

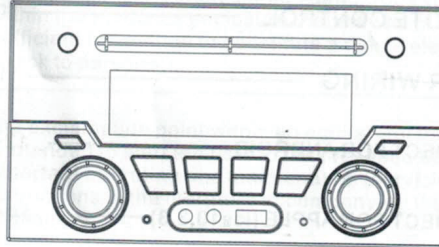

## INSTRUCTION MANUAL



MODEL: DVD3000/DVD5000

Please read this manual carefully before operating your stereo and retain for future reference.

## DIRECTORY

---

IMPORTANT SAFETY INSTRUCTIONS	1
MATTERS NEEDING ATTENTION	2
INTERFACE SPECIFICATION	3
FRONT PANEL	4~6
BOTTOM PANEL	7
INTERFACE SPECIFICATION	8~9
THE REMOTE CONTROL	10
SPEAKER WIRING	11
APK CONNECT FOR ANDROID	12~13
APP CONNECT FOR APPLE (ios10.3.3)	14~15
INSTALLATION DIMENSIONS AND ACCESSORIES	16
TECHNICAL SPECIFICATIONS	17

## IMPORTANT SAFETY INSTRUCTIONS



**CAUTION**  
**RISK OF ELECTRIC SHOCK**  
**DO NOT OPEN**



**CAUTION: TO REDUCE THE RISK OF ELECTRIC SHOCK, DO NOT REMOVE COVER (OR BACK). NO USER-SERVICING TO QUALIFIED SERVICE PERSONNEL.**



The lightning flash with arrowhead symbol within an equilateral triangle is intended to alert the user to the presence of uninsulated ? dangerous voltage? within the product's enclosure that may be of sufficient magnitude to constitute a risk of electric shock to persons.



The exclamation point within an equilateral triangle is intended to alert the user to the presence of important operating and maintenance (servicing) instructions in the literature accompanying the appliance.

### FCC WARNING

To assure continued compliance, follow the attached installation instructions and use only shielded cables when connecting to other devices. Modifications not authorized by the manufacturer may void user's authority to operate this device.

Users in order to correctly use media player to ensure players performance is good, please read carefully and must obey;

- 1: Please read manual carefully before handling the system.
- 2? Don't seriously impact the host.
- 3? Do not contact with benzene, thinner, chemicals, etc.
- 4? Please don't get close to strong magnetic field, electric field.
- 5? Please avoid direct light or heating apparatus.
- 6? Don't open the cover in order to avoid shocking and damage the machine.
- 7? Don't use loud volume to listen to, in order to avoid bad damage to hearing.

#### Functional features

- 1: Bluetooth receives largest distance of 10 meters.
- 2: Play MP3/mp4 format file in USB directly.
- 3: FM stereo radio receiver function.
- 4: Stereo audio input interface, easy to connect computer, digital music player, mobile phone and other audio equipment.
- 5: App/Apk connect control.
- 6: 4 CH amplifier output.
- 7: Infrared remote control.
- 8: Wide range performance
- 9: AUX input.
- 10: Disc player.
- 11: channel 2 video output.
- 12: NFC function.



# INTERFACE SPECIFICATION

## THE FRONT PANEL

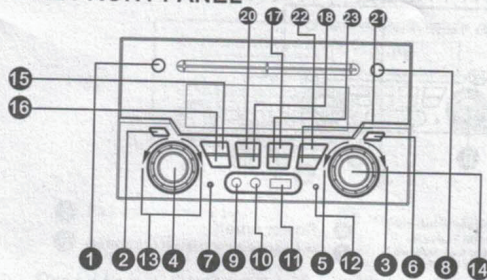

1	Power on/off	9	Earphone
2	Exchanging the bluetooth	10	AUX input
3	Fast backward or last song USB and FM TUNER-/and hang up the phone'	11	USB input
4	Play/Puase or FM/AM Selet	12	RESET
5	Next song or fast forward USB and FM TUNER+ and pick up the phone	13	Volume+/Volume-
6	Source	14	MENU
7	MIC input	15	A Zone mute
8	Disc import and export	16	B Zone mute
		20 22 23	Frequency point selection key.
		17 18 21	

### Note:

- In FM mode, the 5 key FM NEXT search key.
- In FM mode, the 3 key FM BACK search key.
- In USB mode, the 4 key USB pause/play button.
- In USB mode, the 5 key USB the next song.
- In USB mode, the 3 key USB the previous song.
- In disc mode, the 5 key Disc the next and fast forward.
- In disc mode the 3 key Disc the back and fast backard.

## FRONT PANEL

### FM OF FRONT PANEL

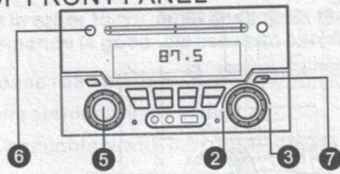

- 2 Fast backward or last song  
USB and FM TUNER-
- 3 Next song or fast forward  
USB and FM TUNER+
- 5 Frequency point selection key.
- 6 Power on/off
- 7 Source

Press the "SOURCE" key, switch to the FM mode

- In FM mode, the 3 press by fine-tuning for frequency+.
- In FM mode, the 2 press by fine-tuning for frequency-.

### AM OF FRONT PANEL

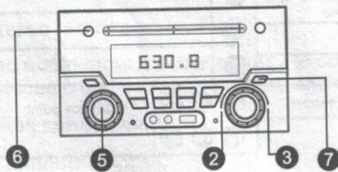

- 2 Fast backward or last song  
USB and Radio TUNER-
- 3 Next song or fast forward  
USB and Radio TUNER+
- 5 Frequency point selection key.
- 6 Power on/off
- 7 Source

Press the "SOURCE" key, switch to the AM mode

- In AM mode, the 3 press by fine-tuning for frequency+.
- In AM mode, the 2 press by fine-tuning for frequency-.

## FRONT PANEL

### BLUETOOTH OF FRONT PANEL

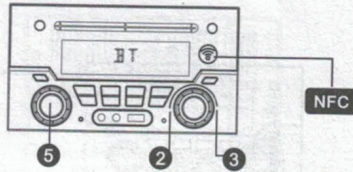

- 3 Pick up the phone key.
- 2 Hang up the phone key.
- 5 Bluetooth music play/pause key.

Press the "SOURCE" key, switch to the BT mode

- 1: Open the settings in mobile phone,
- 2: Open the BT in the setup.
- 3: Automatic search in the BT, appear DVD3000 device name.  
DVD3000 device name, connection.
- 5: After the connection is successful, the speaker tip is  
connected to the DVD3000 device.
- 6: When disconnected, speakers tip has been disconnected.
- 7: Connect the NFC sensing area of the phone to the NFC  
area and the system will automatically connect

### DVD/USB OF FRONT PANEL

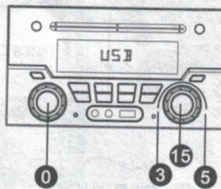

Press the "SOURCE" key, switch to the DISC/USB mode

- 0 Play/pause
- 5 Next song or fast forward
- 3 Fast backward or last song
- 15 Menu

In the USB and DISC mode.



# FRONT PANEL

## AUX OF FRONT PANEL

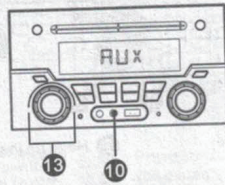



Press the "SOURCE" key, switch to the AUX mode

10 AUX input, L+R 2 channel.

13 VOLME+/VOLME-

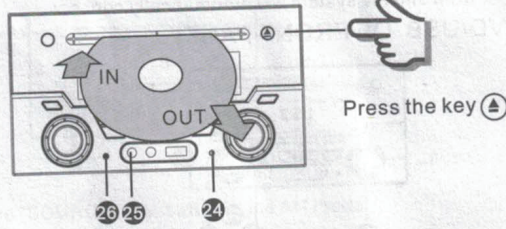
## IN and OUT of the disc



Press the key 

24 SYSTEM RESET

25 EARPHONE(L+R)

26 MIC INPUT



BOTTOM PANEL

VIDEO OUTPUT IN DISC/USB MODE

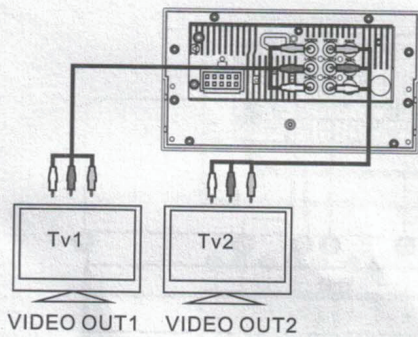

SUB OUTPUT AND AUX INPUT

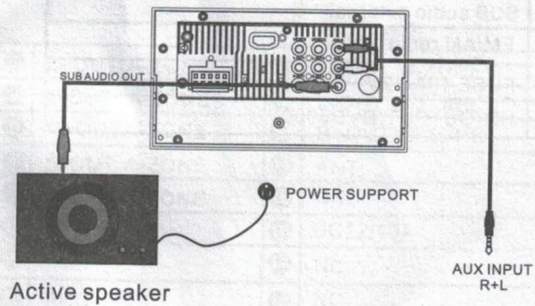

REAR PANEL

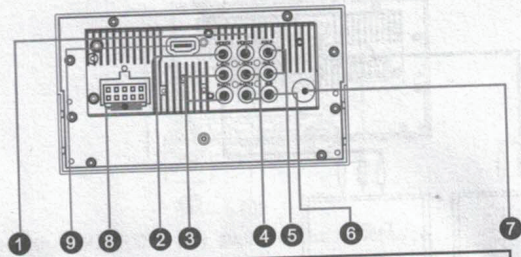

1	Video2 output
2	Video1 output
3	Audio1 output(L+R)
4	Audio2 output(L+R)
5	AUX input(L+R)
6	SUB audio external
7	FM/AM radio signal input
8	FUSE 10A/12V
9	HD-OUTPUT(DVD5000)

# INTERFACE SPECIFICATION

## REAR PANEL

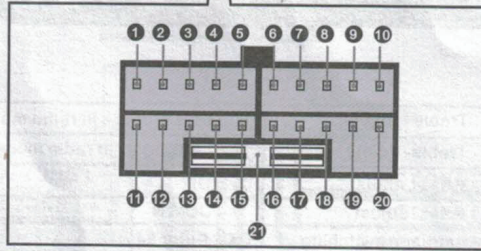
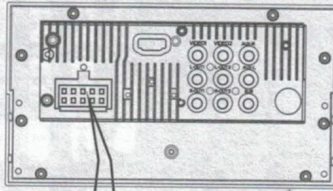

①	L+OUT A-ZONE	⑪	L+OUT B-ZONE
②	L-OUT A-ZONE	⑫	L-OUT B-ZONE
③	R+OUT A-ZONE	⑬	R+OUT B-ZONE
④	R-OUT A-ZONE	⑭	ANT
⑤	R-OUT B-ZONE	⑮	GND
⑥	NC	⑯	DC12/10A
⑦	NC	⑰	NC
⑧	ACC	⑱	NC
⑨	NC	⑲	NC
⑩	NC	⑳	NC
㉑	FUSE 10A/12V		



THE REMOTE CONTROL

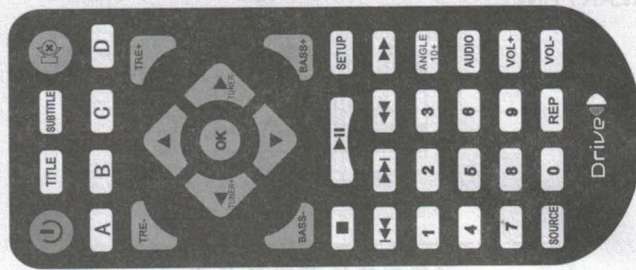

TRE+	Treble+ adjust	TUNER+	Right(tuner+ in radio mode)
TRE-	Treble- adjust	TUNER-	Left(tuner- in radio mode)
BASS+	Bass+ adjust	▲	UP
BASS-	Bass- adjust	▼	DOWN
AUDIO	Language switching	OK	Enter key
1-10+	Numeral key	REP	repeat key
⏻	POWER ON/OFF	🔇	MUTE
VOL-	VOLUME -	VOL+	VOLUME+
⏮	Last song or up(in disc)	⏭	Next song or down(in disc)
⏪	Backard fast or left	⏩	Forward fast or right
SOURCE	SOURCE	⏸	PAUSE/PLAY
A	A-ZONE MUTE	B	B-ZONE MUTE
C	C-ZONE MUTE	D	D-ZONE MUTE
SETUP	DISC of menu	▲	In or out the disc
■	Stop of the Disc	ANGLE 10+	ANGLE/NUMERAL 10+
SUBTITLE	Subtitle	TITLE	TITLE



# SPEAKER WIRING

## SPEAKER(6\*4OHMS) WIRING COLOR CODE GUIDE

### CAUTION!

Connecting the speakers incorrectly will cause distortion and damage the power amplifier

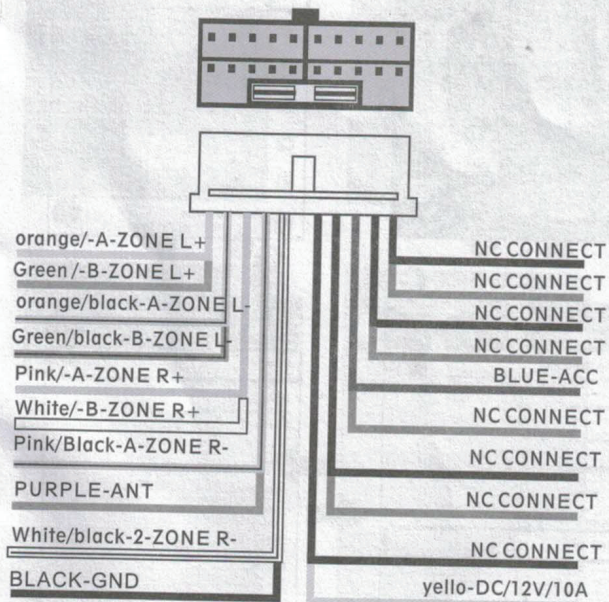

# MOBILE PHONE CONNECTION WITH BLUETOOTH

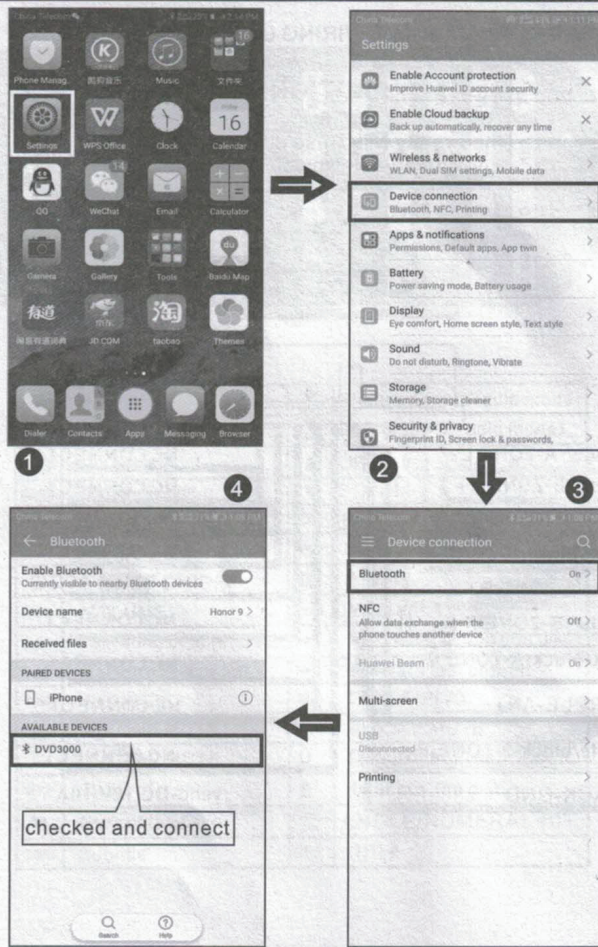

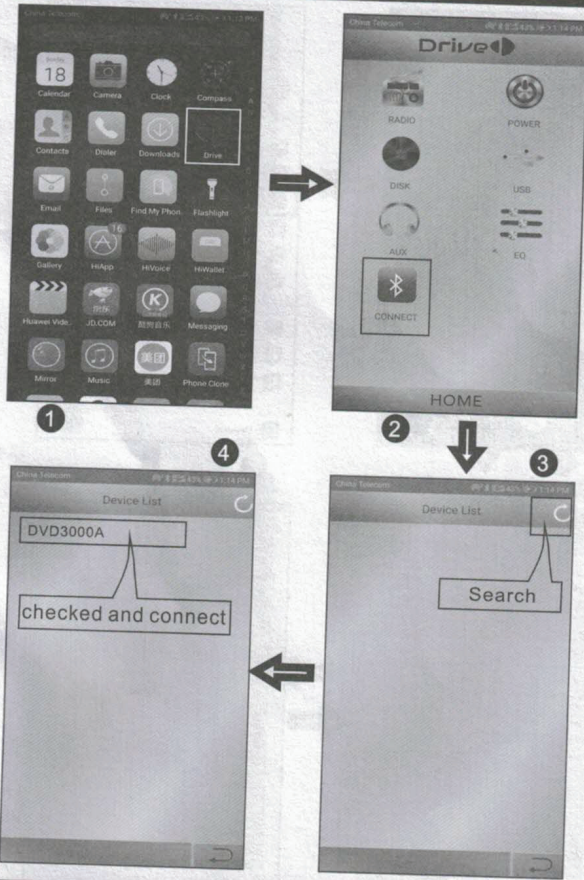

Please download it(APK) on the website.  
(WWW.WAYINTERGLOBAL.COM)



# MOBILE PHONE(Apple) CONNECTION WITH BLUETOOTH

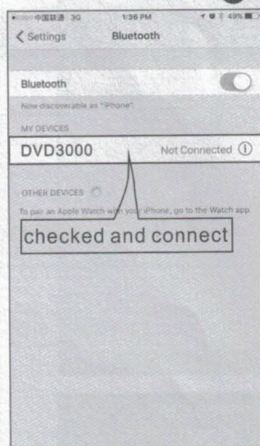
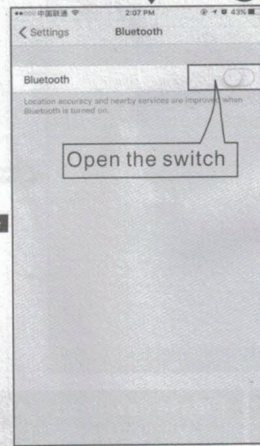
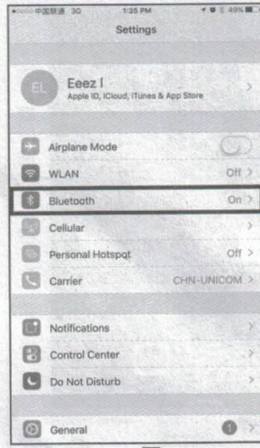



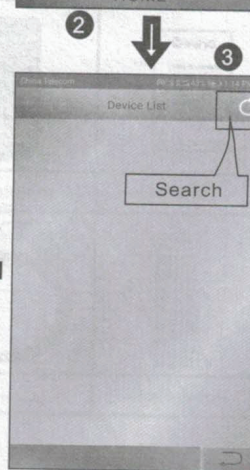
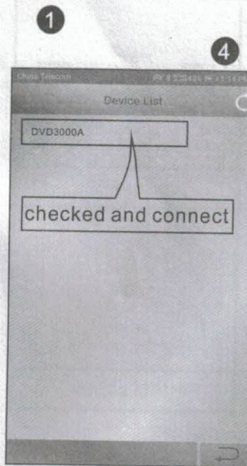
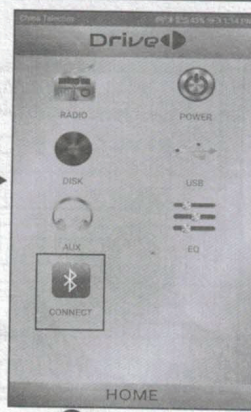



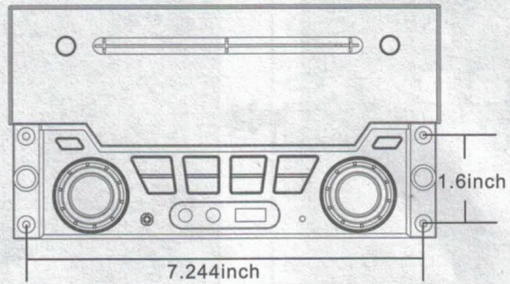



Please download it(APP) on the APP Store.



		
Manual	The remote control	Cover
		
Power cable	AV cable	FM/AM cable

## TECHNICAL SPECIFICATIONS

The output power: 60W

Working voltage: DC12/10A

Frequency response: 35HZ~20KHZ

Signal to noise ratio: 80dBA

The input sensitivity: 450+50mA

Size: 200mm(L)\*175mm(W)\*110mm(H)

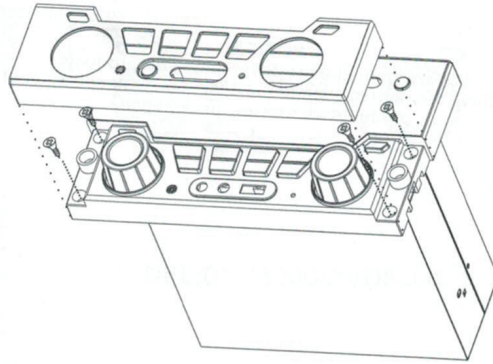

Screws\*4pcs

**For Warranty/Troubleshooting/or General Inquires please contact:**

Way Interglobal Network LLC  
574-971-4490  
3002 Coast Court  
Elkhart, IN 46514  
Rvcampingparts.com

**NOTICE:**

- We are committed to developing new products.
- We reserve the right to change the design and specification of our products without any prior notice.