

strybuc

INDUSTRIES

THE ONE STOP SOURCE FOR ALL YOUR WINDOW & DOOR HARDWARE

20
22

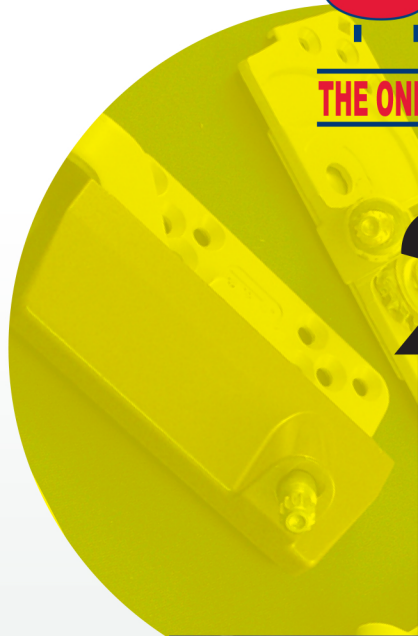

CUSTOM CATALOG PROGRAM

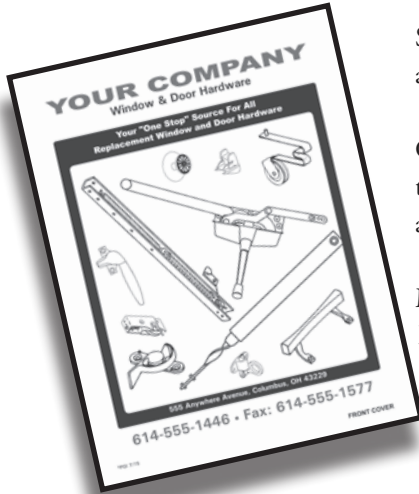

Strybuc Industries is offering you a risk free opportunity to expand your product line and INCREASE SALES!

Call today and have us customize this catalog specifically for your company. We'll be glad to imprint your company name, logo, address phone number, fax number and e-mail address on the cover. The same wide selection of quality parts will be offered inside.

Minimum quantity 25. Allow 2-3 weeks delivery.
For more details, contact your Account Manager.

ONLINE PARTS STORE PROGRAM

strybuc//connect



**Sell parts 24 hours a day 7 days a week
Be open when your customers want to buy**

- Your "custom" online partner store comes pre loaded with thousands of products to sell
- Set your own selling prices
- Use your own logo, identity and branding

See Page 501 for more details.

TOUCH-SCREEN WINDOW AND DOOR PARTS KIOSK FOR RETAIL STORES



The 1st Touch-Screen "Window and Door Parts" Kiosk for Retail Stores!

Store visitors can shop over 36,000+ popular and hard to find and obsolete window and door parts using the touch-screen online store and printed catalog.

See Page 502 for more details.

BLIND DROP SHIP PROGRAM

We offer a **Blind Drop Ship Program** that allows you to ship an order directly to your customer from our warehouse, without letting your customer know the source is Strybuc.

- We use generic packing slips, bags and boxes to ship your order
- Saves time - from our warehouse to your customer
- Save by reducing double handling
- Eliminate additional delivery costs

See packing slip example on next page and talk to your Account Manager for more details.

ACCOUNT NO.

16666

ORDER NO.

100541

SOLD TO

ABC CO.
YOUR COMPANY NAME

SHIP TO

XYZ CO.
YOUR CUSTOMER'S NAME

SLSMN	SUPV.	PURCHASE ORDER NO.	H.	SHIP VIA	ORDER DATE	DATE PROCESSED	INVOICE NO.
532	102	Stock		UPS	3/1/99	3/1/99	

PART NO.	DESCRIPTION	CUSTOMER PART NO.	ORDERED	BACK ORD.	SHIPPED
60-622	23" Channel Balance	YOUR PART NUMBER WILL APPEAR HERE.	25		25
60-507A	G-12 Top Bracket Attached		25		25
60-501A	Bottom Bracket Attached		25		25

The Purpose of the BLIND DROP SHIP PROGRAM is to allow you to ship an order directly to your customer from our warehouse without letting your customer know the source is Strybuc.

Strybuc is not named anywhere on the packing slip so it appears the order was shipped from you to them. The only time a customer may determine that Strybuc was the original shipper is, if damage occurs - our shipping code is noted.

Even if this occurs, Strybuc does not sell directly to any end user: school, apartment, condo, military base etc.

- Save time - from our warehouse to your customer
- Save by reducing double handling
- Eliminate additional delivery cost, whether you deliver or ship

TABLE OF CONTENTS

Sash Support Systems	6-143	Non-Tilt Jamblers	142
Overview of Balances	6-11	86 Series Non-Tilt Boston Style Jamblers	143
Window Balance Identification Display	12	Architectural Hardware	144-149
57 Series Balance and Accessories	13	Sash Locks	144
58 Series Balance and Accessories	14	Lifts and Pulls	145
60 Series Balance and Accessories	15-28	Brass/Steel Pulleys	145-146
60A and 60AX Series Balances and Accessories	29-30	Polysash Pulleys	146
60P Series Balances and Accessories	31	Sash Chain and Accessories	146
60G Series Balances and Accessories	32-36	Sash Cord and Accessories	147
60I Series Balances and Accessories	37-41	Sash Counterweights	147
61 Series Balances and Accessories	42-43	Accessories	147
61AP Series Balances and Accessories	44-49	Spring Bolts and Miscellaneous Items	147
61TI Series Inverted Tilt Balance and Accessories	50	Vent Locks and Accessories	147-148
62 Series Balances	51-52	Casement Hardware	148-149
62A Series Balances	53-54	Screen Hardware	149
62 Series Accessories	55-58	Parting Beads/Brush Seals/Weatherstrip	149
62-716 Series Balance	59	Mini Groover	149
62-766 Series Balance	60	Hinges	149
62-716 & 62-766 Series Accessories	61-62	Window Replacement Hardware	150-283
Soudal Adhesive Sealant	62	Sweep Locks & Sash Locks	150-159
Spray-X Foaming Glass Cleaner	62	Double Hung Latch	159
62DV Series Balances and Accessories	63	Window Keepers	159-164
62FC Series Balances and Accessories	64-65	Slide Lock	164
62FI Series Balances and Accessories	66-67	Spring Type Latches	164-166
62G Series Balances and Accessories	68	Extruded Sash Handles and Lifts	166-169
62R Series Balances and Accessories	69	Sash Lifts	169-170
62S Series Balances and Accessories	70-71	Limit Locks and Accessories	170
62V Series Balances and Accessories	72	Tilt Latch Sweep Lock	170
62W Series Balances and Accessories	73	Window Opening Control Devices (WOCD)	171-176
64 Series Balances and Accessories	74	Vent Locks	177
64-841 Series Balances and Accessories	75	Sash Restrictor Assembly Kits	177
64B Series Balances and Accessories	76	Sliding Window Rollers	178-187
64T Series Balances and Accessories	77	Weep Covers	187
70 Series Balances and Accessories	78-81	Sliding Window Wheels	188-189
72 Series Balances and Accessories	82-83	Storm Cam Latch	189
74 Series Balances and Accessories	84-85	Slider Guides	189-191
75 Series Balances and Accessories	86	Pivot Shoe, Slide Bolt & Anti-Rattle Plug	191
76 Series Balances and Accessories	87-89	Guide Buttons	191
78A Series Balances and Accessories	90	Angles/Corners	191
80 Series Balances and Accessories	91	Miscellaneous	192
80A Series Balances and Accessories	92	Fasteners	192
80B Series Balances and Accessories	93	Project-out Cam Handles	192-198
80SL Series Balances and Accessories	94	Project-in Handles	198-199
83 Series Balances and Accessories	95-97	Handles Fasteners	199
83-P Series Balances and Accessories	98	Casement Handles	199-201
84 Series 5/8" Pneu-Lift Tilt Assembly	99	Casement Locks	202
84S Series Short 5/8" Pneu-Lift Tilt Assembly	100	Multi-Point Locks	202-204
85 Series Balances	101	Spring Catches	204
85M Series Balances	102	Custodial/Vent Locks	204-205
85-P Series Balances	103	Removable Handle Keys	206
85Z Series Balances	104	Project-in, Project-out Casement Keepers and Strikes	206-208
85 Series Accessories	105-116	Face Mounted Casement Operators	209-215
88L Series Balances and Accessories	117-118	Greenhouse Operators	216
88LL & 88SL Series Balances and Accessories	118	Sill Mounted Casement Operators	216-230
89 Series Balances and Accessories	119	Lever Operators	231
901 Series Crossbow Balance	120	Motorized Operators and Accessories	231-234
960SP Series Crossbow Balance	121	Manual Skylight Operators and Accessories	235-236
909A Series Crossbow Balance	122	Rear Mount Awning Operator	237
Balance Tools and Accessories	123	Lever Awning Operator	237
Tape Balances	124	Clerestory Window Wands	237
Perma-Shield Narrowline Window Balances	125	Face Mounted Awning Operators	238
96AA Series Constant Force Balance and Accessories	126	Sill Mounted Awning Operators	239-242
Omega Constant Force Balance System	127	Mill Finish Awning Operators-Miami Type	243
96BT Series Constant Force Balance and Accessories	127	Jalousie Operators	244
96BG Series Constant Force Balance and Accessories	128	Awning and Jalousie Accessories	244-247
96BU Series Constant Force Balance and Accessories	129	Aluminum Awning Window Torque Bar Assemblies	248
96-C Series Coiled Balance Springs and Accessories	130	Torque Bar Arms	248-249
96CQ Series Quick Tilt Constant Force Balances	131-132	Casement and Awning Operator Brackets	250-252
96CR Series Roller Tilt Constant Force Balance Systems	133	Fenestrator	252
96M Series Constant Force Balance Systems	134	Operator Covers	252-253
Introduction to Vinyl Jamblers	135	Crank Handles	253-257
Jambliner Worksheet	136	Push Bars	257-258
Tilt Jamblers with Block and Tackle Balances	137-138	Vent Arms with Brackets	258
Heavy Duty Magnum Jamblers	139	Pressure Shoes, Friction Shoes and Housings	259-260
Sash Preparation Instructions for Magnum Jamblers	140	Casement and Awning Tracks	261-262
How to Install Tilt Jamblers	140	Casement and Awning Hinges	262-270
Tilt Jamblers	141		

Continued on next page.

STRYBUC INDUSTRIES

Continued from previous page.

Sash Control Devices	271-272
Top Hung Hinge Assemblies	272
Miscellaneous Operator Hardware	273-275
Finger Latches, Slide Bolts and Slide Bolt Accessories	275-278
Insert Clips	278
Corner Keys & Tilt Keys	279-282
C-Sash Panels and Components	283

RV & Mobile Home Hardware 284-293

Cranks, Knobs, Handles and Extensions	284
Operators and Operator Kits	285-286
E-Rings and Groove Pins	287
Torque Bar Bearings & Bushings	287-288
Torque Bar Arms	288
Link Arms	288
Torque Bars	288
Vent Hinges	289
Window Latches, Sash Locks and Lever Latches	289-290
Push Bar Assembly	290
Metal Spring	290
Jalousie Operators and Handles	290
Trailer Latch	290
Insect Screening	291
Screen Spline and Installation Tool	291
Screen Corners	291
Clips	291
Lavatory & Tub Stoppers	291
RV Plan-O-Gram	292
RV Window Handle Counter Display	293

Window Glazing & Weatherstripping 294-314

Snap-In Vinyl Glazing Beads	294-301
Tracks	301
Muntin Bars	302
Plunger and Muntin Clips	302
Grille Pins	302
Window Grille Kit	302
Metal Glazing Bead	302-304
Vinyl Glazing Spline	304
Vinyl Glazing Channels	305
U-Channels	305
Perimeter Seals	305
Glazing Spline with Flexible Fin	305
Leaf Weatherseals	306
Foam "T" Slot Weatherseals	306
Weatherstrip	306-308
Nail-Up Foam Door Seals	308
Door Sweeps	308-309
Foam Door Seals	309
Neoprene Sponge Gasket	309
E-Lon Foam Door Seals	310
Skirting Weatherseal	311
Glazing Clips	311
Adhesive Foam Weatherstripping Tape	311
Foam Corner Seals	311
Magnetic Weatherstrip Replacement for Steel Doors	311
E.Z.D. Glazing Tool	311
Entraseal Door Astragal Seals	312
Gray Replacement Fin Weatherstripping	312
Weatherstripping with Adhesive Backing	312
Woolpile Weatherstrip	312
Miscellaneous	312
Quanex Super Spacer	312
Soudal Adhesive Sealant	313
PU Foams	313
Cleaners	313
Glass Cutter	314
Vinyl Glazing Bead Identification Ring	314
Spray-X Foaming Glass Cleaner	314
Private Label Spray-X Foaming Glass Cleaner	314

Screening Hardware 315-342

Custom Made Roll Form Window Screen Order Form	315-318
Screen Frames	319-320
Screen Wire and Screen Cloth	321-323
Screen Spline	324-325
Vinyl Astragal	325
Tension Springs	325
Wire Loop Latches	325
Screen Clips	325-327

Muntin Clip	327
Retainer Clip	327
Pivot Post	327
Hangers	327
Latches	327-328
Cross Brace Insert	328
Fixed Pins	329
Screen Corners	329-331
Grille Fastener	331
Lifts and Pull Tabs	331
Spring Plungers	332-333
Friction Hangers	333
Latch Set	333
Screen Latch Handle & Finger	333
Guide Insert	333
Warning Label	333
Pet Screen Door	333
Screen Shield	333
Automatic Screen Door Closer	333
Extruded Aluminum Wicket & Hopper Screen Order Form	334
Custom Made Extruded Aluminum Screen w/Plastic Wicket Order Form	335
Plastic Hinged Wickets Only	335
Custom Made Assembled Patio Screen Doors Order Form	336
Custom Made Assembled Patio Screen Doors	337-338
Steel Multi-Fit Patio Screen Doors	339-340
Knock Down Patio Screen Doors	340
Top Hung System for Top Rolling Application	341
Screen Tools	341-342

Patio Door Hardware 343-388

Sliding Door Roller Assembly Identification Selector	343
Precision Bearing Roller Assemblies	344-345
Glass Door Roller Assemblies	346-353
Screen Door Roller Assemblies	353-357
Wheels	357
Sliding Glass and Screen Door Keepers	358
Patio Door Handles	359-376
Screen Door Handles	377-378
Latch Assemblies	378-379
Patio Door Screw Hole Cover	379
Screen Door Guides	379-380
Roller Assembly	380
Head Spacer	380
Bug Flaps	380
Fixed Panel Bracket	380
Fixed Patio Door Clip	380
Patio Door Bumpers	380-381
Anti-Lift	381
Anti-Rattle Guides	381
Security Hardware and Patio Door Locks	381-383
Key Cylinders	383
Mortise Locks	383-385
Keepers	386
Latches	387
Corner Brackets	387
Lock Bars	387
Pinion Gear	387
Repair Tracks	388
Fasteners	388
Charley-Bar Sliding Glass Door Lock & Accessories	388
Automatic Screen Door Closer	388

Caulking Applicators & Accessories 389-391

Swing Door Hardware 392-440

Hoppe Swing Door Handle Sets & Accessories	392-401
Hoppe Profile Cylinders and Rekeying Kits	402-405
Hoppe Hinges	405
Hoppe Multi-Point Locking Systems and Accessories	406-413
Hoppe HLS 9000 Multi-Point Hardware Swing Door Questionnaire	407
Hoppe HLS 7 Multi-Point Hardware Swing Door Questionnaire	412
Hoppe HLS 7 Series Replacement Parts	413
G-U Swing Door Handles	414-415
G-U Multi-Point Hardware Swing Door Questionnaire	416
G-U Single Point Mortise Locks	417
G-U Swing Door Accessories	418-419
AmesburyTruth Multi-Point Hardware Swing Door Questionnaire	420
AmesburyTruth Single Point Mortise Gear Box & Accessories	421
AmesburyTruth Hinges	422
AmesburyTruth Tru-Lock Multi-Point Conversion Kit for Entry Doors	423

Continued on next page.

Continued from previous page.

AmesburyTruth Sentry Multi-Point Handle Sets & Accessories	424-425
AmesburyTruth Sentry Multi-Point Swing Door Questionnaire	426
AmesburyTruth Sentry Multi-Point Strikes	427
Andersen Multi-Point System & Accessories	428-429
Ashland Swing Door Handle Sets	430-431
Ashland Adjustable Hinges	432
Ashland Sentinel Multipoint Swing Door Lock System	433-434
Ashland Concealed Multipoint Lock Systems & Accessories	435
Ashland Single & Multipoint Point Mortise Locks	436
Ashland Swing Door Handles	436
Roto Multi-Point Systems & Accessories	436
Milton 2-Point Locksets	436
Eurogroove Stepped Router Bits	436
Hinges	437-438
Miscellaneous Mortise Locks	438-439
Miscellaneous Swing Door Locksets & Accessories	439
Storm Door Handle Set	439
Zinc Bushing Replacement Kit	439
Miscellaneous Handle Sets	440

Closet Door Hardware 441-461

Bi-Fold Closet Door Pin Assemblies	441-444
Bi-Fold Closet Door Caps	445
Bi-Fold Closet Door Springs	445
Bi-Fold Closet Door Accessories	445
Metal Closet Door Pivot Brackets	446
Metal Closet Door Nylon Grommets/Bushings/Bumpers	446-447
Metal Closet Door Plates and Pulls	447
Bi-Fold Door Hinge	447
Closet Door Track	447
Wood Closet Door Plunger Pins, Brackets, Plates and Caps	448-449
Closet Door Rollers	449
Wood Closet Door By-Pass Hangers	450-452
Wood Closet Door Panel Jacket Hangers	452
Wood Closet Door Pivot/Jamb Brackets	452-453
Wood Closet Door Pulls and Knobs	453
Wood Closet Door Floor Guides/Plates	453-454
Pivot Guide, Snuggers, Bumpers	454
Closet Pole Socket	454
Miscellaneous Accessories	454-455
Bi-Fold Repair Bracket	455
Closet Door Savers	455
Bi-Fold Door Track Sets	456
CW Mirror Bi-Pass Door Hardware	456
CW Mirror Bi-Fold Door Hardware	456
E-Z Roll Closet Door Hardware	457-459
Paniflex Closet Door Hardware	459
Floataway Closet Door Hardware	460
Slimfold Closet Door Hardware	460-461

Shower Door Hardware 462-469

Shower Door Rollers and Roller Assemblies	462
Latches	462
Guides	462-463
Bumpers	463
Handles	463
Miscellaneous Accessories	463
Glass Shower Door Hinges	464-465
Glass Shower Door Clamps	466
Glass Shower Door Sealing Strips	467
Glass Shower Door Pull Knobs and Handles	467-468
Mildew Resistant Silicone Sealant	468
Sweepsaver Glazier Tool	468
Gliding Shower Door System	469

Storm Door Hardware 470-476

Knob/Push Pull Latch Sets	470
Push Button Latch Set	470-472
VP Pull Handle Set	472
Locking Handle Set	472
Lever Latch Sets	472-473
Trailer Latch Sets	473
Closers	474-475
Inside Latches	475
Key Locks	475
Panel Clips and Thumb Screws	476
Strikes	476
Shims	476
Hinges	476
Push Button	476

Door Chain	476
Brackets	476
Screen Spline	476

General Door & Builders Hardware 477-478

Entrance Door Closers	477
Door Stops, Bumpers and Silencers	477-478
Retractable Garment Hooks	478
Wall Protectors	478
Door Lock Channels	478
Door Knocker	478
Chain Lock	478
Door Viewers	478

Cabinet Drawer Hardware 479-482

Drawer Track Sets	479
Drawer Inserts	479
Monorail	479
Drawer Slides	479
Drawer Guides and Brackets	479-480
Sockets	480
Rollers	480-481
Hinges	481
Mini Door Struts	481
Cabinet Bumpers	481
Cabinet Shelf Supports and Brackets	481
Latch and Catch	481-482
Handles, Knobs & Pulls	482
Mirror Hardware	482

Mailbox Locks 483

Multi-Cam Mailbox Lock Kits	483
Fixed Cam Mailbox Locks	483
Flat Mailbox Locks	483

Garage Door Handles 483

Toilet Partition Hardware 484-488

Concealed and Surface Mounted Latches	484
Chrome Plated Door Pulls, Hooks and Door Stops	484
Chrome Plated Keepers and Strikes	485
Chrome Plated Wrap Around Gravity Pivot Hinges	485-486
Surface Mounted Gravity Hinges	486
Chrome Plated Wall Brackets	486
Chrome Plated Urinal Brackets	486-487
Replacement Pilaster Shoes	487
Door Inserts	487
Cams, Pintles and Hinge Pins	487-488
Chrome Plated Alcove Clips, Head Rail, End Plugs and Brackets	488
One-Way Screw Remover	488
Chrome Plated Toilet Partition Fasteners	488

Commercial Door/Storefront Hardware 489-498

Mortise Locks	489
Faceplates	489
Push/Pull Paddles	490
Lever Handle	490
Strikes	490
Cylinders/Trim Rings/Collars	491
Flush Bolt	491
Offset Pivots	492-493
Hinges	494
Door Closers	495
Door Stops & Silencers	495
Exit Devices	496-497
Door Pulls	498

Glass Cleaner, Adhesives, Lubricants & Gun Foam 499

Carrymate Non-Slip Panel Grips 500

Hands-Free Hardware 501

Strybuc Connect Website Program 501

Specialty Products 502

Touch Screen Retail Kiosks	502
Fiberglass Lath	502

Terms and Conditions 503

NON-TILT SIDE LOAD CHANNEL BALANCES

The following overview will help you to locate the channel balances you are looking for. There are three basic classifications:

1. Non-Tilt Balances 2. Tilt Balances 3. Overhead Balances

We have designated each of these classifications and have made additional notes to help you determine your specific requirements.

For more information, see the detailed chart page for each individual series.

60 Series Non-Tilt 5/8"

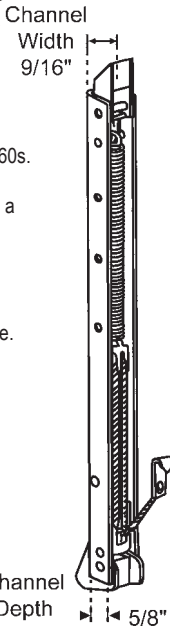

- Used in aluminum windows since 1960s.
- Must always have a top and bottom guide attached.
- Many guide variations available.

See page 15 for chart details.

60A & 60AX Series

The Invisible Balance

- Mounted in the side of the window sash.
- Used primarily in custom wood windows when jamb liners are not acceptable.
- Great for historical renovations.
- Original used wire cable, no longer available.

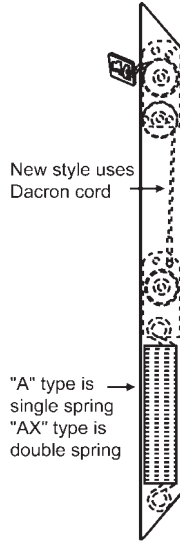

See pages 29-30 for chart details.

60P Series Non-Tilt

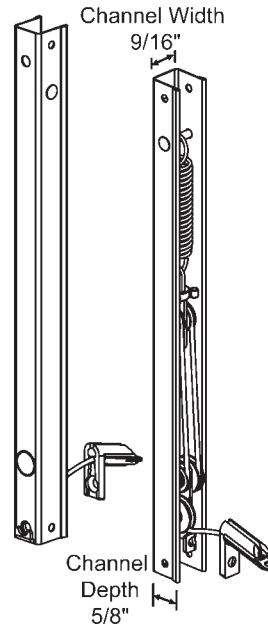

PEACHTREE

See page 31 for chart details.

60G Series Non-Tilt

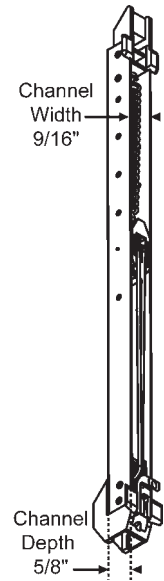

See page 32 for chart details.

NON-TILT SIDE LOAD CHANNEL BALANCES

60AZF4 Series Non-Tilt



Ask account manager for detailed chart.

60I Series Non-Tilt

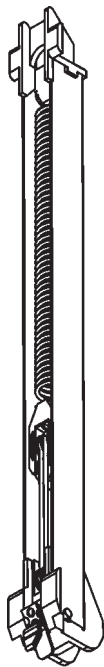

See page 37 for chart details.

61 Series Non-Tilt

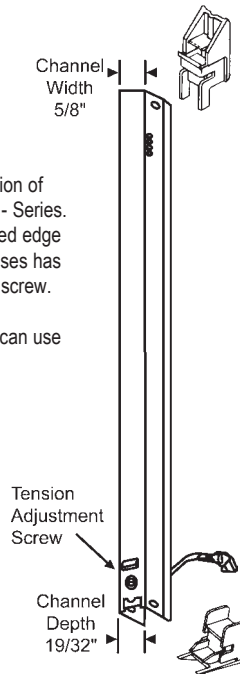

- This is a variation of the original 60 - Series. It has a hemmed edge and in most cases has an adjustment screw.
- In most cases can use 60 - Series.

See page 42 for chart details.

61AP Series Non-Tilt

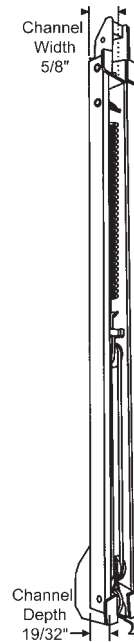

See page 44 for chart details.

62R Series Non-Tilt



RUSCO
Minimum Order Required

See page 69 for chart details.

NON-TILT SIDE LOAD CHANNEL BALANCES

64 Series Non-Tilt 3/8"

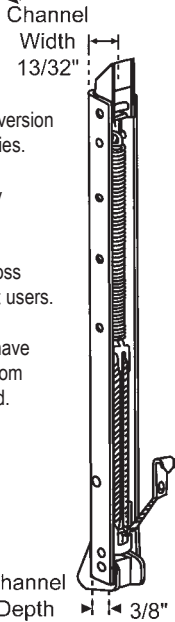

- This is a 3/8" version of our 60- Series.
- Used primarily in Southeast.
- Binnings & Moss were 2 largest users.
- Must always have a top and bottom guide attached.

See page 74 for chart details.

57 Series Non-Tilt

Special Order - Non-Returnable Balance Has 2 Internal Springs

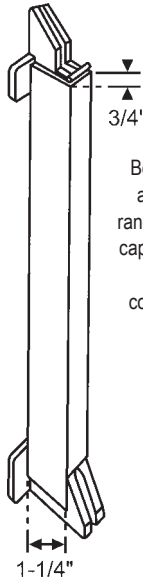

Both 57 & 58- Series are used for weight ranges above 60- series capacity. Primarily used on heavy duty commercial windows.

See pages 13 for chart details.

58 Series Non-Tilt

Special Order - Non-Returnable Balance Has 4 Internal Springs

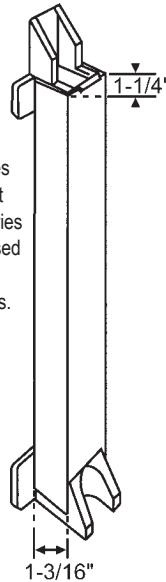

See pages 14 for chart details.

TILT CHANNEL BALANCES

If a window can be tilted in for cleaning and does not have a top and bottom guide attached like our 60- series, you will need one of the balances designated below.

61T Series Tilt

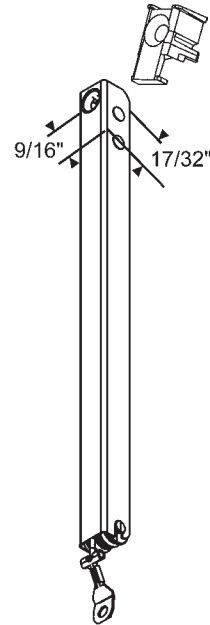

Ask account manager for detailed chart.

61TI Series Tilt

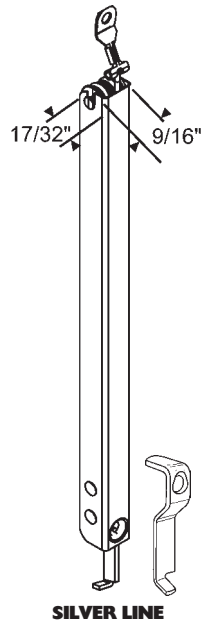

SILVER LINE

See page 50 for chart details.

TILT CHANNEL BALANCES

62 Series Tilt 5/8"

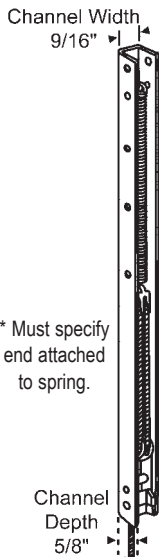

* Must specify end attached to spring.

See page 51 for chart details.

62S Series Inverted Tilt 1/2"

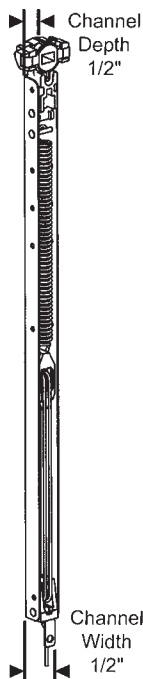

See page 70 for chart details.

64T Series Tilt 3/8"

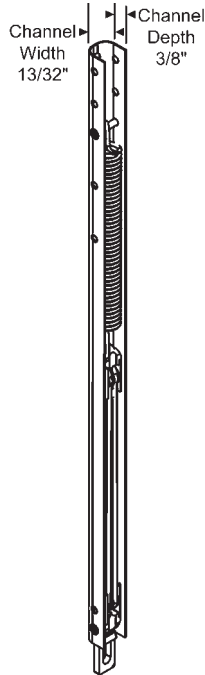

See page 77 for chart details.

64B Series Ribbed Balances

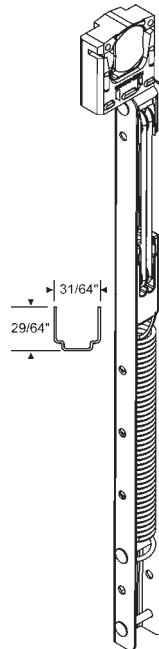

See page 76 for chart details.

64-841 Series Ribbed Inverted

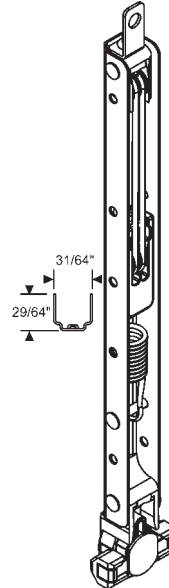

See page 75 for chart details.

62A Series Tilt Ribbed Balances

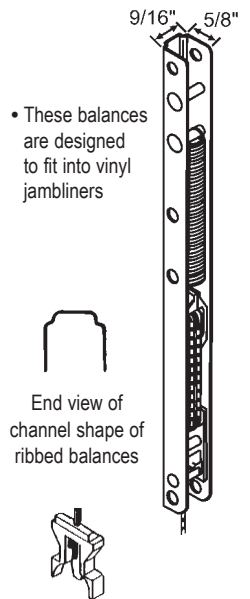

• These balances are designed to fit into vinyl jambliners

End view of channel shape of ribbed balances



See page 53 for chart details.

TILT CHANNEL BALANCES

62FC Series

Channel Width
9/16"
Channel Depth
17/32"



- Most commonly used in vinyl windows. However, several manufacturers use in aluminum windows

Optional Clip

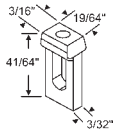

See page 64 for chart details.

62FI Series



Identical to 62-716 Series but has groove on back and reverse pulley.



See page 66 for chart details.

62G Series

Channel Depth
1/2"



See page 68 for chart details.

62-716 Series

Inverted.
1/2" Wide x
1/2" Depth



See page 59 for chart details.

62-766 Series

Inverted.
1/2" Wide x
1/2" Depth
(Similar to 62-716 Series Except 4 numbers Stamped on Balance)

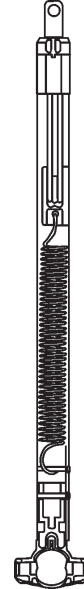

See page 60 for chart details.

62M Series

Used on Magnum #86M, 86MF, 86MS Jambliners



Ask account manager for detailed chart.

OVERHEAD BALANCES

62W Series

Overhead Balances

- Used primarily in West Coast by international and other manufacturers

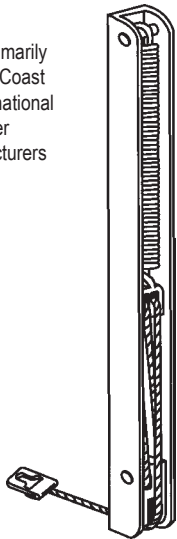

See page 73 for chart details.

62DV Series

Devac Balances

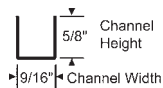

Single Spring Channel



Double Spring Channel

Minimum Order Required

See page 63 for chart details.

62V Series

5 to 1 Overhead Balances

- Original design used wire cable. New design uses Dacron® Cord.



Minimum Order Required

See page 72 for chart details.

60B Series

Bantam Balances

- One of the first overhead balances
- Used primarily by Binswanger
- Not currently used by any manufacturer



Ask account manager for detailed chart.

TILT & NON-TILT SPIRAL BALANCES

85 Series Tilt 5/8"

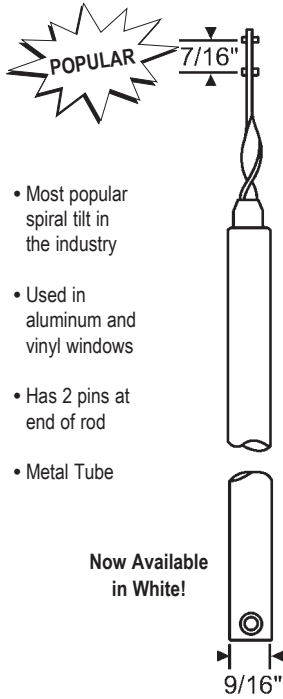

- Most popular spiral tilt in the industry
- Used in aluminum and vinyl windows
- Has 2 pins at end of rod
- Metal Tube

Now Available in White!

See page 101 for chart details.

85M Series Non-Tilt 5/8"



See page 102 for chart details.

85Z Series Pre-Tensioned Tilt 5/8"



See page 104 for chart details.

85-P Series Tilt 5/8"

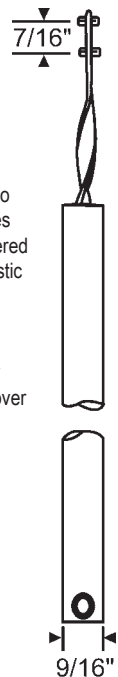

- Similar to 85 Series but covered with plastic tube
- White, Black or Gray Cover

See page 103 for chart details.

TILT & NON-TILT SPIRAL BALANCES

83 Series Tilt 3/8"

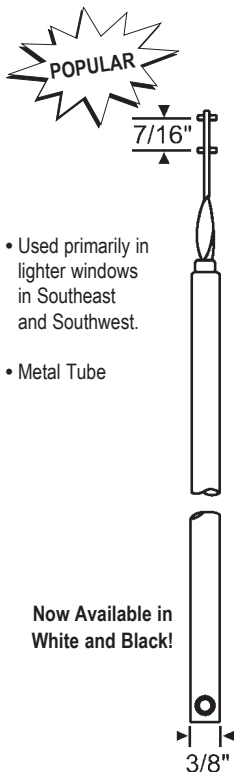

- Used primarily in lighter windows in Southeast and Southwest.
- Metal Tube

Now Available in White and Black!

See page 95 for chart details.

83-P Series Tilt 3/8"



- Similar to 83 Series but with plastic tube
- White, Black or Gray Cover

See page 98 for chart details.

84 Series Pneulift

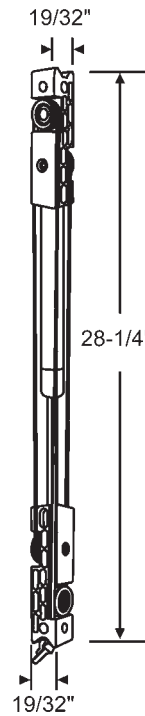

- Pneumatic for commercial applications.
- Gas filled balance.
- Can extend weight range to over 100 lbs. with 4 balances per sash.
- * Also available in 20-1/4" length version as 84S Series.

See page 99 for chart details.

84S Series Pneulift

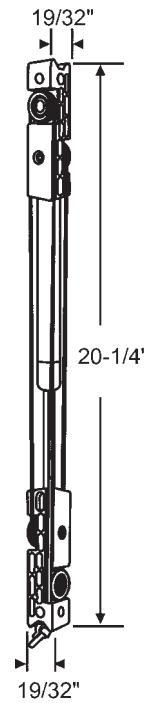

See page 100 for chart details.

89 Series Non-Tilt 5/8"

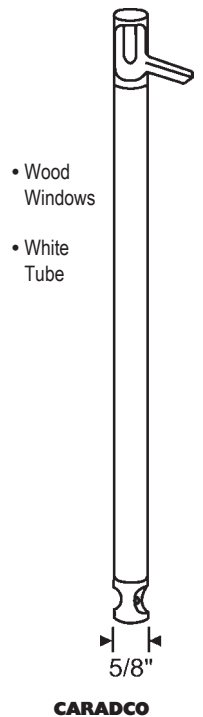

- Wood Windows
- White Tube

CARADCO

See page 119 for chart details.

88L Series Tilt or Non-Tilt

- Commercial Grade Heavy Duty up to 100 lbs.
- Reduces lifting and closing force by over 50%. Excellent for schools, nursing homes, hospitals, etc.
- By utilizing 88-500 bracket, balance can be made Non-Tilt.
- 5 year warranty
- Gray Plastic Cover
- Must be ordered for specific weight.

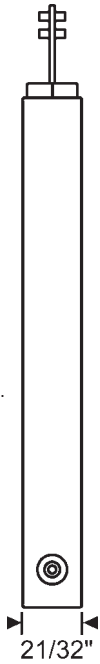

Now Available in White!

See page 117 for chart details.

88LL Series Tilt & Non-Tilt

- Commercial Grade Heavy Duty for weight ranges up to 130 lbs.
- Gray, Black or White Cover



See page 118 for chart details.

88SL Series Tilt & Non-Tilt



89W Series

- White Plastic Tube
- Special Order Item
- Order Per Sample Only
- Also Need Sash Weight & Glass Height



WENCO

Ask account manager for detailed chart.

70 Series Non-Tilt 5/8"



- Metal Tube
- Used in both wood and aluminum windows

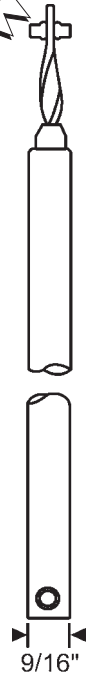

See page 78 for chart details.

76 Series Non-Tilt 3/8"



- Metal Tube
- Used in aluminum windows



See page 87 for chart details.

72 Series Non-Tilt



- Metal Tube
- Always has plastic end attached.
- Do not confuse with 85 tilt series.

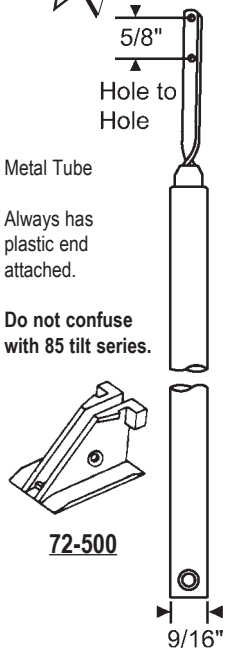

72-500

See page 82 for chart details.

74 Series Non-Tilt



- Metal Tube
- Always has plastic end attached.
- Do not confuse with 83 tilt series.

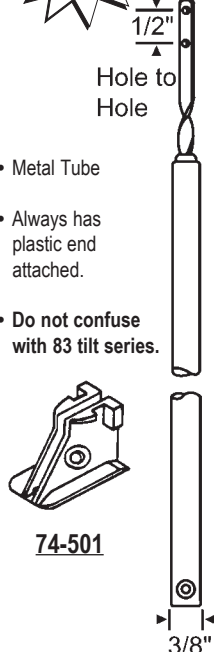

74-501

See page 84 for chart details.

75 Series Non-Tilt



- Metal Tube
- Always has metal guide attached.
- Do not confuse with 83 tilt series.

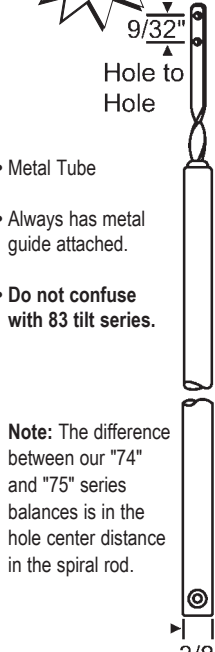

Note: The difference between our "74" and "75" series balances is in the hole center distance in the spiral rod.

See page 86 for chart details.

78A Series Non-Tilt 3/8"

- Plastic Tube

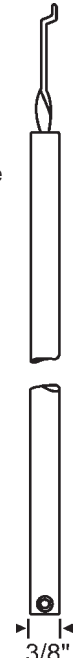

VE ANDERSON

See page 90 for chart details.

TILT & NON-TILT SPIRAL BALANCES

78B Series

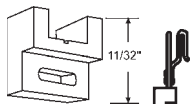

80-604

- Plastic Tube



Ask account manager for detailed chart.

78C Series

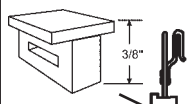

80-605

- Plastic Tube

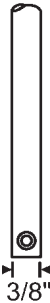

Ask account manager for detailed chart.

78SL Series



- Plastic Tube



Ask account manager for detailed chart.

78M Series



- Metal Tube



ROBERT E. LEE
Ask account manager for detailed chart.

80SL Series



- Plastic Tube



See page 94 for chart details.

80 Series Non-Tilt



- Gray Plastic Tube



AIRMASTER
See page 91 for chart details.

CROSSBOW BALANCES

80A Series Non-Tilt



- Gray Plastic Tube
- Primarily used in New York and New Jersey



See page 92 for chart details.

80B Series Non-Tilt



- Black Plastic Tube



See page 93 for chart details.

Type M Series 13/16"

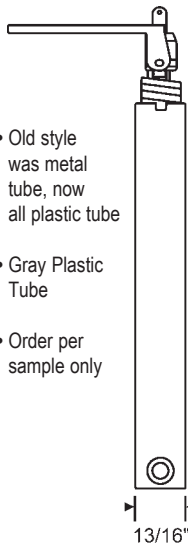

- Old style was metal tube, now all plastic tube
- Gray Plastic Tube
- Order per sample only

Ask account manager for detailed chart.

901 Series Crossbow



See page 120 for chart details.

960SP Series Crossbow



See page 121 for chart details.

909A Series Crossbow



See page 122 for chart details.

Window Balance Identification Display

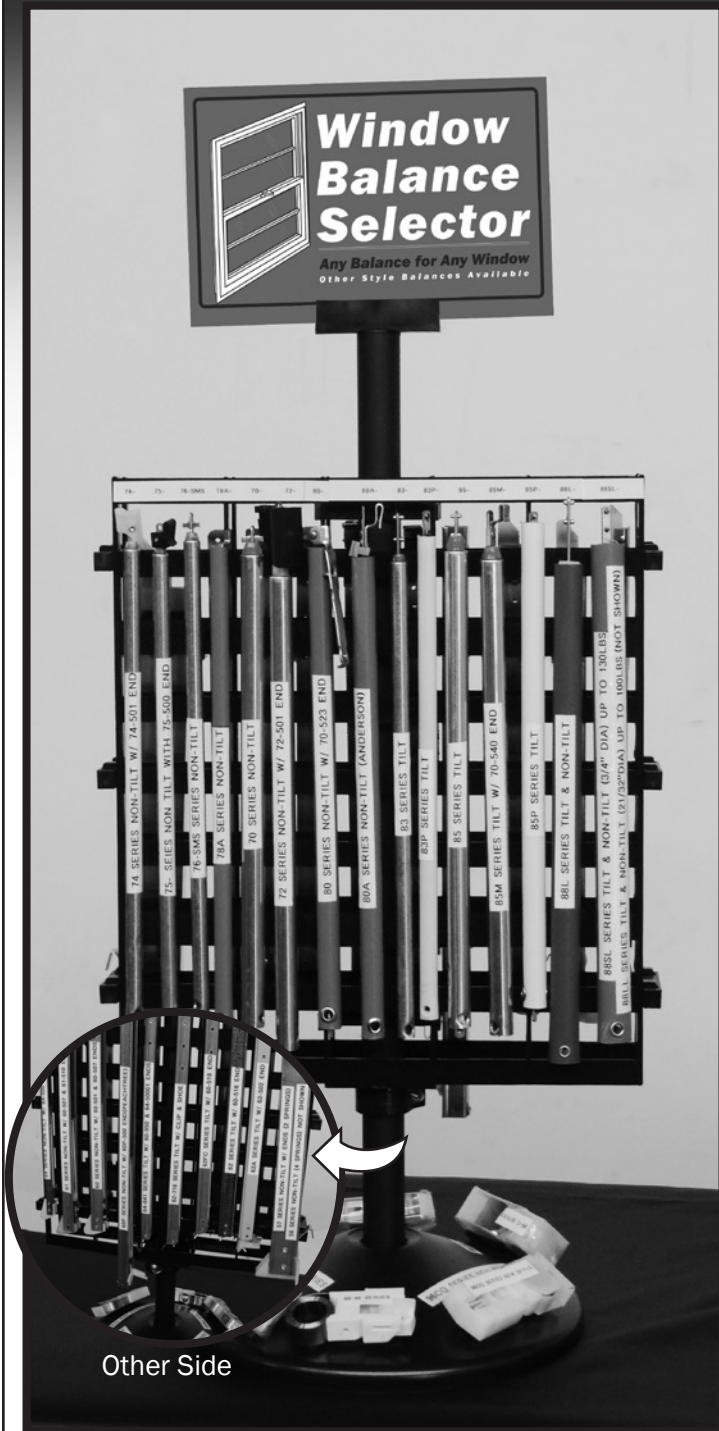

- Includes an assortment of 31 different series channel (Tilt & Non-tilt), tube (Tilt & Non-tilt), and constant force window sash balance samples.
- Counter top display included. (Made of plastic and shipped knocked down)
- Sign included for the top of the display.
- Balances are hook and loop fastener on so they are removable for sample identification and/or transport to site for identification. Each balance is labeled with balance series. Rack is also labeled so the balance samples can be returned to the proper position.
- Also available is a generic "Any Balance for Any Window" flyer that can be customized with your company name & address in a PDF format, to print and hand out (or e-mail) to your customers and for your sales/installation/quote personnel.
- Display rack spins around 360 degrees.
- Display size is approx. 13" wide x 13" deep x 24" high.
- Also great for sales/customer meetings, customer shows/exhibits, open house, training, and other events.
- Well worth the investment and will pay for itself in a short period of time as you increase your balance sales.

57 SERIES NON-TILT BALANCES

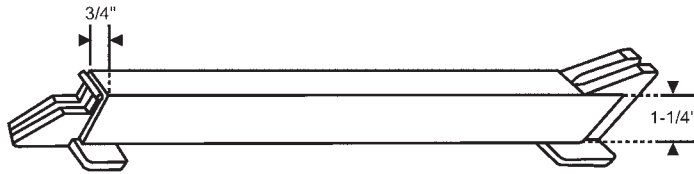

-Max Weight 75lbs.

Note: These are special order balances and are not returnable.

ORDERING INFORMATION

1. Measure metal channel length. Do not include any attached ends.
2. Check number stamped on channel. The first two digits represents the channel length. The second two digits represent the sash weight. (e.g.: The number stamped on the balance is 3248, you would then order #57-32S48. With 57 referring to our series, followed by the length of the balance then the sash weight.)

Note: Top and bottom guides shown below will automatically be attached to your balance unless otherwise specified.

Note: With the 57 Series take out system, the sash balance becomes part of the sash. Therefore, when calculating sash weights, you must add the physical balance weight to the sash weights.

LENGTH OF METAL CHANNEL	NUMBER STAMPED ON BALANCE	OUR PART NUMBER	LENGTH OF METAL CHANNEL	NUMBER STAMPED ON BALANCE	OUR PART NUMBER
13"	13+Weight	57-13S(Sash Weight)	43"	43+Weight	57-43S(Sash Weight)
14"	14+Weight	57-14S(Sash Weight)	44"	44+Weight	57-44S(Sash Weight)
15"	15+Weight	57-15S(Sash Weight)	45"	45+Weight	57-45S(Sash Weight)
16"	16+Weight	57-16S(Sash Weight)	46"	46+Weight	57-46S(Sash Weight)
17"	17+Weight	57-17S(Sash Weight)	47"	47+Weight	57-47S(Sash Weight)
18"	18+Weight	57-18S(Sash Weight)	48"	48+Weight	57-48S(Sash Weight)
19"	19+Weight	57-19S(Sash Weight)	49"	49+Weight	57-49S(Sash Weight)
20"	20+Weight	57-20S(Sash Weight)	50"	50+Weight	57-50S(Sash Weight)
21"	21+Weight	57-21S(Sash Weight)	51"	51+Weight	57-51S(Sash Weight)
22"	22+Weight	57-22S(Sash Weight)	52"	52+Weight	57-52S(Sash Weight)
23"	23+Weight	57-23S(Sash Weight)	53"	53+Weight	57-53S(Sash Weight)
24"	24+Weight	57-24S(Sash Weight)	54"	54+Weight	57-54S(Sash Weight)
25"	25+Weight	57-25S(Sash Weight)	55"	55+Weight	57-55S(Sash Weight)
26"	26+Weight	57-26S(Sash Weight)	56"	56+Weight	57-56S(Sash Weight)
27"	27+Weight	57-27S(Sash Weight)	57"	57+Weight	57-57S(Sash Weight)
28"	28+Weight	57-28S(Sash Weight)	58"	58+Weight	57-58S(Sash Weight)
29"	29+Weight	57-29S(Sash Weight)	59"	59+Weight	57-59S(Sash Weight)
30"	30+Weight	57-30S(Sash Weight)	60"	60+Weight	57-60S(Sash Weight)
31"	31+Weight	57-31S(Sash Weight)	61"	61+Weight	57-61S(Sash Weight)
32"	32+Weight	57-32S(Sash Weight)	62"	62+Weight	57-62S(Sash Weight)
33"	33+Weight	57-33S(Sash Weight)	63"	63+Weight	57-63S(Sash Weight)
34"	34+Weight	57-34S(Sash Weight)	64"	64+Weight	57-64S(Sash Weight)
35"	35+Weight	57-35S(Sash Weight)	65"	65+Weight	57-65S(Sash Weight)
36"	36+Weight	57-36S(Sash Weight)	66"	66+Weight	57-66S(Sash Weight)
37"	37+Weight	57-37S(Sash Weight)	67"	67+Weight	57-67S(Sash Weight)
38"	38+Weight	57-38S(Sash Weight)	68"	68+Weight	57-68S(Sash Weight)
39"	39+Weight	57-39S(Sash Weight)	69"	69+Weight	57-69S(Sash Weight)
40"	40+Weight	57-40S(Sash Weight)	70"	70+Weight	57-70S(Sash Weight)
41"	41+Weight	57-41S(Sash Weight)	71"	71+Weight	57-71S(Sash Weight)
42"	42+Weight	57-42S(Sash Weight)	72"	72+Weight	57-72S(Sash Weight)

For weights above those listed in chart, contact your account manager

TOP GUIDE	BOTTOM GUIDE	SASH CAP	TAKE-OUT CLIP
<p>57-500</p>	<p>57-501</p>	<p>57-600 Black Anodized Aluminum TRACO</p>	<p>58-700 Zinc Plated. Only Available for the 57 & 58 Series Balance.</p>

58 Series Balances are Designed for Heavy Duty Commercial Windows

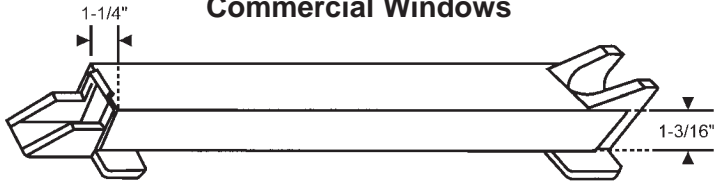

-Max Weight 100lbs.

Note: These are special order balances and are not returnable.

ORDERING INFORMATION

1. Measure metal channel length. Do not include any attached ends.
2. Check number stamped on channel. The first two digits represents the channel length. The second two digits represent the sash weight. (e.g.: The number stamped on the balance is 3248, you would then order #58-32S48. With 58 referring to our series, followed by the length of the balance then the sash weight.)

Note: Top and bottom guides shown below will automatically be attached to your balance unless otherwise specified.

Note: With the 58 Series take out system, the sash balance becomes part of the sash. Therefore, when calculating sash weights, you must add the physical balance weight to the sash weights.

LENGTH OF METAL CHANNEL	NUMBER STAMPED ON BALANCE	OUR PART NUMBER	LENGTH OF METAL CHANNEL	NUMBER STAMPED ON BALANCE	OUR PART NUMBER
13"	13+Weight	58-13S(Sash Weight)	47"	47+Weight	58-47S(Sash Weight)
14"	14+Weight	58-14S(Sash Weight)	48"	48+Weight	58-48S(Sash Weight)
15"	15+Weight	58-15S(Sash Weight)	49"	49+Weight	58-49S(Sash Weight)
16"	16+Weight	58-16S(Sash Weight)	50"	50+Weight	58-50S(Sash Weight)
17"	17+Weight	58-17S(Sash Weight)	51"	51+Weight	58-51S(Sash Weight)
18"	18+Weight	58-18S(Sash Weight)	52"	52+Weight	58-52S(Sash Weight)
19"	19+Weight	58-19S(Sash Weight)	53"	53+Weight	58-53S(Sash Weight)
20"	20+Weight	58-20S(Sash Weight)	54"	54+Weight	58-54S(Sash Weight)
21"	21+Weight	58-21S(Sash Weight)	55"	55+Weight	58-55S(Sash Weight)
22"	22+Weight	58-22S(Sash Weight)	56"	56+Weight	58-56S(Sash Weight)
23"	23+Weight	58-23S(Sash Weight)	57"	57+Weight	58-57S(Sash Weight)
24"	24+Weight	58-24S(Sash Weight)	58"	58+Weight	58-58S(Sash Weight)
25"	25+Weight	58-25S(Sash Weight)	59"	59+Weight	58-59S(Sash Weight)
26"	26+Weight	58-26S(Sash Weight)	60"	60+Weight	58-60S(Sash Weight)
27"	27+Weight	58-27S(Sash Weight)	61"	61+Weight	58-61S(Sash Weight)
28"	28+Weight	58-28S(Sash Weight)	62"	62+Weight	58-62S(Sash Weight)
29"	29+Weight	58-29S(Sash Weight)	63"	63+Weight	58-63S(Sash Weight)
30"	30+Weight	58-30S(Sash Weight)	64"	64+Weight	58-64S(Sash Weight)
31"	31+Weight	58-31S(Sash Weight)	65"	65+Weight	58-65S(Sash Weight)
32"	32+Weight	58-32S(Sash Weight)	66"	66+Weight	58-66S(Sash Weight)
33"	33+Weight	58-33S(Sash Weight)	67"	67+Weight	58-67S(Sash Weight)
34"	34+Weight	58-34S(Sash Weight)	68"	68+Weight	58-68S(Sash Weight)
35"	35+Weight	58-35S(Sash Weight)	69"	69+Weight	58-69S(Sash Weight)
36"	36+Weight	58-36S(Sash Weight)	70"	70+Weight	58-70S(Sash Weight)
37"	37+Weight	58-37S(Sash Weight)	71"	71+Weight	58-71S(Sash Weight)
38"	38+Weight	58-38S(Sash Weight)	72"	72+Weight	58-72S(Sash Weight)
39"	39+Weight	58-39S(Sash Weight)	73"	73+Weight	58-73S(Sash Weight)
40"	40+Weight	58-40S(Sash Weight)	74"	74+Weight	58-74S(Sash Weight)
41"	41+Weight	58-41S(Sash Weight)	75"	75+Weight	58-75S(Sash Weight)
42"	42+Weight	58-42S(Sash Weight)	76"	76+Weight	58-76S(Sash Weight)
43"	43+Weight	58-43S(Sash Weight)	77"	77+Weight	58-77S(Sash Weight)
44"	44+Weight	58-44S(Sash Weight)	78"	78+Weight	58-78S(Sash Weight)
45"	45+Weight	58-45S(Sash Weight)	79"	79+Weight	58-79S(Sash Weight)
46"	46+Weight	58-46S(Sash Weight)	80"	80+Weight	58-80S(Sash Weight)

For weights above those listed in chart, contact your account manager

TOP GUIDE

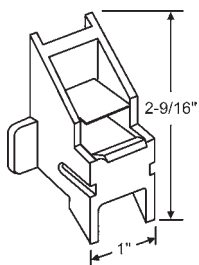

58-500

BOTTOM GUIDE

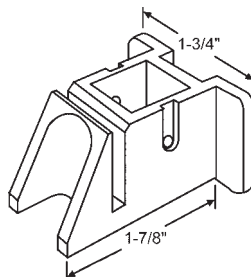

58-501

TAKE-OUT CLIP

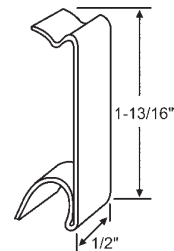

58-700

Zinc Plated. Only Available for the 57 & 58 Series Balance.

60 SERIES CHANNEL BALANCES

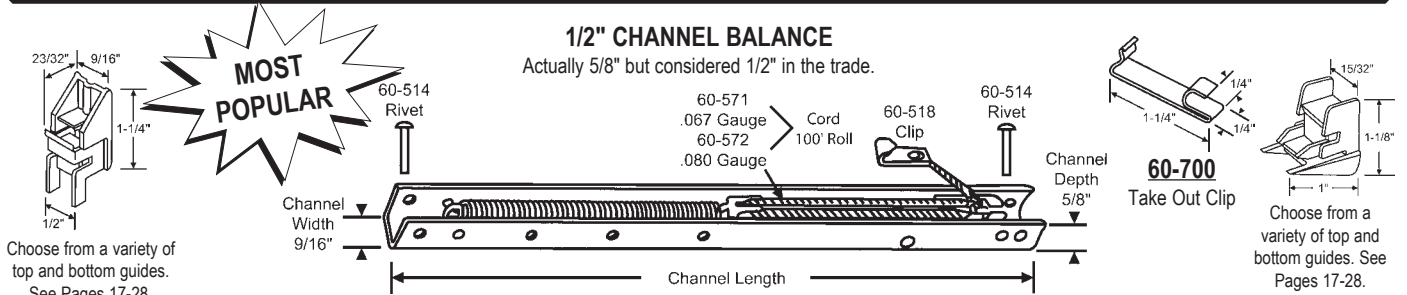

General Information

- Sash weights indicated below are weights that 2 balances per sash will carry with no weather-strip friction considered.
- Balances stamped with a 3-digit number (e.g. 122, 183, 143) or a 2-digit number (e.g. 15, 18, 19) will require you to contact your account manager for more information; such as exact channel length, type of ends attached, etc.
- Any other number/letter variations should also be reviewed with your account manager to ensure your order will be filled correctly.
- If your existing balance has a "BSI" stamped on the face of the balance by the 4 digit number, order exactly as seen on this chart.
- If your existing balance does not have BSI stamped on it and your balance's 4 digit number has a 40 suffix (e.g. 2840, 2940, 3040, 3640 etc.), you have the old style balance and for 29" balances and above -order 2850, 2950, 3050, 3650, etc. If you are unsure, weigh your sash and choose from the weight charts indicated below.
- For sash weights over those indicated on chart below, please provide the following information:
 - Number stamped on balance _____
 - Balance length (do not include ends) _____
 - Sash weight _____
 - Upper or lower sash _____
 - e) 2 or 4 balances per sash _____

Note: Special weight balances were usually stamped with a 4 digit number followed by a two digit number to designate specific weight (e.g. 2640 42 or 2690 42 indicates (2) 27" balances carrying 42 lb. sash.

Ordering Information

- Measure metal channel balance length. (Do not include plastic ends.)
 - Check number stamped on channel. (e.g. 2010, 28A, 3620 etc.)
 - Select our corresponding part number from the chart below.
 - To identify the top and bottom ends to be attached, refer to pages 17-28.
- Note: Top and bottom balance ends must be ordered separately. If you want ends attached, add the letter "A" to the suffix of the part number when ordering. If you find the ends you need and they are located with the popular combinations, look for the suffix number and just add that suffix number to the end of the balance part number you selected (e.g. balance 60-242 with ends 60-507 and 60-501 add the suffix -1 so the final part number is 60-242-1).

Please Note (Important New Information)

Due to increased demand for larger and heavier windows, manufacturers have increased the weight capacity of balances as indicated by our expanded chart. Previously, balances beyond the traditional weight ranges were made for a specific length, weight and often required limited travel and needed to specify upper and lower sash. The examples below show the versatility of the new weight ranges and allow us to inventory these balances to cover a broader range of windows

Examples: Old Number 60-26S42L (27" 42lb - Lower Sash) New Number 60-2680 (27" 42-45lb)
 60-26S42U (27" 42lb - Upper Sash)
 60-26S44L (27" 44lb. - Lower Sash)
 60-26S44U (27" 44lb. - Upper Sash)

All balances listed in this chart no longer need to designate upper or lower and they all have full travel. Balances with weights and lengths above those listed on the chart will require sash weight and upper or lower designation and will have limited travel

Example: 27" Channel balance for 49lb. sash
 60-26S49 (for lower sash)
 60-26S49U (for upper sash)

For weights above those listed in this chart, see next page.

Length of Metal Channel	Number Stamped on Balance	Sash Weight	Our Part Number	Length of Metal Channel	Number Stamped on Balance	Sash Weight	Our Part Number	Length of Metal Channel	Number Stamped on Balance	Sash Weight	Our Part Number	Length of Metal Channel	Number Stamped on Balance	Sash Weight	Our Part Number
13"	1210	3-6 lbs	60-121	17"	1660	22-25 lbs	60-1660	21"	2020	8-12 lbs	60-202	24"	2370	34-37 lbs	60-2370
13"	1220	6-9 lbs	60-122	17"	1665	25-29 lbs	60-1665	21"	2030	12-15 lbs	60-203	24"	2375	37-40 lbs	60-2375
13"	1230	9-11 lbs	60-123	18"	1710	5-8 lbs	60-171	21"	2040	15-23 lbs	60-204	25"	2410	5-9 lbs	60-241
13"	1240	11-12 lbs	60-124	18"	1720	8-12 lbs	60-172	21"	2050	23-27 lbs	60-2050	25"	2420	9-15 lbs	60-242
13"	1250	12-15 lbs	60-1250	18"	1730	12-14 lbs	60-173	21"	2060	27-30 lbs	60-2060	25"	2430	15-19 lbs	60-243
13"	1260	15-18 lbs	60-1260	18"	1740	14-17 lbs	60-174	21"	2065	30-34 lbs	60-2065	25"	2440	19-24 lbs	60-244
14"	1310	3-6 lbs	60-131	18"	1750	17-20 lbs	60-1750	21"	2070	34-37 lbs	60-2070	25"	2450	24-27 lbs	60-2450
14"	1320	6-9 lbs	60-132	18"	1760	20-23 lbs	60-1760	21"	2075	37-40 lbs	60-2075	25"	2460	27-30 lbs	60-2460
14"	1330	9-11 lbs	60-133	18"	1765	23-25 lbs	60-1765	22"	2110	5-8 lbs	60-211	25"	2465	30-33 lbs	60-2465
14"	1340	11-12 lbs	60-134	18"	1770	25-29 lbs	60-1770	22"	2120	8-12 lbs	60-212	25"	2470	33-36 lbs	60-2470
14"	1350	12-15 lbs	60-1350	18"	1775	29-32 lbs	60-1775	22"	2130	12-15 lbs	60-213	25"	2475	36-39 lbs	60-2475
14"	1360	15-18 lbs	60-1360	19"	1810	5-8 lbs	60-181	22"	2140	15-23 lbs	60-214	25"	2480	39-42 lbs	60-2480
14"	1365	18-20 lbs	60-1365	19"	1820	8-12 lbs	60-182	22"	2150	23-27 lbs	60-2150	25"	2485	42-45 lbs	60-2485
15"	1410	4-6 lbs	60-141	19"	1830	12-14 lbs	60-183	22"	2160	27-30 lbs	60-2160	26"	2510	5-9 lbs	60-251
15"	1420	6-10 lbs	60-142	19"	1840	14-17 lbs	60-184	22"	2165	30-34 lbs	60-2165	26"	2520	9-15 lbs	60-252
15"	1430	10-12 lbs	60-143	19"	1850	17-20 lbs	60-1850	22"	2170	34-37 lbs	60-2170	26"	2530	15-19 lbs	60-253
15"	1440	12-13 lbs	60-144	19"	1860	20-23 lbs	60-1860	22"	2175	37-40 lbs	60-2175	26"	2540	19-25 lbs	60-254
15"	1450	13-17 lbs	60-1450	19"	1865	23-25 lbs	60-1865	23"	2210	5-8 lbs	60-221	26"	2550	25-28 lbs	60-2550
15"	1460	17-20 lbs	60-1460	19"	1870	25-29 lbs	60-1870	23"	2220	8-12 lbs	60-222	26"	2560	28-30 lbs	60-2560
15"	1465	20-23 lbs	60-1465	19"	1875	29-32 lbs	60-1875	23"	2230	12-19 lbs	60-223	26"	2565	30-33 lbs	60-2565
16"	1510	4-6 lbs	60-151	19"	1880	32-35 lbs	60-1880	23"	2240	19-23 lbs	60-224	26"	2570	33-36 lbs	60-2570
16"	1520	6-10 lbs	60-152	20"	1910	5-8 lbs	60-191	23"	2250	23-27 lbs	60-2250	26"	2575	36-39 lbs	60-2575
16"	1530	10-12 lbs	60-153	20"	1920	8-12 lbs	60-192	23"	2260	27-30 lbs	60-2260	26"	2580	39-42 lbs	60-2580
16"	1540	12-13 lbs	60-154	20"	1930	12-14 lbs	60-193	23"	2265	30-34 lbs	60-2265	26"	2585	42-45 lbs	60-2585
16"	1550	13-17 lbs	60-1550	20"	1940	14-17 lbs	60-194	23"	2270	34-37 lbs	60-2270	27"	2610	5-9 lbs	60-261
16"	1560	17-20 lbs	60-1560	20"	1950	17-21 lbs	60-1950	23"	2275	37-40 lbs	60-2275	27"	2620	9-13 lbs	60-262
16"	1565	20-23 lbs	60-1565	20"	1960	21-24 lbs	60-1960	24"	2310	5-8 lbs	60-231	27"	2630	13-19 lbs	60-263
16"	1570	23-26 lbs	60-1570	20"	1965	24-27 lbs	60-1965	24"	2320	9-15 lbs	60-232	27"	2640	19-26 lbs	60-264
17"	1610	5-8 lbs	60-161	20"	1970	27-30 lbs	60-1970	24"	2330	15-18 lbs	60-233	27"	2650	26-30 lbs	60-2650
17"	1620	8-12 lbs	60-162	20"	1975	30-34 lbs	60-1975	24"	2340	18-23 lbs	60-234	27"	2660	30-33 lbs	60-2660
17"	1630	12-14 lbs	60-163	20"	1980	34-37 lbs	60-1980	24"	2350	23-27 lbs	60-2350	27"	2665	33-36 lbs	60-2665
17"	1640	14-19 lbs	60-164	20"	1985	37-40 lbs	60-1985	24"	2360	27-30 lbs	60-2360	27"	2670	36-39 lbs	60-2670
17"	1650	19-22 lbs	60-1650	21"	2010	5-8 lbs	60-201	24"	2365	30-34 lbs	60-2365	27"	2675	39-42 lbs	60-2675

Continued on next page

Continued from previous page

Length of Metal Channel	Number Stamped on Balance	Sash Weight	Our Part Number	Length of Metal Channel	Number Stamped on Balance	Sash Weight	Our Part Number	Length of Metal Channel	Number Stamped on Balance	Sash Weight	Our Part Number	Length of Metal Channel	Number Stamped on Balance	Sash Weight	Our Part Number
27"	2680	42-45 lbs	60-2680	34"	3370	39-42 lbs	60-3370	42"	4160	35-39 lbs	60-4160	50"	4950	30-35 lbs	60-4950
28"	2710	5-9 lbs	60-271	34"	3375	42-45 lbs	60-3375	42"	4165	39-42 lbs	60-4165	50"	4960	35-39 lbs	60-4960
28"	2720	9-13 lbs	60-272	35"	3410	8-13 lbs	60-341	42"	4170	42-45 lbs	60-4170	50"	4965	39-42 lbs	60-4965
28"	2730	13-19 lbs	60-273	35"	3420	13-18 lbs	60-342	43"	4210	9-14 lbs	60-421	50"	4970	42-45 lbs	60-4970
28"	2740	19-26 lbs	60-274	35"	3430	18-23 lbs	60-343	43"	4220	14-19 lbs	60-422	51"	5010	4-14 lbs	60-5010
28"	2750	26-30 lbs	60-2750	35"	3440	23-30 lbs	60-344	43"	4230	19-24 lbs	60-423	51"	5020	14-19 lbs	60-5020
28"	2760	30-33 lbs	60-2760	35"	3450	30-34 lbs	60-3450	43"	4240	24-30 lbs	60-424	51"	5030	19-25 lbs	60-5030
28"	2765	33-36 lbs	60-2765	35"	3460	34-39 lbs	60-3460	43"	4250	30-35 lbs	60-4250	51"	5040	25-32 lbs	60-5040
28"	2770	36-39 lbs	60-2770	35"	3465	39-42 lbs	60-3465	43"	4260	35-39 lbs	60-4260	51"	5050	32-35 lbs	60-5050
28"	2775	39-42 lbs	60-2775	35"	3470	42-45 lbs	60-3470	43"	4265	39-42 lbs	60-4265	51"	5060	35-39 lbs	60-5060
28"	2780	42-45 lbs	60-2780	36"	3510	8-13 lbs	60-351	43"	4270	42-45 lbs	60-4270	51"	5065	39-42 lbs	60-5065
29"	2810	7-12 lbs	60-281	36"	3520	13-18 lbs	60-352	44"	4310	9-14 lbs	60-431	51"	5070	42-45 lbs	60-5070
29"	2820	12-16 lbs	60-282	36"	3530	18-23 lbs	60-353	44"	4320	14-19 lbs	60-432	52"	5110	4-14 lbs	60-5110
29"	2830	16-23 lbs	60-283	36"	3540	23-30 lbs	60-354	44"	4330	19-24 lbs	60-433	52"	5120	14-19 lbs	60-5120
29"	2840	23-28 lbs	60-284	36"	3550	30-35 lbs	60-3550	44"	4340	24-30 lbs	60-434	52"	5130	19-25 lbs	60-5130
29"	2850	28-32 lbs	60-2850	36"	3560	35-39 lbs	60-3560	44"	4350	30-35 lbs	60-4350	52"	5140	25-32 lbs	60-5140
29"	2860	32-35 lbs	60-2860	36"	3565	39-42 lbs	60-3565	44"	4360	35-39 lbs	60-4360	52"	5150	32-35 lbs	60-5150
29"	2865	35-39 lbs	60-2865	36"	3570	42-45 lbs	60-3570	44"	4365	39-42 lbs	60-4365	52"	5160	35-39 lbs	60-5160
29"	2870	39-42 lbs	60-2870	37"	3610	8-13 lbs	60-361	44"	4370	42-45 lbs	60-4370	52"	5165	39-42 lbs	60-5165
29"	2875	42-45 lbs	60-2875	37"	3620	13-18 lbs	60-362	45"	4410	9-14 lbs	60-441	52"	5170	42-45 lbs	60-5170
30"	2910	7-12 lbs	60-291	37"	3630	18-23 lbs	60-363	45"	4420	14-19 lbs	60-442	53"	5210	4-14 lbs	60-5210
30"	2920	12-16 lbs	60-292	37"	3640	23-30 lbs	60-364	45"	4430	19-24 lbs	60-443	53"	5220	14-19 lbs	60-5220
30"	2930	16-23 lbs	60-293	37"	3650	30-35 lbs	60-3650	45"	4440	24-30 lbs	60-444	53"	5230	19-25 lbs	60-5230
30"	2940	23-28 lbs	60-294	37"	3660	35-39 lbs	60-3660	45"	4450	30-35 lbs	60-4450	53"	5240	25-32 lbs	60-5240
30"	2950	28-32 lbs	60-2950	37"	3665	39-42 lbs	60-3665	45"	4460	35-39 lbs	60-4460	53"	5250	32-35 lbs	60-5250
30"	2960	32-35 lbs	60-2960	37"	3670	42-45 lbs	60-3670	45"	4465	39-42 lbs	60-4465	53"	5260	35-39 lbs	60-5260
30"	2965	35-39 lbs	60-2965	38"	3710	8-13 lbs	60-371	45"	4470	42-45 lbs	60-4470	53"	5265	39-42 lbs	60-5265
30"	2970	39-42 lbs	60-2970	38"	3720	13-18 lbs	60-372	46"	4510	9-14 lbs	60-451	53"	5270	42-45 lbs	60-5270
30"	2975	42-45 lbs	60-2975	38"	3730	18-23 lbs	60-373	46"	4520	14-19 lbs	60-452	54"	5310	4-14 lbs	60-5310
31"	3010	7-12 lbs	60-301	38"	3740	23-30 lbs	60-374	46"	4530	19-24 lbs	60-453	54"	5320	14-19 lbs	60-5320
31"	3020	12-16 lbs	60-302	38"	3750	30-35 lbs	60-3750	46"	4540	24-30 lbs	60-454	54"	5330	19-25 lbs	60-5330
31"	3030	16-23 lbs	60-303	38"	3760	35-39 lbs	60-3760	46"	4550	30-35 lbs	60-4550	54"	5340	25-32 lbs	60-5340
31"	3040	23-28 lbs	60-304	38"	3765	39-42 lbs	60-3765	46"	4560	35-39 lbs	60-4560	54"	5350	32-35 lbs	60-5350
31"	3050	28-32 lbs	60-3050	38"	3770	42-45 lbs	60-3770	46"	4565	39-42 lbs	60-4565	54"	5360	35-39 lbs	60-5360
31"	3060	32-35 lbs	60-3060	39"	3810	9-14 lbs	60-381	46"	4570	42-45 lbs	60-4570	54"	5365	39-42 lbs	60-5365
31"	3065	35-39 lbs	60-3065	39"	3820	14-19 lbs	60-382	47"	4610	9-14 lbs	60-461	54"	5370	42-45 lbs	60-5370
31"	3070	39-42 lbs	60-3070	39"	3830	19-24 lbs	60-383	47"	4620	14-19 lbs	60-462				
31"	3075	42-45 lbs	60-3075	39"	3840	24-30 lbs	60-384	47"	4630	19-24 lbs	60-463				
32"	3110	7-12 lbs	60-311	39"	3850	30-35 lbs	60-3850	47"	4640	24-30 lbs	60-464				
32"	3120	12-16 lbs	60-312	39"	3860	35-39 lbs	60-3860	47"	4650	30-35 lbs	60-4650				
32"	3130	16-23 lbs	60-313	39"	3865	39-42 lbs	60-3865	47"	4660	35-39 lbs	60-4660				
32"	3140	23-28 lbs	60-314	39"	3870	42-45 lbs	60-3870	47"	4665	39-42 lbs	60-4665				
32"	3150	28-32 lbs	60-3150	40"	3910	9-14 lbs	60-391	47"	4670	42-45 lbs	60-4670				
32"	3160	32-35 lbs	60-3160	40"	3920	14-19 lbs	60-392	48"	4710	9-14 lbs	60-471				
32"	3165	35-39 lbs	60-3165	40"	3930	19-24 lbs	60-393	48"	4720	14-19 lbs	60-472				
32"	3170	39-42 lbs	60-3170	40"	3940	24-30 lbs	60-394	48"	4730	19-24 lbs	60-473				
32"	3175	42-45 lbs	60-3175	40"	3950	30-35 lbs	60-3950	48"	4740	24-30 lbs	60-474				
33"	3210	8-13 lbs	60-321	40"	3960	35-39 lbs	60-3960	48"	4750	30-35 lbs	60-4750				
33"	3220	13-18 lbs	60-322	40"	3965	39-42 lbs	60-3965	48"	4760	35-39 lbs	60-4760				
33"	3230	18-23 lbs	60-323	40"	3970	42-45 lbs	60-3970	48"	4765	39-42 lbs	60-4765				
33"	3240	23-28 lbs	60-324	41"	4010	9-14 lbs	60-401	48"	4770	42-45 lbs	60-4770				
33"	3250	28-32 lbs	60-3250	41"	4020	14-19 lbs	60-402	49"	4810	9-14 lbs	60-481				
33"	3260	32-35 lbs	60-3260	41"	4030	19-23 lbs	60-403	49"	4820	14-19 lbs	60-482				
33"	3265	35-39 lbs	60-3265	41"	4040	23-30 lbs	60-404	49"	4830	19-24 lbs	60-483				
33"	3270	39-42 lbs	60-3270	41"	4050	30-35 lbs	60-4050	49"	4840	24-32 lbs	60-484				
33"	3275	42-45 lbs	60-3275	41"	4060	35-39 lbs	60-4060	49"	4850	30-35 lbs	60-4850				
34"	3310	8-13 lbs	60-331	41"	4065	39-42 lbs	60-4065	49"	4860	35-39 lbs	60-4860				
34"	3320	13-18 lbs	60-332	41"	4070	42-45 lbs	60-4070	49"	4865	39-42 lbs	60-4865				
34"	3330	18-23 lbs	60-333	42"	4110	9-14 lbs	60-411	49"	4870	42-45 lbs	60-4870				
34"	3340	23-28 lbs	60-334	42"	4120	14-19 lbs	60-412	50"	4910	9-14 lbs	60-491				
34"	3350	28-32 lbs	60-3350	42"	4130	19-24 lbs	60-413	50"	4920	14-19 lbs	60-492				
34"	3360	32-35 lbs	60-3360	42"	4140	24-30 lbs	60-414	50"	4930	19-24 lbs	60-493				
34"	3365	35-39 lbs	60-3365	42"	4150	30-35 lbs	60-4150	50"	4940	24-32 lbs	60-494				

60 SERIES BALANCE ACCESSORIES

60 SERIES MOST POPULAR COMBINATIONS

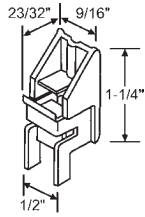

60-507
Top

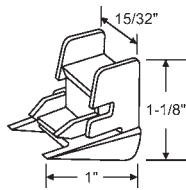

60-501
Bottom

SEASONSHIELD/ALECO

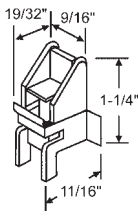

60-508
Top

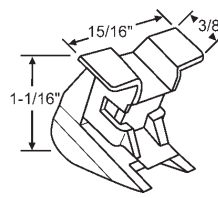

Suffix -3
60-503
Bottom

CROSS EASTERN/PENCO/MILLER/REMINGTON

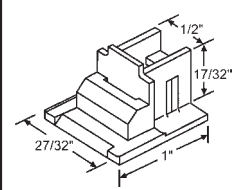

60-595
Top

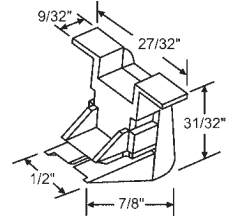

Suffix -28
60-596
Bottom

PAN AM

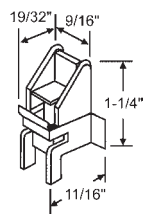

60-508
Top

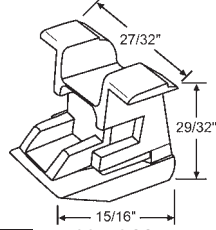

60-5011
Bottom

MILESTONE/FL EXTRUDERS

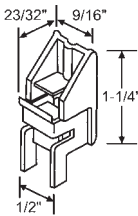

60-507
Top

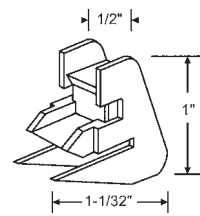

Suffix -0
60-500
Bottom

OLD KINCO/HARCAR/NUAIR/SUNSHINE/EFCO

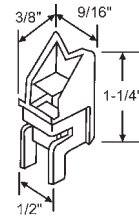

60-936
Top

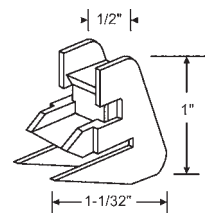

Suffix -36
60-500
Bottom

YALE OGRON

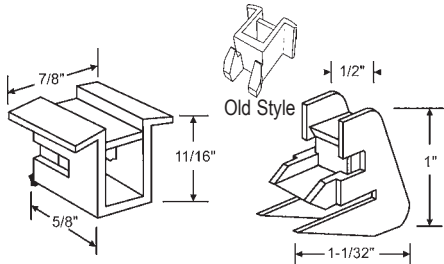

60-506
Top

Suffix -6

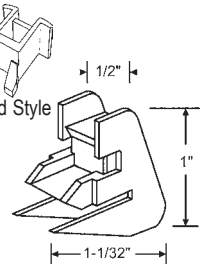

60-500
Bottom

CAPITOL

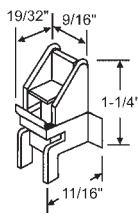

60-508
Top

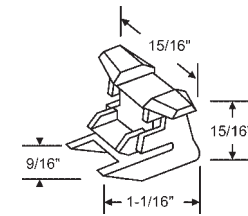

Suffix -8
60-516
Bottom

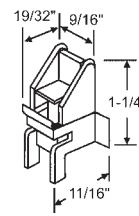

60-508
Top

Suffix -27

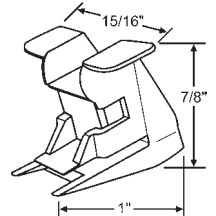

60-943
Bottom

ALCAN

60 SERIES OTHER COMBINATIONS

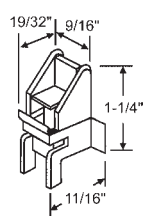

60-508
Top

Suffix -40

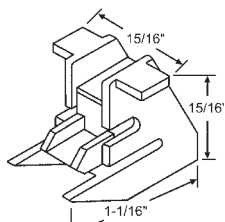

60-904
Bottom

NORANDEX

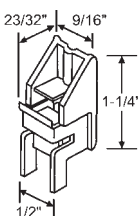

60-507
Top

Suffix -2

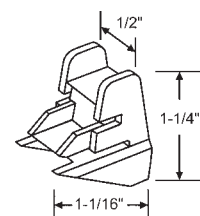

60-502
Bottom

CROSSLY 700 SERIES

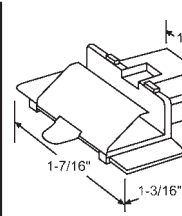

60-510
Top

Suffix -4

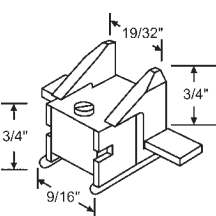

60-504
Bottom

AMERICAN CRAFTSMAN/SILVER LINE

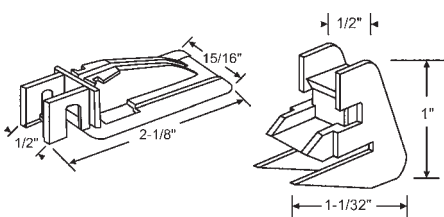

60-509
Top

Suffix -5

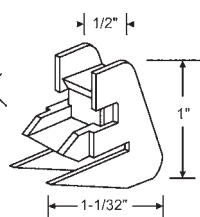

60-500
Bottom

WT INDUSTRIES (REPLACEMENT)

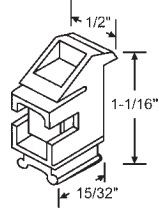

60-560
Top

Suffix -7

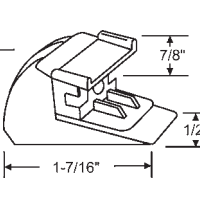

60-561
Bottom

ACORN

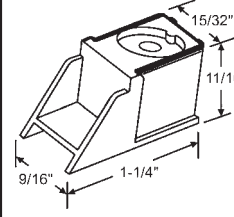

60-907
Top

Suffix -9

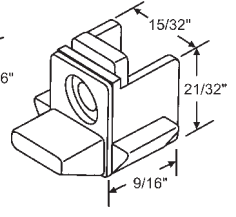

60-908
Bottom

AMERICAN CRAFTSMAN/SILVER LINE

SASH SUPPORT SYSTEMS

60 SERIES BALANCE ACCESSORIES

60 SERIES OTHER COMBINATIONS

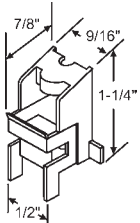

60-916
Top

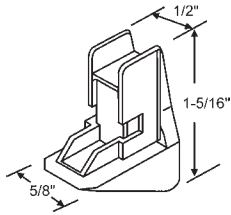

60-915
Bottom

CAPITOL/MILLER

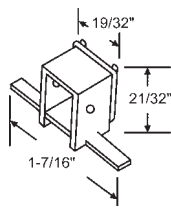

60-569
Top

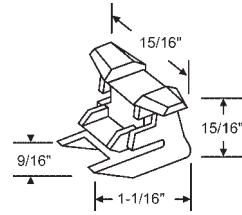

60-516
Bottom

ROLLYSON

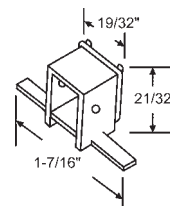

60-569
Top

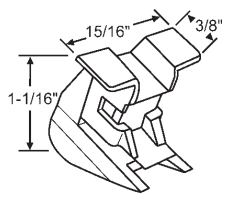

60-503
Bottom

ROLLYSON

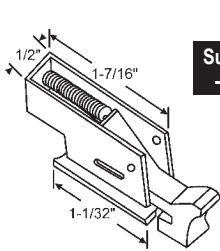

60-513
Top

Suffix -13

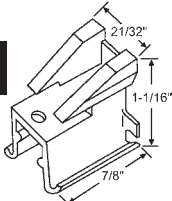

60-505

Bottom. Must be installed with screw 20-046 at time of installation.

GTO 4 WINDOWS/GENERAL BRONZE

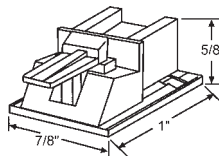

60-575
Top

Suffix -14

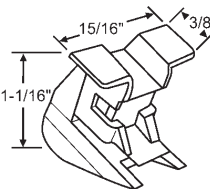

60-503
Bottom

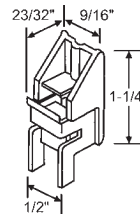

60-507
Top

Suffix -15

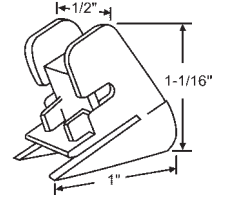

60-587
Bottom

KINCO/DIXIE/CLEARVIEW/SEASONALL

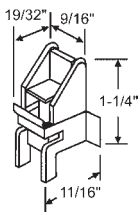

60-508
Top

Suffix -16

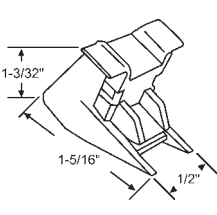

60-598
Bottom

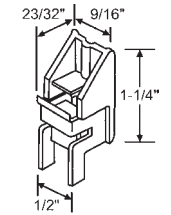

60-507
Top

Suffix -17

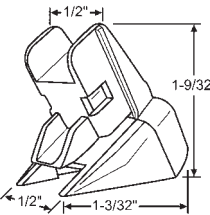

60-597
Bottom

ESP

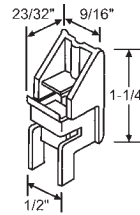

60-507
Top

Suffix -18

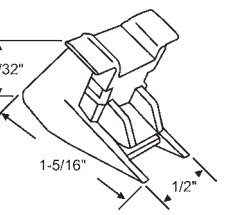

60-598
Bottom

FIBERLUX/BELLVIEW

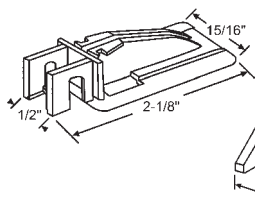

60-509
Top

Suffix -19

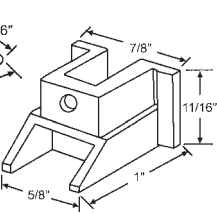

60-576
Bottom

WT INDUSTRIES (ORIGINAL VERSION)

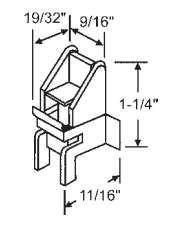

60-508
Top

Suffix -20

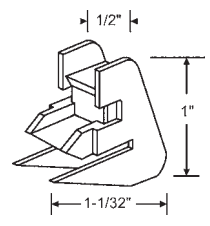

60-500
Bottom

CE ANDERSON/ALENCO/MILLER

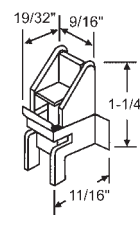

60-508
Top

Suffix -21

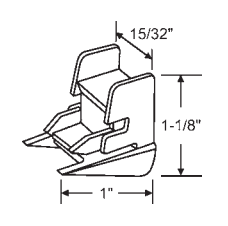

60-501
Bottom

PGT/VINYLTEC

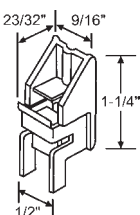

60-507
Top

Suffix -23

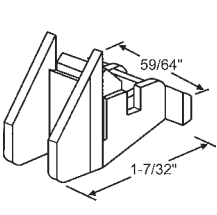

60-987
Bottom

ALCOA

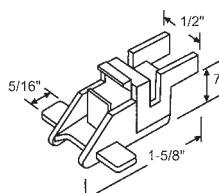

60-901
Top

Suffix -24

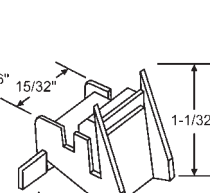

60-902
Bottom

CROSSLY 780 SERIES

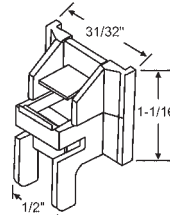

900-10269
Top

Suffix -25

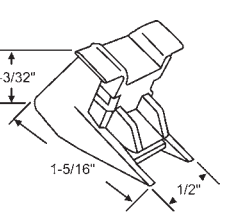

60-598
Bottom

BELLVIEW

60 SERIES BALANCE ACCESSORIES

60 SERIES OTHER COMBINATIONS

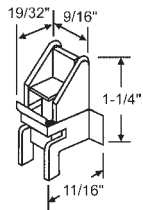

60-508
Top

Suffix -26

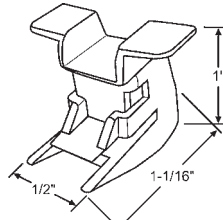

60-980
Bottom

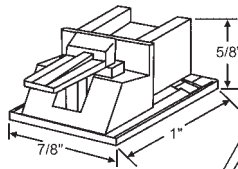

60-575
Top

Suffix -29

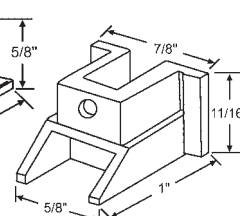

60-576
Bottom

PAN AM

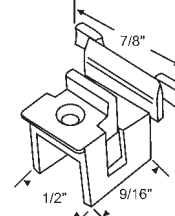

60-919
Top

Suffix -30

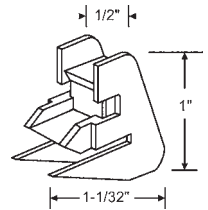

60-500
Bottom

NEW SECURITY

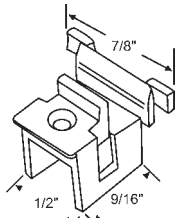

60-919
Top

Suffix -31

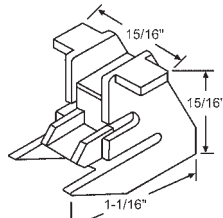

60-904
Bottom

OLD SECURITY

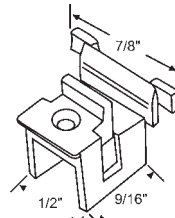

60-919
Top

Suffix -31R

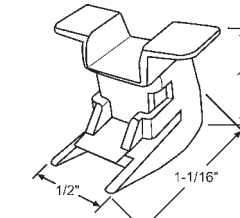

60-980
Bottom

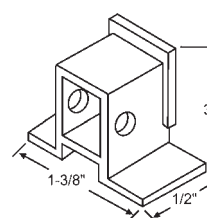

60-903
Top

Suffix -32

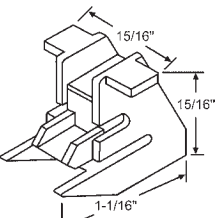

60-904
Bottom

ROLLYSON ORIGINAL

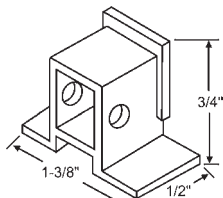

60-903
Top

Suffix -32R

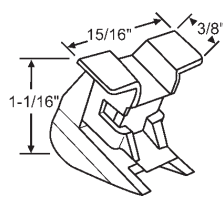

60-503
Bottom

ROLLYSON

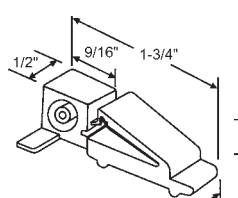

60-563
Top

Suffix -33

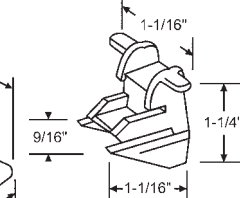

60-564
Bottom

JONES

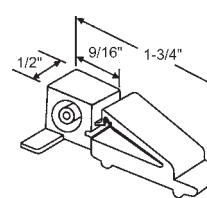

60-563
Top

Suffix -33R

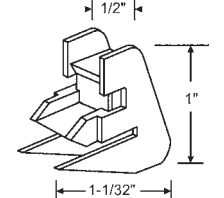

60-500
Bottom

JONES/OLD SECURITY

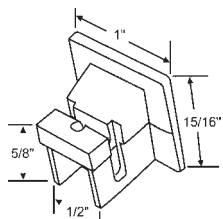

60-905
Top

Suffix -34

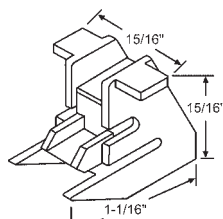

60-904
Bottom

NEW SECURITY

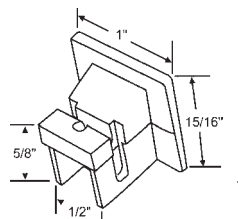

60-905
Top

Suffix -34R

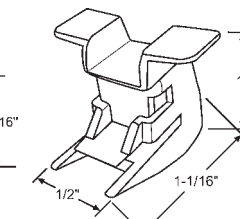

60-980
Bottom

SECURITY/TRACO

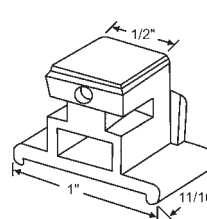

60-933
Top

Suffix -37

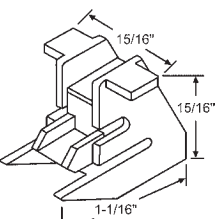

60-904
Bottom

ROLLYSON/AMERICAN ORIGINAL

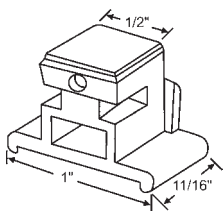

60-933
Top

Suffix -37R

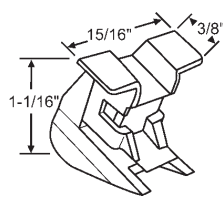

60-503
Bottom

AMERICAN WINDOW

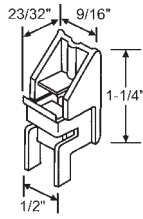

60-507
Top

Suffix 39

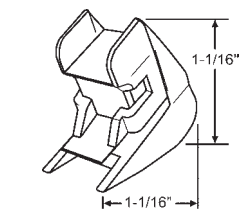

60-944
Bottom

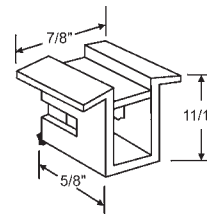

60-506
Top

Suffix -41

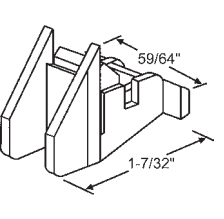

60-987
Bottom

CAPITOL

SASH SUPPORT SYSTEMS

60 SERIES BALANCE ACCESSORIES

60 SERIES OTHER COMBINATIONS

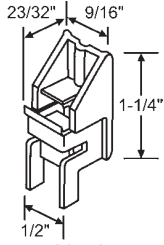

60-507
Top

Suffix
-43

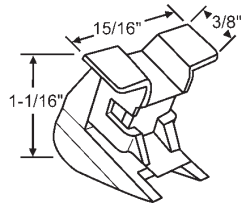

60-503
Bottom

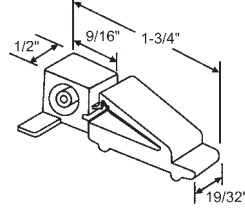

60-563
Top

Suffix
-44

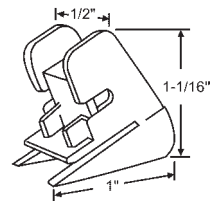

60-587
Bottom

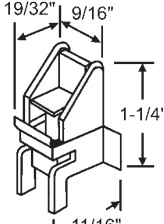

60-508
Top

Suffix
-45

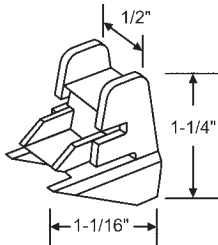

60-502
Bottom

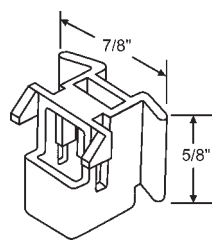

60-591
Top

Suffix
-46

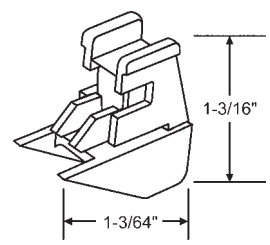

60-590
Bottom

CAPITOL

TOP BRACKETS

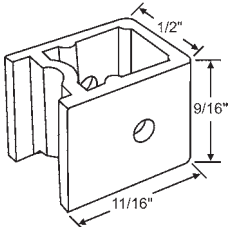

60-568
SWS

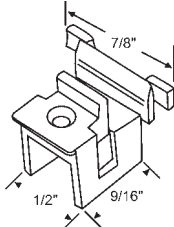

60-919
OLD SECURITY

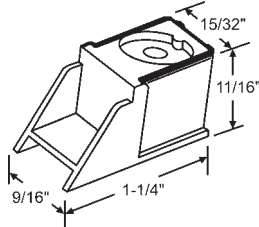

60-907
SILVER LINE

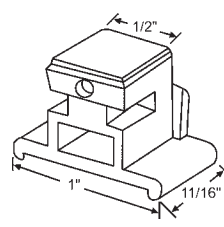

60-933

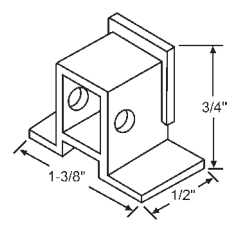

60-903
ROLLYSON

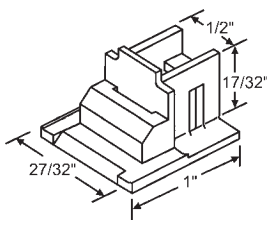

60-595
PAN AM

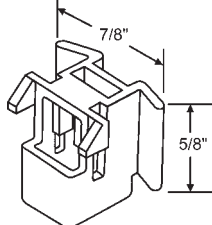

60-591
CAPITOL

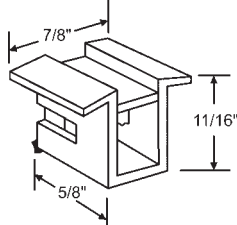

60-506
CAPITOL

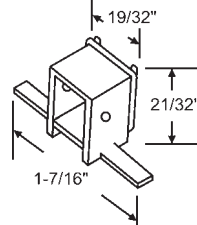

60-569
ROLLYSON

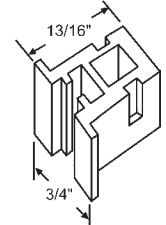

900-15343
WEATHERVANE

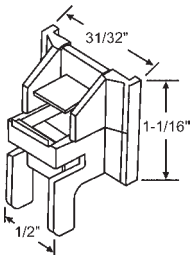

900-10269
BELLVIEW

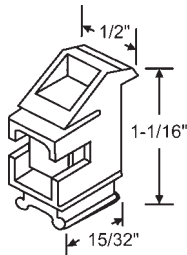

60-560
ACORN

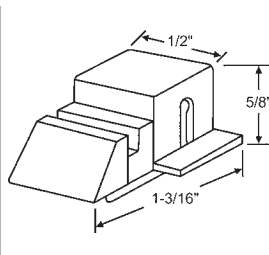

60-578
BELLHOUSE

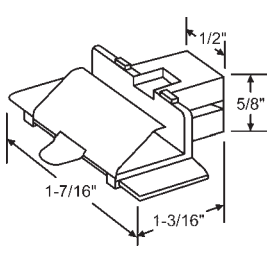

60-510
CROSSLY

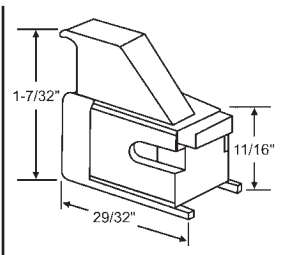

60-511
IDA

60 SERIES BALANCE ACCESSORIES

TOP BRACKETS

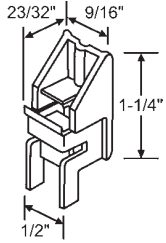

Part #	Color
60-507	White
60-507B	Black

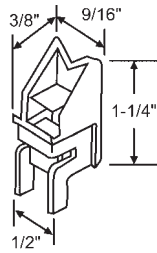

60-936
YALE OGRON

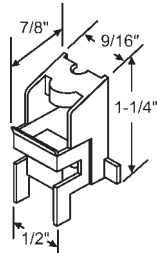

60-916
CAPITOL

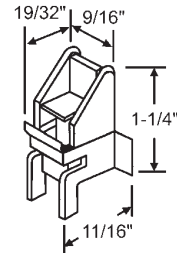

60-508

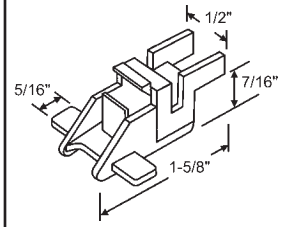

60-901
CROSSLY

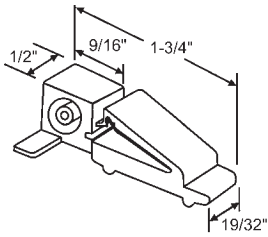

60-563
JONES

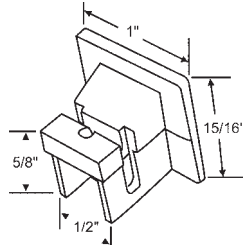

60-905
NEW SECURITY

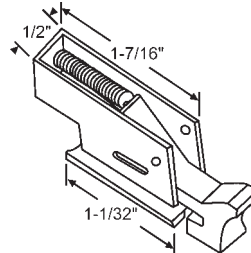

60-513
GENERAL BRONZE

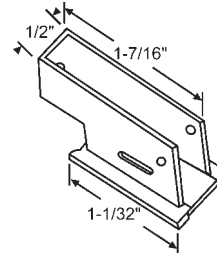

60-513B
Body Only

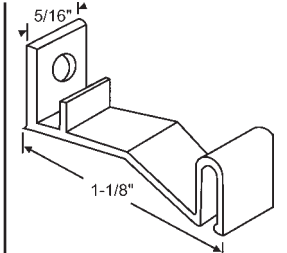

60-592
Metal Toggle. Used with 60-513B

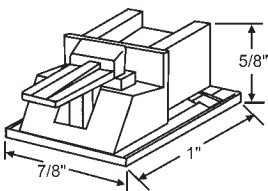

60-575
PAN AM

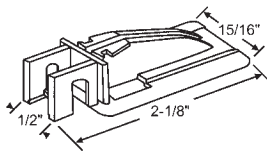

60-509
WT INDUSTRIES

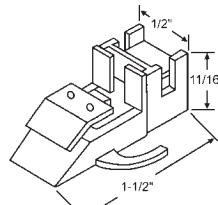

60-583
DARYL

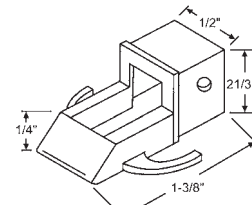

60-586
DARYL

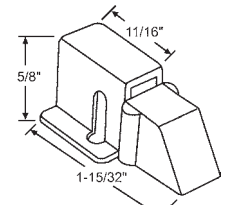

60-562
SWS

BOTTOM BRACKETS

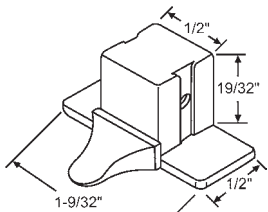

60-594

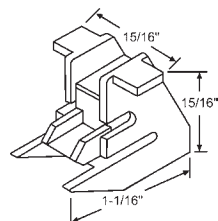

60-904
ROLLYSON

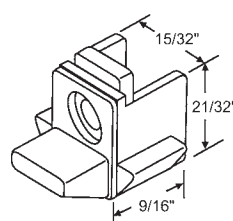

60-908
SILVER LINE

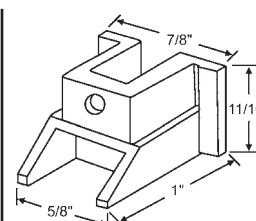

60-576
PAN AM

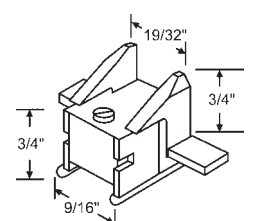

60-504
CROSSLY

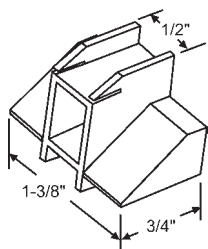

900-15344
WEATHERVANE

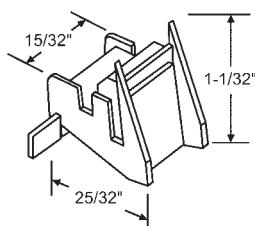

60-902
CROSSLY

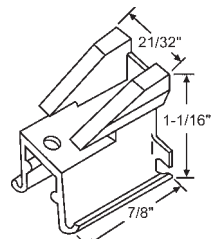

60-505
Must be installed with screw 20-046 at time of installation.
GENERAL BRONZE

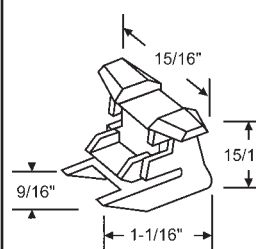

60-516
ROLLYSON

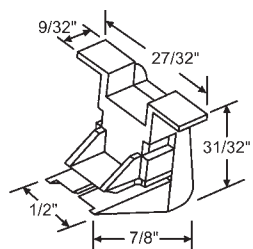

60-596
PAN AM

SASH SUPPORT SYSTEMS

60 SERIES BALANCE ACCESSORIES

BOTTOM BRACKETS

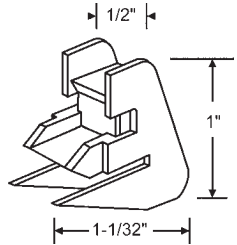

60-500
CAPITOL/WT INDUSTRIES

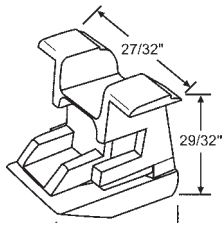

60-5011
Nylon
UNIQUE

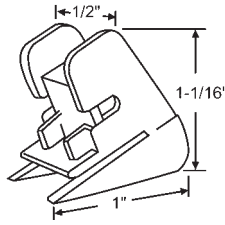

60-587
SEASONALL

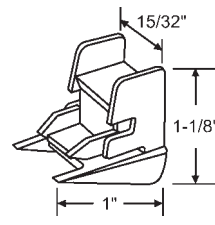

60-501
GENERAL BRONZE

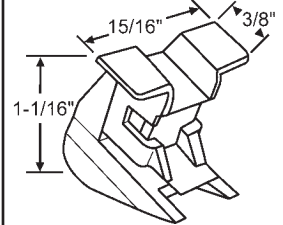

60-503

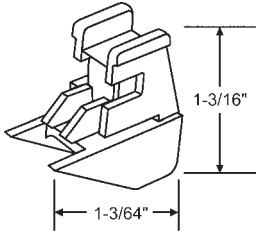

60-590
CAPITOL

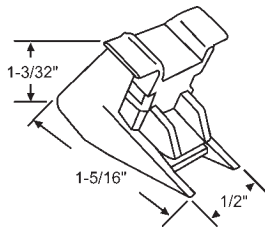

60-598
FIBERLUX

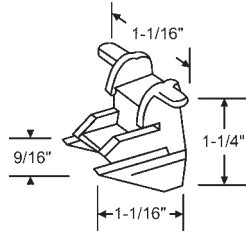

60-564
JONES

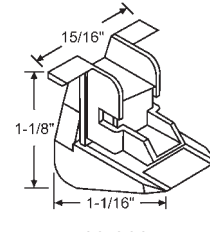

60-909
No Longer Available. Use: 60-503
CAPITOL

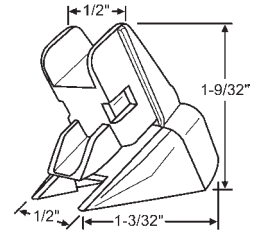

60-597

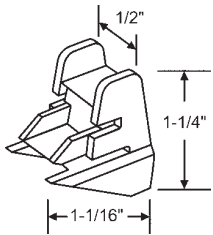

60-502
SEASONALL

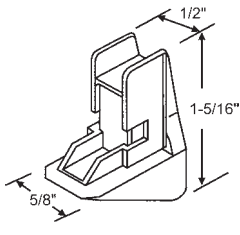

60-915
CAPITOL

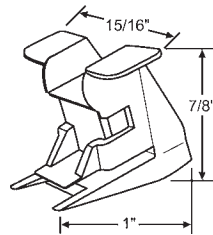

60-943
Nylon
ALCAN

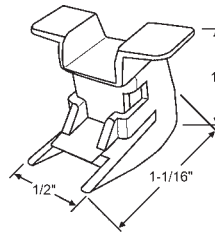

60-980
Winged

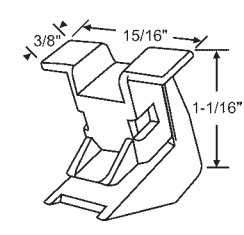

60-930
PINO

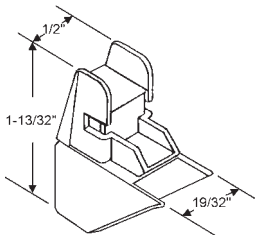

60-922B

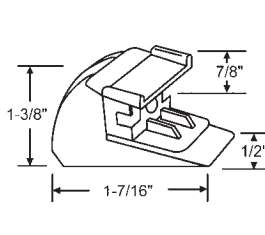

60-561
ACORN

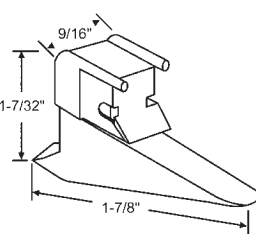

60-512
IDA

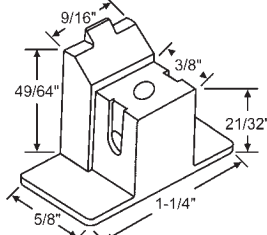

60-593
Bottom Bracket

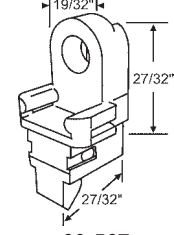

60-567
Bottom Bracket
BURCON

TERMINAL CLIP

STEEL RIVETS

PLASTIC TOP SASH GUIDES - In Order by Length

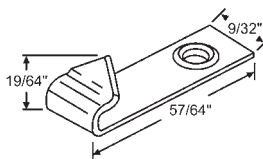

60-518

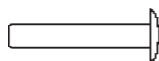

Part #	Description
60-514	3/32" Dia.
60-570	1/8" Dia., Heavy Duty 5/8" Length



20-183
Rivet and Drive Screw Assy. Used
when no rivet tool is available.

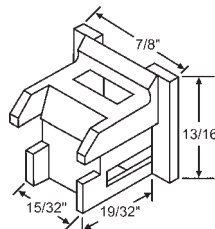

60-912
Black
CAPITOL

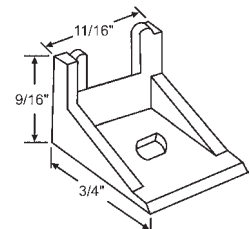

60-616
PAN AM

60 SERIES BALANCE ACCESSORIES

PLASTIC TOP SASH GUIDES - In Order by Length

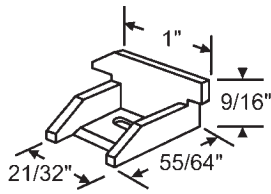

60-619
LH & RH Set
PAN AM

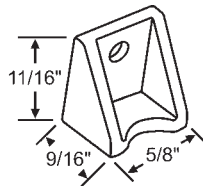

900-6912
White Nylon
HARCAR

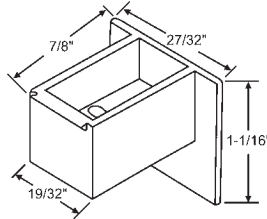

60-632
KING

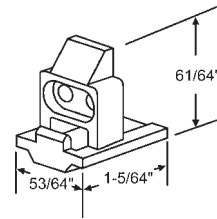

60-630
CAPITOL

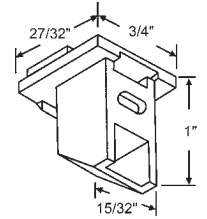

60-621

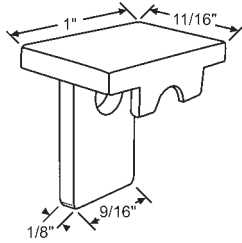

900-9500P
White Nylon
SECURITY

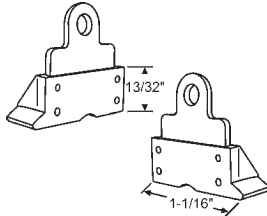

60-620
Pair
CROSSLY

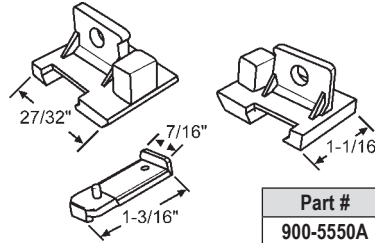

Part #	Color
900-5550A	Natural
900-5550BA	Black

Set
YALE OGRON

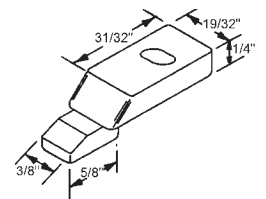

900-6758
Nylon Sash Guide

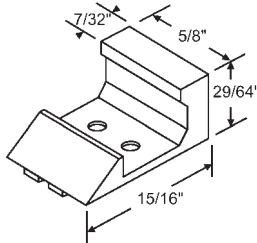

60-640
Nylon
GENERAL ALUMINUM/PAN AM

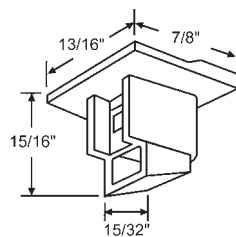

60-600
PENNCO

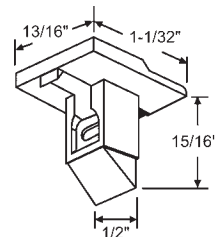

60-601
PENNCO

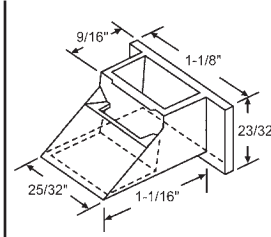

60-629

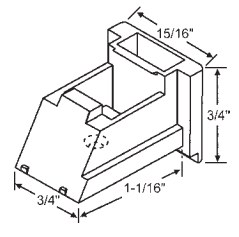

900-14149BA
Black LH & RH Set
BINNINGS

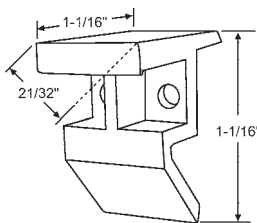

60-672
White
CAPITOL

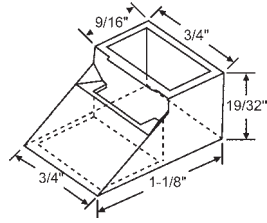

60-643

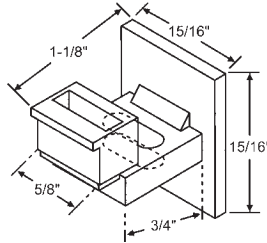

900-18946
Black

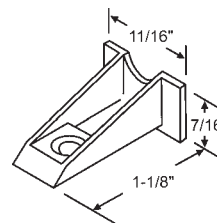

900-10150
Nylon Sash Guide
LOOK

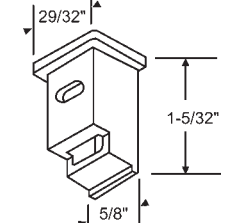

60-733
Black
GALLATIN/GAPCO

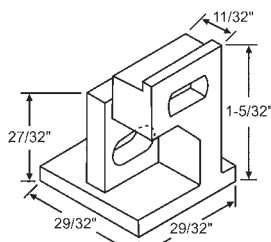

900-6799A
White LH & RH Set
GAPCO

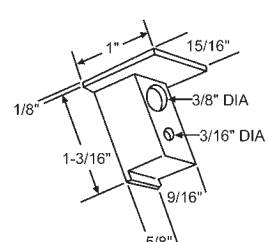

60-727
Black
ALENCO

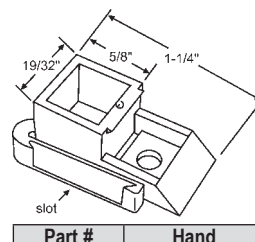

Part #	Hand
60-605	Shown
60-606	Opposite

Weatherstripping not included.
IDA

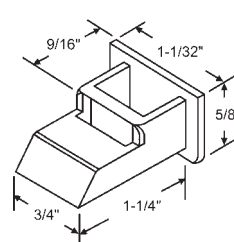

60-645

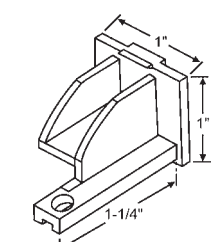

60-676BA
Black LH & RH Set

SASH SUPPORT SYSTEMS

60 SERIES BALANCE ACCESSORIES

PLASTIC TOP SASH GUIDES - In Order by Length

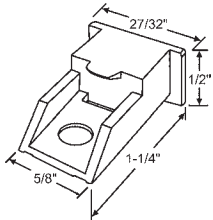

900-20578
White Nylon
LAWSON

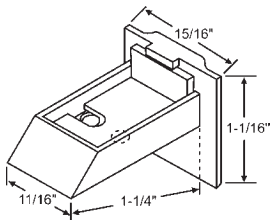

900-15838X
Black Plastic
JORDAN

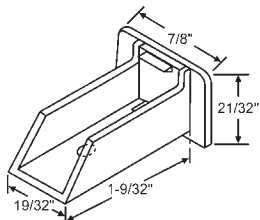

60-658
JORDAN

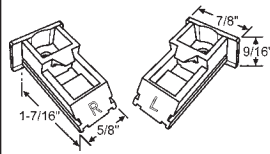

900-20576NS-SET
White LH & RH Set
LAWSON

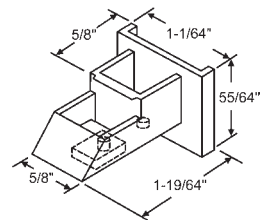

60-651A
LH & RH Set
SUGAR CREEK

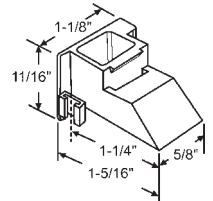

900-9963
LH & RH Set

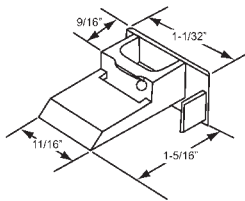

60-732A
Nylon. Sold In Sets Only.
NU-AIRE

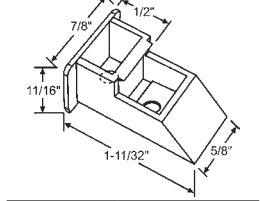

Part #	Color
60-602	White
60-602B	Black

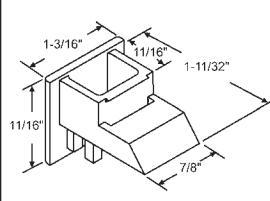

900-13531A
Black LH & RH Set
MANNIX

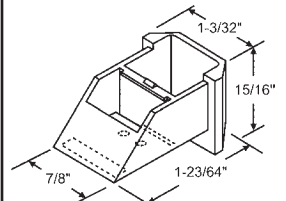

60-661
Black

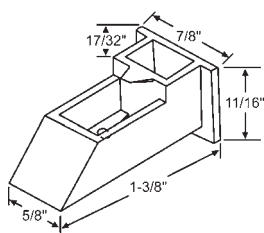

900-10066
KINCO

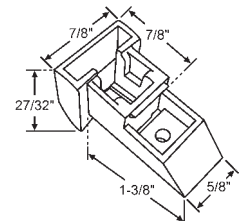

Part #	Color
60-935	White
60-935B	Black

LAWSON

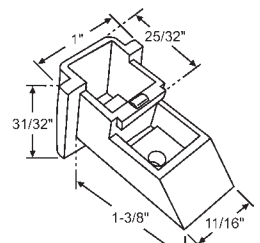

900-10331
Black
MILLER

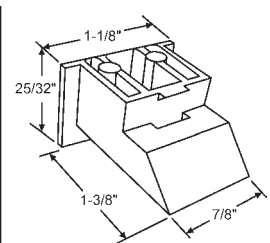

60-958
Black Nylon

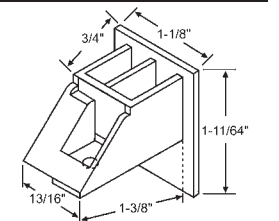

Part #	Hand	Color
900-13071LH	Shown	Black
900-13071RH	Opposite	Black
900-13071LW	Shown	White
900-13071RW	Opposite	White

Nylon
EFCO

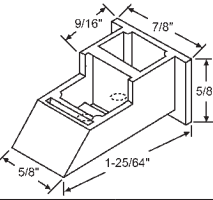

Part #	Color
60-6004	White
60-6004BG	Beige

VBP / GENERAL ALUMINUM
/ BETTER BILT

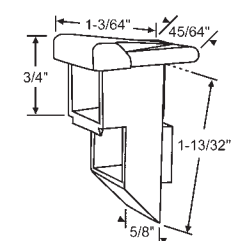

60-624
White
GRAHAM

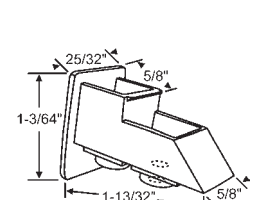

60-653
CROSSLY

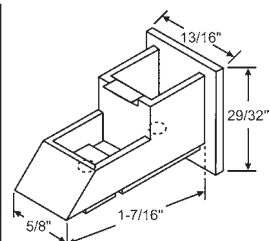

900-13061
Black

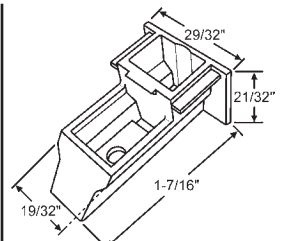

60-993
Black
METAL INDUSTRIES

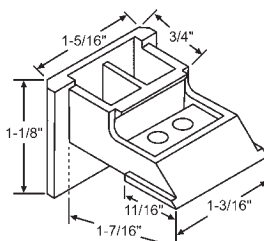

900-15768
Black

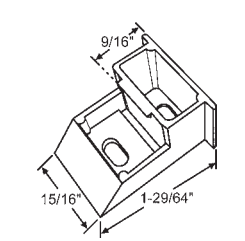

60-963
Natural

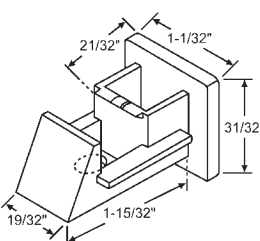

60-641
BINNINGS

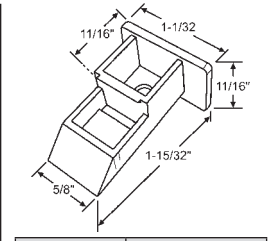

Part #	Color
60-957	Black
60-957W	White

LH & RH Set
YALE OGRON

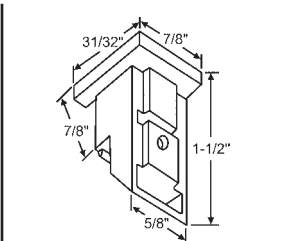

900-1852
3/16" dia. hole. Hole center up
17/32" from bottom.

60 SERIES BALANCE ACCESSORIES

PLASTIC TOP SASH GUIDES - In Order by Length

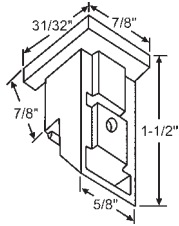

60-612

Hole center up 9/16" from bottom.

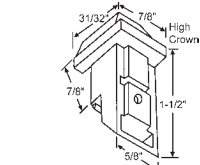

Part #	Color
60-613	Natural
60-613B	Black

Hole center up 9/16" from bottom.
CROSSLY

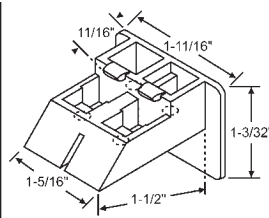

900-19798

White

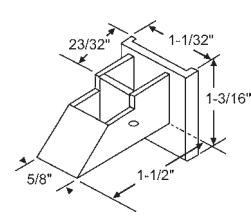

60-652A

LH & RH Set

ALSCO/ANACONDA

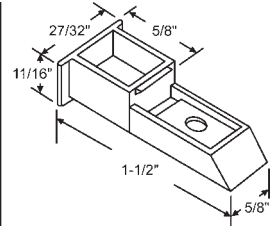

60-618

White

SEASONALL

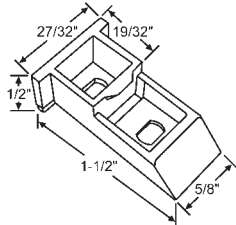

900-10122

Natural

KINCO

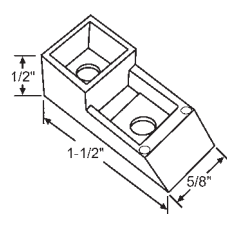

900-10122-OS

Nylon

KINCO

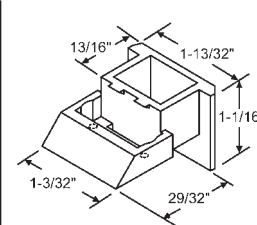

60-646

Black

BINNINGS

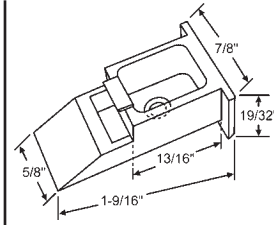

Part #	Color
900-16080	Black
900-16080W	White

HARCAR

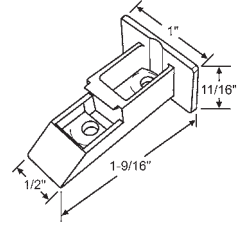

Part #	Color
60-971	White
60-971B	Black

Nylon

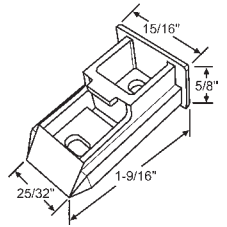

Part #	Color
60-633	Natural
60-633B	Black

PGT 4000 SERIES

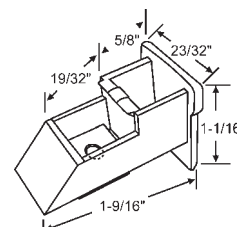

60-604

HOWMET

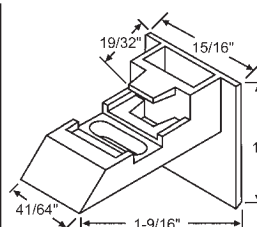

60-675

White

ROLLYSON

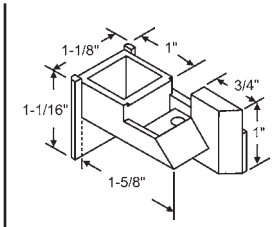

60-666

Black LH & RH Set

MANNIX

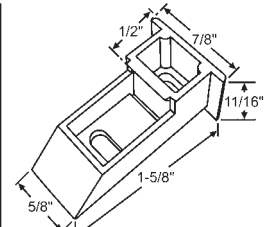

900-1855

White Nylon

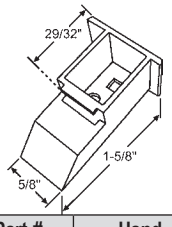

Part #	Hand
60-964LH	Shown
60-964RH	Opposite

White

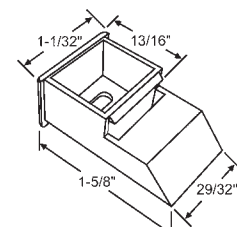

900-8990

White

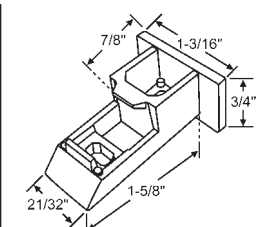

60-962

White

LAWSON

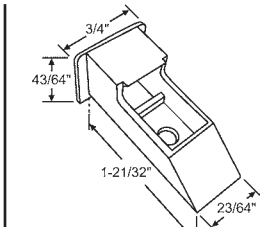

900-20577

Nylon

SEASONSHIELD

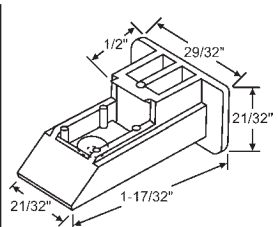

900-11075

White

BELLVIEW

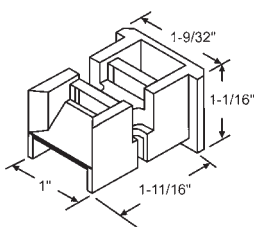

60-648

Black

KAWNEER/WIDING

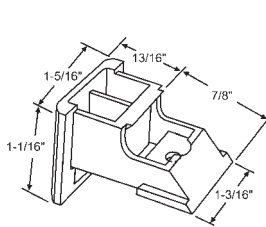

900-15744

Black

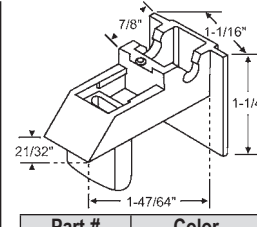

Part #	Color
60-657WH	White
60-657BL	Black
60-657BG	Beige
60-657BR	Brown

FIBERLUX

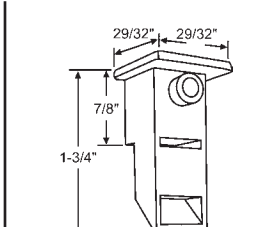

60-622

REYNOLDS

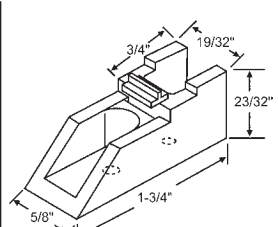

60-647

White

MILCO

SASH SUPPORT SYSTEMS

60 SERIES BALANCE ACCESSORIES

PLASTIC TOP SASH GUIDES - In Order by Length

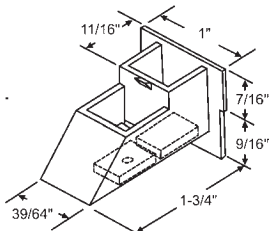

60-659
White
KING

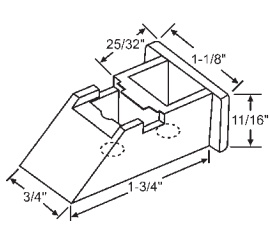

60-642

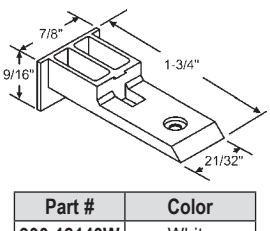

Part #	Color
900-18140W	White
900-18140B	Black

NORANDEX

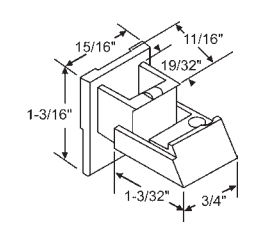

900-1884A
Black LH & RH Set
MANNIX

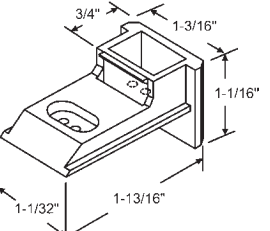

60-644
Black
STORM WEATHER

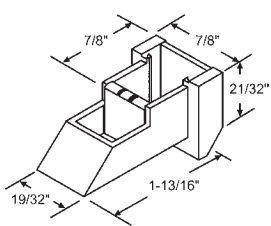

Old Style
No Longer Available
Use 60-654

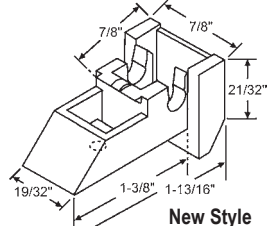

60-654
Old Style No Longer Available
SEASONALL

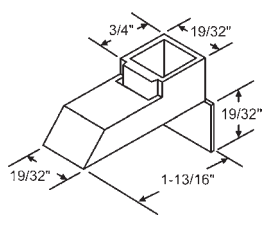

60-656
Black
HOWARD

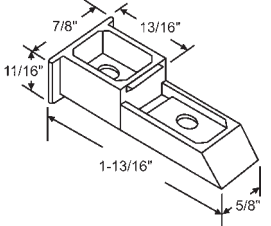

60-617
White

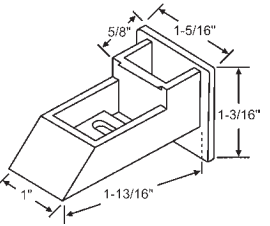

900-14664
SEASONALL

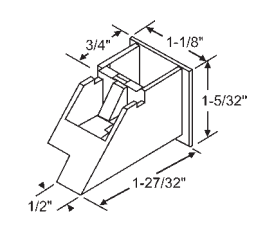

60-649A
Black LH & RH Set
PECO

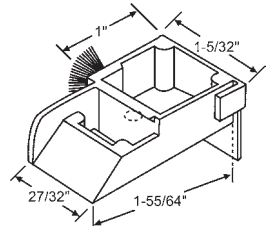

900-16514A
Black LH & RH Set w/Weatherstrip
ALENCO

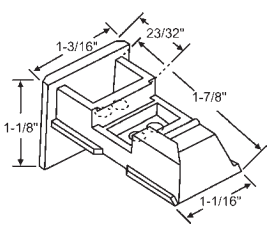

900-15743BA
Black LH & RH Set

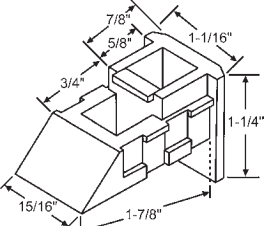

60-660
Black

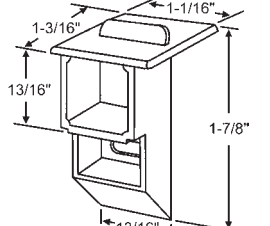

900-15745
Black Sash Guide

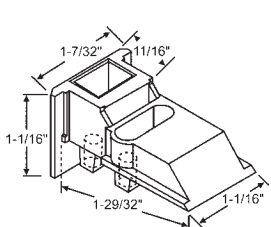

900-15755BA
Black LH & RH Set
STORM WEATHER

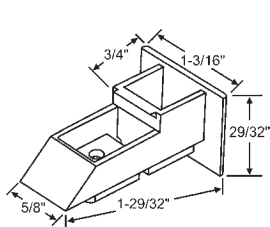

900-11106
Black

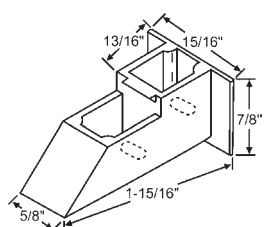

900-16814
Black

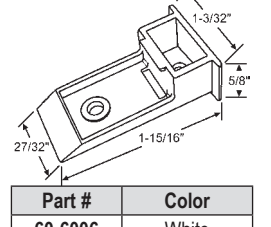

Part #	Color
60-6006	White
60-6006B	Black

Plastic
IWC

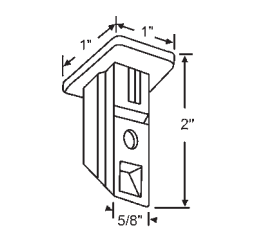

60-582
White
SEASONALL

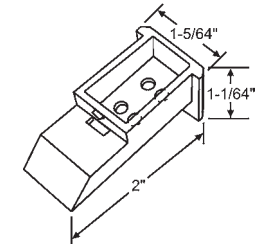

Part #	Color
60-942W	White
60-942	Black

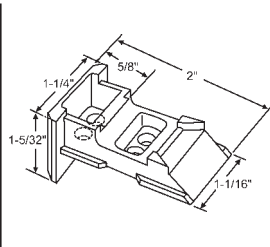

60-941
Black
TRACO

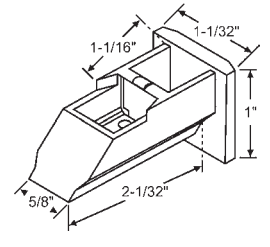

900-15245
White (Original Color Gray)
AMACOR

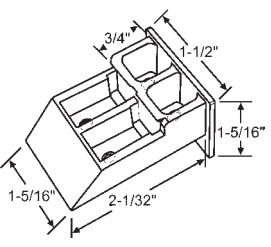

900-12814
Black

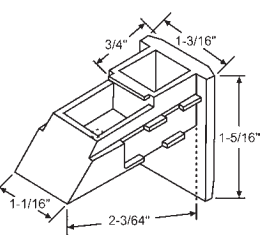

60-650
Black

60 SERIES BALANCE ACCESSORIES

PLASTIC TOP SASH GUIDES - In Order by Length

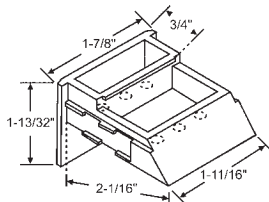

900-15441B
Black

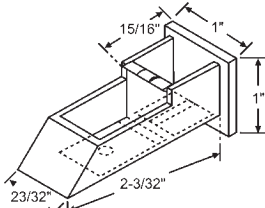

900-10067
Nylon Sash Guide

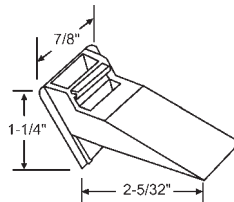

60-610
Black
ACORN

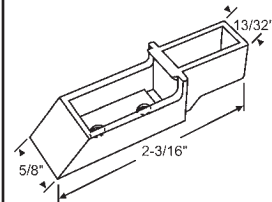

60-668
ALPINE

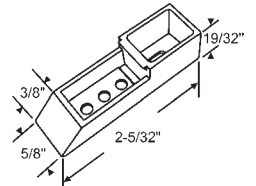

Part #	Color
60-603	White
60-603B	Black

CLEARVIEW

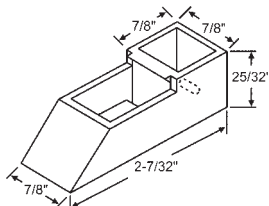

900-14356
White

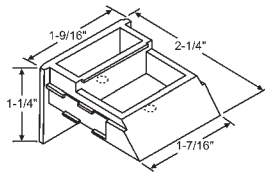

900-1882B
Black
GRAHAM

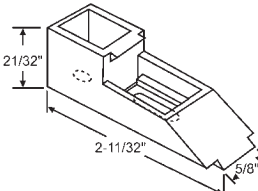

60-623
Natural

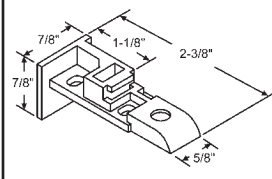

60-684A
White RH & LH Set. RH Shown

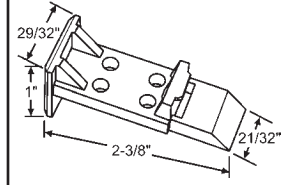

Part #	Color
60-970W	White
60-970B	Black

60-970W
60-970B

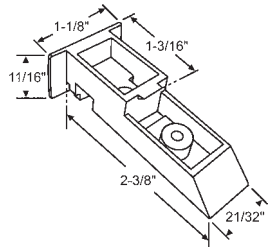

60-5008
White
SILVER LINE

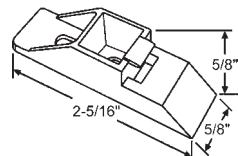

60-968W
JORDAN

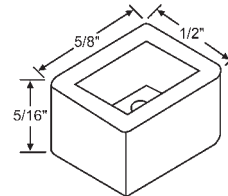

900-13360
Black Face Guide
SWS

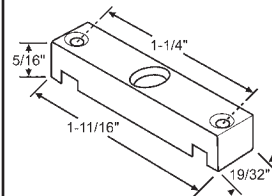

900-20266BL
Black Face Guide

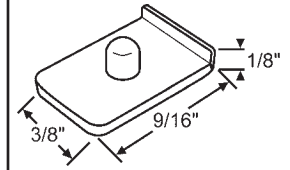

2732P
NU-AIR

FACE GUIDE

METAL SASH GUIDES

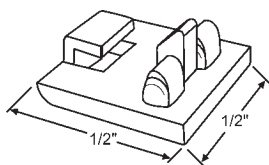

Part #	Color
900-19990	White
900-19990B	Black

Nylon Face Guide

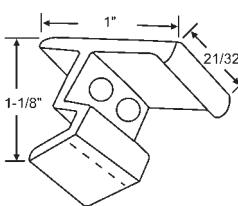

900-14964-A

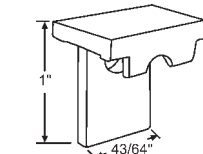

Part #	Color
900-9500AW	White
900-9500AB	Bronze
900-9500AL	Aluminum

Aluminum
SECURITY

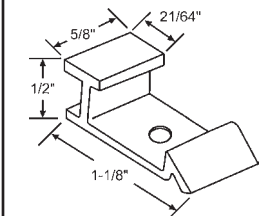

60-609
HOWARD

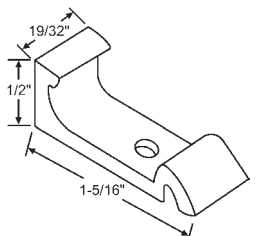

60-611

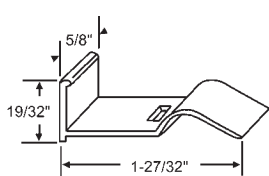

60-663
CAPITOL

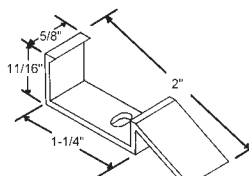

900-10396

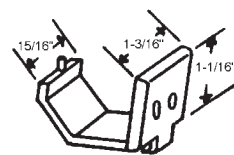

900-9250
Bronze
CAPITOL

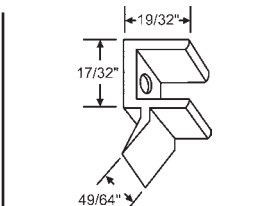

60-608
CAPITOL

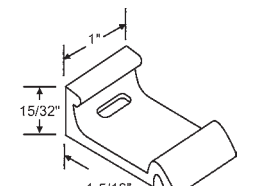

60-665
CROSSLY

SASH SUPPORT SYSTEMS

60 SERIES BALANCE ACCESSORIES

SASH STOPS

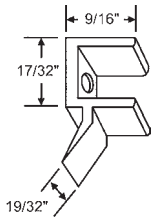

60-607
CAPITOL

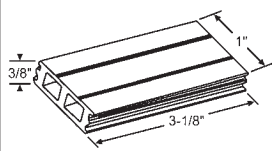

60-705
White Rubber
CAPITOL

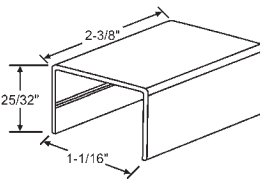

60-6009W
White
PGT

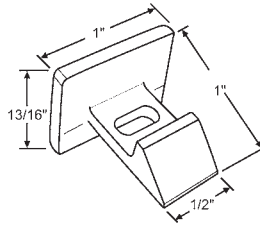

60-721
Plastic

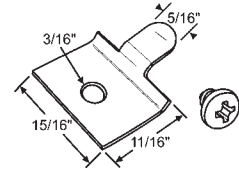

900-16788
YALE OGRON

TAKE OUT CLIPS

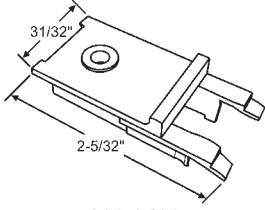

900-9400
Black
ACORN

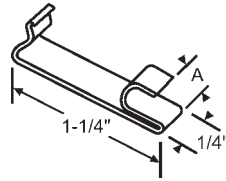

Part #	Description
60-700	A=1/4"
60-708	A=5/16"

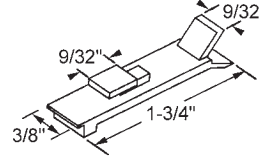

60-662
Plastic
PAN AM

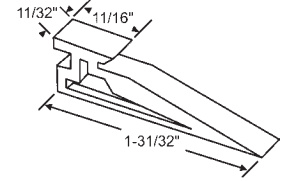

60-701
Frame Guide
IDA

60 SERIES MISCELLANEOUS

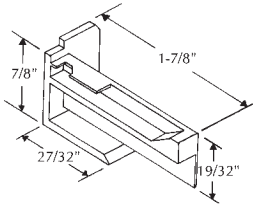

900-14926WA
White LH & RH Anti-Draft
Plug Set.
SEASONALL

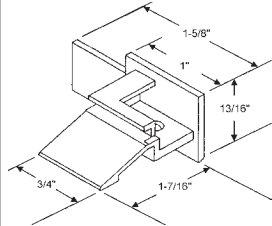

60-673
White Vent Clip Sash
Guides - Pair
ROLLYSON

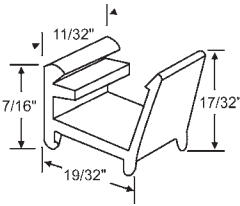

60-515
Extender

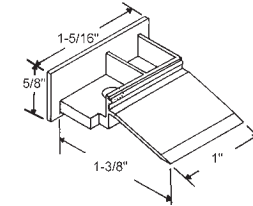

60-674BA
Black Vent Clips - Pair
ROLLYSON

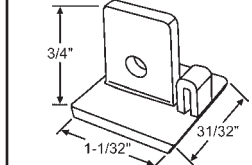

Part #	Color
60-664	White
60-664B	Black

Nylon Vent Bracket.
YALE OGRON

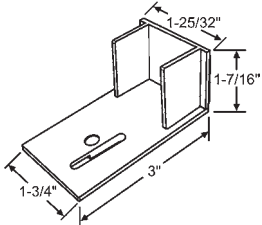

Part #	Hand
60-687RB	Shown
60-687LB	Opposite

Dust Cap. Black

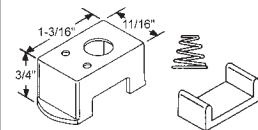

60-906
3 Piece Balance Guide Assembly
LOUISIANA PACIFIC

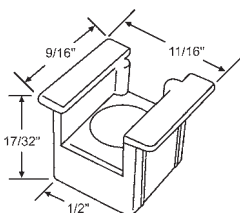

60-614
Square Guide
WT INDUSTRIES

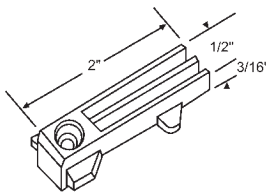

900-9401
Bottom Sash Cam
ACORN 3500 SERIES

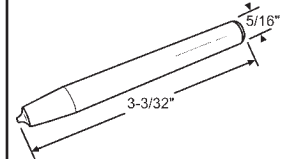

59-81
Rivet Installation Tool

WINDOW BALANCE RIVET TOOLS

For Channel and Tube Balances "A Must for Repair and Assembly of Balance Brackets" (Tube & Channel)
Professional Results! Say Good-bye to Hammered Fingers! **FAST - EFFICIENT - COST EFFECTIVE**

RIVET CRIMPING PLIERS

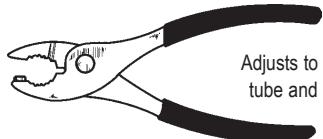

59-1
Adjusts to accommodate both
tube and channel balances.

RIVET REMOVAL PLIERS

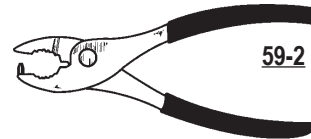
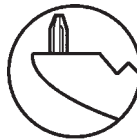

59-2

For tube balances, simply line up pin with peened rivet and squeeze. Rivet will be pushed out. For channel balances, grind or file rivet flush and then squeeze to remove rivet.



59-3
Replacement pin for
rivet removal pliers

The Invisible Balance has been used for over 25 years, primarily for wood windows. They are an excellent choice for historic window renovations, eliminating exposed hardware and maintaining the original window appearance. This product is the favorite of the custom millwork industry when jambliner aesthetics are not acceptable.

ORDERING INFORMATION:

- 1) Measure metal channel length.
- 2) Check number stamped on channel. (e.g. 101 or 101A or 101AX etc.)
- 3) Select our corresponding part numbers from the chart on following page and order accordingly.
- 4) Additional cord lengths are available: for 10" add "A" after part number, 5" add "B" and 8" add "C". Contact your account manager for other variations.

NOTE: If you have any unusual number/letter variations that are not shown in the chart, please consult your representative to be sure that your order will be filled correctly.

NOTE: With the 60A and 60AX series take out system, the sash balance becomes part of the sash. Therefore, when calculating sash weights, you must add the physical balance weight to the sash weights.

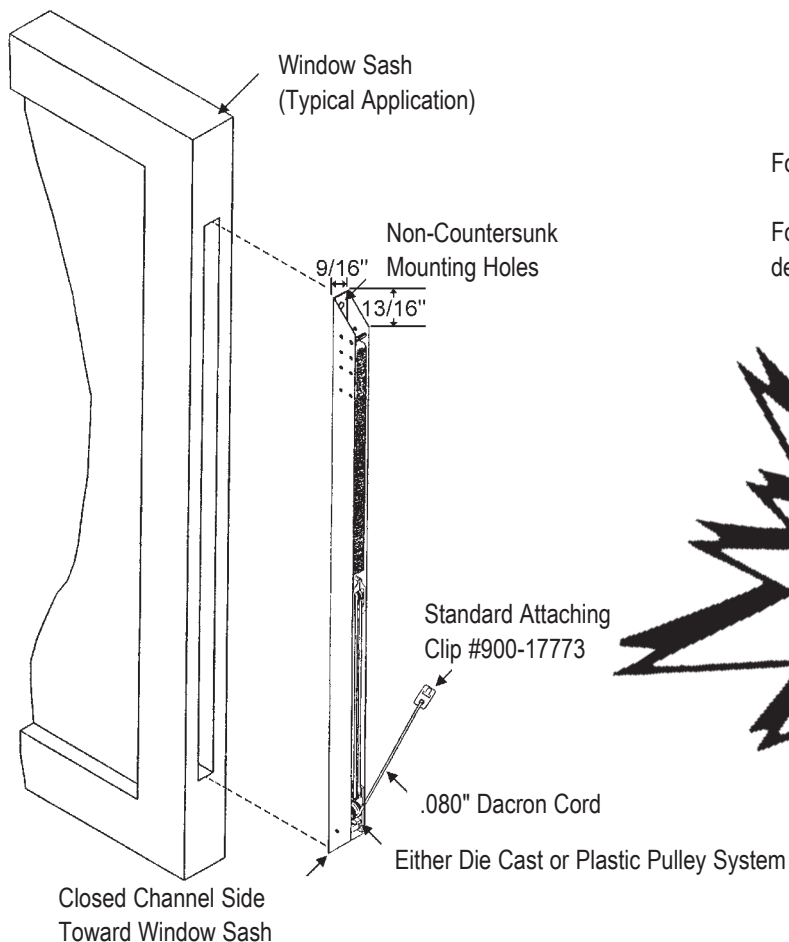

For "A" type balance make plough in sash 5/8" wide X 1" deep.

For "AX" type balance make plough in sash 5/8" wide X 1-1/8" deep to accommodate double spring.

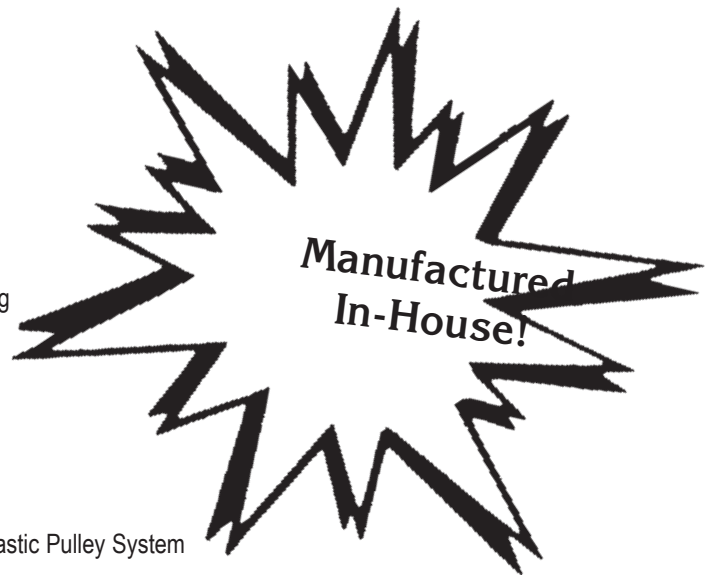

Refer to chart on following page.

SERIES A/AX BALANCE INSTALLATION

- Both "A" and "AX" balances are designed to counterbalance certain weights, regardless of the thickness of the sash. Do not overload.
- For odd height glass use the next smaller balance.
- When ploughing for over 36" glass height start at bottom of each sash, as always, and make groove the same length as you do for 36" glass leaving extra wood at top of stiles.

SASH SUPPORT SYSTEMS

60A AND 60AX SERIES - THE INVISIBLE BALANCE

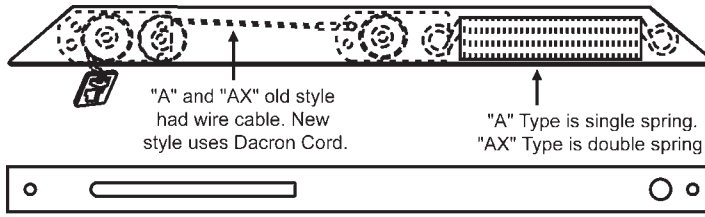
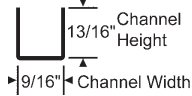

Old style is slotted;
new style is not.



Bottom View

End Brackets

Attaching Clip

Example Ordering Chart

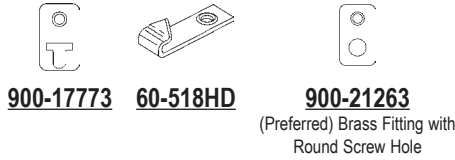

900-17773

60-518HD

900-21263

(Preferred) Brass Fitting with
Round Screw Hole

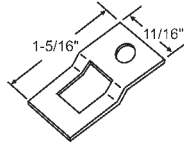

60-704M

Length of Metal Channel	Number Stamped on Balance	Our Part Number	End Bracket	Cord Length	Complete Part Number
13-1/2"	101	60-A101	Standard	Standard	60-A101
13-1/2"	101	60-A101	1	Standard	60-A101-1
13-1/2"	101	60-A101	10	Standard	60-A101-10
13-1/2"	101	60-A101	10	+ 10"	60-A101-10A
13-1/2"	101	60-A101	10	+ 5"	60-A101-10B
13-1/2"	101	60-A101	10	+ 8"	60-A101-10C

Standard

-1

-10

"A" TYPE (Single Spring)

Glass Height	Length of Metal Channel	Balance Number	Sash Weight Per Pair	Standard Cord Length	Our Part Number
12"	13-1/2"	101	5-7 lbs.	31"	60-A101
12"	13-1/2"	102	7-11 lbs.	31"	60-A102
14"	15-1/2"	111	5-8 lbs.	33"	60-A111
14"	15-1/2"	112	8-11 lbs.	33"	60-A112
16"	17-1/2"	121	5-9 lbs.	35"	60-A121
16"	17-1/2"	122	9-12 lbs.	35"	60-A122
18"	19-1/2"	131	5-9 lbs.	37"	60-A131
18"	19-1/2"	132	9-13 lbs.	37"	60-A132
20"	21-1/2"	141	5-9 lbs.	39"	60-A141
20"	21-1/2"	142	9-12 lbs.	39"	60-A142
20"	21-1/2"	143	12-14 lbs.	39"	60-A143
22"	23-1/2"	151	6-10 lbs.	41"	60-A151
22"	23-1/2"	152	10-12 lbs.	41"	60-A152
22"	23-1/2"	153	12-15 lbs.	41"	60-A153
24"	25-1/2"	161	6-10 lbs.	43"	60-A161
24"	25-1/2"	162	10-14 lbs.	43"	60-A162
24"	25-1/2"	163	14-18 lbs.	43"	60-A163
26"	27-1/2"	171	6-10 lbs.	45"	60-A171
26"	27-1/2"	172	10-14 lbs.	45"	60-A172
26"	27-1/2"	173	14-18 lbs.	45"	60-A173
28"	29-1/2"	181	7-12 lbs.	47"	60-A181
28"	29-1/2"	182	12-16 lbs.	47"	60-A182
28"	29-1/2"	183	16-20 lbs.	47"	60-A183
30"	31-1/2"	191	7-12 lbs.	49"	60-A191
30"	31-1/2"	192	12-16 lbs.	49"	60-A192
30"	31-1/2"	193	16-20 lbs.	49"	60-A193
32"	33-1/2"	201	8-14 lbs.	51"	60-A201
32"	33-1/2"	202	14-18 lbs.	51"	60-A202
32"	33-1/2"	203	18-22 lbs.	51"	60-A203
34"	35-1/2"	211	8-14 lbs.	53"	60-A211
34"	35-1/2"	212	14-18 lbs.	53"	60-A212
34"	35-1/2"	213	18-22 lbs.	53"	60-A213
36"	37-1/2"	221	8-15 lbs.	53"	60-A221
36"	37-1/2"	222	15-20 lbs.	55"	60-A222
36"	37-1/2"	223	20-24 lbs.	55"	60-A223
38"	37-1/2"	231	8-15 lbs.	57"	60-A231
38"	37-1/2"	232	15-20 lbs.	57"	60-A232
38"	37-1/2"	233	20-24 lbs.	57"	60-A233
40"	37-1/2"	241	8-15 lbs.	59"	60-A241
40"	37-1/2"	242	15-20 lbs.	59"	60-A242
40"	37-1/2"	243	20-24 lbs.	59"	60-A243
42"	37-1/2"	251	8-15 lbs.	61"	60-A251
42"	37-1/2"	252	15-20 lbs.	61"	60-A252
42"	37-1/2"	253	20-24 lbs.	61"	60-A253

NOTE: Whenever you add cord length to standard length you reduce the sash weight capacity and forfeit the warranty.

NOTE: Numbers stamped on balances may be the same -single spring designated by "A" -double spring designated by "AX".

NOTE: When determining sash weight, you need to include the weight of the balances. (e.g. Sash weighs 20 lbs. (2) balances weigh 3 lbs. Total sash weight is 23 lbs.)

"AX" TYPE (Double Spring)

Glass Height	Length of Metal Channel	Balance Number	Sash Weight Per Pair	Standard Cord Length	Our Part Number
12"	13-1/2"	101AX	11-16 lbs.	31"	60-AX101
12"	13-1/2"	102AX	16-24 lbs.	31"	60-AX102
14"	15-1/2"	111AX	11-16 lbs.	33"	60-AX111
14"	15-1/2"	112AX	16-25 lbs.	33"	60-AX112
16"	17-1/2"	121AX	12-19 lbs.	35"	60-AX121
16"	17-1/2"	122AX	19-26 lbs.	35"	60-AX122
18"	19-1/2"	131AX	13-19 lbs.	37"	60-AX131
18"	19-1/2"	132AX	19-26 lbs.	37"	60-AX132
20"	21-1/2"	141AX	14-20 lbs.	39"	60-AX141
20"	21-1/2"	142AX	20-26 lbs.	39"	60-AX142
20"	21-1/2"	143AX	26-30 lbs.	39"	60-AX143
22"	23-1/2"	151AX	15-20 lbs.	41"	60-AX151
22"	23-1/2"	152AX	20-26 lbs.	41"	60-AX152
22"	23-1/2"	153AX	26-32 lbs.	41"	60-AX153
24"	25-1/2"	161AX	18-23 lbs.	43"	60-AX161
24"	25-1/2"	162AX	23-28 lbs.	43"	60-AX162
24"	25-1/2"	163AX	28-34 lbs.	43"	60-AX163
24"	25-1/2"	164AX	34-38 lbs.	43"	60-AX164
26"	27-1/2"	171AX	18-23 lbs.	45"	60-AX171
26"	27-1/2"	172AX	23-28 lbs.	45"	60-AX172
26"	27-1/2"	173AX	28-34 lbs.	45"	60-AX173
26"	27-1/2"	174AX	34-38 lbs.	45"	60-AX174
28"	29-1/2"	181AX	20-25 lbs.	47"	60-AX181
28"	29-1/2"	182AX	25-32 lbs.	47"	60-AX182
28"	29-1/2"	183AX	32-38 lbs.	47"	60-AX183
28"	29-1/2"	184AX	38-42 lbs.	47"	60-AX184
30"	31-1/2"	191AX	20-25 lbs.	49"	60-AX191
30"	31-1/2"	192AX	25-32 lbs.	49"	60-AX192
30"	31-1/2"	193AX	32-38 lbs.	49"	60-AX193
30"	31-1/2"	194AX	38-42 lbs.	49"	60-AX194
32"	33-1/2"	201AX	22-28 lbs.	51"	60-AX201
32"	33-1/2"	202AX	28-34 lbs.	51"	60-AX202
32"	33-1/2"	203AX	34-40 lbs.	51"	60-AX203
32"	33-1/2"	204AX	40-44 lbs.	51"	60-AX204
34"	35-1/2"	211AX	22-28 lbs.	53"	60-AX211
34"	35-1/2"	212AX	28-34 lbs.	53"	60-AX212
34"	35-1/2"	213AX	34-40 lbs.	53"	60-AX213
34"	35-1/2"	214AX	40-44 lbs.	53"	60-AX214
36"	37-1/2"	221AX	24-30 lbs.	55"	60-AX221
36"	37-1/2"	222AX	30-36 lbs.	55"	60-AX222
36"	37-1/2"	223AX	36-42 lbs.	55"	60-AX223
36"	37-1/2"	224AX	42-48 lbs.	55"	60-AX224
38"	37-1/2"	231AX	24-30 lbs.	57"	60-AX231
38"	37-1/2"	232AX	30-36 lbs.	57"	60-AX232
38"	37-1/2"	233AX	36-42 lbs.	57"	60-AX233
38"	37-1/2"	234AX	42-48 lbs.	57"	60-AX234
40"	37-1/2"	241AX	24-30 lbs.	59"	60-AX241
40"	37-1/2"	242AX	30-36 lbs.	59"	60-AX242
40"	37-1/2"	243AX	36-42 lbs.	59"	60-AX243
40"	37-1/2"	244AX	42-48 lbs.	59"	60-AX244
42"	37-1/2"	251AX	24-30 lbs.	61"	60-AX251
42"	37-1/2"	252AX	30-36 lbs.	61"	60-AX252
42"	37-1/2"	253AX	36-42 lbs.	61"	60-AX253
42"	37-1/2"	254AX	42-48 lbs.	61"	60-AX254

60P SERIES 1/2" CHANNEL BALANCE (PEACHTREE -ARIEL NON-TILT)

ACTUALLY 5/8" BUT CONSIDERED 1/2" IN THE TRADE

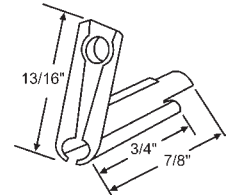
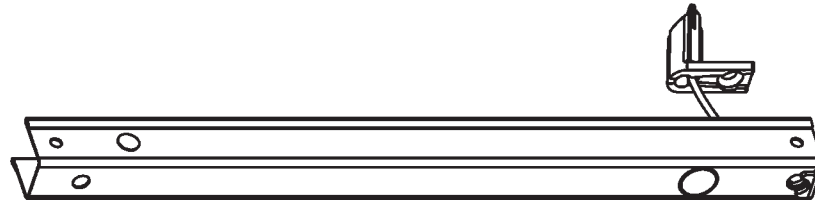
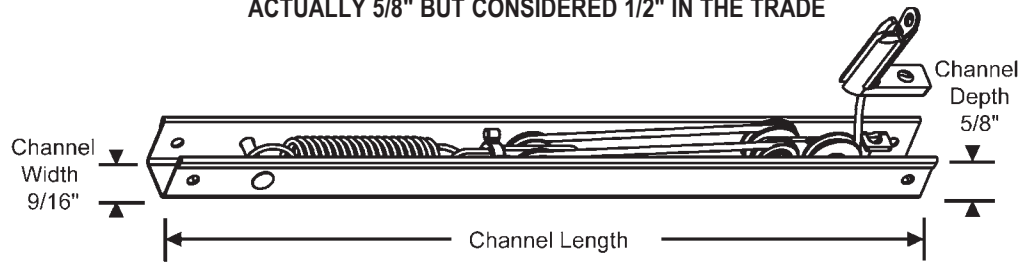

Ordering Information

- 1) Measure metal channel length.
- 2) Identify number stamped on channel.
- 3) Select our corresponding part number from the chart below.

Note: Balances measuring 29-1/4" long are no longer manufactured. We recommend using the 32-1/4" balance. See chart below for weight ranges and select corresponding part number.

60P-500

Black
Balance Terminal Plug
PEACHTREE

Peachtree Window Size	Our Part Number	Length of Metal Channel	Number Stamped on Balance	Weight Capacity
D2436	60P-134	14-1/4"	13-1/4 - 4	10 to 12
D2440	60P-154	16-1/4"	15-1/4 - 4	11 to 13
D2448	60P-194	20-1/4"	19-1/4 - 4	13 to 17
D2454	60P-223	23-1/4"	22-1/4 - 3	13 to 19
D2460	60P-253	26-1/4"	25-1/4 - 3	16 to 19
D2472	60P-313	32-1/4"	31-1/4 - 3	17 to 23
D3036	60P-134	14-1/4"	13-1/4 - 4	10 to 12
D3040	60P-154	16-1/4"	15-1/4 - 4	11 to 13
D3048	60P-194	20-1/4"	19-1/4 - 4	13 to 17
D3054	60P-223	23-1/4"	22-1/4 - 3	13 to 19
D3060	60P-253	26-1/4"	25-1/4 - 3	16 to 19
D3072	60P-314	32-1/4"	31-1/4 - 4	24 to 28
D3636	60P-135	14-1/4"	13-1/4 - 5	13 to 17
D3640	60P-155	16-1/4"	15-1/4 - 5	14 to 17
D3648	60P-194	20-1/4"	19-1/4 - 4	13 to 17
D3654	60P-224	23-1/4"	22-1/4 - 4	20 to 23
D3660	60P-254	26-1/4"	25-1/4 - 4	20 to 25
D3672	60P-314	32-1/4"	31-1/4 - 4	24 to 28
D4236	60P-135	14-1/4"	13-1/4 - 5	13 to 17
D4240	60P-156	16-1/4"	15-1/4 - 6	18 to 22
D4248	60P-196	20-1/4"	19-1/4 - 6	22 to 26
D4248	60P-199	20-1/4"	19-1/4 - 9	27 to 30
D4254	60P-224	23-1/4"	22-1/4 - 4	20 to 23
D4254	60P-229	23-1/4"	22-1/4 - 9	28 to 30
D4260	60P-254	26-1/4"	25-1/4 - 4	20 to 25
D4260	60P-255	26-1/4"	25-1/4 - 5	26 to 31
D4272	60P-315	32-1/4"	31-1/4 - 5	29 to 32
D4272	60P-316	32-1/4"	31-1/4 - 6	33 to 35
D4272	60P-319	32-1/4"	31-1/4 - 9	36 to 38

Actual size is 1" more than stamp on balances.

SASH SUPPORT SYSTEMS

60G SERIES CHANNEL BALANCE (HURD MILWORK / THERMAL WINDOWS)



Bottom bracket not sold separately. Bottom bracket contains a roller.

INSTRUCTIONS

1. Measure metal channel length (do not include plastic ends, metal channel only)
2. Check number stamped on balance (e.g.: 24-1, 36-3, etc.)
3. Select our corresponding part number from chart below
4. Select your ends and clip combination from the list and add suffix to end of part number you choose from chart.

***Note:** When ordering balances where the number stamped on balance ends with DS (example 21DS) you need to specify the exact sash weight within the range listed on the chart.

Ordering Example: Number stamped on balance is 21DS, exact sash weight is 34 lbs. and the end clip combination is -1, you would then order part number 60G-21DS34

Example Ordering Chart

Length of Metal Channel	Number Stamped on Balance	Our Part Number	End Clip Combination	Complete Part Number
24-5/8"	24-3	60G-243	-1	60G-243-1

Length of Metal Channel	Number Stamped on Balance	Sash Weight	Our Part Number	Length of Metal Channel	Number Stamped on Balance	Sash Weight	Our Part Number	Length of Metal Channel	Number Stamped on Balance	Sash Weight	Our Part Number
12-5/8"	12-1	3-6	60G-121	16-5/8"	16-5	18-22	60G-165	21-5/8"	21-3	11-14	60G-213
12-5/8"	12-2	6-9	60G-122	16-5/8"	16-9	22-26	60G-169	21-5/8"	21-4	14-22	60G-214
12-5/8"	12-3	9-11	60G-123	16-5/8"	16DS*	27-35	60G-16DS*	21-5/8"	21-5	22-25	60G-215
12-5/8"	12-4	11-12	60G-124	17-5/8"	17-1	4-7	60G-171	21-5/8"	21-9	25-30	60G-219
12-5/8"	12-5	12-15	60G-125	17-5/8"	17-2	7-11	60G-172	21-5/8"	21DS*	31-40	60G-21DS*
12-5/8"	12-6	15-18	60G-126	17-5/8"	17-3	11-13	60G-173	22-5/8"	22-1	4-7	60G-221
12-5/8"	12-9	18-21	60G-129	17-5/8"	17-4	13-15	60G-174	22-5/8"	22-2	7-11	60G-222
12-5/8"	12DS*	22-30	60G-12DS*	17-5/8"	17-5	15-19	60G-175	22-5/8"	22-3	11-18	60G-223
13-5/8"	13-1	3-6	60G-131	17-5/8"	17-9	19-26	60G-179	22-5/8"	22-4	18-22	60G-224
13-5/8"	13-2	6-9	60G-132	17-5/8"	17DS*	27-35	60G-17DS*	22-5/8"	22-5	22-26	60G-225
13-5/8"	13-3	9-11	60G-133	18-5/8"	18-1	4-7	60G-181	22-5/8"	22-9	26-30	60G-229
13-5/8"	13-4	11-12	60G-134	18-5/8"	18-2	7-11	60G-182	22-5/8"	22DS*	31-40	60G-22DS*
13-5/8"	13-5	12-16	60G-135	18-5/8"	18-3	11-13	60G-183	23-5/8"	23-1	4-8	60G-231
13-5/8"	13-6	16-19	60G-136	18-5/8"	18-4	13-16	60G-184	23-5/8"	23-2	8-14	60G-232
13-5/8"	13-9	16-22	60G-139	18-5/8"	18-5	16-23	60G-185	23-5/8"	23-3	14-17	60G-233
13-5/8"	13DS*	22-35	60G-13DS*	18-5/8"	18-6	23-26	60G-186	23-5/8"	23-4	17-21	60G-234
14-5/8"	14-1	4-6	60G-141	18-5/8"	18-9	26-29	60G-189	23-5/8"	23-5	21-26	60G-235
14-5/8"	14-2	6-9	60G-142	18-5/8"	18DS*	30-35	60G-18DS*	23-5/8"	23-9	26-30	60G-239
14-5/8"	14-3	9-11	60G-143	19-5/8"	19-1	4-7	60G-191	23-5/8"	23DS*	31-40	60G-23DS*
14-5/8"	14-4	11-12	60G-144	19-5/8"	19-2	7-11	60G-192	24-5/8"	24-1	4-8	60G-241
14-5/8"	14-5	12-17	60G-145	19-5/8"	19-3	11-15	60G-193	24-5/8"	24-2	8-14	60G-242
14-5/8"	14-6	17-22	60G-146	19-5/8"	19-4	15-16	60G-194	24-5/8"	24-3	14-18	60G-243
14-5/8"	14-9	22-25	60G-149	19-5/8"	19-5	16-20	60G-195	24-5/8"	24-4	18-23	60G-244
14-5/8"	14DS*	26-35	60G-14DS*	19-5/8"	19-6	20-25	60G-196	24-5/8"	24-5	23-29	60G-245
15-5/8"	15-1	4-6	60G-151	19-5/8"	19-9	25-29	60G-199	24-5/8"	24-9	29-34	60G-249
15-5/8"	15-2	6-8	60G-152	19-5/8"	19DS*	30-40	60G-19DS*	24-5/8"	24DS*	35-45	60G-24DS*
15-5/8"	15-3	8-11	60G-153	20-5/8"	20-1	4-7	60G-201	25-5/8"	25-1	4-8	60G-251
15-5/8"	15-4	11-12	60G-154	20-5/8"	20-2	7-11	60G-202	25-5/8"	25-2	8-14	60G-252
15-5/8"	15-5	12-16	60G-155	20-5/8"	20-3	11-14	60G-203	24-5/8"	24-9	29-34	60G-249
15-5/8"	15-6	16-21	60G-156	20-5/8"	20-4	14-22	60G-204	24-5/8"	24DS*	35-45	60G-24DS*
15-5/8"	15-9	21-23	60G-159	20-5/8"	20-5	22-25	60G-205	25-5/8"	25-1	4-8	60G-251
15-5/8"	15DS*	24-35	60G-15DS*	20-5/8"	20-6	25-28	60G-206	25-5/8"	25-2	8-14	60G-252
16-5/8"	16-1	4-7	60G-161	20-5/8"	20-9	28-31	60G-209	25-5/8"	25-3	14-18	60G-253
16-5/8"	16-2	7-11	60G-162	20-5/8"	20DS*	31-40	60G-20DS*	25-5/8"	25-4	18-24	60G-254
16-5/8"	16-3	11-13	60G-163	21-5/8"	21-1	4-7	60G-211	25-5/8"	25-5	24-30	60G-255
16-5/8"	16-4	13-18	60G-164	21-5/8"	21-2	7-11	60G-212	25-5/8"	25-9	30-34	60G-259

Continued on next page

SASH SUPPORT SYSTEMS

60G SERIES ENDS & CLIP COMBINATIONS

**Suffix
-1**

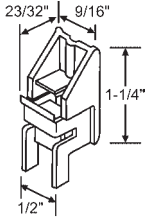

60-507
Top

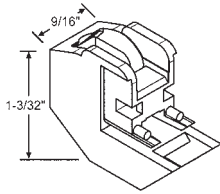

60-940
Bottom

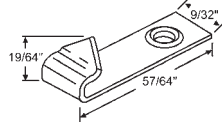

60-518

**Suffix
-1Q**

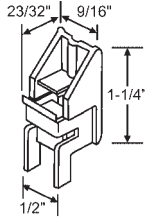

60-507
Top

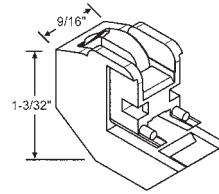

60-940
Bottom

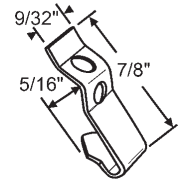

60-807

**Suffix
-1R**

No Longer Available.
Use Suffix -1T

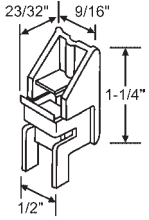

60-507
Top

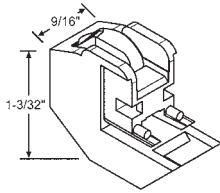

60-940
Bottom

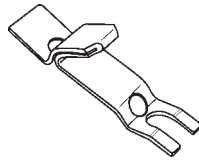

60-808

No Longer Available

**Suffix
-1T**

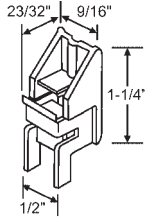

60-507
Top

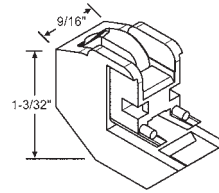

60-940
Bottom

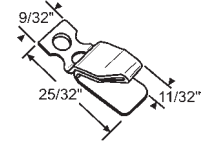

62-50022

**Suffix
-2**

No Longer Available.
Use Suffix -7

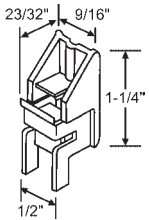

60-507
Top

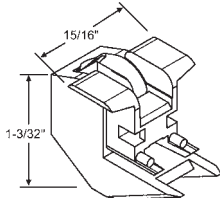

60-939

No Longer Available

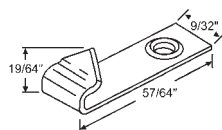

60-518

**Suffix
-2Q**

No Longer Available.
Use Suffix -7Q

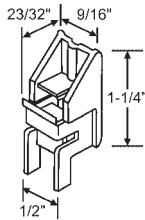

60-507
Top

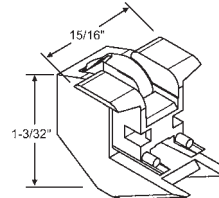

60-939

No Longer Available

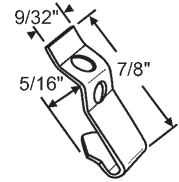

60-807

**Suffix
-2R**

No Longer Available.
Use Suffix -7T

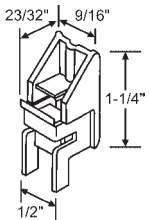

60-507
Top

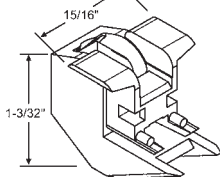

60-939

No Longer Available

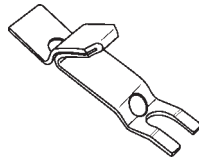

60-808

No Longer Available

**Suffix
-2T**

No Longer Available.
Use Suffix -7T

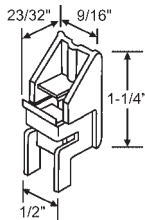

60-507
Top

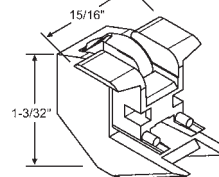

60-939

No Longer Available

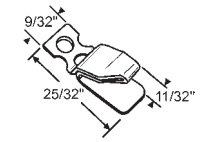

62-50022

**Suffix
-3**

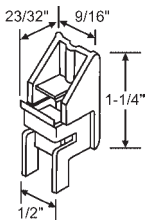

60-507
Top

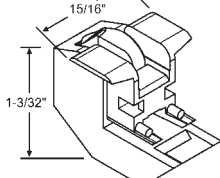

60-938
Bottom

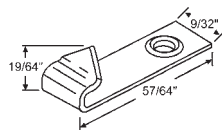

60-518

**Suffix
-3Q**

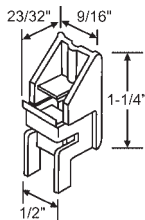

60-507
Top

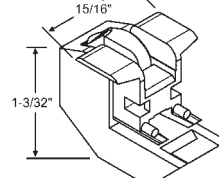

60-938
Bottom

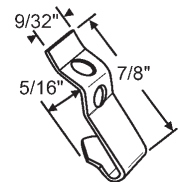

60-807

60G SERIES ENDS & CLIP COMBINATIONS

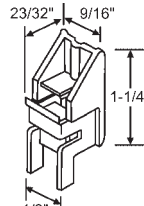
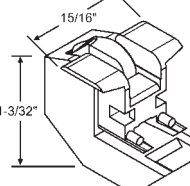
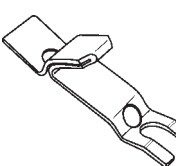
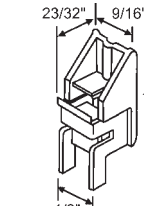
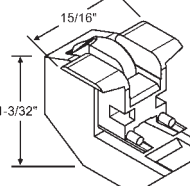
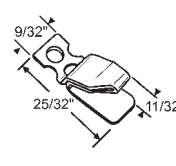
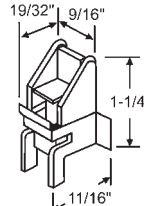
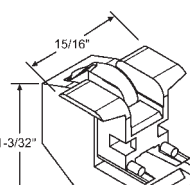
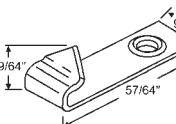
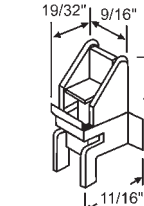
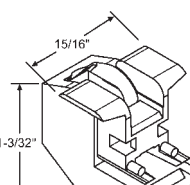
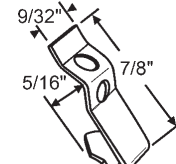
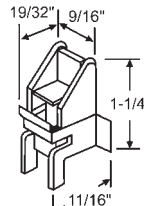
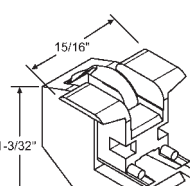
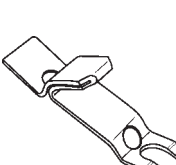
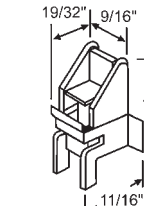
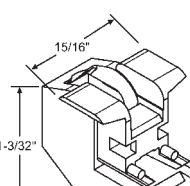
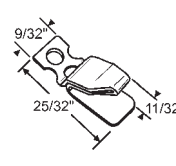
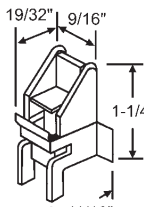
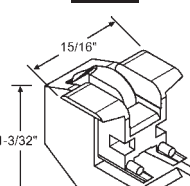
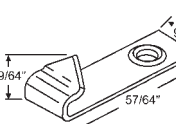
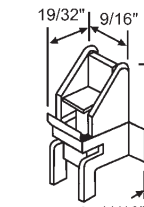
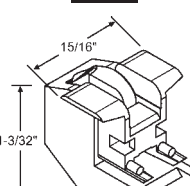
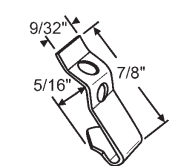
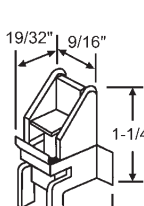
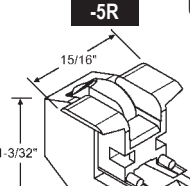
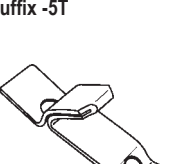
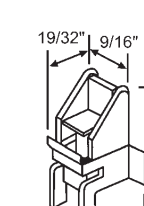
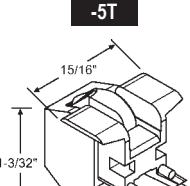
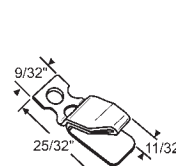
<p>Suffix -3R No Longer Available. Use Suffix -3T</p>  <p>60-507 Top</p>	 <p>60-938 Bottom</p>	 <p>60-808 No Longer Available</p>	 <p>60-507 Top</p>	 <p>60-938 Bottom</p>	 <p>62-50022</p>
<p>Suffix -4 No Longer Available. Use Suffix -8</p>  <p>60-508 Top</p>	 <p>60-939 No Longer Available</p>	 <p>60-518</p>	 <p>60-508 Top</p>	 <p>60-939 No Longer Available</p>	 <p>60-807</p>
<p>Suffix -4R No Longer Available. Use Suffix -8T</p>  <p>60-508 Top</p>	 <p>60-939 No Longer Available</p>	 <p>60-808 No Longer Available</p>	 <p>60-508 Top</p>	 <p>60-939 No Longer Available</p>	 <p>62-50022</p>
<p>Suffix -5</p>  <p>60-508 Top</p>	 <p>60-938 Bottom</p>	 <p>60-518</p>	 <p>60-508 Top</p>	 <p>60-938 Bottom</p>	 <p>60-807</p>
<p>Suffix -5R No Longer Available. Use Suffix -5T</p>  <p>60-508 Top</p>	 <p>60-938 Bottom</p>	 <p>60-808 No Longer Available</p>	 <p>60-508 Top</p>	 <p>60-938 Bottom</p>	 <p>62-50022</p>

SASH SUPPORT SYSTEMS

60G SERIES ENDS & CLIP COMBINATIONS

**Suffix
-6**

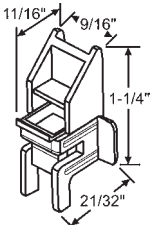

60-997
Top

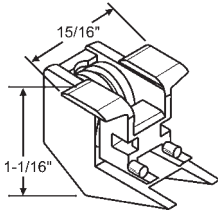

60-999

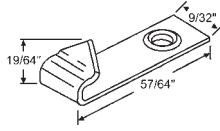

60-518

**Suffix
-6Q**

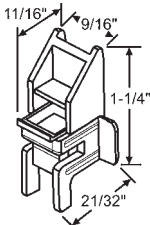

60-997

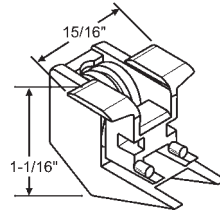

60-999

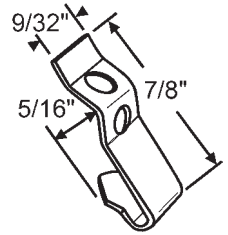

60-807

**Suffix
-6T**

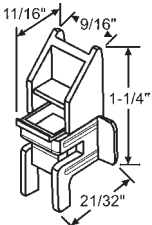

60-997

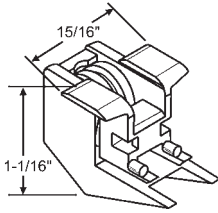

60-999

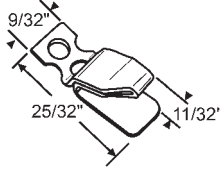

62-50022

**Suffix
-7**

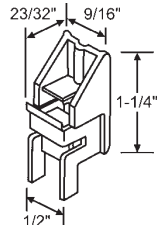

60-507

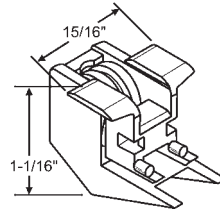

60-999

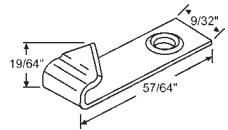

60-518

**Suffix
-7Q**

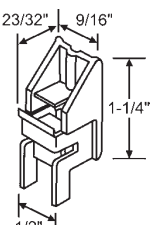

60-507

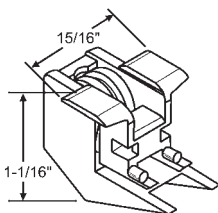

60-999

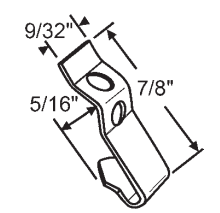

60-807

**Suffix
-7T**

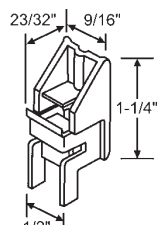

60-507

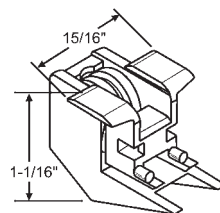

60-999

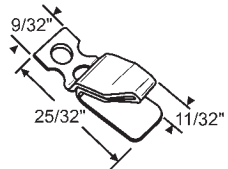

62-50022

**Suffix
-8**

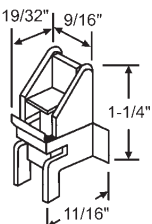

60-508
Top

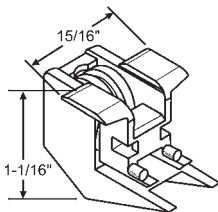

60-999

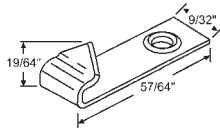

60-518

**Suffix
-8Q**

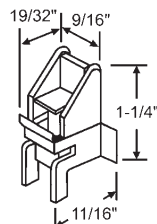

60-508

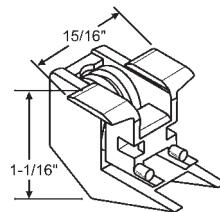

60-999

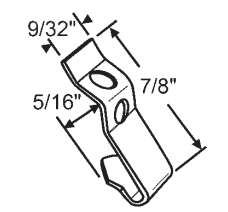

60-807

**Suffix
-8T**

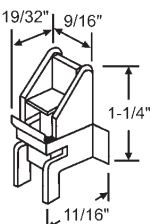

60-508
Top

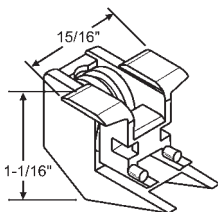

60-999

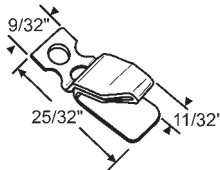

62-50022

601 SERIES NON-TILT CHANNEL BALANCE

RIVETLESS

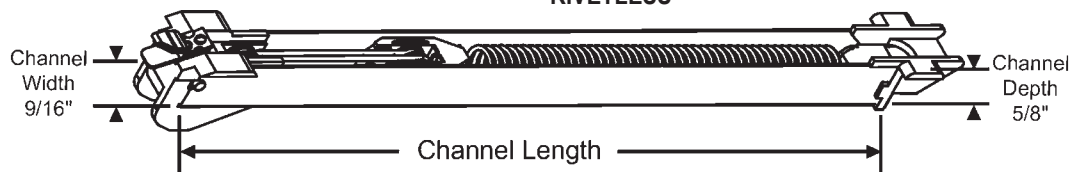

Bottom bracket contains a roller. Top and bottom bracket not sold separately.

INSTRUCTIONS

1. Measure metal channel length (do not include plastic ends, metal channel only)
2. Check number stamped on balance (e.g.: 1210, 1840, etc.)
3. Select our corresponding part number from chart below
4. Select your ends and clip combination from the list and add suffix to end of part number you choose from chart.

Ordering Example: Length of Balance is 20-7/8", number stamped on balance is 2040, and the end clip combination is -1, you would then order part number 60I-204-1

Example Ordering Chart

Length of Metal Channel	Number Stamped on Balance	Our Part Number	End Clip Combination	Complete Part Number
20-7/8"	2040	60I-204	-1	60I-204-1

Length of Metal Channel	Number Stamped on Balance	Weight Range	Our Part Number	Length of Metal Channel	Number Stamped on Balance	Weight Range	Our Part Number	Length of Metal Channel	Number Stamped on Balance	Weight Range	Our Part Number
12-7/8"	1210	2 - 6	60I-121	18-7/8"	1840	14 - 17	60I-184	23-7/8"	2330	15 - 18	60I-233
12-7/8"	1220	6 - 9	60I-122	18-7/8"	1850	17 - 20	60I-185	23-7/8"	2340	18 - 23	60I-234
12-7/8"	1230	9 - 11	60I-123	18-7/8"	1860	20 - 23	60I-186	23-7/8"	2350	23 - 27	60I-235
12-7/8"	1240	11 - 12	60I-124	18-7/8"	1865	23 - 25	60I-186	23-7/8"	2360	27 - 30	60I-236
12-7/8"	1250	12 - 15	60I-125	18-7/8"	1870	25 - 29	60I-187	23-7/8"	2365	30 - 34	60I-2365
12-7/8"	1260	15 - 18	60I-126	18-7/8"	1875	29 - 32	60I-1875	23-7/8"	2370	34 - 37	60I-237
13-7/8"	1310	2 - 6	60I-131	18-7/8"	1880	32 - 35	60I-188	23-7/8"	2375	37 - 40	60I-2375
13-7/8"	1320	6 - 9	60I-132	19-7/8"	1910	2 - 8	60I-191	24-7/8"	2410	2 - 9	60I-241
13-7/8"	1330	9 - 11	60I-133	19-7/8"	1920	8 - 12	60I-192	24-7/8"	2420	9 - 15	60I-242
13-7/8"	1340	11 - 12	60I-134	19-7/8"	1930	12 - 14	60I-193	24-7/8"	2430	15 - 19	60I-243
13-7/8"	1350	12 - 15	60I-135	19-7/8"	1940	14 - 17	60I-194	24-7/8"	2440	19 - 24	60I-244
13-7/8"	1360	15 - 18	60I-136	19-7/8"	1950	17 - 21	60I-195	24-7/8"	2450	24 - 27	60I-245
13-7/8"	1365	18 - 20	60I-1365	19-7/8"	1960	21 - 24	60I-196	24-7/8"	2460	27 - 30	60I-246
14-7/8"	1410	2 - 6	60I-141	19-7/8"	1965	24 - 27	60I-1965	24-7/8"	2465	30 - 33	60I-2465
14-7/8"	1420	6 - 10	60I-142	19-7/8"	1970	27 - 30	60I-197	24-7/8"	2470	33 - 36	60I-247
14-7/8"	1430	10 - 12	60I-143	19-7/8"	1975	30 - 34	60I-1975	24-7/8"	2475	36 - 39	60I-2475
14-7/8"	1440	12 - 13	60I-144	19-7/8"	1980	34 - 37	60I-198	24-7/8"	2480	39 - 42	60I-248
14-7/8"	1450	13 - 17	60I-145	19-7/8"	1985	37 - 40	60I-1985	24-7/8"	2485	42 - 45	60I-2485
14-7/8"	1460	17 - 20	60I-146	20-7/8"	2010	2 - 8	60I-201	25-7/8"	2510	2 - 9	60I-251
14-7/8"	1465	20 - 23	60I-1465	20-7/8"	2020	8 - 12	60I-202	25-7/8"	2520	9 - 15	60I-252
15-7/8"	1510	2 - 6	60I-151	20-7/8"	2030	12 - 15	60I-203	25-7/8"	2530	15 - 19	60I-253
15-7/8"	1520	6 - 10	60I-152	20-7/8"	2040	15 - 23	60I-204	25-7/8"	2540	19 - 25	60I-254
15-7/8"	1530	10 - 12	60I-153	20-7/8"	2050	23 - 27	60I-205	25-7/8"	2550	25 - 28	60I-255
15-7/8"	1540	12 - 13	60I-154	20-7/8"	2060	27 - 30	60I-206	25-7/8"	2560	28 - 30	60I-256
15-7/8"	1550	13 - 17	60I-155	20-7/8"	2065	30 - 34	60I-2065	25-7/8"	2565	30 - 33	60I-2565
15-7/8"	1560	17 - 20	60I-156	20-7/8"	2070	34 - 37	60I-207	25-7/8"	2570	33 - 36	60I-257
15-7/8"	1565	20 - 23	60I-1565	20-7/8"	2075	37 - 40	60I-2075	25-7/8"	2575	36 - 39	60I-2575
15-7/8"	1570	23 - 26	60I-157	21-7/8"	2110	2 - 8	60I-211	25-7/8"	2580	39 - 42	60I-258
16-7/8"	1610	2 - 8	60I-161	21-7/8"	2120	8 - 12	60I-212	25-7/8"	2585	42 - 45	60I-2585
16-7/8"	1620	8 - 12	60I-162	21-7/8"	2130	12 - 15	60I-213	26-7/8"	2610	2 - 9	60I-261
16-7/8"	1630	12 - 14	60I-163	21-7/8"	2140	15 - 23	60I-214	26-7/8"	2620	9 - 13	60I-262
16-7/8"	1640	14 - 19	60I-164	21-7/8"	2150	23 - 27	60I-215	26-7/8"	2630	13 - 19	60I-263
16-7/8"	1650	19 - 22	60I-165	21-7/8"	2160	27 - 30	60I-216	26-7/8"	2640	19 - 26	60I-264
16-7/8"	1660	22 - 25	60I-166	21-7/8"	2165	30 - 34	60I-2165	26-7/8"	2650	26 - 30	60I-265
16-7/8"	1665	25 - 29	60I-1665	21-7/8"	2170	34 - 37	60I-217	26-7/8"	2660	30 - 33	60I-266
17-7/8"	1710	2 - 8	60I-171	21-7/8"	2175	37 - 40	60I-2175	26-7/8"	2665	33 - 36	60I-2665
17-7/8"	1720	8 - 12	60I-172	22-7/8"	2210	2 - 8	60I-221	26-7/8"	2670	36 - 39	60I-267
17-7/8"	1730	12 - 14	60I-173	22-7/8"	2220	8 - 12	60I-222	26-7/8"	2675	39 - 42	60I-2675
17-7/8"	1740	14 - 17	60I-174	22-7/8"	2230	12 - 19	60I-223	26-7/8"	2680	42 - 45	60I-268
17-7/8"	1750	17 - 20	60I-175	22-7/8"	2240	19 - 23	60I-224	27-7/8"	2710	2 - 9	60I-271
17-7/8"	1760	20 - 23	60I-176	22-7/8"	2250	23 - 27	60I-225	27-7/8"	2720	9 - 13	60I-272
17-7/8"	1765	23 - 25	60I-1765	22-7/8"	2260	27 - 30	60I-226	27-7/8"	2730	13 - 19	60I-273
17-7/8"	1770	25 - 29	60I-177	22-7/8"	2265	30 - 34	60I-2265	27-7/8"	2740	19 - 26	60I-274
17-7/8"	1775	29 - 32	60I-1775	22-7/8"	2270	34 - 37	60I-227	27-7/8"	2750	26 - 30	60I-275
18-7/8"	1810	2 - 8	60I-181	22-7/8"	2275	37 - 40	60I-2275	27-7/8"	2760	30 - 33	60I-276
18-7/8"	1820	8 - 12	60I-182	23-7/8"	2310	2 - 9	60I-231	27-7/8"	2765	33 - 36	60I-2765
18-7/8"	1830	12 - 14	60I-183	23-7/8"	2320	9 - 15	60I-232	27-7/8"	2770	36 - 39	60I-277

Continued on next page

Continued from previous page.

Length of Metal Channel	Number Stamped on Balance	Weight Range	Our Part Number	Length of Metal Channel	Number Stamped on Balance	Weight Range	Our Part Number	Length of Metal Channel	Number Stamped on Balance	Weight Range	Our Part Number
27-7/8"	2775	39 - 42	601-2775	34-7-8"	3465	39 - 42	601-3465	41-7/8"	4160	35 - 39	601-4160
27-7/8"	2780	42 - 45	601-2780	34-7-8"	3470	42 - 45	601-3470	41-7/8"	4165	39 - 42	601-4165
28-7/8"	2810	3 - 12	601-2810	35-7/8"	3510	3 - 13	601-3510	41-7/8"	4170	42 - 45	601-4170
28-7/8"	2820	12 - 16	601-2820	35-7/8"	3520	13 - 18	601-3520	42-7/8"	4210	4 - 14	601-4210
28-7/8"	2830	16 - 23	601-2830	35-7/8"	3530	18 - 23	601-3530	42-7/8"	4220	14 - 19	601-4220
28-7/8"	2840	23 - 28	601-2840	35-7/8"	3540	23 - 30	601-3540	42-7/8"	4230	19 - 24	601-4230
28-7/8"	2850	28 - 32	601-2850	35-7/8"	3550	30 - 35	601-3550	42-7/8"	4240	24 - 30	601-4240
28-7/8"	2860	32 - 35	601-2860	35-7/8"	3560	35 - 39	601-3560	42-7/8"	4250	30 - 35	601-4250
28-7/8"	2865	35 - 39	601-2865	35-7/8"	3565	39 - 42	601-3565	42-7/8"	4260	35 - 39	601-4260
28-7/8"	2870	39 - 42	601-2870	35-7/8"	3570	42 - 45	601-3570	42-7/8"	4265	39 - 42	601-4265
28-7/8"	2875	42 - 45	601-2875	36-7/8"	3610	3 - 13	601-3610	42-7/8"	4270	42 - 45	601-4270
29-7/8"	2910	3 - 12	601-2910	36-7/8"	3620	13 - 18	601-3620	43-7/8"	4310	4 - 14	601-4310
29-7/8"	2920	12 - 16	601-2920	36-7/8"	3630	18 - 23	601-3630	43-7/8"	4320	14 - 19	601-4320
29-7/8"	2930	16 - 23	601-2930	36-7/8"	3640	23 - 30	601-3640	43-7/8"	4330	19 - 24	601-4330
29-7/8"	2940	23 - 28	601-2940	36-7/8"	3650	30 - 35	601-3650	43-7/8"	4340	24 - 30	601-4340
29-7/8"	2950	28 - 32	601-2950	36-7/8"	3660	35 - 39	601-3660	43-7/8"	4350	30 - 35	601-4350
29-7/8"	2960	32 - 35	601-2960	36-7/8"	3665	39 - 42	601-3665	43-7/8"	4360	35 - 39	601-4360
29-7/8"	2965	35 - 39	601-2965	36-7/8"	3670	42 - 45	601-3670	43-7/8"	4365	39 - 42	601-4365
29-7/8"	2970	39 - 42	601-2970	37-7/8"	3710	3 - 13	601-3710	43-7/8"	4370	42 - 45	601-4370
29-7/8"	2975	42 - 45	601-2975	37-7/8"	3720	13 - 18	601-3720	44-7/8"	4410	4 - 14	601-4410
30-7/8"	3010	3 - 12	601-3010	37-7/8"	3730	18 - 23	601-3730	44-7/8"	4420	14 - 19	601-4420
30-7/8"	3020	12 - 16	601-3020	37-7/8"	3740	23 - 30	601-3740	44-7/8"	4430	19 - 24	601-4430
30-7/8"	3030	16 - 23	601-3030	37-7/8"	3750	30 - 35	601-3750	44-7/8"	4440	24 - 30	601-4440
30-7/8"	3040	23 - 28	601-3040	37-7/8"	3760	35 - 39	601-3760	44-7/8"	4450	30 - 35	601-4450
30-7/8"	3050	28 - 32	601-3050	37-7/8"	3765	39 - 42	601-3765	44-7/8"	4460	35 - 39	601-4460
30-7/8"	3060	32 - 35	601-3060	37-7/8"	3770	42 - 45	601-3770	44-7/8"	4465	39 - 42	601-4465
30-7/8"	3065	35 - 39	601-3065	38-7/8"	3810	4 - 14	601-3810	44-7/8"	4470	42 - 45	601-4470
30-7/8"	3070	39 - 42	601-3070	38-7/8"	3820	14 - 19	601-3820	45-7/8"	4510	4 - 14	601-4510
30-7/8"	3075	42 - 45	601-3075	38-7/8"	3830	19 - 24	601-3830	45-7/8"	4520	14 - 19	601-4520
31-7/8"	3110	3 - 12	601-3110	38-7/8"	3840	24 - 30	601-3840	45-7/8"	4530	19 - 24	601-4530
31-7/8"	3120	12 - 16	601-3120	38-7/8"	3850	30 - 35	601-3850	45-7/8"	4540	24 - 30	601-4540
31-7/8"	3130	16 - 23	601-3130	38-7/8"	3860	35 - 39	601-3860	45-7/8"	4550	30 - 35	601-4550
31-7/8"	3140	23 - 28	601-3140	38-7/8"	3865	39 - 42	601-3865	45-7/8"	4560	35 - 39	601-4560
31-7/8"	3150	28 - 32	601-3150	38-7/8"	3870	42 - 45	601-3870	45-7/8"	4565	39 - 42	601-4565
31-7/8"	3160	32 - 35	601-3160	39-7/8"	3910	4 - 14	601-3910	45-7/8"	4570	42 - 45	601-4570
31-7/8"	3165	35 - 39	601-3165	39-7/8"	3920	14 - 19	601-3920	46-7/8"	4610	4 - 14	601-4610
31-7/8"	3170	39 - 42	601-3170	39-7/8"	3930	19 - 24	601-3930	46-7/8"	4620	14 - 19	601-4620
31-7/8"	3175	42 - 45	601-3175	39-7/8"	3940	24 - 30	601-3940	46-7/8"	4630	19 - 24	601-4630
32-7/8"	3210	3 - 13	601-3210	39-7/8"	3950	30 - 35	601-3950	46-7/8"	4640	24 - 30	601-4640
32-7/8"	3220	13 - 18	601-3220	39-7/8"	3960	35 - 39	601-3960	46-7/8"	4650	30 - 35	601-4650
32-7/8"	3230	18 - 23	601-3230	39-7/8"	3965	39 - 42	601-3965	46-7/8"	4660	35 - 39	601-4660
32-7/8"	3240	23 - 28	601-3240	39-7/8"	3970	42 - 45	601-3970	46-7/8"	4665	39 - 42	601-4665
32-7/8"	3250	28 - 32	601-3250	40-7/8"	4010	4 - 14	601-4010	46-7/8"	4670	42 - 45	601-4670
32-7/8"	3260	32 - 35	601-3260	40-7/8"	4020	14 - 19	601-4020	47-7/8"	4710	4 - 14	601-4710
32-7/8"	3265	35 - 39	601-3265	40-7/8"	4030	19 - 23	601-4030	47-7/8"	4720	14 - 19	601-4720
32-7/8"	3270	39 - 42	601-3270	40-7/8"	4040	23 - 30	601-4040	47-7/8"	4730	19 - 24	601-4730
32-7/8"	3275	42 - 45	601-3275	40-7/8"	4050	30 - 35	601-4050	47-7/8"	4740	24 - 30	601-4740
33-7/8"	3310	3 - 13	601-3310	40-7/8"	4060	35 - 39	601-4060	47-7/8"	4750	30 - 35	601-4750
33-7/8"	3320	13 - 18	601-3320	40-7/8"	4065	39 - 42	601-4065	47-7/8"	4760	35 - 39	601-4760
33-7/8"	3330	18 - 23	601-3330	40-7/8"	4070	42 - 45	601-4070	47-7/8"	4765	39 - 42	601-4765
33-7/8"	3340	23 - 28	601-3340	41-7/8"	4110	4 - 14	601-4110	47-7/8"	4770	42 - 45	601-4770
33-7/8"	3350	28 - 32	601-3350	41-7/8"	4120	14 - 19	601-4120	48-7/8"	4810	4 - 14	601-4810
33-7/8"	3360	32 - 35	601-3360	41-7/8"	4130	19 - 24	601-4130	48-7/8"	4820	14 - 19	601-4820
33-7/8"	3365	35 - 39	601-3365	41-7/8"	4140	24 - 30	601-4140	48-7/8"	4830	19 - 24	601-4830
33-7/8"	3370	39 - 42	601-3370	41-7/8"	4150	30 - 35	601-4150	48-7/8"	4840	24 - 30	601-4840
33-7/8"	3375	42 - 45	601-3375	41-7/8"	4160	35 - 39	601-4160	48-7/8"	4850	30 - 35	601-4850
34-7-8"	3410	3 - 13	601-3410	41-7/8"	4165	39 - 42	601-4165	48-7/8"	4860	35 - 39	601-4860
34-7-8"	3420	13 - 18	601-3420	41-7/8"	4170	42 - 45	601-4170	48-7/8"	4865	39 - 42	601-4865
34-7-8"	3430	18 - 23	601-3430	42-7/8"	4210	4 - 14	601-4210	48-7/8"	4870	42 - 45	601-4870
34-7-8"	3440	23 - 30	601-3440	42-7/8"	4220	14 - 19	601-4220	49-7/8"	4910	4 - 14	601-4910
34-7-8"	3450	30 - 34	601-3450	42-7/8"	4230	19 - 24	601-4230	49-7/8"	4920	14 - 19	601-4920
34-7-8"	3460	34 - 39	601-3460	42-7/8"	4240	24 - 30	601-4240	49-7/8"	4930	19 - 24	601-4930

Continued on next page

60I SERIES CHANNEL BALANCE

Continued from previous page.

Length of Metal Channel	Number Stamped on Balance	Weight Range	Our Part Number	Length of Metal Channel	Number Stamped on Balance	Weight Range	Our Part Number	Length of Metal Channel	Number Stamped on Balance	Weight Range	Our Part Number
49-7/8"	4940	24 - 30	60I-494	51-7/8"	5110	4 - 14	60I-5110	52-7/8"	5260	35 - 39	60I-5260
49-7/8"	4950	30 - 35	60I-495	51-7/8"	5120	14 - 19	60I-5120	52-7/8"	5265	39 - 42	60I-5265
49-7/8"	4960	35 - 39	60I-496	51-7/8"	5130	19 - 25	60I-5130	52-7/8"	5270	42 - 45	60I-5270
49-7/8"	4965	39 - 42	60I-4965	51-7/8"	5140	25 - 32	60I-5140	53-7/8"	5310	4 - 14	60I-5310
49-7/8"	4970	42 - 45	60I-497	51-7/8"	5150	32 - 35	60I-5150	53-7/8"	5320	14 - 19	60I-5320
50-7/8"	5010	4 - 14	60I-5010	51-7/8"	5160	35 - 39	60I-5160	53-7/8"	5330	19 - 25	60I-5330
50-7/8"	5020	14 - 19	60I-5020	51-7/8"	5165	39 - 42	60I-5165	53-7/8"	5340	25 - 32	60I-5340
50-7/8"	5030	19 - 25	60I-5030	51-7/8"	5170	42 - 45	60I-5170	53-7/8"	5350	32 - 35	60I-5350
50-7/8"	5040	25 - 32	60I-5040	52-7/8"	5210	4 - 14	60I-5210	53-7/8"	5360	35 - 39	60I-5360
50-7/8"	5050	32 - 35	60I-5050	52-7/8"	5220	14 - 19	60I-5220	53-7/8"	5365	39 - 42	60I-5365
50-7/8"	5060	35 - 39	60I-5060	52-7/8"	5230	19 - 25	60I-5230	53-7/8"	5370	42 - 45	60I-5370
50-7/8"	5065	39 - 42	60I-5065	52-7/8"	5240	25 - 32	60I-5240				
50-7/8"	5070	42 - 45	60I-5070	52-7/8"	5250	32 - 35	60I-5250				

60I SERIES ENDS & CLIP COMBINATIONS

**Suffix
-1**

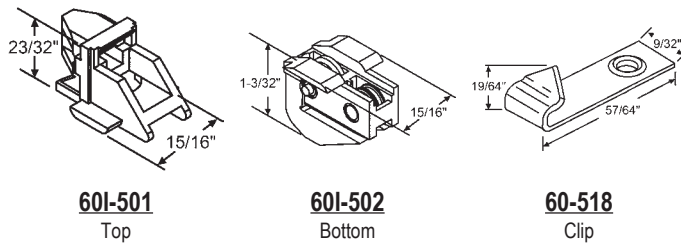

**Suffix
-1AB**

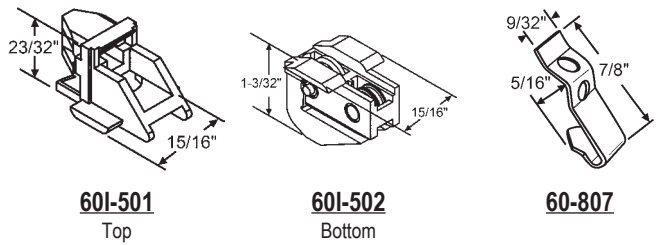

**Suffix
-1T**

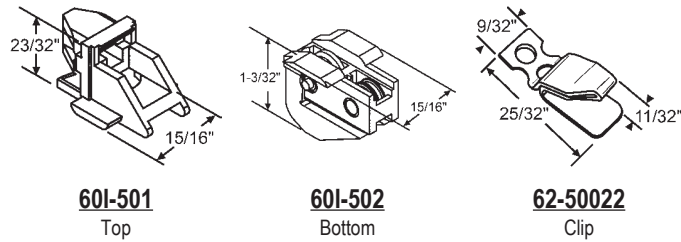

**Suffix
-1AE**

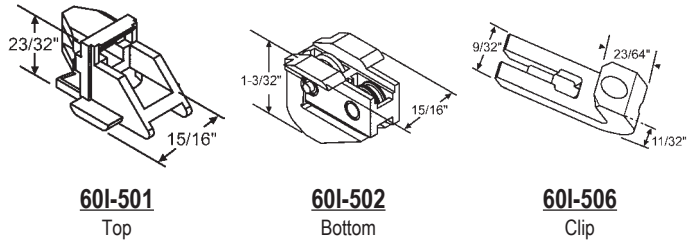

**Suffix
-2**

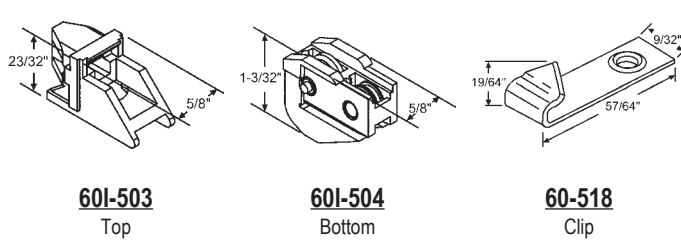

**Suffix
-2AB**

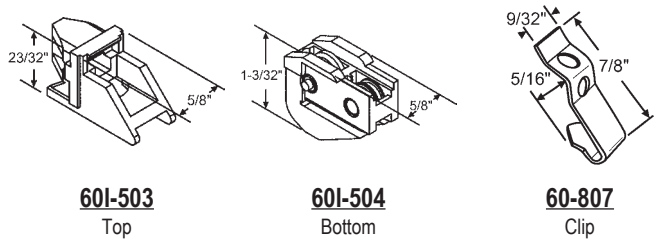

**Suffix
-2T**

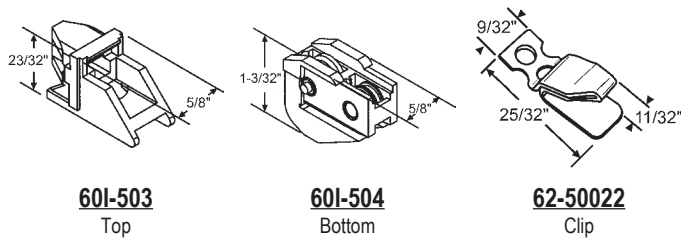

**Suffix
-2AE**

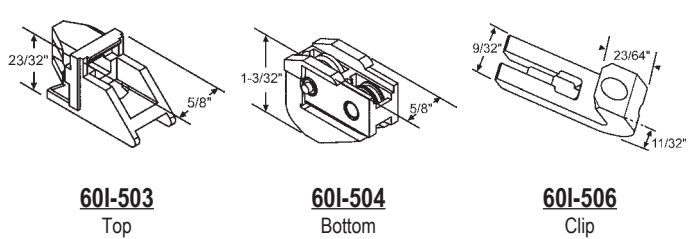

SASH SUPPORT SYSTEMS

60I SERIES ENDS & CLIP COMBINATIONS

**Suffix
-3**

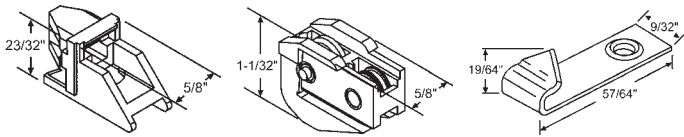

60I-503
Top

60I-505
Bottom

60-518
Clip

**Suffix
-3AB**

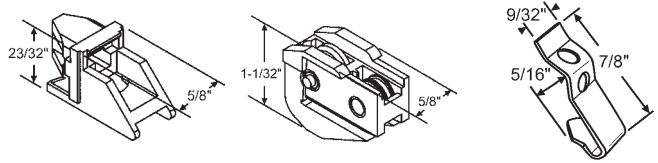

60I-503
Top

60I-505
Bottom

60-807
Clip

**Suffix
-3T**

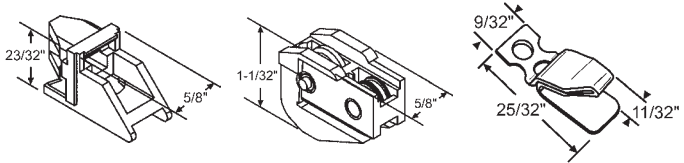

60I-503
Top

60I-505
Bottom

62-50022
Clip

**Suffix
-3AE**

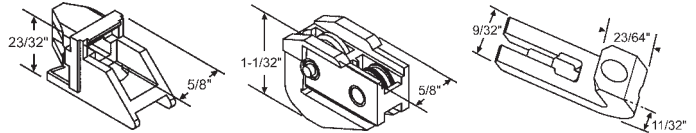

60I-503
Top

60I-505
Bottom

60I-506
Clip

**Suffix
-4**

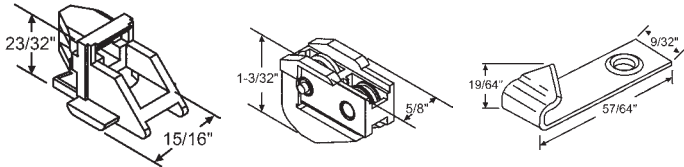

60I-501
Top

60I-504
Bottom

60-518
Clip

**Suffix
-4AB**

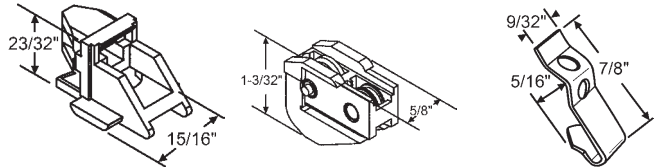

60I-501
Top

60I-504
Bottom

60-807
Clip

**Suffix
-4T**

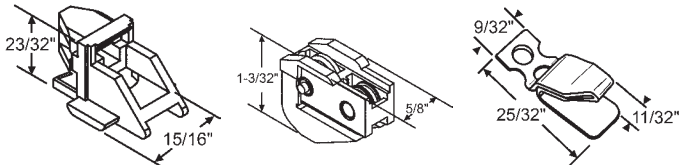

60I-501
Top

60I-504
Bottom

62-50022
Clip

**Suffix
-4AE**

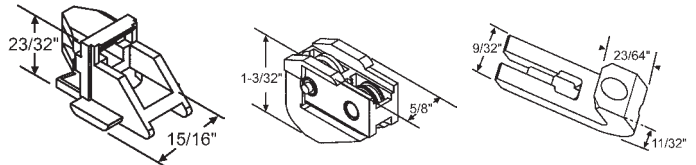

60I-501
Top

60I-504
Bottom

60I-506
Clip

**Suffix
-5**

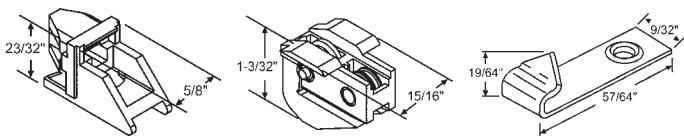

60I-503
Top

60I-502
Bottom

60-518
Clip

**Suffix
-5AB**

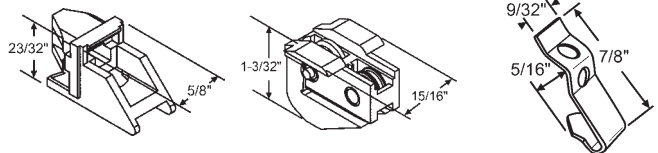

60I-503
Top

60I-502
Bottom

60-807
Clip

60I SERIES ENDS & CLIP COMBINATIONS

**Suffix
-5T**

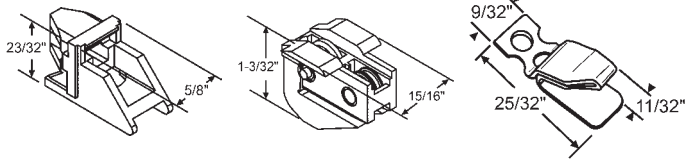

60I-503
Top

60I-502
Bottom

62-50022
Clip

**Suffix
-5AE**

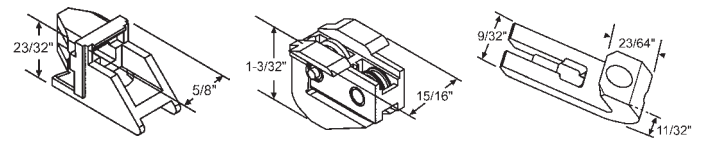

60I-503
Top

60I-502
Bottom

60I-506
Clip

**Suffix
-6**

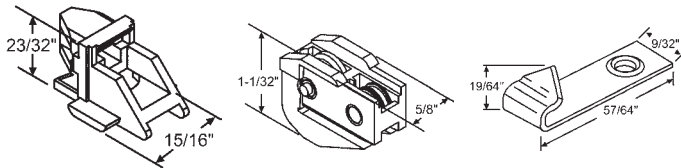

60I-501
Top

60I-505
Bottom

60-518
Clip

**Suffix
-6AB**

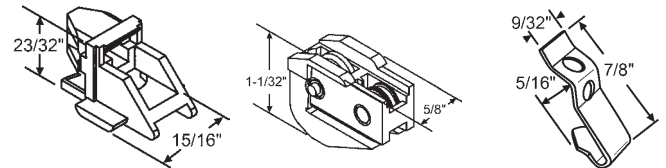

60I-501
Top

60I-505
Bottom

60-807
Clip

**Suffix
-6T**

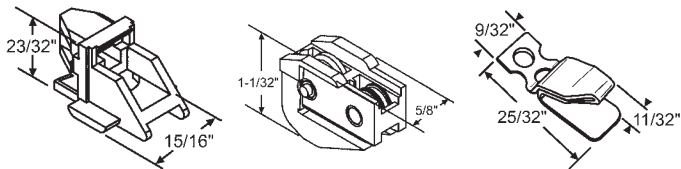

60I-501
Top

60I-505
Bottom

62-50022
Clip

**Suffix
-6AE**

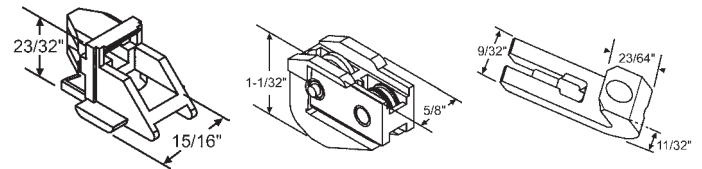

60I-501
Top

60I-505
Bottom

60I-506
Clip

**Suffix
-7**

No Longer Available.
Use Suffix -7AE

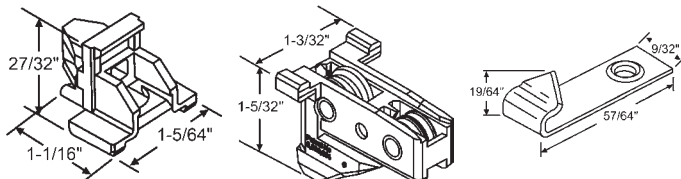

60I-509
Top

60I-510
Bottom

60-518
Clip

**Suffix
-7AB**

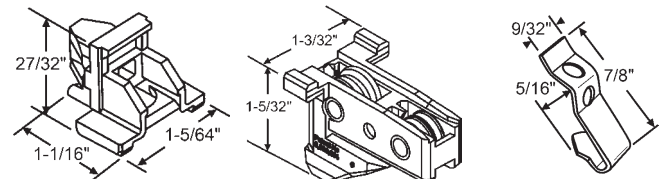

60I-509
Top

60I-510
Bottom

60-807
Clip

**Suffix
-7T**

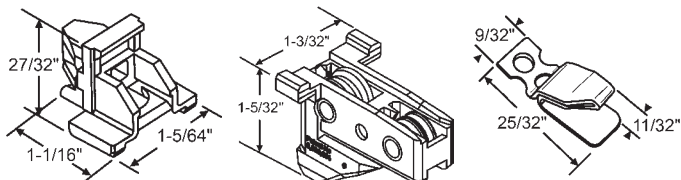

60I-509
Top

60I-510
Bottom

62-50022
Clip

**Suffix
-7AE**

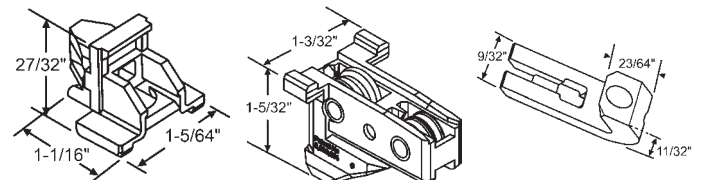

60I-509
Top

60I-510
Bottom

60I-506
Clip

61 SERIES CHANNEL BALANCE WITH HEMMED EDGE

Continued from previous page.

Length of Metal Channel	Number Stamped on Balance	Sash Weight	Our Part Number	Length of Metal Channel	Number Stamped on Balance	Sash Weight	Our Part Number	Length of Metal Channel	Number Stamped on Balance	Sash Weight	Our Part Number	Length of Metal Channel	Number Stamped on Balance	Sash Weight	Our Part Number
46"	45-1	9 To 14 Lbs.	61-451	48"	47-4	24 To 30 Lbs.	61-474	51"	50-1	9 To 15 Lbs.	61-5010	53"	52-4	24 To 32 Lbs.	61-5240
46"	45-2	14 To 19 Lbs.	61-452	48"	47-5	30 To 37 Lbs.	61-475	51"	50-2	15 To 19 Lbs.	61-5020	53"	52-5	32 To 37 Lbs.	61-5250
46"	45-3	19 To 24 Lbs.	61-453	48"	47-9	37 To 44 Lbs.	61-479	51"	50-3	19 To 25 Lbs.	61-5030	53"	52-9	37 To 44 Lbs.	61-5290
46"	45-4	24 To 31 Lbs.	61-454	49"	48-1	9 To 14 Lbs.	61-481	51"	50-4	25 To 32 Lbs.	61-5040	54"	53-1	9 To 14 Lbs.	61-5310
46"	45-5	31 To 37 Lbs.	61-455	49"	48-2	14 To 19 Lbs.	61-482	51"	50-5	32 To 37 Lbs.	61-5050	54"	53-2	14 To 19 Lbs.	61-5320
46"	45-9	37 To 42 Lbs.	61-459	49"	48-3	19 To 24 Lbs.	61-483	51"	50-9	37 To 44 Lbs.	61-5090	54"	53-3	19 To 25 Lbs.	61-5330
47"	46-1	9 To 14 Lbs.	61-461	49"	48-4	24 To 32 Lbs.	61-484	52"	51-1	9 To 14 Lbs.	61-5110	54"	53-4	25 To 34 Lbs.	61-5340
47"	46-2	14 To 19 Lbs.	61-462	49"	48-5	32 To 37 Lbs.	61-485	52"	51-2	14 To 19 Lbs.	61-5120	54"	53-5	34 To 39 Lbs.	61-5350
47"	46-3	19 To 25 Lbs.	61-463	49"	48-9	37 To 44 Lbs.	61-489	52"	51-3	19 To 24 Lbs.	61-5130	54"	53-9	39 To 44 Lbs.	61-5390
47"	46-4	25 To 31 Lbs.	61-464	50"	49-1	9 To 14 Lbs.	61-491	52"	51-4	24 To 32 Lbs.	61-5140	55"	54-3	19 To 24 Lbs.	61-5430
47"	46-5	31 To 37 Lbs.	61-465	50"	49-2	14 To 19 Lbs.	61-492	52"	51-5	32 To 37 Lbs.	61-5150	55"	54-5	32 To 37 Lbs.	61-5450
47"	46-9	37 To 44 Lbs.	61-469	50"	49-3	19 To 24 Lbs.	61-493	52"	51-9	37 To 44 Lbs.	61-5190	55"	54-9	37 To 44 Lbs.	61-5490
48"	47-1	9 To 14 Lbs.	61-471	50"	49-4	24 To 32 Lbs.	61-494	53"	52-1	9 To 14 Lbs.	61-5210	57"	56-5	32 To 37 Lbs.	61-5650
48"	47-2	14 To 19 Lbs.	61-472	50"	49-5	32 To 37 Lbs.	61-495	53"	52-2	14 To 19 Lbs.	61-5220	59"	58-3	19 To 24 Lbs.	61-5830
48"	47-3	19 To 24 Lbs.	61-473	50"	49-9	37 To 44 Lbs.	61-499	53"	52-3	19 To 24 Lbs.	61-5230				

TOP BRACKETS

60-Series top brackets are all interchangeable with 61-Series balances. Use 61-Series bottom brackets listed below.

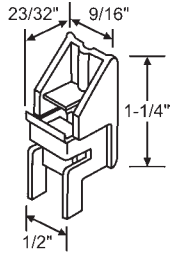

Part #	Color
60-507	White
60-507B	Black

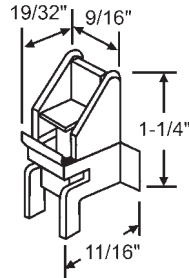

60-508

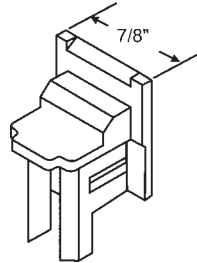

61-503

No Longer Available. Use 60-595

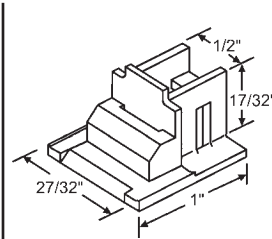

60-595

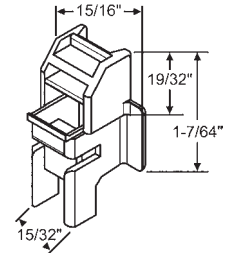

61-516

Nylon
PGT/ATRIUM

BOTTOM BRACKETS

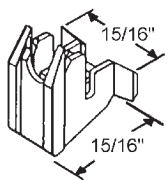

61-508

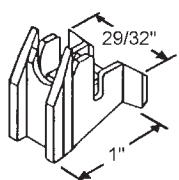

61-512

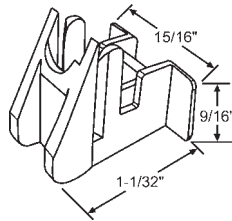

61-519

Nylon
PGT/ATRIUM

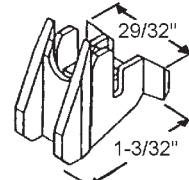

61-510

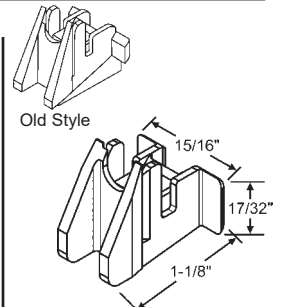

61-507

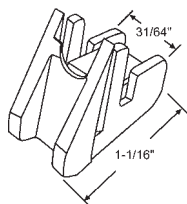

61-515

No Longer Available
Use: 61-501

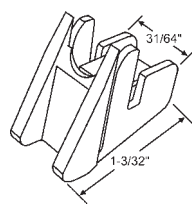

61-501

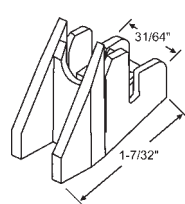

61-509

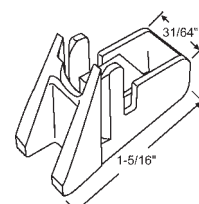

61-513

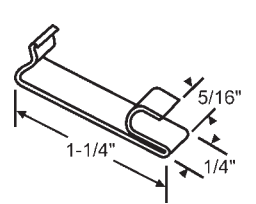

60-708

Take out clip
SILVER LINE

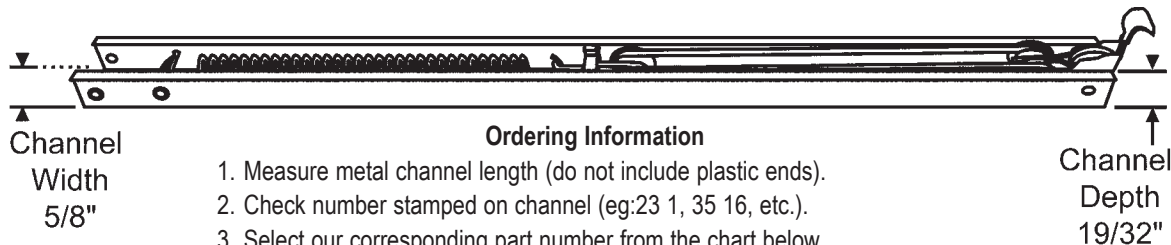

- Ordering Information**
1. Measure metal channel length (do not include plastic ends).
 2. Check number stamped on channel (eg:23 1, 35 16, etc.).
 3. Select our corresponding part number from the chart below.
 4. Identify the top and bottom end combination to be attached and add suffix to part number. **Balance not sold separately, ends must be attached.**

Example Ordering Chart

Length of Metal Channel	Number Stamped on Balance	Strybuc Part Number	Attached Ends Suffix	Complete Part Number
42"	41 15	61AP-4115	-6	61AP-4115-6

Length of Metal Channel	Number Stamped on Balance	Sash Weight	Spring	Our Part Number	Length of Metal Channel	Number Stamped on Balance	Sash Weight	Spring	Our Part Number
8"	7 1	2 to 3 LBS	Single	61AP-071	13"	12 2	5 to 8 LBS	Single	61AP-122
8"	7 2	3 to 4 LBS	Single	61AP-072	13"	12 3	8 to 10 LBS	Single	61AP-123
8"	7 3	4 to 5 LBS	Single	61AP-073	13"	12 4	10 to 13 LBS	Single	61AP-124
8"	7 4	5 to 6 LBS	Single	61AP-074	13"	12 5	13 to 16 LBS	Single	61AP-125
8"	7 5	6 to 8 LBS	Single	61AP-075	13"	12 6	16 to 19 LBS	Single	61AP-126
8"	7 9	8 to 10 LBS	Single	61AP-079	13"	12 9	19 to 22 LBS	Single	61AP-129
8"	7 11	10 to 14 LBS	Single	61AP-0711	13"	12 11	22 to 24 LBS	Double	61AP-1211
8"	7 12	14 to 18 LBS	Single	61AP-0712	13"	12 12	24 to 27 LBS	Double	61AP-1212
9"	8 1	2 to 3 LBS	Single	61AP-081	13"	12 13	27 to 30 LBS	Double	61AP-1213
9"	8 2	3 to 4 LBS	Single	61AP-082	13"	12 14	30 to 33 LBS	Double	61AP-1214
9"	8 3	4 to 6 LBS	Single	61AP-083	14"	13 1	3 to 5 LBS	Single	61AP-131
9"	8 4	6 to 8 LBS	Single	61AP-084	14"	13 2	5 to 8 LBS	Single	61AP-132
9"	8 5	8 to 10 LBS	Single	61AP-085	14"	13 3	8 to 10 LBS	Single	61AP-133
9"	8 9	10 to 12 LBS	Single	61AP-089	14"	13 4	10 to 13 LBS	Single	61AP-134
9"	8 11	12 to 16 LBS	Single	61AP-0811	14"	13 5	13 to 16 LBS	Single	61AP-135
9"	8 12	16 to 20 LBS	Single	61AP-0812	14"	13 6	16 to 19 LBS	Single	61AP-136
10"	9 1	3 to 5 LBS	Single	61AP-091	14"	13 9	19 to 22 LBS	Single	61AP-139
10"	9 2	5 to 7 LBS	Single	61AP-092	14"	13 11	22 to 24 LBS	Double	61AP-1311
10"	9 3	7 to 9 LBS	Single	61AP-093	14"	13 12	24 to 27 LBS	Double	61AP-1312
10"	9 4	9 to 11 LBS	Single	61AP-094	14"	13 13	27 to 30 LBS	Double	61AP-1313
10"	9 5	11 to 12 lbs	Single	61AP-095	14"	13 14	30 to 33 LBS	Double	61AP-1314
10"	9 6	12 to 13 LBS	Single	61AP-096	14"	13 15	33 to 35 LBS	Double	61AP-1315
10"	9 9	12 to 15 LBS	Single	61AP-099	15"	14 1	4 to 6 LBS	Single	61AP-141
10"	9 11	15 to 18 LBS	Single	61AP-0911	15"	14 2	6 to 9 LBS	Single	61AP-142
10"	9 12	10 to 22 LBS	Single	61AP-0912	15"	14 3	9 to 12 LBS	Single	61AP-143
11"	10 1	3 to 5 LBS	Single	61AP-101	15"	14 4	12 to 15 LBS	Single	61AP-144
11"	10 2	5 to 7 LBS	Single	61AP-102	15"	14 5	16 to 19 LBS	Single	61AP-145
11"	10 3	7 to 9 LBS	Single	61AP-103	15"	14 6	19 to 23 LBS	Single	61AP-146
11"	10 4	9 to 11 LBS	Single	61AP-104	15"	14 9	23 to 25 LBS	Single	61AP-149
11"	10 5	11 to 13 LBS	Single	61AP-105	15"	14 11	26 to 27 LBS	Double	61AP-1411
11"	10 6	13 to 16 LBS	Single	61AP-106	15"	14 12	27 to 30 LBS	Double	61AP-1412
11"	10 9	16 to 18 LBS	Single	61AP-109	15"	14 13	30 to 33 LBS	Double	61AP-1413
11"	10 11	18 to 22 LBS	Single	61AP-1011	15"	14 14	33 to 35 LBS	Double	61AP-1414
11"	10 12	22 to 26 LBS	Single	61AP-1012	15"	14 15	35 to 37 LBS	Double	61AP-1415
12"	11 1	3 to 4 LBS	Single	61AP-111	16"	15 1	4 to 6 LBS	Single	61AP-151
12"	11 2	5 to 6 LBS	Single	61AP-112	16"	15 2	6 to 9 LBS	Single	61AP-152
12"	11 3	7 to 8 LBS	Single	61AP-113	16"	15 3	9 to 12 LBS	Single	61AP-153
12"	11 4	9 to 11 LBS	Single	61AP-114	16"	15 4	12 to 16 LBS	Single	61AP-154
12"	11 5	11 to 13 LBS	Single	61AP-115	16"	15 5	16 to 19 LBS	Single	61AP-155
12"	11 6	13 to 16 LBS	Single	61AP-116	16"	15 6	19 to 23 LBS	Single	61AP-156
12"	11 9	16 to 20 LBS	Single	61AP-119	16"	15 9	23 to 25 LBS	Single	61AP-159
12"	11 11	20 to 24 LBS	Single	61AP-1111	16"	15 11	26 to 27 LBS	Double	61AP-1511
12"	11 12	24 to 27 LBS	Single	61AP-1112	16"	15 12	27 to 30 LBS	Double	61AP-1512
13"	12 1	3 to 4 LBS	Single	61AP-121	16"	15 13	30 to 33 LBS	Double	61AP-1513

Continued on next page

61AP SERIES NON-TILT BALANCE

Continued from previous page

Length of Metal Channel	Number Stamped on Balance	Sash Weight	Spring	Our Part Number	Length of Metal Channel	Number Stamped on Balance	Sash Weight	Spring	Our Part Number
16"	15 14	33 to 35 LBS	Double	61AP-1514	22"	21 1	4 to 7 LBS	Single	61AP-211
16"	15 15	35 to 37 LBS	Double	61AP-1515	22"	21 2	7 to 10 LBS	Single	61AP-212
17"	16 1	4 to 6 LBS	Single	61AP-161	22"	21 3	10 to 14 LBS	Single	61AP-213
17"	16 2	6 to 9 LBS	Single	61AP-162	22"	21 4	14 to 19 LBS	Single	61AP-214
17"	16 3	9 to 12 LBS	Single	61AP-163	22"	21 5	19 to 24 LBS	Single	61AP-215
17"	16 4	12 to 16 LBS	Single	61AP-164	22"	21 6	24 to 27 LBS	Single	61AP-216
17"	16 5	16 to 19 LBS	Single	61AP-165	22"	21 9	27 to 30 LBS	Single	61AP-219
17"	16 6	19 to 23 LBS	Single	61AP-166	22"	21 11	30 to 31 LBS	Double	61AP-2111
17"	16 9	23 to 26 LBS	Single	61AP-169	22"	21 12	31 to 34 LBS	Double	61AP-2112
17"	16 11	26 to 27 LBS	Double	61AP-1611	22"	21 13	34 to 37 LBS	Double	61AP-2113
17"	16 12	27 to 30 LBS	Double	61AP-1612	22"	21 14	37 to 40 LBS	Double	61AP-2114
17"	16 13	30 to 33 LBS	Double	61AP-1613	22"	21 15	40 to 42 LBS	Double	61AP-2115
17"	16 14	33 to 35 LBS	Double	61AP-1614	23"	22 1	5 to 8 LBS	Single	61AP-221
17"	16 15	35 to 37 LBS	Double	61AP-1615	23"	22 2	8 to 11 LBS	Single	61AP-222
18"	17 1	4 to 6 LBS	Single	61AP-171	23"	22 3	11 to 14 LBS	Single	61AP-223
18"	17 2	6 to 9 LBS	Single	61AP-172	23"	22 4	14 to 19 LBS	Single	61AP-224
18"	17 3	9 to 12 LBS	Single	61AP-173	23"	22 5	19 to 24 LBS	Single	61AP-225
18"	17 4	12 to 16 LBS	Single	61AP-174	23"	22 6	24 to 29 LBS	Single	61AP-226
18"	17 5	16 to 19 LBS	Single	61AP-175	23"	22 9	29 to 32 LBS	Single	61AP-229
18"	17 6	19 to 23 LBS	Single	61AP-176	23"	22 12	32 to 34 LBS	Double	61AP-2212
18"	17 9	23 to 26 LBS	Single	61AP-179	23"	22 13	34 to 37 LBS	Double	61AP-2213
18"	17 11	26 to 27 LBS	Double	61AP-1711	23"	22 14	37 to 40 LBS	Double	61AP-2214
18"	17 12	27 to 30 LBS	Double	61AP-1712	23"	22 15	40 to 43 LBS	Double	61AP-2215
18"	17 13	30 to 33 LBS	Double	61AP-1713	24"	23 1	5 to 8 LBS	Single	61AP-231
18"	17 14	33 to 35 LBS	Double	61AP-1714	24"	23 2	8 to 11 LBS	Single	61AP-232
18"	17 15	35 to 38 LBS	Double	61AP-1715	24"	23 3	11 to 15 LBS	Single	61AP-233
19"	18 1	4 to 7 LBS	Single	61AP-181	24"	23 4	15 to 19 LBS	Single	61AP-234
19"	18 2	7 to 10 LBS	Single	61AP-182	24"	23 5	19 to 24 LBS	Single	61AP-235
19"	18 3	10 to 14 LBS	Single	61AP-183	24"	23 6	24 to 29 LBS	Single	61AP-236
19"	18 4	14 to 19 LBS	Single	61AP-184	24"	23 9	29 to 32 LBS	Single	61AP-239
19"	18 5	19 to 24 LBS	Single	61AP-185	24"	23 12	32 to 34 LBS	Double	61AP-2312
19"	18 6	24 to 27 LBS	Single	61AP-186	24"	23 13	34 to 37 LBS	Double	61AP-2313
19"	18 9	27 to 30 LBS	Single	61AP-189	24"	23 14	37 to 40 LBS	Double	61AP-2314
19"	18 11	30 to 31 LBS	Double	61AP-1811	24"	23 15	40 to 43 LBS	Double	61AP-2315
19"	18 12	31 to 33 LBS	Double	61AP-1812	25"	24 1	5 to 8 LBS	Single	61AP-241
19"	18 13	33 to 35 LBS	Double	61AP-1813	25"	24 2	8 to 11 LBS	Single	61AP-242
19"	18 14	35 to 38 LBS	Double	61AP-1814	25"	24 3	11 to 15 LBS	Single	61AP-243
19"	18 15	38 to 40	Double	61AP-1815	25"	24 4	15 to 19 LBS	Single	61AP-244
20"	19 1	4 to 7 LBS	Single	61AP-191	25"	24 5	19 to 24 LBS	Single	61AP-245
20"	19 2	7 to 10 LBS	Single	61AP-192	25"	24 6	24 to 29 LBS	Single	61AP-246
20"	19 3	10 to 14 LBS	Single	61AP-193	25"	24 9	29 to 34 LBS	Single	61AP-249
20"	19 4	14 to 19 LBS	Single	61AP-194	25"	24 11	34 to 36 LBS	Double	61AP-2411
20"	19 5	19 to 24 LBS	Single	61AP-195	25"	24 12	36 to 39 LBS	Double	61AP-2412
20"	19 6	24 to 27 LBS	Single	61AP-196	25"	24 13	39 to 42 LBS	Double	61AP-2413
20"	19 9	27 to 30 LBS	Single	61AP-199	25"	24 14	42 to 45 LBS	Double	61AP-2414
20"	19 11	30 to 31 LBS	Double	61AP-1911	25"	24 15	45 to 47 LBS	Double	61AP-2415
20"	19 12	31 to 34 LBS	Double	61AP-1912	26"	25 1	5 to 8 LBS	Single	61AP-251
20"	19 13	34 to 37 LBS	Double	61AP-1913	26"	25 2	8 to 11 LBS	Single	61AP-252
20"	19 14	37 to 40 LBS	Double	61AP-1914	26"	25 3	11 to 15 LBS	Single	61AP-253
20"	19 15	40 to 42 LBS	Double	61AP-1915	26"	25 4	15 to 19 LBS	Single	61AP-254
21"	20 1	4 to 7 LBS	Single	61AP-201	26"	25 5	19 to 24 LBS	Single	61AP-255
21"	20 2	7 to 10 LBS	Single	61AP-202	26"	25 6	24 to 29 LBS	Single	61AP-256
21"	20 3	10 to 14 LBS	Single	61AP-203	26"	25 9	29 to 34 LBS	Single	61AP-259
21"	20 4	14 to 19 LBS	Single	61AP-204	26"	25 11	34 to 36 LBS	Double	61AP-2511
21"	20 5	19 to 24 LBS	Single	61AP-205	26"	25 12	36 to 39 LBS	Double	61AP-2512
21"	20 6	24 to 27 LBS	Single	61AP-206	26"	25 13	39 to 42 LBS	Double	61AP-2513
21"	20 9	27 to 30 LBS	Single	61AP-209	26"	25 14	42 to 45 LBS	Double	61AP-2514
21"	20 11	30 to 31 LBS	Double	61AP-2011	26"	25 15	45 to 47 LBS	Double	61AP-2515
21"	20 12	31 to 34 LBS	Double	61AP-2012	26"	25 16	47 to 49 LBS	Double	61AP-2516
21"	20 13	34 to 37 LBS	Double	61AP-2013	27"	26 1	5 to 8 LBS	Single	61AP-261
21"	20 14	37 to 40 LBS	Double	61AP-2014	27"	26 2	8 to 12 LBS	Single	61AP-262
21"	20 15	40 to 42 LBS	Double	61AP-2015	27"	26 3	12 to 17 LBS	Single	61AP-263

Continued on next page

Continued from previous page

Length of Metal Channel	Number Stamped on Balance	Sash Weight	Spring	Our Part Number	Length of Metal Channel	Number Stamped on Balance	Sash Weight	Spring	Our Part Number
27"	26 4	17 to 22 LBS	Single	61AP-264	32"	31 1	6 to 9 LBS	Single	61AP-311
27"	26 5	22 to 26 LBS	Single	61AP-265	32"	31 2	9 to 13 LBS	Single	61AP-312
27"	26 6	26 to 30 LBS	Single	61AP-266	32"	31 3	13 to 18 LBS	Single	61AP-313
27"	26 9	30 to 34 LBS	Single	61AP-269	32"	31 4	18 to 24 LBS	Single	61AP-314
27"	26 11	34 to 36 LBS	Double	61AP-2611	32"	31 5	24 to 30 LBS	Single	61AP-315
27"	26 12	36 to 39 LBS	Double	61AP-2612	32"	31 6	30 to 35 LBS	Single	61AP-316
27"	26 13	39 to 42 LBS	Double	61AP-2613	32"	31 9	35 to 38 LBS	Single	61AP-319
27"	26 14	42 to 45 LBS	Double	61AP-2614	32"	31 12	38 to 41 LBS	Double	61AP-3112
27"	26 15	45 to 47 LBS	Double	61AP-2615	32"	31 13	41 to 43 LBS	Double	61AP-3113
27"	26 16	47 to 49 LBS	Double	61AP-2616	32"	31 14	43 to 45 LBS	Double	61AP-3114
28"	27 1	5 to 8 LBS	Single	61AP-271	32"	31 15	45 to 47 LBS	Double	61AP-3115
28"	27 2	8 to 12 LBS	Single	61AP-272	32"	31 16	47 to 50 LBS	Double	61AP-3116
28"	27 3	12 to 17 LBS	Single	61AP-273	32"	31 17	50 to 52 LBS	Double	61AP-3117
28"	27 4	17 to 22 LBS	Single	61AP-274	33"	32 1	6 to 9 LBS	Single	61AP-321
28"	27 5	22 to 27 LBS	Single	61AP-275	33"	32 2	9 to 13 LBS	Single	61AP-322
28"	27 6	27 to 31 LBS	Single	61AP-276	33"	32 3	13 to 18 LBS	Single	61AP-323
28"	27 9	31 to 36 LBS	Single	61AP-279	33"	32 4	18 to 24 LBS	Single	61AP-324
28"	27 11	36 to 37 LBS	Double	61AP-2711	33"	32 5	24 to 30 LBS	Single	61AP-325
28"	27 12	37 to 40 LBS	Double	61AP-2712	33"	32 6	30 to 35 LBS	Single	61AP-326
28"	27 13	40 to 43 LBS	Double	61AP-2713	33"	32 9	35 to 38 LBS	Single	61AP-329
28"	27 14	43 to 45 LBS	Double	61AP-2714	33"	32 12	38 to 41 LBS	Double	61AP-3212
28"	27 15	45 to 47 LBS	Double	61AP-2715	33"	32 13	41 to 43 LBS	Double	61AP-3213
28"	27 16	47 to 50 LBS	Double	61AP-2716	33"	32 14	43 to 45 LBS	Double	61AP-3214
29"	28 1	6 to 9 LBS	Single	61AP-281	33"	32 15	45 to 48 LBS	Double	61AP-3215
29"	28 2	9 to 13 LBS	Single	61AP-282	33"	32 16	48 to 50 LBS	Double	61AP-3216
29"	28 3	13 to 18 LBS	Single	61AP-283	33"	32 17	50 to 52 LBS	Double	61AP-3217
29"	28 4	18 to 24 LBS	Single	61AP-284	34"	33 1	6 to 9 LBS	Single	61AP-331
29"	28 5	24 to 30 LBS	Single	61AP-285	34"	33 2	9 to 13 LBS	Single	61AP-332
29"	28 6	30 to 34 LBS	Single	61AP-286	34"	33 3	13 to 18 LBS	Single	61AP-333
29"	28 9	34 to 38 LBS	Single	61AP-289	34"	33 4	18 to 24 LBS	Single	61AP-334
29"	28 12	38 to 41 LBS	Double	61AP-2812	34"	33 5	24 to 30 LBS	Single	61AP-335
29"	28 13	41 to 43 LBS	Double	61AP-2813	34"	33 6	30 to 35 LBS	Single	61AP-336
29"	28 14	43 to 45 LBS	Double	61AP-2814	34"	33 9	35 to 38 LBS	Single	61AP-339
29"	28 15	45 to 47 LBS	Double	61AP-2815	34"	33 12	38 to 41 LBS	Double	61AP-3312
29"	28 16	47 to 50 LBS	Double	61AP-2816	34"	33 13	41 to 43 LBS	Double	61AP-3313
29"	28 17	50 to 52 LBS	Double	61AP-2817	34"	33 14	43 to 45 LBS	Double	61AP-3314
30"	29 1	6 to 9 LBS	Single	61AP-291	34"	33 15	45 to 48 LBS	Double	61AP-3315
30"	29 2	9 to 13 LBS	Single	61AP-292	34"	33 16	48 to 50 LBS	Double	61AP-3316
30"	29 3	13 to 18 LBS	Single	61AP-293	34"	33 17	50 to 52 LBS	Double	61AP-3317
30"	29 4	18 to 24 LBS	Single	61AP-294	35"	34 1	6 to 9 LBS	Single	61AP-341
30"	29 5	24 to 30 LBS	Single	61AP-295	35"	34 2	9 to 13 LBS	Single	61AP-342
30"	29 6	30 to 35 LBS	Single	61AP-296	35"	34 3	13 to 18 LBS	Single	61AP-343
30"	29 9	35 to 38 LBS	Single	61AP-299	35"	34 4	18 to 24 LBS	Single	61AP-344
30"	29 12	38 to 41 LBS	Double	61AP-2912	35"	34 5	24 to 30 LBS	Single	61AP-345
30"	29 13	41 to 43 LBS	Double	61AP-2913	35"	34 6	30 to 35 LBS	Single	61AP-346
30"	29 14	43 to 45 LBS	Double	61AP-2914	35"	34 9	35 to 38 LBS	Single	61AP-349
30"	29 15	45 to 47 LBS	Double	61AP-2915	35"	34 12	38 to 41 LBS	Double	61AP-3412
30"	29 16	47 to 50 LBS	Double	61AP-2916	35"	34 13	41 to 43 LBS	Double	61AP-3413
30"	29 17	50 to 52 LBS	Double	61AP-2917	35"	34 14	43 to 45 LBS	Double	61AP-3414
31"	30 1	6 to 9 LBS	Single	61AP-301	35"	34 15	45 to 48 LBS	Double	61AP-3415
31"	30 2	9 to 13 LBS	Single	61AP-302	35"	34 16	48 to 51 LBS	Double	61AP-3416
31"	30 3	13 to 18 LBS	Single	61AP-303	35"	34 17	51 to 53 LBS	Double	61AP-3417
31"	30 4	18 to 24 LBS	Single	61AP-304	36"	35 1	8 to 12 LBS	Single	61AP-351
31"	30 5	24 to 30 LBS	Single	61AP-305	36"	35 2	12 to 17 LBS	Single	61AP-352
31"	30 6	30 to 35 LBS	Single	61AP-306	36"	35 3	17 to 23 LBS	Single	61AP-353
31"	30 9	35 to 38 LBS	Single	61AP-309	36"	35 4	23 to 29 LBS	Single	61AP-354
31"	30 12	38 to 41 LBS	Double	61AP-3012	36"	35 5	29 to 34 LBS	Single	61AP-355
31"	30 13	41 to 43 LBS	Double	61AP-3013	36"	35 6	34 to 38 LBS	Single	61AP-356
31"	30 14	43 to 45 LBS	Double	61AP-3014	36"	35 9	38 to 40 LBS	Single	61AP-359
31"	30 15	45 to 47 LBS	Double	61AP-3015	36"	35 12	40 to 43 LBS	Double	61AP-3512
31"	30 16	47 to 50 LBS	Double	61AP-3016	36"	35 13	43 to 45 LBS	Double	61AP-3513
31"	30 17	50 to 52 LBS	Double	61AP-3017	36"	35 14	45 to 48 LBS	Double	61AP-3514

Continued on next page

61AP SERIES NON-TILT BALANCE

Continued from previous page

Length of Metal Channel	Number Stamped on Balance	Sash Weight	Spring	Our Part Number	Length of Metal Channel	Number Stamped on Balance	Sash Weight	Spring	Our Part Number
36"	35 15	48 to 51 LBS	Double	61AP-3515	42"	41 2	13 to 18 LBS	Single	61AP-412
36"	35 16	51 to 53 LBS	Double	61AP-3516	42"	41 3	18 to 24 LBS	Single	61AP-413
37"	36 1	8 to 12 LBS	Single	61AP-361	42"	41 4	24 to 29 LBS	Single	61AP-414
37"	36 2	12 to 17 LBS	Single	61AP-362	42"	41 5	29 to 35 LBS	Single	61AP-415
37"	36 3	17 to 23 LBS	Single	61AP-363	42"	41 6	35 to 39 LBS	Single	61AP-416
37"	36 4	23 to 29 LBS	Single	61AP-364	42"	41 9	39 to 42 LBS	Single	61AP-419
37"	36 5	29 to 34 LBS	Single	61AP-365	42"	41 12	42 to 45 LBS	Double	61AP-4112
37"	36 6	34 to 38 LBS	Single	61AP-366	42"	41 13	45 to 48 LBS	Double	61AP-4113
37"	36 9	38 to 40 LBS	Single	61AP-369	42"	41 14	48 to 51 LBS	Double	61AP-4114
37"	36 12	40 to 43 LBS	Double	61AP-3612	42"	41 15	51 to 53 LBS	Double	61AP-4115
37"	36 13	43 to 45 LBS	Double	61AP-3613	43"	42 1	9 to 13 LBS	Single	61AP-421
37"	36 14	45 to 48 LBS	Double	61AP-3614	43"	42 2	13 to 18 LBS	Single	61AP-422
37"	36 15	48 to 51 LBS	Double	61AP-3615	43"	42 3	18 to 24 LBS	Single	61AP-423
37"	36 16	51 to 53 LBS	Double	61AP-3616	43"	42 4	24 to 29 LBS	Single	61AP-424
38"	37 1	8 to 12 LBS	Single	61AP-371	43"	42 5	29 to 35 LBS	Single	61AP-425
38"	37 2	12 to 17 LBS	Single	61AP-372	43"	42 6	35 to 39 LBS	Single	61AP-426
38"	37 3	17 to 23 LBS	Single	61AP-373	43"	42 9	39 to 42 LBS	Single	61AP-429
38"	37 4	23 to 29 LBS	Single	61AP-374	43"	42 12	42 to 45 LBS	Double	61AP-4212
38"	37 5	29 to 34 LBS	Single	61AP-375	43"	42 13	45 to 48 LBS	Double	61AP-4213
38"	37 6	34 to 38 LBS	Single	61AP-376	43"	42 14	48 to 51 LBS	Double	61AP-4214
38"	37 9	38 to 40 LBS	Single	61AP-379	43"	42 15	51 to 53 LBS	Double	61AP-4215
38"	37 12	40 to 43 LBS	Double	61AP-3712	44"	43 1	9 to 13 LBS	Single	61AP-431
38"	37 13	43 to 45 LBS	Double	61AP-3713	44"	43 2	13 to 18 LBS	Single	61AP-432
38"	37 14	45 to 48 LBS	Double	61AP-3714	44"	43 3	18 to 24 LBS	Single	61AP-433
38"	37 15	48 to 51 LBS	Double	61AP-3715	44"	43 4	24 to 29 LBS	Single	61AP-434
38"	37 16	51 to 53 LBS	Double	61AP-3716	44"	43 5	29 to 35 LBS	Single	61AP-435
39"	38 1	8 to 12 LBS	Single	61AP-381	44"	43 6	35 to 39 LBS	Single	61AP-436
39"	38 2	12 to 17 LBS	Single	61AP-382	44"	43 9	39 to 42 LBS	Single	61AP-439
39"	38 3	17 to 23 LBS	Single	61AP-383	44"	43 12	42 to 45 LBS	Double	61AP-4312
39"	38 4	23 to 29 LBS	Single	61AP-384	44"	43 13	45 to 48 LBS	Double	61AP-4313
39"	38 5	29 to 34 LBS	Single	61AP-385	44"	43 14	48 to 51 LBS	Double	61AP-4314
39"	38 6	34 to 38 LBS	Single	61AP-386	44"	43 15	51 to 53 LBS	Double	61AP-4315
39"	38 9	38 to 40 LBS	Single	61AP-389	45"	44 1	9 to 13 LBS	Single	61AP-441
39"	38 12	40 to 43 LBS	Double	61AP-3812	45"	44 2	13 to 18 LBS	Single	61AP-442
39"	38 13	43 to 45 LBS	Double	61AP-3813	45"	44 3	18 to 24 LBS	Single	61AP-443
39"	38 14	45 to 48 LBS	Double	61AP-3814	45"	44 4	24 to 29 LBS	Single	61AP-444
39"	38 15	48 to 51 LBS	Double	61AP-3815	45"	44 5	29 to 35 LBS	Single	61AP-445
39"	38 16	51 to 53 LBS	Double	61AP-3816	45"	44 6	35 to 39 LBS	Single	61AP-446
40"	39 1	8 to 12 LBS	Single	61AP-391	45"	44 9	39 to 42 LBS	Single	61AP-449
40"	39 2	12 to 17 LBS	Single	61AP-392	45"	44 12	42 to 45 LBS	Double	61AP-4412
40"	39 3	17 to 23 LBS	Single	61AP-393	45"	44 13	45 to 48 LBS	Double	61AP-4413
40"	39 4	23 to 29 LBS	Single	61AP-394	45"	44 14	48 to 51 LBS	Double	61AP-4414
40"	39 5	29 to 34 LBS	Single	61AP-395	45"	44 5	51 to 53 LBS	Double	61AP-4415
40"	39 6	34 to 38 LBS	Single	61AP-396	46"	45 1	9 to 13 LBS	Single	61AP-451
40"	39 9	38 to 40 LBS	Single	61AP-399	46"	45 2	13 to 18 LBS	Single	61AP-452
40"	39 12	40 to 43 LBS	Double	61AP-3912	46"	45 3	18 to 24 LBS	Single	61AP-453
40"	39 13	43 to 45 LBS	Double	61AP-3913	46"	45 4	24 to 29 LBS	Single	61AP-454
40"	39 14	45 to 48 LBS	Double	61AP-3914	46"	45 5	29 to 35 LBS	Single	61AP-455
40"	39 15	48 to 51 LBS	Double	61AP-3915	46"	45 6	35 to 39 LBS	Single	61AP-456
40"	39 16	51 to 53 LBS	Double	61AP-3916	46"	45 9	39 to 42 LBS	Single	61AP-459
41"	40 1	9 to 13 LBS	Single	61AP-401	46"	45 12	42 to 45 LBS	Double	61AP-4512
41"	40 2	13 to 18 LBS	Single	61AP-402	46"	45 13	45 to 48 LBS	Double	61AP-4513
41"	40 3	18 to 24 LBS	Single	61AP-403	46"	45 14	48 to 51 LBS	Double	61AP-4514
41"	40 4	24 to 29 LBS	Single	61AP-404	46"	45 15	51 to 53 LBS	Double	61AP-4515
41"	40 5	29 to 35 LBS	Single	61AP-405	47"	46 1	9 to 13 LBS	Single	61AP-461
41"	40 6	35 to 39 LBS	Single	61AP-406	47"	46 2	13 to 18 LBS	Single	61AP-462
41"	40 9	39 to 42 LBS	Single	61AP-409	47"	46 3	18 to 24 LBS	Single	61AP-463
41"	40 12	42 to 45 LBS	Double	61AP-4012	47"	46 4	24 to 29 LBS	Single	61AP-464
41"	40 13	45 to 48 LBS	Double	61AP-4013	47"	46 5	29 to 35 LBS	Single	61AP-465
41"	40 14	48 to 51 LBS	Double	61AP-4014	47"	46 6	35 to 39 LBS	Single	61AP-466
41"	40 15	51 to 53 LBS	Double	61AP-4015	47"	46 9	39 to 42 LBS	Single	61AP-469
42"	41 1	9 to 13 LBS	Single	61AP-411	47"	46 12	42 to 45 LBS	Double	61AP-4612

Continued on next page

Continued from previous page

Length of Metal Channel	Number Stamped on Balance	Sash Weight	Spring	Our Part Number	Length of Metal Channel	Number Stamped on Balance	Sash Weight	Spring	Our Part Number
47"	46 13	45 to 48 LBS	Double	61AP-4613	54"	53 4	24 to 29 LBS	Single	61AP-534
47"	46 14	48 to 51 LBS	Double	61AP-4614	54"	53 5	29 to 35 LBS	Single	61AP-535
47"	46 15	51 to 53 LBS	Double	61AP-4615	54"	53 6	35 to 39 LBS	Single	61AP-536
48"	47 1	9 to 13 LBS	Single	61AP-471	54"	53 9	39 to 43 LBS	Single	61AP-539
48"	47 2	13 to 18 LBS	Single	61AP-472	54"	53 12	43 to 45 LBS	Double	61AP-5312
48"	47 3	18 to 24 LBS	Single	61AP-473	54"	53 13	45 to 48 LBS	Double	61AP-5313
48"	47 4	24 to 29 LBS	Single	61AP-474	55"	54 1	9 to 13 LBS	Single	61AP-541
48"	47 5	29 to 35 LBS	Single	61AP-475	55"	54 2	13 to 18 LBS	Single	61AP-542
48"	47 6	35 to 39 LBS	Single	61AP-476	55"	54 3	18 to 24 LBS	Single	61AP-543
48"	47 9	39 to 43 LBS	Single	61AP-479	55"	54 4	24 to 29 LBS	Single	61AP-544
48"	47 12	43 to 45 LBS	Double	61AP-4712	55"	54 5	29 to 35 LBS	Single	61AP-545
48"	47 13	45 to 50 LBS	Double	61AP-4713	55"	54 6	35 to 39 LBS	Single	61AP-546
48"	47 14	50 to 52 LBS	Double	61AP-4714	55"	54 9	39 to 43 LBS	Single	61AP-549
49"	48 1	9 to 13 LBS	Single	61AP-481	56"	55 1	9 to 13 LBS	Single	61AP-551
49"	48 2	13 to 18 LBS	Single	61AP-482	56"	55 2	13 to 18 LBS	Single	61AP-552
49"	48 3	18 to 24 LBS	Single	61AP-483	56"	55 3	18 to 24 LBS	Single	61AP-553
49"	48 4	24 to 29 LBS	Single	61AP-484	56"	55 4	24 to 29 LBS	Single	61AP-554
49"	48 5	29 to 35 LBS	Single	61AP-485	56"	55 5	29 to 35 LBS	Single	61AP-555
49"	48 6	35 to 39 LBS	Single	61AP-486	56"	55 6	35 to 39 LBS	Single	61AP-556
49"	48 9	39 to 43 LBS	Single	61AP-489	56"	55 9	39 to 43 LBS	Single	61AP-557
49"	48 12	43 to 45 LBS	Double	61AP-4812	57"	56 1	9 to 13 LBS	Single	61AP-561
49"	48 13	45 to 49 LBS	Double	61AP-4813	57"	56 2	13 to 18 LBS	Single	61AP-562
49"	48 14	49 to 51 LBS	Double	61AP-4814	57"	56 3	18 to 24 LBS	Single	61AP-563
50"	49 1	9 to 13 LBS	Single	61AP-491	57"	56 4	24 to 29 LBS	Single	61AP-564
50"	49 2	13 to 18 LBS	Single	61AP-492	57"	56 5	29 to 35 LBS	Single	61AP-565
50"	49 3	18 to 24 LBS	Single	61AP-493	57"	56 6	35 to 39 LBS	Single	61AP-566
50"	49 4	24 to 29 LBS	Single	61AP-494	57"	56 9	39 to 43 LBS	Single	61AP-569
50"	49 5	29 to 35 LBS	Single	61AP-495	58"	57 1	9 to 13 LBS	Single	61AP-571
50"	49 6	35 to 39 LBS	Single	61AP-496	58"	57 2	13 to 18 LBS	Single	61AP-572
50"	49 9	39 to 43 LBS	Single	61AP-499	58"	57 3	18 to 24 LBS	Single	61AP-573
50"	49 13	43 to 45 LBS	Double	61AP-4913	58"	57 4	24 to 29 LBS	Single	61AP-574
50"	49 13	45 to 48 LBS	Double	61AP-4913	58"	57 5	29 to 35 LBS	Single	61AP-575
51"	50 1	9 to 13 LBS	Single	61AP-501	58"	57 6	35 to 39 LBS	Single	61AP-576
51"	50 2	13 to 18 LBS	Single	61AP-502	58"	57 9	39 to 43 LBS	Single	61AP-579
51"	50 3	18 to 24 LBS	Single	61AP-503	59"	58 1	9 to 13 LBS	Single	61AP-581
51"	50 4	24 to 29 LBS	Single	61AP-504	59"	58 2	13 to 18 LBS	Single	61AP-582
51"	50 5	29 to 35 LBS	Single	61AP-505	59"	58 3	18 to 24 LBS	Single	61AP-583
51"	50 6	35 to 39 LBS	Single	61AP-506	59"	58 4	24 to 29 LBS	Single	61AP-584
51"	50 9	39 to 43 LBS	Single	61AP-509	59"	58 5	29 to 35 LBS	Single	61AP-585
51"	50 12	43 to 45 LBS	Double	61AP-5012	59"	58 6	35 to 39 LBS	Single	61AP-586
51"	50 13	45 to 48 LBS	Double	61AP-5013	60"	59 1	9 to 13 LBS	Single	61AP-591
52"	51 1	9 to 13 LBS	Single	61AP-511	60"	59 2	13 to 18 LBS	Single	61AP-592
52"	51 2	13 to 18 LBS	Single	61AP-512	60"	59 3	18 to 24 LBS	Single	61AP-593
52"	51 3	18 to 24 LBS	Single	61AP-513	60"	59 4	24 to 29 LBS	Single	61AP-594
52"	51 4	24 to 29 LBS	Single	61AP-514	60"	59 5	29 to 35 LBS	Single	61AP-595
52"	51 5	29 to 35 LBS	Single	61AP-515	60"	59 6	35 to 39 LBS	Single	61AP-596
52"	51 6	35 to 39 LBS	Single	61AP-516					
52"	51 9	39 to 43 LBS	Single	61AP-519					
52"	51 12	43 to 45 LBS	Double	61AP-5112					
52"	51 13	45 to 48 LBS	Double	61AP-5113					
53"	52 1	9 to 13 LBS	Single	61AP-521					
53"	52 2	13 to 18 LBS	Single	61AP-522					
53"	52 3	18 to 24 LBS	Single	61AP-523					
53"	52 4	24 to 29 LBS	Single	61AP-524					
53"	52 5	29 to 35 LBS	Single	61AP-525					
53"	52 6	35 to 39 LBS	Single	61AP-526					
53"	52 9	39 to 43 LBS	Single	61AP-529					
53"	52 12	43 to 45 LBS	Double	61AP-5212					
53"	52 13	45 to 48 LBS	Double	61AP-5213					
54"	53 1	9 to 13 LBS	Single	61AP-531					
54"	53 2	13 to 18 LBS	Single	61AP-532					
54"	53 3	18 to 24 LBS	Single	61AP-533					

Continued on next page

61AP SERIES NON-TILT BALANCE TOP AND BOTTOM END COMBINATIONS

Add suffix to complete part number.

Single Spring Combo

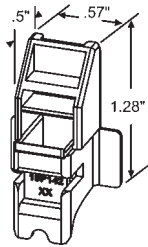

61-502

-0

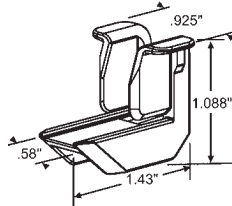

61AP-505

Double Spring Combo

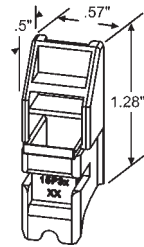

61-500

-1

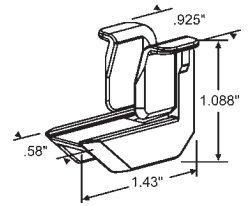

61AP-500

Double Spring Combo

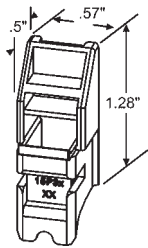

61-500

-2

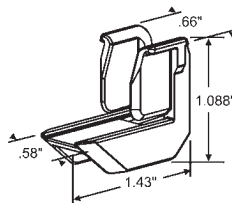

61AP-501

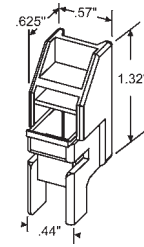

61-525

-16

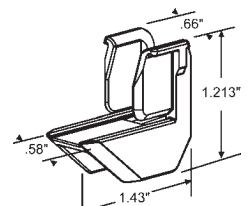

61AP-504

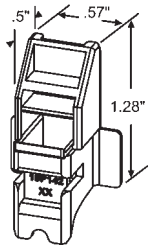

61-502

-6

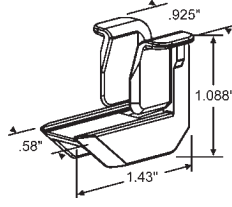

61AP-500

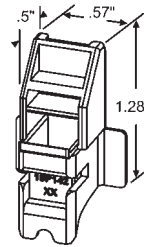

61-502

-8

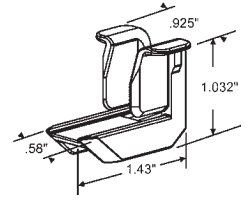

61AP-502

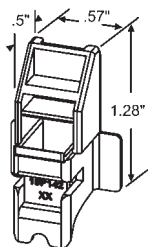

61-502

-9

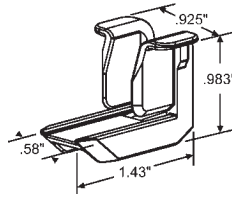

61AP-503

SASH SUPPORT SYSTEMS

61TI SERIES INVERTED TILT BALANCE

Silver Line

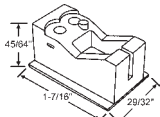

62-708W
Balance Stop



62-709W
Screw Cover White

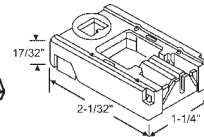
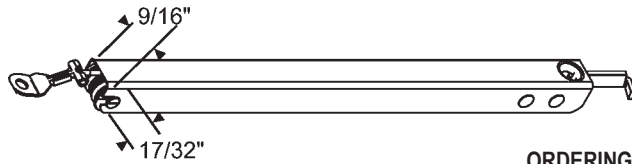

85-516
SILVER LINE

GENERAL INFORMATION

All Accessories such as pivot lock shoes and pivot bars must be purchased separately. Refer to 85 Series balance accessory pages.

ORDERING INFORMATION

1. Measure length of channel. (Do not include any attached ends)
2. Check number stamped on channel: e.g. 23-5, 25-7 etc.
3. Check for corresponding sash weight.
4. Select our corresponding part number from the chart below and order accordingly.

Length of Metal Channel	Number Stamped on Balance	Sash Weight	Our Part Number	Length of Metal Channel	Number Stamped on Balance	Sash Weight	Our Part Number	Length of Metal Channel	Number Stamped on Balance	Sash Weight	Our Part Number
10"	9-1	2 - 5	61TI-091	22"	21-5	15 - 19	61TI-215	34"	33-5	25 - 30	61TI-335
10"	9-3	5 - 7	61TI-093	22"	21-7	19 - 24	61TI-217	34"	33-7	30 - 34	61TI-337
10"	9-5	7 - 9	61TI-095	22"	21-9	24 - 28	61TI-219	34"	33-9	34 - 40	61TI-339
10"	9-7	9 - 11	61TI-097	23"	22-1	6 - 10	61TI-221	35"	34-1	14 - 19	61TI-341
11"	10-1	2 - 5	61TI-101	23"	22-3	10 - 14	61TI-223	35"	34-3	19 - 25	61TI-343
11"	10-3	5 - 7	61TI-103	23"	22-5	14 - 18	61TI-225	35"	34-5	25 - 30	61TI-345
11"	10-5	7 - 11	61TI-105	23"	22-7	18 - 24	61TI-227	35"	34-7	30 - 34	61TI-347
11"	10-7	11 - 13	61TI-107	23"	22-9	24 - 28	61TI-229	35"	34-9	34 - 42	61TI-349
11"	10-9	13 - 15	61TI-109	24"	23-1	7 - 10	61TI-231	36"	35-1	14 - 19	61TI-351
12"	11-1	4 - 7	61TI-111	24"	23-3	10 - 14	61TI-233	36"	35-3	19 - 25	61TI-353
12"	11-3	7 - 9	61TI-113	24"	23-5	14 - 19	61TI-235	36"	35-5	25 - 30	61TI-355
12"	11-5	9 - 13	61TI-115	24"	23-7	19 - 25	61TI-237	36"	35-7	30 - 34	61TI-357
12"	11-7	13 - 15	61TI-117	24"	23-9	25 - 30	61TI-239	36"	35-9	34 - 42	61TI-359
12"	11-9	15 - 18	61TI-119	25"	24-1	7 - 11	61TI-241	37"	36-1	14 - 19	61TI-361
13"	12-1	5 - 9	61TI-121	25"	24-3	11 - 17	61TI-243	37"	36-3	19 - 25	61TI-363
13"	12-3	9 - 12	61TI-123	25"	24-5	17 - 24	61TI-245	37"	36-5	25 - 30	61TI-365
13"	12-5	12 - 14	61TI-125	25"	24-7	24 - 30	61TI-247	37"	36-7	30 - 34	61TI-367
13"	12-7	14 - 16	61TI-127	25"	24-9	30 - 34	61TI-249	37"	36-9	34 - 42	61TI-369
13"	12-9	16 - 19	61TI-129	26"	25-1	8 - 13	61TI-251	38"	37-1	14 - 19	61TI-371
14"	13-1	5 - 9	61TI-131	26"	25-3	13 - 19	61TI-253	38"	37-3	19 - 25	61TI-373
14"	13-5	9 - 12	61TI-135	26"	25-5	19 - 24	61TI-255	38"	37-5	25 - 30	61TI-375
14"	13-7	12 - 14	61TI-137	26"	25-7	24 - 30	61TI-257	38"	37-7	30 - 35	61TI-377
14"	13-9	16 - 19	61TI-139	26"	25-9	30 - 34	61TI-259	38"	37-9	35 - 42	61TI-379
15"	14-1	5 - 8	61TI-141	27"	26-1	9 - 12	61TI-261	39"	38-1	14 - 19	61TI-381
15"	14-3	8 - 12	61TI-143	27"	26-3	12 - 17	61TI-263	39"	38-3	19 - 25	61TI-383
15"	14-5	12 - 16	61TI-145	27"	26-5	17 - 23	61TI-265	39"	38-5	25 - 30	61TI-385
15"	14-7	16 - 19	61TI-147	27"	26-7	23 - 30	61TI-267	39"	38-7	30 - 35	61TI-387
15"	14-9	19 - 25	61TI-149	27"	26-9	30 - 34	61TI-269	39"	38-9	35 - 42	61TI-389
16"	15-1	5 - 8	61TI-151	28"	27-1	10 - 14	61TI-271	40"	39-1	14 - 19	61TI-391
16"	15-3	8 - 12	61TI-153	28"	27-3	14 - 19	61TI-273	40"	39-3	19 - 25	61TI-393
16"	15-5	12 - 16	61TI-155	28"	27-5	19 - 24	61TI-275	40"	39-5	25 - 31	61TI-395
16"	15-7	16 - 19	61TI-157	28"	27-7	24 - 31	61TI-277	40"	39-7	31 - 35	61TI-397
16"	15-9	19 - 25	61TI-159	28"	27-9	31 - 34	61TI-279	40"	39-9	35 - 42	61TI-399
17"	16-1	5 - 8	61TI-161	29"	28-1	10 - 14	61TI-281	41"	40-1	14 - 19	61TI-401
17"	16-3	8 - 12	61TI-163	29"	28-3	14 - 20	61TI-283	41"	40-3	19 - 25	61TI-403
17"	16-5	12 - 16	61TI-165	29"	28-5	20 - 27	61TI-285	41"	40-5	25 - 31	61TI-405
17"	16-7	16 - 20	61TI-167	29"	28-7	27 - 34	61TI-287	41"	40-7	31 - 35	61TI-407
17"	16-9	20 - 24	61TI-169	29"	28-9	34 - 38	61TI-289	41"	40-9	35 - 42	61TI-409
18"	17-1	5 - 8	61TI-171	30"	29-1	10 - 14	61TI-291	42"	41-1	13 - 19	61TI-411
18"	17-3	8 - 12	61TI-173	30"	29-3	14 - 21	61TI-293	42"	41-3	19 - 25	61TI-413
18"	17-5	12 - 16	61TI-175	30"	29-5	21 - 27	61TI-295	42"	41-5	25 - 31	61TI-415
18"	17-7	16 - 20	61TI-177	30"	29-7	27 - 34	61TI-297	42"	41-7	31 - 36	61TI-417
18"	17-9	20 - 25	61TI-179	30"	29-9	34 - 38	61TI-299	42"	41-9	36 - 42	61TI-419
19"	18-1	5 - 9	61TI-181	31"	30-1	12 - 16	61TI-301	43"	42-1	14 - 19	61TI-421
19"	18-3	9 - 12	61TI-183	31"	30-3	16 - 23	61TI-303	43"	42-3	19 - 25	61TI-423
19"	18-5	12 - 16	61TI-185	31"	30-5	23 - 28	61TI-305	43"	42-5	25 - 31	61TI-425
19"	18-7	16 - 20	61TI-187	31"	30-7	28 - 34	61TI-307	43"	42-7	31 - 36	61TI-427
19"	18-9	20 - 26	61TI-189	31"	30-9	34 - 38	61TI-309	43"	42-9	36 - 42	61TI-429
20"	19-1	5 - 8	61TI-191	32"	31-1	13 - 17	61TI-311	44"	43-1	14 - 19	61TI-431
20"	19-3	8 - 12	61TI-193	32"	31-3	17 - 23	61TI-313	44"	43-3	19 - 25	61TI-433
20"	19-5	12 - 16	61TI-195	32"	31-5	23 - 28	61TI-315	44"	43-5	25 - 31	61TI-435
20"	19-7	16 - 21	61TI-197	32"	31-7	28 - 34	61TI-317	44"	43-7	31 - 37	61TI-437
20"	19-9	21 - 26	61TI-199	32"	31-9	34 - 38	61TI-319	44"	43-9	37 - 42	61TI-439
21"	20-1	6 - 10	61TI-201	33"	32-1	13 - 18	61TI-321	45"	44-1	14 - 19	61TI-441
21"	20-3	10 - 15	61TI-203	33"	32-3	18 - 24	61TI-323	45"	44-3	19 - 25	61TI-443
21"	20-5	15 - 19	61TI-205	33"	32-5	24 - 29	61TI-325	45"	44-5	25 - 31	61TI-445
21"	20-7	19 - 24	61TI-207	33"	32-7	29 - 34	61TI-327	45"	44-7	31 - 37	61TI-447
21"	20-9	24 - 28	61TI-209	33"	32-9	34 - 40	61TI-329	45"	44-9	37 - 42	61TI-449
22"	21-1	6 - 10	61TI-211	34"	33-1	13 - 19	61TI-331				
22"	21-3	10 - 15	61TI-213	34"	33-3	19 - 25	61TI-333				

62 SERIES CHANNEL BALANCES

1/2" TILT WINDOW CHANNEL BALANCE

Actually 5/8" but considered 1/2" in the trade.

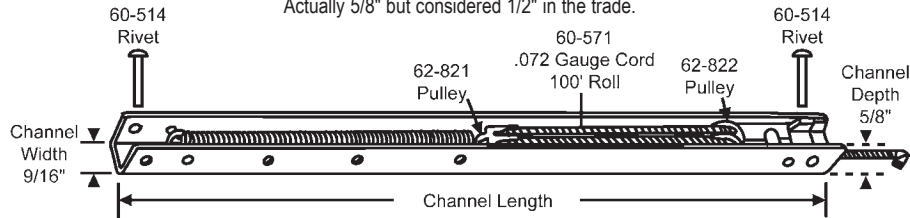

Ordering Information

1. Measure channel length (do not include any attached ends).
2. Check number stamped on channel. (e.g., 2210, 22DS, etc.)
3. Select our corresponding part number from the chart below.
4. If the number stamped on the balance ends with DS (double spring), you will need to select the exact weight from the weight range in the chart. An example would be if the number stamped on your balance is 19DS, you'll need to select the exact weight of the sash between 30-40 lbs. (ex. 32lbs). Then add the weight to the part number from the chart below. Ex: 62-19DS32
5. Balances that are 29" & above that have 90 stamped on the balance (ex. 3090) are no longer available. These balances are being substituted with the 50 weight range balances (ex. 3050). Balances that are below 29" & have 90 stamped on the balance (ex. 2590) they will need to be ordered by replacing the 90 that is stamped on the balance with the letter "S" (ex. 2590 to 25S). Then you will need the exact weight of the sash (usually stamped on balance. If not, you'll need to weigh the sash) & add the weight after the letter "S" (ex: if the sash weighs 28lbs, the part number would be 62-25S28).
6. Some balances maybe stamped with the letter "U" or "L" that indicates Upper sash or Lower sash. If your balance is stamped with the letter U or L, please add the letter to the end of the part number (ex. 62-305L or 62-25S28U).
7. Identify the appropriate end bracket to be attached from the illustrations shown; then add -1,-2,-3, etc suffix to complete our part number.

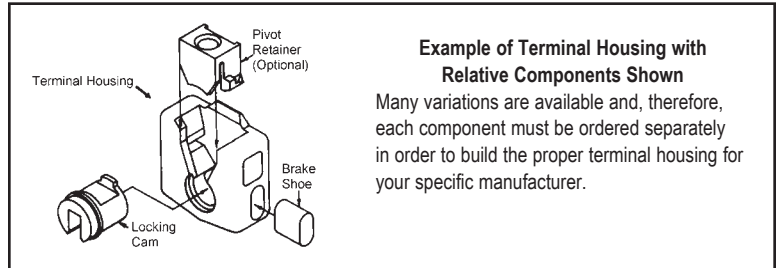

Example of Terminal Housing with Relative Components Shown

Many variations are available and, therefore, each component must be ordered separately in order to build the proper terminal housing for your specific manufacturer.

General Information

- 1) Any other number/letter variations which may be stamped on your balance should first be discussed with your representative to ensure that your order will be filled correctly.
- 2) Balance prices include attached bracket

END BRACKETS

Add suffix to complete part number. Must choose end to be attached directly to cord.

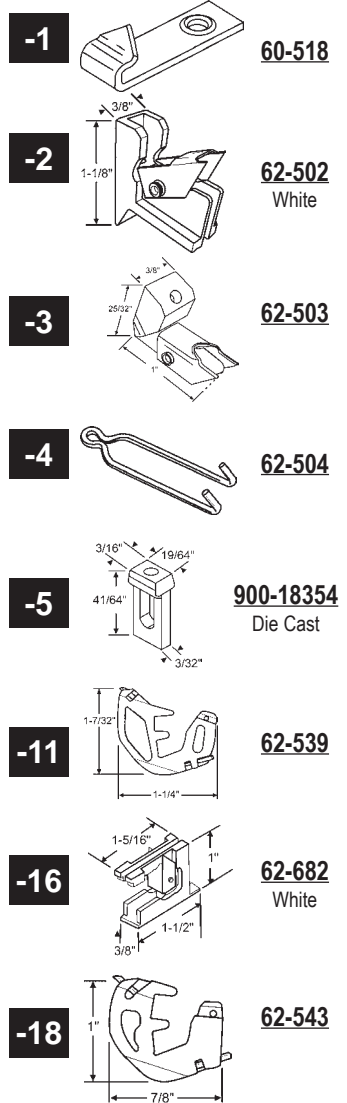

Balance Length	Number Stamped on Balance	Weight Range	Our Part Number
13"	1210	3-8	62-121-
13"	1220	8-11	62-122-
13"	1230	11-13	62-123-
13"	1240	13-17	62-124-
13"	1290	- 20	see instructions 5 and 6
14"	1310	4-8	62-131-
14"	1320	8-11	62-132-
14"	1330	11-13	62-133-
14"	1340	13-17	62-134-
14"	1390	- 20	see instructions 5 and 6
15"	1410	4-7	62-141-
15"	1420	7-11	62-142-
15"	1430	11-14	62-143-
15"	1440	14-20	62-144-
15"	1490	- 20	see instructions 5 and 6
16"	1510	4-7	62-151-
16"	1520	7-11	62-152-
16"	1530	11-14	62-153-
16"	1540	14-20	62-154-
16"	1590	- 20	see instructions 5 and 6
17"	1610	4-8	62-161-
17"	1620	8-11	62-162-
17"	1630	11-14	62-163-
17"	1640	14-20	62-164-
17"	1690	- 25	see instructions 5 and 6
17"	16DS	- 35	see instructions 4 and 6
18"	1710	4-8	62-171-
18"	1720	8-11	62-172-
18"	1730	11-14	62-173-
18"	1740	14-20	62-174-
18"	1790	- 25	see instructions 5 and 6
18"	17DS	- 35	see instructions 4 and 6
19"	1810	4-8	62-181-
19"	1820	8-11	62-182-
19"	1830	11-14	62-183-
19"	1840	14-20	62-184-
19"	1890	- 25	see instructions 5 and 6
19"	18DS	- 35	see instructions 4 and 6
20"	1910	4-7	62-191-
20"	1920	7-11	62-192-
20"	1930	11-14	62-193-
20"	1940	14-20	62-194-
20"	1990	- 30	see instructions 5 and 6
20"	19DS	- 40	see instructions 4 and 6
21"	2010	4-8	62-201-
21"	2020	8-13	62-202-
21"	2030	13-17	62-203-
21"	2040	17-25	62-204-
21"	2090	- 30	see instructions 5 and 6

Balance Length	Number Stamped on Balance	Weight Range	Our Part Number
21"	20DS	- 40	see instructions 4 and 6
22"	2110	5-9	62-211-
22"	2120	9-13	62-212-
22"	2130	13-17	62-213-
22"	2140	17-25	62-214-
22"	2190	- 30	see instructions 5 and 6
22"	21DS	- 40	see instructions 4 and 6
23"	2210	5-9	62-221-
23"	2220	9-14	62-222-
23"	2230	14-18	62-223-
23"	2240	18-26	62-224-
23"	2290	- 30	see instructions 5 and 6
23"	22DS	- 40	see instructions 4 and 6
24"	2310	5-10	62-231-
24"	2320	10-16	62-232-
24"	2330	16-20	62-233-
24"	2340	20-27	62-234-
24"	2390	- 30	see instructions 5 and 6
24"	23DS	- 40	see instructions 4 and 6
25"	2410	5-10	62-241-
25"	2420	10-16	62-242-
25"	2430	16-20	62-243-
25"	2440	20-27	62-244-
25"	2490	- 30	see instructions 5 and 6
25"	24DS	- 45	see instructions 4 and 6
26"	2510	5-10	62-251-
26"	2520	10-15	62-252-
26"	2530	15-20	62-253-
26"	2540	20-27	62-254-
26"	2590	- 30	see instructions 5 and 6
26"	25DS	- 45	see instructions 4 and 6
27"	2610	5-10	62-261-
27"	2620	10-16	62-262-
27"	2630	16-20	62-263-
27"	2640	20-27	62-264-
27"	2690	- 30	see instructions 5 and 6
27"	26DS	- 45	see instructions 4 and 6
28"	2710	5-10	62-271-
28"	2720	10-16	62-272-
28"	2730	16-20	62-273-
28"	2740	20-27	62-274-
28"	2790	- 30	see instructions 5 and 6
28"	27DS	- 45	see instructions 4 and 6
29"	2810	7-13	62-281-
29"	2820	13-17	62-282-
29"	2830	17-24	62-283-
29"	2840	24-30	62-284-
29"	2850	30-36	62-285-
29"	2890	- 35	62-285-

Continued on next page

Continued from previous page.

Balance Length	Number Stamped on Balance	Weight Range	Our Part Number
29"	28DS	- 45	see instructions 4 and 6
30"	2910	8-13	62-291-
30"	2920	13-17	62-293-
30"	2930	17-24	62-293-
30"	2940	24-30	62-294-
30"	2950	30-36	62-295-
30"	2990	- 35	62-295-
30"	29DS	- 45	see instructions 4 and 6
31"	3010	8-13	62-301-
31"	3020	13-18	62-302-
31"	3030	18-24	62-303-
31"	3040	24-30	62-304-
31"	3050	30-36	62-305-
31"	3090	- 35	62-305-
31"	30DS	- 45	see instructions 4 and 6
32"	3110	8-13	62-311-
32"	3120	13-17	62-312-
32"	3130	17-24	62-313-
32"	3140	24-30	62-314-
32"	3150	30-36	62-315-
32"	3190	- 35	62-315-
32"	31DS	- 45	see instructions 4 and 6
33"	3210	8-14	62-321-
33"	3220	14-19	62-322-
33"	3230	19-24	62-323-
33"	3240	24-30	62-324-
33"	3250	30-36	62-325-
33"	3290	- 35	62-325-
33"	32DS	- 45	see instructions 4 and 6
34"	3310	9-15	62-331-
34"	3320	15-19	62-332-
34"	3330	19-23	62-333-
34"	3340	23-30	62-334-
34"	3350	30-36	62-335-
34"	3390	- 35	62-335-
34"	33DS	- 45	see instructions 4 and 6
35"	3410	9-15	62-341-
35"	3420	15-19	62-342-
35"	3430	19-25	62-343-
35"	3440	25-30	62-344-
35"	3450	30-36	62-345-
35"	3490	- 35	62-345-
35"	34DS	- 45	see instructions 4 and 6
36"	3510	9-15	62-351-
36"	3520	15-19	62-352-
36"	3530	19-25	62-353-
36"	3540	25-30	62-354-
36"	3550	30-36	62-355-
36"	35DS	- 45	see instructions 4 and 6
37"	3610	9-15	62-361-
37"	3620	15-19	62-362-
37"	3630	19-25	62-363-
37"	3640	25-32	62-364-
37"	3650	32-38	62-365-
37"	36DS	- 45	see instructions 4 and 6
38"	3710	9-15	62-371-
38"	3720	15-19	62-372-
38"	3730	19-25	62-373-
38"	3740	25-32	62-374-
38"	3750	32-38	62-375-
38"	37DS	- 45	see instructions 4 and 6
39"	3810	9-15	62-381-
39"	3820	15-20	62-382-
39"	3830	20-25	62-383-
39"	3840	28-32	62-384-
39"	3850	32-38	62-385-
39"	38DS	- 45	see instructions 4 and 6
40"	3910	9-15	62-391-
40"	3920	15-20	62-392-
40"	3930	20-25	62-393-
40"	3940	25-32	62-394-
40"	3950	32-38	62-395-
40"	39DS	- 45	see instructions 4 and 6
41"	4010	9-15	62-401-
41"	4020	15-20	62-402-
41"	4030	20-25	62-403-
41"	4040	25-32	62-404-
41"	4050	32-38	62-405-
41"	40DS	- 45	see instructions 4 and 6
42"	4110	9-16	62-411-
42"	4120	16-20	62-412-
42"	4130	20-25	62-413-
42"	4140	25-32	62-414-
42"	4150	32-38	62-415-
42"	41DS	- 45	see instructions 4 and 6
43"	4210	9-16	62-421-
43"	4220	16-20	62-422-
43"	4230	20-26	62-423-

Balance Length	Number Stamped on Balance	Weight Range	Our Part Number
43"	4240	26-32	62-424-
43"	4250	32-38	62-425-
43"	42DS	- 45	see instructions 4 and 6
44"	4310	9-15	62-431-
44"	4320	15-20	62-432-
44"	4330	20-26	62-433-
44"	4340	26-32	62-434-
44"	4350	32-38	62-435-
44"	43DS	- 45	see instructions 4 and 6
45"	4410	9-15	62-441-
45"	4420	15-20	62-442-
45"	4430	20-26	62-443-
45"	4440	26-32	62-444-
45"	4450	32-38	62-445-
45"	44DS	- 45	see instructions 4 and 6
46"	4510	9-15	62-451-
46"	4520	15-20	62-452-
46"	4530	20-26	62-453-
46"	4540	26-32	62-454-
46"	4550	32-40	62-455-
46"	45DS	- 45	see instructions 4 and 6
47"	4610	9-15	62-461-
47"	4620	15-20	62-462-
47"	4630	20-26	62-463-
47"	4640	26-32	62-464-
47"	4650	32-40	62-465-
47"	46DS	- 45	see instructions 4 and 6
48"	4710	9-15	62-471-
48"	4720	15-20	62-472-
48"	4730	20-26	62-473-
48"	4740	26-32	62-474-
48"	4750	32-40	62-475-
48"	47DS	- 45	see instructions 4 and 6
49"	4810	9-15	62-481-
49"	4820	15-21	62-482-
49"	4830	21-26	62-483-
49"	4840	26-32	62-484-
49"	4850	32-40	62-485-
49"	48DS	- 45	see instructions 4 and 6
50"	4910	9-15	62-491-
50"	4920	15-20	62-492-
50"	4930	20-26	62-493-
50"	4940	26-32	62-494-
50"	4950	32-40	62-495-
50"	49DS	- 45	see instructions 4 and 6
51"	5010	9-15	62-501-
51"	5020	15-20	62-502-
51"	5030	20-26	62-503-
51"	5040	26-32	62-504-
51"	5050	32-40	62-505-
51"	50DS	- 45	see instructions 4 and 6
52"	5110	9-15	62-511-
52"	5120	15-21	62-512-
52"	5130	21-26	62-513-
52"	5140	26-32	62-514-
52"	5150	32-40	62-515-
52"	51DS	- 45	see instructions 4 and 6
53"	5210	9-15	62-521-
53"	5220	15-20	62-522-
53"	5230	20-26	62-523-
53"	5240	26-32	62-524-
53"	5250	32-40	62-525-
53"	52DS	- 45	see instructions 4 and 6
54"	5310	9-15	62-531-
54"	5320	15-20	62-532-
54"	5330	20-26	62-533-
54"	5340	26-32	62-534-
54"	5350	32-40	62-535-
54"	53DS	- 45	see instructions 4 and 6

62A SERIES BALANCES FOR JAMBLINERS

1/2" RIBBED CHANNEL BALANCE FOR JAMBLINERS COMMONLY REFERRED TO AS D70 BALANCES.

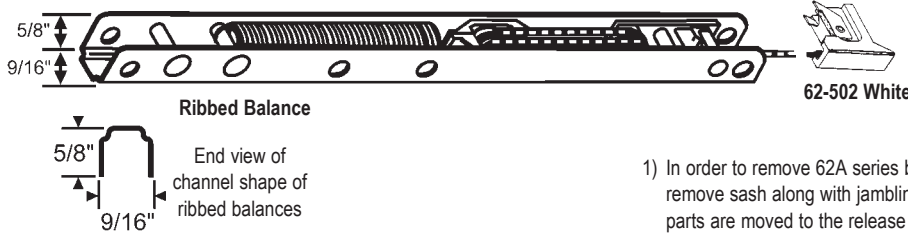

Ribbed Balance

62-502 White

General Information

- 1) In order to remove 62A series balances, you must first remove all window trim and remove sash along with jambliners. Balances can then be slid out of jambliner sleeve once parts are moved to the release position. (Forcing balances out of jambliner pocket will most likely destroy vinyl extrusion!)
- 2) Balances can be special ordered in beige or white finishes. Contact your account manager for part numbers.

Ordering Information

- 1) Measure metal channel length. Do not include any attached ends.
- 2) Check number stamped on channel. (e.g. 16, 16HD, 16TG, etc.)
- 3) Select our corresponding part number from the chart below.
- 4) Identify the appropriate end bracket to be attached from illustration at right of chart. Select -2, -5, -9, -12, -14, -16, -17.
- 5) Note -2, -12 are available in white and black. White will automatically be attached to regular balances; black will automatically be attached to HD, TG and XHD balances.

Length of Metal Channel	Number Stamped on Balance	Weight Range	Our Part Number
13"	12L	5 - 8	62A-12LT-
13"	12 or 12R	8 - 11	62A-12-
13"	12HD	11-14	62A-12HD-
13"	12TG or 12XHD or 12XH	14-17	62A-12TG-
14"	13L	5-8	62A-13LT-
14"	13 or 13R	8-11	62A-13-
14"	13HD	11-14	62A-13HD-
14"	13TG or 13XHD or 13XH	14-17	62A-13TG-
15"	14L	6-10	62A-14LT-
15"	14 or 14R	10-15	62A-14-
15"	14HD	15-22	62A-14HD-
15"	14TG or 14XHD or 14XH	22-24	62A-14TG-
16"	15L	6-10	62A-15LT-
16"	15 or 15R	10-15	62A-15-
16"	15HD	15-22	62A-15HD-
16"	15TG or 15XHD or 15XH	22-24	62A-15TG-
17"	16L	6-10	62A-16LT-
17"	16 or 16R	10-17	62A-16-
17"	16HD	17-22	62A-16HD-
17"	16TG or 16XHD or 16XH	22-24	62A-16TG-
18"	17L	6-10	62A-17LT-
18"	17 or 17R	10-17	62A-17-
18"	17HD	17-22	62A-17HD-
18"	17TG or 17XHD or 17XH	22-24	62A-17TG-
19"	18L	6-10	62A-18LT-
19"	18 or 18R	10-17	62A-18-
19"	18HD	17-22	62A-18HD-
19"	18TG or 18XHD or 18XH	22-24	62A-18TG-
20"	19L	6-10	62A-19LT-
20"	19 or 19R	10-17	62A-19-
20"	19HD	17-22	62A-19HD-
20"	19TG or 19XHD or 19XH	22-24	62A-19TG-
21"	20L	6-10	62A-20LT-
21"	20 or 20R	10-17	62A-20-
21"	20HD	17-20	62A-20HD-
21"	20TG or 20XHD or 20XH	20-30	62A-20TG-
22"	21L	6-10	62A-21LT-
22"	21 or 21R	10-17	62A-21-
22"	21HD	17-20	62A-21HD-
22"	21TG or 21XHD or 21XH	20-30	62A-21TG-
23"	22L	6-10	62A-22LT-

Continued on next page

END BRACKETS

Add suffix to complete part number.

-2

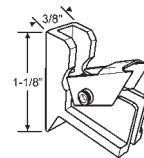

Part #	Color
62-502	White
62-511	Black

Locking Terminals Plastic with Metal Lock

-5

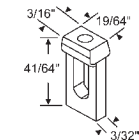

900-18354
Die Cast

-12

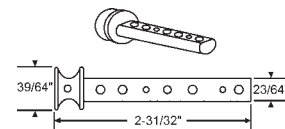

62-520
White

-14

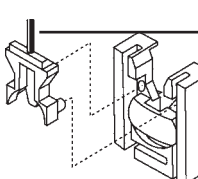

62-528
Die Cast

62-526
Sold and Attached Separately

-BC

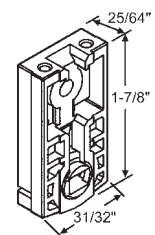

64T-506

-16

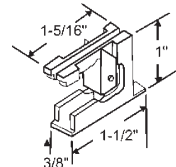

62-682
White

-17

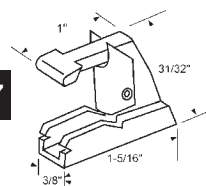

62-684B
Black

-35

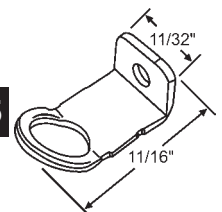

62-706
Steel

Continued from previous page.

Length of Metal Channel	Number Stamped on Balance	Weight Range	Our Part Number	Length of Metal Channel	Number Stamped on Balance	Weight Range	Our Part Number
23"	22 or 22R	10-18	62A-22-	38"	37 or 37R	15-24	62A-37-
23"	22HD	18-22	62A-22HD-	38"	37HD	24-29	62A-37HD-
23"	22TG or 22XHD or 22XH	22-30	62A-22TG-	38"	37TG or 37XHD or 37XH	29-38	62A-37TG-
24"	23L	6-10	62A-23LT-	39"	38L	10-15	62A-38LT-
24"	23 or 23R	10-18	62A-23-	39"	38 or 38R	15-24	62A-38-
24"	23HD	18-22	62A-23HD-	39"	38HD	24-29	62A-38HD-
24"	23TG or 23XHD or 23XH	22-30	62A-23TG-	39"	38TG or 38XHD or 38XH	29-38	62A-38TG-
25"	24L	6-10	62A-24LT-	40"	39L	10-15	62A-39LT-
25"	24 or 24R	10-18	62A-24-	40"	39 or 39R	15-25	62A-39-
25"	24HD	18-22	62A-24HD-	40"	39HD	25-30	62A-39HD-
25"	24TG or 24XHD or 24XH	22-30	62A-24TG-	40"	39TG or 38XHD or 39XH	30-38	62A-39TG-
26"	25L	6-10	62A-25LT-	41"	40L	10-15	62A-40LT-
26"	25 or 25R	10-20	62A-25-	41"	40 or 40R	15-25	62A-40-
26"	25TG or 25XHD or 25XH	24-30	62A-25TG-	41"	40HD	25-30	62A-40HD-
27"	26L	6-10	62A-26LT-	41"	40TG or 40XHD or 40XH	30-38	62A-40TG-
27"	26 or 26R	10-19	62A-26-	42"	41L	10-15	62A-41LT-
27"	26HD	19-24	62A-26HD-	42"	41 or 41R	15-25	62-41-
27"	26TG or 26XHD or 26XH	24-31	62A-26TG-	42"	41HD	25-30	62A-41HD-
28"	27L	6-10	62A-27LT-	42"	41TG or 41XHD or 41XH	30-38	62A-41TG-
28"	27 or 27R	10-19	62A-27-	43"	42L	10-15	62A-42LT-
28"	27HD	19-24	62A-27HD-	43"	42 or 42R	15-25	62A-42-
28"	27TG or 27XHD or 27XH	24-31	62A-27TG-	43"	42HD	25-30	62A-42HD-
29"	28L	10-15	62A-28L-	43"	42TG or 41XHD or 42XH	30-38	62A-42TG-
29"	28 or 28R	15-22	62A-28-	44"	43L	10-15	62A-43LT-
29"	28HD	22-28	62A-28HD-	44"	43 or 43R	15-25	62A-43-
29"	28TG or 28XHD or 28XH	28-35	62A-28TG-	44"	43HD	25-30	62A-43HD-
30"	29L	10-15	62A-29LT-	44"	43TG or 43XHD or 43XH	30-38	62A-43TG-
30"	29 or 29R	15-22	62A-29-	45"	44L	10-15	62A-44LT-
30"	29HD	22-28	62A-29HD-	45"	44 or 44R	15-25	62A-44-
30"	29TG or 29XHD or 29XH	28-35	62A-29TG-	45"	44HD	25-30	62A-44HD-
31"	30L	10-15	62A-30LT-	45"	44TG or 44XHD or 44XH	30-38	62A-44TG-
31"	30 or 30R	15-23	62A-30-	46"	45L	10-15	62A-45LT-
31"	30HD	23-29	62A-30HD-	46"	45 or 45R	15-25	62A-45-
31"	30TG or 30XHD or 30XH	29-36	62A-30TG-	46"	45HD	25-30	62A-45HD-
32"	31L	10-15	62A-31LT-	46"	45TG or 45XHD or 45XH	30-38	62A-45TG-
32"	31 or 31R	15-23	62A-31-	47"	46L	10-15	62A-46LT-
32"	31HD	23-29	62A-31HD-	47"	46 or 46R	15-25	62A-46-
32"	31TG or 31XHD or 31XH	29-36	62A-31TG-	47"	46HD	25-30	62A-46HD-
33"	32L	10-15	62A-32LT-	47"	46TG or 46XHD or 46XH	30-38	62A-46TG-
33"	32 or 32R	15-24	62A-32-	48"	47L	10-15	62A-47LT-
33"	32HD	24-29	62A-32HD-	48"	47 or 47R	15-25	62A-47-
33"	32TG or 32XHD or 32XH	29-36	62A-32TG-	48"	47HD	25-30	62A-47HD-
34"	33L	10-15	62A-33LT-	48"	47TG or 47XHD or 47XH	30-38	62A-47TG-
34"	33 or 33R	15-24	62A-33-	49"	48L	10-15	62A-48L
34"	33HD	24-29	62A-33HD-	49"	48 or 48R	15-25	62A-48-
34"	33TG or 33XHD or 33XH	29-36	62A-33TG-	49"	48HD	25-30	62A-48HD-
35"	34L	10-15	62A-34LT-	49"	48TG or 48XHD or 48XH	30-38	62A-48TG-
35"	34 or 34R	15-24	62A-34-	50"	49L	10-15	62A-49LT-
35"	34HD	24-29	62A-34HD-	50"	49 or 49R	15-25	62A-49-
35"	34TG or 34XHD or 34XH	29-36	62A-34TG-	50"	49HD	25-30	62A-49HD-
36"	35L	10-15	62A-35LT-	50"	49TG or 49XHD or 49XH	30-38	62A-49TG-
36"	35 or 35R	15-24	62A-35-	51"	50L	10-15	62A-50LT-
36"	35HD	24-29	62A-35HD-	51"	50 or 50R	15-25	62A-50-
36"	35TG or 35XHD or 35XH	29-36	62A-35TG-	51"	50HD	25-30	62A-50HD-
37"	36L	10-15	62A-36LT-	51"	50TG or 50XHD or 50XH	30-38	62A-50TG-
37"	36 or 36R	15-24	62A-36-	52"	51L	10-15	62A-51LT-
37"	36HD	24-29	62A-36HD-	52"	51 or 51R	15-25	62A-51-
37"	36TG or 36XHD or 36XH	29-38	62A-36TG-	52"	51HD	25-30	62A-51HD-
38"	37L	10-15	62A-37LT-	52"	51TG or 51XHD or 51XH	30-38	62A-51TG-

62 SERIES CHANNEL BALANCES ACCESSORIES

BALANCE ATTACHMENTS

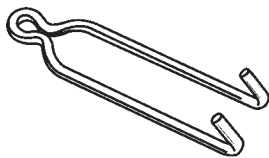

62-504

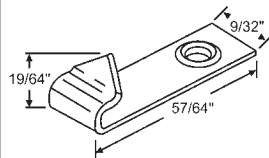

Part #	Description
60-518	1/32" Thick
60-518HD	3/64" Thick

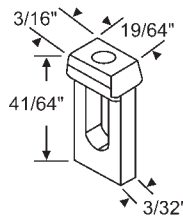

900-18354
Die Cast

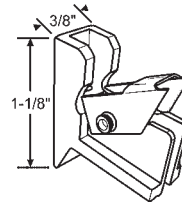

Part #	Color
62-502	White
62-511	Black

Locking Terminals
Plastic with Metal Lock

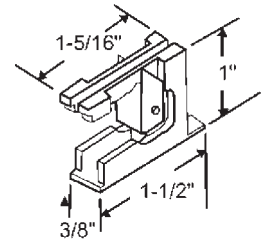

62-682

White Locking Terminals
Plastic with Metal Lock

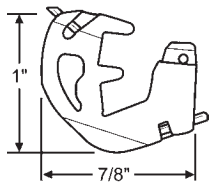

62-543
Wedge Locking Shoe
Only Available Attached to Balance

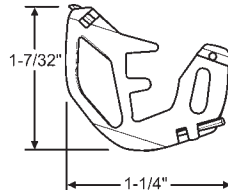

62-539
Channel Balance Wedge

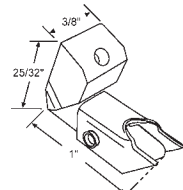

62-503
Locking Terminals
Plastic with Metal Lock

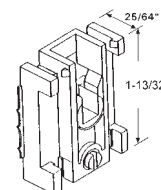

62-530
No Longer Available.
Use 64T-506

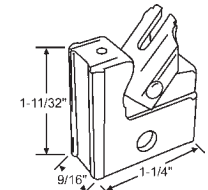

62-531
Zinc Die Cast
Magnum Locking Terminal
WEATHERSHIELD

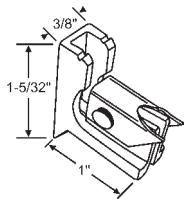

62-502SP
Locking Terminal Assembly
White

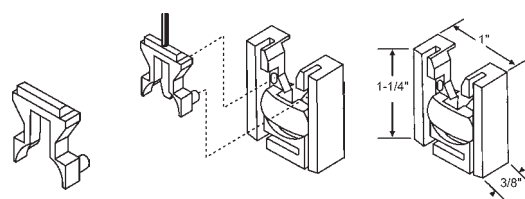

62-528
Die Cast
Tie Bar Guide

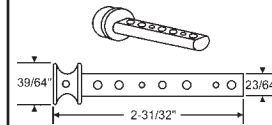

Part #	Color
62-520	White
62-521	Black

Plastic

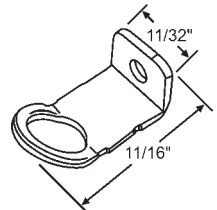

62-706
Steel
INTEK

"S" CLIPS

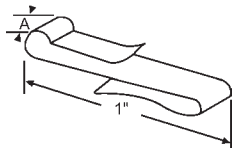

Part #	"A"
62-517	1/4"
62-517HD	3/8"

Short "S" Clip

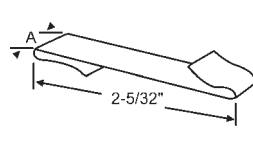

Part #	"A"
62-518	1/4"
62-518HD	3/8"

Long "S" Clip

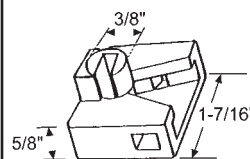

62-526

TERMINAL HOUSINGS

Part #	Hand	Use With
62-532	Shown	15/16" Cam
62-533	Opposite	15/16" Cam
62-535	Shown	5/8" Cam
62-534	Opposite	5/8" Cam

Housing Assembly.
Includes Cam and Shoe
GRAHAM

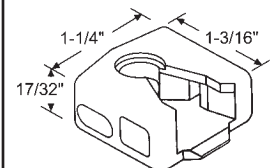

62-512
9/16" Dia. Hole
GRAHAM

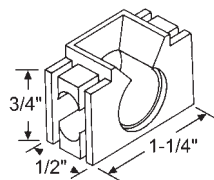

62-505

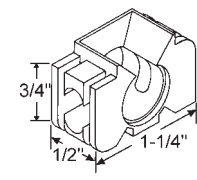

Part #	Hand
62-507	Shown
62-506	Opposite

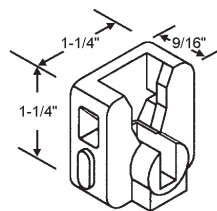

900-9312A

GRAHAM

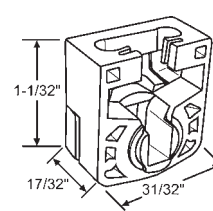

62-834
Front to Back 1"
SUPER SEAL

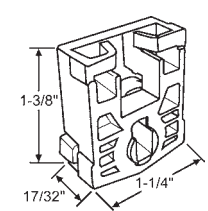

62-831
White Puck
THERMAL INDUSTRIES

SASH SUPPORT SYSTEMS

62 SERIES CHANNEL BALANCES ACCESSORIES

LOCKING CAMS

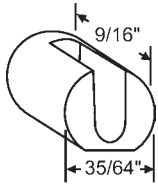

62-509
Die Cast

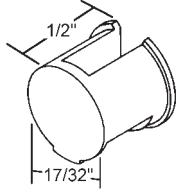

62-513
Die Cast

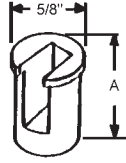

Part #	A
900-9447	15/16"
900-9447M	5/8"

Die Cast
GRAHAM

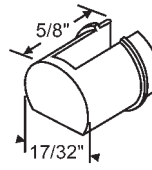

62-516
Die Cast

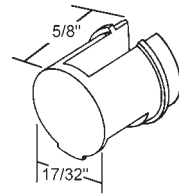

62-514
Die Cast

PIVOT RETAINERS

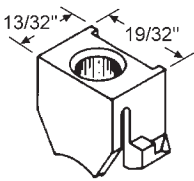

62-519
White Plastic

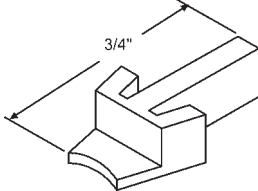

62-660
Non Take Out Retainer

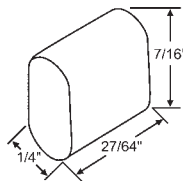

62-510
White

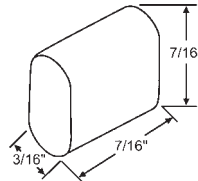

900-9310
Used with 62-532, 533, 534 & 535
GRAHAM

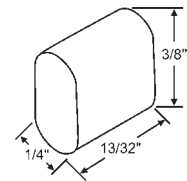

62-614
Black

BRAKE SHOES

PIVOT LOCK SHOES

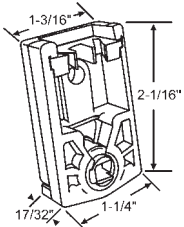

62-565

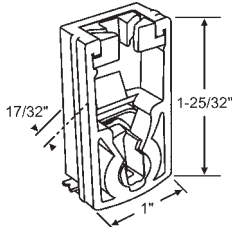

62-546

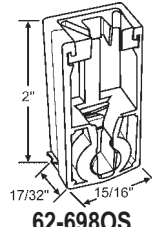

62-698OS
No Longer Available.
Use 62-698

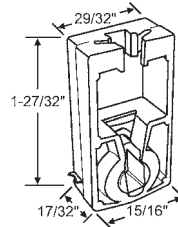

62-698
Will not work on spiral balances.

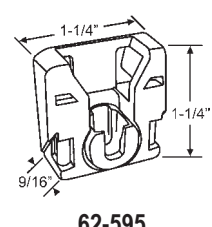

62-595
Pivot Lock Shoe with
Slate Blue Puck

OMEGA PIVOT LOCK SHOE

TILT STUDS

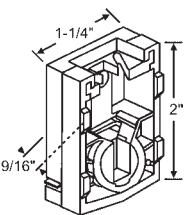

62-695
1.250" X .575" Metal .030" Spring
Zinc Plate

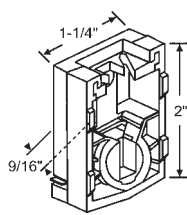

62-679
1.250" X .575" Metal Spring
Zinc Plate

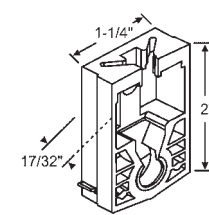

62-693
1.250" X .530" Metal Spring
Molded Plate

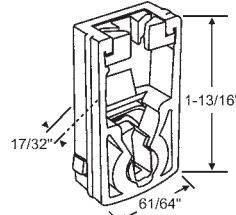

62-568
Molded Spring. Zinc Plate
GREAT LAKES

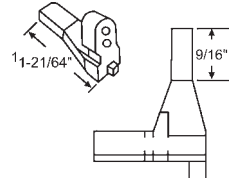

Part #	Hand
62-616	Shown
62-617	Opposite

Above item has Left/Right
marked on part. Die Cast

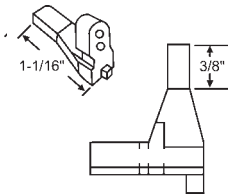

Part #	Hand
62-616	Shown
62-617	Opposite

Above item has Left/Right
marked on part. Die Cast

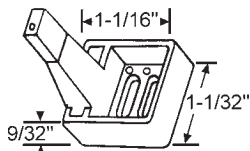

Part #	Hand
62-620	Shown
62-621	Opposite

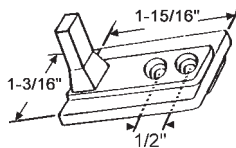

900-9443
Zinc

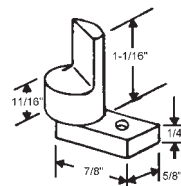

62-622A
Plastic Set
REPCO

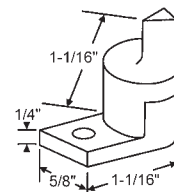

62-626
REPCO

62 SERIES CHANNEL BALANCES ACCESSORIES

TILT STUDS

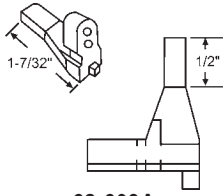

62-603A

LH & RH Set (LH Shown). Above item has Left/Right marked on part. Die Cast

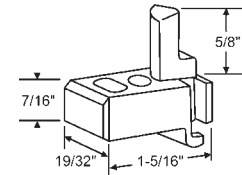

Part #	Hand
62-600	Shown
62-601	Opposite

Plastic

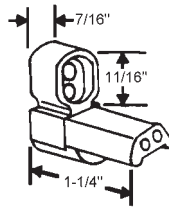

62-602
Plastic

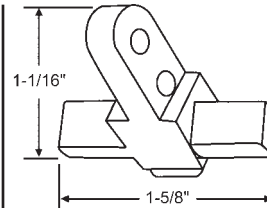

62-663
Tilt Stud Dual Arm
Die Cast

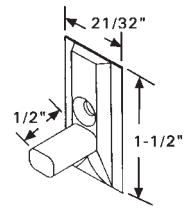

62-652
Die Cast
Square Plough

CAM PIVOTS

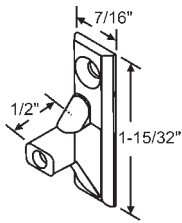

62-653R
Die Cast

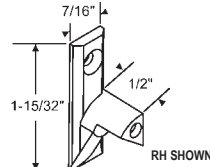

Part #	Hand	Description
62-649LW	LH	Natural Plastic
62-649RB	RH	Black Plastic
62-650RH	RH	Zinc
62-650LH	LH	Zinc

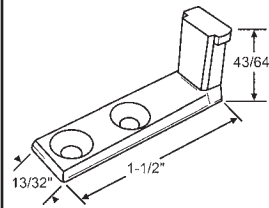

62-50078
Zinc Die Cast

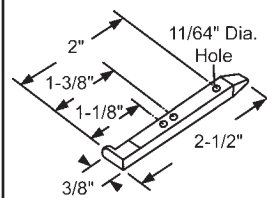

62-540F
Die Cast

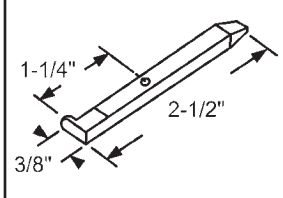

62-540
Non-Pull-Out. Die Cast

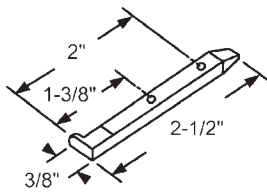

62-540A
Die Cast

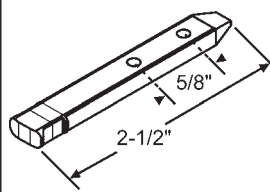

62-550
T-Head Pivot Bar Zinc

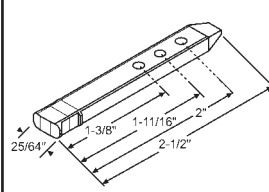

62-552
Zinc T-Pivot with Collar

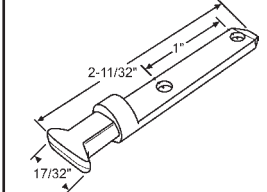

62-833
Die Cast
REPUBLIC

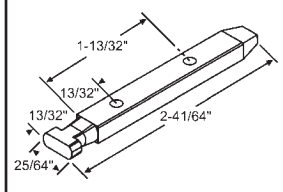

62-828
T-Head Pivot Bar
SIMONTON

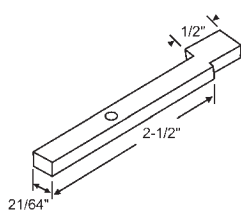

62-624
Die Cast

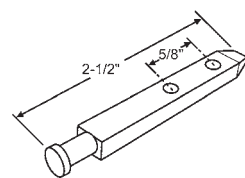

62-541
Zinc

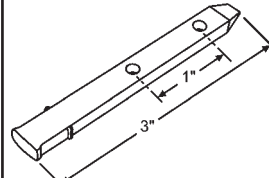

62-556
Zinc Die Cast
GTS

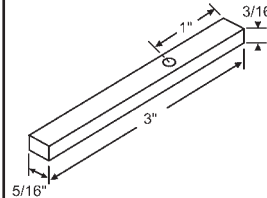

Part #	Description
900-14396	No Thread, Die Cast
900-13506	With Thread, Stainless Steel

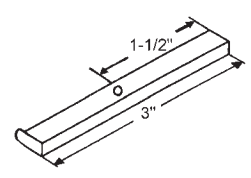

62-667
Zinc Die Cast

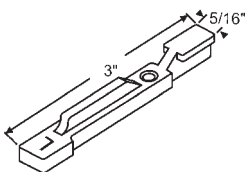

62-618A

Pivot Bar Set. 1 RH / 1 LH
LH Shown
ATRIUM/KINCO

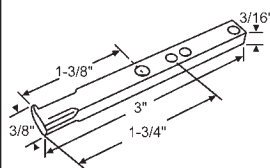

62-545

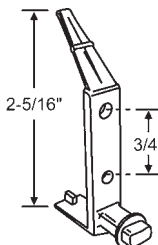

62-711

Pivot Bar Die cast
HARVEY

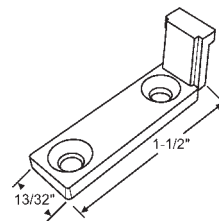

62-832
SCHERER

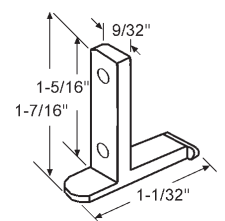

900-21862A

LH (shown). Sold in Sets Only
Die Cast

SASH SUPPORT SYSTEMS

62 SERIES CHANNEL BALANCES ACCESSORIES

SASH RETAINERS

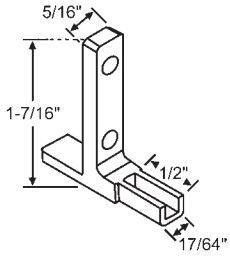

900-22082
Zinc Die Cast
REHAU

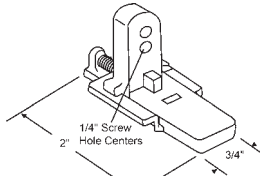

62-610
Black
Used with 62-602 and 62-501
NORANDEX

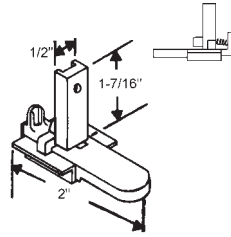

No Longer Available

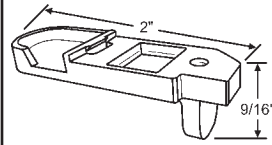

Part #	Hand
62-639	Shown
62-640	Opposite

Nylon Slide Only
For 62-636 & 62-637.

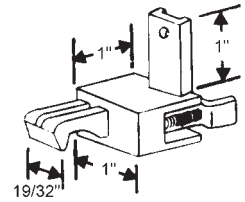

Part #	Hand
62-607	Shown
62-606	Opposite

HOWMET

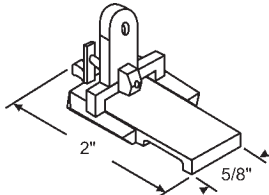

Part #	Hand
62-644	Shown
62-645	Opposite

Clear Plastic

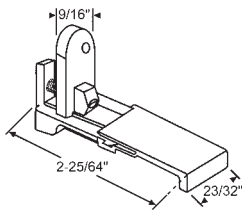

No Longer Available

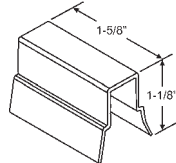

Part #	Color
62-702	White
62-702BG	Beige

Vinyl

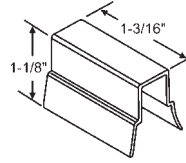

Part #	Color
62-701BG	Beige
62-701	White

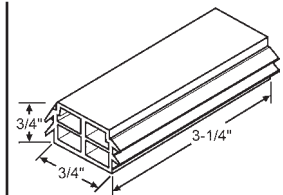

900-19369
Black Rubber Sash Stop

DUST CAP

SASH LOCK

BUSHINGS

INSTALLATION BRACKETS

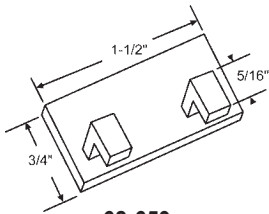

62-659
GRAHAM

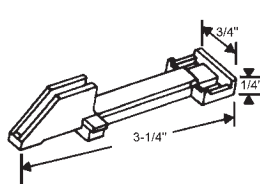

62-633
Lower
Nylon

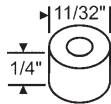

62-613
KELLER

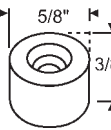

62-658
Metal
Mill Finish

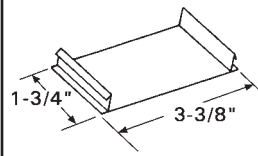

86-21
Vinyl Release

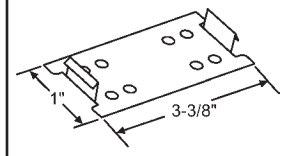

86-22
Metal

RELEASE LEVER

GUIDE

BALANCE STOP

INTERLOCKING PLUNGER

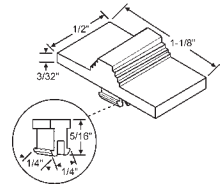

Part #	Color
62-643BR	Brown
62-643BG	Beige
62-643	White
62-643BL	Black

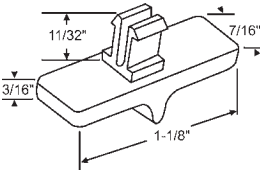

Part #	Finish
62-635	Natural
62-635B	Black

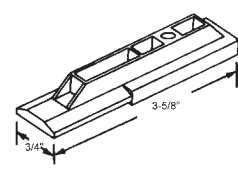

900-11376
GRAHAM

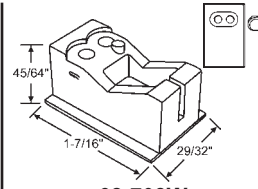

62-708W
White Balance Stop
62-709W
White Screw Cover

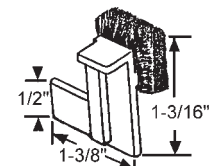

62-641BA
Black
Sold in Sets Only, RH Shown
AIRMASTER

64T SERIES TILT CHANNEL BALANCES ACCESSORIES

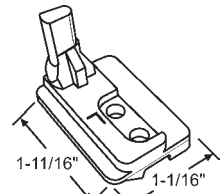

900-20924A
Pivot Assy. Set (LH Shown & Opposite)

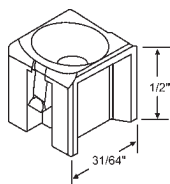

62-689
Mounting Screw Support

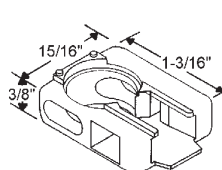

64T-500
Terminal Housing

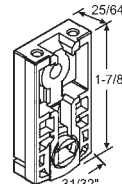

64T-506
Tie-On Balance Shoe

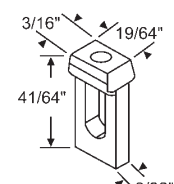

900-18354

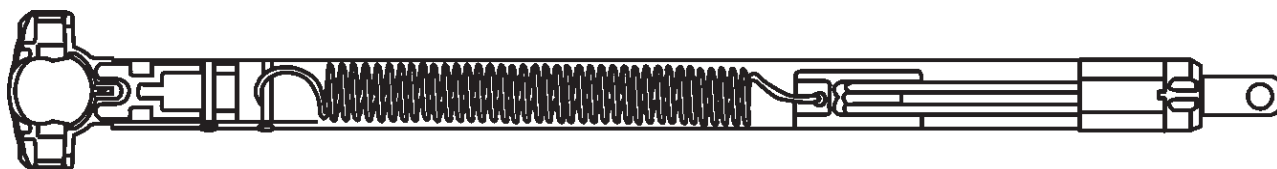

For Windows 36" or Less				For Windows Wider than 36"			
Length of Metal Channel	Number Stamped on Balance	Sash Weight	Our Part Number	Length of Metal Channel	Number Stamped on Balance	Sash Weight	Our Part Number
9"	900	3-10 LBS.	62-766-900-	9"	901	10-11 LBS.	62-766-901-
10"	1000	3-10 LBS.	62-766-1000-	10"	1001	10-11 LBS.	62-766-1001-
11"	1100	3-10 LBS.	62-766-1100-	11"	1101	10-11 LBS.	62-766-1101-
12"	1200	3-11 LBS.	62-766-1200-	12"	1201	11-13 LBS.	62-766-1201-
13"	1300	3-11 LBS.	62-766-1300-	13"	1301	11-13 LBS.	62-766-1301-
14"	1400	4-12 LBS.	62-766-1400-	14"	1401	12-15 LBS.	62-766-1401-
15"	1500	4-12 LBS.	62-766-1500-	15"	1501	12-15 LBS.	62-766-1501-
16"	1600	4-13 LBS.	62-766-1600-	16"	1601	13-16 LBS.	62-766-1601-
17"	1700	4-13 LBS.	62-766-1700-	17"	1701	13-16 LBS.	62-766-1701-
18"	1800	5-14 LBS.	62-766-1800-	18"	1801	14-18 LBS.	62-766-1801-
19"	1900	5-14 LBS.	62-766-1900-	19"	1901	14-18 LBS.	62-766-1901-
20"	2000	5-16 LBS.	62-766-2000-	20"	2001	16-19 LBS.	62-766-2001-
21"	2100	5-16 LBS.	62-766-2100-	21"	2101	16-19 LBS.	62-766-2101-
22"	2200	6-17 LBS.	62-766-2200-	22"	2201	17-21 LBS.	62-766-2201-
23"	2300	6-17 LBS.	62-766-2300-	23"	2301	17-21 LBS.	62-766-2301-
24"	2400	6-18 LBS.	62-766-2400-	24"	2401	18-23 LBS.	62-766-2401-
25"	2500	6-18 LBS.	62-766-2500-	25"	2501	18-23 LBS.	62-766-2501-
26"	2600	7-19 LBS.	62-766-2600-	26"	2601	19-24 LBS.	62-766-2601-
27"	2700	7-19 LBS.	62-766-2700-	27"	2701	19-24 LBS.	62-766-2701-
28"	2800	7-21 LBS.	62-766-2800-	28"	2801	21-26 LBS.	62-766-2801-
29"	2900	7-21 LBS.	62-766-2900-	29"	2901	21-26 LBS.	62-766-2901-
30"	3000	8-22 LBS.	62-766-3000-	30"	3001	22-28 LBS.	62-766-3001-
31"	3100	8-22 LBS.	62-766-3100-	31"	3101	22-28 LBS.	62-766-3101-
32"	3200	8-23 LBS.	62-766-3200-	32"	3201	23-29 LBS.	62-766-3201-
33"	3300	8-23 LBS.	62-766-3300-	33"	3301	23-29 LBS.	62-766-3301-
34"	3400	9-24 LBS.	62-766-3400-	34"	3401	24-31 LBS.	62-766-3401-
35"	3500	9-24 LBS.	62-766-3500-	35"	3501	24-31 LBS.	62-766-3501-
36"	3600	9-24 LBS.	62-766-3600-	36"	3601	25-32 LBS.	62-766-3601-
37"	3700	9-24 LBS.	62-766-3700-	37"	3701	25-32 LBS.	62-766-3701-
38"	3800	10-27 LBS.	62-766-3800-	38"	3801	27-33 LBS.	62-766-3801-
39"	3900	10-27 LBS.	62-766-3900-	39"	3901	27-33 LBS.	62-766-3901-
40"	4000	10-28 LBS.	62-766-4000-	40"	4001	28-34 LBS.	62-766-4001-
41"	4100	10-28 LBS.	62-766-4100-	41"	4101	28-34 LBS.	62-766-4101-
42"	4200	10-28 LBS.	62-766-4200-	42"	4201	28-34 LBS.	62-766-4201-
43"	4300	10-28 LBS.	62-766-4300-	43"	4301	28-34 LBS.	62-766-4301-
44"	4400	10-28 LBS.	62-766-4400-	44"	4401	28-34 LBS.	62-766-4401-

ORDERING INSTRUCTIONS FOR 62-716 & 62-766

Ordering Information

- 1) Measure metal channel length (Do not include any attached ends.)
- 2) Check number stamped on channel: e.g., 23C, 29A etc.
- 3) Select our corresponding part number from chart on previous page or above.
- 4) Select clip from list on next page and add suffix to end of part number.
- 5) Select the appropriate "T" lock option from next page and add suffix to end of part number.

Example Ordering Chart

Channel Length	Number Stamped on Balance	Our Part Number	Clip Attached	Tilt Shoe Attached	Complete Part Number
28"	28A	62-716-28A-	60-950	62-50007	62-716-28A-34C

**These balances are special order
Contact Your Account Manager For Delivery Schedules**

62-716 & 62-766 SERIES BALANCES ACCESSORIES

CLIPS

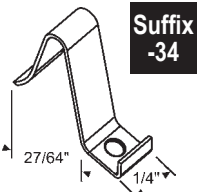

**Suffix
-34**

60-950

Form Fit Hanger
Use with Traditional Pulley

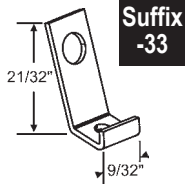

**Suffix
-33**

60-937

Form Fit Screw-in
Use with Traditional Pulley



**Suffix
-20**

60-952

No Longer Available
Use 60-951

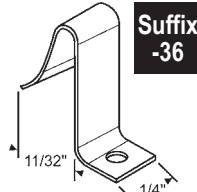

**Suffix
-36**

62-50041

Hanger
Use with Reverse Lace

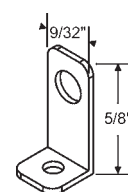

**Suffix
-19**

60-951

Screw-in
Use with Reverse Lace



**Suffix
-31**

62-50051

Hanger
Use with Reverse Lace

TILT SHOES

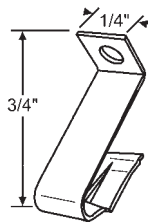

**Suffix
-38**

60-965
Not Sold Separately
REPUBLIC

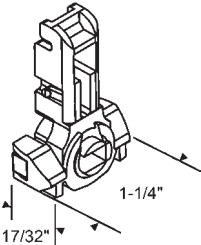

Part #	Puck Color	Cam	Suffix
62-50001	Red	Closed	G
62-50002	White	Open	H
62-50003	White	Closed	D
62-50004	Black	Closed	I
62-50005	Blue	Closed	B
62-50015	Black	Open	J

T-Lock/Molded Spring
Stamped Pivot

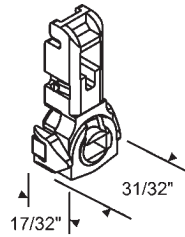

Part #	*Puck Color	Cam	Suffix
62-50006	Green	Closed	A
62-50007	Green	Open	C

T-Lock

*Puck and the sides that extend

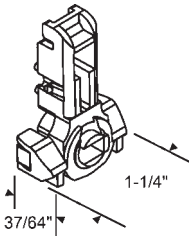

Part #	Puck Color	Cam	Suffix
62-50008	White	Closed	K

No Longer Available
Use 62-5003, Suffix D

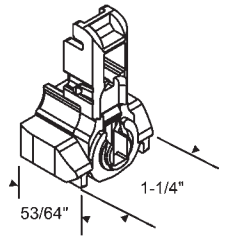

Part #	Puck Color	Cam	Suffix
62-50012	Tan	Open	P

Front-to-Back T-Lock
Twin Cam

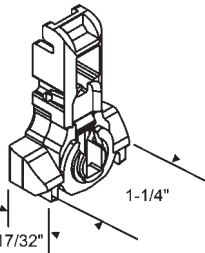

Part #	Puck Color	Cam	Suffix
62-50011	Tan	Open	N

Front-to-Back T-Lock
No Longer Available.
Use 62-50002

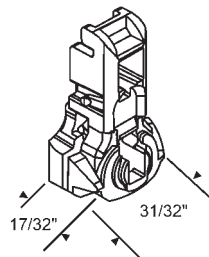

Part #	Puck Color	Cam	Suffix
62-50033	Black	Open	W

Front-to-Back T-Lock

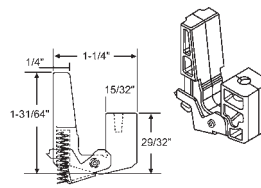

Part #	Suffix
62-50016	AU

Sure Lock
JELD-WEN



**Suffix
M**

62-50013
Inverted Link
Used with 62-50014

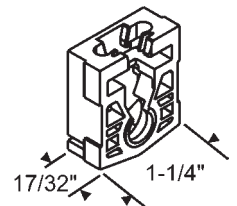

62-50014
Sold Separately

PIVOT SHOE

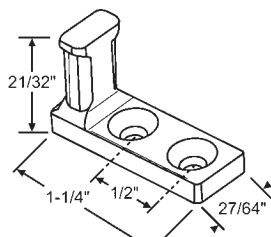

62-824

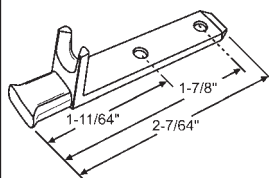

62-825

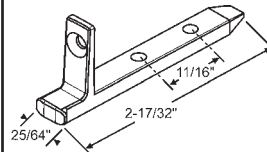

62-50046

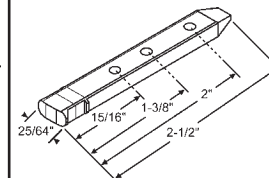

62-826

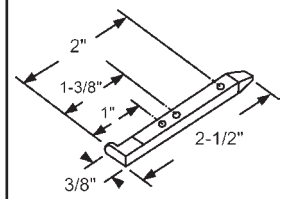

62-540D
No Longer Available
Use 62-540K

PIVOT BARS

SASH SUPPORT SYSTEMS

62-716 & 62-766 SERIES BALANCES ACCESSORIES

PIVOT BARS

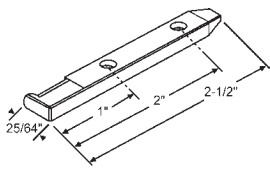

62-540K

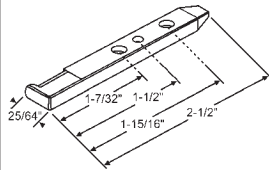

62-540H

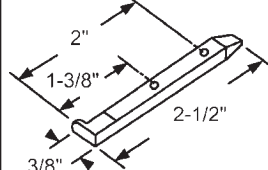

62-540A

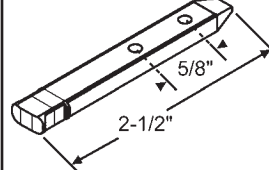

62-550

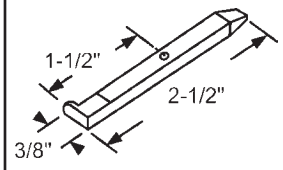

62-540B

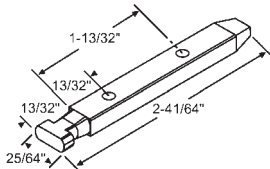

62-828

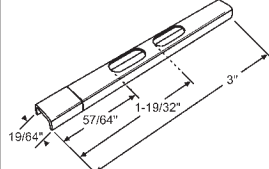

62-827

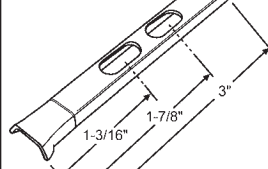

62-544

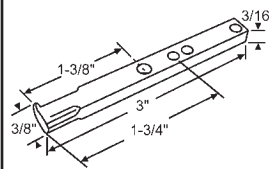

62-545

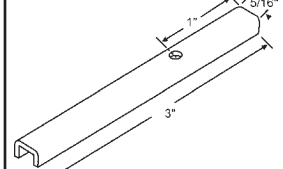

900-14309

ADHESIVE SEALANT

Soudal

Part #	Color	Size
59-137W	White	10.1 oz. Tube
59-137	Clear	10.1 oz. Tube
59-138W	White	20 oz. Sausage

Silirub N1 is a Premium Grade 100%, Neutral Cure Silicone

Characteristics:

- Permanent color
- UV resistant
- Excellent moisture and mold resistance.
- Stays fully elastic after curing
- Good adhesion on many materials
- Easy application
- Medium modulus
- Movement up to +/- 25%

Applications:

- Building and construction joints
- Top sealing at glazing jobs
- Suitable as back bedding compound as well as weather sealant
- Joints with high movement between different building materials
- Sealing between treated wood, metal, PVC profiles and glass

Surfaces:

- Type: all usual building surfaces
- State of surface: clean, dry, free of dust and grease
- Preparation: Prime porous surfaces with Primer, no primer required for non-porous surfaces.

We recommend a preliminary compatibility test, especially on PVD and powder coated materials.

Note: Custom Color Matching Available. Three Case Minimum (12 Per Case). Check with Your Account Manager for Available Colors and Lead Times.



GLASS CLEANER



59-101
19 oz. can
12 cans per case

Foaming Glass Cleaner

- Industrial Strength
- The most versatile glass cleaner available
- Cleans glass, windows, mirrors, windshields, enamel surfaces, chrome, tile, porcelain and other hard surfaces.
- Sprays in any position
- Dissolves dirt, grease, grit and grime
- Heavy-Duty Foam clings to vertical surfaces
- Non-ammoniated
- Guaranteed to leave no film - "Streak Free"
- Safe on tinted glass, plastic and mirrors
- Contains cosmetic-grade alcohol for best performance
- Superior quality at competitive pricing
- Patent Pending Formulation

Spray X Glass Cleaner contains less water and more cleaning power. Our patent pending formulation allows us to meet the current VOC regulations and deliver maximum cleaning performance for our customers. Compare our alcohol content to other national brands and you'll notice our quality is significantly higher

Spray X Glass Cleaner uses SD-40B cosmetic grade alcohol that is 200 proof and 99.9% pure. This type of alcohol requires a registration with the US Department of Alcohol, Tobacco and Firearms, and each Spray-X Glass Cleaner can is marked with our registration number. Compare our registration to other brands and you'll quickly agree this product has been performance engineered to meet all your glass cleaning needs.

Spray X Glass Cleaner for cleaning and polishing glass, mirrors and other nonporous surfaces. This easy-to-use, fast-acting product uses clinging foam to break up soils and hold them -even on vertical surfaces. There's no dripping, no running and no streaking. With an exclusive industrial strength formulation, this product cleans thoroughly, dries quickly, requires no rinsing and leaves a pleasant, fresh aroma.

Spray-X Glass Cleaner utilizes a 360 degree valve for ease of use. This allows our product to be sprayed right side up or upside down. Other brands cannot spray upside down, but we have this solid valve feature, plus the anti-fatigue finger pad makes this packaging very attractive to all users.

Spray-X Glass Cleaner is alcohol based. It does not contain ammonia. When comparing our performance on tinted glass to ammoniated brands most professional installers praise the difference.

Spray-X Glass Cleaner is packaged in a two-piece steel can. No side seam means we use less energy and material and generate less waste. Our can weighs 10% less than the three-piece equivalent and is 100% recyclable. You will appreciate the new contemporary can design.

62DV SERIES DEVAC OVERHEAD CHANNEL BALANCES

Single Spring Channel - Aluminum 9/16" Wide x 5/8" Deep
 Double Spring Channel - Aluminum 9/16" Wide x 13/16" Deep

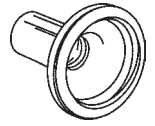
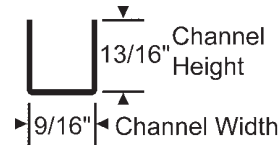
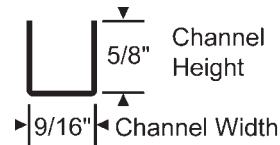
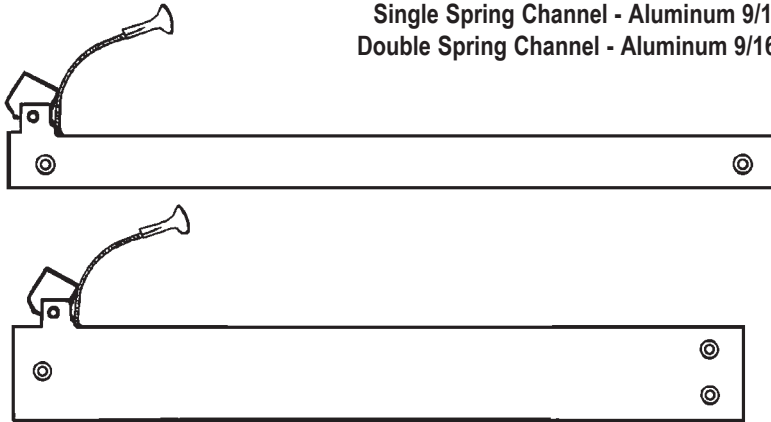

900-9036
Standard Bell Clip Attached

Ordering Information

- 1) Measure metal channel length.
- 2) Check number old or new stamped on balance (e.g. 111 or 1210).
- 3) Select our corresponding part number from the chart below and order accordingly.
- 4) All balances come with 900-9036 attached.

General Information

- 1) All balances now use Dacron cord. Stainless steel cable with copper hook terminal is no longer being produced.
- 2) It is important to note how much cord extends from your balance to the window sill (in inches) in order to ensure the proper amount of cord travel. Our chart will indicate standard lengths but if additional inches of cord are required, add a plus (+) sign after the part number and indicate the number of extra inches of cord required.
- 3) When the letter "D" alone is stamped on your balance, it denotes a double spring. "HD", on the other hand, simply denotes heavy duty.

**Note: Minimum order required for this series.
 Must order minimum of four (4) of the same size balance.**

Old Balance Number	Old Balance Length	New Balance Number	New Balance Length	Standard Cord Length in Balance	Sash Weight Per Pair	Our Part #
111	12-3/4"	1210 HD	13"	31"	4-7 lbs.	62DV-1210HD
112	12-3/4"	1220 HD	13"	31"	7-11 lbs.	62DV-1220HD
112-D	13-1/4"	112 D	13-1/4"	36"	11-18 lbs.	62DV-112D
121	15-1/4"	1510 HD	16"	37"	5-9 lbs.	62DV-1510HD
122	15-1/4"	1520 HD	16"	37"	9-13 lbs.	62DV-1520HD
122-D	16-1/4"	122-D	16-1/4"	42"	12-22 lbs.	62DV-122D
151	19-1/4"	1910 HD	20"	41"	5-11 lbs.	62DV-1910HD
152	19-1/4"	1920 HD	20"	41"	8-14 lbs.	62DV-1920HD
153	19-1/4"	1930 HD	20"	41"	14-18 lbs.	62DV-1930HD
153-D	19-3/4"	153-D	19-3/4"	47"	16-28 lbs.	62DV-153D
162	23-1/4"	2320 HD	24"	47"	9-14 lbs.	62DV-2320HD
163	23-1/4"	2330 HD	24"	47"	12-20 lbs.	62DV-2330HD
163-D	23-1/4"	163-D	23-3/4"	53"	20-32 lbs.	62DV-163D
183	27-1/4"	2730 HD	28"	50"	16-25 lbs.	62DV-2730HD
183-D	28-1/4"	183-D	28-1/4"	58"	22-34 lbs.	62DV-183D

DEVAC SASH STOPS 900-10445B 2 Piece Set - Black, Aluminum	PIN LOCKING SPRING 900-14913	LOCKING PINS <table border="1"> <thead> <tr> <th>Part #</th> <th>A</th> </tr> </thead> <tbody> <tr> <td>900-9678</td> <td>2-1/4"</td> </tr> <tr> <td>900-9677</td> <td>2-1/2"</td> </tr> </tbody> </table>	Part #	A	900-9678	2-1/4"	900-9677	2-1/2"	CUSHION BLOCK SPRING 900-9676	NYLON CUSHION SHOE 900-10443 Red	NYLON CUSHION BLOCK 900-9675 Red
Part #	A										
900-9678	2-1/4"										
900-9677	2-1/2"										
NYLON BALANCE CUSHION 900-10442 Red	PIN LOCK SCREW 900-10444	LATCH ASSEMBLY HOUSING 900-9674	PIN LOCKING HANDLE 900-9679 Black	SASH CLIPS 900-15841	SPRING 900-14743						

SASH SUPPORT SYSTEMS

62FC SERIES 1/2" X 1/2" TILT CHANNEL BALANCE

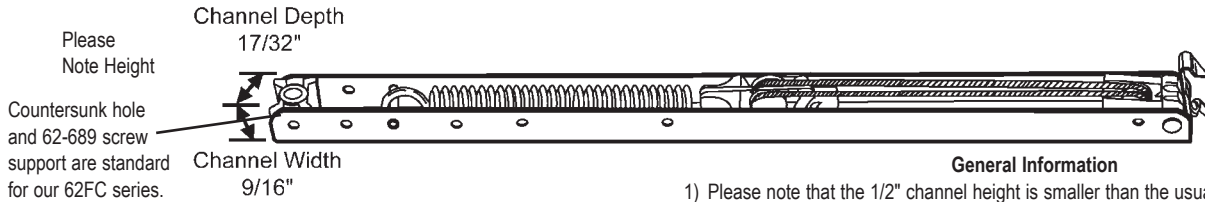

Ordering Information

- 1) Measure metal channel length (Do not include any attached ends).
- 2) Identify number stamped on channel. (e.g., 21A, 24B, etc.)
- 3) Select our corresponding part number from the chart below.
- 4) Identify the appropriate balance end to be attached; add the appropriate suffix -1 (60-518) or -5 (900-18354) after the part number and order accordingly.
- 5) If the letter "T" appears after the number stamped, it indicates a top sash balance; when ordering, add the letter "T" at the end of our part number.

General Information

- 1) Please note that the 1/2" channel height is smaller than the usual 19/32" height on standard balances.
- 2) If metal channel length does not correspond with the number stamped on balance, consult your representative since your balance may be a special order.

Example Ordering Chart

Channel Length	Number Stamped	Part Number	End Attached	Complete Part Number
21"	21A	62FC-21A	-1	62FC-21A-1
24"	24B	62FC-24B	-5	62FC-24B-5

Length of Metal Channel	Number Stamped on Balance	Sash Weight	Our Part Number	Length of Metal Channel	Number Stamped on Balance	Sash Weight	Our Part Number
10"	10A	2-6 lbs.	62FC-10A-	18"	18A	4-9 lbs.	62FC-18A-
10"	10B	6-10 lbs.	62FC-10B-	18"	18B	9-13 lbs.	62FC-18B-
10"	10C	10-13 lbs.	62FC-10C-	18"	18C	13-18 lbs.	62FC-18C-
11"	11A	3-7 lbs.	62FC-11A-	18"	18D	18-21 lbs.	62FC-18D-
11"	11B	7-10 lbs.	62FC-11B-	18"	18E	21-24 lbs.	62FC-18E-
11"	11C	10-16 lbs.	62FC-11C-	18"	18F	24-26 lbs.	62FC-18F-
11"	11D	16-18 lbs.	62FC-11D-	18"	18G	26-29 lbs.	62FC-18G-
12"	12A	3-7 lbs.	62FC-12A-	18"	18H	29-32 lbs.	62FC-18H-
12"	12B	7-10 lbs.	62FC-12B-	18"	18I	32-34 lbs.	62FC-18I-
12"	12C	10-16 lbs.	62FC-12C-	19"	19A	4-9 lbs.	62FC-19A-
12"	12D	16-18 lbs.	62FC-12D-	19"	19B	9-13 lbs.	62FC-19B-
13"	13A	3-7 lbs.	62FC-13A-	19"	19C	13-18 lbs.	62FC-19C-
13"	13B	7-10 lbs.	62FC-13B-	19"	19D	18-21 lbs.	62FC-19D-
13"	13C	10-16 lbs.	62FC-13C-	19"	19E	21-24 lbs.	62FC-19E-
13"	13D	16-18 lbs.	62FC-13D-	19"	19F	24-26 lbs.	62FC-19F-
14"	14A	3-7 lbs.	62FC-14A-	19"	19G	26-29 lbs.	62FC-19G-
14"	14B	7-10 lbs.	62FC-14B-	19"	19H	29-32 lbs.	62FC-19H-
14"	14C	10-16 lbs.	62FC-14C-	19"	19I	32-34 lbs.	62FC-19I-
14"	14D	16-19 lbs.	62FC-14D-	20"	20A	5-10 lbs.	62FC-20A-
14"	14E	19-22 lbs.	62FC-14E-	20"	20B	10-14 lbs.	62FC-20B-
14"	14F	22-25 lbs.	62FC-14F-	20"	20C	14-18 lbs.	62FC-20C-
14"	14G	25-28 lbs.	62FC-14G-	20"	20D	18-22 lbs.	62FC-20D-
14"	14H	28-31 lbs.	62FC-14H-	20"	20E	22-26 lbs.	62FC-20E-
14"	14I	31-34 lbs.	62FC-14I-	20"	20F	26-30 lbs.	62FC-20F-
15"	15A	3-7 lbs.	62FC-15A-	20"	20G	30-34 lbs.	62FC-20G-
15"	15B	7-10 lbs.	62FC-15B-	20"	20H	34-37 lbs.	62FC-20H-
15"	15C	10-16 lbs.	62FC-15C-	20"	20I	37-40 lbs.	62FC-20I-
15"	15D	16-19 lbs.	62FC-15D-	21"	21A	5-10 lbs.	62FC-21A-
15"	15E	19-22 lbs.	62FC-15E-	21"	21B	10-14 lbs.	62FC-21B-
15"	15F	22-25 lbs.	62FC-15F-	21"	21C	14-18 lbs.	62FC-21C-
15"	15G	25-28 lbs.	62FC-15G-	21"	21D	18-22 lbs.	62FC-21D-
15"	15H	28-31 lbs.	62FC-15H-	21"	21E	22-26 lbs.	62FC-21E-
15"	15I	31-34 lbs.	62FC-15I-	21"	21F	26-30 lbs.	62FC-21F-
16"	16A	3-7 lbs.	62FC-16A-	21"	21G	30-34 lbs.	62FC-21G-
16"	16B	7-10 lbs.	62FC-16B-	21"	21H	34-37 lbs.	62FC-21H-
16"	16C	10-16 lbs.	62FC-16C-	21"	21I	37-40 lbs.	62FC-21I-
16"	16D	16-19 lbs.	62FC-16D-	22"	22A	5-10 lbs.	62FC-22A-
16"	16E	19-22 lbs.	62FC-16E-	22"	22B	10-14 lbs.	62FC-22B-
16"	16F	22-24 lbs.	62FC-16F-	22"	22C	14-18 lbs.	62FC-22C-
16"	16G	24-28 lbs.	62FC-16G-	22"	22D	18-22 lbs.	62FC-22D-
16"	16H	28-31 lbs.	62FC-16H-	22"	22E	22-26 lbs.	62FC-22E-
16"	16I	31-34 lbs.	62FC-16I-	22"	22F	26-30 lbs.	62FC-22F-
17"	17A	3-7 lbs.	62FC-17A-	22"	22G	30-34 lbs.	62FC-22G-
17"	17B	7-10 lbs.	62FC-17B-	22"	22H	34-37 lbs.	62FC-22H-
17"	17C	10-16 lbs.	62FC-17C-	22"	22I	37-40 lbs.	62FC-22I-
17"	17D	16-19 lbs.	62FC-17D-	23"	23A	5-10 lbs.	62FC-23A-
17"	17E	19-22 lbs.	62FC-17E-	23"	23B	10-14 lbs.	62FC-23B-
17"	17F	22-24 lbs.	62FC-17F-	23"	23C	14-18 lbs.	62FC-23C-
17"	17G	24-28 lbs.	62FC-17G-	23"	23D	18-22 lbs.	62FC-23D-
17"	17H	28-31 lbs.	62FC-17H-	23"	23E	22-26 lbs.	62FC-23E-
17"	17I	31-34 lbs.	62FC-17I-	23"	23F	26-30 lbs.	62FC-23F-

END BRACKETS

Add suffix to complete part number.

-1



60-518

-5

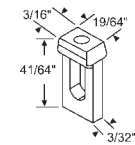

900-18354

-11

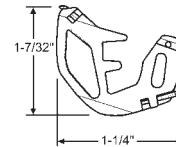

62-539

-18

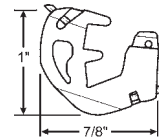

62-543

-24

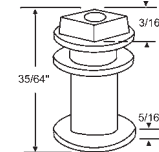

62-50018

Note: Old manufacturer (Jim Walters) of this series balance stamped it with a four digit number (e.g. 2130). These balances are no longer manufactured with that stamping. To identify your balance and match up properly with the new manufacturer's balances, you must take the following steps:

1. Measure exact length of channel.
2. Identify the weight range you require.
 - Weighing your sash is the only way to get the exact weight range required.
 - The old balance with the 4 digit number has a different weight range than the new balances.
 - Consult your account manager if you have any questions.
3. Select our corresponding part number from the chart.
4. Identify the appropriate balance end that needs to be attached.

Chart continued on next page.

62FC SERIES 1/2" X 1/2" TILT CHANNEL BALANCE

Chart continued from previous page.

Length of Metal Channel	Number Stamped on Balance	Sash Weight	Our Part Number	Length of Metal Channel	Number Stamped on Balance	Sash Weight	Our Part Number	Length of Metal Channel	Number Stamped on Balance	Sash Weight	Our Part Number
23"	23G	30-34 lbs.	62FC-23G-	31"	31C	19-24 lbs.	62FC-31C-	38"	38H	40-43 lbs.	62FC-38H-
23"	23H	34-37 lbs.	62FC-23H-	31"	31D	24-29 lbs.	62FC-31D-	38"	38I	43-45 lbs.	62FC-38I-
23"	23I	37-40 lbs.	62FC-23I-	31"	31E	29-33 lbs.	62FC-31E-	39"	39A	11-16 lbs.	62FC-39A-
24"	24A	6-11 lbs.	62FC-24A-	31"	31F	33-37 lbs.	62FC-31F-	39"	39B	16-22 lbs.	62FC-39B-
24"	24B	11-17 lbs.	62FC-24B-	31"	31G	37-40 lbs.	62FC-31G-	39"	39C	22-27 lbs.	62FC-39C-
24"	24C	17-22 lbs.	62FC-24C-	31"	31H	40-43 lbs.	62FC-31H-	39"	39D	27-32 lbs.	62FC-39D-
24"	24D	22-25 lbs.	62FC-24D-	31"	31I	43-45 lbs.	62FC-31I-	39"	39E	32-34 lbs.	62FC-39E-
24"	24E	25-28 lbs.	62FC-24E-	32"	32A	8-14 lbs.	62FC-32A-	39"	39F	34-37 lbs.	62FC-39F-
24"	24F	28-30 lbs.	62FC-24F-	32"	32B	14-20 lbs.	62FC-32B-	39"	39G	37-40 lbs.	62FC-39G-
24"	24G	30-34 lbs.	62FC-24G-	32"	32C	20-25 lbs.	62FC-32C-	39"	39H	40-43 lbs.	62FC-39H-
24"	24H	34-37 lbs.	62FC-24H-	32"	32D	25-30 lbs.	62FC-32D-	39"	39I	43-45 lbs.	62FC-39I-
24"	24I	37-40 lbs.	62FC-24I-	32"	32E	30-34 lbs.	62FC-32E-	40"	40A	11-16 lbs.	62FC-40A-
25"	25A	6-11 lbs.	62FC-25A-	32"	32F	34-37 lbs.	62FC-32F-	40"	40B	16-22 lbs.	62FC-40B-
25"	25B	11-17 lbs.	62FC-25B-	32"	32G	37-40 lbs.	62FC-32G-	40"	40C	22-27 lbs.	62FC-40C-
25"	25C	17-22 lbs.	62FC-25C-	32"	32H	40-43 lbs.	62FC-32H-	40"	40D	27-32 lbs.	62FC-40D-
25"	25D	22-25 lbs.	62FC-25D-	32"	32I	43-45 lbs.	62FC-32I-	40"	40E	32-34 lbs.	62FC-40E-
25"	25E	25-28 lbs.	62FC-25E-	33"	33A	8-14 lbs.	62FC-33A-	40"	40F	34-37 lbs.	62FC-40F-
25"	25F	28-30 lbs.	62FC-25F-	33"	33B	14-20 lbs.	62FC-33B-	40"	40G	37-40 lbs.	62FC-40G-
25"	25G	30-34 lbs.	62FC-25G-	33"	33C	20-25 lbs.	62FC-33C-	40"	40H	40-43 lbs.	62FC-40H-
25"	25H	34-37 lbs.	62FC-25H-	33"	33D	25-30 lbs.	62FC-33D-	40"	40I	43-45 lbs.	62FC-40I-
25"	25I	37-40 lbs.	62FC-25I-	33"	33E	30-34 lbs.	62FC-33E-	41"	41A	11-16 lbs.	62FC-41A-
26"	26A	6-11 lbs.	62FC-26A-	33"	33F	34-37 lbs.	62FC-33F-	41"	41B	16-22 lbs.	62FC-41B-
26"	26B	11-17 lbs.	62FC-26B-	33"	33G	37-40 lbs.	62FC-33G-	41"	41C	22-27 lbs.	62FC-41C-
26"	26C	17-22 lbs.	62FC-26C-	33"	33H	40-43 lbs.	62FC-33H-	41"	41D	27-32 lbs.	62FC-41D-
26"	26D	22-26 lbs.	62FC-26D-	33"	33I	43-45 lbs.	62FC-33I-	41"	41E	32-34 lbs.	62FC-41E-
26"	26E	26-30 lbs.	62FC-26E-	34"	34A	11-16 lbs.	62FC-34A-	41"	41F	34-37 lbs.	62FC-41F-
26"	26F	30-34 lbs.	62FC-26F-	34"	34B	16-22 lbs.	62FC-34B-	41"	41G	37-40 lbs.	62FC-41G-
26"	26G	34-38 lbs.	62FC-26G-	34"	34C	22-27 lbs.	62FC-34C-	41"	41H	40-43 lbs.	62FC-41H-
26"	26H	38-42 lbs.	62FC-26H-	34"	34D	27-32 lbs.	62FC-34D-	41"	41I	43-45 lbs.	62FC-41I-
26"	26I	42-45 lbs.	62FC-26I-	34"	34E	32-34 lbs.	62FC-34E-	42"	42A	11-16 lbs.	62FC-42A-
27"	27A	6-11 lbs.	62FC-27A-	34"	34F	34-37 lbs.	62FC-34F-	42"	42B	16-22 lbs.	62FC-42B-
27"	27B	11-17 lbs.	62FC-27B-	34"	34G	37-40 lbs.	62FC-34G-	42"	42C	22-27 lbs.	62FC-42C-
27"	27C	17-22 lbs.	62FC-27C-	34"	34H	40-43 lbs.	62FC-34H-	42"	42D	27-32 lbs.	62FC-42D-
27"	27D	22-26 lbs.	62FC-27D-	34"	34I	43-45 lbs.	62FC-34I-	42"	42E	32-34 lbs.	62FC-42E-
27"	27E	26-30 lbs.	62FC-27E-	35"	35A	11-16 lbs.	62FC-35A-	42"	42F	34-37 lbs.	62FC-42F-
27"	27F	30-34 lbs.	62FC-27F-	35"	35B	16-22 lbs.	62FC-35B-	42"	42G	37-40 lbs.	62FC-42G-
27"	27G	34-38 lbs.	62FC-27G-	35"	35C	22-27 lbs.	62FC-35C-	42"	42H	40-43 lbs.	62FC-42H-
27"	27H	38-42 lbs.	62FC-27H-	35"	35D	27-32 lbs.	62FC-35D-	42"	42I	43-45 lbs.	62FC-42I-
27"	27I	42-45 lbs.	62FC-27I-	35"	35E	32-34 lbs.	62FC-35E-	43"	43A	11-16 lbs.	62FC-43A-
28"	28A	7-12 lbs.	62FC-28A-	35"	35F	34-37 lbs.	62FC-35F-	43"	43B	16-22 lbs.	62FC-43B-
28"	28B	12-18 lbs.	62FC-28B-	35"	35G	37-40 lbs.	62FC-35G-	43"	43C	22-27 lbs.	62FC-43C-
28"	28C	18-23 lbs.	62FC-28C-	35"	35H	40-43 lbs.	62FC-35H-	43"	43D	27-32 lbs.	62FC-43D-
28"	28D	23-28 lbs.	62FC-28D-	35"	35I	43-45 lbs.	62FC-35I-	43"	43E	32-34 lbs.	62FC-43E-
28"	28E	28-32 lbs.	62FC-28E-	36"	36A	11-16 lbs.	62FC-36A-	43"	43F	34-37 lbs.	62FC-43F-
28"	28F	32-36 lbs.	62FC-28F-	36"	36B	16-22 lbs.	62FC-36B-	43"	43G	37-40 lbs.	62FC-43G-
28"	28G	36-40 lbs.	62FC-28G-	36"	36C	22-27 lbs.	62FC-36C-	43"	43H	40-43 lbs.	62FC-43H-
28"	28H	40-43 lbs.	62FC-28H-	36"	36D	27-32 lbs.	62FC-36D-	43"	43I	43-45 lbs.	62FC-43I-
28"	28I	43-45 lbs.	62FC-28I-	36"	36E	32-34 lbs.	62FC-36E-	44"	44A	11-16 lbs.	62FC-44A-
29"	29A	7-12 lbs.	62FC-29A-	36"	36F	34-37 lbs.	62FC-36F-	44"	44B	16-22 lbs.	62FC-44B-
29"	29B	12-18 lbs.	62FC-29B-	36"	36G	37-40 lbs.	62FC-36G-	44"	44C	22-27 lbs.	62FC-44C-
29"	29C	18-23 lbs.	62FC-29C-	36"	36H	40-43 lbs.	62FC-36H-	44"	44D	27-32 lbs.	62FC-44D-
29"	29D	23-28 lbs.	62FC-29D-	36"	36I	43-45 lbs.	62FC-36I-	44"	44E	32-34 lbs.	62FC-44E-
29"	29E	28-32 lbs.	62FC-29E-	37"	37A	11-16 lbs.	62FC-37A-	44"	44F	34-37 lbs.	62FC-44F-
29"	29F	32-36 lbs.	62FC-29F-	37"	37B	16-22 lbs.	62FC-37B-	44"	44G	37-40 lbs.	62FC-44G-
29"	29G	36-40 lbs.	62FC-29G-	37"	37C	22-27 lbs.	62FC-37C-	44"	44H	40-43 lbs.	62FC-44H-
29"	29H	40-43 lbs.	62FC-29H-	37"	37D	27-32 lbs.	62FC-37D-	44"	44I	43-45 lbs.	62FC-44I-
29"	29I	43-45 lbs.	62FC-29I-	37"	37E	32-34 lbs.	62FC-37E-				
30"	30A	8-13 lbs.	62FC-30A-	37"	37F	34-37 lbs.	62FC-37F-				
30"	30B	13-19 lbs.	62FC-30B-	37"	37G	37-40 lbs.	62FC-37G-				
30"	30C	19-24 lbs.	62FC-30C-	37"	37H	40-43 lbs.	62FC-37H-				
30"	30D	24-29 lbs.	62FC-30D-	37"	37I	43-45 lbs.	62FC-37I-				
30"	30E	29-33 lbs.	62FC-30E-	38"	38A	11-16 lbs.	62FC-38A-				
30"	30F	33-37 lbs.	62FC-30F-	38"	38B	16-22 lbs.	62FC-38B-				
30"	30G	37-40 lbs.	62FC-30G-	38"	38C	22-27 lbs.	62FC-38C-				
30"	30H	40-43 lbs.	62FC-30H-	38"	38D	27-32 lbs.	62FC-38D-				
30"	30I	43-45 lbs.	62FC-30I-	38"	38E	32-34 lbs.	62FC-38E-				
31"	31A	8-13 lbs.	62FC-31A-	38"	38F	34-37 lbs.	62FC-38F-				
31"	31B	13-19 lbs.	62FC-31B-	38"	38G	37-40 lbs.	62FC-38G-				

For balances larger than sizes shown and balances stamped with additional numbers that indicate special sash weights, please consult your account manager. Please contact account manager for pricing.

62FI 1/2" X 1/2" INVERTED TILT CHANNEL BALANCE



Length of Metal Channel	Number Stamped on Balance	Sash Weight	Our Part Number	Length of Metal Channel	Number Stamped on Balance	Sash Weight	Our Part Number	Length of Metal Channel	Number Stamped on Balance	Sash Weight	Our Part Number	Length of Metal Channel	Number Stamped on Balance	Sash Weight	Our Part Number
10"	10A	1-6 LBS.	62FI-10A-	22"	22D	21-24 LBS.	62FI-22D-	30"	30E	29-33 LBS.	62FI-30E-	38"	38B	16-22 LBS.	62FI-38B-
10"	10B	6-10 LBS.	62FI-10B-	22"	22E	24-27 LBS.	62FI-22E-	30"	30F	33-37 LBS.	62FI-30F-	38"	38C	22-27 LBS.	62FI-38C-
10"	10C	10-13 LBS.	62FI-10C-	22"	22F	27-30 LBS.	62FI-22F-	30"	30G	37-40 LBS.	62FI-30G-	38"	38D	27-32 LBS.	62FI-38D-
11"	11A	3-7 LBS.	62FI-11A-	22"	22G	30-34 LBS.	62FI-22G-	30"	30H	40-43 LBS.	62FI-30H-	38"	38E	32-34 LBS.	62FI-38E-
11"	11B	7-10 LBS.	62FI-11B-	22"	22H	34-37 LBS.	62FI-22H-	31"	31A	8-13 LBS.	62FI-31A-	38"	38F	34-37 LBS.	62FI-38F-
11"	11C	10-16 LBS.	62FI-11C-	23"	23A	5-10 LBS.	62FI-23A-	31"	31B	13-19 LBS.	62FI-31B-	38"	38G	37-40 LBS.	62FI-38G-
12"	12A	3-7 LBS.	62FI-12A-	23"	23B	10-16 LBS.	62FI-23B-	31"	31C	19-24 LBS.	62FI-31C-	38"	38H	40-43 LBS.	62FI-38H-
12"	12B	7-10 LBS.	62FI-12B-	23"	23C	16-21 LBS.	62FI-23C-	31"	31D	24-29 LBS.	62FI-31D-	38"	38I	43-45 LBS.	62FI-38I-
12"	12C	10-16 LBS.	62FI-12C-	23"	23D	21-24 LBS.	62FI-23D-	31"	31E	29-33 LBS.	62FI-31E-	39"	39A	11-16 LBS.	62FI-39A-
12"	12D	16-18 LBS.	62FI-12D-	23"	23E	24-27 LBS.	62FI-23E-	31"	31F	33-37 LBS.	62FI-31F-	39"	39B	16-22 LBS.	62FI-39B-
13"	13A	3-7 LBS.	62FI-13A-	23"	23F	27-30 LBS.	62FI-23F-	31"	31G	37-40 LBS.	62FI-31G-	39"	39C	22-27 LBS.	62FI-39C-
13"	13B	7-10 LBS.	62FI-13B-	23"	23G	30-34 LBS.	62FI-23G-	31"	31H	40-43 LBS.	62FI-31H-	39"	39D	27-32 LBS.	62FI-39D-
13"	13C	10-16 LBS.	62FI-13C-	23"	23H	34-37 LBS.	62FI-23H-	32"	32A	8-14 LBS.	62FI-32A-	39"	39E	32-34 LBS.	62FI-39E-
13"	13D	16-18 LBS.	62FI-13D-	24"	24A	6-11 LBS.	62FI-24A-	32"	32B	14-20 LBS.	62FI-32B-	39"	39F	34-37 LBS.	62FI-39F-
14"	14A	3-7 LBS.	62FI-14A-	24"	24B	11-17 LBS.	62FI-24B-	32"	32C	20-25 LBS.	62FI-32C-	39"	39G	37-40 LBS.	62FI-39G-
14"	14B	7-10 LBS.	62FI-14B-	24"	24C	17-22 LBS.	62FI-24C-	32"	32D	25-30 LBS.	62FI-32D-	39"	39H	40-43 LBS.	62FI-39H-
14"	14C	10-16 LBS.	62FI-14C-	24"	24D	22-25 LBS.	62FI-24D-	32"	32E	30-34 LBS.	62FI-32E-	39"	39I	43-45 LBS.	62FI-39I-
14"	14D	16-19 LBS.	62FI-14D-	24"	24E	25-28 LBS.	62FI-24E-	32"	32F	34-37 LBS.	62FI-32F-	40"	40A	11-16 LBS.	62FI-40A-
15"	15A	3-7 LBS.	62FI-15A-	24"	24F	28-30 LBS.	62FI-24F-	32"	32G	37-40 LBS.	62FI-32G-	40"	40B	16-22 LBS.	62FI-40B-
15"	15B	7-10 LBS.	62FI-15B-	24"	24G	30-34 LBS.	62FI-24G-	32"	32H	40-43 LBS.	62FI-32H-	40"	40C	22-27 LBS.	62FI-40C-
15"	15C	10-16 LBS.	62FI-15C-	24"	24H	34-37 LBS.	62FI-24H-	33"	33A	8-14 LBS.	62FI-33A-	40"	40D	27-32 LBS.	62FI-40D-
15"	15D	16-19 LBS.	62FI-15D-	25"	25A	6-11 LBS.	62FI-25A-	33"	33B	14-20 LBS.	62FI-33B-	40"	40E	32-34 LBS.	62FI-40E-
16"	16A	3-7 LBS.	62FI-16A-	25"	25B	11-17 LBS.	62FI-25B-	33"	33C	20-25 LBS.	62FI-33C-	40"	40F	34-37 LBS.	62FI-40F-
16"	16B	7-10 LBS.	62FI-16B-	25"	25C	17-22 LBS.	62FI-25C-	33"	33D	25-30 LBS.	62FI-33D-	40"	40G	37-40 LBS.	62FI-40G-
16"	16C	10-16 LBS.	62FI-16C-	25"	25D	22-25 LBS.	62FI-25D-	33"	33E	30-34 LBS.	62FI-33E-	40"	40H	40-43 LBS.	62FI-40H-
16"	16D	16-19 LBS.	62FI-16D-	25"	25E	25-28 LBS.	62FI-25E-	33"	33F	34-37 LBS.	62FI-33F-	40"	40I	43-45 LBS.	62FI-40I-
16"	16E	19-22 LBS.	62FI-16E-	25"	25F	28-30 LBS.	62FI-25F-	33"	33G	37-40 LBS.	62FI-33G-	41"	41A	11-16 LBS.	62FI-41A-
17"	17A	3-7 LBS.	62FI-17A-	25"	25G	30-34 LBS.	62FI-25G-	33"	33H	40-43 LBS.	62FI-33H-	41"	41B	16-22 LBS.	62FI-41B-
17"	17B	7-10 LBS.	62FI-17B-	25"	25H	34-37 LBS.	62FI-25H-	34"	34A	11-16 LBS.	62FI-34A-	41"	41C	22-27 LBS.	62FI-41C-
17"	17C	10-16 LBS.	62FI-17C-	26"	26A	6-11 LBS.	62FI-26A-	34"	34B	16-22 LBS.	62FI-34B-	41"	41D	27-32 LBS.	62FI-41D-
17"	17D	16-19 LBS.	62FI-17D-	26"	26B	11-17 LBS.	62FI-26B-	34"	34C	22-27 LBS.	62FI-34C-	41"	41E	32-34 LBS.	62FI-41E-
17"	17E	19-22 LBS.	62FI-17E-	26"	26C	17-22 LBS.	62FI-26C-	34"	34D	27-32 LBS.	62FI-34D-	41"	41F	34-37 LBS.	62FI-41F-
17"	17F	22-24 LBS.	62FI-17F-	26"	26D	22-26 LBS.	62FI-26D-	34"	34E	32-34 LBS.	62FI-34E-	41"	41G	37-40 LBS.	62FI-41G-
17"	17G	24-28 LBS.	62FI-17G-	26"	26E	26-30 LBS.	62FI-26E-	34"	34F	34-37 LBS.	62FI-34F-	41"	41H	40-43 LBS.	62FI-41H-
18"	18A	4-9 LBS.	62FI-18A-	26"	26F	30-34 LBS.	62FI-26F-	34"	34G	37-40 LBS.	62FI-34G-	41"	41I	43-45 LBS.	62FI-41I-
18"	18B	9-13 LBS.	62FI-18B-	26"	26G	34-38 LBS.	62FI-26G-	34"	34H	40-43 LBS.	62FI-34H-	42"	42A	11-16 LBS.	62FI-42A-
18"	18C	13-18 LBS.	62FI-18C-	26"	26H	38-42 LBS.	62FI-26H-	34"	34I	43-45 LBS.	62FI-34I-	42"	42B	16-22 LBS.	62FI-42B-
18"	18D	18-21 LBS.	62FI-18D-	27"	27A	6-11 LBS.	62FI-27A-	35"	35A	11-16 LBS.	62FI-35A-	42"	42C	22-27 LBS.	62FI-42C-
18"	18E	21-24 LBS.	62FI-18E-	27"	27B	11-17 LBS.	62FI-27B-	35"	35B	16-22 LBS.	62FI-35B-	42"	42D	27-32 LBS.	62FI-42D-
18"	18F	24-26 LBS.	62FI-18F-	27"	27C	17-22 LBS.	62FI-27C-	35"	35C	22-27 LBS.	62FI-35C-	42"	42E	32-34 LBS.	62FI-42E-
18"	18G	26-29 LBS.	62FI-18G-	27"	27D	22-26 LBS.	62FI-27D-	35"	35D	27-32 LBS.	62FI-35D-	42"	42F	34-37 LBS.	62FI-42F-
19"	19A	4-9 LBS.	62FI-19A-	27"	27E	26-30 LBS.	62FI-27E-	35"	35E	32-34 LBS.	62FI-35E-	42"	42G	37-40 LBS.	62FI-42G-
19"	19B	9-13 LBS.	62FI-19B-	27"	27F	30-34 LBS.	62FI-27F-	35"	35F	34-37 LBS.	62FI-35F-	42"	42H	40-43 LBS.	62FI-42H-
19"	19C	13-18 LBS.	62FI-19C-	27"	27G	34-38 LBS.	62FI-27G-	35"	35G	37-40 LBS.	62FI-35G-	42"	42I	43-45 LBS.	62FI-42I-
19"	19D	18-21 LBS.	62FI-19D-	27"	27H	38-42 LBS.	62FI-27H-	35"	35H	40-43 LBS.	62FI-35H-	43"	43A	11-16 LBS.	62FI-43A-
19"	19E	21-24 LBS.	62FI-19E-	28"	28A	7-12 LBS.	62FI-28A-	35"	35I	43-45 LBS.	62FI-35I-	43"	43B	16-22 LBS.	62FI-43B-
19"	19F	24-26 LBS.	62FI-19F-	28"	28B	12-18 LBS.	62FI-28B-	36"	36A	11-16 LBS.	62FI-36A-	43"	43C	22-27 LBS.	62FI-43C-
19"	19G	26-29 LBS.	62FI-19G-	28"	28C	18-23 LBS.	62FI-28C-	36"	36B	16-22 LBS.	62FI-36B-	43"	43D	27-32 LBS.	62FI-43D-
20"	20A	5-10 LBS.	62FI-20A-	28"	28D	23-28 LBS.	62FI-28D-	36"	36C	22-27 LBS.	62FI-36C-	43"	43E	32-34 LBS.	62FI-43E-
20"	20B	10-14 LBS.	62FI-20B-	28"	28E	28-32 LBS.	62FI-28E-	36"	36D	27-32 LBS.	62FI-36D-	43"	43F	34-37 LBS.	62FI-43F-
20"	20C	14-18 LBS.	62FI-20C-	28"	28F	32-36 LBS.	62FI-28F-	36"	36E	32-34 LBS.	62FI-36E-	43"	43G	37-40 LBS.	62FI-43G-
20"	20D	18-22 LBS.	62FI-20D-	28"	28G	36-40 LBS.	62FI-28G-	36"	36F	34-37 LBS.	62FI-36F-	43"	43H	40-43 LBS.	62FI-43H-
20"	20E	22-26 LBS.	62FI-20E-	28"	28H	40-43 LBS.	62FI-28H-	36"	36G	37-40 LBS.	62FI-36G-	43"	43I	43-45 LBS.	62FI-43I-
20"	20F	26-30 LBS.	62FI-20F-	29"	29A	7-12 LBS.	62FI-29A-	36"	36H	40-43 LBS.	62FI-36H-	44"	44A	11-16 LBS.	62FI-44A-
20"	20G	30-34 LBS.	62FI-20G-	29"	29B	12-18 LBS.	62FI-29B-	36"	36I	43-45 LBS.	62FI-36I-	44"	44B	16-22 LBS.	62FI-44B-
21"	21A	5-10 LBS.	62FI-21A-	29"	29C	18-23 LBS.	62FI-29C-	37"	37A	11-16 LBS.	62FI-37A-	44"	44C	22-27 LBS.	62FI-44C-
21"	21B	10-14 LBS.	62FI-21B-	29"	29D	23-28 LBS.	62FI-29D-	37"	37B	16-22 LBS.	62FI-37B-	44"	44D	27-32 LBS.	62FI-44D-
21"	21C	14-18 LBS.	62FI-21C-	29"	29E	28-32 LBS.	62FI-29E-	37"	37C	22-27 LBS.	62FI-37C-	44"	44E	32-34 LBS.	62FI-44E-
21"	21D	18-22 LBS.	62FI-21D-	29"	29F	32-36 LBS.	662FI-29F-	37"	37D	27-32 LBS.	62FI-37D-	44"	44F	34-37 LBS.	62FI-44F-
21"	21E	22-26 LBS.	62FI-21E-	29"	29G	36-40 LBS.	62FI-29G-	37"	37E	32-34 LBS.	62FI-37E-	44"	44G	37-40 LBS.	62FI-44G-
21"	21F	26-30 LBS.	62FI-21F-	29"	29H	40-43 LBS.	62FI-29H-	37"	37F	34-37 LBS.	62FI-37F-	44"	44H	40-43 LBS.	62FI-44H-
21"	21G	30-34 LBS.	62FI-21G-	30"	30A	8-13 LBS.	62FI-30A-	37"	37G	37-40 LBS.	62FI-37G-	44"	44I	43-45 LBS.	62FI-44I-
22"	22A	5-10 LBS.	62FI-22A-	30"	30B	13-19 LBS.	62FI-30B-	37"	37H	40-43 LBS.	62FI-37H-				
22"	22B	10-16 LBS.	62FI-22B-	30"	30C	19-24 LBS.	62FI-30C-	37"	37I	43-45 LBS.	62FI-37I-				
22"	22C	16-21 LBS.	62FI-22C-	30"	30D	24-29 LBS.	62FI-30D-	38"	38A	11-16 LBS.	62FI-38A-				

See Next Page for Ordering Instructions

ORDERING INSTRUCTIONS FOR 62FI SERIES BALANCE

Ordering Information

- 1) Measure metal channel length (Do not include any attached ends.)
- 2) Check number stamped on channel: e.g., 23C, 29A etc.
- 3) Select our corresponding part number from chart on previous page.
- 4) Select clip from list below and add suffix to end of part number.
- 5) Select the appropriate "T" lock option from list below and add suffix to end of part number.

Example Ordering Chart

Channel Length	Number Stamped on Balance	Our Part Number	Clip Attached	Tilt Shoe Attached	Complete Part Number
28"	28A	62FI-28A-	60-951	62-50047	62FI-28A-19AW

**These balances are special order
Contact Your Account Manager For Delivery Schedules**

62FI SERIES BALANCES ACCESSORIES



-42

62-50049

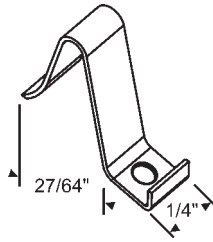

-34

60-950

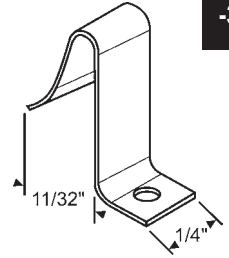

-36

62-50041

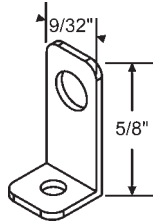

-19

60-951

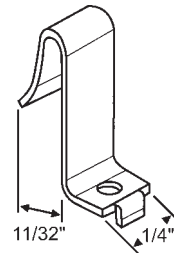

-31

62-50051

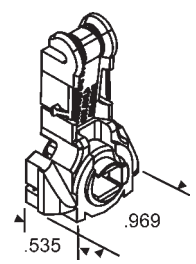
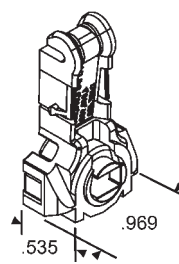
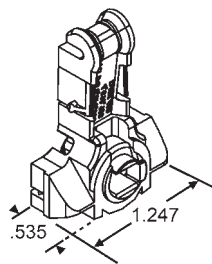
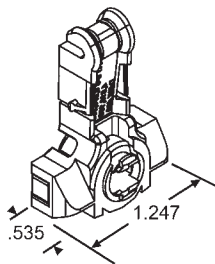

Part #	Puck Color	Cam	Suffix
62-50047	White	Open	AW
62-50104	Blue	Closed	BG
62-50037*	White	Open	X
	Black	Closed	Z

* has twin tab

Part #	Puck Color	Cam	Suffix
62-50034	Metal Spring	Closed	V

Part #	Puck Color	Cam	Suffix
62-50036	Green	Closed	Y

Part #	Puck Color	Cam	Suffix
62-50111	Mill	Closed	

Channel
Depth

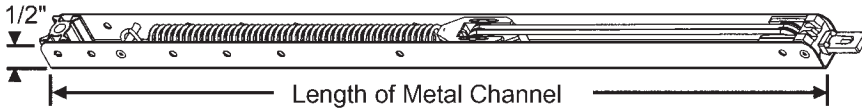

GENERAL INFORMATION

1. Please note that the 1/2" channel height is smaller than the usual 19/32" height on standard balances.
2. If metal channel length does not correspond with the number stamped on balance, consult your representative since your balance may be a special order.
3. Available in Mill Only

ORDERING INSTRUCTIONS

1. Measure metal channel length (do not include any attached ends.)
2. Check number stamped on balance (eg: 26R, 22TG, ect.)
3. Select our corresponding part number from chart below

***Note:** When ordering balances where the number stamped on balance ends with S or DS (example 21DS) you need to specify the exact sash weight within the range listed on the chart.
Ordering Example: Number stamped on balance is 21DS, exact sash weight is 34 lbs., you would then order part number 62G-21DS34-5

Length of Metal Channel	Number Stamped on Balance	Sash Weight	Our Part Number	Length of Metal Channel	Number Stamped on Balance	Sash Weight	Our Part Number	Length of Metal Channel	Number Stamped on Balance	Sash Weight	Our Part Number	Length of Metal Channel	Number Stamped on Balance	Sash Weight	Our Part Number
8"	7R	4-6	62G-7R-5	18"	17S*	20-26	SEE NOTE	27"	26TGX	24-26	62G-26TGX-5	37"	36HD	20-25	62G-36HD-5
8"	7HD	6-9	62G-7HD-5	18"	17TG	14-18	62G-17TG-5	28"	27DS*	34-45	SEE NOTE	37"	36R	15-20	62G-36R-5
8"	7TG	9-11	62G-7TG-5	18"	17TGX	18-20	62-17TGX-5	28"	27HD	15-21	62G-27HD-5	37"	36S*	33-34	SEE NOTE
8"	7TGX	11-13	62G-7TGX-5	19"	18DS*	26-34	SEE NOTE	28"	27R	10-15	62G-27R-5	37"	36TG	25-29	62G-36TG-5
9"	8R	4-6	62G-8R-5	19"	18HD	9-14	62-18HD-5	28"	27S*	26-34	SEE NOTE	37"	36TGX	29-33	62G-36TGX-5
9"	8HD	6-9	62G-8HD-5	19"	18R	6-9	62-18R-5	28"	27TG	21-24	62G-27TG-5	38"	37DS*	34-45	SEE NOTE
9"	8TG	9-11	62G-8TG-5	19"	18S*	21-26	SEE NOTE	28"	27TGX	24-26	62G-27TGX-5	38"	37HD	21-26	62G-37HD-5
9"	8TGX	11-13	62G-8TGX-5	19"	18TG	14-18	62G-18TG-5	29"	28DS*	34-45	SEE NOTE	38"	37R	16-21	62G-37R-5
10"	9R	4-7	62G-9R-5	19"	18TGX	18-21	62G-18TGX-5	29"	28HD	16-21	62G-28HD-5	38"	37TG	26-30	62G-37TG-5
10"	9HD	7-10	62G-9HD-5	20"	19DS*	26-40	SEE NOTE	29"	28R	10-16	62G-28R-5	38"	37TGX	30-34	62G-37TGX-5
10"	9TG	10-12	62G-9TG-5	20"	19HD	9-15	62G-19HD-5	29"	28S*	28-34	SEE NOTE	39"	38DS*	34-45	SEE NOTE
10"	9TGX	10-14	62G-9TGX-5	20"	19R	6-9	62G-19R-5	29"	28TG	21-26	62G-28TG-5	39"	38HD	21-26	62G-38HD-5
11"	10R	4-7	62G-10R-5	20"	19S*	21-26	SEE NOTE	29"	28TGX	26-28	62G-28TGX-5	39"	38R	16-21	62G-38R-5
11"	10HD	7-10	62G-10HD-5	20"	19TG	15-19	62G-19TG-5	30"	29DS*	34-45	SEE NOTE	39"	38TG	26-30	62G-38TG-5
11"	10TG	10-12	62G-10TG-5	20"	19TGX	19-21	62G-19TGX-5	30"	29HD	16-21	62G-29HD-5	39"	38TGX	30-34	62G-38TGX-5
11"	10TGX	12-14	62G-10TGX-5	21"	20DS*	30-40	SEE NOTE	30"	29R	10-16	62G-29R-5	40"	39DS*	34-45	SEE NOTE
11"	10S*	14-18	SEE NOTE	21"	20HD	11-17	62G-20HD-5	30"	29S*	28-34	SEE NOTE	40"	39HD	21-26	62G-39HD-5
12"	11R	4-7	62G-11R-5	21"	20R	8-11	62G-20R-5	30"	29TG	21-26	62G-29TG-5	40"	39R	16-21	62G-39R-5
12"	11HD	7-10	62G-11HD-5	21"	20S*	23-30	SEE NOTE	30"	29TGX	26-28	62G-29TGX-5	40"	39TG	26-30	62G-39TG-5
12"	11TG	10-12	62G-11TG-5	21"	20TG	17-20	62G-20TG-5	31"	30DS*	34-45	SEE NOTE	40"	39TGX	30-34	62G-39TGX-5
12"	11TGX	12-14	62G-11TGX-5	21"	20TGX	20-23	62G-20TGX-5	31"	30HD	18-23	62G-30HD-5	41"	40DS*	34-45	SEE NOTE
12"	11S*	14-18	SEE NOTE	22"	21DS*	30-40	SEE NOTE	31"	30R	13-18	62G-30R-5	41"	40HD	21-26	62G-40HD-5
13"	12R	4-7	62G-12R-5	22"	21HD	11-17	62G-21HD-5	31"	30S*	30-34	SEE NOTE	41"	40R	16-21	62G-40R-5
13"	12HD	7-10	62G-12HD-5	22"	21R	8-11	62G-21R-5	31"	30TG	23-26	62G-30TG-5	41"	40TG	26-30	62G-40TG-5
13"	12TG	10-12	62G-12TG-5	22"	21S*	23-30	SEE NOTE	31"	30TGX	26-30	62G-30TGX-5	41"	40TGX	30-34	62G-40TGX-5
13"	12TGX	12-14	62G-12TGX-5	22"	21TG	17-20	62G-21TG-5	32"	31DS*	34-45	SEE NOTE	42"	41DS*	34-45	SEE NOTE
13"	12S17	14-17	62G-12S17-5	22"	21TGX	20-23	62G-21TGX-5	32"	31HD	18-24	62G-31HD-5	42"	41HD	21-26	62G-41HD-5
13"	12S*	14-22	SEE NOTE	23"	22DS*	30-40	SEE NOTE	32"	31R	13-18	62G-31R-5	42"	41R	18-21	62G-41R-5
13"	12DS*	22-30	SEE NOTE	23"	22HD	12-18	62G-22HD-5	32"	31S*	30-34	SEE NOTE	42"	41TG	26-30	62G-41TG-5
14"	13R	5-8	62G-13R-5	23"	22R	8-12	62G-22R-5	32"	31TG	24-27	62G-31TG-5	42"	41TGX	30-34	62G-41TGX-5
14"	13HD	8-12	62G-13HD-5	23"	22S*	23-30	SEE NOTE	32"	31TGX	27-30	62G-31TGX-5	43"	42DS*	34-45	SEE NOTE
14"	13TG	12-16	62G-13TG-5	23"	22TG	18-21	62G-22TG-5	33"	32DS*	34-45	SEE NOTE	43"	42HD	21-26	62G-42HD-5
14"	13TGX	16-18	62G-13TGX-5	23"	22TGX	21-23	62G-22TGX-5	33"	32HD	18-24	62G-32HD-5	43"	42R	18-21	62G-42R-5
14"	13DS*	22-34	SEE NOTE	24"	23DS*	30-40	SEE NOTE	33"	32R	13-18	62G-32R-5	43"	42TG	26-30	62G-42TG-5
14"	13S*	18-22	SEE NOTE	24"	23HD	12-18	62G-23HD-5	33"	32S*	31-34	SEE NOTE	43"	42TGX	30-34	62G-42TGX-5
15"	14DS	24-34	SEE NOTE	24"	23R	8-12	62G-23R-5	33"	32TG	24-27	62G-32TG-5	44"	43DS*	34-45	SEE NOTE
15"	14HD	8-12	62G-14HD-5	24"	23S*	25-30	SEE NOTE	33"	32TGX	27-31	62G-32TGX-5	44"	43HD	21-26	62G-43HD-5
15"	14R	5-8	62G-R-5	24"	23TG	18-23	62G-23TG-5	34"	33DS*	34-45	SEE NOTE	44"	43R	18-21	62G-43R-5
15"	14S	18-24	SEE NOTE	24"	23TGX	23-25	62G-23TGX-5	34"	33HD	19-25	62G-33HD-5	44"	43TG	26-30	62G-43TG-5
15"	14TG	12-16	62G-14TG-5	25"	24DS*	34-45	SEE NOTE	34"	33R	15-19	62G-33R-5	44"	43TGX	30-34	62G-43TGX-5
15"	14TGX	16-18	62G-14TGX-5	25"	24HD	12-19	62G-24HD-5	34"	33S*	32-34	SEE NOTE	45"	44DS*	35-45	SEE NOTE
16"	15DS*	24-34	SEE NOTE	25"	24R	8-12	62G-24R-5	34"	33TG	25-28	62G-33TG-5	45"	44HD	21-26	62G-44HD-5
16"	15HD	8-12	62G-15HD-5	25"	24S*	26-34	SEE NOTE	34"	33TGX	28-32	62G-33TGX-5	45"	44R	18-21	62G-44R-5
16"	15R	5-8	62G-15R-5	25"	24TG	19-23	62G-24TG-5	35"	34DS*	34-45	SEE NOTE	45"	44TG	26-30	62G-44TG-5
16"	15S*	18-24	SEE NOTE	25"	24TGX	23-26	62G-24TGX-5	35"	34HD	20-25	62G-34HD-5	45"	44TGX	30-35	62G-44TGX-5
16"	15TG	12-16	62G-15TG-5	26"	25DS*	34-45	SEE NOTE	35"	34R	15-20	62G-34R-5				
16"	15TGX	16-18	62G-15TGX-5	26"	25HD	15-20	62G-25HD-5	35"	34S*	32-34	SEE NOTE				
17"	16DS*	26-34	SEE NOTE	26"	25R	10-15	62G-25R-5	35"	34TG	25-28	62G-34TG-5				
17"	16HD	9-14	62G-16HD-5	26"	25S*	26-34	SEE NOTE	35"	34TGX	28-32	62G-34TGX-5				
17"	16R	6-9	62G-16R-5	26"	25TG	20-24	62G-25TG-5	36"	35DS*	34-45	SEE NOTE				
17"	16S*	26-19	SEE NOTE	26"	25TGX	24-26	62G-25TGX-5	36"	35HD	20-25	62G-35HD-5				
17"	16TG	14-17	62G-16TG-5	27"	26DS*	24-45	SEE NOTE	36"	35R	15-20	62G-35R-5				
17"	16TGX	17-17	62G-16TGX-5	27"	26HD	15-20	62G-26HD-5	36"	35S*	33-34	SEE NOTE				
18"	17DS*	26-34	SEE NOTE	27"	26R	10-15	62G-26R-5	36"	35TG	25-29	62G-35TG-5				
18"	17HD	9-14	62G-17HD-5	27"	26S*	26-34	SEE NOTE	36"	35TGX	29-33	62G-35TGX-5				
18"	17R	6-9	62G-17R-5	27"	26TG	20-24	62G-26TG-5	37"	36DS*	34-45	SEE NOTE				

62R SERIES CHANNEL BALANCE (RUSCO)

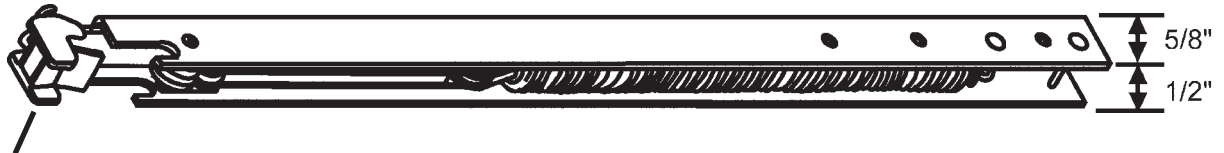

62-538

Balance Foot

Included with balance purchase.

Ordering Information

- 1) Measure metal channel length.
- 2) Identify number stamped on channel.
- 3) Select our corresponding part number from the chart below.

Note: Minimum order required for this series.

Must order minimum of four (4) of the same size balance.

62R SERIES BALANCE ACCESSORIES

Length of Metal Channel	Number Stamped on Balance	Weight Range	Our Part Number	Length of Metal Channel	Number Stamped on Balance	Weight Range	Our Part Number
10-1/2"	10A-C	3-6 lbs.	62R-10A	24"	23E	10-15 lbs.	62R-23E
10-1/2"	10B-C	7-9 lbs.	62R-10B	24"	23F	16-18 lbs.	62R-23F
10-1/2"	10D-C	10-12 lbs.	62R-10D	23-1/16"	23S		62R-23S
10-3/16"	10-S		62R-10S				
11-7/8"	11A	3-6 lbs.	62R-11A	24-3/8"	24F		62R-24F
11-7/8"	11B	7-9 lbs.	62R-11B	24-11/32"	24S		62R-24S
11-7/8"	11D	10-12 lbs.	62R-11D	26"	25B	10-15 lbs.	62R-25B
				26"	25C	16-19 lbs.	62R-25C
14-3/8"	14A		62R-14A	26"	25D	20-25 lbs.	62R-25D
15-7/8"	15A	4-6 lbs.	62R-15A	25-5/8"	25S		62R-25S
15-7/8"	15B	7-10 lbs.	62R-15B	26-1/2"	26C		62R-26C
				26-25/32"	26S		62R-26S
15-7/8"	15D	11-13 lbs.	62R-15D	27-7/8"	27A	5-9 lbs.	62R-27A
				27-7/8"	27B	10-13 lbs.	62R-27B
16-11/16"	16A-C	5-8 lbs.	62R-16A	27-7/8"	27C	14-19 lbs.	62R-27C
16-11/16"	16B-C	9-12 lbs.	62R-16B	27-7/8"	27D	20-26 lbs.	62R-27D
16-11/16"	16D-C	13-19 lbs.	62R-16D	27-15/16"	27S		62R-27S
16-11/16"	16E-C	20-22 lbs.	62R-16E	27-7/8"	27E	27-30 lbs.	62R-27E
16-1/8"	16F		62R-16F	29"	28A-C	7-12 lbs.	62R-28A
16-13/32"	16S		62R-16S	29"	28B-C	13-16 lbs.	62R-28B
16-11/16"	16S-11		62R-16S-11	29"	28C-C	17-23 lbs.	62R-28C
16-11/16"	16S-18		62R-16S-18	29"	28D-C	24-28 lbs.	62R-28D
18"	17A	9-12 lbs.	62R-17A	29"	28E-C	29-32 lbs.	62R-28E
18"	17B	13-17 lbs.	62R-17B	28-9/16"	28S-28		62R-28S
18"	17D		62R-17D	29"	28F-C	32-35 lbs.	62R-28F
18"	17C		62R-17C	32"	31B	13-16 lbs.	62R-31B
18-1/4"	18B		62R-18B	32"	31C	17-23 lbs.	62R-31C
18-21/32"	18S		62R-18S	32"	31D	24-28 lbs.	62R-31D
19-7/8"	19A	5-8 lbs.	62R-19A	32"	31E	29-32 lbs.	62R-31E
19-7/8"	19B	9-12 lbs.	62R-19B				
19-7/8"	19D	13-17 lbs.	62R-19D	33-7/8"	33A	8-13 lbs.	62R-33A
19-7/8"	19S		62R-19S	33-7/8"	33B	14-18 lbs.	62R-33B
20-5/8"	20C		62R-20C	33-7/8"	33C	19-23 lbs.	62R-33C
20-5/8"	20D		62R-20D	33-7/8"	33D	24-28 lbs.	62R-33D
20-3/4"	20E		62R-20E	33-7/8"	33E	29-32 lbs.	62R-33E
20-3/8"	20S		62R-20S				
21-7/8"	21A	5-8 lbs.	62R-21A	35-7/8"	35A-C	8-13 lbs.	62R-35A
21-7/8"	21B	9-12 lbs.	62R-21B	35-7/8"	35B-C	14-18 lbs.	62R-35B
21-7/8"	21C	13-15 lbs.	62R-21C	35-7/8"	35C-C	19-23 lbs.	62R-35C
21-7/8"	21D	16-23 lbs.	62R-21D	35-7/8"	35D-C	24-30 lbs.	62R-35D
21-15/16"	21S		62R-21S	35-7/8"	35E-C	31-35 lbs.	62R-35E
22-13/16"	22A-C	5-8 lbs.	62R-22A	39-7/8"	39A	9-14 lbs.	62R-39A
22-13/16"	22B-C	9-12 lbs.	62R-22B	39-7/8"	39B	15-19 lbs.	62R-39B
22-13/16"	22C-C	13-19 lbs.	62R-22C	39-7/8"	39C	20-24 lbs.	62R-39C
22-13/16"	22D-C	20-23 lbs.	62R-22D	39-7/8"	39D	25-30 lbs.	62R-39D
22-13/16"	22F		62R-22F	39-7/8"	39E		62R-39E
22-9/16"	22S-23		62R-22S	42-7/8"	42A	9-14 lbs.	62R-42A
22-13/16"	22E-C	24-28 lbs.	62R-22E	42-7/8"	42B	15-19 lbs.	62R-42B
23-7/8"	23A	5-9 lbs.	62R-23A	42-7/8"	42C	20-24 lbs.	62R-42C
23-7/8"	23B	10-15 lbs.	62R-23B	42-7/8"	42D	25-30 lbs.	62R-42D
23-7/8"	23C	16-18 lbs.	62R-23C	42-7/8"	42E	31-36 lbs.	62R-42E
23-7/8"	23D	19-22 lbs.	62R-23D				

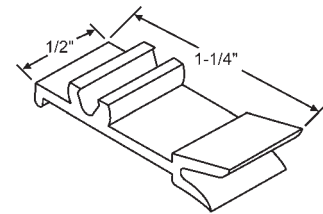

900-19165

Balance Frame Retainer

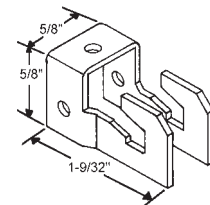

900-19163

Balance Mounting Hook

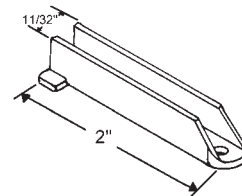

900-19107

Sash Stop
Black

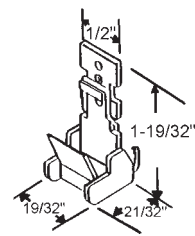

62-538

Balance Foot

Please contact account manager for pricing

SASH SUPPORT SYSTEMS

62S SERIES INVERTED TILT BALANCE

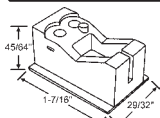

62-708W
Balance Stop

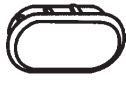

62-709W
Screw Cover
White

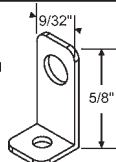

60-951

Channel
Width
1/2"

Channel
Depth
1/2"

Channel Length

Channel
Depth
1/2"



62-50042

GENERAL INFORMATION

1. Same balance as 62-716 series except it has numbers only stamped on balance (no letters like 62-716).
2. Only supplied with 62-50042 shoe and 60-951 clip attached. No other combinations available.
3. Used by Silver Line

ORDERING INFORMATION

1. Measure metal channel length (do not include any attached ends).
2. Check number stamped on channel: e.g. 23-0, 29-1 ect.
3. Select corresponding part number from chart.

Our Part Number	Number Stamped On Balance	Length of Metal Channel	Sash Weight	Our Part Number	Number Stamped On Balance	Length of Metal Channel	Sash Weight
62S-071-19AA	7-1	8"	2 - 4 lbs	62S-1711-19AA	17-11	18"	24 - 26 lbs
62S-073-19AA	7-3	8"	4 - 6 lbs	62S-1713-19AA	17-13	18"	26 - 29 lbs
62S-075-19AA	7-5	8"	6 - 7 lbs	62S-180-19AA	18-0	19"	3 - 5 lbs
62S-077-19AA	7-7	8"	7 - 10 lbs	62S-181-19AA	18-1	19"	5 - 8 lbs
62S-081-19AA	8-1	9"	2 - 4 lbs	62S-183-19AA	18-3	19"	8 - 12 lbs
62S-083-19AA	8-3	9"	4 - 6 lbs	62S-185-19AA	18-5	19"	12 - 16 lbs
62S-085-19AA	8-5	9"	6 - 8 lbs	62S-187-19AA	18-7	19"	16 - 20 lbs
62S-087-19AA	8-7	9"	8 - 10 lbs	62S-1711-19AA	17-11	18"	24 - 26 lbs
62S-089-19AA	8-9	9"	10 - 12 lbs	62S-1713-19AA	17-13	18"	26 - 29 lbs
62S-0811-19AA	8-11	9"	12 - 14 lbs	62S-180-19AA	18-0	19"	3 - 5 lbs
62S-091-19AA	9-1	10"	2 - 5 lbs	62S-181-19AA	18-1	19"	5 - 8 lbs
62S-093-19AA	9-3	10"	5 - 7 lbs	62S-183-19AA	18-3	19"	8 - 12 lbs
62S-095-19AA	9-5	10"	7 - 9 lbs	62S-185-19AA	18-5	19"	12 - 16 lbs
62S-097-19AA	9-7	10"	9 - 11 lbs	62S-187-19AA	18-7	19"	16 - 20 lbs
62S-0911-19AA	9-11	10"	15 - 17 lbs	62S-189-19AA	18-9	19"	20 - 24 lbs
62S-101-19AA	10-1	11"	2 - 5 lbs	62S-1811-19AA	18-11	19"	24 - 26 lbs
62S-103-19AA	10-3	11"	5 - 7 lbs	62S-1813-19AA	18-13	19"	26 - 29 lbs
62S-105-19AA	10-5	11"	7 - 11 lbs	62S-190-19AA	19-0	20"	3 - 5 lbs
62S-107-19AA	10-7	11"	11 - 13 lbs	62S-191-19AA	19-1	20"	5 - 8 lbs
62S-109-19AA	10-9	11"	13 - 15 lbs	62S-193-19AA	19-3	20"	8 - 12 lbs
62S-110-19AA	11-0	12"	2 - 5 lbs	62S-195-19AA	19-5	20"	12 - 16 lbs
62S-111-19AA	11-1	12"	5 - 7 lbs	62S-197-19AA	19-7	20"	16 - 21 lbs
62S-113-19AA	11-3	12"	7 - 9 lbs	62S-199-19AA	19-9	20"	21 - 26 lbs
62S-115-19AA	11-5	12"	9 - 13 lbs	62S-1911-19AA	19-11	20"	26 - 30 lbs
62S-117-19AA	11-7	12"	13 - 15 lbs	62S-1913-19AA	19-13	20"	30 - 34 lbs
62S-119-19AA	11-9	12"	15 - 18 lbs	62S-200-19AA	20-0	21"	4 - 6 lbs
62S-120-19AA	12-0	13"	2 - 5 lbs	62S-201-19AA	20-1	21"	6 - 10 lbs
62S-121-19AA	12-1	13"	5 - 8 lbs	62S-203-19AA	20-3	21"	10 - 15 lbs
62S-123-19AA	12-3	13"	8 - 12 lbs	62S-205-19AA	20-5	21"	15 - 19 lbs
62S-125-19AA	12-5	13"	12 - 14 lbs	62S-207-19AA	20-7	21"	19 - 24 lbs
62S-127-19AA	12-7	13"	14 - 16 lbs	62S-209-19AA	20-9	21"	24 - 26 lbs
62S-129-19AA	12-9	13"	16 - 18 lbs	62S-2011-19AA	20-11	21"	26 - 30 lbs
62S-130-19AA	13-0	14"	2 - 5 lbs	62S-2013-19AA	20-13	21"	30 - 34 lbs
62S-131-19AA	13-1	14"	5 - 8 lbs	62S-210-19AA	21-0	22"	4 - 6 lbs
62S-133-19AA	13-3	14"	8 - 12 lbs	62S-211-19AA	21-1	22"	6 - 10 lbs
62S-135-19AA	13-5	14"	12 - 14 lbs	62S-213-19AA	21-3	22"	10 - 15 lbs
62S-137-19AA	13-7	14"	14 - 16 lbs	62S-215-19AA	21-5	22"	15 - 19 lbs
62S-139-19AA	13-9	14"	16 - 19 lbs	62S-217-19AA	21-7	22"	19 - 24 lbs
62S-140-19AA	14-0	15"	2 - 5 lbs	62S-219-19AA	21-9	22"	24 - 27 lbs
62S-141-19AA	14-1	15"	5 - 8 lbs	62S-2111-19AA	21-11	22"	27 - 30 lbs
62S-143-19AA	14-3	15"	8 - 12 lbs	62S-2113-19AA	21-13	22"	30 - 34 lbs
62S-145-19AA	14-5	15"	12 - 14 lbs	62S-2115-19AA	21-15	22"	34 - 37 lbs
62S-147-19AA	14-7	15"	14 - 16 lbs	62S-220-19AA	22-0	23"	4 - 6 lbs
62S-149-19AA	14-9	15"	16 - 19 lbs	62S-221-19AA	22-1	23"	6 - 10 lbs
62S-1411-19AA	14-11	15"	19 - 22 lbs	62S-223-19AA	22-3	23"	10 - 15 lbs
62S-1413-19AA	14-13	15"	22 - 24 lbs	62S-225-19AA	22-5	23"	15 - 19 lbs
62S-150-19AA	15-0	16"	2 - 5 lbs	62S-227-19AA	22-7	23"	19 - 24 lbs
62S-151-19AA	15-1	16"	5 - 8 lbs	62S-229-19AA	22-9	23"	24 - 27 lbs
62S-153-19AA	15-3	16"	8 - 12 lbs	62S-2211-19AA	22-11	23"	27 - 30 lbs
62S-155-19AA	15-5	16"	12 - 14 lbs	62S-2213-19AA	22-13	23"	30 - 34 lbs
62S-157-19AA	15-7	16"	14 - 16 lbs	62S-2215-19AA	22-15	23"	34 - 37 lbs
62S-159-19AA	15-9	16"	16 - 19 lbs	62S-230-19AA	23-0	24"	4 - 7 lbs
62S-1511-19AA	15-11	16"	19 - 22 lbs	62S-231-19AA	23-1	24"	7 - 10 lbs
62S-1513-19AA	15-13	16"	22 - 24 lbs	62S-233-19AA	23-3	24"	10 - 14 lbs
62S-160-19AA	16-0	17"	3 - 5 lbs	62S-235-19AA	23-5	24"	14 - 19 lbs
62S-161-19AA	16-1	17"	5 - 8 lbs	62S-237-19AA	23-7	24"	19 - 25 lbs
62S-163-19AA	16-3	17"	8 - 12 lbs	62S-238-19AA	23-8	24"	25 - 30 lbs
62S-165-19AA	16-5	17"	12 - 14 lbs	62S-239-19AA	23-9	24"	30 - 34 lbs
62S-167-19AA	16-7	17"	14 - 16 lbs	62S-2311-19AA	23-11	24"	34 - 37 lbs
62S-169-19AA	16-9	17"	16 - 19 lbs	62S-240-19AA	24-0	25"	4 - 7 lbs
62S-1611-19AA	16-11	17"	19 - 22 lbs	62S-241-19AA	24-1	25"	7 - 11 lbs
62S-1613-19AA	16-13	17"	22 - 24 lbs	62S-243-19AA	24-3	25"	11 - 17 lbs
62S-1615-19AA	16-15	17"	24 - 28 lbs	62S-245-19AA	24-5	25"	17 - 24 lbs
62S-170-19AA	17-0	18"	3 - 5 lbs	62S-247-19AA	24-7	25"	24 - 30 lbs
62S-171-19AA	17-1	18"	5 - 8 lbs	62S-249-19AA	24-9	25"	30 - 34 lbs
62S-173-19AA	17-3	18"	8 - 12 lbs	62S-2411-19AA	24-11	25"	34 - 37 lbs
62S-175-19AA	17-5	18"	12 - 16 lbs	62S-250-19AA	25-0	26"	5 - 8 lbs
62S-177-19AA	17-7	18"	16 - 20 lbs	62S-251-19AA	25-1	26"	8 - 13 lbs
62S-179-19AA	17-9	18"	20 - 24 lbs	62S-253-19AA	25-3	26"	13 - 19 lbs

62S SERIES INVERTED TILT BALANCE

Our Part Number	Number Stamped On Balance	Length of Metal Channel	Sash Weight	Our Part Number	Number Stamped On Balance	Length of Metal Channel	Sash Weight
62S-255-19AA	25-5	26"	19 - 24 lbs	62S-351-19AA	35-1	36"	14 - 19 lbs
62S-257-19AA	25-7	26"	24 - 30 lbs	62S-353-19AA	35-3	36"	19 - 25 lbs
62S-259-19AA	25-9	26"	30 - 34 lbs	62S-355-19AA	35-5	36"	25 - 30 lbs
62S-2511-19AA	25-11	26"	34 - 38 lbs	62S-357-19AA	35-7	36"	30 - 34 lbs
62S-2513-19AA	25-13	26"	38 - 42 lbs	62S-359-19AA	35-9	36"	34 - 37 lbs
62S-260-19AA	26-0	27"	5 - 9 lbs	62S-3511-19AA	35-11	36"	37 - 40 lbs
62S-261-19AA	26-1	27"	9 - 12 lbs	62S-3513-19AA	35-13	36"	40 - 43 lbs
62S-263-19AA	26-3	27"	12 - 17 lbs	62S-3515-19AA	35-15	36"	43 - 45 lbs
62S-265-19AA	26-5	27"	17 - 23 lbs	62S-360-19AA	36-0	37"	9 - 14 lbs
62S-267-19AA	26-7	27"	23 - 30 lbs	62S-361-19AA	36-1	37"	14 - 19 lbs
62S-269-19AA	26-9	27"	30 - 34 lbs	62S-363-19AA	36-3	37"	19 - 25 lbs
62S-2611-19AA	26-11	27"	34 - 38 lbs	62S-365-19AA	36-5	37"	25 - 30 lbs
62S-2613-19AA	26-13	27"	38 - 42 lbs	62S-367-19AA	36-7	37"	30 - 34 lbs
62S-270-19AA	27-0	28"	6 - 10 lbs	62S-369-19AA	36-9	37"	34 - 37 lbs
62S-271-19AA	27-1	28"	10 - 14 lbs	62S-3611-19AA	36-11	37"	37 - 40 lbs
62S-273-19AA	27-3	28"	14 - 19 lbs	62S-3613-19AA	36-13	37"	40 - 43 lbs
62S-275-19AA	27-5	28"	19 - 24 lbs	62S-3615-19AA	36-15	37"	43 - 45 lbs
62S-277-19AA	27-7	28"	24 - 31 lbs	62S-370-19AA	37-0	38"	9 - 14 lbs
62S-279-19AA	27-9	28"	31 - 36 lbs	62S-371-19AA	37-1	38"	14 - 19 lbs
62S-2711-19AA	27-11	28"	36 - 40 lbs	62S-373-19AA	37-3	38"	19 - 25 lbs
62S-2713-19AA	27-13	28"	40 - 43 lbs	62S-375-19AA	37-5	38"	25 - 30 lbs
62S-280-19AA	28-0	29"	6 - 10 lbs	62S-377-19AA	37-7	38"	30 - 35 lbs
62S-281-19AA	28-1	29"	10 - 14 lbs	62S-379-19AA	37-9	38"	35 - 37 lbs
62S-283-19AA	28-3	29"	14 - 20 lbs	62S-3711-19AA	37-11	38"	37 - 40 lbs
62S-285-19AA	28-5	29"	20 - 27 lbs	62S-3713-19AA	37-13	38"	40 - 43 lbs
62S-287-19AA	28-7	29"	27 - 34 lbs	62S-3715-19AA	37-15	38"	43 - 45 lbs
62S-289-19AA	28-9	29"	34 - 36 lbs	62S-380-19AA	38-0	39"	9 - 14 lbs
62S-2811-19AA	28-11	29"	36 - 40 lbs	62S-381-19AA	38-1	39"	14 - 19 lbs
62S-2813-19AA	28-13	29"	40 - 43 lbs	62S-383-19AA	38-3	39"	19 - 25 lbs
62S-290-19AA	29-0	30"	6 - 10 lbs	62S-385-19AA	38-5	39"	25 - 30 lbs
62S-291-19AA	29-1	30"	10 - 14 lbs	62S-387-19AA	38-7	39"	30 - 35 lbs
62S-293-19AA	29-3	30"	14 - 21 lbs	62S-389-19AA	38-9	39"	35 - 37 lbs
62S-295-19AA	29-5	30"	21 - 27 lbs	62S-3811-19AA	38-11	39"	37 - 40 lbs
62S-297-19AA	29-7	30"	27 - 34 lbs	62S-3813-19AA	38-13	39"	40 - 43 lbs
62S-299-19AA	29-9	30"	34 - 37 lbs	62S-3815-19AA	38-15	39"	43 - 45 lbs
62S-2911-19AA	29-11	30"	37 - 40 lbs	62S-390-19AA	39-0	40"	9 - 14 lbs
62S-2913-19AA	29-13	30"	40 - 43 lbs	62S-391-19AA	39-1	40"	14 - 19 lbs
62S-300-19AA	30-0	31"	6 - 12 lbs	62S-393-19AA	39-3	40"	19 - 25 lbs
62S-301-19AA	30-1	31"	12 - 16 lbs	62S-395-19AA	39-5	40"	25 - 31 lbs
62S-303-19AA	30-3	31"	16 - 23 lbs	62S-397-19AA	39-7	40"	31 - 35 lbs
62S-305-19AA	30-5	31"	23 - 28 lbs	62S-399-19AA	39-9	40"	35 - 37 lbs
62S-307-19AA	30-7	31"	28 - 34 lbs	62S-3911-19AA	39-11	40"	37 - 40 lbs
62S-309-19AA	30-9	31"	34 - 37 lbs	62S-3913-19AA	39-13	40"	40 - 43 lbs
62S-3011-19AA	30-11	31"	37 - 40 lbs	62S-3915-19AA	39-15	40"	43 - 45 lbs
62S-3013-19AA	30-13	31"	40 - 43 lbs	62S-400-19AA	40-0	41"	9 - 14 lbs
62S-310-19AA	31-0	32"	7 - 13 lbs	62S-401-19AA	40-1	41"	14 - 19 lbs
62S-311-19AA	31-1	32"	13 - 17 lbs	62S-403-19AA	40-3	41"	19 - 25 lbs
62S-313-19AA	31-3	32"	17 - 23 lbs	62S-405-19AA	40-5	41"	25 - 31 lbs
62S-315-19AA	31-5	32"	23 - 28 lbs	62S-407-19AA	40-7	41"	31 - 35 lbs
62S-317-19AA	31-7	32"	28 - 34 lbs	62S-409-19AA	40-9	41"	35 - 40 lbs
62S-319-19AA	31-9	32"	34 - 37 lbs	62S-4011-19AA	40-11	41"	40 - 43 lbs
62S-3111-19AA	31-11	32"	37 - 40 lbs	62S-4013-19AA	40-13	41"	43 - 45 lbs
62S-3113-19AA	31-13	32"	40 - 43 lbs	62S-410-19AA	41-0	42"	9 - 14 lbs
62S-320-19AA	32-0	33"	7 - 13 lbs	62S-411-19AA	41-1	42"	14 - 19 lbs
62S-321-19AA	32-1	33"	13 - 18 lbs	62S-413-19AA	41-3	42"	19 - 25 lbs
62S-323-19AA	32-3	33"	18 - 24 lbs	62S-415-19AA	41-5	42"	25 - 31 lbs
62S-325-19AA	32-5	33"	24 - 29 lbs	62S-417-19AA	41-7	42"	31 - 36 lbs
62S-327-19AA	32-7	33"	29 - 34 lbs	62S-419-19AA	41-9	42"	36 - 40 lbs
62S-329-19AA	32-9	33"	34 - 37 lbs	62S-4111-19AA	41-11	42"	40 - 43 lbs
62S-3211-19AA	32-11	33"	37 - 40 lbs	62S-4113-19AA	41-13	42"	43 - 45 lbs
62S-3213-19AA	32-13	33"	40 - 43 lbs	62S-420-19AA	42-0	43"	9 - 14 lbs
62S-3215-19AA	32-15	33"	43 - 45 lbs	62S-421-19AA	42-1	43"	14 - 19 lbs
62S-330-19AA	33-0	34"	8 - 13 lbs	62S-423-19AA	42-3	43"	19 - 25 lbs
62S-331-19AA	33-1	34"	13 - 19 lbs	62S-425-19AA	42-5	43"	25 - 31 lbs
62S-333-19AA	33-3	34"	19 - 25 lbs	62S-427-19AA	42-7	43"	31 - 36 lbs
62S-335-19AA	33-5	34"	25 - 30 lbs	62S-429-19AA	42-9	43"	36 - 40 lbs
62S-337-19AA	33-7	34"	30 - 34 lbs	62S-4211-19AA	42-11	43"	40 - 43 lbs
62S-339-19AA	33-9	34"	34 - 37 lbs	62S-4213-19AA	42-13	43"	43 - 45 lbs
62S-3311-19AA	33-11	34"	37 - 40 lbs	62S-430-19AA	43-0	44"	9 - 14 lbs
62S-3313-19AA	33-13	34"	40 - 43 lbs	62S-431-19AA	43-1	44"	14 - 19 lbs
62S-3315-19AA	33-15	34"	43 - 45 lbs	62S-433-19AA	43-3	44"	19 - 25 lbs
62S-340-19AA	34-0	35"	8 - 14 lbs	62S-435-19AA	43-5	44"	25 - 31 lbs
62S-341-19AA	34-1	35"	14 - 19 lbs	62S-437-19AA	43-7	44"	31 - 37 lbs
62S-343-19AA	34-3	35"	19 - 25 lbs	62S-439-19AA	43-9	44"	37 - 42 lbs
62S-345-19AA	34-5	35"	25 - 30 lbs	62S-440-19AA	44-0	45"	9 - 14 lbs
62S-347-19AA	34-7	35"	30 - 34 lbs	62S-441-19AA	44-1	45"	14 - 19 lbs
62S-349-19AA	34-9	35"	34 - 37 lbs	62S-443-19AA	44-3	45"	19 - 25 lbs
62S-3411-19AA	34-11	35"	37 - 40 lbs	62S-445-19AA	44-5	45"	25 - 31 lbs
62S-3413-19AA	34-13	35"	40 - 43 lbs	62S-447-19AA	44-7	45"	31 - 37 lbs
62S-3415-19AA	34-15	35"	43 - 45 lbs	62S-449-19AA	44-9	45"	37 - 42 lbs
62S-350-19AA	35-0	36"	9 - 14 lbs				

SASH SUPPORT SYSTEMS

62V SERIES CHANNEL BALANCE (RUSCO)

OBSOLETE BALANCE AND RELATED COMPONENTS ARE SHOWN FOR REFERENCE ONLY

Old Style 5 to 1 Overhead

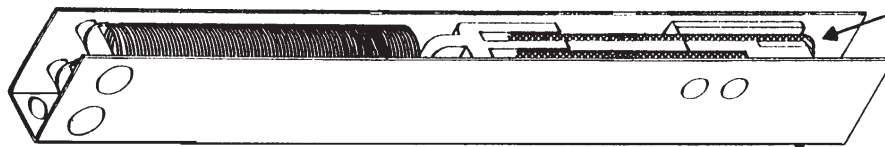

Balance is strung with 3/64" Dia. wire cable.

Straight Sleeve is installed when extra cable is ordered.



62V-500
Balance Clip

New Style



New style is strung with .072 Dacron Cord.

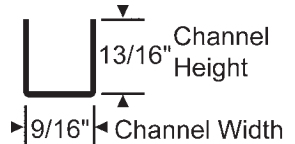

Standard cord length is determined from balance to hook at bottom of closed sash.

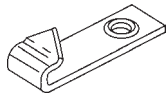

60-518

Supplied with our 60-518 clip unless otherwise specified.



If ordering **900-21263**
add -10

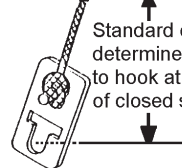

If ordering **900-17773**
add -6

Ordering Information

- 1) Measure channel length.
- 2) Identify number stamped on balance.
- 3) Customer must determine how much cord hangs down from the balance when the window is closed. If more cord than the standard lengths shown is required, specify number of extra inches required when ordering by adding a plus sign (+) followed by number of extra inches needed.
- 4) Determine the clip to be attached to balance. If ordering with our 900-17773 attached, add -6 after our part number.

(e.g. If ordering a 153-D balance with our 900-17773 clip attached and 40" of cord is required, the part number would be 62V-153D+10-6.)

General Information

- 1) Balances are supplied with either one or two springs. If the number stamped on your balance is followed by the letter "D" it denotes a double spring.

**Note: Minimum order required for this series.
Must order minimum of four (4) of the same size balance.**

Length of Metal Channel	Number Stamped on Balance	Our Part Number		Weight Range (2 Balances)
13-1/4"	112	62V-112	Standard extended cord length from balance 20"	4 to 10 lbs.
13-1/4"	112	62V-112+	(Specify extra inches of cord required)	
13-1/4"	112-D	62V-112D	Standard extended cord length from balance 20"	10 to 18 lbs.
13-1/4"	112-D	62V-112D+	(Specify extra inches of cord required)	
16-1/4"	122	62V-122	Standard extended cord length from balance 25"	6 to 12 lbs.
16-1/4"	122	62V-122+	(Specify extra inches of cord required)	
16-1/4"	122-D	62V-122D	Standard extended cord length from balance 25"	12 to 22 lbs.
16-1/4"	122-D	62V-122D+	(Specify extra inches of cord required)	
19-3/4"	153	62V-153	Standard extended cord length from balance 30"	8 to 16 lbs.
19-3/4"	153	62V-153+	(Specify extra inches of cord required)	
19-3/4"	153-D	62V-153D	Standard extended cord length from balance 30"	16 to 28 lbs.
19-3/4"	153-D	62V-153D+	(Specify extra inches of cord required)	
23-3/4"	163	62V-163	Standard extended cord length from balance 36"	10 to 18 lbs.
23-3/4"	163	62V-163+	(Specify extra inches of cord required)	
23-3/4"	163-D	62V-163D	Standard extended cord length from balance 36"	18 to 32 lbs.
23-3/4"	163-D	62V-163D+	(Specify extra inches of cord required)	
28-1/4"	183	62V-183	Standard extended cord length from balance 40"	10 to 16 lbs.
28-1/4"	183	62V-183+	(Specify extra inches of cord required)	
28-1/4"	183-D	62V-183D	Standard extended cord length from balance 40"	16 to 34 lbs.
28-1/4"	183-D	62V-183D+	(Specify extra inches of cord required)	

Please contact account manager for pricing.

62W SERIES OVERHEAD BALANCES

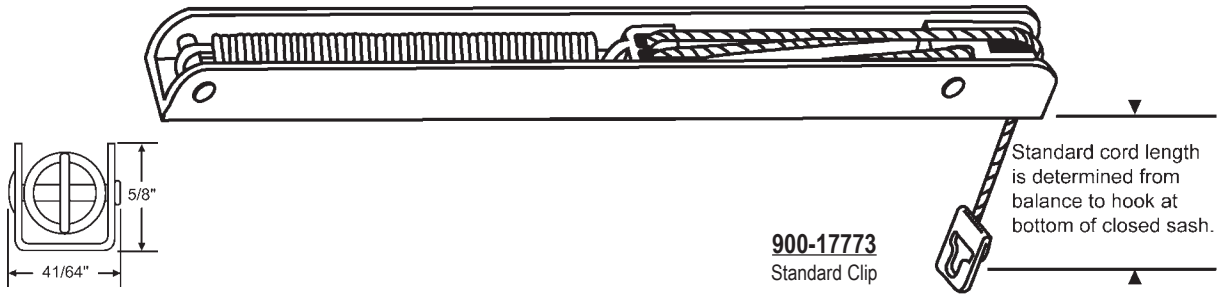

900-17773
Standard Clip

Ordering Information

- 1) Measure metal channel length.
- 2) Identify number stamped on balance.
- 3) Select our corresponding part number from the chart below and order accordingly.
- 4) Standard clip shown will be attached unless otherwise specified.

General Information

- 1) If cord lengths are different from the standard lengths shown, a plus sign (+) and the extra number of inches should be added after the part number.
- 2) Determine the balance clip to be attached and order accordingly: standard, 60-518 or 900-18354.

Example Ordering Chart

Channel Length	Number Stamped	Part Number	Extra Cord (In Inches)	End Attached	Complete Part Number
15-1/4"	122	62W-122	10"	-5	62W-122+10-5
19-1/4"	152	62W-152	--	-1	62W-152-1

Note: If your balance is stamped with the letters "DBS", refer to our DS balances, since their manufacturing specifications are the same.

Length of Metal Channel	Number Stamped on Balance	Our Part Number		Sash Weight Per Pair
12-3/4"	111	62W-111	Standard Cord 20" with standard clip attached	4- 7 lbs.
12-3/4"	111	62W-111+	(Specify extra inches of cord length)	4- 7 lbs.
12-3/4"	112	62W-112	Standard Cord 20" with standard clip attached	7-11 lbs.
12-3/4"	112	62W-112+	(Specify extra inches of cord length)	7-11 lbs.
15-1/4"	121	62W-121	Standard Cord 25" with standard clip attached	4-8 lbs.
15-1/4"	121	62W-121+	(Specify extra inches of cord length)	4-8 lbs.
15-1/4"	122	62W-122	Standard Cord 25" with standard clip attached	8-12 lbs.
15-1/4"	122	62W-122+	(Specify extra inches of cord length)	8-12 lbs.
15-1/4"	122DS	62W-122DS*	Standard Cord 32" with standard clip attached	-
15-1/4"	122DS	62W-122DS+ *	(Specify extra inches of cord length)	-
19-1/4"	151	62W-151	Standard Cord 33" with standard clip attached	5-9 lbs.
19-1/4"	151	62W-151+	(Specify extra inches of cord length)	5-9 lbs.
19-1/4"	152	62W-152	Standard Cord 33" with standard clip attached	9-13 lbs.
19-1/4"	152	62W-152+	(Specify extra inches of cord length)	9-13 lbs.
19-1/4"	153	62W-153	Standard Cord 33" with standard clip attached	13-16 lbs.
19-1/4"	153	62W-153+	(Specify extra inches of cord length)	13-16 lbs.
19-1/4"	153HD	62W-153HD	Standard Cord 30" with standard clip attached	16-18 lbs.
19-1/4"	153HD	62W-153HD+	(Specify extra inches of cord length)	16-18 lbs.
23-1/4"	162	62W-162	Standard Cord 36" with standard clip attached	9-14 lbs.
23-1/4"	162	62W-162+	(Specify extra inches of cord length)	9-14 lbs.
23-1/4"	163	62W-163	Standard Cord 36" with standard clip attached	13-16 lbs.
23-1/4"	163	62W-163+	(Specify extra inches of cord length)	13-16 lbs.
23-1/4"	163HD	62W-163HD	Standard Cord 36" with standard clip attached	15-17 lbs.
23-1/4"	163HD	62W-163HD+	(Specify extra inches of cord length)	15-17 lbs.
25"	24DS	62W-24DS*	Standard Cord 36" with standard clip attached	-
25"	24DS	62W-24DS+*	(Specify extra inches of cord length)	-
27-1/4"	183	62W-183	Standard Cord 40" with standard clip attached	17-20 lbs.
27-1/4"	183	62W-183+	(Specify extra inches of cord length)	17-20 lbs.
27-1/4"	183HD	62W-183HD	Standard Cord 36" with standard clip attached	24-27 lbs.
27-1/4"	183HD	62W-183HD+	(Specify extra inches of cord length)	24-27 lbs.
29"	28DS	62W-28DS*	Standard Cord 36" with standard clip attached	-
29"	28DS	62W-28DS+*	(Specify extra inches of cord length)	-
31"	30DS	62W-30DS*	Standard Cord 36" with standard clip attached	-
31"	30DS	62W-30DS+*	(Specify extra inches of cord length)	-
34"	33DS	62W-33DS*	Standard Cord 38" with standard clip attached	-
34"	33DS	62W-33DS+*	(Specify extra inches of cord length)	-
36"	35DS	62W-35DS*	Standard Cord 36" with standard clip attached	-
36"	35DS	62W-35DS+*	(Specify extra inches of cord length)	-

*Note: When ordering balances where the number stamped on balance ends with DS (example 24DS) you need to specify the exact sash weight within the range listed on the chart.

END BRACKETS

Add suffix to complete part number.

-1

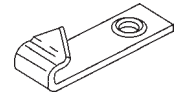

60-518

If ordering with our optional 60-518 clip attached, please add "-1" after the part number.

-5

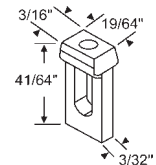

900-18354

If ordering with our optional 900-18354 clip attached, please add "-5" after the part number.

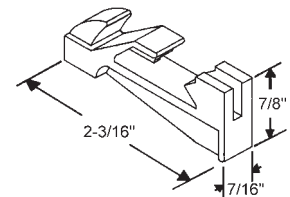

62W-500

Black

Primarily used on West Coast by International and other manufacturers.

Must be ordered separately.

64 SERIES CHANNEL BALANCES

3/8" CHANNEL BALANCE NON-TILT

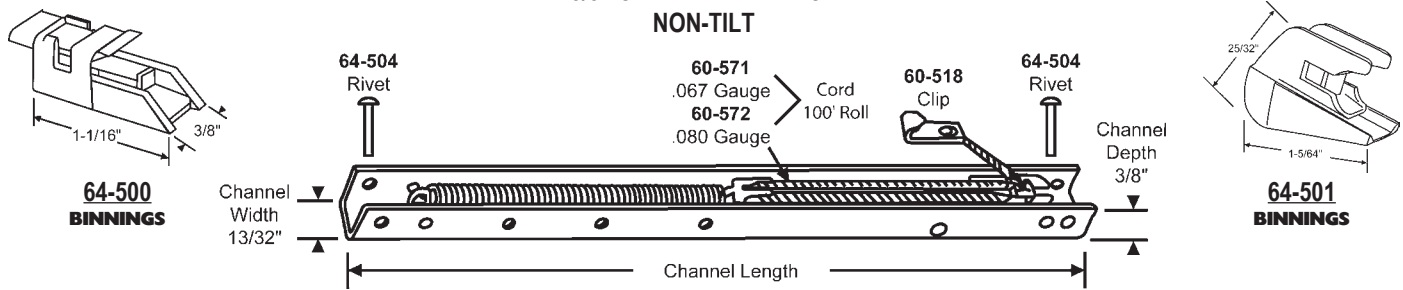

Length of Metal Channel	Number Stamped on Balance	Sash Weight	Our Part Number	Number Stamped on Balance	Sash Weight	Our Part Number	Number Stamped on Balance	Sash Weight	Our Part Number
10"	9A		64-091				9C		64-093
11"	10A	2 through 5	64-101	10B	4 through 7	64-102	10C	8 through 12	64-103
12"	11A	3 through 6	64-111	11B	7 through 9	64-112	11C	10 through 12	64-113
13"	12A	3 through 7	64-121	12B	8 through 12	64-122	12C	13 through 15	64-123
14"	13A	3 through 7	64-131	13B	8 through 12	64-132	13C	13 through 15	64-133
15"	14A	3 through 7	64-141	14B	8 through 12	64-142	14C	13 through 16	64-143
16"	15A	3 through 7	64-151	15B	8 through 12	64-152	15C	13 through 16	64-153
17"	16A	3 through 7	64-161	16B	8 through 12	64-162	16C	13 through 18	64-163
18"	17A	3 through 7	64-171	17B	8 through 12	64-172	17C	13 through 18	64-173
19"	18A	4 through 8	64-181	18B	9 through 12	64-182	18C	13 through 18	64-183
20"	19A	4 through 8	64-191	19B	9 through 12	64-192	19C	13 through 18	64-193
21"	20A	4 through 8	64-201	20B	9 through 13	64-202	20C	14 through 18	64-203
22"	21A	4 through 8	64-211	21B	9 through 13	64-212	21C	14 through 18	64-213
23"	22A	4 through 8	64-221	22B	9 through 12	64-222	22C	13 through 18	64-223
24"	23A	4 through 8	64-231	23B	9 through 13	64-232	23C	14 through 20	64-233
25"	24A	4 through 8	64-241	24B	9 through 13	64-242	24C	14 through 23	64-243
26"	25A	4 through 8	64-251	25B	9 through 14	64-252	25C	15 through 23	64-253
27"	26A	4 through 8	64-261	26B	9 through 14	64-262	26C	15 through 23	64-263
28"	27A	4 through 8	64-271	27B	9 through 14	64-272	27C	15 through 23	64-273
29"	28A	4 through 8	64-281	28B	9 through 14	64-282	28C	15 through 23	64-283
30"	29A	4 through 8	64-291	29B	9 through 14	64-292	29C	15 through 23	64-293
31"	30A	4 through 8	64-301	30B	9 through 14	64-302	30C	15 through 23	64-303
32"	31A	4 through 8	64-311	31B	9 through 14	64-312	31C	15 through 23	64-313
33"	32A	4 through 8	64-321	32B	9 through 14	64-322	32C	15 through 23	64-323
34"	33A	4 through 8	64-331	33B	9 through 14	64-332	33C	15 through 23	64-333
35"	34A	4 through 8	64-341	34B	9 through 14	64-342	34C	15 through 23	64-343
36"	35A	4 through 8	64-351	35B	9 through 14	64-352	35C	15 through 23	64-353
37"	36A	4 through 8	64-361	36B	9 through 14	64-362	36C	15 through 23	64-363
38"	37A	4 through 8	64-371	37B	9 through 14	64-372	37C	15 through 23	64-373

Ordering Information

- 1) Measure metal channel length (do not include plastic ends).
- 2) Identify number stamped on channel. (e.g. 19A, 22B, 28C, etc.)
- 3) Select our corresponding part number from the chart below.
- 4) Identify the top and bottom ends to be attached.

Note: Top and bottom balance ends must be ordered separately. If you want ends attached, add the letter "A" to the suffix of the part number when ordering.

Popular in Southeast; primarily used by Binnings and Moss.

64 SERIES BALANCES ACCESSORIES

TOP BRACKETS

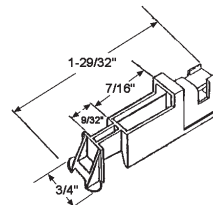

**900-15469
LAWSON**

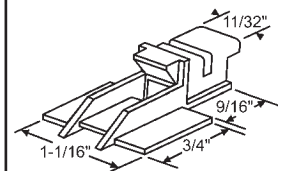

64-506

TOP BRACKETS

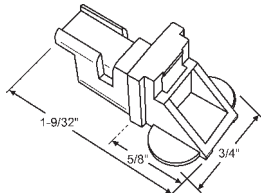

**64-508
ATRIUM**

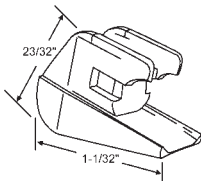

64-502

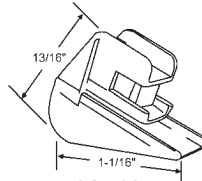

64-503
No Longer Available.
Use: 54-501

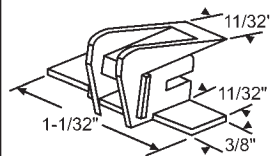

64-505

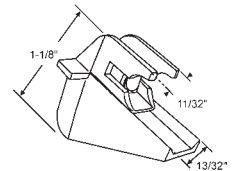

**900-15468
LAWSON**

BOTTOM BRACKETS

BALANCE CLIP

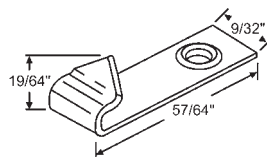

60-518

RIVET



64-504
3/32" Diameter 13/32" Length

SASH GUIDES

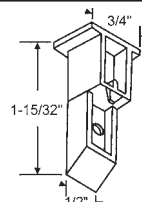

Part #	Color
64-600	White
64-600B	Black
64-600CLR	Clear

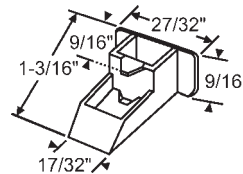

64-602
White

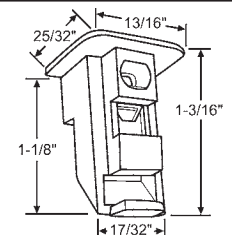

Part #	Color
64-601	White
64-601B	Black

64-841 SERIES RIBBED INVERTED TILT BALANCES

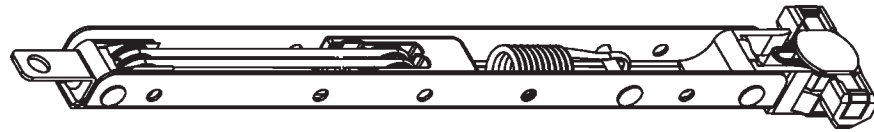
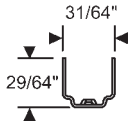

Ordering Information

1. Measure metal channel length. (Do not include attached clip and T-Lock.)
2. Check number stamped on balance.
3. Select our corresponding part number from the chart below.
4. Select clip from list and add suffix to end of part number
5. Select the appropriate T-Lock from list and add suffix to end of part number

Example Ordering Chart

Channel Length	Number Stamped on Balance	Our Part Number	Clip Attached	Tilt Lock Attached	Complete Part Number
24"	24A	64-841-24A	60-651	64-50000	64-841-24A-19Q

Length of Metal Channel	Number Stamped on Balance	Sash Weight	Our Part Number	Length of Metal Channel	Number Stamped on Balance	Sash Weight	Our Part Number	Length of Metal Channel	Number Stamped on Balance	Sash Weight	Our Part Number
8"	8A	4 - 6	64-841-8A	22"	22B	11 - 17	64-841-22B	32"	32F	33 - 36	64-841-32F
8"	8B	6 - 8	64-841-8B	22"	22C	17 - 21	64-841-22C	33"	33A	15 - 19	64-841-33A
8"	8C	8 - 10	64-841-8C	22"	22D	21 - 25	64-841-22D	33"	33B	19 - 23	64-841-33B
9"	9A	5 - 7	64-841-9A	22"	22E	25 - 28	64-841-22E	33"	33C	23 - 26	64-841-33C
9"	9B	7 - 9	64-841-9B	23"	23A	5 - 11	64-841-23A	33"	33D	26 - 30	64-841-33D
9"	9C	9 - 11	64-841-9C	23"	23B	11 - 17	64-841-23B	33"	33E	30 - 33	64-841-33E
10"	10A	5 - 8	64-841-10A	23"	23C	17 - 21	64-841-23C	33"	33F	33 - 36	64-841-33F
10"	10B	8 - 11	64-841-10B	23"	23D	21 - 25	64-841-23D	34"	34A	16 - 21	64-841-34A
10"	10C	11 - 14	64-841-10C	23"	23E	25 - 28	64-841-23E	34"	34B	21 - 25	64-841-34B
11"	11A	5 - 9	64-841-11A	24"	24A	5 - 13	64-841-24A	34"	34C	25 - 26	64-841-34C
11"	11B	9 - 13	64-841-11B	24"	24B	13 - 18	64-841-24B	34"	34D	26 - 30	64-841-34D
11"	11C	13 - 16	64-841-11C	24"	24C	18 - 22	64-841-24C	34"	34E	30 - 34	64-841-34E
12"	12A	5 - 9	64-841-12A	24"	24D	22 - 26	64-841-24D	34"	34F	34 - 36	64-841-34F
12"	12B	9 - 13	64-841-12B	24"	24E	26 - 29	64-841-24E	35"	35A	18 - 21	64-841-35A
12"	12C	13 - 16	64-841-12C	25"	25A	5 - 13	64-841-25A	35"	35B	21 - 24	64-841-35B
13"	13A	5 - 9	64-841-13A	25"	25B	13 - 19	64-841-25B	35"	35C	24 - 26	64-841-35C
13"	13B	9 - 13	64-841-13B	25"	25C	19 - 23	64-841-25C	35"	35D	26 - 30	64-841-35D
13"	13C	13 - 16	64-841-13C	25"	25D	23 - 27	64-841-25D	35"	35E	30 - 34	64-841-35E
13"	13D	16 - 18	64-841-13D	25"	25E	27 - 30	64-841-25E	36"	36A	18 - 21	64-841-36A
14"	14A	5 - 9	64-841-14A	26"	26A	6 - 14	64-841-26A	36"	36B	21 - 24	64-841-36B
14"	14B	9 - 13	64-841-14B	26"	26B	14 - 19	64-841-26B	36"	36C	24 - 26	64-841-36C
14"	14C	13 - 16	64-841-14C	26"	26C	19 - 23	64-841-26C	36"	36D	26 - 30	64-841-36D
14"	14D	16 - 18	64-841-14D	26"	26D	23 - 28	64-841-26D	37"	37A	18 - 21	64-841-37A
15"	15A	5 - 9	64-841-15A	26"	26E	28 - 31	64-841-26E	37"	37B	21 - 24	64-841-37B
15"	15B	9 - 13	64-841-15B	27"	27A	7 - 14	64-841-27A	37"	37C	24 - 26	64-841-37C
15"	15C	13 - 16	64-841-15C	27"	27B	14 - 20	64-841-27B	37"	37D	26 - 30	64-841-37D
15"	15D	16 - 18	64-841-15D	27"	27C	20 - 24	64-841-27C	38"	38A	18 - 21	64-841-38A
16"	16A	5 - 9	64-841-16A	27"	27D	24 - 28	64-841-27D	38"	38B	21 - 24	64-841-38B
16"	16B	9 - 14	64-841-16B	27"	27E	28 - 30	64-841-27E	38"	38C	24 - 26	64-841-38C
16"	16C	14 - 17	64-841-16C	28"	28A	8 - 14	64-841-28A	38"	38D	26 - 30	64-841-38D
16"	16D	17 - 20	64-841-16D	28"	28B	14 - 20	64-841-28B	39"	39A	18 - 21	64-841-39A
17"	17A	4 - 9	64-841-17A	28"	28C	20 - 23	64-841-28C	39"	39B	21 - 24	64-841-39B
17"	17B	9 - 14	64-841-17B	28"	28D	23 - 28	64-841-28D	39"	39C	24 - 26	64-841-39C
17"	17C	14 - 18	64-841-17C	28"	28E	28 - 30	64-841-28E	39"	39D	26 - 28	64-841-39D
17"	17D	18 - 20	64-841-17D	28"	28F	30 - 34	64-841-28F	40"	40A	18 - 21	64-841-40A
18"	18A	4 - 9	64-841-18A	29"	29A	9 - 15	64-841-29A	40"	40B	21 - 24	64-841-40B
18"	18B	9 - 15	64-841-18B	29"	29B	15 - 21	64-841-29B	40"	40C	24 - 26	64-841-40C
18"	18C	15 - 18	64-841-18C	29"	29C	21 - 26	64-841-29C	40"	40D	26 - 28	64-841-40D
18"	18D	18 - 20	64-841-18D	29"	29D	26 - 30	64-841-29D	41"	41A	18 - 21	64-841-41A
18"	18E	20 - 22	64-841-18E	29"	29E	30 - 33	64-841-29E	41"	41B	21 - 24	64-841-41B
19"	19A	3 - 9	64-841-19A	30"	30A	13 - 18	64-841-30A	41"	41C	24 - 26	64-841-41C
19"	19B	9 - 15	64-841-19B	30"	30B	18 - 23	64-841-30B	41"	41D	26 - 28	64-841-41D
19"	19C	15 - 18	64-841-19C	30"	30C	23 - 26	64-841-30C	42"	42A	18 - 21	64-841-42A
19"	19D	18 - 20	64-841-19D	30"	30D	26 - 30	64-841-30D	42"	42B	21 - 24	64-841-42B
19"	19E	20 - 22	64-841-19E	30"	30E	30 - 33	64-841-30E	42"	42C	24 - 26	64-841-42C
20"	20A	4 - 10	64-841-20A	30"	30F	33 - 35	64-841-30F	42"	42D	26 - 28	64-841-42D
20"	20B	10 - 16	64-841-20B	31"	31A	13 - 18	64-841-31A	43"	43A	18 - 21	64-841-43A
20"	20C	16 - 19	64-841-20C	31"	31B	18 - 23	64-841-31B	43"	43B	21 - 24	64-841-43B
20"	20D	19 - 22	64-841-20D	31"	31C	23 - 26	64-841-31C	43"	43C	24 - 26	64-841-43C
20"	20E	22 - 25	64-841-20E	31"	31D	26 - 30	64-841-31D	43"	43D	26 - 28	64-841-43D
21"	21A	4 - 10	64-841-21A	31"	31E	30 - 33	64-841-31E	44"	44A	18 - 21	64-841-44A
21"	21B	10 - 16	64-841-21B	32"	32A	15 - 20	64-841-32A	44"	44B	21 - 24	64-841-44B
21"	21C	16 - 20	64-841-21C	32"	32B	20 - 24	64-841-32B	44"	44C	24 - 26	64-841-44C
21"	21D	20 - 24	64-841-21D	32"	32C	24 - 27	64-841-32C	44"	44D	26 - 28	64-841-44D
21"	21E	24 - 27	64-841-21E	32"	32D	27 - 30	64-841-32D				
22"	22A	5 - 11	64-841-22A	32"	32E	30 - 33	64-841-32E				

Suffix -19

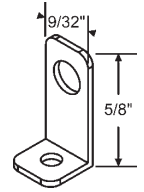

60-951
Clip

Suffix -34

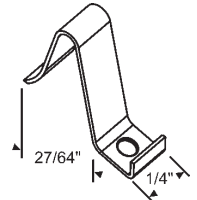

60-950
Clip

Suffix -Q

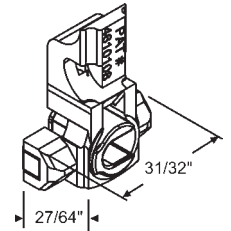

64-50000
T-Lock, Beige

Suffix -AZ

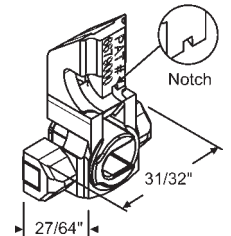

64-50001
T-Lock, Black

PIVOT BAR

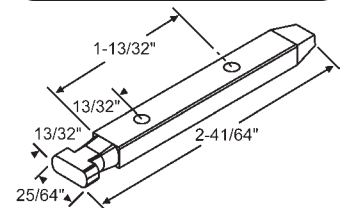

62-828
Zinc

SASH SUPPORT SYSTEMS

64B SERIES RIBBED TILT CHANNEL BALANCES

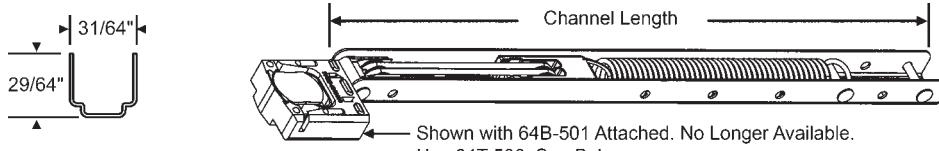

Ordering Information

1. Measure metal channel balance length. (Do not include any attachments.)
2. Identify number stamped on channel. (e.g. 21A, 24B, etc.)
3. Select our corresponding part number from the chart below.
4. Identify the appropriate end to be attached from list and add the appropriate suffix. (e.g. -1, -5, -22)
5. If white balance is needed add "W" to end of part number

Example Ordering Chart

Length of Metal Channel	Number Stamped on Balance	Our Part Number	End Clip Combination	Color	Complete Part Number
21"	21A	64B-21A	-1	White	64B-21A-1W
24"	24B	64B-24B	-1	Mill	64B-21A-1

Length of Metal Channel	Number Stamped on Balance	Sash Weight	Our Part Number	Length of Metal Channel	Number Stamped on Balance	Sash Weight	Our Part Number	Length of Metal Channel	Number Stamped on Balance	Sash Weight	Our Part Number
8"	8A	4 - 6	64B-8A	22"	22B	11 - 17	64B-22B	32"	32F	33 - 36	64B-32F
8"	8B	6 - 8	64B-8B	22"	22C	17 - 21	64B-22C	33"	33A	15 - 19	64B-33A
8"	8C	8 - 10	64B-8C	22"	22D	21 - 25	64B-22D	33"	33B	19 - 23	64B-33B
9"	9A	5 - 7	64B-9A	22"	22E	25 - 28	64B-22E	33"	33C	23 - 26	64B-33C
9"	9B	7 - 9	64B-9B	23"	23A	5 - 11	64B-23A	33"	33D	26 - 30	64B-33D
9"	9C	9 - 11	64B-9C	23"	23B	11 - 17	64B-23B	33"	33E	30 - 33	64B-33E
10"	10A	5 - 8	64B-10A	23"	23C	17 - 21	64B-23C	33"	33F	33 - 36	64B-33F
10"	10B	8 - 11	64B-10B	23"	23D	21 - 25	64B-23D	34"	34A	16 - 21	64B-34A
10"	10C	11 - 14	64B-10C	23"	23E	25 - 28	64B-23E	34"	34B	21 - 25	64B-34B
11"	11A	5 - 9	64B-11A	24"	24A	5 - 13	64B-24A	34"	34C	25 - 26	64B-34C
11"	11B	9 - 13	64B-11B	24"	24B	13 - 18	64B-24B	34"	34D	26 - 30	64B-34D
11"	11C	13 - 16	64B-11C	24"	24C	18 - 22	64B-24C	34"	34E	30 - 34	64B-34E
12"	12A	5 - 9	64B-12A	24"	24D	22 - 26	64B-24D	34"	34F	34 - 36	64B-34F
12"	12B	9 - 13	64B-12B	24"	24E	26 - 29	64B-24E	35"	35A	18 - 21	64B-35A
12"	12C	13 - 16	64B-12C	25"	25A	5 - 13	64B-25A	35"	35B	21 - 24	64B-35B
13"	13A	5 - 9	64B-13A	25"	25B	13 - 19	64B-25B	35"	35C	24 - 26	64B-35C
13"	13B	9 - 13	64B-13B	25"	25C	19 - 23	64B-25C	35"	35D	26 - 30	64B-35D
13"	13C	13 - 16	64B-13C	25"	25D	23 - 27	64B-25D	35"	35E	30 - 34	64B-35E
13"	13D	16 - 18	64B-13D	25"	25E	27 - 30	64B-25E	36"	36A	18 - 21	64B-36A
14"	14A	5 - 9	64B-14A	26"	26A	6 - 14	64B-26A	36"	36B	21 - 24	64B-36B
14"	14B	9 - 13	64B-14B	26"	26B	14 - 19	64B-26B	36"	36C	24 - 26	64B-36C
14"	14C	13 - 16	64B-14C	26"	26C	19 - 23	64B-26C	36"	36D	26 - 30	64B-36D
14"	14D	16 - 18	64B-14D	26"	26D	23 - 28	64B-26D	37"	37A	18 - 21	64B-37A
15"	15A	5 - 9	64B-15A	26"	26E	28 - 31	64B-26E	37"	37B	21 - 24	64B-37B
15"	15B	9 - 13	64B-15B	27"	27A	7 - 14	64B-27A	37"	37C	24 - 26	64B-37C
15"	15C	13 - 16	64B-15C	27"	27B	14 - 20	64B-27B	37"	37D	26 - 30	64B-37D
15"	15D	16 - 18	64B-15D	27"	27C	20 - 24	64B-27C	38"	38A	18 - 21	64B-38A
16"	16A	5 - 9	64B-16A	27"	27D	24 - 28	64B-27D	38"	38B	21 - 24	64B-38B
16"	16B	9 - 14	64B-16B	27"	27E	28 - 30	64B-27E	38"	38C	24 - 26	64B-38C
16"	16C	14 - 17	64B-16C	28"	28A	8 - 14	64B-28A	38"	38D	26 - 30	64B-38D
16"	16D	17 - 20	64B-16D	28"	28B	14 - 20	64B-28B	39"	39A	18 - 21	64B-39A
17"	17A	4 - 9	64B-17A	28"	28C	20 - 23	64B-28C	39"	39B	21 - 24	64B-39B
17"	17B	9 - 14	64B-17B	28"	28D	23 - 28	64B-28D	39"	39C	24 - 26	64B-39C
17"	17C	14 - 18	64B-17C	28"	28E	28 - 30	64B-28E	39"	39D	26 - 28	64B-39D
17"	17D	18 - 20	64B-17D	28"	28F	30 - 34	64B-28F	40"	40A	18 - 21	64B-40A
18"	18A	4 - 9	64B-18A	29"	29A	9 - 15	64B-29A	40"	40B	21 - 24	64B-40B
18"	18B	9 - 15	64B-18B	29"	29B	15 - 21	64B-29B	40"	40C	24 - 26	64B-40C
18"	18C	15 - 18	64B-18C	29"	29C	21 - 26	64B-29C	40"	40D	26 - 28	64B-40D
18"	18D	18 - 20	64B-18D	29"	29D	26 - 30	64B-29D	41"	41A	18 - 21	64B-41A
18"	18E	20 - 22	64B-18E	29"	29E	30 - 33	64B-29E	41"	41B	21 - 24	64B-41B
19"	19A	3 - 9	64B-19A	30"	30A	13 - 18	64B-30A	41"	41C	24 - 26	64B-41C
19"	19B	9 - 15	64B-19B	30"	30B	18 - 23	64B-30B	41"	41D	26 - 28	64B-41D
19"	19C	15 - 18	64B-19C	30"	30C	23 - 26	64B-30C	42"	42A	18 - 21	64B-42A
19"	19D	18 - 20	64B-19D	30"	30D	26 - 30	64B-30D	42"	42B	21 - 24	64B-42B
19"	19E	20 - 22	64B-19E	30"	30E	30 - 33	64B-30E	42"	42C	24 - 26	64B-42C
20"	20A	4 - 10	64B-20A	30"	30F	33 - 35	64B-30F	42"	42D	26 - 28	64B-42D
20"	20B	10 - 16	64B-20B	31"	31A	13 - 18	64B-31A	43"	43A	18 - 21	64B-43A
20"	20C	16 - 19	64B-20C	31"	31B	18 - 23	64B-31B	43"	43B	21 - 24	64B-43B
20"	20D	19 - 22	64B-20D	31"	31C	23 - 26	64B-31C	43"	43C	24 - 26	64B-43C
20"	20E	22 - 25	64B-20E	31"	31D	26 - 30	64B-31D	43"	43D	26 - 28	64B-43D
21"	21A	4 - 10	64B-21A	31"	31E	30 - 33	64B-31E	44"	44A	18 - 21	64B-44A
21"	21B	10 - 16	64B-21B	32"	32A	15 - 20	64B-32A	44"	44B	21 - 24	64B-44B
21"	21C	16 - 20	64B-21C	32"	32B	20 - 24	64B-32B	44"	44C	24 - 26	64B-44C
21"	21D	20 - 24	64B-21D	32"	32C	24 - 27	64B-32C	44"	44D	26 - 28	64B-44D
21"	21E	24 - 27	64B-21E	32"	32D	27 - 30	64B-32D				
22"	22A	5 - 11	64B-22A	32"	32E	30 - 33	64B-32E				

-1

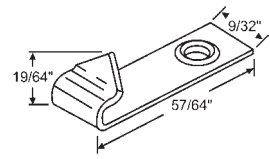

60-518

-5

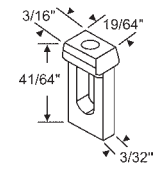

900-18354

-BC

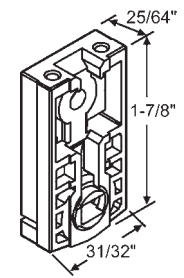

64T-506

64T SERIES CHANNEL BALANCE

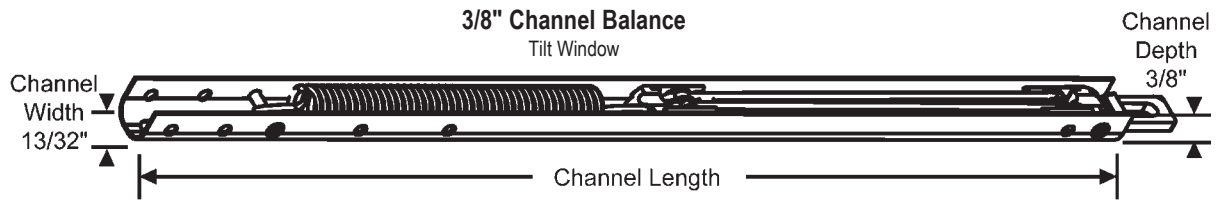

INSTRUCTIONS

1. Measure metal channel length (do not include attached clip)
2. Check number stamped on balance
3. Select our corresponding part number from chart below
4. Identify appropriate end to be attached from list and add appropriate suffix (eg: -5, -BC)
5. Select related accessories (see bottom of page)

Length of Metal Channel	Number Stamped on Balance	Sash Weight	Our Part Number	Length of Metal Channel	Number Stamped on Balance	Sash Weight	Our Part Number
11"	10A	2 - 4 lbs	64T-101	26"	25A	4 - 8 lbs	64T-251
11"	10B	4 - 7 lbs	64T-102	26"	25B	8 - 14 lbs	64T-252
11"	10C	7 - 12 lbs	64T-103	26"	25C	14 - 20 lbs	64T-253
12"	11A	3 - 6 lbs	64T-111	27"	26A	4 - 8 lbs	64T-261
12"	11B	6 - 9 lbs	64T-112	27"	26B	8 - 14 lbs	64T-262
12"	11C	9 - 12 lbs	64T-113	27"	26C	14 - 20 lbs	64T-263
13"	12A	3 - 7 lbs	64T-121	28"	27A	4 - 8 lbs	64T-271
13"	12B	7 - 12 lbs	64T-122	28"	27B	8 - 14 lbs	64T-272
13"	12C	12 - 15 lbs	64T-123	28"	27C	14 - 20 lbs	64T-273
14"	13A	3 - 7 lbs	64T-131	29"	28A	4 - 8 lbs	64T-281
14"	13B	7 - 12 lbs	64T-132	29"	28B	8 - 14 lbs	64T-282
14"	13C	12 - 15 lbs	64T-133	29"	28C	14 - 20 lbs	64T-283
15"	14A	3 - 7 lbs	64T-141	30"	29A	4 - 8 lbs	64T-291
15"	14B	7 - 12 lbs	64T-142	30"	29B	8 - 14 lbs	64T-292
15"	14C	12 - 16 lbs	64T-143	30"	29C	14 - 20 lbs	64T-293
16"	15A	3 - 7 lbs	64T-151	31"	30A	4 - 8 lbs	64T-301
16"	15B	7 - 12 lbs	64T-152	31"	30B	8 - 14 lbs	64T-302
16"	15C	12 - 16 lbs	64T-153	31"	30C	14 - 20 lbs	64T-303
17"	16A	3 - 7 lbs	64T-161	32"	31A	4 - 8 lbs	64T-311
17"	16B	7 - 12 lbs	64T-162	32"	31B	8 - 14 lbs	64T-312
17"	16C	12 - 18 lbs	64T-163	32"	31C	14 - 20 lbs	64T-313
18"	17A	3 - 7 lbs	64T-171	33"	32A	4 - 8 lbs	64T-321
18"	17B	7 - 12 lbs	64T-172	33"	32B	8 - 14 lbs	64T-322
18"	17C	12 - 18 lbs	64T-173	33"	32C	14 - 20 lbs	64T-323
19"	18A	4 - 8 lbs	64T-181	34"	33A	4 - 8 lbs	64T-331
19"	18B	8 - 12 lbs	64T-182	34"	33B	8 - 14 lbs	64T-332
19"	18C	12 - 18 lbs	64T-183	34"	33C	14 - 20 lbs	64T-333
20"	19A	4 - 8 lbs	64T-191	35"	34A	4 - 8 lbs	64T-341
20"	19B	8 - 12 lbs	64T-192	35"	34B	8 - 14 lbs	64T-342
20"	19C	12 - 18 lbs	64T-193	35"	34C	14 - 20 lbs	64T-343
21"	20A	4 - 8 lbs	64T-201	36"	35A	4 - 8 lbs	64T-351
21"	20B	8 - 13 lbs	64T-202	36"	35B	8 - 14 lbs	64T-352
21"	20C	13 - 18 lbs	64T-203	36"	35C	14 - 20 lbs	64T-353
22"	21A	4 - 8 lbs	64T-211	37"	36A	4 - 8 lbs	64T-361
22"	21B	8 - 13 lbs	64T-212	37"	36B	8 - 14 lbs	64T-362
22"	21C	13 - 18 lbs	64T-213	37"	36C	14 - 20 lbs	64T-363
23"	22A	4 - 8 lbs	64T-221	38"	37A	4 - 8 lbs	64T-371
23"	22B	8 - 12 lbs	64T-222	38"	37B	8 - 14 lbs	64T-372
23"	22C	12 - 18 lbs	64T-223	38"	37C	14 - 20 lbs	64T-373
24"	23A	4 - 8 lbs	64T-231	39"	38A	4 - 8 lbs	64T-381
24"	23B	8 - 13 lbs	64T-232	39"	38B	8 - 14 lbs	64T-382
24"	23C	13 - 20 lbs	64T-233	39"	38C	14 - 20 lbs	64T-383
25"	24A	4 - 8 lbs	64T-241				
25"	24B	8 - 13 lbs	64T-241				
25"	24C	13 - 20 lbs	64T-243				

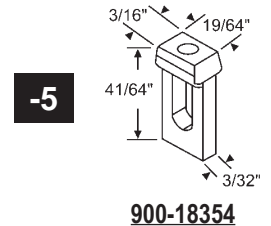

-5

900-18354

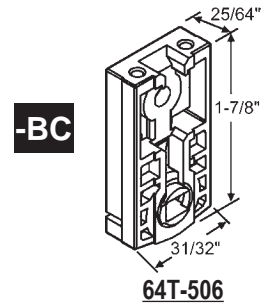

-BC

64T-506

64T SERIES BALANCE ACCESSORIES

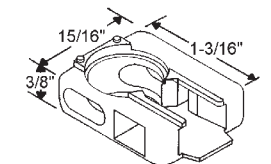

64T-500

Terminal Housing

5/8" TUBE BALANCE

Tube diameter 9/16" but considered 5/8" in the trade.

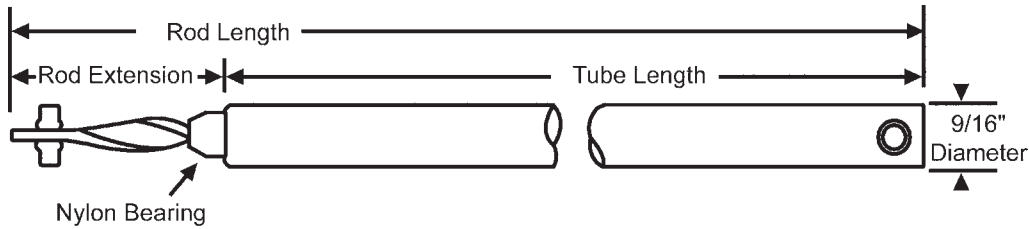

Ordering Information

- 1) Measure metal tube length. (Do not include nylon bearing.)
- 2) Measure spiral rod length. (Make sure rod is flush with screw hole end of tube before measuring.)
- 3) Identify the color of the bearing (e.g., white, red, blue or black) and select our corresponding part number from the chart below.
- 4) To identify any attaching brackets or accessories used with your balance, refer to pages 79-81.

Note: Brackets and accessories must be ordered separately.

General Information

- 1) Maximum tube balance length available is 60".
- 2) White, red and blue bearings are for sashes weighing up to 30 lbs; the black bearing with nyclud tip is for sashes weighing up to 40 lbs. Please consult your sales representative for special ordering information.
- 3) The appropriate tensioning tools are 70-515 and 70-516 as shown on pages 81 and 123.

Standard Rod

Tube Length	Rod Length	Red Bearing	Blue Bearing	Black Bearing
9"	9-3/4"	70-N9SR	---	---
10"	10-3/4"	70-N10SR	---	---
11"	11-3/4"	70-N11SR	---	---
12"	12-3/4"	70-N12SR	70-N12SB	---
13"	13-3/4"	70-N13SR	70-N13SB	---
14"	14-3/4"	70-N14SR	70-N14SB	---
15"	15-3/4"	70-N15SR	70-N15SB	---
16"	16-3/4"	70-N16SR	---	---
17"	17-3/4"	70-N17SR	70-N17SB	70-L17S
18"	18-3/4"	70-N18SR	70-N18SB	70-L18S
19"	19-3/4"	70-N19SR	70-N19SB	70-L19S
20"	20-3/4"	70-N20SR	70-N20SB	70-L20S
21"	21-3/4"	70-N21SR	70-N21SB	70-L21S
22"	22-3/4"	70-N22SR	70-N22SB	70-L22S
23"	23-3/4"	70-N23SR	70-N23SB	70-L23S
24"	24-3/4"	70-N24SR	70-N24SB	70-L24S
25"	25-3/4"	70-N25SR	70-N25SB	70-L25S
26"	26-3/4"	70-N26SR	70-N26SB	70-L26S
27"	27-3/4"	70-N27SR	70-N27SB	70-L27S
28"	28-3/4"	70-N28SR	70-N28SB	70-L28S
29"	29-3/4"	70-N29SR	70-N29SB	70-L29S
30"	30-3/4"	70-N30SR	70-N30SB	70-L30S
31"	31-3/4"	70-N31SR	70-N31SB	70-L31S
32"	32-3/4"	70-N32SR	70-N32SB	70-L32S
33"	33-3/4"	70-N33SR	---	70-L33S
34"	34-3/4"	70-N34SR	---	70-L34S
35"	35-3/4"	70-N35SR	---	70-L35S
36"	36-3/4"	70-N36SR	---	70-L36S
37"	37-3/4"	70-N37SR	---	70-L37S
38"	38-3/4"	70-N38SR	---	70-L38S
39"	39-3/4"	70-N39SR	---	70-L39S
40"	40-3/4"	70-N40SR	---	70-L40S
41"	41-3/4"	70-N41SR	---	70-L41S
42"	42-3/4"	70-N42SR	---	70-L42S
43"	43-3/4"	70-N43SR	---	70-L43S
44"	44-3/4"	70-N44SR	---	70-L44S
45"	45-3/4"	70-N45SR	---	70-L45S
46"	46-3/4"	70-N46SR	---	70-L46S
47"	47-3/4"	70-N47SR	---	70-L47S
48"	48-3/4"	70-N48SR	---	70-L48S
49"	49-3/4"	70-N49SR	---	70-L49S
50"	50-3/4"	70-N50SR	---	70-L50S

Extended Rod

Tube Length	Rod Length	Red Bearing	Blue Bearing
9"	10-3/4"	70-N9RR	---
10"	11-3/4"	70-N10RR	---
11"	12-3/4"	70-N11RR	---
12"	13-3/4"	70-N12RR	70-N12RB
13"	14-3/4"	70-N13RR	70-N13RB
14"	15-3/4"	70-N14RR	70-N14RB
15"	16-3/4"	70-N15RR	70-N15RB
16"	17-3/4"	70-N16RR	70-N16RB
17"	18-3/4"	70-N17RR	70-N17RB
18"	19-3/4"	70-N18RR	70-N18RB
19"	20-3/4"	70-N19RR	70-N19RB
20"	21-3/4"	70-N20RR	70-N20RB
21"	22-3/4"	70-N21RR	70-N21RB
22"	23-3/4"	70-N22RR	70-N22RB
23"	24-3/4"	70-N23RR	70-N23RB
24"	25-3/4"	70-N24RR	70-N24RB
25"	26-3/4"	70-N25RR	70-N25RB
26"	27-3/4"	70-N26RR	70-N26RB
27"	28-3/4"	70-N27RR	70-N27RB
28"	29-3/4"	70-N28RR	70-N28RB
29"	30-3/4"	70-N29RR	70-N29RB
30"	31-3/4"	70-N30RR	70-N30RB
31"	32-3/4"	70-N31RR	70-N31RB
32"	33-3/4"	70-N32RR	70-N32RB
33"	34-3/4"	70-N33RR	---
34"	35-3/4"	70-N34RR	---
35"	36-3/4"	70-N35RR	---
36"	37-3/4"	70-N36RR	---
37"	38-3/4"	70-N37RR	---
38"	39-3/4"	70-N38RR	---
39"	40-3/4"	70-N39RR	---
40"	41-3/4"	70-N40RR	---
41"	42-3/4"	70-N41RR	---
42"	43-3/4"	70-N42RR	---
43"	44-3/4"	70-N43RR	---
44"	45-3/4"	70-N44RR	---
45"	46-3/4"	70-N45RR	---
46"	47-3/4"	70-N46RR	---
47"	48-3/4"	70-N47RR	---
48"	49-3/4"	70-N48RR	---
49"	50-3/4"	70-N49RR	---
50"	51-3/4"	70-N50RR	---

70 SERIES BALANCE ACCESSORIES

METAL BRACKETS

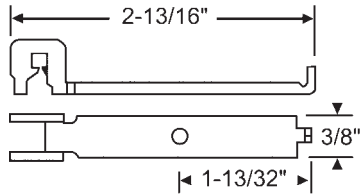

Part #	Description
70-503	Metal
70-503SS	Stainless Steel

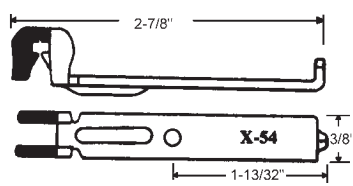

Part #	Description
70-502N	Nyclad Coated
70-502	Not Coated

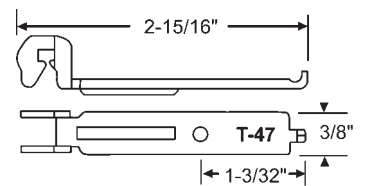

70-501

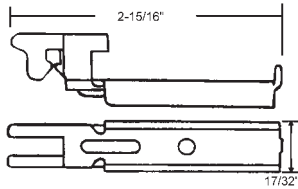

70-504

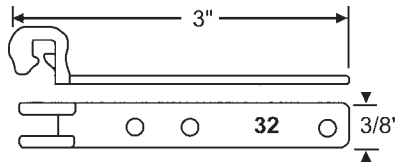

70-500

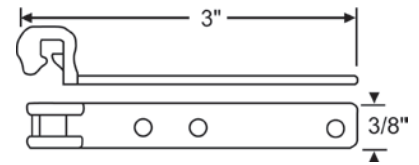

70-524

Used with Retainer Guide 70-626

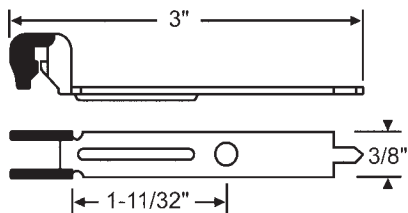

70-534N
Nyclad Coated

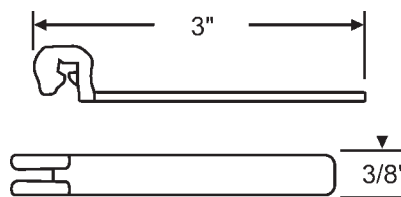

70-526

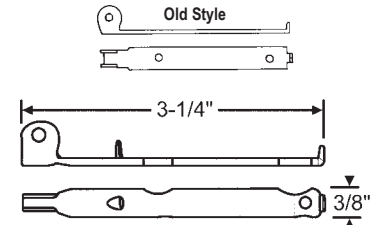

70-523
Riveted Type
Used with Rivet 74-509

BALANCE SHOES

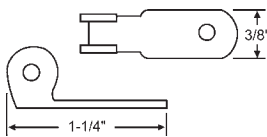

70-523C

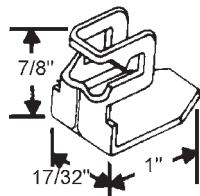

70-521
Metal
ALWINSEAL

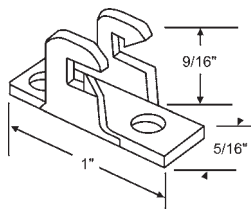

Part #	Description
70-505	Metal
70-505SS	Stainless Steel

Side Mount

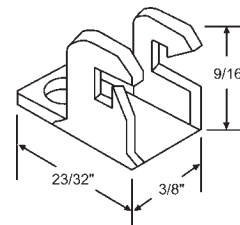

70-506
Metal
Side Mount

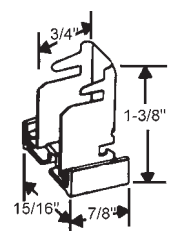

Part #	Hand
70-514RH	Shown

STANLEY

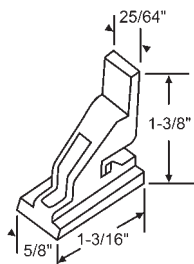

70-510
TUCKER/
GEORGIA PALM BEACH

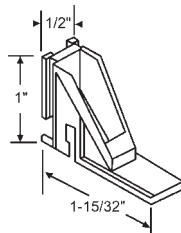

70-513
Use with 70-600 Sash Clip
ABC/HARCAR

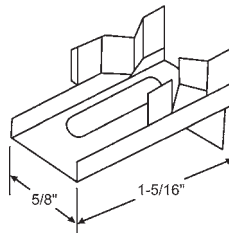

70-600
Metal Sash Clip for 70-513
ABC/HARCAR

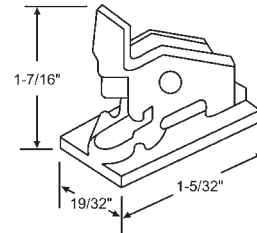

70-509
TUCKER/
GEORGIA PALM BEACH

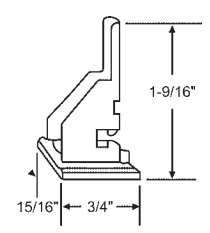

70-508
Use with 70-629 Retainer
CROSSLY

SASH SUPPORT SYSTEMS

70 SERIES BALANCE ACCESSORIES

BALANCE SHOES

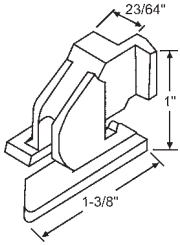

70-511A

Sold in Sets Only
CUPPLES

BALANCE BRACKET

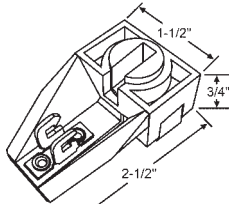

900-10697A

Balance Bracket Assembly w/
Cam and Pawl
SWS

TOP SASH CAMS

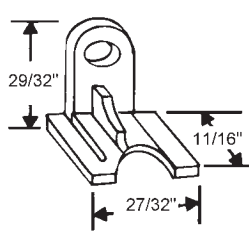

70-602

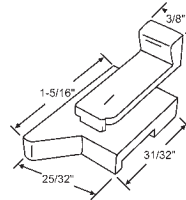

Part #	Hand
70-615	Shown
70-616	Opposite

Black Plastic
CALCO ALUM. CO.

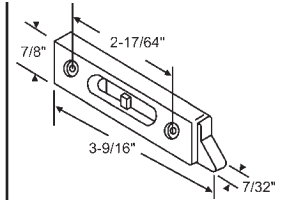

Part #	Hand
70-617	Shown

Black Top Sash Cam Assembly
New Style
CALCO ALUM. CO.

BALANCE CAPS

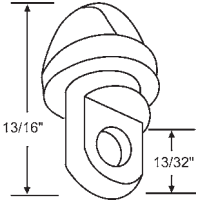

70-517

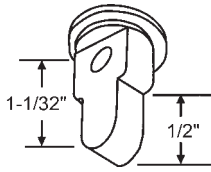

70-528

GEORGIA PALM BEACH

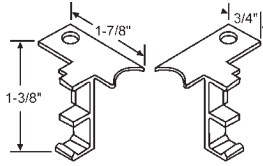

70-627

Two Piece
Die Cast

GUIDES

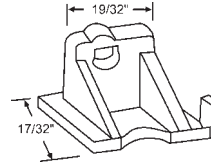

70-606A

Nylon Sold in Sets Only
CROSSLY

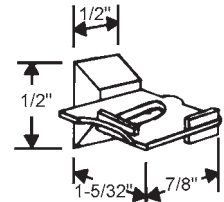

70-621

Nylon Top Sash Guide

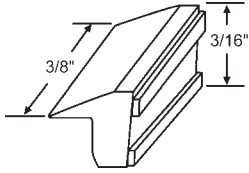

70-624

Nylon

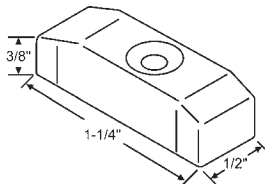

900-5095

Nylon

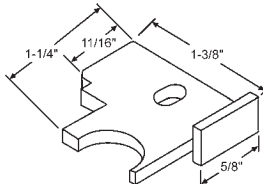

70-639

Nylon

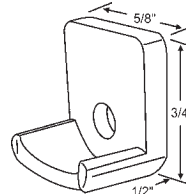

70-603

White Plastic
GEORGIA PALM BEACH

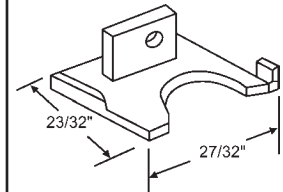

70-612

Sold in Sets Only. RH Shown.
Nylon. Use with Balance Shoes
70-514LH & RH
STANLEY

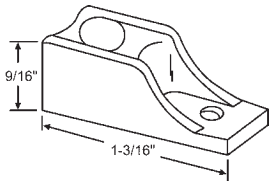

70-620

Nylon

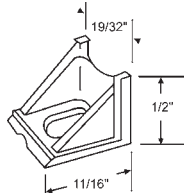

70-601

Off White Plastic

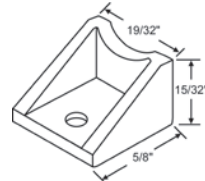

70-605

Gray Plastic

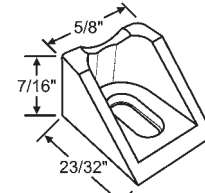

70-625

Nylon

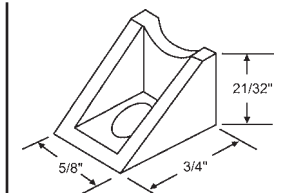

70-635

Nylon

SCREW BUSHING

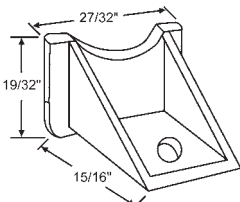

70-622

Nylon

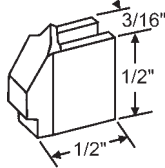

900-6891

AIRE-LOK

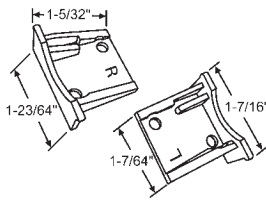

70-655B

Sash Guide Set. Black
PGT

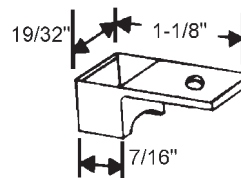

70-623

Nylon. Use with 72-500 Carrier
and 72-603 Sash Clip

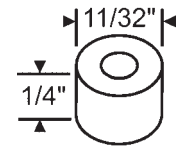

62-613

Used with Screw 20-048
CALCO ALUM. CO.

70 SERIES BALANCE ACCESSORIES

RETAINER

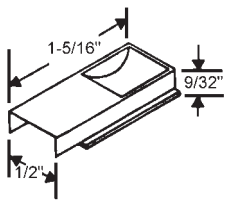

70-629
Nylon

TILT PIVOT

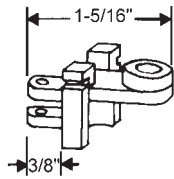

70-519
Black Plastic
CALCO ALUM. CO.

SASH STOPS

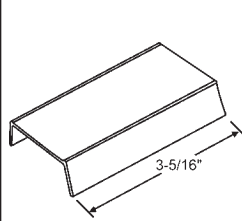

70-712
Black
YALE/ OGRON

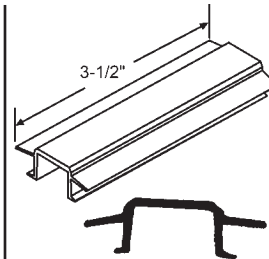

900-20095BE-3.5
Beige Plastic

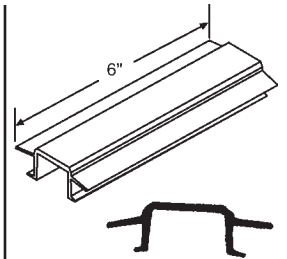

Part #	Color
900-20095W	White
900-20095	Beige

Plastic

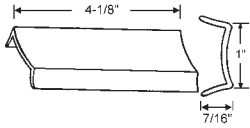

70-702
White Plastic

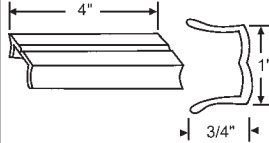

70-700
White Plastic

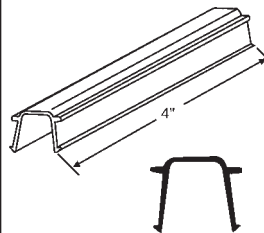

Part #	Color
70-710B	Black
70-710	White

Plastic

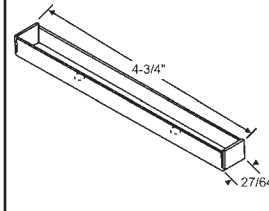

70-707
Metal

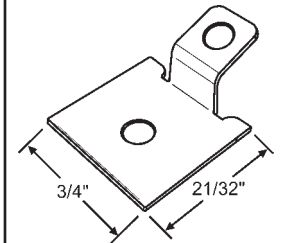

70-713
Aluminum
PAN AM

BALANCE EXTENDER TOOL

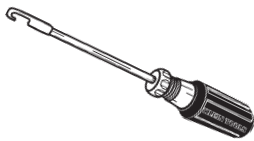

59-42

BALANCE TENSION TOOLS

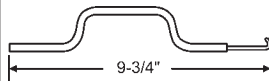

70-515

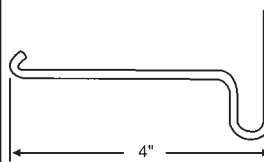

70-516

MISCELLANEOUS ACCESSORIES

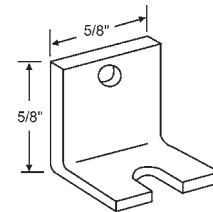

70-704
Metal Angle Clip
GEORGIA PALM BEACH

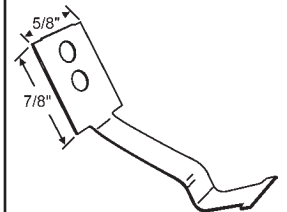

70-705
Metal Vent Spring
GEORGIA PALM BEACH

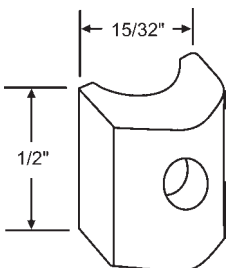

70-709
Nylon Backing Block
GEORGIA PALM BEACH

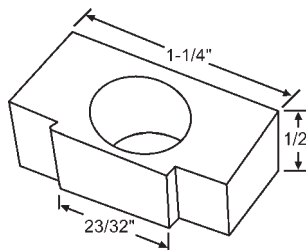

Part #	Color
900-11391	White

Balance Plug

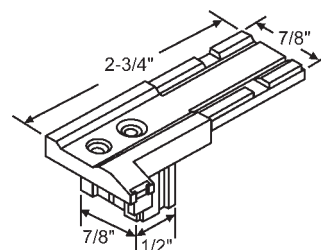

Part #	Hand
900-2350	Shown
900-2349	Opposite

Black Plastic Corner Assembly

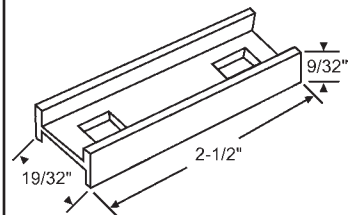

70-604
Aluminum Sash Carrier Lock
GEORGIA PALM BEACH

72 SERIES BALANCES

5/8" TUBE BALANCE

Tube diameter 9/16" but considered 5/8" in the trade.

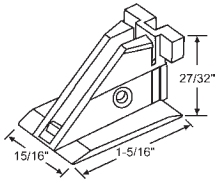

Balance Carrier

See page 83

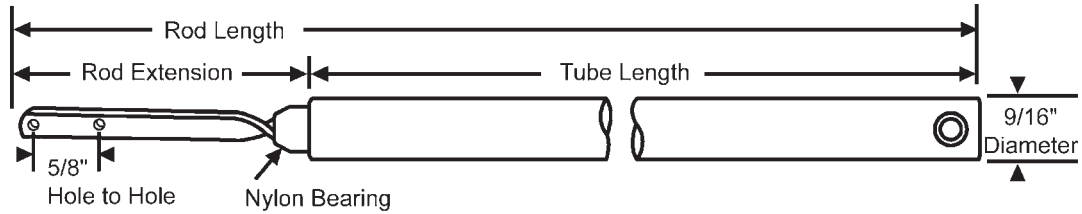

Ordering Information

- 1) Measure metal tube length (Do not include nylon bearing).
- 2) Measure spiral rod length (Make sure rod is flush with screw hole end of tube before measuring).
- 3) Identify the color of the bearing (e.g., white, red or blue) and select our corresponding part number from the chart below.
- 4) To identify the appropriate carrier or shoe to be attached and other related accessories, see page 83.

Note: Attached carriers and related accessories must be ordered separately. If you want the ends attached, add the letter "A" to the suffix of the accessory part number when ordering.

Note: If a window tilts in and balance has 2 pins, refer to our 83 and 85 series balances on pages 95 and 101.

Standard Rod

Tube Length	Rod Length	White Bearing	Red Bearing
10"	11-5/8"	72-P10SW	---
11"	12-5/8"	72-P11SW	---
12"	13-5/8"	72-P12SW	72-P12SR
13"	14-5/8"	72-P13SW	72-P13SR
14"	15-5/8"	72-P14SW	72-P14SR
15"	16-5/8"	72-P15SW	72-P15SR
16"	17-5/8"	---	72-P16SR
17"	18-5/8"	---	72-P17SR
18"	19-5/8"	---	72-P18SR
19"	20-5/8"	---	72-P19SR
20"	21-5/8"	---	72-P20SR
21"	22-5/8"	---	72-P21SR
22"	23-5/8"	---	72-P22SR
23"	24-5/8"	---	72-P23SR
24"	25-5/8"	---	72-P24SR
25"	26-5/8"	---	72-P25SR
26"	27-5/8"	---	72-P26SR
27"	28-5/8"	---	72-P27SR
28"	29-5/8"	---	72-P28SR
29"	30-5/8"	72-P29SW	72-P29SR
30"	31-5/8"	---	72-P30SR
31"	32-5/8"	72-P31SW	72-P31SR
32"	33-5/8"	---	72-P32SR
33"	34-5/8"	---	72-P33SR
34"	35-5/8"	---	72-P34SR
35"	36-5/8"	72-P35SW	72-P35SR
36"	37-5/8"	---	72-P36SR
37"	38-5/8"	72-P37SW	72-P37SR
38"	39-5/8"	72-P38SW	72-P38SR
39"	40-5/8"	---	72-P39SR
40"	41-5/8"	72-P40SW	72-P40SR
41"	42-5/8"	72-P41SW	72-P41SR
42"	43-5/8"	72-P42SW	72-P42SR
43"	44-5/8"	---	72-P43SR
44"	45-5/8"	72-P44SW	72-P44SR
45"	46-5/8"	72-P45SW	72-P45SR
46"	47-5/8"	72-P46SW	72-P46SR
47"	48-5/8"	72-P47SW	72-P47SR
48"	49-5/8"	72-P48SW	72-P48SR
49"	50-5/8"	72-P49SW	72-P49SR
50"	51-5/8"	72-P50SW	72-P50SR

Extended Rod

Tube Length	Rod Length	White Bearing	Red Bearing
10"	12-5/8"	72-P10RW	---
11"	13-5/8"	72-P11RW	---
12"	14-5/8"	72-P12RW	72-P12RR
13"	15-5/8"	---	72-P13RR
14"	16-5/8"	72-P14RW	72-P14RR
15"	17-5/8"	72-P15RW	72-P15RR
16"	18-5/8"	---	72-P16RR
17"	19-5/8"	---	72-P17RR
18"	20-5/8"	---	72-P18RR
19"	21-5/8"	---	72-P19RR
20"	22-5/8"	---	72-P20RR
21"	23-5/8"	---	72-P21RR
22"	24-5/8"	---	72-P22RR
23"	25-5/8"	---	72-P23RR
24"	26-5/8"	---	72-P24RR
25"	27-5/8"	---	72-P25RR
26"	28-5/8"	---	72-P26RR
27"	29-5/8"	---	72-P27RR
28"	30-5/8"	---	72-P28RR
29"	31-5/8"	---	72-P29RR
30"	32-5/8"	72-P30RW	72-P30RR
31"	33-5/8"	72-P31RW	72-P31RR
32"	34-5/8"	72-P32RW	72-P32RR
33"	35-5/8"	72-P33RW	72-P33RR
34"	36-5/8"	72-P34RW	72-P34RR
35"	37-5/8"	72-P35RW	72-P35RR
36"	38-5/8"	72-P36RW	72-P36RR
37"	39-5/8"	72-P37RW	72-P37RR
38"	40-5/8"	---	72-P38RR
39"	41-5/8"	---	72-P39RR
40"	42-5/8"	---	72-P40RR
41"	43-5/8"	---	72-P41RR
42"	44-5/8"	72-P42RW	72-P42RR
43"	45-5/8"	72-P43RW	72-P43RR
44"	46-5/8"	72-P44RW	72-P44RR
45"	47-5/8"	72-P45RW	72-P45RR
46"	48-5/8"	72-P46RW	72-P46RR
47"	49-5/8"	72-P47RW	72-P47RR
48"	50-5/8"	72-P48RW	72-P48RR
49"	51-5/8"	72-P49RW	72-P49RR
50"	52-5/8"	72-P50RW	72-P50RR

An extra long extended rod is available with red bearings on the following sizes only:

Double Extended Rod

Tube Length	Rod Length	Part Number
15"	18-5/8"	72-P15RRR
19"	22-5/8"	72-P19RRR
21"	24-5/8"	72-P21RRR
23"	26-5/8"	72-P23RRR
27"	30-5/8"	72-P27RRR
33"	36-5/8"	72-P33RRR

Used Primarily by Keller

- The appropriate tensioning tools are 70-515 and 70-516 as shown on pages 81 and 123.
- Many customers confuse this series with our 85 tilt series on page 101.
- 72 series always comes with a plastic guide attachment to the 2nd hole.

Note: Mostly "red bearings" are used for repairs. "Blue bearings" were not used on original windows but used when heavier glass was added. Blue bearing balances can be special ordered.

72 SERIES BALANCE ACCESSORIES

CARRIERS

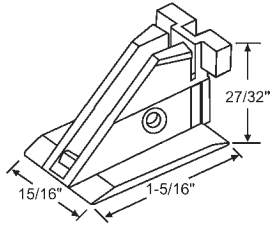

Part #	Color
72-500	White

PORTALUME

Part #	Color
72-501	Black

KELLER

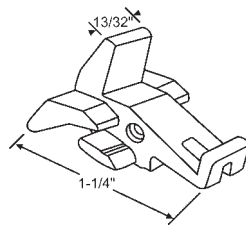

72-503
White
SILVER LINE

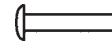

72-504
3/32" Diameter
3/8" Length



72-502
5/64" Diameter
3/8" Length

TOP SASH GUIDE

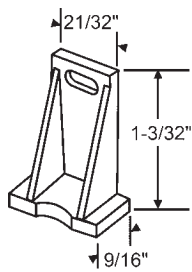

72-604
KELLER

SASH CLIPS

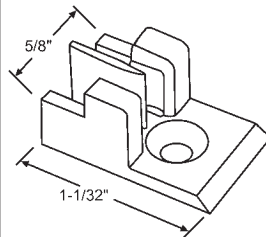

72-607
HOWARD

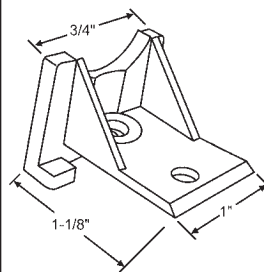

72-608A
Sold as Set Only. RH Shown.
HOWARD

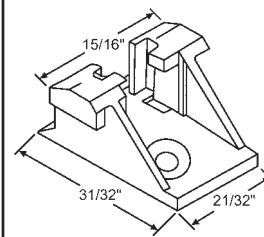

72-605A
Sold in Sets Only
KELLER

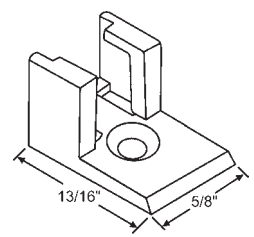

72-600
PORTALUME

BUSHING

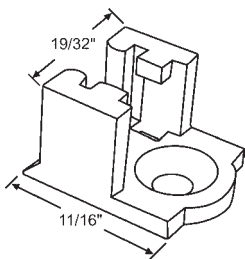

72-601

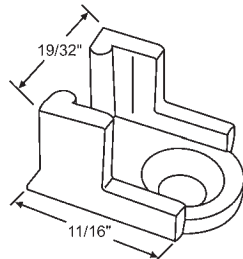

72-602

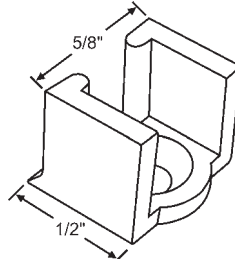

72-603
Sash clip

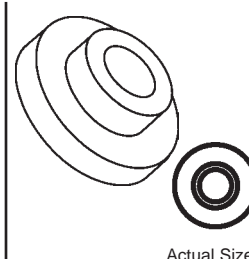

72-800

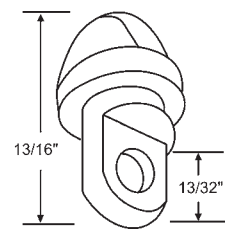

70-517

SIDE RAIL GUIDE

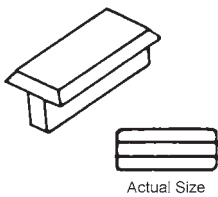

Part #	Finish
72-802	White
72-803	Black

RETAINERS

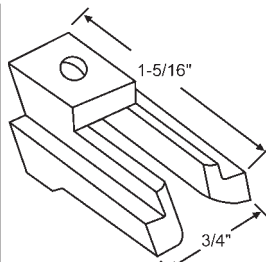

74-715
White Nylon
AIR CONTROL

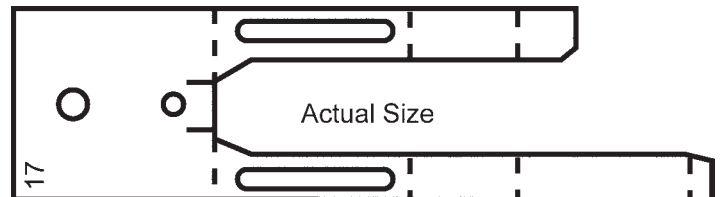

72-700
Metal

3/8" TUBE BALANCE

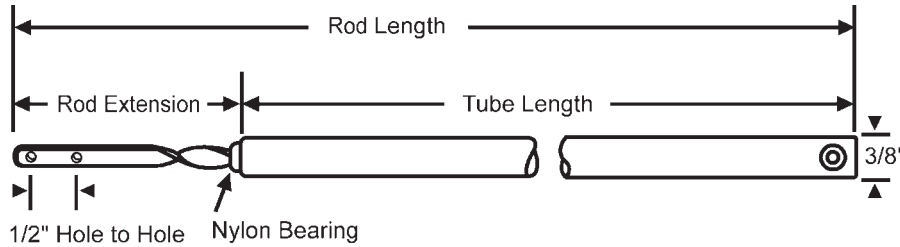
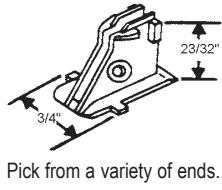

Note: If a window tilts in and balance has 2 pins, refer to our 83 and 85 series balances on pages 96 and 102.

Ordering Information

- 1) Measure metal tube length (Do not include nylon bearing).
- 2) Measure spiral rod length. (Make sure rod is flush with screw hole end of tube before measuring.)
- 3) Identify the color of the bearing (e.g., white, red or blue) and select our corresponding part number from the chart below.
- 4) To identify the appropriate carrier or shoe to be attached and other related accessories, see page 85.

Note: Attached carriers and related accessories must be ordered separately. If you want the ends attached, add the letter "A" to the suffix of the part number when ordering.

General Information

- 1) White, red and blue bearings are for sashes weighing up to 22 lbs; green bearings are for sashes weighing up to 26 lbs. Consult your sales representative for ordering information.
- 2) The appropriate tensioning tools are 70-515 and 70-516 as shown on pages 81 and 123.

This series always comes with a shoe or bracket attached. Some customers confuse this series with our 83 series tilt balances on page 95.

Standard Rod

Tube Length	Rod Length	White Bearing	Red Bearing	Blue Bearing	Green* Bearing
10"	10-3/4"	74-S10	---	---	---
11"	11-3/4"	74-S11	---	---	---
12"	12-3/4"	74-S12	---	---	---
13"	13-3/4"	74-S13	74-S13R	---	---
14"	14-3/4"	74-S14	74-S14R	---	---
15"	15-3/4"	74-S15	74-S15R	74-S15B	---
16"	16-3/4"	---	74-S16R	74-S16B	---
17"	17-3/4"	---	74-S17R	74-S17B	---
18"	18-3/4"	---	74-S18R	74-S18B	---
19"	19-3/4"	---	74-S19R	74-S19B	---
20"	20-3/4"	---	74-S20R	74-S20B	---
21"	21-3/4"	---	74-S21R	74-S21B	---
22"	22-3/4"	---	74-S22R	74-S22B	---
23"	23-3/4"	---	74-S23R	74-S23B	74-S23G
24"	24-3/4"	---	74-S24R	74-S24B	---
25"	25-3/4"	---	74-S25R	74-S25B	74-S25G
26"	26-3/4"	---	74-S26R	---	---
27"	27-3/4"	74-S27	74-S27R	---	---
28"	28-3/4"	---	74-S28R	---	74-S28G
29"	29-3/4"	---	74-S29R	---	74-S29G
30"	30-3/4"	---	74-S30R	---	74-S30G
31"	31-3/4"	---	74-S31R	---	---
32"	32-3/4"	---	74-S32R	---	---
33"	33-3/4"	74-S33	---	---	---
34"	34-3/4"	74-S34	---	---	74-S34G
35"	35-3/4"	74-S35	---	---	---
36"	36-3/4"	74-S36	---	---	74-S36G
37"	37-3/4"	74-S37	---	---	---
38"	38-3/4"	74-S38	---	---	---
39"	39-3/4"	74-S39	---	---	---
40"	40-3/4"	74-S40	---	---	---

Extended Rod

Tube Length	Rod Length	White Bearing	Red Bearing	Blue Bearing	Green* Bearing
10"	11-3/4"	74-10	---	---	---
11"	12-3/4"	---	---	---	---
12"	13-3/4"	74-12	---	---	---
13"	14-3/4"	74-13	74-13R	---	---
14"	15-3/4"	74-14	74-14R	---	---
15"	16-3/4"	74-15	74-15R	74-15B	---
16"	17-3/4"	---	74-16R	74-16B	---
17"	18-3/4"	---	74-17R	74-17B	---
18"	19-3/4"	---	74-18R	74-18B	---
19"	20-3/4"	---	74-19R	74-19B	---
20"	21-3/4"	---	74-20R	74-20B	---
21"	22-3/4"	---	74-21R	74-21B	---
22"	23-3/4"	---	74-22R	74-22B	---
23"	24-3/4"	---	74-23R	74-23B	---
24"	25-3/4"	---	74-24R	74-24B	---
25"	26-3/4"	---	74-25R	74-25B	---
26"	27-3/4"	---	74-26R	---	---
27"	28-3/4"	---	74-27R	---	---
28"	29-3/4"	---	74-28R	---	74-28G
29"	30-3/4"	---	74-29R	---	74-29G
30"	31-3/4"	74-30	74-30R	---	74-30G
31"	32-3/4"	74-31	74-31R	---	74-31G
32"	33-3/4"	74-32	74-32R	---	---
33"	34-3/4"	74-33	---	---	---
34"	35-3/4"	74-34	---	---	---
35"	36-3/4"	74-35	---	---	---
36"	37-3/4"	74-36	---	---	---
37"	38-3/4"	74-37	---	---	---
38"	39-3/4"	74-38	---	---	---
39"	40-3/4"	74-39	---	---	---
40"	41-3/4"	74-40	---	---	---

*Other sizes available upon request.

74 SERIES BALANCE ACCESSORIES

CARRIERS

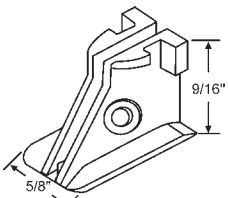

74-501

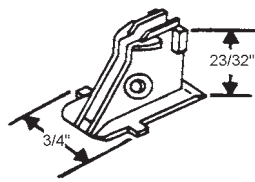

74-502
AIRMASTER

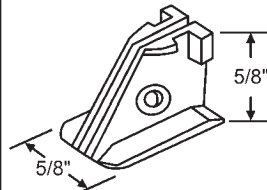

74-503
KELLER

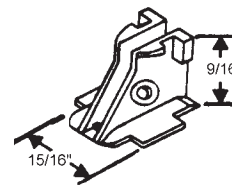

74-504

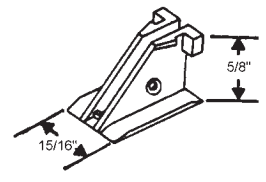

74-510
KELLER

BALANCE CAP

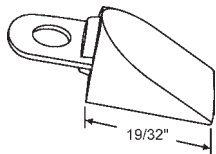

74-505

BALANCE SHOE

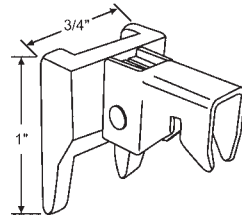

74-508
LOOK

RIVETS

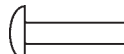

74-509
3/32" Diameter
13/32" Length



74-500
3/32" Diameter
9/32" Length

NYLON RETAINER

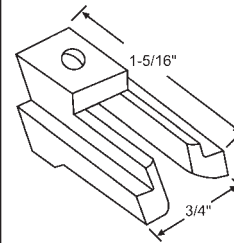

74-715
White Nylon
All metal retainers are
obsolete. 74-715 will work
in most applications.

TOP SASH GUIDES

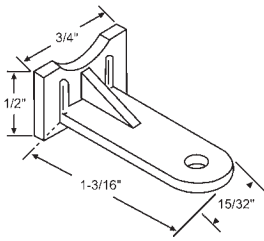

900-5955

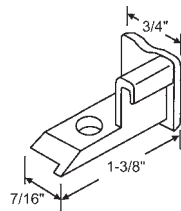

74-602A
LH and RH Set
AIRMASTER

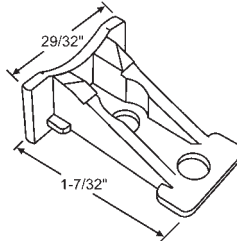

74-607
KELLER

FACE GUIDE

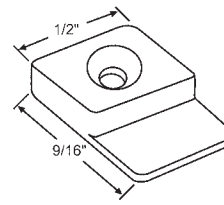

76-600
Uses Screw 20-004

ROUND FACE GUIDE

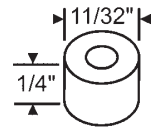

62-613
Nylon Bushing
KELLER

WINDOW GUIDE

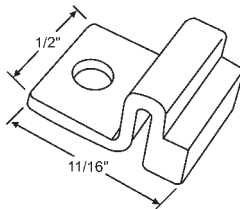

74-612

SASH STOP

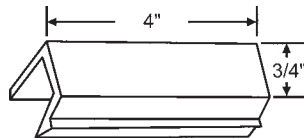

74-713
White

SASH CLIPS

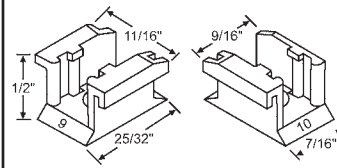

74-600A
LH and RH Set
AIRMASTER

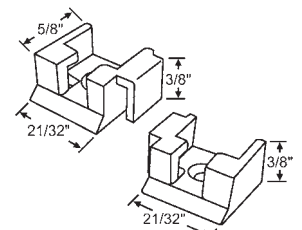

74-611
LH and RH Set
KELLER

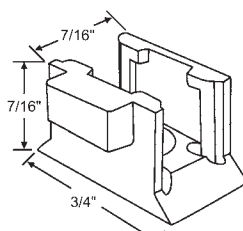

74-604

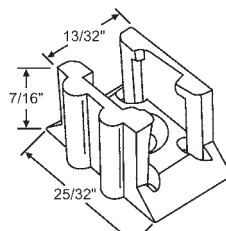

74-605

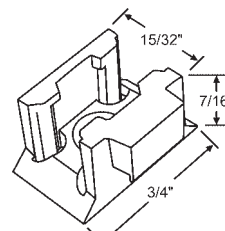

74-606

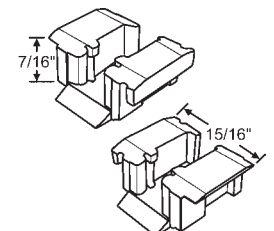

74-609
KELLER

75 SERIES BALANCES

3/8" TUBE BALANCE

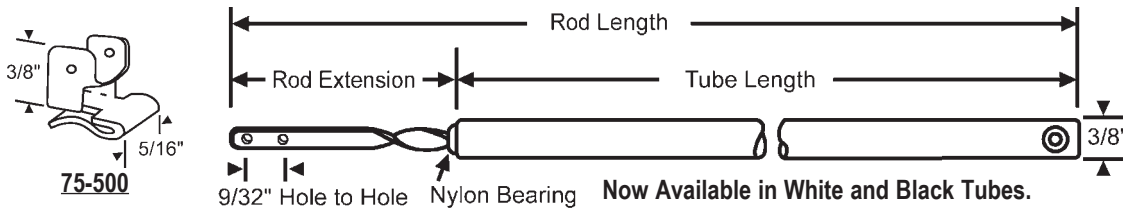

Note: The difference between our "74" and "75" series balances is in the hole center distance in the spiral rod.

Note: If a window tilts in and balance has 2 pins, refer to our 83 and 85 series balances on pages 95 and 101.

Ordering Information

1. Measure metal tube length. (Do not include nylon bearing.)
2. Measure spiral rod length. (Make sure rod is flush with screw hole end of tube before measuring.)
3. Identify the color of the bearing (e.g., white, red or blue) and select our corresponding part number from the chart below.
4. To identify the appropriate carrier or shoe to be attached and other related accessories, see bottom of the page.

Note: Attached carriers and related accessories must be ordered separately. If you want the ends attached, add the letter "A" to the suffix of the part number when ordering.

Standard Rod

Tube Length	Rod Length	White Bearing	Red Bearing	Blue Bearing	Green Bearing*
10"	10-9/16"	75-S10	---	---	---
11"	11-9/16"	75-S11	---	---	---
12"	12-9/16"	75-S12	---	---	---
13"	13-9/16"	75-S13	75-S13R	---	---
14"	14-9/16"	75-S14	75-S14R	---	---
15"	15-9/16"	75-S15	75-S15R	75-S15B	---
16"	16-9/16"	---	75-S16R	75-S16B	---
17"	17-9/16"	---	75-S17R	75-S17B	---
18"	18-9/16"	---	75-S18R	75-S18B	75-S18G
19"	19-9/16"	---	75-S19R	75-S19B	75-S19G
20"	20-9/16"	75-S20	75-S20R	75-S20B	---
21"	21-9/16"	75-S21	75-S21R	75-S21B	---
22"	22-9/16"	75-S22	75-S22R	75-S22B	75-S22G
23"	23-9/16"	75-S23	75-S23R	75-S23B	75-S23G
24"	24-9/16"	75-S24	75-S24R	75-S24B	75-S24G
25"	25-9/16"	75-S25	75-S25R	75-S25B	---
26"	26-9/16"	75-S26	75-S26R	---	---
27"	27-9/16"	75-S27	75-S27R	---	---
28"	28-9/16"	75-S28	75-S28R	---	75-S28G
29"	29-9/16"	---	75-S29R	---	75-S29G
30"	30-9/16"	75-S30	75-S30R	---	75-S30G
31"	31-9/16"	---	75-S31R	---	75-S31G
32"	32-9/16"	75-S32	75-S32R	---	---
33"	33-9/16"	75-S33	---	---	---
34"	34-9/16"	75-S34	---	---	---
35"	35-9/16"	75-S35	---	---	75-S35G
36"	36-9/16"	75-S36	---	---	75-S36G
37"	37-9/16"	75-S37	---	---	---
38"	38-9/16"	75-S38	---	---	---
39"	39-9/16"	75-S39	---	---	---
40"	40-9/16"	75-S40	---	---	---

General Information

1. White, red and blue bearings are for sashes weighing up to 22 lbs; green bearings are for sashes weighing up to 26 lbs; yellow bearings are for sashes weighing 26-34 lbs. Consult your sales representative for ordering information.
2. The appropriate tensioning tools are 70-515 and 70-516 as shown on pages 81 and 123.
3. A pre-tensioned balance whose rod length is 1-7/8" longer than the tube is also available on a SPECIAL ORDER, NON-RETURNABLE BASIS. These are generally used by manufacturers' specifications. Consult your sales representative for inquiries or questions. (If you have a pre-tensioned balance and want to use our standard 75 SERIES balance, order 1" longer balance with a standard rod. (e.g. If your pre-tensioned balance is 30" with red bearing, order our 75-S31R.)

Extended Rod

Tube Length	Rod Length	White Bearing	Red Bearing	Blue Bearing	Green Bearing*
10"	11-9/16"	75-10	---	---	---
11"	12-9/16"	75-11	---	---	---
12"	13-9/16"	75-12	---	---	---
13"	14-9/16"	75-13	---	---	---
14"	15-9/16"	75-14	---	---	---
15"	16-9/16"	75-15	---	---	---
16"	17-9/16"	75-16	---	---	---
17"	18-9/16"	75-17	75-17R	---	---
18"	19-9/16"	---	---	---	---
19"	18-9/16"	75-19	---	---	---
20"	21-9/16"	---	---	---	---
21"	22-9/16"	75-21	---	---	---
22"	23-9/16"	75-22	---	---	---
23"	24-9/16"	75-23	75-23R	---	---
24"	25-9/16"	75-24	75-24R	---	75-24G
25"	26-9/16"	75-25	75-25R	---	---
26"	27-9/16"	75-26	75-26R	---	---
27"	28-9/16"	75-27	75-27R	---	---
28"	29-9/16"	75-28	75-28R	---	75-28G
29"	30-9/16"	75-29	75-29R	---	---
30"	31-9/16"	75-30	75-30R	---	---
31"	32-9/16"	75-31	75-31R	---	---
32"	33-9/16"	75-32	75-32R	---	---
33"	34-9/16"	75-33	---	---	---
34"	35-9/16"	75-34	---	---	---
35"	36-9/16"	75-35	---	---	---
36"	37-9/16"	75-36	---	---	---
37"	38-9/16"	75-37	---	---	---

*Other Sizes Available Upon Request.

75 SERIES BALANCE ACCESSORIES

CARRIER BRACKETS

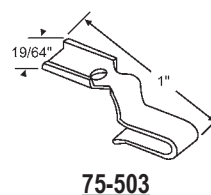
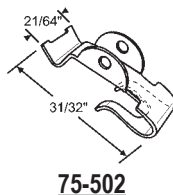
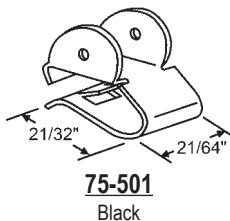
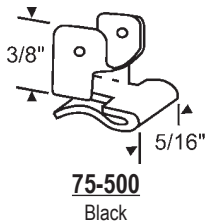

BALANCE CAP

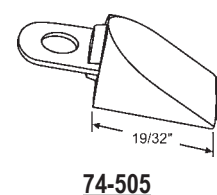

RIVETS

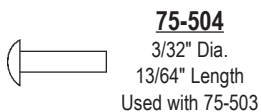

VENT GUIDE

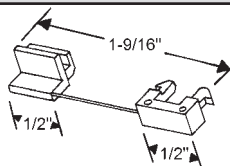

Part #	Finish
75-507W	White
75-507	Black

RUSCO

BALANCE SCREW

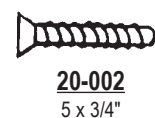

76 SERIES BALANCES

3/8" TUBE BALANCE

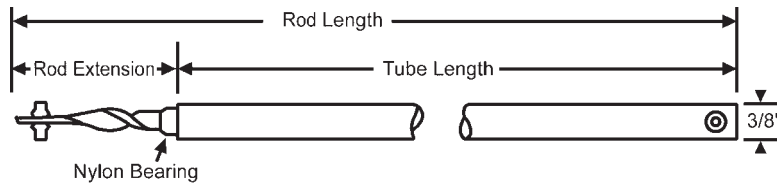

Ordering Information

1. Measure metal tube length. (Do not include nylon bearing.)
2. Measure spiral rod length. (Make sure rod is flush with screw hole end of tube before measuring.)
3. Identify the color of the bearing (e.g., white, red, yellow or blue) and select our corresponding part number from the chart below.
4. To identify the appropriate carrier or shoe to be attached and other related accessories, see pages 88-89.

Note: Attached carriers and related accessories must be ordered separately. If you want the ends attached, add the letter "A" to the suffix of the part number when ordering.

General Information

1. White, red and blue bearings are for sashes weighing up to 22 lbs; green bearings are for sashes weighing up to 26 lbs; yellow-green bearings are for sashes weighing 26-34 lbs. Consult your sales representative for ordering information.
2. The appropriate tensioning tools are 70-515 and 70-516 as shown on pages 81 and 123.

Standard Rod

Tube Length	Rod Length	White Bearing	Red Bearing	Blue Bearing	Green* Bearing	Yellow Bearing
10"	10-5/8"	76-SMS10	---	---	---	
11"	11-5/8"	76-SMS11	---	---	---	
12"	12-5/8"	76-SMS12	---	---	---	
13"	13-5/8"	76-SMS13	76-SMS13R	---	---	
14"	14-5/8"	76-SMS14	76-SMS14R	---	---	
15"	15-5/8"	76-SMS15	76-SMS15R	76-SMS15B	---	
16"	16-5/8"	---	76-SMS16R	---	---	
17"	17-5/8"	---	76-SMS17R	76-SMS17B	---	
18"	18-5/8"	---	76-SMS18R	76-SMS18B	---	
19"	19-5/8"	76-SMS19	76-SMS19R	76-SMS19B	76-SMS19G	
20"	20-5/8"	---	76-SMS20R	76-SMS20B	---	
21"	21-5/8"	---	76-SMS21R	76-SMS21B	76-SMS21G	
22"	22-5/8"	76-SMS22	76-SMS22R	76-SMS22B	---	
23"	23-5/8"	---	76-SMS23R	76-SMS23B	---	76-SMS23Y
24"	24-5/8"	---	76-SMS24R	76-SMS24B	---	
25"	25-5/8"	---	76-SMS25R	76-SMS25B	---	76-SMS25Y
26"	26-5/8"	76-SMS26	76-SMS26R	---	---	
27"	27-5/8"	---	76-SMS27R	---	---	
28"	28-5/8"	---	76-SMS28R	---	76-SMS28G	
29"	29-5/8"	---	76-SMS29R	---	76-SMS29G	76-SMS29Y
30"	30-5/8"	---	76-SMS30R	---	76-SMS30G	76-SMS30Y
31"	31-5/8"	---	76-SMS31R	---	76-SMS31G	
32"	32-5/8"	---	76-SMS32R	---	---	
33"	33-5/8"	76-SMS33	---	---	---	76-SMS33Y
34"	34-5/8"	76-SMS34	---	---	---	
35"	35-5/8"	76-SMS35	---	---	76-SMS35G	76-SMS35Y
36"	36-5/8"	76-SMS36	---	---	76-SMS36G	76-SMS36Y
37"	37-5/8"	76-SMS37	---	---	---	
38"	38-5/8"	76-SMS38	---	---	---	76-SMS38Y
39"	39-5/8"	76-SMS39	---	---	---	
40"	40-5/8"	76-SMS40	---	---	---	76-SMS40Y

Extended Rod

Tube Length	Rod Length	White Bearing	Red Bearing	Blue Bearing	Green* Bearing	Yellow Bearing
10"	11-5/8"	76-SM10	---	---	---	
11"	12-5/8"	76-SM11	---	---	---	
12"	13-5/8"	76-SM12	---	---	---	
13"	14-5/8"	76-SM13	76-SM13R	---	---	
14"	15-5/8"	76-SM14	76-SM14R	---	---	
15"	16-5/8"	76-SM15	76-SM15R	76-SM15B	---	
16"	17-5/8"	76-SM16	76-SM16R	76-SM16B	---	
17"	18-5/8"	76-SM17	76-SM17R	76-SM17B	---	
18"	19-5/8"	76-SM18	76-SM18R	76-SM18B	---	
19"	20-5/8"	---	76-SM19R	76-SM19B	---	
20"	21-5/8"	---	76-SM20R	76-SM20B	---	
21"	22-5/8"	---	76-SM21R	76-SM21B	---	
22"	23-5/8"	---	76-SM22R	76-SM22B	---	
23"	24-5/8"	---	76-SM23R	76-SM23B	---	
24"	25-5/8"	---	76-SM24R	76-SM24B	---	
25"	26-5/8"	---	76-SM25R	76-SM25B	---	
26"	27-5/8"	76-SM26	76-SM26R	---	---	
27"	28-5/8"	---	76-SM27R	---	---	
28"	29-5/8"	76-SM28	76-SM28R	---	---	
29"	30-5/8"	---	76-SM29R	---	---	
30"	31-5/8"	76-SM30	76-SM30R	---	---	
31"	32-5/8"	76-SM31	---	---	---	
32"	33-5/8"	76-SM32	76-SM32R	---	---	
33"	34-5/8"	76-SM33	---	---	---	
34"	35-5/8"	76-SM34	---	---	---	
35"	36-5/8"	76-SM35	---	---	---	
36"	37-5/8"	76-SM36	---	---	76-SM36G	76-SM36Y
37"	38-5/8"	76-SM37	---	---	---	
38"	39-5/8"	76-SM38	---	---	---	76-SM38G
39"	40-5/8"	76-SM39	---	---	---	
40"	41-5/8"	76-SM40	---	---	---	

*Other sizes available upon request.

SASH SUPPORT SYSTEMS

76 SERIES BALANCE ACCESSORIES

HINGE LEAF ASSEMBLY

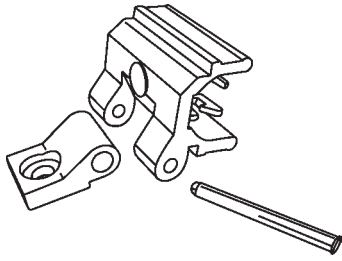

Hinge Assembly w/Metal Bracket

Part #	Color
76-518	White
76-518B	Black

Hinge Assembly - No Metal Bracket

Part #	Color
76-523	White
76-523B	Black

SILVER LINE

METAL SASH CLIPS

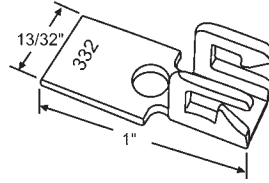

76-500

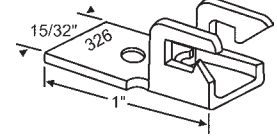

76-501

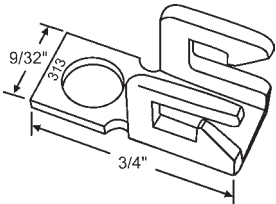

76-502
KINRO/SILVER LINE

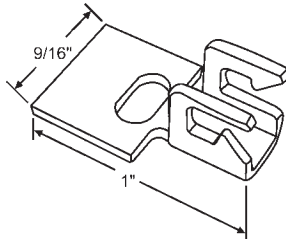

76-533

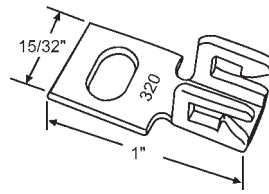

76-503

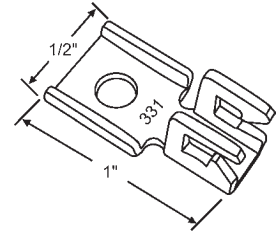

76-504

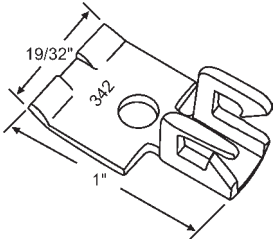

76-505

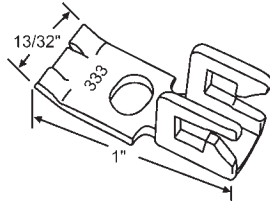

76-509

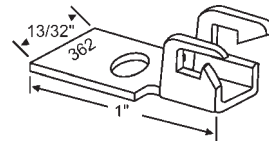

76-510

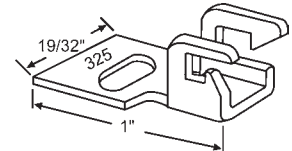

76-511

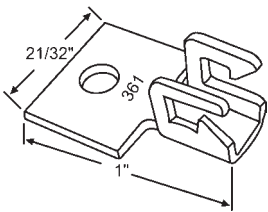

76-513

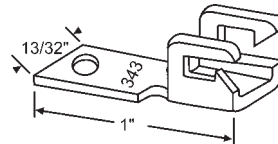

76-514

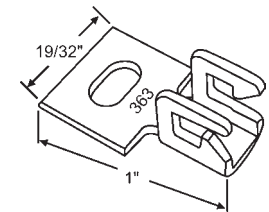

76-515

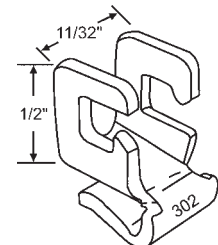

76-516
Clip On
GENERAL ALUMINUM

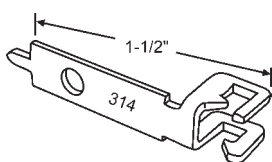

76-506

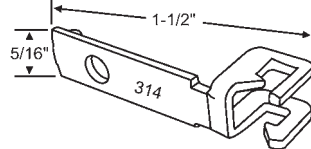

76-507

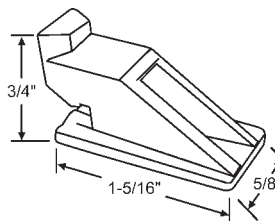

76-517

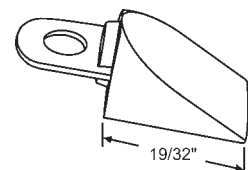

74-505

CARRIER

BALANCE CAP

76 SERIES BALANCE ACCESSORIES

TOP SASH GUIDES

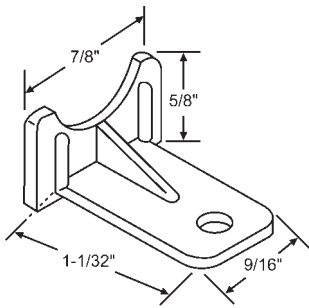

900-5013
Natural Nylon

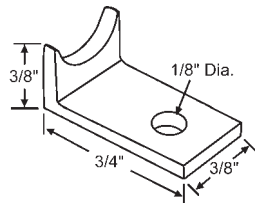

900-6861
Nylon

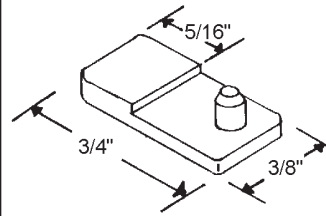

900-5814
Nylon Guide

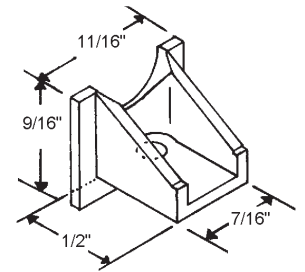

900-5428
Nylon Guide

TOP SASH GUIDES

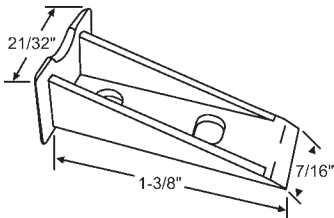

76-603

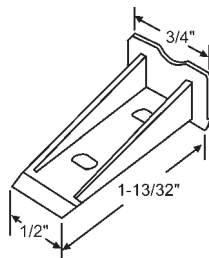

76-604
New Style. (Old Style only had 1 mounting hole.)

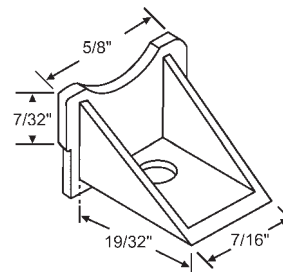

900-5522
CROWN

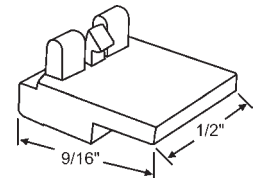

76-602
Natural
KELLER

SNAP-IN SASH GUIDES

FACE GUIDES

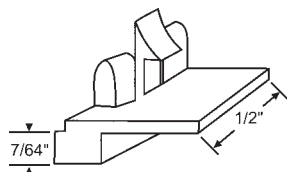

Part #	Color
76-607	Black
76-607W	White

HARCAR

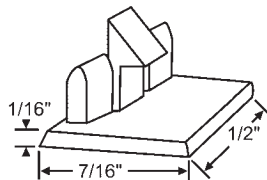

900-9966
Natural
HARCAR

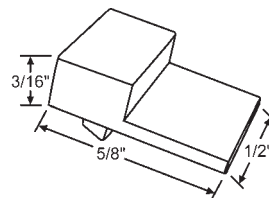

HWP956 WH
White
PGT

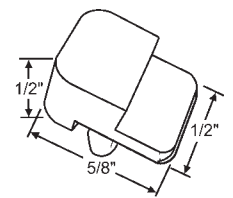

HWP959 WH
White
PGT

SPRING GUIDES

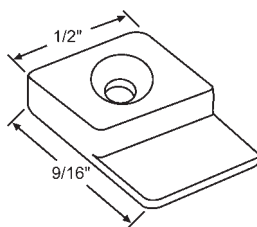

76-600
Uses 20-004 Screw

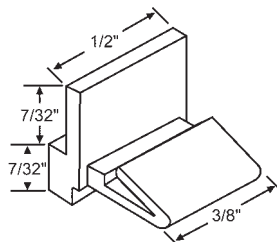

Part #	Color
76-608	Black
76-608W	White

HARCAR

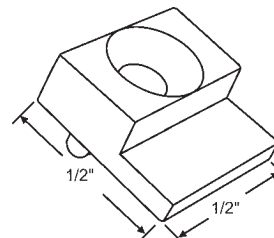

Part #	Color
76-611	Black
76-611W	White

KELLER

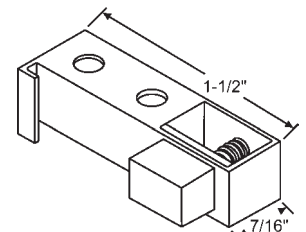

Part #	Hand
76-610RH	Shown
76-610LH	Opposite

RUSCO

78A SERIES BALANCES

3/8" PLASTIC TUBE BALANCE

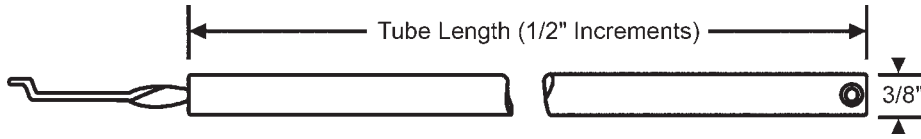

Tube Length	Part Number
14"	78A-14
15"	78A-15
16"	78A-16
16-1/2"	78A-16.5
17"	78A-17
17-1/2"	78A-17.5
18"	78A-18
18-1/2"	78A-18.5
19"	78A-19
19-1/2"	78A-19.5
20"	78A-20
20-1/2"	78A-20.5
21"	78A-21
21-1/2"	78A-21.5
22"	78A-22
22-1/2"	78A-22.5
23"	78A-23
23-1/2"	78A-23.5
24"	78A-24
24-1/2"	78A-24.5
25"	78A-25
25-1/2"	78A-25.5

Tube Length	Part Number
26"	78A-26
26-1/2"	78A-26.5
27"	78A-27
27-1/2"	78A-27.5
28"	78A-28
28-1/2"	78A-28.5
29"	78A-29
29-1/2"	78A-29.5
30"	78A-30
30-1/2"	78A-30.5
31"	78A-31
31-1/2"	78A-31.5
32"	78A-32
32-1/2"	78A-32.5
33"	78A-33
33-1/2"	78A-33.5
34"	78A-34
34-1/2"	78A-34.5
35"	78A-35
35-1/2"	78A-35.5
36"	78A-36

Ordering Information

1. Measure length of the plastic tube.
2. Select corresponding part number from the chart below.
3. To identify any attaching brackets or accessories used with your balance refer to bottom of the page.

Note: Accessories must be ordered separately.

General Information

1. Gray tubes are standard stock items, all other colors must be special order.

78A SERIES BALANCE ACCESSORIES

BRACKET

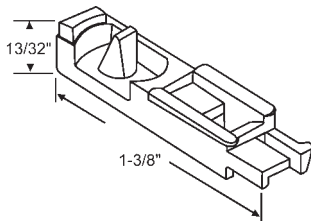

78-508

METAL SASH CLIP

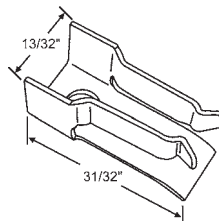

78-600

TOP SASH GUIDE

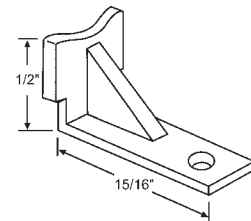

78-602

RETAINER LATCH

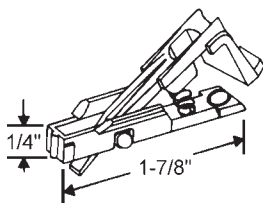

78-603

SASH CLIPS

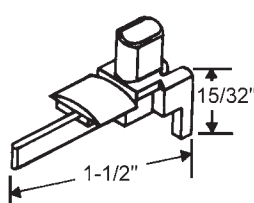

78-604

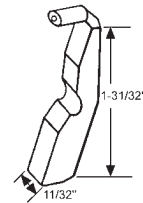

78-605

80 SERIES BALANCES

5/8" PLASTIC TUBE BALANCE

Tube diameter 9/16" but considered 5/8" in the trade.

NOTE: In most cases, the 72 series balances can be used as a direct substitute. Consult your account representative.

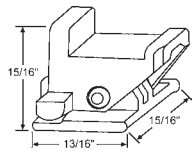

80-500

Order Separately.

If Needed Attached, Add Suffix A

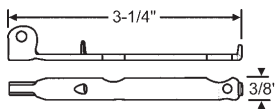

70-523

Comes Attached to Balance

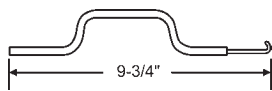

70-515

Balance Tensioning Tool

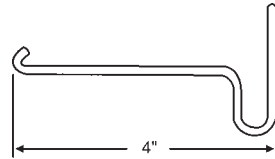

70-516

Balance Tensioning Tool

General Information

- In the past, various bearing (or pawl) colors were used to indicate different weight ranges for these balances. The colors used were white, red, blue, black and yellow. Currently the standard color for sashes weighing up to 30 lbs. is red and for 30 to 40 lbs, sash is yellow. If your sash weighs between 30 and up to 40 lbs., please specify HD after the part number.
- Gray tubes are standard. All other colors must be special order.

Ordering Information

- Measure length of the plastic tube.
- Select corresponding part number from the chart.
- Identify which carrier or shoe to be attached as well as accessories needed with your balance.

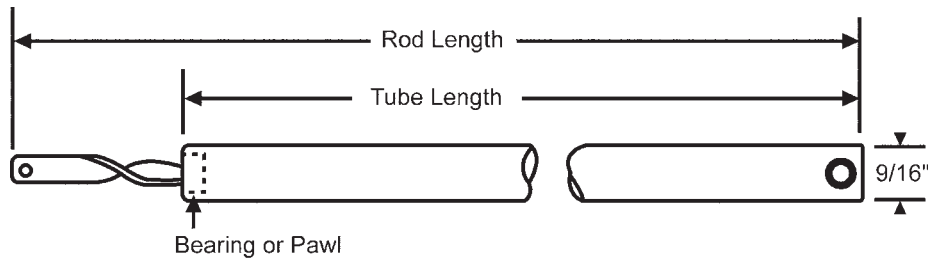

When 80-500 is Attached

Rod length is 1-3/4" longer than tube.

Tube Length	Part Number
16"	80-16P-1A
18"	80-18P-1A
20"	80-20P-1A
22"	80-22P-1A
23"	80-23P-1A
24"	80-24P-1A
25"	80-25P-1A
26"	80-26P-1A
27"	80-27P-1A
28"	80-28P-1A
29"	80-29P-1A
30"	80-30P-1A
32"	80-32P-1A
34"	80-34P-1A
36"	80-36P-1A

When 70-523 is Attached

Rod length is 3/4" longer than tube.

Tube Length	Part Number
16"	80-S16P-1
18"	80-S18P-1
20"	80-S20P-1
22"	80-S22P-1
23"	80-S23P-1
24"	80-S24P-1
25"	80-S25P-1
26"	80-S26P-1
27"	80-S27P-1
28"	80-S28P-1
29"	80-S29P-1
30"	80-S30P-1
32"	80-S32P-1
34"	80-S34P-1
36"	80-S36P-1

80 SERIES BALANCE ACCESSORIES

FOOT ATTACHMENT

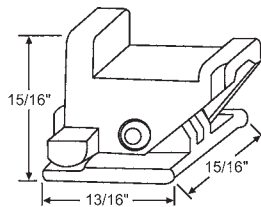

Part #	Description
80-500	No Rivet
80-500R	Includes Rivet

BRACKETS

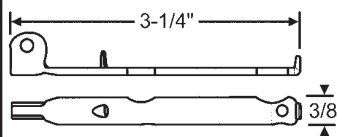

70-523
Uses Rivet 74-509

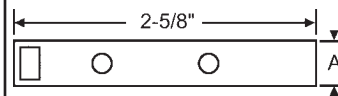

Part #	"A"
900-9939	3/8"

BALANCE SCREW

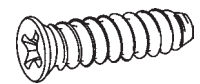

20-001
10 x 3/4", Phillips Head

RIVET

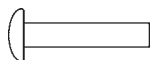

80-501
1/8" Diameter, 1/2" Length
Used With: 80-500

SASH CLIPS

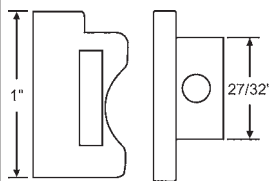

80-600A
Sash Guide LH and RH Set

LOWER SASH BLOCK

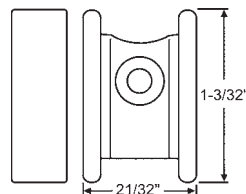

80-602

FRAME RETAINER

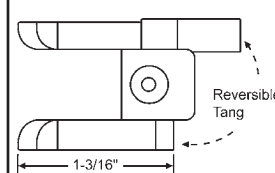

80-700
Nylon

TOP SASH GUIDE

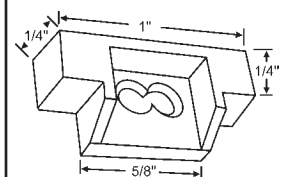

900-21614
ANDERSON

80A SERIES BALANCES

5/8" PLASTIC TUBE BALANCE

Tube diameter 9/16" but considered 5/8" in the trade.

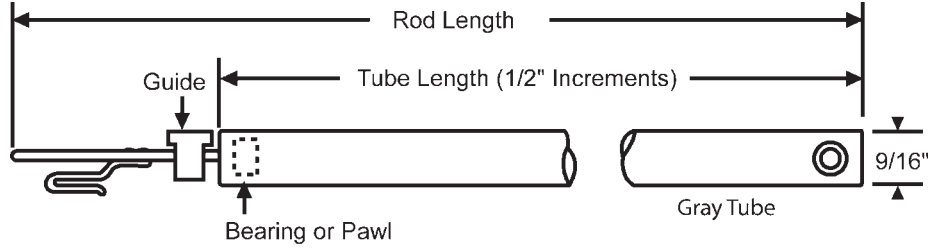

Tube Length	Part Number
15"	80A-15
15-1/2"	80A-15.5
16"	80A-16
16-1/2"	80A-16.5
17"	80A-17
17-1/2"	80A-17.5
18"	80A-18
18-1/2"	80A-18.5
19"	80A-19
19-1/2"	80A-19.5
20"	80A-20
20-1/2"	80A-20.5
21"	80A-21
21-1/2"	80A-21.5
22"	80A-22
22-1/2"	80A-22.5
23"	80A-23
23-1/2"	80A-23.5
24"	80A-24
24-1/2"	80A-24.5
25"	80A-25

Tube Length	Part Number
25-1/2"	80A-25.5
26"	80A-26
26-1/2"	80A-26.5
27"	80A-27
27-1/2"	80A-27.5
28"	80A-28
28-1/2"	80A-28.5
29"	80A-29
29-1/2"	80A-29.5
30"	80A-30
30-1/2"	80A-30.5
31"	80A-31
31-1/2"	80A-31.5
32"	80A-32
32-1/2"	80A-32.5
33"	80A-33
33-1/2"	80A-33.5
34"	80A-34
34-1/2"	80A-34.5
35"	80A-35
35-1/2"	80A-35.5

Ordering Information

1. Measure length of the plastic tube.
2. Select corresponding part number from the chart at left.
3. Balance brackets must be ordered separately. See below.

General Information

1. In the past, various bearing (or pawl) colors were used to indicate different weight ranges for these balances. The colors used were white, red, blue, black and yellow. Currently the standard color for sashes weighing up to 30 lbs. is red and for 30 to 40 lbs, sash is yellow. If your sash weighs between 30 and 40 lbs., please specify HD after the part number. Example: If ordering a 25-1/2" balance and your sash weighs 30 to 40 lbs., your part # is 80A-25.5HD.
2. This style balance is also available in 3/8". See 78C Series.
3. Tube length is available in 1/2" increments.
4. Gray tubes are standard; other colors available. Please consult your sales representative.
5. Used primarily in Northeast-New Jersey and New York.

80A SERIES BALANCE ACCESSORIES

BRACKET

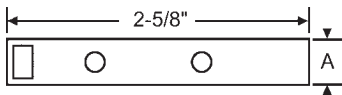

Part #	"A"
900-9939	3/8"

BALANCE SCREW

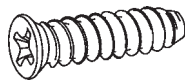

20-001
10 x 3/4", Phillips Head

BALANCE BRACKETS

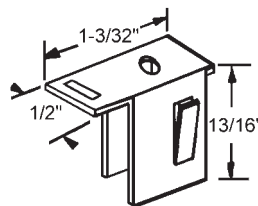

900-16911
Must Be Purchased Separately

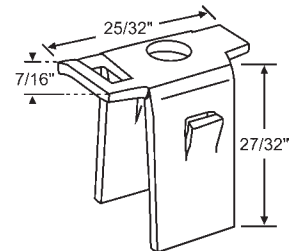

80-502
Must Be Purchased Separately

80B SERIES BALANCES

5/8" PLASTIC TUBE BALANCE

Tube diameter 9/16" but considered 5/8" in the trade.

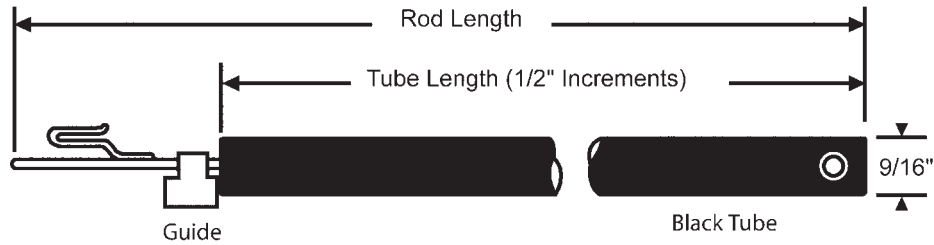

Tube Length	Part Number
15"	80B-15
15-1/2"	80B-15.5
16"	80B-16
16-1/2"	80B-16.5
17"	80B-17
17-1/2"	80B-17.5
18"	80B-18
18-1/2"	80B-18.5
19"	80B-19
19-1/2"	80B-19.5
20"	80B-20
20-1/2"	80B-20.5
21"	80B-21
21-1/2"	80B-21.5
22"	80B-22
22-1/2"	80B-22.5
23"	80B-23
23-1/2"	80B-23.5
24"	80B-24
24-1/2"	80B-24.5
25"	80B-25

Tube Length	Part Number
25-1/2"	80B-25.5
26"	80B-26
26-1/2"	80B-26.5
27"	80B-27
27-1/2"	80B-27.5
28"	80B-28
28-1/2"	80B-28.5
29"	80B-29
29-1/2"	80B-29.5
30"	80B-30
30-1/2"	80B-30.5
31"	80B-31
31-1/2"	80B-31.5
32"	80B-32
32-1/2"	80B-32.5
33"	80B-33
33-1/2"	80B-33.5
34"	80B-34
34-1/2"	80B-34.5
35"	80B-35
35-1/2"	80B-35.5
36"	80B-36

Ordering Information

1. Measure length of the plastic tube.
2. Select corresponding part number from the chart at left.
3. Balance brackets must be ordered separately.

General Information

1. In the past, various bearing (or pawl) colors were used to indicate different weight ranges for these balances. The colors used were white, red, blue, black and yellow. Currently the standard color for sashes weighing up to 30 lbs. is red and for 30 to 40 lbs, sash is yellow. If your sash weighs between 30 and 40 lbs., please specify HD after the part number. Example: If ordering a 25-1/2" balance and your sash weighs 30 to 40 lbs., your part # is 80B-25.5HD.
2. This style balance is also available in 3/8". Please consult your sales representative.
3. Tube length is available in 1/2" increments.
4. Black tubes are standard; other colors available. Please consult your sales representative.

80B SERIES BALANCE ACCESSORIES

GUIDE

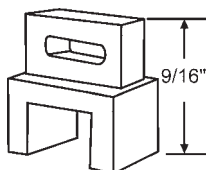

80-603
Not Sold Separately

BRACKET

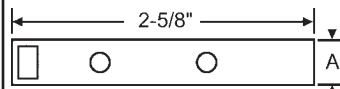

Part #	"A"
900-9939	3/8"

BALANCE BRACKET

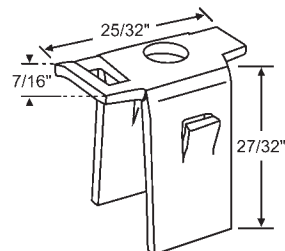

80-502
Must be purchased separately.

BALANCE SCREW

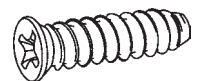

20-001
10 x 3/4", Phillips Head

5/8" PLASTIC TUBE BALANCE

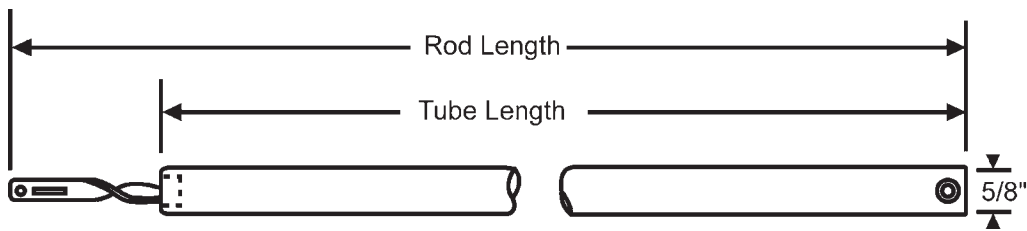

Ordering Information

1. Measure length of the plastic tube.
2. Select corresponding part number from the chart below and order accordingly.

General Information

1. Gray tubes are standard. All other colors must be special ordered.

5/8" Tubes 80SL Series

Tube Length	Part Number	Tube Length	Part Number
15"	80SL-15	25-1/2"	80SL-25.5
15-1/2"	80SL-15.5	26"	80SL-26
16"	80SL-16	26-1/2"	80SL-26.5
16-1/2"	80SL-16.5	27"	80SL-27
17"	80SL-17	27-1/2"	80SL-27.5
17-1/2"	80SL-17.5	28"	80SL-28
18"	80SL-18	28-1/2"	80SL-28.5
18-1/2"	80SL-18.5	29"	80SL-29
19"	80SL-19	29-1/2"	80SL-29.5
19-1/2"	80SL-19.5	30"	80SL-30
20"	80SL-20	30-1/2"	80SL-30.5
20-1/2"	80SL-20.5	31"	80SL-31
21"	80SL-21	31-1/2"	80SL-31.5
21-1/2"	80SL-21.5	32"	80SL-32
22"	80SL-22	32-1/2"	80SL-32.5
22-1/2"	80SL-22.5	33"	80SL-33
23"	80SL-23	33-1/2"	80SL-33.5
23-1/2"	80SL-23.5	34"	80SL-34
24"	80SL-24	34-1/2"	80SL-34.5
24-1/2"	80SL-24.5	35"	80SL-35
25"	80SL-25		

83 SERIES BALANCES

3/8" TILT TUBE BALANCE

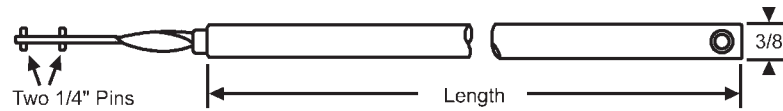

Now Available in White and Black Tubes.

Ordering Information

1. Measure metal tube length. (Do not include nylon bearing.)
2. Identify color of bearing (e.g. white or red) and select corresponding part number from the chart below.
3. When ordering a black or white tube, add a B (black) or W (white) at the end of the part number

General Information

Appropriate tensioning tools are 85-511 and 85-515 as shown on pages 115 and 123.

Tube Length	Bearing Color	Weight Range	Part#
10	white	4 thru 13	83-10W
10	red	8 thru 17	83-10R
10	blue	11 thru 20	83-10B
11	white	4 thru 13	83-11W
11	red	7 thru 17	83-11R
11	blue	11 thru 20	83-11B
11	green	14 thru 20	83-11G
12	white	4 thru 13	83-12W
12	red	7 thru 17	83-12R
12	blue	11 thru 20	83-12B
12	green	14 thru 20	83-12G
13	white	4 thru 13	83-13W
13	red	7 thru 17	83-13R
13	blue	11 thru 20	83-13B
13	green	14 thru 22	83-13G
14	white	4 thru 13	83-14W
14	red	6 thru 17	83-14R
14	blue	9 thru 21	83-14B
14	green	14 thru 24	83-14G
15	white	4 thru 13	83-15W
15	red	6 thru 17	83-15R
15	blue	9 thru 21	83-15B
15	green	14 thru 24	83-15G
16	red	6 thru 17	83-16R
16	blue	9 thru 21	83-16B
16	green	14 thru 24	83-16G
17	red	6 thru 17	83-17R
17	blue	9 thru 21	83-17B
17	green	14 thru 24	83-17G
17	yellow	24 thru 34	83-17Y
18	red	6 thru 16	83-18R
18	blue	9 thru 21	83-18B
18	green	14 thru 24	83-18G
18	yellow	24 thru 34	83-18Y
19	red	6 thru 16	83-19R
19	blue	9 thru 21	83-19B
19	green	14 thru 26	83-19G

Tube Length	Bearing Color	Weight Range	Part#
19	yellow	24 thru 34	83-19Y
20	red	8 thru 21	83-20R
20	blue	12 thru 22	83-20B
20	green	14 thru 26	83-20G
20	yellow	24 thru 34	83-20Y
21	white	6 thru 15	83-21W
21	red	8 thru 21	83-21R
21	blue	12 thru 22	83-21B
21	green	14 thru 26	83-21G
21	yellow	24 thru 34	83-21Y
22	red	8 thru 21	83-22R
22	blue	12 thru 22	83-22B
22	green	14 thru 26	83-22G
22	yellow	24 thru 34	83-22Y
23	red	7 thru 21	83-23R
23	blue	12 thru 22	83-23B
23	green	14 thru 26	83-23G
23	yellow	24 thru 34	83-23Y
24	red	7 thru 21	83-24R
24	blue	11 thru 22	83-24B
24	green	14 thru 26	83-24G
24	yellow	24 thru 34	83-24Y
25	white	6 thru 14	83-25W
25	red	7 thru 21	83-25R
25	blue	11 thru 22	83-25B
25	green	14 thru 26	83-25G
25	yellow	24 thru 34	83-25Y
26	red	10 thru 22	83-26R
26	green	14 thru 26	83-26G
26	yellow	24 thru 34	83-26Y
27	red	10 thru 22	83-27R
27	green	14 thru 26	83-27G
27	yellow	24 thru 34	83-27Y

Tube Length	Bearing Color	Weight Range	Part#
28	red	10 thru 22	83-28R
28	green	14 thru 26	83-28G
28	yellow	24 thru 34	83-28Y
29	red	10 thru 22	83-29R
29	green	14 thru 26	83-29G
29	yellow	24 thru 34	83-29Y
30	red	10 thru 22	83-30R
30	green	14 thru 26	83-30G
30	yellow	24 thru 34	83-30Y
31	white	5 thru 21	83-31W
31	red	10 thru 22	83-31R
31	green	14 thru 26	83-31G
31	yellow	24 thru 34	83-31Y
32	red	10 thru 22	83-32R
32	green	14 thru 26	83-32G
32	yellow	24 thru 34	83-32Y
33	white	7 thru 22	83-33W
33	green	14 thru 26	83-33G
33	yellow	24 thru 34	83-33Y
34	white	7 thru 22	83-34W
34	green	14 thru 26	83-34G
34	yellow	24 thru 34	83-34Y
35	white	7 thru 22	83-35W
35	green	14 thru 26	83-35G
35	yellow	24 thru 34	83-35Y
36	white	7 thru 22	83-36W
36	green	14 thru 26	83-36G
36	yellow	24 thru 34	83-36Y
37	white	7 thru 22	83-37W
37	green	14 thru 26	83-37G
37	yellow	24 thru 34	83-37Y
38	white	7 thru 22	83-38W
38	green	14 thru 26	83-38G
38	yellow	24 thru 34	83-38Y
39	white	7 thru 22	83-39W
39	green	14 thru 26	83-39G
39	yellow	24 thru 34	83-39Y

83 SERIES BALANCE ACCESSORIES

PIVOT LOCK SHOES

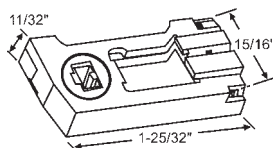

83-500

Black Cam. Opening: 1/4" x 3/16"
Used with Pivot Bar 83-504

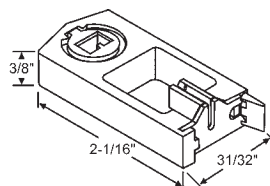

83-507

Red Cam
Opening: 1/4" x 3/16"

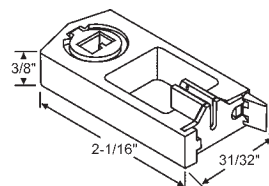

83-508

White Cam
Opening: 1/4" x 3/16"

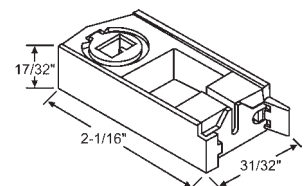

83-509

Royal Blue Cam
Opening: 1/4" x 3/16"

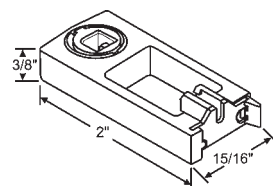

83-538

White Nylon with Red Cam
ALENCO/ PLY GEM

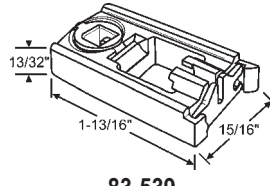

83-539

White Nylon with White Cam
GENERAL ALUM/ METAL INDUSTRIES

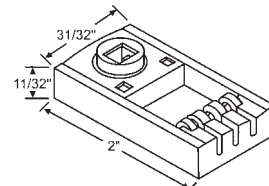

83-512

Cam Opening: 21/64" x 7/32"
4 Pins

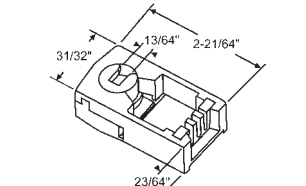

83-514

Blue Cam
CAREFREE

SASH SUPPORT SYSTEMS

83 SERIES BALANCE ACCESSORIES

PIVOT LOCK SHOES

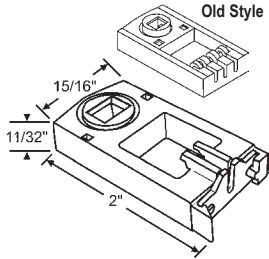

Part #	Description
83-510	Regular
83-510HD	Heavy Duty

Opening: 9/32" x 7/32"

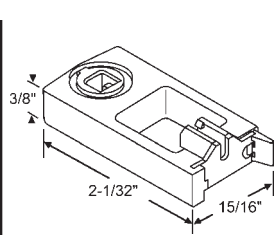

83-533
Black Cam
Opening: 5/16" x 3/16"

Balance Guide

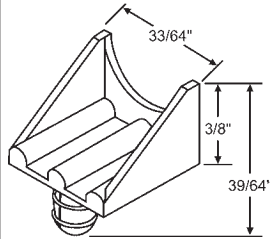

83-518
Nylon, Black

SPLIT ROLL PIN

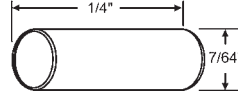

83-503

BALANCE COVER

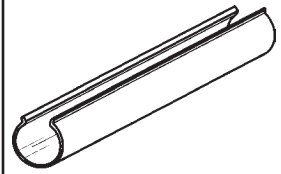

Part #	Color
83-633B	Black
83-633W	White

For 3/8" Balance Sold in 6' Lengths
ALENCO

PIVOT BAR

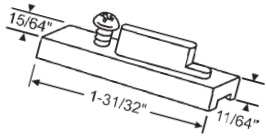

83-504
Die Cast with Screw

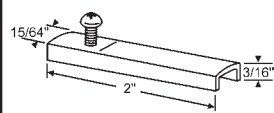

83-628
Steel Stamping. Includes Screw

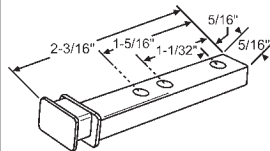

83-517
Pivot Bar

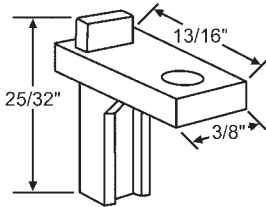

83-535
Pivot Bar

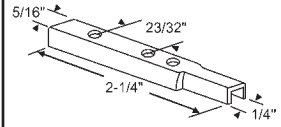

85-557
Stamped. Use with 83-506 Pivot Lock Shoe.
ROLLYSON

PIVOT BAR HOLDER

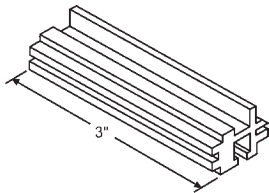

900-11662
White
REYNOLDS

PIVOT SHOE TAMP-R-LOCK

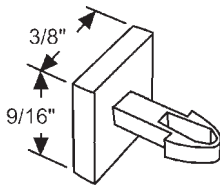

83-525
Plastic

SNAP LATCH

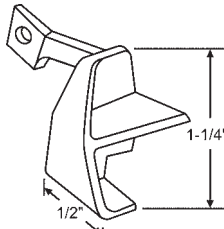

Part #	Hand
83-605	Shown
83-606	Opposite

Black
SECURITY

SLIDE/TILT LATCHES

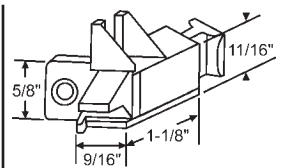
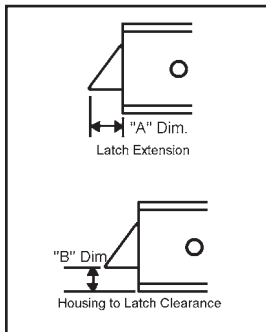

Part #	Color
83-614BA	Black

"A"	"B"
3/8"	1/4"

Sold in sets only (RH/LH).
REYNOLDS

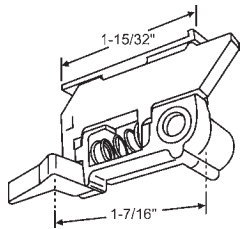

Part #	Color
83-603BA	Black

Sold in sets only. RH Shown
Black with Stop
ACORN

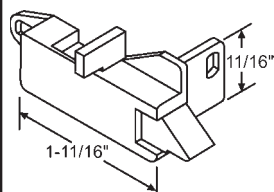

Part #	Color
83-625BA	Black

"A"	"B"
5/16"	1/8"

Sold in sets only (RH/LH).
ACORN

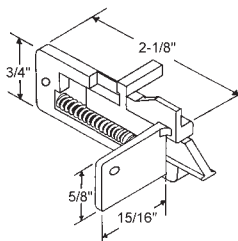

Part #	Color
83-624WA	White
83-624BA	Black

"A"	"B"
3/8"	7/32"

Sold in sets only. Top and Side Mounted.
BETTER-BILT

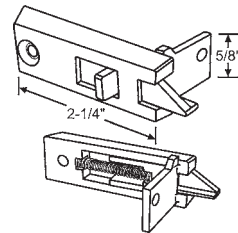

Part #	Color
83-620WA	White
83-620BA	Black

"A"	"B"
3/8"	1/4"

Sold in Sets Only. LH Shown
BETTER-BILT

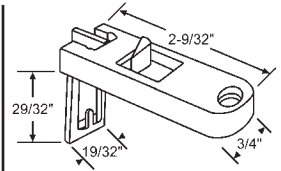

Part #	Color
83-607BA	Black
83-607WA	White

"A"	"B"
3/8"	1/4"

Sold in sets only. Top and Side Mounted.
KELLER

83 SERIES BALANCE ACCESSORIES

SLIDE/TILT LATCHES

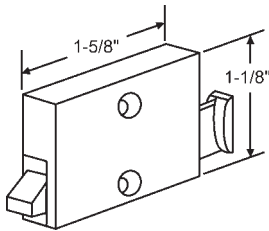

Part #	Color
900-10278	Black

"A"	"B"
1/4"	1/4"

Reversible
REYNOLDS

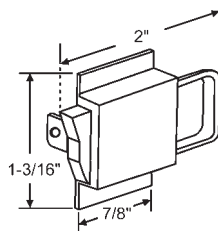

Part #	Color
83-613	Black

"A"	"B"
3/8"	1/4"

Reversible. Side Mounted
ALUM. INDUSTRIES

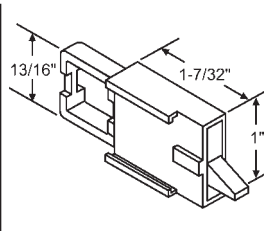

Part #	Hand	Color
83-617LH	Shown	Black
83-617RH	Opposite	Black

"A"	"B"
11/32"	5/16"

Slides onto extrusion.

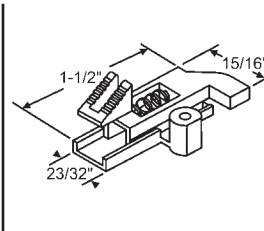

Part #	Color
83-522	Black

"A"	"B"
19/64"	3/8"

Slides onto extrusion. Black

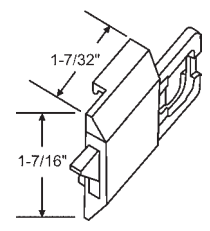

Part #	Color
83-600BA	Black

"A"	"B"
9/32"	3/8"

Sold in Sets Only
KELLER

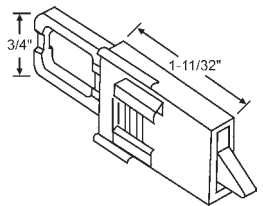

Part #	Color
83-627BA	Black

"A"	"B"
3/8"	1/4"

Sold in sets only. Slides onto extrusion.

BETTER-BILT

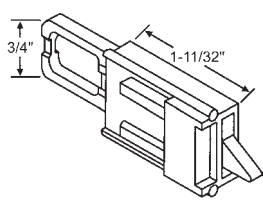

Part #	Color
83-623BA	Black

"A"	"B"
11/32"	1/4"

Sold in sets only. Slides onto extrusion.

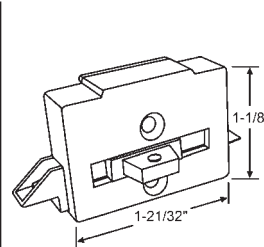

83-602
Black
ACORN

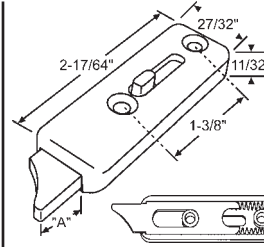

Part #	Color
83-704WA	White

"A"	"B"
19/32"	5/32"

Sold in Sets Only

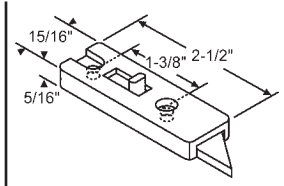

Part #	Color
83-523BA	Black
83-523WA	White

"A"	"B"
1/2"	1/4"

Sold in Sets Only

ESP/KINRO

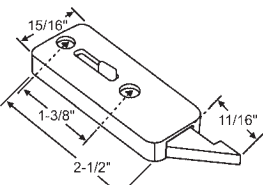

Part #	Color
83-631	Black
83-631W	White

"A"	"B"
3/8"	11/32"

Sold as Set Only
LH Shown

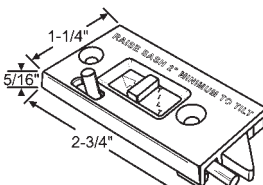

Part #	Color
83-526MOD-WA	White

"A"	"B"
3/8"	11/32"

Sold in Sets Only. RH Shown.

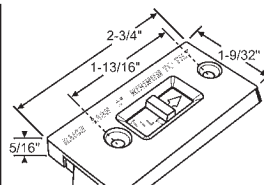

Part #	Color
83-526WA	White

"A"	"B"
3/8"	5/16"

Sold in Sets Only. LH Shown.

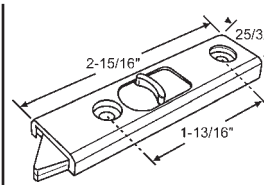

Part #	Color
83-635BA	Black
83-635WA	White

"A"	"B"
11/32"	1/8"

Sold in Sets Only. LH Shown.

ALENCO

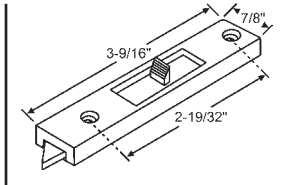

Part #	Color
83-622WA	White
83-622BA	Black
83-622BGA	Beige

"A"	"B"
3/8"	3/16"

Sold in Sets Only. LH Shown

SASH STOPS

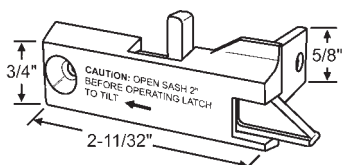

Part #	Color
83-621WA	White
83-621BA	Black

"A"	"B"
3/8"	1/8"

Sold in Sets Only

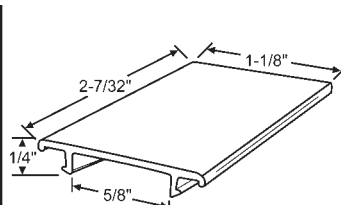

83-641W
White Vinyl
2-7/32" Long

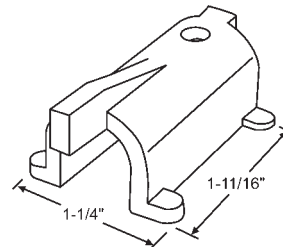

83-700
Black
ACORN

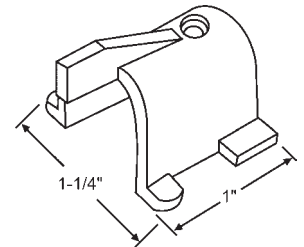

Part #	Finish
900-9712	Black
900-9712W	White

ACORN

3/8" Tilt Tube Balance

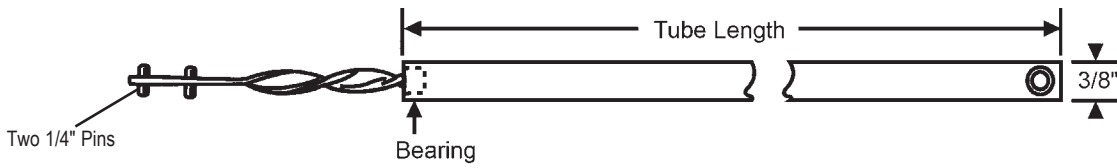

Ordering Information

1. Measure plastic tube length.
2. Identify bearing color by looking down into the tube where the rod comes out. Refer to general information #1.
3. Select the part number from the chart below for (2) 1/4" pin configuration.
4. If different configuration, select appropriate pin configuration from the chart and add the number to the end of the part number.

Example Ordering Chart

Balance Length	Tube Color	Pin Configuration	Complete Part Number
26"	White	-	83-P26W
19"	Black	2	83-P19B-2

General Information

1. The bearing (or Pawl) colors used on the 83P Series balance are white for sash weighing up to 18 lbs., and yellow for sash weighing 18 to 30 lbs. If your sash weighs between 18 and 30lbs, add HD after the part number. Example: If ordering a 36" balance for a 23 lb. sash, your part number is 83-P36HD.
2. Standard tube color is gray. If ordering white, place the letter "W" at the end of the part number. If ordering black, place the letter "B" at the end of the part number.
3. Appropriate tensioning tools are 85-511 and 85-515 as shown on pages 115 and 123.
4. Accessories must be ordered separately.

Tube Length	Tube Color	Part Number
15"	Gray	83-P15
16"	Gray	83-P16
17"	Gray	83-P17
18"	Gray	83-P18
19"	Gray	83-P19
20"	Gray	83-P20
21"	Gray	83-P21
22"	Gray	83-P22
23"	Gray	83-P23
24"	Gray	83-P24
25"	Gray	83-P25
26"	Gray	83-P26
27"	Gray	83-P27
28"	Gray	83-P28
29"	Gray	83-P29
30"	Gray	83-P30
31"	Gray	83-P31
32"	Gray	83-P32
33"	Gray	83-P33
34"	Gray	83-P34
35"	Gray	83-P35
36"	Gray	83-P36
37"	Gray	83-P37
38"	Gray	83-P38
39"	Gray	83-P39
40"	Gray	83-P40
41"	Gray	83-P41
42"	Gray	83-P42
43"	Gray	83-P43
44"	Gray	83-P44
45"	Gray	83-P45

Balance Pin Options

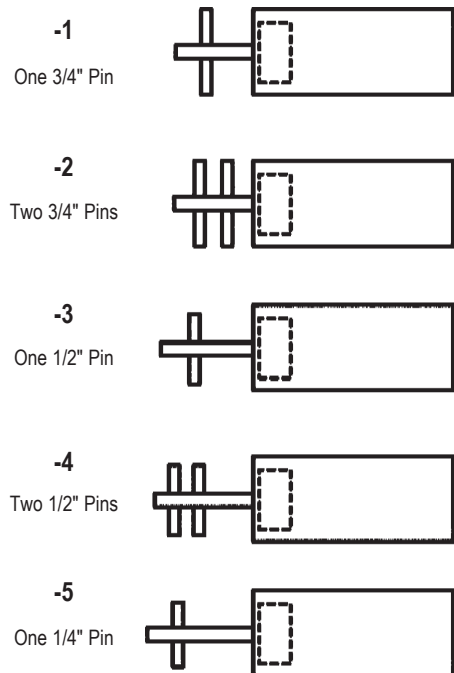

*Other sizes available upon request.

84 SERIES 5/8" PNEU-LIFT TILT ASSEMBLY

All balances are same length - Only gas pressures differ.
Will not work for the old style 3/4" balance

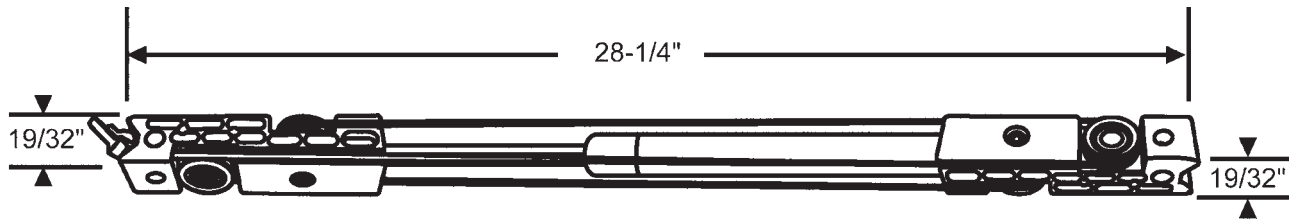

Suggested Weight Per Pair	Suggested Weight 4 Per Sash		Part Number
18 to 21 lbs.	36 to 42 lbs.	w/60-518 attached	84-35-1
18 to 21 lbs.	36 to 42 lbs.	w/900-18354 attached	84-35-5
21 to 24 lbs.	42 to 48 lbs.	w/60-518 attached	84-40-1
21 to 24 lbs.	42 to 48 lbs.	w/900-18354 attached	84-40-5
24 to 27 lbs.	48 to 54 lbs.	w/60-518 attached	84-45-1
24 to 27 lbs.	48 to 54 lbs.	w/900-18354 attached	84-45-5
27 to 30 lbs.	54 to 60 lbs.	w/60-518 attached	84-50-1
27 to 30 lbs.	54 to 60 lbs.	w/900-18354 attached	84-50-5
30 to 32 lbs.	60 to 64 lbs.	w/60-518 attached	84-55-1
30 to 32 lbs.	60 to 64 lbs.	w/900-18354 attached	84-55-5
32 to 36 lbs.	64 to 72 lbs.	w/60-518 attached	84-60-1
32 to 36 lbs.	64 to 72 lbs.	w/900-18354 attached	84-60-5
36 to 39 lbs.	72 to 78 lbs.	w/60-518 attached	84-65-1
36 to 39 lbs.	72 to 78 lbs.	w/900-18354 attached	84-65-5
39 to 43 lbs.	78 to 86 lbs.	w/60-518 attached	84-70-1
39 to 43 lbs.	78 to 86 lbs.	w/900-18354 attached	84-70-5
43 to 45 lbs.	86 to 90 lbs.	w/60-518 attached	84-75-1
43 to 45 lbs.	86 to 90 lbs.	w/900-18354 attached	84-75-5
45 to 48 lbs.	90 to 96 lbs.	w/60-518 attached	84-80-1
45 to 48 lbs.	90 to 96 lbs.	w/900-18354 attached	84-80-5
48 to 52 lbs.	96 to 104 lbs.	w/60-518 attached	84-85-1
48 to 52 lbs.	96 to 104 lbs.	w/900-18354 attached	84-85-5
52 to 55 lbs.	104 to 110 lbs.	w/60-518 attached	84-90-1
52 to 55 lbs.	104 to 110 lbs.	w/900-18354 attached	84-90-5
55 to 58 lbs.	110 to 116 lbs.	w/60-518 attached	84-95-1
55 to 58 lbs.	110 to 116 lbs.	w/900-18354 attached	84-95-5
58 to 62 lbs.	116 to 124 lbs.	w/60-518 attached	84-105-1
58 to 62 lbs.	116 to 124 lbs.	w/900-18354 attached	84-105-5
62 to 64 lbs.	124 to 129 lbs.	w/60-518 attached	84-110-1
62 to 64 lbs.	124 to 129 lbs.	w/900-18354 attached	84-110-5

OPTIONAL END BRACKETS

-5

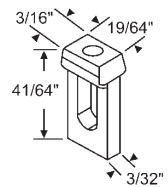

900-18354

If ordering with our optional 900-18354 clip attached, Please add "-5" after the part number

-1

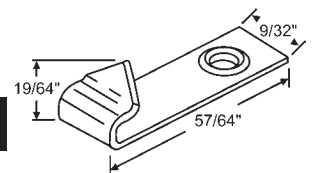

60-518

If ordering with our optional 60-518 clip attached, Please add "-1" after the part number

Contact Account Manager For Pricing

SASH SUPPORT SYSTEMS

84S SERIES SHORT 5/8" PNEU-LIFT TILT ASSEMBLY

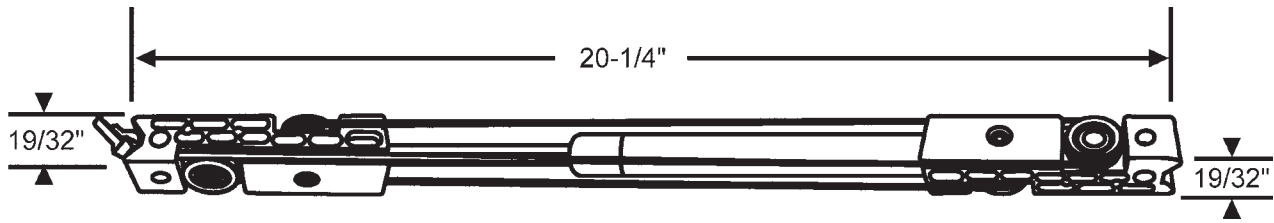

Suggested Weight Per Pair	Suggested Weight 4 Per Sash		Part Number
9 to 12 lbs.	10 to 24 lbs.	w/60-518 attached	84S-20-1
9 to 12 lbs.	10 to 24 lbs.	w/900-18354 attached	84S-20-5
12 to 15 lbs.	24 to 30 lbs.	w/60-518 attached	84S-25-1
12 to 15 lbs.	24 to 30 lbs.	w/900-18354 attached	84S-25-5
15-18 lbs.	30-36 lbs.	w/60-518 attached	84S-30-1
15-18 lbs.	30-36 lbs.	w/900-18354 attached	84S-30-5
18 to 21 lbs.	36 to 42 lbs.	w/60-518 attached	84S-35-1
18 to 21 lbs.	36 to 42 lbs.	w/900-18354 attached	84S-35-5
21 to 24 lbs.	42 to 48 lbs.	w/60-518 attached	84S-40-1
21 to 24 lbs.	42 to 48 lbs.	w/900-18354 attached	84S-40-5
24 to 27 lbs.	48 to 54 lbs.	w/60-518 attached	84S-45-1
24 to 27 lbs.	48 to 54 lbs.	w/900-18354 attached	84S-45-5
27 to 30 lbs.	54 to 60 lbs.	w/60-518 attached	84S-50-1
27 to 30 lbs.	54 to 60 lbs.	w/900-18354 attached	84S-50-5
30 to 32 lbs.	60 to 64 lbs.	w/60-518 attached	84S-55-1
30 to 32 lbs.	60 to 64 lbs.	w/900-18354 attached	84S-55-5
32 to 36 lbs.	64 to 72 lbs.	w/60-518 attached	84S-60-1
32 to 36 lbs.	64 to 72 lbs.	w/900-18354 attached	84S-60-5
36 to 39 lbs.	72 to 78 lbs.	w/60-518 attached	84S-65-1
36 to 39 lbs.	72 to 78 lbs.	w/900-18354 attached	84S-65-5
39 to 43 lbs.	78 to 86 lbs.	w/60-518 attached	84S-70-1
39 to 43 lbs.	78 to 86 lbs.	w/900-18354 attached	84S-70-5
43 to 45 lbs.	86 to 90 lbs.	w/60-518 attached	84S-75-1
43 to 45 lbs.	86 to 90 lbs.	w/900-18354 attached	84S-75-5
45 to 48 lbs.	90 to 96 lbs.	w/60-518 attached	84S-80-1
45 to 48 lbs.	90 to 96 lbs.	w/900-18354 attached	84S-80-5
48 to 52 lbs.	96 to 104 lbs.	w/60-518 attached	84S-85-1
48 to 52 lbs.	96 to 104 lbs.	w/900-18354 attached	84S-85-5
52 to 55 lbs.	104 to 110 lbs.	w/60-518 attached	84S-90-1
52 to 55 lbs.	104 to 110 lbs.	w/900-18354 attached	84S-90-5
55 to 58 lbs.	110 to 116 lbs.	w/60-518 attached	84S-95-1
55 to 58 lbs.	110 to 116 lbs.	w/900-18354 attached	84S-95-5
58 to 62 lbs.	116 to 124 lbs.	w/60-518 attached	84S-100-1
58 to 62 lbs.	116 to 124 lbs.	w/900-18354 attached	84S-100-5
62 to 64 lbs.	124 to 128 lbs.	w/60-518 attached	84S-110-1
62 to 64 lbs.	124 to 128 lbs.	w/900-18354 attached	84S-110-5

OPTIONAL END BRACKETS

-5

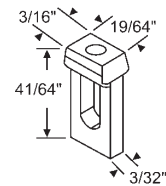

900-18354

If ordering with our optional 900-18354 clip attached, Please add "-5" after the part number

-1

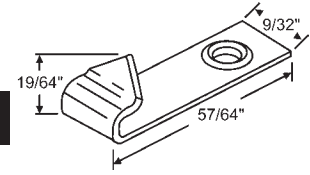

60-518

If ordering with our optional 60-518 clip attached, Please add "-1" after the part number

Contact Account Manager For Pricing

85 SERIES BALANCES

5/8" TILT TUBE BALANCE 9/16" but considered 5/8" in the trade.

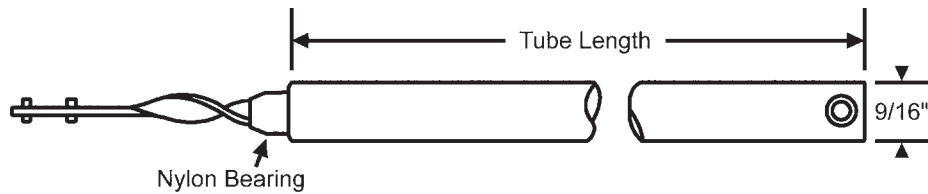

Ordering Information

1. Measure metal tube length. (Do not include nylon bearing.)
2. Identify color of bearing (e.g. red, blue or black) and select corresponding part number from the chart below.
3. If different pin configuration, select appropriate pin configuration from the chart and add the number to the end of the part number.

Note: Accessories must be ordered separately, see pages 105 - 116.

General Information

1. Maximum tube balance length available is 60".
2. Red and blue bearings are for sashes weighing up to 30 lbs; the black bearing with the nyclad tip is for sashes weighing up to 40 lbs. Please consult your sales representative for special ordering information.
3. In most cases red bearing can be used in place of white bearing. Check with sales representative for availability of white bearing.
4. Now Available in White.
5. The appropriate tensioning tools are 85-511 and 85-515 as shown on pages 115 and 123.
6. All rod lengths are standard.

Tube Length	Red Bearing (up to 30 lbs.)	Blue Bearing (up to 30 lbs.)	Black Bearing (30 - 40 lbs.)
12"	85-12R	85-12B	---
13"	85-13R	85-13B	---
14"	85-14R	85-14B	---
15"	85-15R	85-15B	---
16"	85-16R	85-16B	---
17"	85-17R	85-17B	85-17HD
18"	85-18R	85-18B	85-18HD
19"	85-19R	85-19B	85-19HD
20"	85-20R	85-20B	85-20HD
21"	85-21R	85-21B	85-21HD
22"	85-22R	85-22B	85-22HD
23"	85-23R	85-23B	85-23HD
24"	85-24R	85-24B	85-24HD
25"	85-25R	85-25B	85-25HD
26"	85-26R	85-26B	85-26HD
27"	85-27R	85-27B	85-27HD
28"	85-28R	85-28B	85-28HD
29"	85-29R	85-29B	85-29HD
30"	85-30R	85-30B	85-30HD
31"	85-31R	85-31B	85-31HD
32"	85-32R	85-32B	85-32HD
33"	85-33R	---	85-33HD
34"	85-34R	---	85-34HD
35"	85-35R	---	85-35HD
36"	85-36R	---	85-36HD
37"	85-37R	---	85-37HD
38"	85-38R	---	85-38HD

Tube Length	Red Bearing (up to 30 lbs.)	Black Bearing (30 - 40 lbs.)
39"	85-39R	85-39HD
40"	85-40R	85-40HD
41"	85-41R	85-41HD
42"	85-42R	85-42HD
43"	85-43R	85-43HD
44"	85-44R	85-44HD
45"	85-45R	85-45HD
46"	85-46R	85-46HD
47"	85-47R	85-47HD
48"	85-48R	85-48HD
49"	85-49R	85-49HD
50"	85-50R	85-50HD
51"	85-51R	85-51HD
52"	---	85-52HD
53"	---	85-53HD
54"	---	85-54HD
55"	---	85-55HD
56"	---	85-56HD
57"	---	85-57HD
58"	---	85-58HD
59"	---	85-59HD
60"	---	85-60HD
61"	---	85-61HD
62"	---	85-62HD
63"	---	85-63HD
64"	---	85-64HD
65"	---	85-65HD
72"	---	85-72HD

5/8" NON-TILT TUBE BALANCE 9/16" but considered 5/8" in the trade.

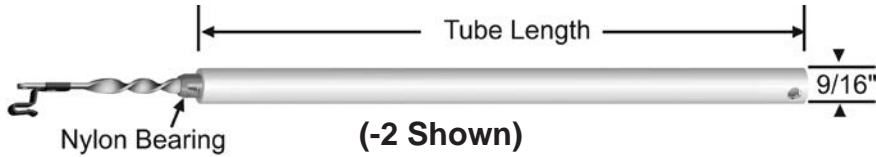

Ordering Information

1. Measure metal tube length. (Do not include nylon bearing.)
2. Identify color of bearing (e.g. red, blue or black) and select corresponding part column from the chart below.
3. Select our corresponding part number from the chart below
4. Identify appropriate end bracket to be attached from the illustrations shown then add -1 or -2 to complete our part number.
5. Add suffix W to end of part number when ordering with white tube

Example: 32" Balance with black bearing, #75-540 attached in white = 85M-32HD-2W

General Information

1. Maximum tube balance length available is 60".
2. Red and blue bearings are for sashes weighing up to 30 lbs; the black bearing with the nyclad tip is for sashes weighing up to 40 lbs.
3. In most cases red bearing can be used in place of white bearing.
4. Available in Mill (Standard) or White (Special Order) tube.
5. The appropriate tensioning tools are 85-511 and 85-515 as shown on pages 115 and 123.
6. All rod lengths are standard.

CARRIER BRACKETS

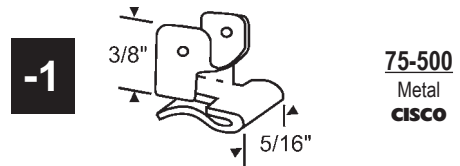

75-500
Metal
CISCO

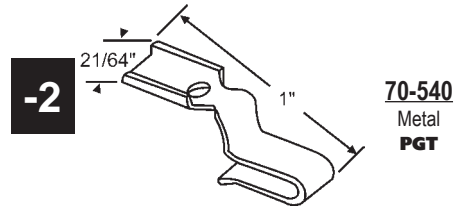

70-540
Metal
PGT

Tube Length	Red Bearing (up to 30 lbs.)	Blue Bearing (up to 30 lbs.)	Black Bearing (30 - 40 lbs.)
12"	85M-12R-	85M-12B-	---
13"	85M-13R-	85M-13B-	---
14"	85M-14R-	85M-14B-	---
15"	85M-15R-	85M-15B-	---
16"	85M-16R-	85M-16B-	---
17"	85M-17R-	85M-17B-	85M-17HD-
18"	85M-18R-	85M-18B-	85M-18HD-
19"	85M-19R-	85M-19B-	85M-19HD-
20"	85M-20R-	85M-20B-	85M-20HD-
21"	85M-21R-	85M-21B-	85M-21HD-
22"	85M-22R-	85M-22B-	85M-22HD-
23"	85M-23R-	85M-23B-	85M-23HD-
24"	85M-24R-	85M-24B-	85M-24HD-
25"	85M-25R-	85M-25B-	85M-25HD-
26"	85M-26R-	85M-26B-	85M-26HD-
27"	85M-27R-	85M-27B-	85M-27HD-
28"	85M-28R-	85M-28B-	85M-28HD-
29"	85M-29R-	85M-29B-	85M-29HD-
30"	85M-30R-	85M-30B-	85M-30HD-
31"	85M-31R-	85M-31B-	85M-31HD-
32"	85M-32R-	85M-32B-	85M-32HD-
33"	85M-33R-	85M-33B-	85M-33HD-
34"	85M-34R-	---	85M-34HD-
35"	85M-35R-	---	85M-35HD-

Tube Length	Red Bearing (up to 30 lbs.)	Black Bearing (30 - 40 lbs.)
36"	85M-36R-	85M-36HD-
37"	85M-37R-	85M-37HD-
38"	85M-38R-	85M-38HD-
39"	85M-39R-	85M-39HD-
40"	85M-40R-	85M-40HD-
41"	85M-41R-	85M-41HD-
42"	85M-42R-	85M-42HD-
43"	85M-43R-	85M-43HD-
44"	85M-44R-	85M-44HD-
45"	85M-45R-	85M-45HD-
46"	85M-46R-	85M-46HD-
47"	85M-47R-	85M-47HD-
48"	85M-48R-	85M-48HD-
49"	85M-49R-	85M-49HD-
50"	85M-50R-	85M-50HD-
51"	85M-51R-	85M-51HD-
52"	---	85M-52HD-
53"	---	85M-53HD-
54"	---	85M-54HD-
55"	---	85M-55HD-
56"	---	85M-56HD-
57"	---	85M-57HD-
58"	---	85M-58HD-
59"	---	85M-59HD-
60"	---	85M-60HD-

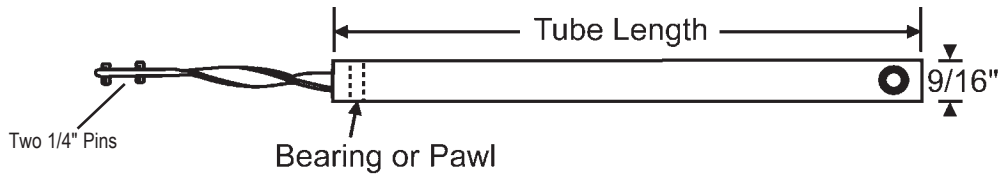

Ordering Information

1. Measure plastic tube length.
2. Identify bearing color by looking down into the tube where the rod comes out.
3. Select the part number from the chart below if 2 1/4" pin configuration.
4. If different configuration, select appropriate pin configuration from the chart and add the number to the end of the part number.

* Note: 1/2" sizes are no longer available.

General Information

1. In the past, various bearing (or pawl) colors were used to indicate different weight ranges for these balances. The colors used were white, red, blue, black and yellow. Currently the standard color for sashes weighing up to 30 lbs. is red and for 30 to 40 lbs, sash is yellow. If your sash weighs between 30 and up to 40 lbs. Please specify HD after the part number.
2. Standard tube color is gray. If ordering white, place the letter "W" at the end of the part number. If ordering black, place the letter "B" at the end of the part number.
3. Appropriate tensioning tools are 85-511 and 85-515 as shown on pages 115 and 123.
4. Accessories must be ordered separately.

Example Ordering Chart

Balance Length	Tube Color	Pin Configuration	Complete Part Number
26-1/2"	White	-	85-P26.5W
19"	Black	2	85-P19B-2

Tube Length	Part Number	Tube Length	Part Number
15"	85-P15	30"	85-P30
16"	85-P16	31"	85-P31
17"	85-P17	32"	85-P32
18"	85-P18	33"	85-P33
19"	85-P19	34"	85-P34
20"	85-P20	35"	85-P35
21"	85-P21	36"	85-P36
22"	85-P22	37"	85-P37
23"	85-P23	38"	85-P38
24"	85-P24	39"	85-P39
25"	85-P25	40"	85-P40
26"	85-P26	41"	85-P41
27"	85-P27	42"	85-P42
28"	85-P28	43"	85-P43
29"	85-P29	44"	85-P44
		45"	85-P45

Balance Pin Options

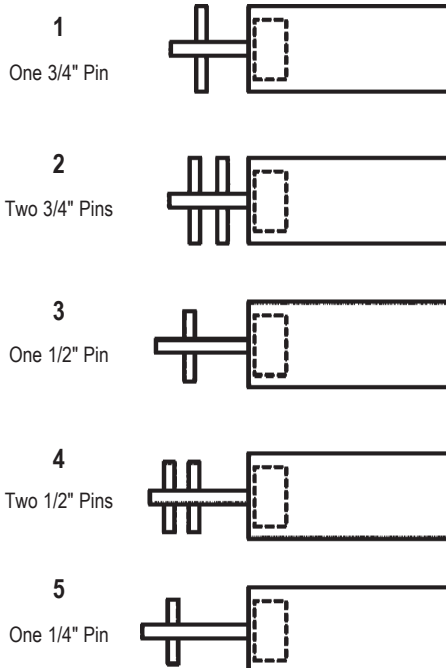

85Z SERIES BALANCES

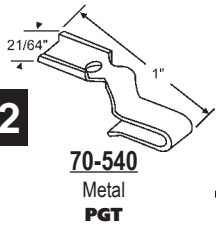

To make the balance non-tilt, add suffix -2 to part number.

5/8" PRE-TENSIONED TILT METAL TUBE BALANCE 9/16" but considered 5/8" in the trade.

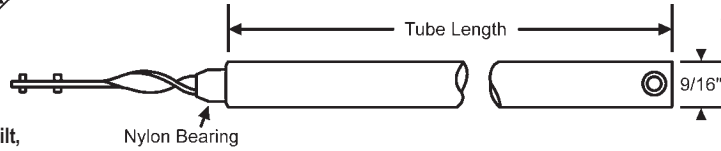

Ordering Information

1. Identify number stamped on balance.
2. Select our corresponding part number from the chart below.

Note: Accessories must be ordered separately, see pages 105 - 116.

Support Heavier Sash Weights with Superior Operating Performance

- Spiral Balances are already known for their consistent operating forces in raising and lowering sash.
- 85Z Series offers increased lift assistance to operation of heavier sash -up to 60 lbs -well beyond conventional spiral and block & tackle products available today.

- 85Z Series also eliminates the need to tension product on the job or the factory floor.
- If you currently have a window using a 5/8" spiral platform, mounting 85Z Series will remain the same. No tensioning required. It operates in the same style tilt shoes in use today. It should also fit into most windows currently utilizing our 88L Series or 60 Series Balances.

- Outwardly, it looks virtually identical to our 85 Series Balance.
- 85Z Series will fit into the same jambs that 85 Series fits into and provides a similar look.
- It's pre-tensioned. Many of our customers have been asking for a pre-tensioned spiral product. Here it is. Just mount the balance, connect the carrier, and it's done!

Other sizes available. Contact your Account Representative.

Tube Length	Number Stamped on Balance	Weight Capacity	Our Part Number	Tube Length	Number Stamped on Balance	Weight Capacity	Our Part Number	Tube Length	Number Stamped on Balance	Weight Capacity	Our Part Number	Tube Length	Number Stamped on Balance	Weight Capacity	Our Part Number
15"	E15A	4 to 8 lbs	85Z-E15A	21"	E21B	8 to 11 lbs	85Z-E21B	26"	E26B	8 to 11 lbs	85Z-E26B	31"	E31B	8 to 11 lbs	85Z-E31B
15"	E15B	8 to 11 lbs	85Z-E15B	21"	E21C	11 to 14 lbs	85Z-E21C	26"	E26C	11 to 14 lbs	85Z-E26C	31"	E31C	11 to 14 lbs	85Z-E31C
15"	E15C	11 to 14 lbs	85Z-E15C	21"	E21D	14 to 18 lbs	85Z-E21D	26"	E26D	14 to 18 lbs	85Z-E26D	31"	E31D	14 to 18 lbs	85Z-E31D
15"	E15D	14 to 18 lbs	85Z-E15D	21"	E21E	18 to 24 lbs	85Z-E21E	26"	E26E	18 to 24 lbs	85Z-E26E	31"	E31E	18 to 24 lbs	85Z-E31E
15"	E15E	18 to 24 lbs	85Z-E15E	21"	E21F	24 to 30 lbs	85Z-E21F	26"	E26F	24 to 30 lbs	85Z-E26F	31"	E31F	24 to 30 lbs	85Z-E31F
15"	E15F	24 to 28 lbs	85Z-E15F	21"	E21G	30 to 35 lbs	85Z-E21G	26"	E26G	30 to 35 lbs	85Z-E26G	31"	E31G	30 to 35 lbs	85Z-E31G
16"	E16A	4 to 8 lbs	85Z-E16A	21"	E21H	35 to 40 lbs	85Z-E21H	26"	E26H	35 to 40 lbs	85Z-E26H	31"	E31H	35 to 40 lbs	85Z-E31H
16"	E16B	8 to 11 lbs	85Z-E16B	21"	E21J	40 to 47 lbs	85Z-E21J	26"	E26J	40 to 47 lbs	85Z-E26J	31"	E31J	40 to 47 lbs	85Z-E31J
16"	E16C	11 to 14 lbs	85Z-E16C	21"	E21K	47 to 54 lbs	85Z-E21K	26"	E26K	47 to 54 lbs	85Z-E26K	31"	E31K	47 to 54 lbs	85Z-E31K
16"	E16D	14 to 18 lbs	85Z-E16D	21"	E21M	54 to 60 lbs	85Z-E21M	26"	E26M	54 to 60 lbs	85Z-E26M	31"	E31M	54 to 60 lbs	85Z-E31M
16"	E16E	18 to 24 lbs	85Z-E16E	22"	E22B	8 to 11 lbs	85Z-E22B	27"	E27B	8 to 11 lbs	85Z-E27B	32"	E32B	8 to 11 lbs	85Z-E32B
16"	E16F	24 to 28 lbs	85Z-E16F	22"	E22C	11 to 14 lbs	85Z-E22C	27"	E27C	11 to 14 lbs	85Z-E27C	32"	E32C	11 to 14 lbs	85Z-E32C
17"	E17A	4 to 8 lbs	85Z-E17A	22"	E22D	14 to 18 lbs	85Z-E22D	27"	E27D	14 to 18 lbs	85Z-E27D	32"	E32D	14 to 18 lbs	85Z-E32D
17"	E17B	8 to 11 lbs	85Z-E17B	22"	E22E	18 to 24 lbs	85Z-E22E	27"	E27E	18 to 24 lbs	85Z-E27E	32"	E32E	18 to 24 lbs	85Z-E32E
17"	E17C	11 to 14 lbs	85Z-E17C	22"	E22F	24 to 30 lbs	85Z-E22F	27"	E27F	24 to 30 lbs	85Z-E27F	32"	E32F	24 to 30 lbs	85Z-E32F
17"	E17D	14 to 18 lbs	85Z-E17D	22"	E22G	30 to 35 lbs	85Z-E22G	27"	E27G	30 to 35 lbs	85Z-E27G	32"	E32G	30 to 35 lbs	85Z-E32G
17"	E17E	18 to 24 lbs	85Z-E17E	22"	E22H	35 to 40 lbs	85Z-E22H	27"	E27H	35 to 40 lbs	85Z-E27H	32"	E32H	35 to 40 lbs	85Z-E32H
17"	E17F	24 to 30 lbs	85Z-E17F	22"	E22J	40 to 47 lbs	85Z-E22J	27"	E27J	40 to 47 lbs	85Z-E27J	32"	E32J	40 to 47 lbs	85Z-E32J
17"	E17G	30 to 35 lbs	85Z-E17G	22"	E22K	47 to 54 lbs	85Z-E22K	27"	E27K	47 to 54 lbs	85Z-E27K	32"	E32K	47 to 54 lbs	85Z-E32K
17"	E17H	35 to 40 lbs	85Z-E17H	22"	E22M	54 to 60 lbs	85Z-E22M	27"	E27M	54 to 60 lbs	85Z-E27M	32"	E32M	54 to 60 lbs	85Z-E32M
18"	E18B	8 to 11 lbs	85Z-E18B	23"	E23B	8 to 11 lbs	85Z-E23B	28"	E28B	8 to 11 lbs	85Z-E28B	33"	E33B	12 to 14 lbs	85Z-E33B
18"	E18C	11 to 14 lbs	85Z-E18C	23"	E23C	11 to 14 lbs	85Z-E23C	28"	E28C	11 to 14 lbs	85Z-E28C	33"	E33D	14 to 18 lbs	85Z-E33D
18"	E18D	14 to 18 lbs	85Z-E18D	23"	E23D	14 to 18 lbs	85Z-E23D	28"	E28D	14 to 18 lbs	85Z-E28D	33"	E33E	18 to 24 lbs	85Z-E33E
18"	E18E	18 to 24 lbs	85Z-E18E	23"	E23E	18 to 24 lbs	85Z-E23E	28"	E28E	18 to 24 lbs	85Z-E28E	33"	E33F	24 to 30 lbs	85Z-E33F
18"	E18F	24 to 30 lbs	85Z-E18F	23"	E23F	24 to 30 lbs	85Z-E23F	28"	E28F	24 to 30 lbs	85Z-E28F	33"	E33G	30 to 35 lbs	85Z-E33G
18"	E18G	30 to 35 lbs	85Z-E18G	23"	E23G	30 to 35 lbs	85Z-E23G	28"	E28G	30 to 35 lbs	85Z-E28G	33"	E33H	35 to 40 lbs	85Z-E33H
18"	E18H	35 to 40 lbs	85Z-E18H	23"	E23H	35 to 40 lbs	85Z-E23H	28"	E28H	35 to 40 lbs	85Z-E28H	33"	E33J	40 to 47 lbs	85Z-E33J
18"	E18J	40 to 47 lbs	85Z-E18J	23"	E23J	40 to 47 lbs	85Z-E23J	28"	E28J	40 to 47 lbs	85Z-E28J	33"	E33K	47 to 54 lbs	85Z-E33K
18"	E18K	47 to 54 lbs	85Z-E18K	23"	E23K	47 to 54 lbs	85Z-E23K	28"	E28K	47 to 54 lbs	85Z-E28K	33"	E33M	54 to 60 lbs	85Z-E33M
18"	E18M	54 to 60 lbs	85Z-E18M	23"	E23M	54 to 60 lbs	85Z-E23M	28"	E28M	54 to 60 lbs	85Z-E28M	34"	E34C	12 to 14 lbs	85Z-E34C
19"	E19B	8 to 11 lbs	85Z-E19B	24"	E24B	8 to 11 lbs	85Z-E24B	29"	E29B	8 to 11 lbs	85Z-E29B	34"	E34D	14 to 18 lbs	85Z-E34D
19"	E19C	11 to 14 lbs	85Z-E19C	24"	E24C	11 to 14 lbs	85Z-E24C	29"	E29C	11 to 14 lbs	85Z-E29C	34"	E34E	18 to 24 lbs	85Z-E34E
19"	E19D	14 to 18 lbs	85Z-E19D	24"	E24D	14 to 18 lbs	85Z-E24D	29"	E29D	14 to 18 lbs	85Z-E29D	34"	E34F	24 to 30 lbs	85Z-E34F
19"	E19E	18 to 24 lbs	85Z-E19E	24"	E24E	18 to 24 lbs	85Z-E24E	29"	E29E	18 to 24 lbs	85Z-E29E	34"	E34G	30 to 35 lbs	85Z-E34G
19"	E19F	24 to 30 lbs	85Z-E19F	24"	E24F	24 to 30 lbs	85Z-E24F	29"	E29F	24 to 30 lbs	85Z-E29F	34"	E34H	35 to 40 lbs	85Z-E34H
19"	E19G	30 to 35 lbs	85Z-E19G	24"	E24G	30 to 35 lbs	85Z-E24G	29"	E29G	30 to 35 lbs	85Z-E29G	34"	E34J	40 to 47 lbs	85Z-E34J
19"	E19H	35 to 40 lbs	85Z-E19H	24"	E24H	35 to 40 lbs	85Z-E24H	29"	E29H	35 to 40 lbs	85Z-E29H	34"	E34K	47 to 54 lbs	85Z-E34K
19"	E19J	40 to 47 lbs	85Z-E19J	24"	E24J	40 to 47 lbs	85Z-E24J	29"	E29J	40 to 47 lbs	85Z-E29J	34"	E34M	54 to 60 lbs	85Z-E34M
19"	E19K	47 to 54 lbs	85Z-E19K	24"	E24K	47 to 54 lbs	85Z-E24K	29"	E29K	47 to 54 lbs	85Z-E29K	35"	E35C	12 to 14 lbs	85Z-E35C
19"	E19M	54 to 60 lbs	85Z-E19M	24"	E24M	54 to 60 lbs	85Z-E24M	29"	E29M	54 to 60 lbs	85Z-E29M	35"	E35D	14 to 18 lbs	85Z-E35D
20"	E20B	8 to 11 lbs	85Z-E20B	25"	E25B	8 to 11 lbs	85Z-E25B	30"	E30B	8 to 11 lbs	85Z-E30B	35"	E35E	18 to 24 lbs	85Z-E35E
20"	E20C	11 to 14 lbs	85Z-E20C	25"	E25C	11 to 14 lbs	85Z-E25C	30"	E30C	11 to 14 lbs	85Z-E30C	35"	E35F	24 to 30 lbs	85Z-E35F
20"	E20D	14 to 18 lbs	85Z-E20D	25"	E25D	14 to 18 lbs	85Z-E25D	30"	E30D	14 to 18 lbs	85Z-E30D	35"	E35G	30 to 35 lbs	85Z-E35G
20"	E20E	18 to 24 lbs	85Z-E20E	25"	E25E	18 to 24 lbs	85Z-E25E	30"	E30E	18 to 24 lbs	85Z-E30E	35"	E35H	35 to 40 lbs	85Z-E35H
20"	E20F	24 to 30 lbs	85Z-E20F	25"	E25F	24 to 30 lbs	85Z-E25F	30"	E30F	24 to 30 lbs	85Z-E30F	35"	E35J	40 to 47 lbs	85Z-E35J
20"	E20G	30 to 35 lbs	85Z-E20G	25"	E25G	30 to 35 lbs	85Z-E25G	30"	E30G	30 to 35 lbs	85Z-E30G	35"	E35K	47 to 54 lbs	85Z-E35K
20"	E20H	35 to 40 lbs	85Z-E20H	25"	E25H	35 to 40 lbs	85Z-E25H	30"	E30H	35 to 40 lbs	85Z-E30H	35"	E35M	54 to 60 lbs	85Z-E35M
20"	E20J	40 to 47 lbs	85Z-E20J	25"	E25J	40 to 47 lbs	85Z-E25J	30"	E30J	40 to 47 lbs	85Z-E30J				
20"	E20K	47 to 54 lbs	85Z-E20K	25"	E25K	47 to 54 lbs	85Z-E25K	30"	E30K	47 to 54 lbs	85Z-E30K				
20"	E20M	54 to 60 lbs	85Z-E20M	25"	E25M	54 to 60 lbs	85Z-E25M	30"	E30M	54 to 60 lbs	85Z-E30M				

85 SERIES BALANCE ACCESSORIES

PIVOT BARS

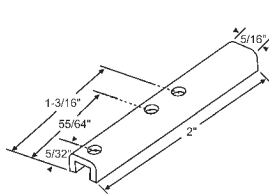

900-14310
Stainless Steel
FIBERLUX

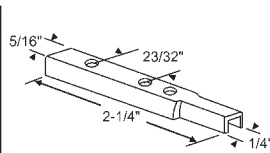

85-557
Stamped. Use with 83-506
Pivot Lock Shoe.
ROLLYSON

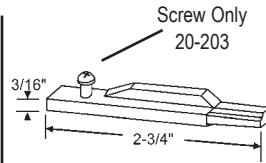

85-500
Die Cast with Screw. Use with
85-517 Pivot Lock Shoe.
TROCAL

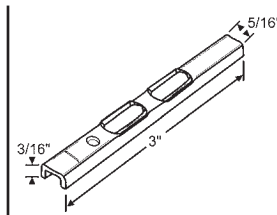

Part #	Description
85-513	Steel
85-513SS	Stainless Steel

Slotted Pivot Bar

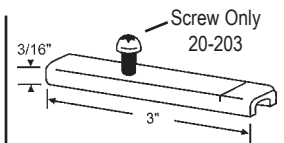

85-501
Stamped with Screw
ACORN/NORANDEX

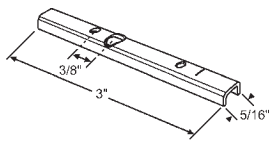

85-5025

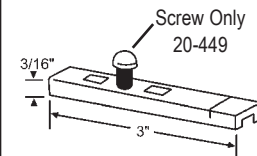

85-514
Stamped

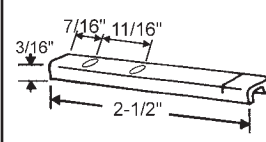

85-591E
Stamped

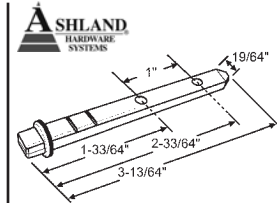

85-895
Zinc Die Cast

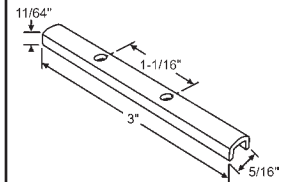

900-17544

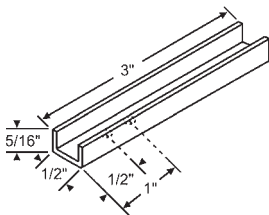

85-567
Pivot Bar. Stainless Steel

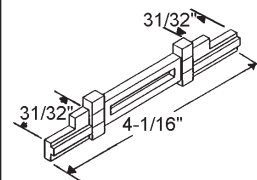

900-14299
Die Cast
SWS

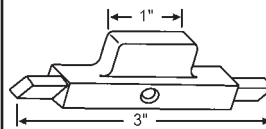

900-10700
Die Cast
SEASONALL

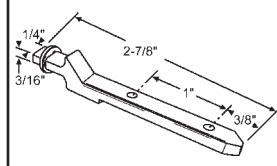

85-5005
Zinc Die Cast

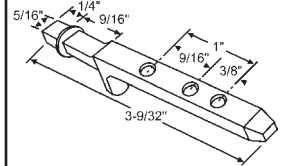

85-5003
Die Cast
SIMONTON

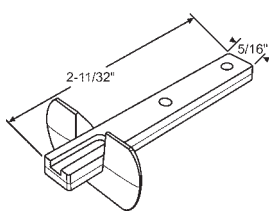

900-22450
"Old Style" Metal Die Cast

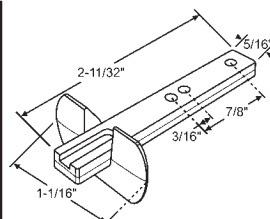

900-22450NS
"New Style" Metal Die Cast

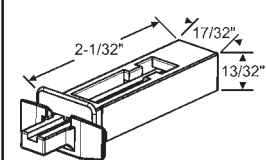

85-1197A
Pivot Bar & Housing Assembly.
Clear Nylon Housing
w/ Die Cast Pivot Bar
SILVER LINE

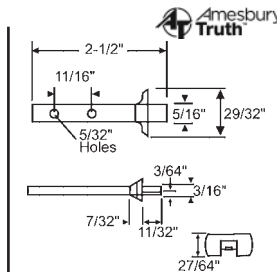

85-866
Die Cast
SILVER LINE

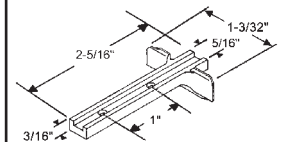

85-718
Die Cast
SILVER LINE

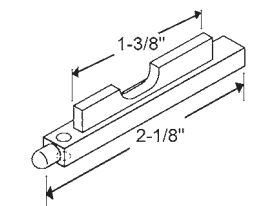

85-698
Bar Only. Die Cast
BETTER-BILT

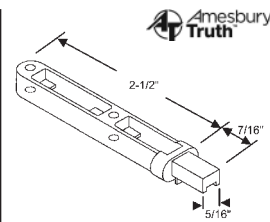

85-573
Die Cast Universal Pivot Bar

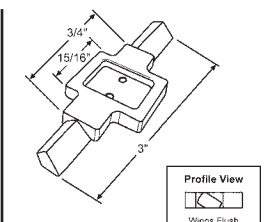

900-20043
Old Style

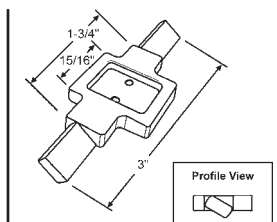

900-8599
New Style. Die Cast
TACO

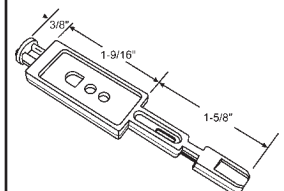

900-18822
Die Cast
ACRO/SLOCOMB

SASH SUPPORT SYSTEMS

85 SERIES BALANCE ACCESSORIES

PIVOT BARS

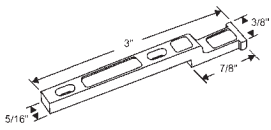

85-852
Die Cast

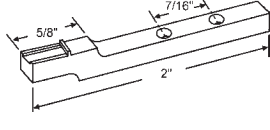

85-585

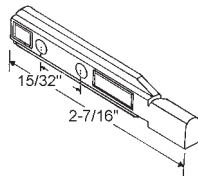

900-18821
RH (shown) and LH Set
Die Cast

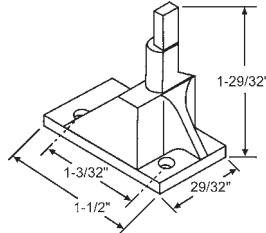

900-13070A
Die Cast. Sold in sets only.

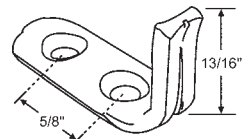

85-5035
Sash Pivot Pin Kit. Kit Includes
two Sash Pivot Pins w/ Screws
PEACHTREE

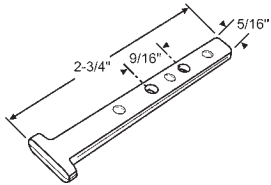

85-764
Zinc Die Cast

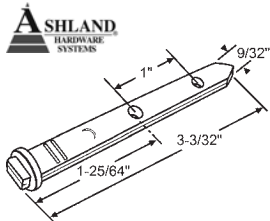

900-21355
Zinc Die Cast

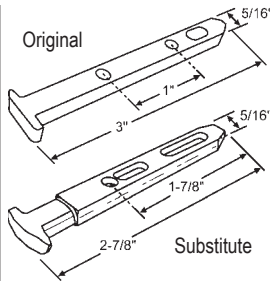

85-1016
Zinc Die Cast

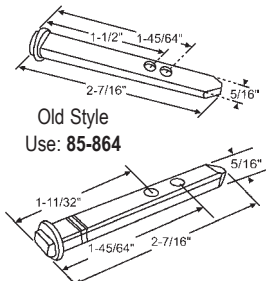

85-864
Die Cast

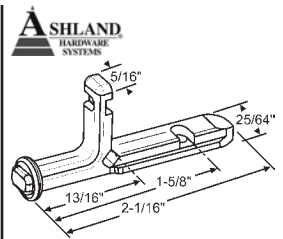

85-1062A
Zinc Die Cast
(Packed & Sold in Pairs)

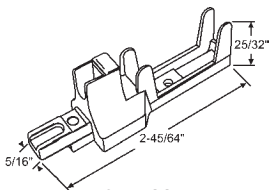

85-744
No Longer Available.
Use 900-15752

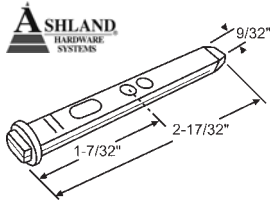

85-998
Zinc Die Cast

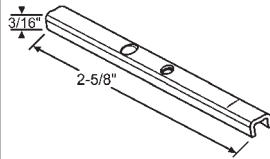

85-522
Metal
KRESTMARK

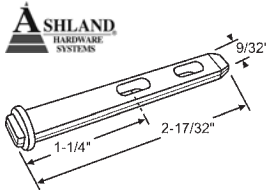

900-21878
Zinc Die Cast

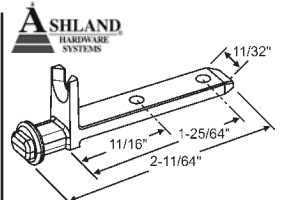

85-1053
Zinc Die Cast

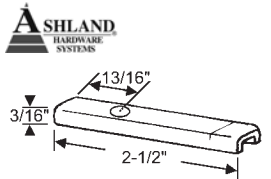

85-574

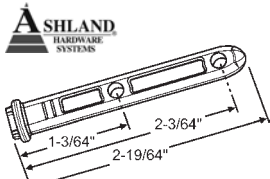

85-1034
Zinc Die Cast

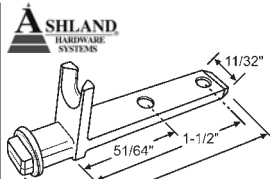

85-1061
Zinc Die Cast

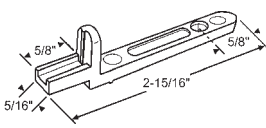

85-1044
Zinc Die Cast
REYNOLDS

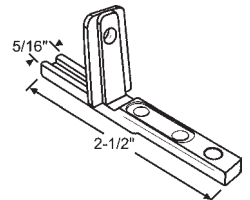

85-1129
Metal

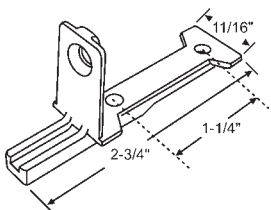

85-766
SPECTUS

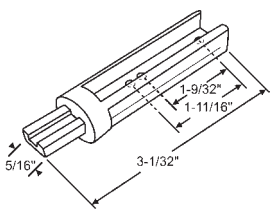

Part #	Hand
900-21497RH	Shown
900-21497LH	Opposite

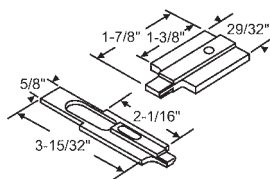

85-822
Sold in sets only (1 short, 1 long).
Stamped. Used with 85-525 Pivot
Lock Shoe.
THERMAGARD

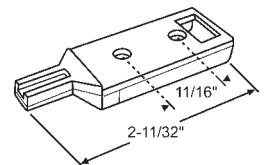

85-788NW
Zinc Die Cast (No Wings)

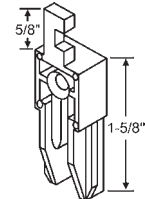

900-18446A
Die Cast. Sold in sets only.
HARVEY

85 SERIES BALANCE ACCESSORIES

PIVOT BAR SETS

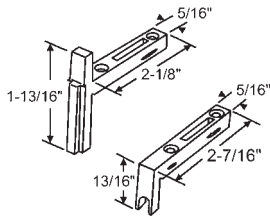

85-886PA
White Plastic Set

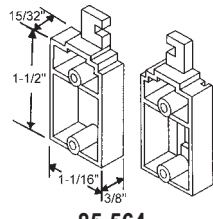

85-564
Die Cast
HARVEY

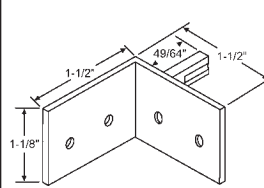

900-16398A
Sash Pivot Angle Bracket
Set (LH/RH). Aluminum

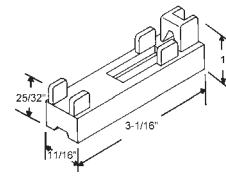

900-20368
Bottom Pivot Bar Corner
Used with 85-717 & 85-718
SILVER LINE

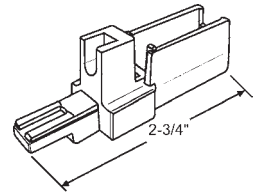

900-15752
Die Cast

PIVOT BAR HOUSINGS

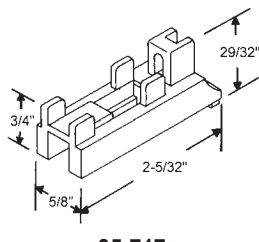

85-717
White. Use with 85-718 Pivot Bar.
SILVER LINE

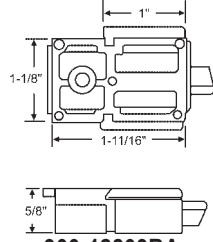

900-12809BA
Sold in sets only. Upper. Black
AMACOR

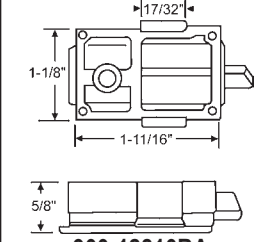

900-12810BA
Sold in sets only. Lower. Black
AMACOR

PIVOT BLOCK

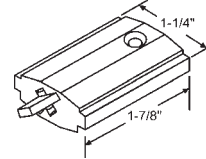

Part #	Hand
900-2367RH	Shown
900-2367LH	Opposite

Black
ALENCO

CARRIER ASSEMBLY

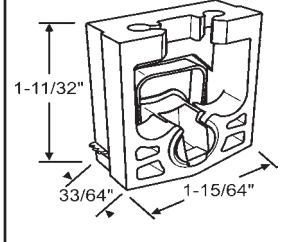

85-5040
Carrier Assembly

CARRIER ASSEMBLY

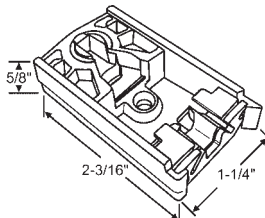

85-5016
POS Lock w/ Torque Plate

LOCKING TERMINAL

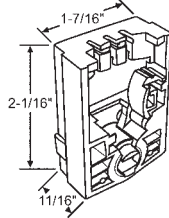

85-973
REPUBLIC

PIVOT LOCK SHOES

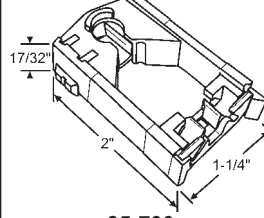

85-799
With White Cam
CALDWELL

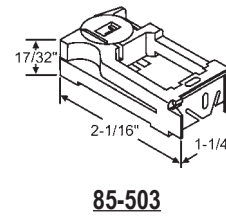

85-503
Blue Cam
Cam Opening: 5/16" x 3/16"
ACORN/NORANDEX

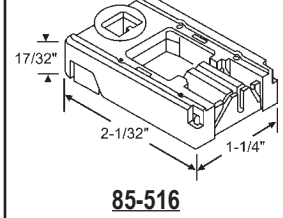

85-516
Tan Cam
Cam Opening: 3/8" x 3/16"
FIBERLUX

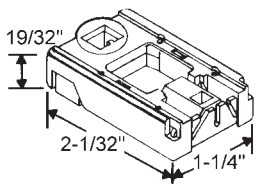

85-505
Die Cast Cam
No Longer Available
Use: 85-517

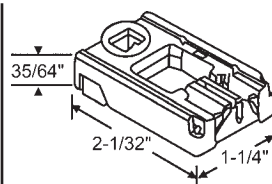

85-541
Blue Cam with White Brake
Cam Opening: 3/8" x 5/32"

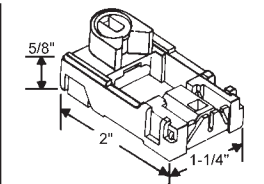

85-518
Red Cam
Cam Opening: 3/8" x 3/16"
TRACO

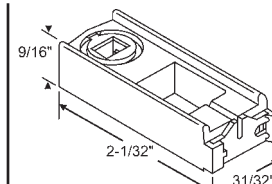

85-544
White Cam
Cam Opening: 5/16" x 3/16"

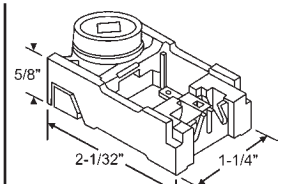

85-525
Black Cam
Cam Opening: 5/16" x 3/16"
THERMALGARD

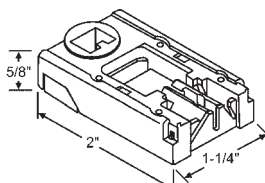

85-540
Black Cam
Cam Opening: 5/16" x 3/16"
Uses 85-550 Spacer.

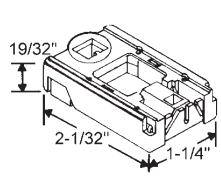

85-517
Black Cam
Cam Opening: 3/8" x 3/16"

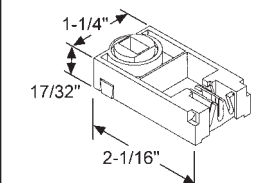

85-590
Blue Cam & Blue Brake w/max
width opening of 1.310
Cam Openings = 5/16" x 3/16"

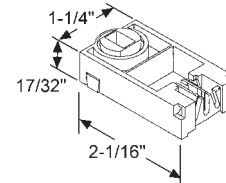

85-588
Blue Cam & Black Brake Puck
Cam Opening: 5/16" x 3/16"

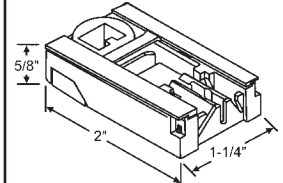

85-589
Black Cam

SASH SUPPORT SYSTEMS

85 SERIES BALANCE ACCESSORIES

PIVOT LOCK SHOES

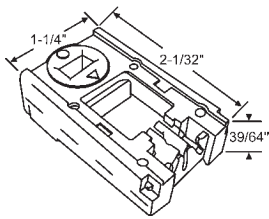

85-534
Light Green Cam

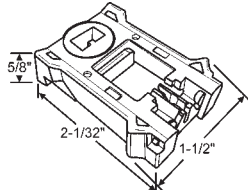

85-539
Natural Cam
Cam Opening: 5/16" x 3/16".
Can be used in place of 85-540
with 85-550

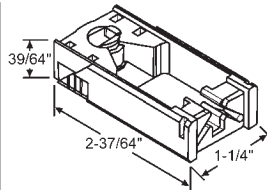

85-1076
Zinc Die Cast Cam
SILVERLINE

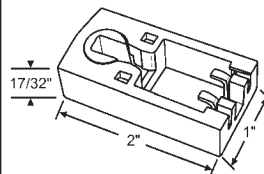

85-5004
.530 Thick With 2 Metal Prongs
UNIQUE

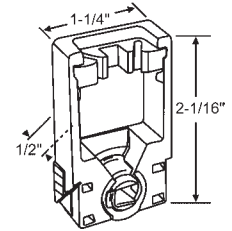

85-971A
Brake Ext. 1.34. Metal Cam

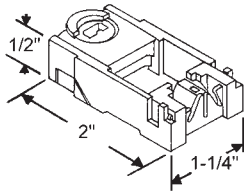

85-531
No Longer Available.
Use 85-590

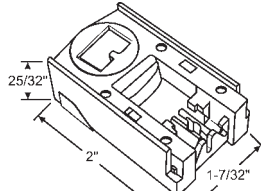

85-5045

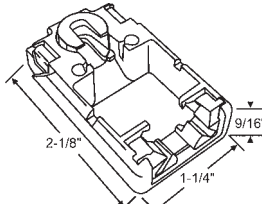

900-21341
Blue-Gray Pad - .055 Pad
Projection. Replaces White Pad.

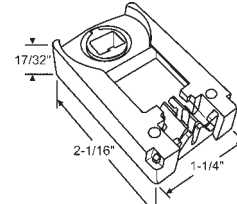

85-807
w/White Cam
CALDWELL

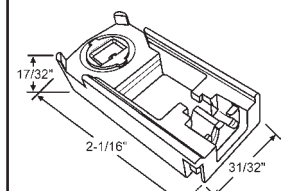

85-802
w/Black Cam

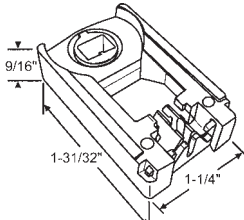

85-804
Black Cam

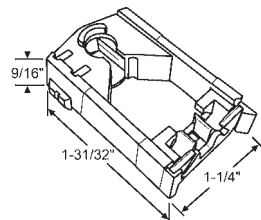

85-570
Black Enforcer

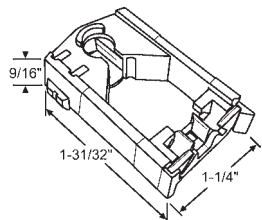

85-800
Natural Cam
Orange Locking Pad

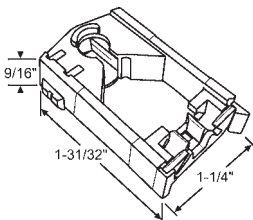

85-801
Natural Cam
Navy Blue Locking Pad

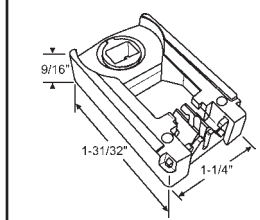

85-805
Orange Cam

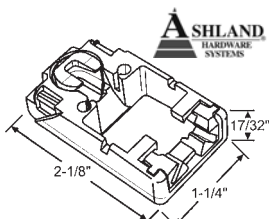

85-5070
White Pad

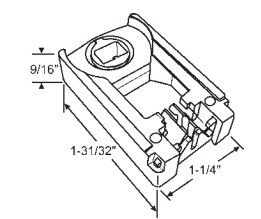

85-806
Navy Blue Cam

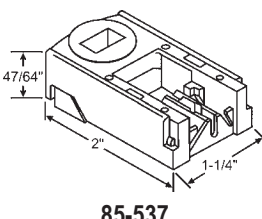

85-537
Natural Cam
Cam Opening: 1/2" x 5/16"

PIVOT LOCK SHOE FILLERS

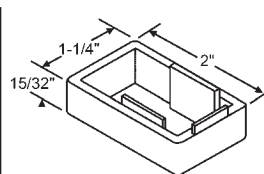

85-559
Used with Pivot Lock
Shoe 85-517.
MANNIX

SPACER SHIM

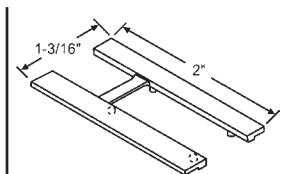

85-524
Used with 85-517
1/32" Thick

SLIDE GUIDES

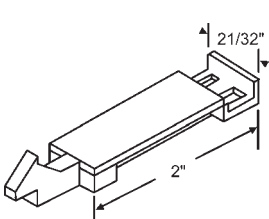

85-601
White
TRACO

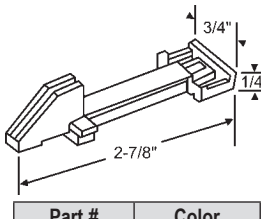

Part #	Color
85-506	Natural
85-506B	Black

GRAHAM

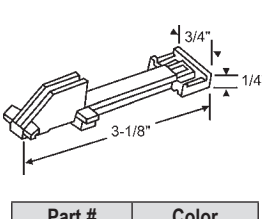

Part #	Color
85-507	White

WEATHERCRAFT

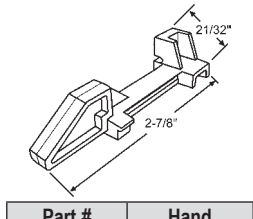

Part #	Hand
85-772RH	Shown
85-772LH	Opposite

Slide Bolt

SPRING HOOK

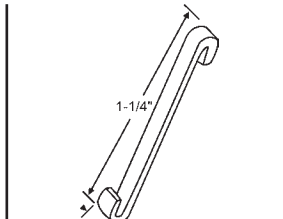

85-510
Metal
TRACO

85 SERIES BALANCE ACCESSORIES

SPRING

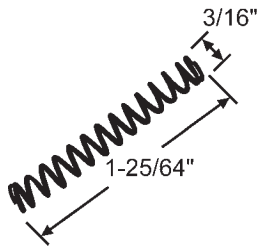

85-509

DUST COVER

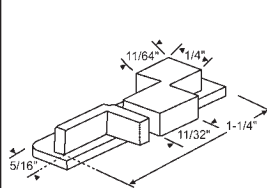

Part #	Hand
900-6783RH	Shown
900-6783LH	Opposite

White

HOUSING PLUG

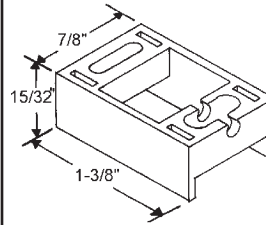

Part #	Color
900-5789	White
900-5789BR	Brown
900-5789BG	Beige

FIBERLUX

TAMP-R-LOCKS

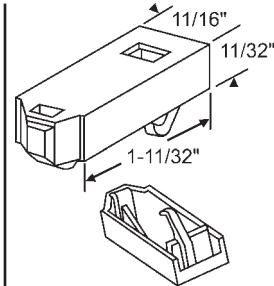

85-606
Black
Used with 85-518

SLIDE GUIDES

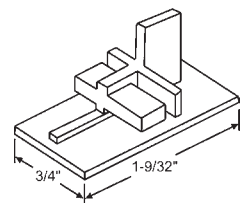

Part #	Color
85-605A	Black
85-605WA	White

Lower. Sold in sets only.
TRACO

VENT LOCKS

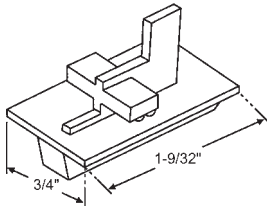

Part #	Color
85-603	Black
85-603N	Natural

White Version (85-602) No Longer Available.

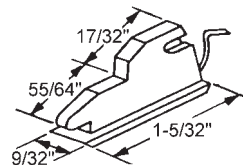

Part #	Color
900-11406	White
900-11406B	Black
900-11406BR	Brown
900-11406BG	Beige

ALL WEATHER/ROLLYSON

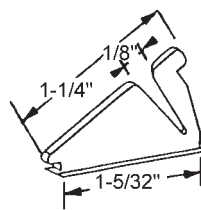

Part #	Color
900-12557	White

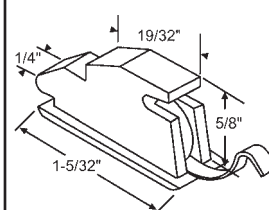

Part #	Color
900-2433	White
900-2433BG	Beige

FIBERLUX

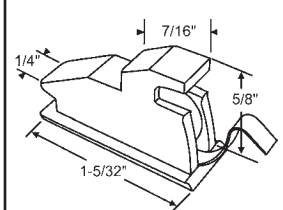

Part #	Color
900-16381	Beige

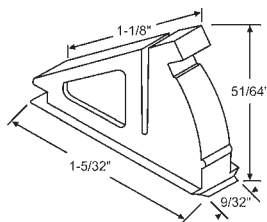

Part #	Color
900-16594	White

FIBERLUX

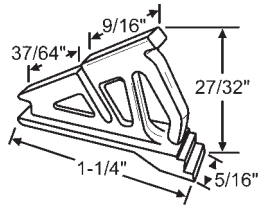

Part #	Color
900-19788	Beige
900-19788B	Black
900-19788W	White

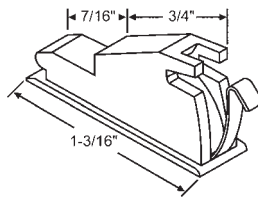

Part #	Color
900-20055W	White
900-20055BG	Beige
900-20055LGY	Light Gray

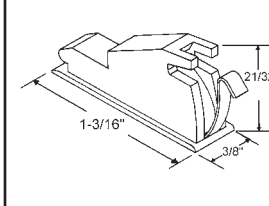

Part #	Color
900-7796	White

No longer available.
Use: 900-20055W
SEASONALL

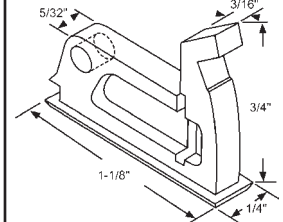

Part #	Color
85-825BZ	Dark Bronze

VENT STOP

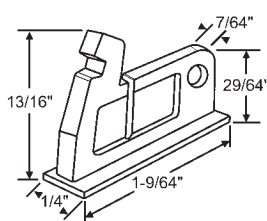

Part #	Color
900-22266W	White
900-22266BEW	Blue White

Nylon
INTERSTATE

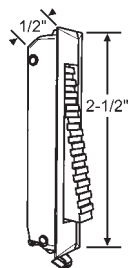

Part #	Color
900-13386	White
900-13386BR	Brown
900-13386BG	Beige

TRACO

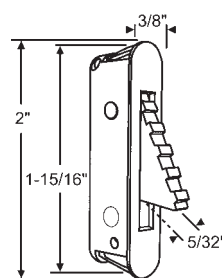

Part #	Color
85-985BG	Beige
85-985W	White

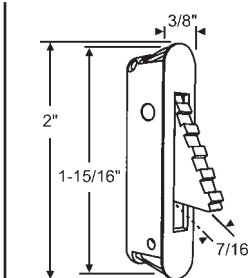

Part #	Color
900-20122W	White
900-20122BR	Dark Brown

Limit Latch

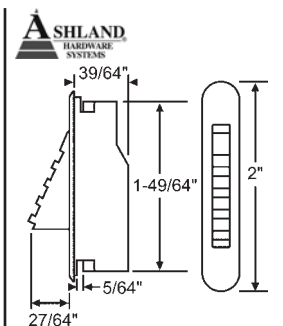

85-1245EW
Euro-White

SASH SUPPORT SYSTEMS

85 SERIES BALANCE ACCESSORIES

VENT STOP

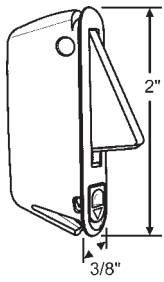

85-1288W
White Nylon

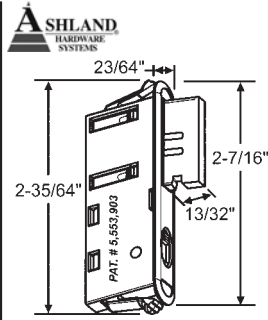

85-956W
White

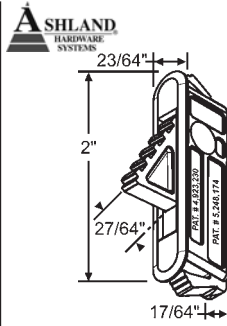

85-849W
White

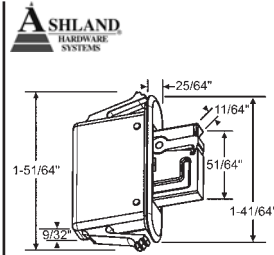

900-21461
White
Universal Vent Lock

SASH STOPS

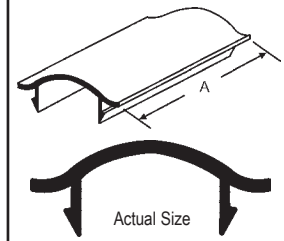

Part #	Color	"A"
900-8547B	Black	3"
900-8547B-4	Black	4"
900-8547B-6	Black	6"
900-8547B-12	Black	12"
900-8547B-24	Black	24"

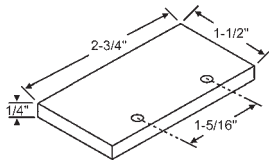

900-21112
Black
Anodized Aluminum

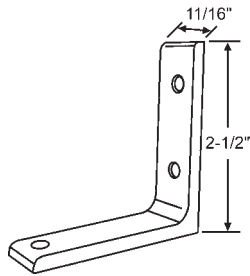

88-700
Black
Anodized Aluminum Angle Stop

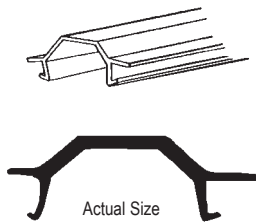

Part #	Length
900-14211	7'
900-14211-3	3-1/4"
900-14211BL	1"

Black

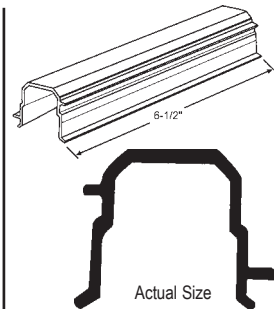

Part #	Color
900-16324B-6	Black
900-16324W-6	White

Plastic

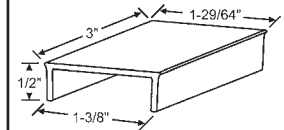

85-6002WX
White
PGT

HOLE PLUG

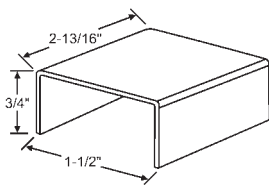

85-6003WX
White
PGT

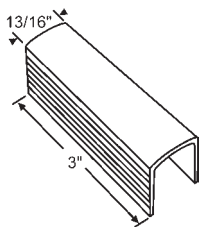

85-768
3" White Plastic

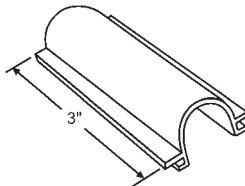

85-771
Black

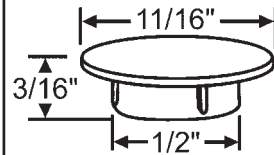

85-1051W
1/2" Nylon Hole Plug White
LINCOLN

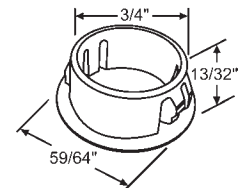

Part #	Color
85-1125B	Black
85-1125W	White

PGT

JAMB COVER

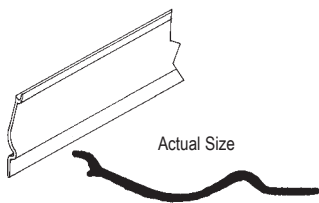

Part #	Color
85-702	Blue White
85-703	White
85-704	Charcoal Brown
85-702BG	Beige

Sold in 7' lengths, Minimum 140'

DUST CAP

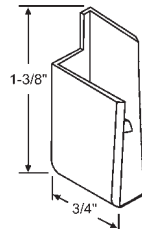

Part #	Hand
85-786LH	Shown
85-786RH	Opposite

Black
RIVERVIEW

TILT LATCH BLADE

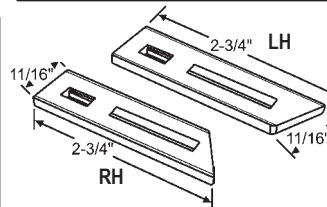

Part Number	Hand	Color
900-21006LB	LH	Brown
900-21006LH	LH	Beige
900-21006LW	LH	White
900-21006RB	RH	Brown
900-21006RH	RH	Beige
900-21006RW	RH	White

DAYTON

SLIDING LATCH

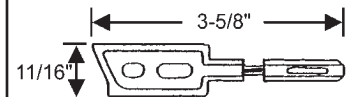

Part #	Color
900-18900W	White
900-18900BG	Beige

Fits Acro Windows

85 SERIES BALANCE ACCESSORIES

TILT LATCHES - In Order by Hole Spacing

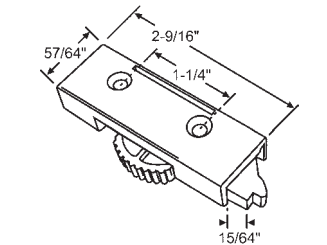
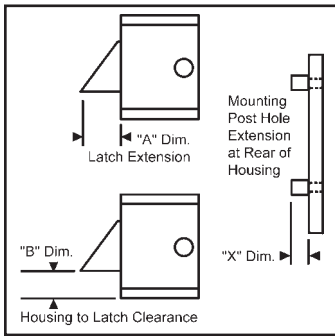

Part #	Color
85-936BZA	Bronze
85-936WA	White

Set (Includes RH & LH). RH Shown

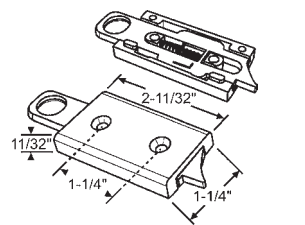

Part #	Color
85-793WA	White

Sold in sets only.

CERTAINTED

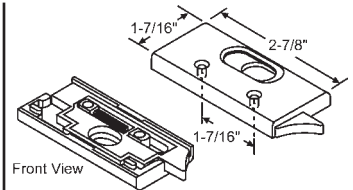

Part #	Color
900-20311WA	White

"A"	"B"	"X"
3/8"	21/32"	7/64"

Sold in Sets Only (LH Shown).

CERTAINTED

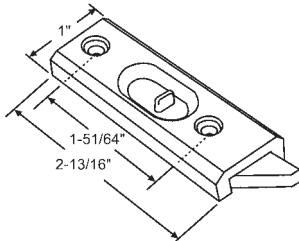

Part #	Color
85-773WA	White

"A"	"B"	"X"
13/32"	3/16"	Flush w/Housing

Sold in sets only (LH Shown).

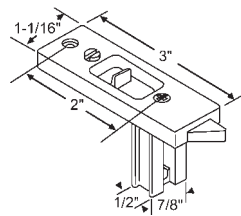

Part #	Color
900-16378WA	White
900-16378BRA	Brown

"A"	"B"	"X"
3/8"	7/32"	None

Sold in sets only (LH Shown).

FIBERLUX

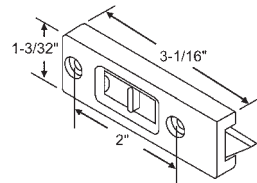

Part #	Color
85-618WA	White
85-618BA	Black
85-618BRA	Brown
85-618BGA	Beige

"A"	"B"	"X"
5/16"	1/4"	Flush w/Housing

Sold in sets only (LH Shown).

FIBERLUX

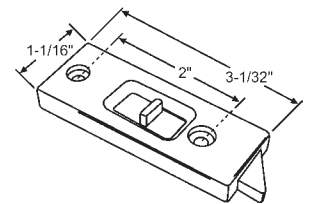

Part #	Hand	Color
85-737RW	Shown	White
85-737LW	Opposite	White

"A"	"B"	"X"
5/16"	3/32"	Flush w/Housing

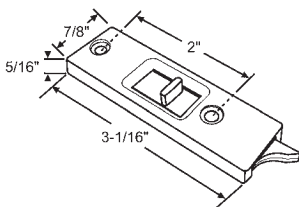

Part #	Color
85-887W	White

"A"	"B"	"X"
11/32"	3/16"	Flush w/Housing

Sold in sets only (LH Shown).

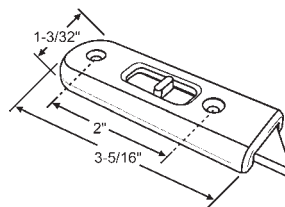

Part #	Color
85-817	White

"A"	"B"	"X"
7/16"	1/4"	Flush w/Housing

Sold in sets only

VINYLUME

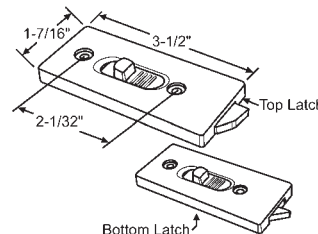

Part #	Color
85-726WH	White

Latch	"A"	"B"	"X"
Top	9/32"	15/32"	Flush w/Housing
Bottom	9/32"	11/16"	Flush w/Housing

Sold in sets only (LH Shown).

KEYSTONE

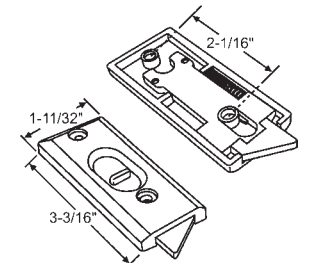

Part #	Color
900-16281WA	White

"A"	"B"	"X"
3/8"	5/16"	Flush w/Housing

Sold as set only.

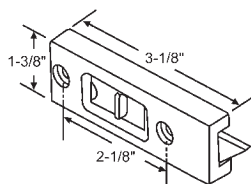

Part #	Hand	Color
85-528LHW	Shown	White
85-528RHW	Opposite	White
85-528LHB	Shown	Black
85-528RHB	Opposite	Black

"A"	"B"	"X"
11/16"	1/4"	Flush w/Housing

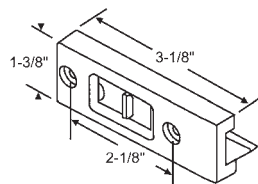

Part #	Hand	Color
85-529LHW	Shown	White
85-529RHW	Opposite	White
85-529LHB	Shown	Black
85-529RHB	Opposite	Black

"A"	"B"	"X"
11/16"	1/4"	1/8"

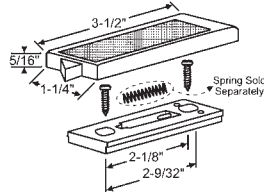

Part #	Color
85-626BA	Black
85-626BGA	Beige
85-626WA	White

Sold in sets only. LH Shown
Spring (Part# 85-626S) not included.

ATRIUM

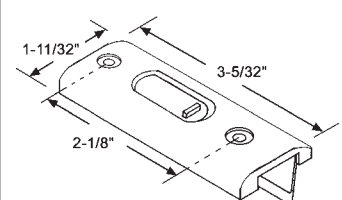

Part #	Color
900-12766WA	White
900-12766BA	Black

"A"	"B"	"X"
7/16"	1/4"	Flush w/Housing

Sold in sets only.

SASH SUPPORT SYSTEMS

85 SERIES BALANCE ACCESSORIES

TILT LATCHES - In Order by Hole Spacing

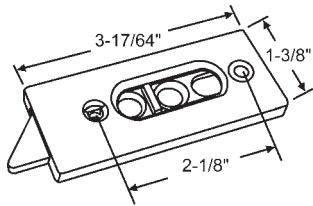

Part #	Color
900-16267A	White

"A"	"B"	"X"
1/2"	5/16"	Flush w/Housing

Sold in sets only.

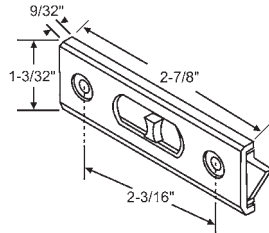

Part #	Color
900-19450WA	White

"A"	"B"	"X"
5/16"	5/16"	Flush w/Housing

Sold in sets only.

GENERAL ALUMINUM

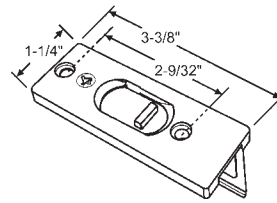

900-11868LHW/RHW

No Longer Available
Use: 900-11615W

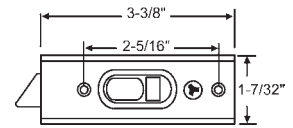

Part #	Color
85-616W	White
85-616B	Black

"A"	"B"	"X"
1/2"	1/4"	Flush w/Housing

Die Cast
Reversible

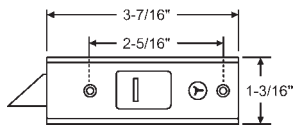

Part #	Color
85-578WA	White
85-578BA	Black

"A"	"B"	"X"
7/16"	1/4"	Flush w/Housing

Sold in sets only.

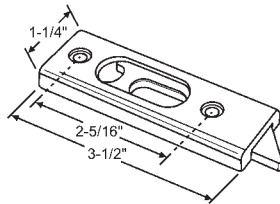

Part #	Color
85-533	Black
85-533WH	White

"A"	"B"	"X"
1/2"	5/16"	Flush w/Housing

Plastic
Reversible

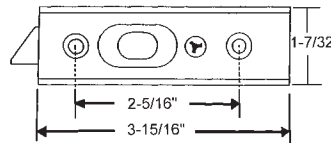

Part #	Color
85-617W	White
85-617B	Black

"A"	"B"	"X"
7/16"	9/32"	Flush w/Housing

Die Cast
Reversible

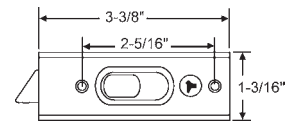

Part #	Color
900-11615B	Black
900-11615W	White

"A"	"B"	"X"
7/16"	5/16"	Flush w/Housing

Plastic
Reversible

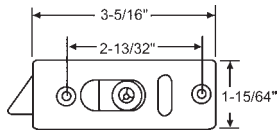

Part #	Hand	Color
85-532LHB	Shown	Black
85-532RHB	Opposite	Black
85-532LH	Shown	White
85-532RH	Opposite	White

"A"	"B"	"X"
7/16"	9/32"	Flush w/Housing

With lock. If needed, use tilt latch tool 59-6.

ACORN

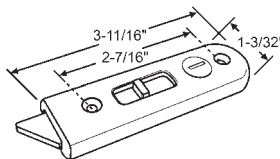

Part #	Hand	Color
85-6004RHW	Shown	White
85-6004LHW	Opposite	White

"A"	"B"	"X"
7/16"	1/4"	Flush w/Housing

PGT

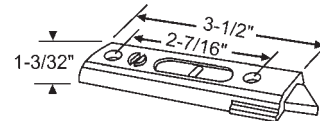

Part #	Color
900-16339BA	Black

"A"	"B"	"X"
1/2"	9/32"	Flush w/Housing

Sold in sets only.

PATRIOT

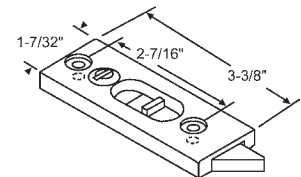

Part #	Color
900-19480WA	White

"A"	"B"	"X"
7/16"	5/16"	Flush w/Housing

Sold in sets only.

SEASONALL

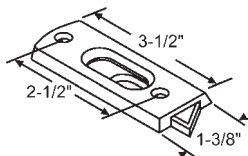

Part #	Color
85-736	White

"A"	"B"	"X"
13/32"	9/32"	1/8"

Universal

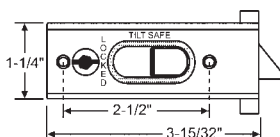

Part #	Color
85-719MB	Black
85-719MW	White

"A"	"B"	"X"
3/8"	3/8"	Flush w/Housing

Metal Housing w/Plastic Latch
Reversible
SEASONALL

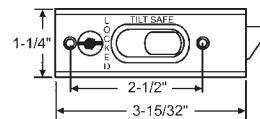

Part #	Color
85-619PW	White

Plastic Assembly

"A"	"B"	"X"
13/32"	5/16"	Flush w/Housing

Reversible
SEASONALL

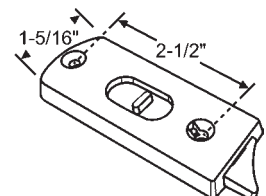

Part #	Color
85-763W	White
85-763B	Black
85-763BG	Beige

"A"	"B"	"X"
7/16"	9/32"	Flush w/Housing

ALENCO

85 SERIES BALANCE ACCESSORIES

TILT LATCHES - In Order by Hole Spacing

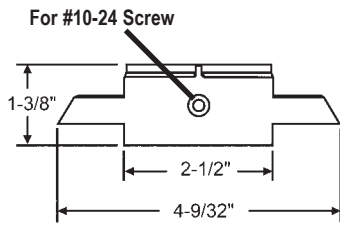

For #10-24 Screw

85-733

Zinc Die Cast
MANNIX

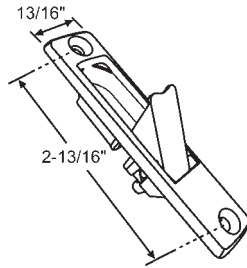

Part #	Color
85-5033A	Driftwood

Sash Tilt Latch Kit. Kit Includes LH and RH Tilt Latches w/Screws

PEACHTREE

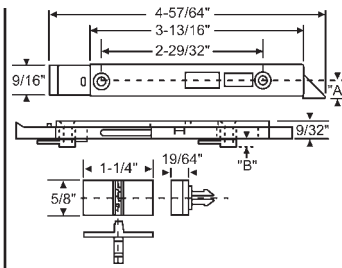

Part #	Hand	"A"	"B"
900-19869A	Shown	19/64"	3/32"
900-19875A	Shown	11/32"	9/64"

Sold in sets only (RH, LH).
White. Includes thumb button

SPECTUS

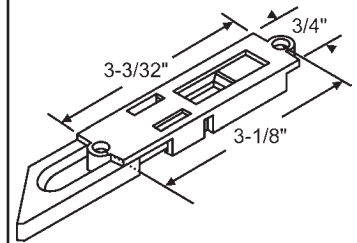

Part #	Color
900-19847WA	White

Sold in sets only.
Used with 900-19448 thumb button.

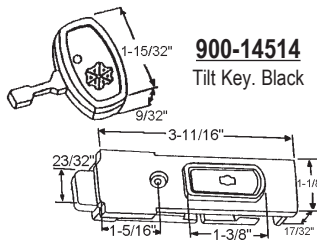

900-14514
Tilt Key. Black

Part #	Color
900-12808BA	Black

"A"	"B"	"X"
1/4"	5/16"	Flush w/Housing

Sold in sets only.

AMACOR

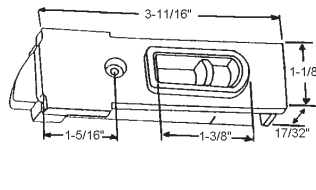

Part #	Color
900-15683BA	Black

"A"	"B"	"X"
9/32"	3/16"	Flush w/Housing

Sold in sets only.

AMACOR

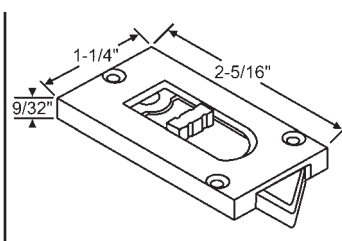

Part #	Color
900-20221WA	White

"A"	"B"	"X"
1/4"	5/16"	Flush w/Housing

Reversible

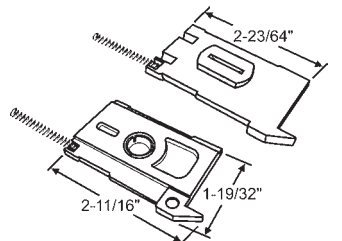

Part #	Color
85-1030WA	White

"A"	"B"	"X"
5/16"	1-3/8"	Flush w/Housing

Set (Includes RH & LH) RH Shown

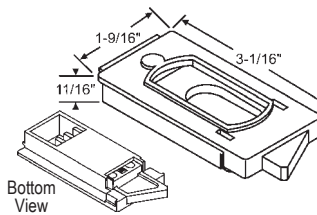

Bottom View

Part #	Color
900-19433WA	White
900-19433BA	Black
900-19433BGA	Beige

"A"	"B"	"X"
7/16"	3/8"	Slides onto Extrusion

Sold in sets only.

MANNIX & ECKER

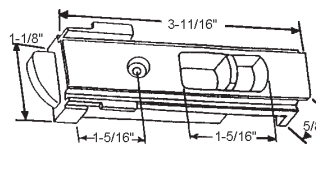

Part #	Color
900-15486BA	Black

"A"	"B"	"X"
1/4"	3/16"	Flush w/Housing

Sold in sets only.

AMACOR

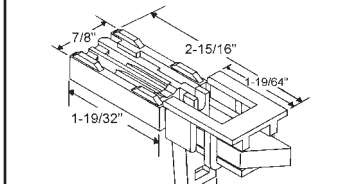

Part #	Color
900-16976WA	White

"A"	"B"	"X"
7/16"	5/16"	None

Sold in sets only.

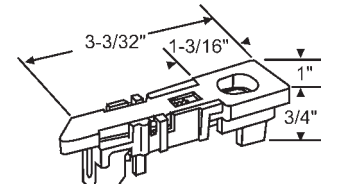

Part #	Color
900-17651A	White

Sold in sets only.

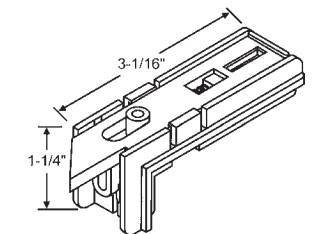

Part #	Hand
900-19178	Shown
900-19177	Opposite

White

MAYNARD/CHELSEA

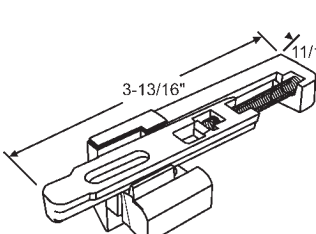

85-5034A

Sash Tilt Latch Housing Kit. Driftwood. Kit Includes LH and RH Housings w/ Screws

PEACHTREE

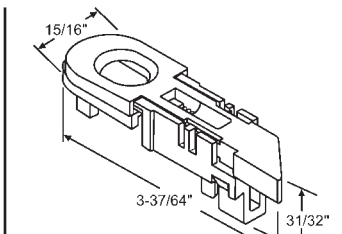

Part #	Hand
85-775RH	Shown
85-775LH	Opposite

DOVE/SILVER LINE

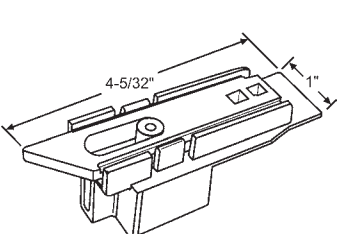

Part #	Color
85-827WA	White

Sold in sets only.

SASH SUPPORT SYSTEMS

85 SERIES BALANCE ACCESSORIES

SNAP-IN TILT LATCHES

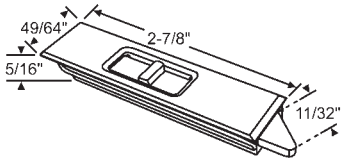

85-897WA

.092 Stile Snap. White RH & LH Set

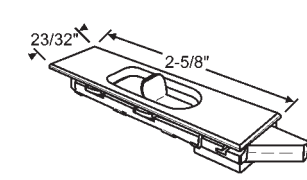

Part #	Color
85-1190BG	Beige
85-1190CY	Clay
85-1190W	White

"A"	"B"	"X"
3/8"	1/16"	Flush w/Housing

ALENCO

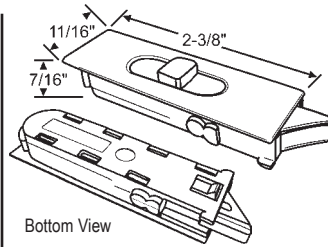

Bottom View

Part #	Hand	Color
85-932LH	Shown	White
85-932RH	Opposite	White

"A"	"B"	"X"
5/16"	1/8"	None

SILVER LINE

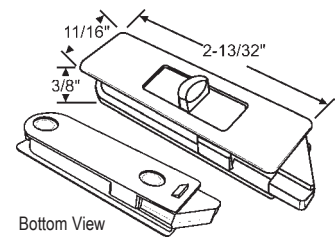

Bottom View

Part #	Color
85-963WA	Blue White

"A"	Nose Size
5/16"	3/8"

Sold in Sets Only (RH Shown).

SILVER LINE

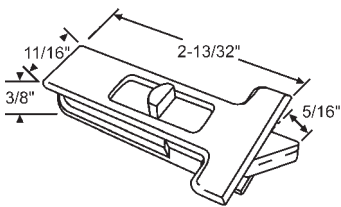

Width of Wings 1-7/16"

85-900WA

White

Set (1 RH/ 1 LH) LH Shown

SILVER LINE

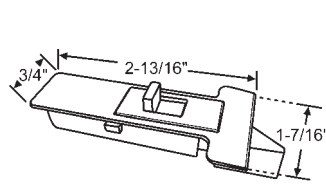

Part #	Color
85-962WA	White

"A"	"B"	"X"
3/8"	7/16"	None

Sold in Sets Only (RH Shown)

SILVER LINE

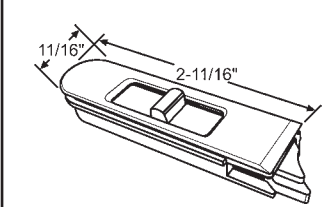

Part #	Hand	Color
85-6005RHW	Shown	White
85-6005LHW	Opposite	White

"A"	"B"	"X"
11/32"	3/32"	None

PGT

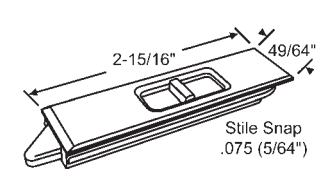

Stile Snap
.075 (5/64")

Part #	Color
85-853WA	White

"A"	"B"
3/8"	5/32"

Sold in sets only.

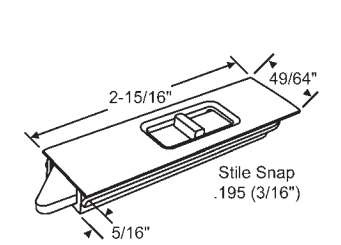

Stile Snap
.195 (3/16")

Part #	Color
85-892WA	White

"A"	"B"
3/8"	5/32"

Sold in sets only.

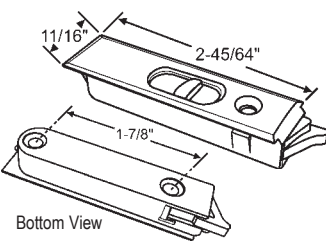

Bottom View

Part #	Hand	Color
85-940WA	LH/RH Set	White
85-940LBG	Shown	Beige
85-940RBG	Opposite	Beige

"A"	"B"	"X"
5/16"	1/16"	None

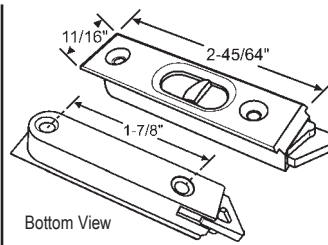

Bottom View

Part #	Hand	Color
85-939LW	Shown	White
85-939RW	Opposite	White

"A"	"B"	"X"
7/16"	Flush w/Housing	None

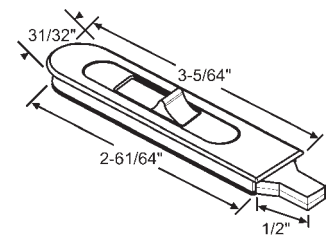

Part #	Color
85-905-3	White

Non-Handed

POZZI/JELD-WEN

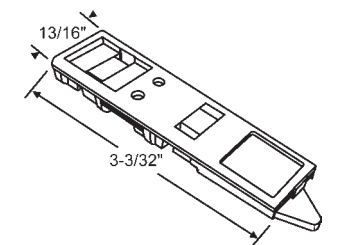

Part #	Color
85-809WA	White

"A"	"B"	"X"
7/16"	1/16"	None

Sold in Sets

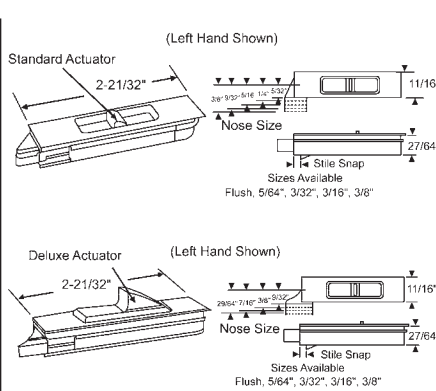

Standard Nose Chart

Our Part #	Hand	Color	Nose Size	Stile Snap Size	Actuator
85-910WA	Set	White	1/4"	5/64"	Standard
85-910A	Set	Dark Brown	1/4"	5/64"	Standard
900-21229A	Set	Blue White	1/4"	3/16"	Standard
85-819WA	Set	Blue White	9/32"	3/32"	Standard
85-1054WA	Set	White	9/32"	3/8"	Standard
900-19498WA	Set	White	3/8"	3/16"	Deluxe

Scalloped Nose Chart

Our Part #	Hand	Color	Nose Size	Stile Snap Size	Actuator
900-19496A	Set	Dark Brown	3/8"	3/32"	Standard
900-19496WA	Set	White	3/8"	3/32"	Standard

85 SERIES BALANCE ACCESSORIES

SNAP-IN TILT LATCHES

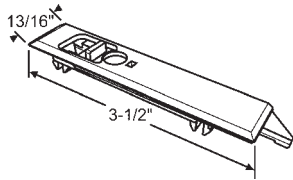

Part #	Color	
85-881WA	White	
"A"	"B"	"X"
5/16"	5/16"	5/16"

Sold in sets only (RH Shown).
CERTAINTED

SASH PLUNGER

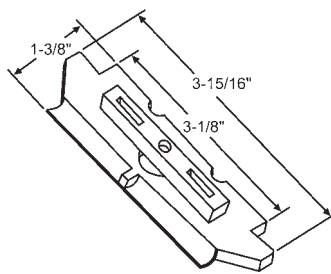

900-8600

Black with springs.
Used with pivot bar 900-8599.
TRACO

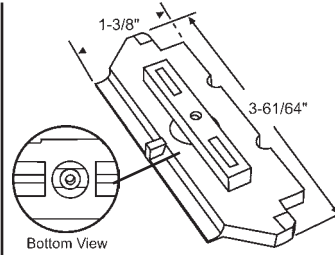

900-8600MOD

Black with springs. Modified to accept
tamper proof screw. Screw #20-468
TRACO

TILT LATCH INSERT

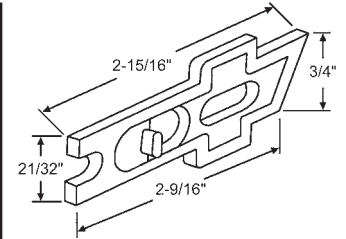

Part #	Hand	Color
85-527RHW	Opposite	White
85-527LHW	Shown	White
85-527RH	Opposite	Black
85-527LH	Shown	Black

TILT LATCH SPRING

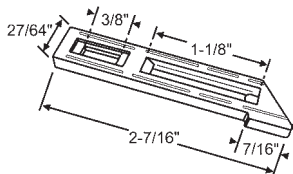

85-656W

White Nylon Universal Tilt Latch Insert
DAYTON

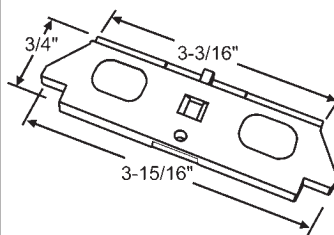

Part #	Color
85-1082W	White
85-1082B	Black

TRACO

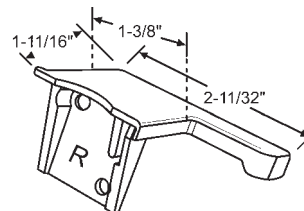

Part #	Hand
85-6008RW	Shown
85-6008LW	Opposite

Sash Guide & Cover. White
PGT

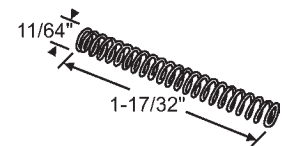

85-626S

TRACO

TOOLS

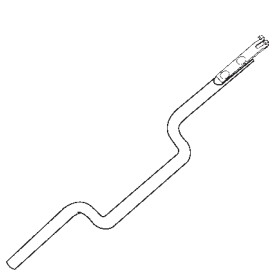

85-511

Tilt Tensioning Tool. Used with
83 and 85 Series Balances

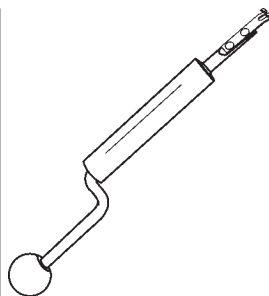

85-515

Deluxe Tilt Tensioning Tool. Used
with 83 and 85 Series Balances



59-6

Plastic Tilt Latch Tool.
Fits Tri-Wing Button Tilt Latches

TILT SLIDE BUTTONS

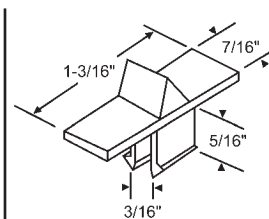

900-15551B

Black
AMACOR

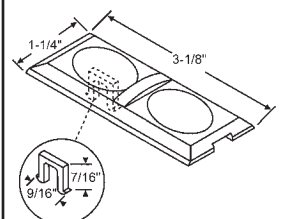

Part #	Color
85-729	White
85-729BG	Beige
85-729BR	Brown

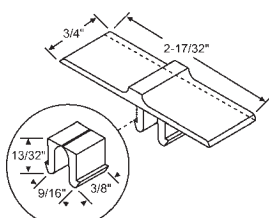

Part #	Color
900-19037	White

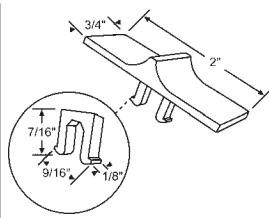

Part #	Color
900-19038BE	Beige
900-19038	White

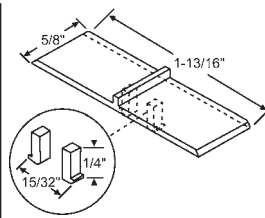

Part #	Color
900-19015	White
900-19015BR	Brown
900-19015BG	Beige

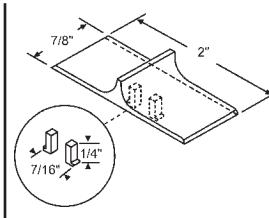

Part #	Color
900-14340BR	Brown

GREAT LAKES

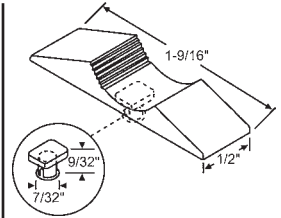

Part #	Color
900-21219W	White
900-21219BZ	Bronze
900-21219	Beige

SASH SUPPORT SYSTEMS

85 SERIES BALANCE ACCESSORIES

TILT SLIDE BUTTONS

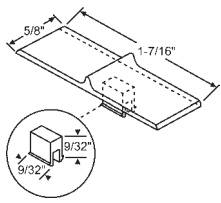

900-19744
Bronze

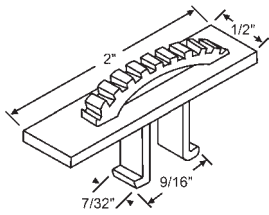

900-19448
White

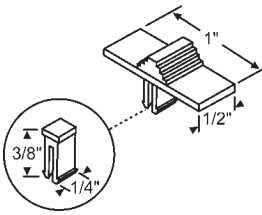

Part #	Color
85-620BR	Brown
85-620BG	Beige

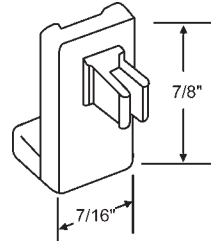

Part #	Color
85-508	White
85-508B	Black
85-508BG	Beige

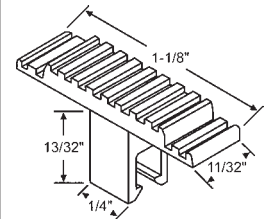

85-552BG
Beige
ACRO/SLOCOMB

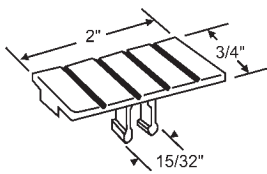

900-18706
White
VINYL BUILDING PRODUCTS

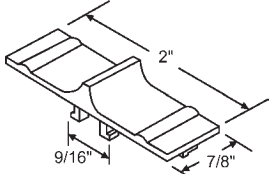

900-19179
White
HARVEY

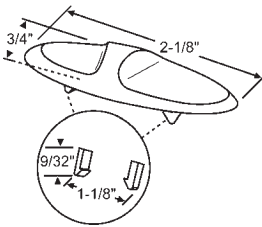

85-1033W
White

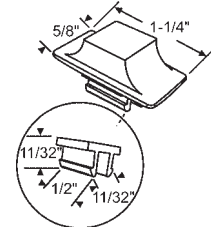

85-834
White

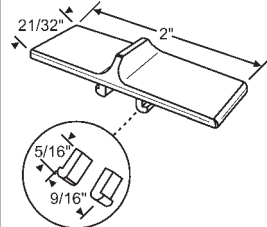

85-842
White

NYLON GUIDE

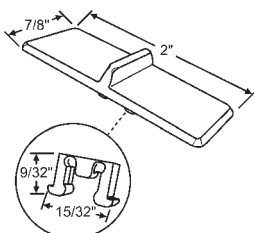

85-760
White

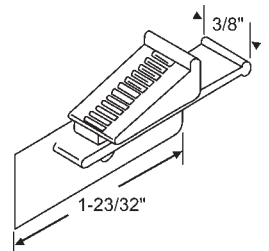

Part #	Color
85-553	White
85-553B	Black

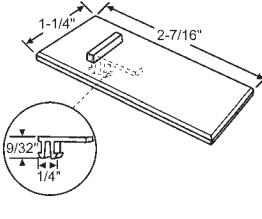

Part #	Color
85-1083W	White
85-1083B	Black

TRACO

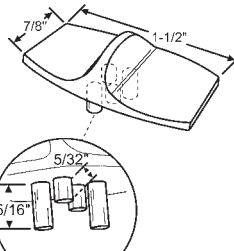

85-882W
White
For 85-881WA

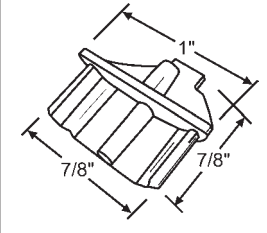

Part #	Color
85-1057B	Black
85-1057W	White

TRACO

TILT LATCH CAP

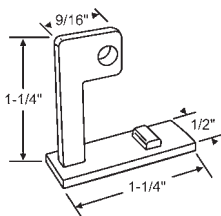

Part #	Color
900-6765	White
900-6765B	Black

TILT LATCH CAM

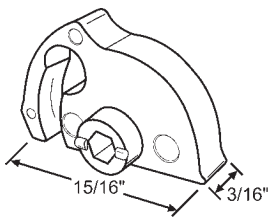

85-695W
White Tilt Latch Assy.
Used with 85-619.
DAYTON

INSERT ANGLE

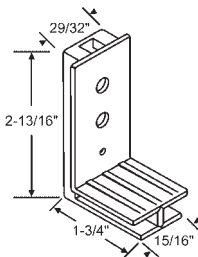

900-18899
White Plastic
ACRO/SLOCOMB

MISCELLANEOUS ACCESSORIES

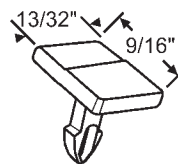

900-5759
Anti Rattle Lock Pin. White Nylon.
Used With 85-503 Pivot Lock
Shoe
ACORN

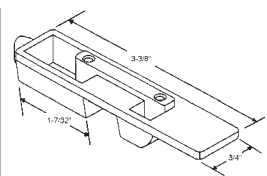

Part #	Hand	Color
900-15612LG	Shown	Grey
900-15612RG	Opposite	Grey

Friction Sash
AMACOR

88L SERIES ULTRALIFT 43/64" HEAVY DUTY TUBE BALANCE

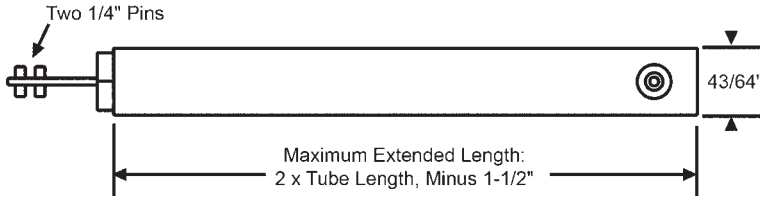

The heavy duty Ultralift is not only an excellent product for counterbalancing windows from 10lbs. to 100 lbs.; it also reduces the manual force required to open and close windows by 50%. Standard balances only provide about 40% of the sash weight while the Ultralift lifts 70% of the sash weight. This makes the Ultralift an excellent product to use in nursing homes, schools and windows that are difficult to access. These balances can be used in sashes from 10 lbs. to 100 lbs. in weight.

Here are the facts:

- Lifts 70% of sash weight vs. AAMA'S 40% minimum.
- Provides even power across full range of sash travel.
- Usable with both tilt and non-tilt windows.
- Adjustable on site by +/- 2 lbs.
- Fits most C-20 and HC-40 AAMA grade single and double hung windows.
- Fits most large architectural wood windows.
- Combines spiral and extension spring technology.
- Covered by a 5-year warranty.
- Custom made for specific sash weights.

ORDERING INFORMATION

1. Supply information stamped on balance.
2. First set of numbers represent the tube length of balance (actual tube length is 1/2" longer than number stamped on balance).
3. Second set of number represents the sash weight (balances are pre-tensioned to the exact weight of sash).
4. Specify color of the tube: Gray (standard), White, Black or Tan.

Ordering Example: Information stamped on balance is 18-24 lbs Ultralift. Order our 88L-18S24. You will receive gray tube.

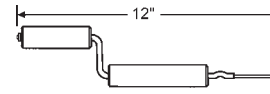

For sash weights over 100 lbs. contact your account manager.

For weight capacity chart contact your account manager.

88-575

Ultra Lift Balance Tension Tool

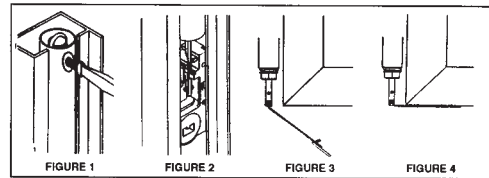

Installing Balance in Tilt Windows

1. Mount the balance to the outer frame with a screw (See Figure 1). Do not overtighten screw.
2. Raise the pivot shoe in the jamb channel and insert the balance rod into the shoe rod slot (See Figure 2).
3. Install the sash.

Installing Balance in Non-Tilt Windows

1. Mount balance to outside frame with screw (See Figure 1). Do not overtighten screw.
2. With top stops removed, raise the sash so that the sash brackets protrude below bottom rail. Pull bracket around sash corner with installation tool (See Figure 3).
3. Attach sash bracket to bottom rail using a minimum of two screws per bracket (See Figure 4).

88L SERIES BALANCE ACCESSORIES

PIVOT LOCK SHOES

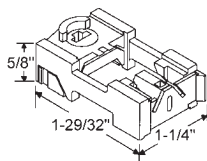

85-505

No Longer Available
Use: 85-517

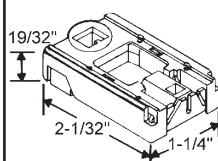

85-517

Black Cam
Cam Opening: 3/8" x 3/16"

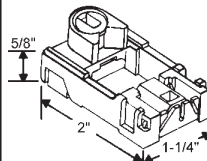

85-518

Red Cam
Cam Opening: 3/8" x 3/16"
TRACO

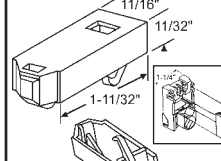

85-606

Tamp-R-Lock. Snaps on to eliminate take out function.
Black

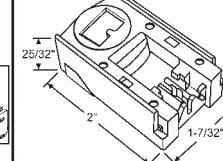

85-5045

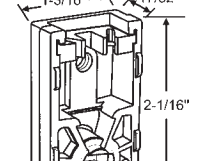

62-873

Pivot Lock Shoe. 1-1/4in X 5/8in DP Cam

SASH STOP

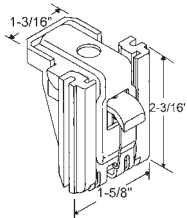

88-503

Carrier

ANGLE STOP

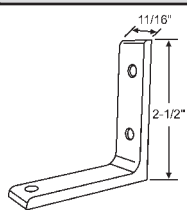

88-700

Anodized Aluminum Angle Stop - Black

PIVOT BARS

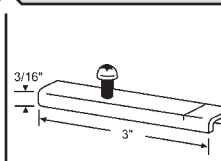

85-501

Metal
NORANDEX

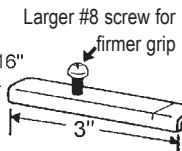

88-505

Special heat treated for added strength

BRACKETS

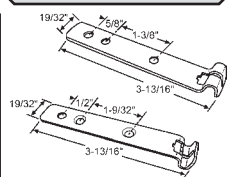

Part #	Description
88-500	Standard Holes for Non-Tilt
88-501	Countersunk Holes

PIVOT LOCK SHOE ADAPTER

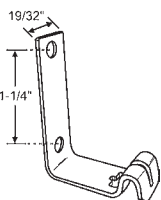

88-543

Stainless Steel.
Countersunk Holes

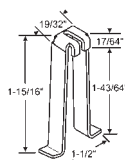

For use with 88L heavy duty balances. Not sold separately. Must be purchased with Ultra Lift Balances.

88-508

Stainless Steel

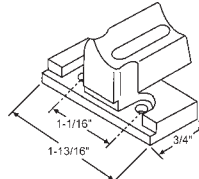

Part #	Hand
900-20214LH	Shown
900-20214RH	Opposite

Cast Aluminum

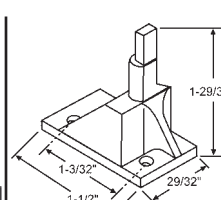

900-13070A

Sold in sets only.

TAMPER LOCKS

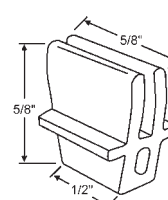

88-519

For UltraLift
TRACO

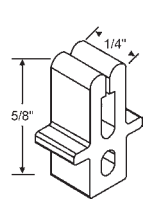

88-540

For Ultra Lift
TRACO

SASH SUPPORT SYSTEMS

88L SERIES BALANCE ACCESSORIES

TAMPER LOCKS

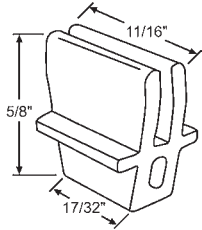

88-542

For Ultra Lift
Blue

GUIDE

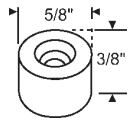

62-658

Heavy Duty Die Cast
Face Guide

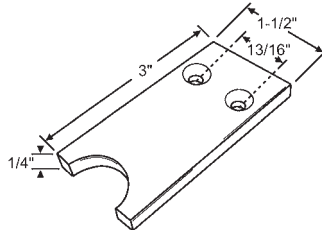

88-604

Black w/Countersunk Holes

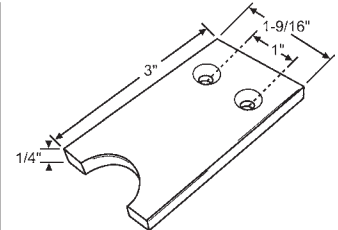

88-605

Black w/Countersunk Holes

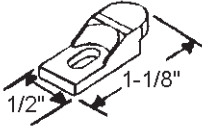

900-12977
SWS

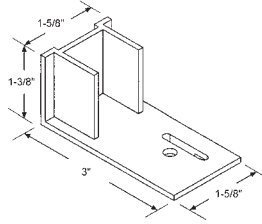

Part #	Hand
88-602RH	Shown
88-602LH	Opposite

Riverview 400S. Black

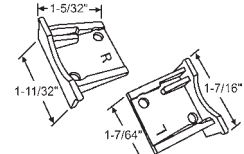

88-612W
White
PGT

88LL & 88SL SERIES - 21/32" & 3/4" TUBE BALANCES

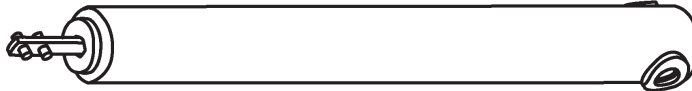

Ordering Information

- Determine series 88LL (21/32" (.656) OD) or 88SL (3/4" (.750) OD) based on sash weight range required.
- Select pin option (1,2,3,4,5 or 6*) from diagram shown.
- Determine tube length.
- Determine color (gray, black, white & beige).

Example: Sash weighing 92 lbs. and balance is 38" long with 2 pins 1/2" long and gray cover the part number is: 88SL90-438G

General Information

- Travel characteristics for these balances is 2x tube length minus 2".
- Choose the required pivot lock shoes or brackets from the balance accessory page.
- Proper tension is acquired by winding in a COUNTERCLOCKWISE direction.

Note: All accessories must be ordered separately.

Made without any pretension and will need to be wound up.

See links below for turn chart and field adjustment

88LL Series Balance 21/32" Diameter Plastic Tube Balance

Series	Tube Lengths	Weight Ranges	Bearing Color	Part Number
88LL	6" to 72"	20 to 29.5 lbs.	Red	88LL20-Pin Option + Tube Length + Tube Color
88LL	6" to 72"	30 to 39.5 lbs.	Blue	88LL30-Pin Option + Tube Length + Tube Color
88LL	6" to 72"	40 to 49.5 lbs.	Black	88LL40-Pin Option + Tube Length + Tube Color
88LL	6" to 72"	50 to 59.5 lbs.	White	88LL50-Pin Option + Tube Length + Tube Color
88LL	6" to 72"	60 to 69.5 lbs.	Yellow	88LL60-Pin Option + Tube Length + Tube Color
88LL	6" to 72"	70 to 79.5 lbs.	Yellow	88LL70-Pin Option + Tube Length + Tube Color
88LL	6" to 72"	80 to 89.5 lbs.	Yellow	88LL80-Pin Option + Tube Length + Tube Color
88LL	15" to 75"	90 to 99.5 lbs.	Yellow	88LL90-Pin Option + Tube Length + Tube Color

88SL Series Balance 3/4" Diameter Plastic Tube Balance

Series	Tube Lengths	Weight Ranges	Part Number
88SL	20" to 74"	60 to 69.5 lbs.	88SL60-Pin Option + Tube Length + Tube Color
88SL	20" to 74"	70 to 79.5 lbs.	88SL70-Pin Option + Tube Length + Tube Color
88SL	20" to 74"	80 to 89.5 lbs.	88SL80-Pin Option + Tube Length + Tube Color
88SL	20" to 74"	90 to 99.5 lbs.	88SL90-Pin Option + Tube Length + Tube Color
88SL	20" to 74"	100 to 109.5 lbs.	88SL100-Pin Option + Tube Length + Tube Color
88SL	20" to 74"	110 to 119.5 lbs.	88SL110-Pin Option + Tube Length + Tube Color
88SL	20" to 74"	120 to 129.5 lbs.	88SL120-Pin Option + Tube Length + Tube Color

Balance Tilt Pin Options

Note: 1, 2 and 3 can also be used on non-tilt systems.

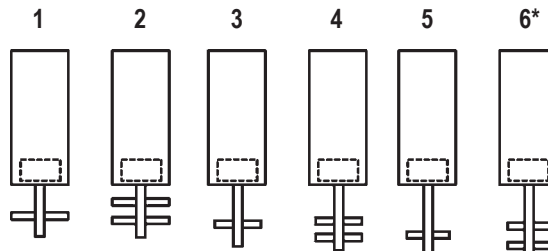

One 3/4" Pin Two 3/4" Pins One 1/2" Pin Two 1/2" Pins One 1/4" Pin Two 1/4" Pins

89 SERIES WINDOW BALANCES

CARADCO C-100 Balances Exclusively for Wood Windows

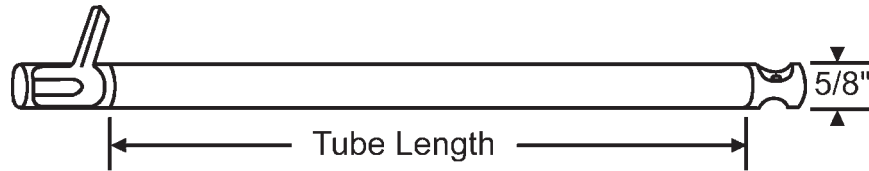

ORDERING INFORMATION

1. Measure the length of the plastic tube; do not include any of the plastic bracket end pieces.
2. Determine color of dye on the spring end.
3. Select corresponding part number from the chart below and order accordingly.

GENERAL INFORMATION

1. The tube lengths are available in only those sizes shown in chart below.
2. Tube color is always white.

Tube Length	Spring Color	Caradco Balance Code	Caradco Part #	Our Part #
13-1/2"	BROWN	A1	944814	89-30B
13-1/2"	GREEN	C2	944881	89-9T
13-1/2"	RED	D1	944906	89-14T
13-1/2"	YELLOW	B1	944847	89-1T
15-1/2"	BROWN	A2	944815	89-29B
15-1/2"	GREEN	C3	944882	89-10T
15-1/2"	RED	D2	944907	89-15T
15-1/2"	YELLOW	B3	944848	89-2T
17-1/2"	GREEN	C5	944821	89-3T
17-1/2"	GREEN	C6	944822	89-31B
17-1/2"	YELLOW	B4	944820	89-28B
19-1/2"	GREEN	C7	944850	89-4T
19-1/2"	GREEN	C8	944884	89-8T
19-1/2"	NONE	E5	944908	89-22T
19-1/2"	RED	D5	944878	89-17T
19-1/2"	YELLOW	B5	944817	89-27B
21-1/2"	GREEN	C10	944885	89-11T
21-1/2"	GREEN	C9	944851	89-5T
21-1/2"	NONE	E7	944880	89-35B
21-1/2"	RED	D6	944823	89-18T
21-1/2"	YELLOW	B6	944818	89-26B
23-1/2"	GREEN	C11	944852	89-6T
23-1/2"	NONE	E14	944829	89-21T
23-1/2"	NONE	E8	944825	89-20T
23-1/2"	RED	D8	944903	89-16T
23-1/2"	YELLOW	B7	944819	89-25B
27-1/2"	GREEN	C12	944877	89-23B
27-1/2"	NONE	E9	944883	89-13T
27-1/2"	RED	D9	944879	89-7T
30-1/2"	NONE	E13	944826	89-36B
30-1/2"	RED	D11	944824	89-32B
33-1/2"	RED	D12	922546	89-33B
35-1/2"	GREEN	C14	944900	89-24B
35-1/2"	RED	D14	944828	89-34B

To determine balance number you need, find part numbers by glass size and then select top or bottom sash. Contact your account manager if not shown.

Glass Width

	Position	16"	20"	24"	28"	32"	36"	40"
14"	Top	----	89-1T	89-9T	89-9T	89-14T	89-14T	----
	Bottom	----	89-30B	89-1T	89-1T	89-9T	89-9T	----
16"	Top	89-29B	89-2T	89-10T	89-10T	89-15T	89-15T	89-15T
	Bottom		89-29B	89-2T	89-2T	89-10T	89-10T	89-10T
18"	Top	89-28B	89-3T	89-3T	89-3T	89-38	89-38	----
	Bottom		89-28B	89-28B	89-3T	89-3T	89-3T	----
20"	Top	89-27B	89-4T	89-4T	89-4T	89-17T	89-17T	89-22T
	Bottom		89-27B	89-4T	89-4T	89-4T	89-4T	89-4T
22"	Top	89-26B	89-5T	89-5T	89-5T	89-18T	89-35B	89-19T
	Bottom		89-26B	89-5T	89-5T	89-5T	89-5T	89-18T
24"	Top	89-25B	89-6T	89-16T	89-16T	89-20T	89-20T	89-20T
	Bottom		89-25B	89-6T	89-6T	89-6T	89-16T	89-16T
28"	Top	89-23B	89-7T	89-7T	89-13T	89-13T	89-13T	89-13T
	Bottom		89-23B	89-23B	89-7T	89-7T	89-7T	89-7T
* 22/34"	Top	----	----	----	89-5T	89-18T	E7-89-18T	----
	Bottom	----	----	----	89-7T	89-32B	89-33B	----
* 24/36"	Top	----	89-6T	89-16T	89-16T	89-20T	89-20T	89-20T
	Bottom		89-24B	89-24B	89-34B	89-34B	89-34B	89-36B
** 44/16"	-	----	----	----	----	89-10T	89-10T	----
34"	Top	----	----	----	89-20T	89-20T	89-20T	----
	Bottom	----	----	----	89-33B	89-33B	89-33B	----
36"	Top	----	89-8T	----	----	89-21T	89-21T	----
	Bottom	----	89-24B	----	----	89-33B	89-34B	----

Glass Height

*for oriel window

**for reverse oriel or cottage window

Note: Spring strength from lightest to strongest is brown, yellow, green, red, none.

Note: Purple and black springs can be special ordered. Please contact your account manager.

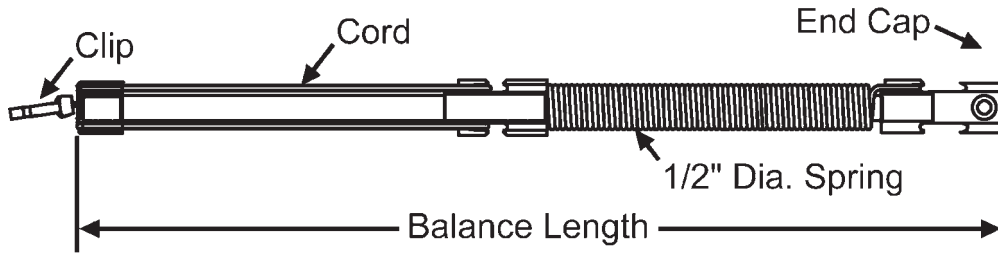

Ordering Information

- 1) Measure balance length, including end cap.
- 2) Determine color of end cap, black or white.
- 3) Based on length of balance and color of cap, locate our part number from chart below
- 4) Determine clip attached to spring and add suffix -5, -11 or -18.

Example Ordering Chart

Length of Balance Length	End Cap Color	Strybuc Part Number	Clip Attached	Complete Part Number
10"	Black	901-1000	900-18354	901-1000-5

Black End Cap (Windows less than or equal to 36")		
Balance Length	Weight Range	Strybuc Part Number
10"	3-10	901-1000
12"	3-11	901-1200
14"	4-12	901-1400
16"	4-13	901-1600
18"	5-14	901-1800
20"	5-16	901-2000
22"	6-17	901-2200
24"	6-18	901-2400
26"	7-19	901-2600
28"	7-21	901-2800
30"	8-22	901-3000
32"	8-23	901-3200
34"	9-24	901-3400
36"	9-25	901-3600
38"	10-27	901-3800
40"	10-28	901-4000

White End Cap (Windows greater than 36" wide)		
Balance Length	Weight Range	Strybuc Part Number
10"	10-11	901-1001
12"	11-13	901-1201
14"	12-15	901-1401
16"	13-16	901-1601
18"	14-18	901-1801
20"	16-19	901-2001
22"	17-21	901-2201
24"	18-23	901-2401
26"	19-24	901-2601
28"	21-26	901-2801
30"	22-28	901-3001
32"	23-29	901-3201
34"	24-31	901-3401
36"	25-32	901-3601
38"	27-33	901-3801

CLIPS

Add suffix to complete part number.

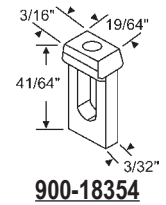

-5

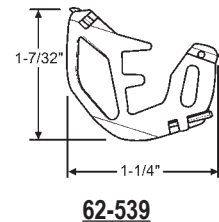

-11

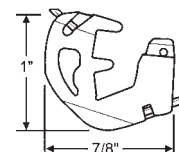

-18

960SP SERIES CROSSBOW BALANCE

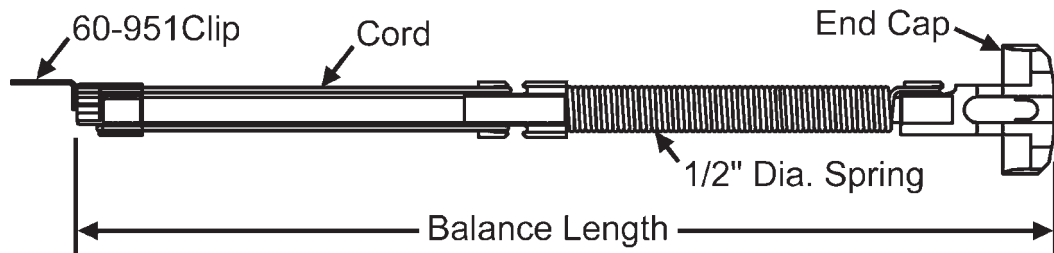

Ordering Information

- 1) Measure balance length, including end cap.
- 2) Determine color of end cap, black or white.
- 3) Based on length of balance and color of cap, locate our part number from chart below
- 4) Determine width of end cap and add suffix of -19 or 19A (see ordering example).

PIVOT BAR

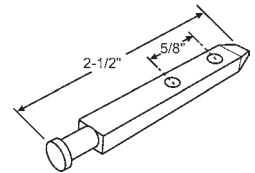

62-541
Zinc

Example Ordering Chart

Length of Balance Length	End Cap Color	Strybuc Part Number	Balance End Cap Width	Complete Part Number
10-1/2"	Black	960SP-1000	1-1/4"	960SP-1000-19A

Black End Cap (Windows less than or equal to 36")		
Balance Length	Weight Range	Strybuc Part Number
10-1/2"	3-10	960SP-1000
12-1/2"	3-11	960SP-1200
14-1/2"	4-12	960SP-1400
16-1/2"	4-13	960SP-1600
18-1/2"	5-14	960SP-1800
20-1/2"	5-16	960SP-2000
22-1/2"	6-17	960SP-2200
24-1/2"	6-18	960SP-2400
26-1/2"	7-19	960SP-2600
28-1/2"	7-21	960SP-2800
30-1/2"	8-22	960SP-3000
32-1/2"	8-23	960SP-3200
34-1/2"	9-24	960SP-3400
36-1/2"	9-25	960SP-3600
38-1/2"	10-27	960SP-3800
40-1/2"	10-28	960SP-4000

White End Cap (Windows greater than 36" wide)		
Balance Length	Weight Range	Strybuc Part Number
10-1/2"	10-11	960SP-1001
12-1/2"	11-13	960SP-1201
14-1/2"	12-15	960SP-1401
16-1/2"	13-16	960SP-1601
18-1/2"	14-18	960SP-1801
20-1/2"	16-19	960SP-2001
22-1/2"	17-21	960SP-2201
24-1/2"	18-23	960SP-2401
26-1/2"	19-24	960SP-2601
28-1/2"	21-26	960SP-2801
30-1/2"	22-28	960SP-3001
32-1/2"	23-29	960SP-3201
34-1/2"	24-31	960SP-3401
36-1/2"	25-32	960SP-3601
38-1/2"	27-33	960SP-3801
40-1/2"	28-34	960SP-4001

END CAPS

Add suffix to complete part number.
End caps not sold separately.

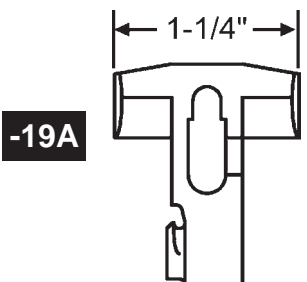
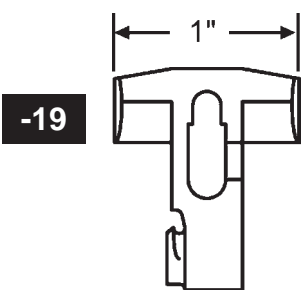

Note: If you have a plastic clip it is no longer available and is replaced by 60-951 Metal Clip.

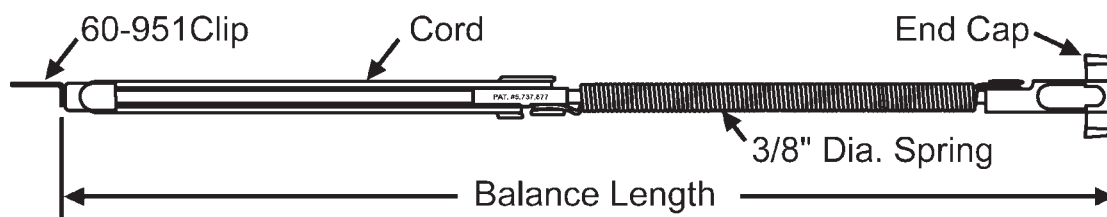

PIVOT BAR

Ordering Information

- 1) Measure balance length, including end cap.
- 2) Determine color of end cap, black, white or red.
- 3) Based on length of balance and color of cap, locate our part number from chart below
- 4) Determine width of end cap and add suffix of -19 or 19A (see ordering example).

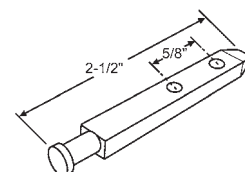

62-541
Zinc

Example Ordering Chart

Length of Balance Length	End Cap Color	Strybuc Part Number	Balance End Cap Width	Complete Part Number
16-1/2"	Black	909A-1600	15/16"	909A-1600-19

Black End Cap		
Balance Length	Weight Range	Part Number
10-1/2"	2 - 6	909A-1000
12-1/2"	3 - 7	909A-1200
14-1/2"	3 - 8	909A-1400
16-1/2"	4 - 8	909A-1600
18-1/2"	4 - 9	909A-1800
20-1/2"	4 - 10	909A-2000
22-1/2"	5 - 11	909A-2200
24-1/2"	5 - 12	909A-2400
26-1/2"	6 - 13	909A-2600
28-1/2"	6 - 13	909A-2800
30-1/2"	6 - 14	909A-3000
32-1/2"	7 - 15	909A-3200
34-1/2"	7 - 16	909A-3400
36-1/2"	8 - 17	909A-3600
38-1/2"	8 - 18	909A-3800
40-1/2"	8 - 18	909A-4000

White End Cap		
Balance Length	Weight Range	Part Number
10-1/2"	6 - 8	909A-1001
12-1/2"	7 - 9	909A-1201
14-1/2"	8 - 10	909A-1401
16-1/2"	8 - 11	909A-1601
18-1/2"	9 - 12	909A-1801
20-1/2"	10 - 13	909A-2001
22-1/2"	11 - 14	909A-2201
24-1/2"	12 - 15	909A-2401
26-1/2"	13 - 17	909A-2601
28-1/2"	13 - 18	909A-2801
30-1/2"	14 - 19	909A-3001
32-1/2"	15 - 20	909A-3201
34-1/2"	16 - 21	909A-3401
36-1/2"	17 - 22	909A-3601
38-1/2"	18 - 23	909A-3801
40-1/2"	18 - 24	909A-4001

Red End Cap		
Balance Length	Weight Range	Part Number
10-1/2"	8 - 9	909A-1002
12-1/2"	9 - 10	909A-1202
14-1/2"	10 - 11	909A-1402
16-1/2"	11 - 13	909A-1602
18-1/2"	12 - 14	909A-1802
20-1/2"	13 - 15	909A-2002
22-1/2"	14 - 17	909A-2202
24-1/2"	15 - 18	909A-2402
26-1/2"	17 - 19	909A-2602
28-1/2"	18 - 20	909A-2802
30-1/2"	19 - 22	909A-3002
32-1/2"	20 - 23	909A-3202
34-1/2"	21 - 24	909A-3402
36-1/2"	22 - 26	909A-3602
38-1/2"	23 - 27	909A-3802
40-1/2"	24 - 28	909A-4002

END CAPS

Add suffix to complete part number.
End caps not sold separately.

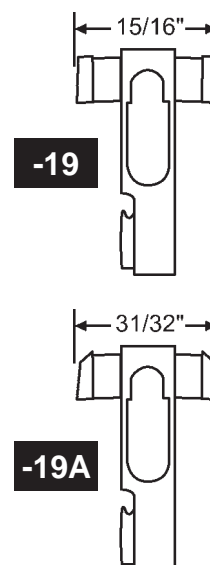

WINDOW BALANCE RIVET/TENSION TOOLS

For Channel and Tube Balances. "A Must for Repair and Assembly of Balance Brackets"
 (Tube & Channel) Professional Results! Say Good-bye to Hammered Fingers!
FAST - EFFICIENT - COST EFFECTIVE

RIVET CRIMPING PLIERS

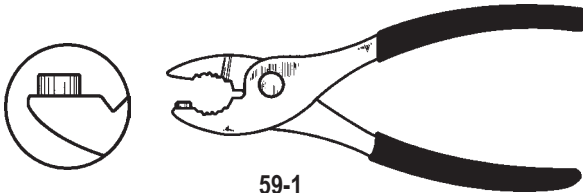

59-1

Adjusts to accommodate both tube and channel balances.

For tube balances, simply line up pin with peened rivet and squeeze. Rivet will be pushed out.
 For channel balances, grind or file rivet flush and then squeeze to remove rivet.

RIVET REMOVAL PLIERS

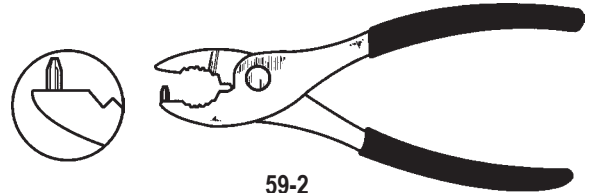

59-2



59-3

Replacement pin for rivet removal pliers

BALANCE EXTENDER TOOL

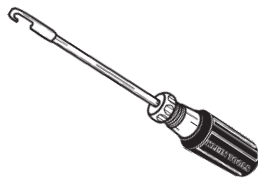

59-42

BALANCE TENSIONING TOOLS

(Used with 70, 72, 74, 75, 76 and 80 Series Balances)

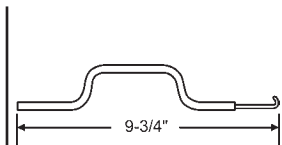

70-515



70-516

(Used with 83 and 85 Series Balances)

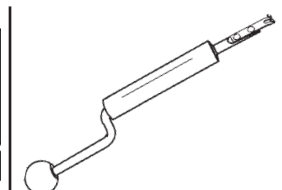

85-515

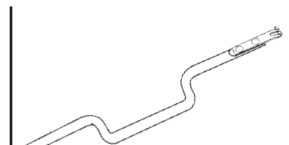

85-511

JAMB STRETCHER

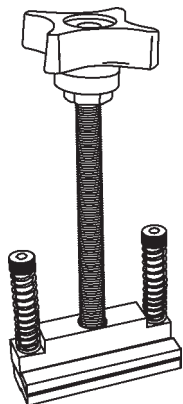

JAMB STRETCHER

59-52 (2 Piece Set)

The Jamb Stretcher enables you to spread a vinyl jamb pocket in order to replace balances, shoes or other components without the need to cut into the jamb or melt the vinyl with a hot air gun.

Replace components in a fraction of the time compared to other methods.

This is an excellent tool for factory use or field repair! Designed for use in Vinyl Jamb only!

3 Easy Steps:



1. Position one spreader below and one spreader above the item to be removed.

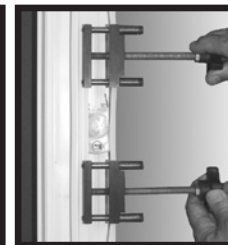

2. Turn knobs clockwise by hand or with a hex bit drill gun to spread jamb.

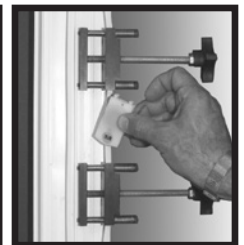

3. Remove/replace components.

BALANCE INSTALLATION TOOL

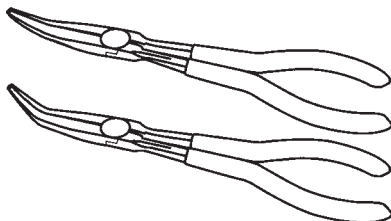

59-7 (2 Piece Set)

Long Reach Needle Pliers Set
 2 piece 11" 20° offset & 45° angle

- Reach areas too tight for standard pliers
- Made from drop-forged, heat-treated steel

ALUM-A-LUB LUBRICATING CLEANER

59-5

Alum-A-Lub Cleaner is the "All Purpose" lubricating cleaner that can be used on all products that stick or squeak. Alum-A-Lub assures ease of operation and a "Like New" appearance for metal windows, doors, locks, hinges, cabinets and more. Simply spray and wipe away dirt, grime and gummy residue left by other lubricants. A must for your shop, workroom, home, maintenance department or garage.
Sold individually and in cases of 12.



Net Weight 9.4oz.

L.C. WAX ALUMASLICK ALUMINUM LUBRICANT

59-50

"L.C. Wax" Alumaslick Aluminum Lubricant & Liquid Masking cleans and lubricates aluminum better than anything. Quick penetration/release and long lasting lubrication. Cleans corrosion and tarnish; protects from salt corrosion; reduces wear; stops squeaks, bumps, klunks, clinks.
Sold individually and in cases of 12.



Net Weight 11oz.

TAPE BALANCES

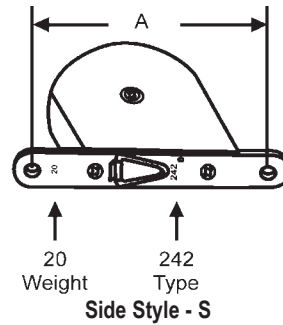
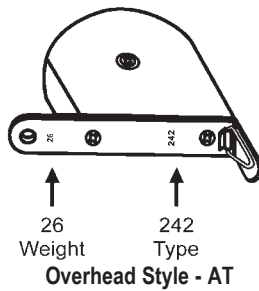
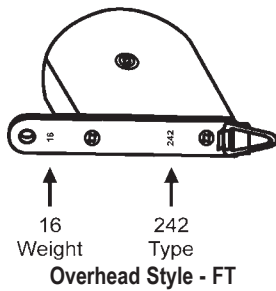

Size	A
242S	5"
150S	5-1/4"
154S	6-1/16"

Ordering Information

1. Identify Style: FT - AT - S
2. Identify Type: 242 - 150 - 154 (Type number will be stamped on face plate.)
3. Determine weight. (Number is stamped on face plate.)
4. Select our corresponding part number from chart below.

General Information

1. Type 242 for maximum sash weight 26 lbs., tape length 39".
Type 150 for maximum sash weight 35 lbs., tape length 50".
Type 154 for maximum sash weight 50 lbs., tape length 50".
2. Balance size is governed by the weight of sash and length of tape required. All balance weights are per pair of balances.
3. Tapes for special weight and lengths are available. Consult your sales representative.
4. All tape balances are custom made and, therefore, they are non-returnable.

Overhead Style - FT

LBS.	TYPE 242 Part #	TYPE 150* Part #	TYPE 154 Part #
4	96-1	-	-
6	96-2	96-37	-
8	96-3	96-38	-
10	96-4	96-39	-
12	96-5	96-40	-
14	96-6	96-41	-
16	96-7	96-42	-
18	96-8	96-43	-
20	96-9	96-44	96-73
22	96-10	96-45	96-74
24	96-11	96-156	96-75
26	96-12	96-46	96-76
28	-	96-47	96-77
30	-	-	96-78
32	-	96-48	96-79
34	-	-	96-80
36	-	96-154	96-81
38	-	96-155	96-82
40	-	-	96-83

Overhead Style - AT

LBS.	TYPE 242 Part #	TYPE 150* Part #	TYPE 154 Part #
4	96-13	-	-
6	96-14	96-49	-
8	96-15	96-50	-
10	96-16	96-51	-
12	96-17	96-52	-
14	96-18	96-53	-
16	96-19	96-54	-
18	96-20	96-55	-
20	96-21	96-56	96-84
22	96-22	96-57	96-85
24	96-23	-	96-86
26	96-24	96-58	96-87
28	-	96-59	96-88
30	-	-	96-89
32	-	96-60	96-90
34	-	-	96-91
36	-	-	96-92
38	-	-	96-93
40	-	-	96-94

Side Style - S

LBS.	TYPE 242 Part #	TYPE 150* Part #	TYPE 154 Part #
4	96-25	-	-
6	96-26	96-61	-
8	96-27	96-62	-
10	96-28	96-63	-
12	96-29	96-64	-
14	96-30	96-65	-
16	96-31	96-66	-
18	96-32	96-67	-
20	96-33	96-68	96-95
22	96-34	96-69	96-96
24	96-35	-	96-97
26	96-36	96-70	96-98
28	-	96-71	96-99
30	-	-	96-100
32	-	96-72	96-101
34	-	-	96-102
36	-	-	96-103
38	-	-	96-104
40	-	-	96-105

* Note: Type 150 adjustable to 3 lbs. plus or minus weight specified

TAPE BALANCE TECHNICAL INFORMATION

Size	A	B	C	D	E	G
242AT	3"	4-5/16"	7/8"	1-5/16"	5/16"	3"
150AT	3-3/8"	4-11/16"	1-1/8"	1-5/16"	3/8"	3-3/8"
154AT	3-5/16"	5-5/32"	1-1/4"	1-17/32"	15/32"	3-15/16"
242S	3"	5-5/8"	7/8"	1-5/16"	5/16"	3"
150S	3-3/8"	6"	1-1/8"	1-5/16"	3/8"	3-3/8"
154S	3-15/16"	7"	1-1/4"	1-13/32"	15/32"	3-15/16"
242FT	3"	4-11/16"	7/8"	1-5/16"	3/8"	3"
150FT	3-3/8"	5-1/8"	1"	1-5/16"	3/8"	3-3/8"
154FT	3-15/16"	5-13/16"	1-1/4"	1-17/32"	11/32"	3-15/16"

WGT. of Sash	4-26 lbs.	4-35 lbs.	20-50 lbs.
Balance Size	242	150	154
*Standard Tape Length	39"	50"	50"

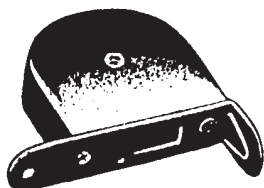

STYLE - AT

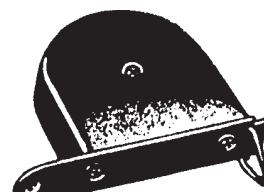

STYLE - FT

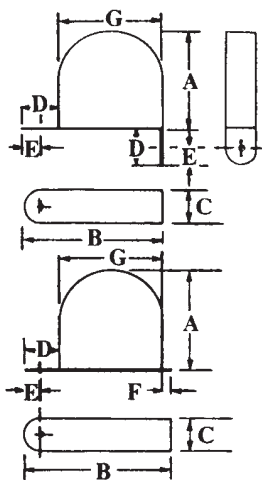

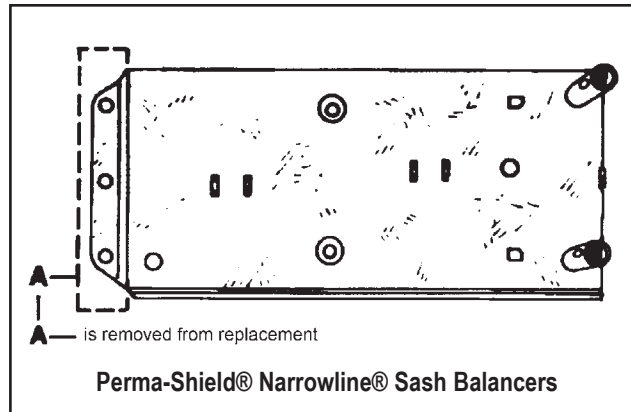

CAN BE USED TO REPLACE BALANCERS #	OUR PART NUMBER	USED TO REPLACE SERVICE BALANCERS #	OUR PART NUMBER
331, 319, 325	750-1626012	NOTE: Use the following service balancers on 56" high units or where limited travel is necessary.	
431, 419, 425, 431	750-1626018		
531, 519, 523, 527	750-1626024		
637, 623, 627, 631	750-1626029	R12/827	750-1626088
737, 725, 727, 731	750-1626034	L9/1327	750-1626090
837, 823, 827, 831	750-1626037	L10/1427	750-1626094
939, 927, 931, 937	750-1626043	R13/927	750-1626092
1031, 1027	750-1626044	L10/1827	750-1626055
1133, 1131	750-1626045	R14/1027	750-1626096
11L, 10SL	750-1626074	L12/1827	750-1626070
11R, 10SR	750-1626076	L1719/37	750-1626059
1231, 1226, 1227	750-1626048	R1737/19	750-1626061
1331	750-1626050	R18/1027	750-1626057
13L, 12SL	750-1626078	R18/1227	750-1626072
13R, 12SR	750-1626080		
1427, 1426	750-1626052		
1527	750-1626053		
16L, 14SL	750-1626082		
16R, 14SR	750-1626084		
L1427/31	750-1626066		
R1431/27	750-1626068		
L8/1227	750-1626086		

SASH SUPPORT SYSTEMS

96AA SERIES PIVOT TRUE COIL BALANCE SYSTEM

3/8" Coil

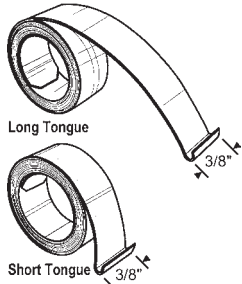

Part Number	Weight	Spring Code	Tongue
96AA-69	5 lbs.	G	Short
96AA-70	5 lbs.	GL	Long
96AA-71	5.5 lbs.	H	Short
96AA-72	5.5 lbs.	HL	Long
96AA-73	8 lbs.	R	Short
96AA-74	8 lbs.	RL	Long

For achieving additional egress, the 3/8 coil spring are used in conjunction with our 1/2" balance shoe to increase the travel of the balance.

1/2" Coil

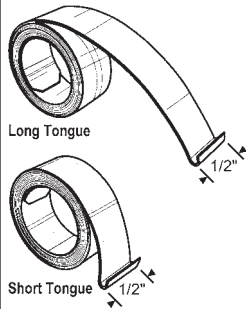

Part Number	Weight	Spring Code	Tongue
96AA-12	3 lbs.	A	Short
96AA-13	4 lbs.	B	Short
96AA-67	4 lbs.	BL	Long
96AA-6	5 lbs.	C	Short
96AA-14	5 lbs.	CL	Long
96AA-15	6 lbs.	D	Short
96AA-16	6 lbs.	DL	Long
96AA-17	7 lbs.	E	Short
96AA-18	7 lbs.	EL	Long
96AA-19	8 lbs.	F	Short
96AA-20	8 lbs.	FL	Long
96AA-21	9 lbs.	J	Short
96AA-22	9 lbs.	JL	Long
96AA-53	10 lbs.	K	Short
96AA-68	10 lbs.	KL	Long

Extra tail lengths available.
Contact account manager for details.

Pivot Lock Shoe

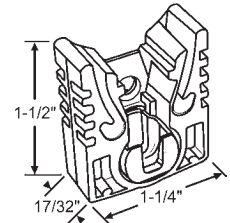

Part Number	Brake Pad Extension from Shoe Housing	Brake Pad Color
96AA-66-1	.035	Black
96AA-66-2	.045	White
96AA-66-3	.055	Dusk
96AA-66-4	.065	Brown
96AA-66-5	.075	Cadet Blue
96AA-66-6	.085	Green
96AA-66-7	.095	Tan
96AA-66-8	.105	Cream
96AA-66-9	.115	Desert Sand

96AA SERIES BALANCE ACCESSORIES

Spring Holder

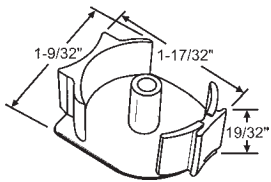

96AA-23

Interlocking Stackable Spring Holder

Retainer

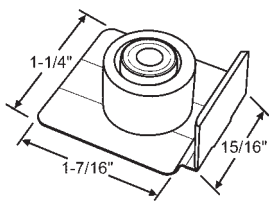

96AA-1

Constant Force Retainer

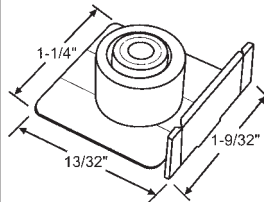

96AA-2

Constant Force Retainer

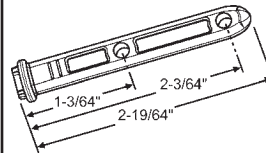

85-1034

Zinc Die Cast

Pivot Bars

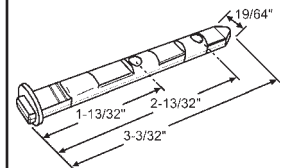

85-5054

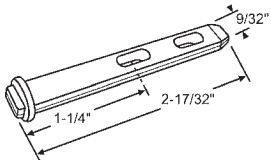

900-21878

Zinc Die Cast

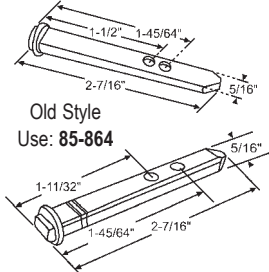

85-864

Die Cast

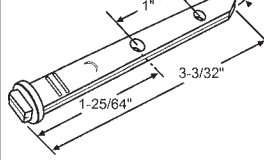

900-21355

Zinc Die Cast

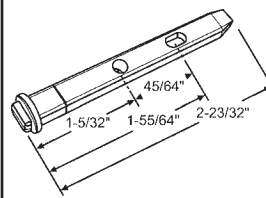

85-1063

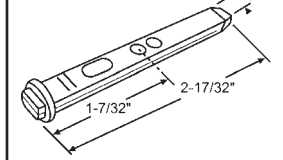

85-998

Zinc Die Cast

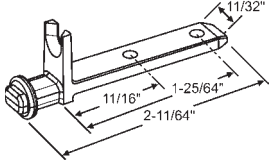

85-1053

Zinc Die Cast

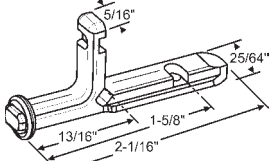

85-1062A

Zinc Die Cast
(Packed & Sold in Pairs)

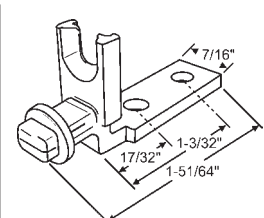

85-1055

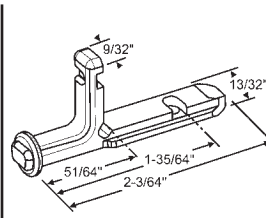

85-889A

Zinc Die Cast
(Packed & Sold in Pairs)

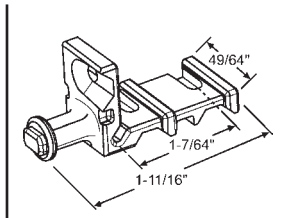

Part #	Hand
85-1065RH	Shown
85-1065LH	Opposite

OMEGA CONSTANT FORCE BALANCE SYSTEM

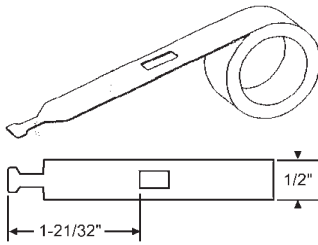

STANDARD SPRING

1. Determine correct sash weight (weights shown are per each side of sash)
2. Top sash should be overbalanced by selecting next highest balance.

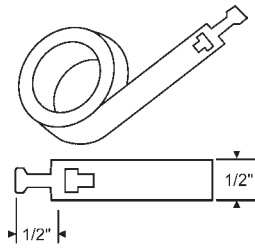

EGRESS SPRING

Spring Type	Sash/Spring Weight (per each side)	Coil Spring Length	Part Number
STANDARD	3.5LBS.	33"	900-21234
STANDARD	3.5LBS.	35"	96BU-1
STANDARD	4.5LBS.	33"	96BU-2
STANDARD	7.5LBS.	33"	900-21959
EGRESS	3.5LBS.	33"	900-21958
EGRESS	5.5LBS.	33"	96BU-3

BRAKE SHOE

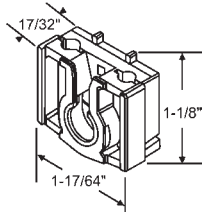

900-19198

No Longer Available. Use: 900-19198NS

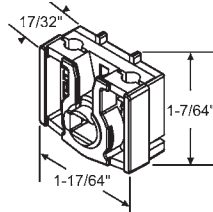

900-19198NS

Spring Side. Super Tough Nylon

PIVOT BAR

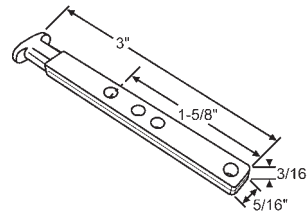

900-22526

PIVOT BAR RETAINER

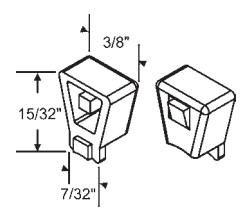

900-22527

96BT SERIES CONSTANT FORCE BALANCES

TITAN

1" Pocket Size

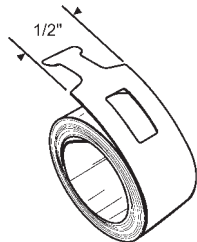

Spring

Our Part #	Weight
96BT-1	3.5 lbs.
96BT-2	4.5 lbs.

BALANCE SUPPORTS

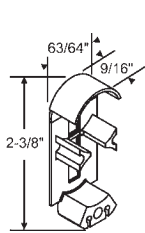

96BT-5

Dual Support

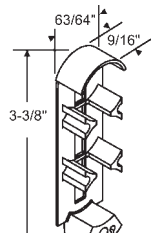

96BT-6

Triple Support

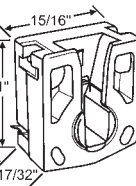

96BT-3

Supa

PIVOT RETAINER

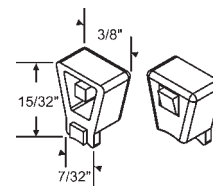

900-22527

PIVOT BAR

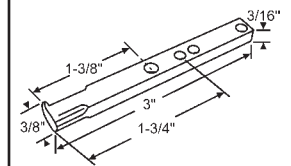

62-545

Transit

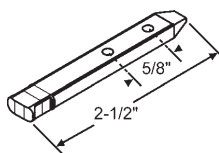

62-550

T-Head

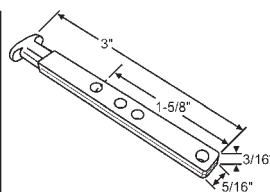

900-22526

4- Hole

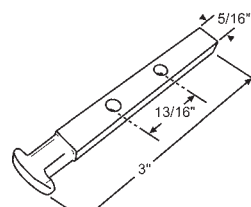

62-551

Use: 62-553

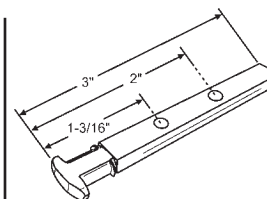

62-553

BUMPER

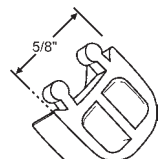

96BT-4



3/8" Gecko System

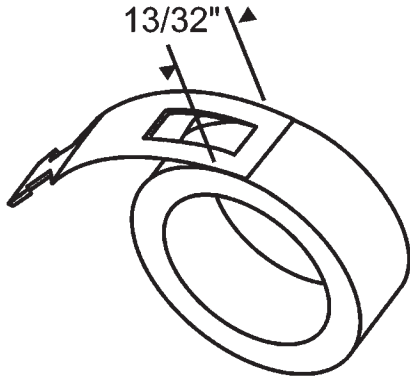

Egress Coil

Our Part #	Weight
96BG-1	3 lbs.
96BG-2	4 lbs.
96BG-3	5 lbs.
96BG-7	6 lbs.

Max Travel of Coils 35"

96BG SERIES BALANCE SUPPORTS

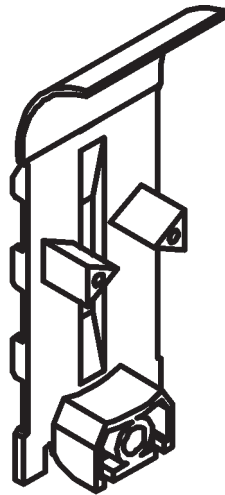
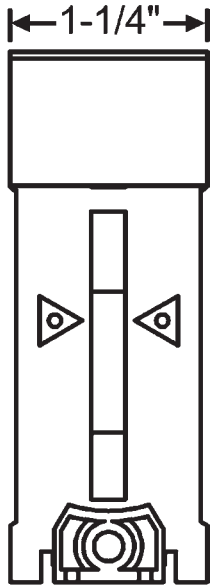
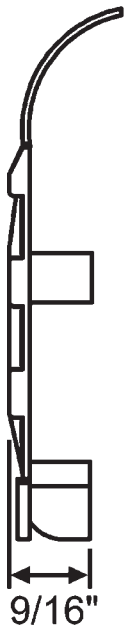

96BG-4
Egress Dual Support

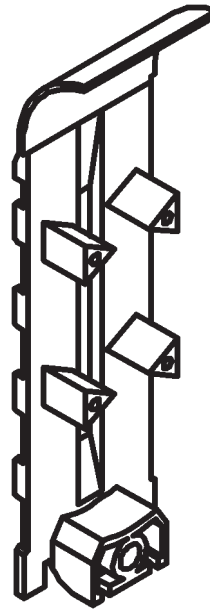

96BG-5
Egress Triple Support

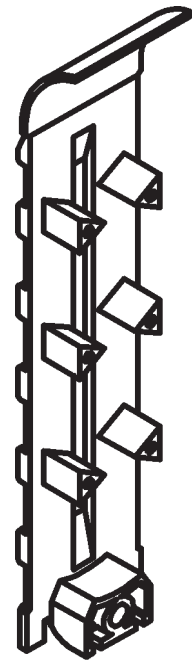

96BG-6
Egress Quad Support

96BU SERIES CONSTANT FORCE BALANCES

UNIVERSAL
1-1/4" Pocket Size

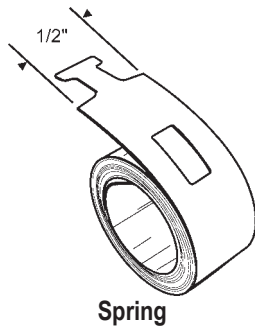

Spring

Weight	Our Part #
3.5 lbs.	96BU-1
4.5 lbs.	96BU-2
5.5 lbs.	96BU-3
6.5 lbs.	96BU-4
7.5 lbs.	96BU-5
9 lbs.	96BU-10
10 lbs.	96BU-12

96BU SERIES BALANCE SUPPORTS

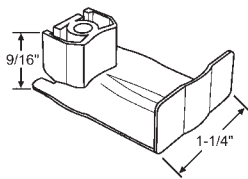

96BU-6
Single Support

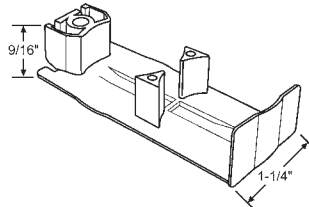

96BU-7
Dual Support

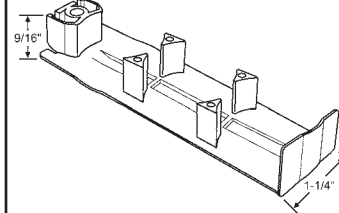

96BU-8
Triple Support

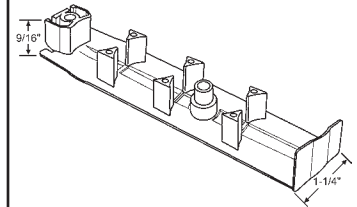

96BU-9
Quad Support

96BU SERIES BALANCE ACCESSORIES

LOCK BRAKE SHOE

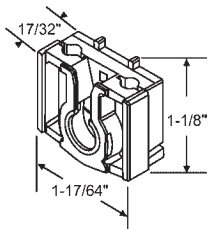

900-19198
No Longer Available
Use: 900-19198NS

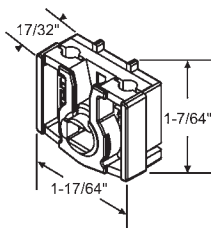

900-19198NS
Spring Side
Super Tough Nylon

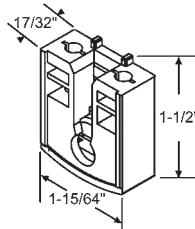

960-102
Back Locking Brake Shoe

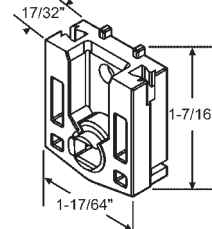

960-105
Spring Side Brake Shoe

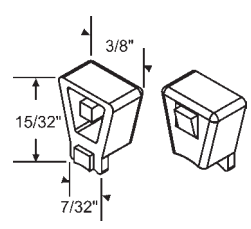

900-22527

PIVOT RETAINER

PIVOT BARS

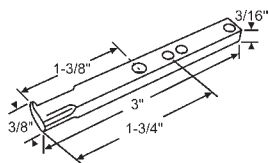

62-545
Transit

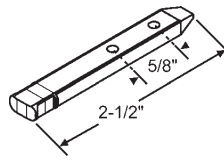

62-550
T Head Pivot

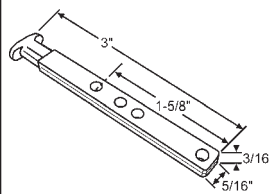

900-22526
T-Pivot

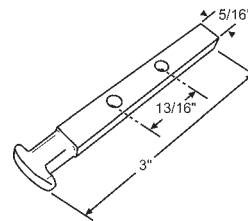

62-551
Use: 62-553

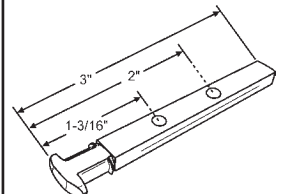

62-553

SASH SUPPORT SYSTEMS

96-C SERIES COILED BALANCE SPRINGS

CERTAINTED

Short Tongue, 3/4" Wide

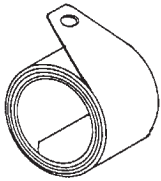

Number Stamped on Spring	Weight	Our Part #
263-S	3 lbs.	96-C263
334-S	4 lbs.	96-C334
335-S	5 lbs.	96-C335
405-S	5 lbs.	96-C405
336-S	6 lbs.	96-C336
406-S	6 lbs.	96-C406
407-S	7 lbs.	96-C407
408-S	8 lbs.	96-C408
409-S	9 lbs.	96-C409

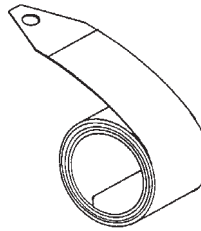

Long Tongue, 3/4" Wide

Number Stamped on Spring	Weight	Our Part #
405-L	5 lbs.	96-C405A
406-L	6 lbs.	96-C406A
407-L	7 lbs.	96-C407A
408-8	8 lbs.	96-C408A
409-8	9 lbs.	96-C409A

Note: Many other manufacturers' variations are available. Contact your account manager if you have a similar product. Samples may be required.

96-C SERIES BALANCE ACCESSORIES

PIVOT BAR

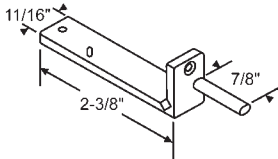

Part #	Hand
96-C7	Shown
96-C6	Opposite

Old Style. No Longer Available
Use 96-C18 & 96-C19

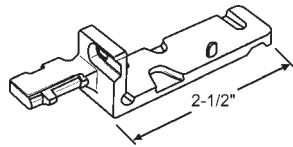

Part #	Hand
96-C18	Shown
96-C19	Opposite

Interlocking Pivot Bar

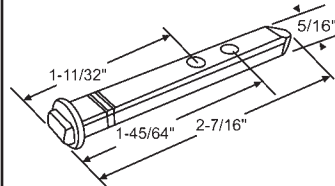

85-864

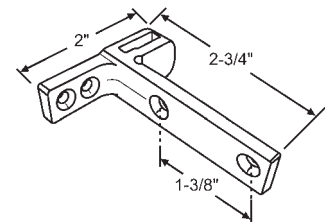

96-C700

PIVOT LOCK SHOE

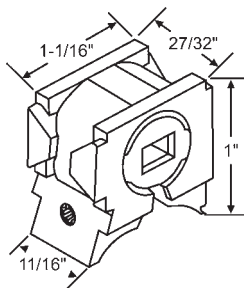

Old Style
With Plastic Cam
No Longer Available
Use: 96-C1

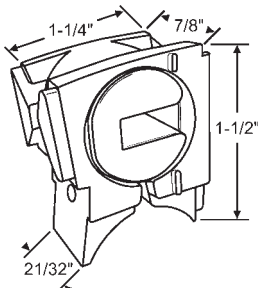

96-C1 (New Style)
With Metal Cam
Cam Opening: 19/64" x 3/16"
CERTAINTED

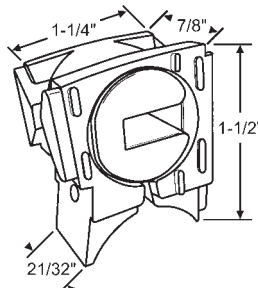

96-C9
Nylon Body with Metal Cam and
Alignment Nibs

BALANCE SPRING COVERS

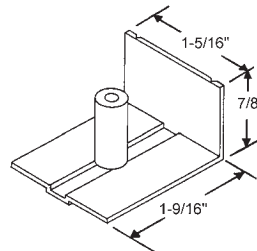

96-C2
Drum Barrel Diameter: Outside
3/8" Inside 5/32". Wide
CERTAINTED

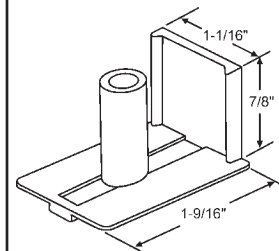

96-C8
Drum Barrel Diameter: Outside
3/8" Inside 1/4". Narrow
CERTAINTED

BALANCE DRUM

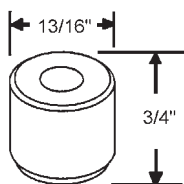

96-C3
CERTAINTED

VENT LOCK

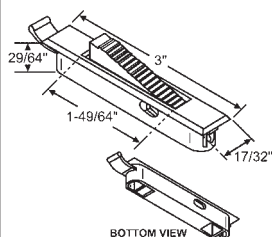

85-1123W
White

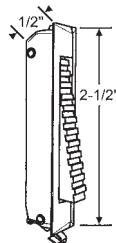

900-13386

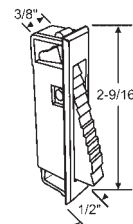

Part #	Color
900-20590	Beige
900-20590W	White

CERTAINTED

SHEET METAL SCREW



Part #	Color
20-240	Mill
20-240W	White

#8 x 3/8" Phillips Pan Head
CERTAINTED

96CQ SERIES QUICK TILT CONSTANT FORCE BALANCE ACCESSORIES

The old style quick tilt constant force balance assemblies are no longer available. They are replaced with quick tilt NC assemblies. The old style quick tilt carriers use the "T" head pivot bars (see below), which will also need to be replaced when converting to the new style quick tilt NC system. The replacement assemblies take the round head pivot bar (see below). When ordering the replacement balance assemblies, identify the carrier size and the weight of the sash. Then, select the corresponding quick tilt NC balance assembly from chart shown on page 132.

Old Style

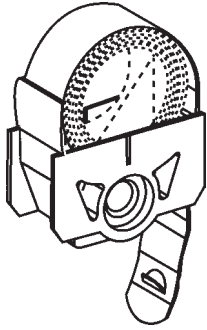

96CQ-10
Tamper Lock

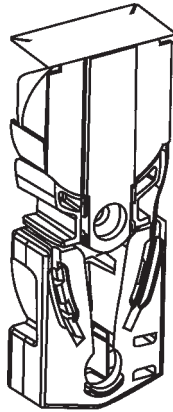
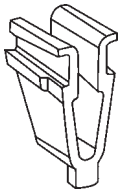

96CQ-20

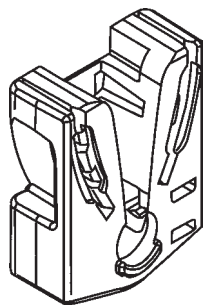
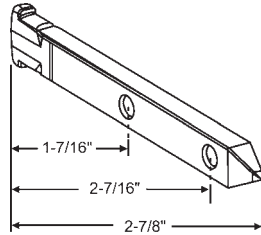

96CQ-22

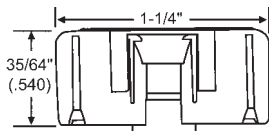
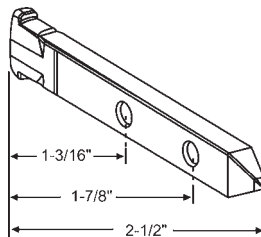

.540 Carrier

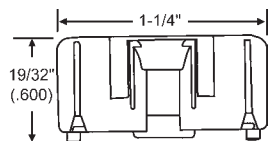

.600 Carrier

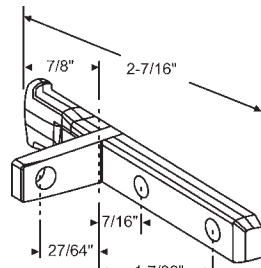

96CQ-26

T-Head Pivot Bars
Use with Old Style system
No longer available. Use: 96CQ-27

New Style

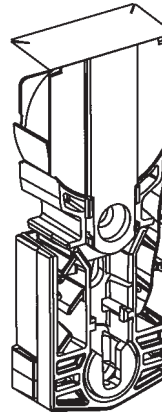

96CQ-24

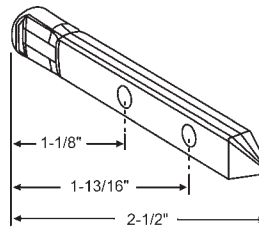
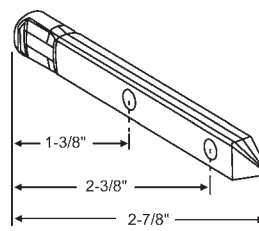

96CQ-23

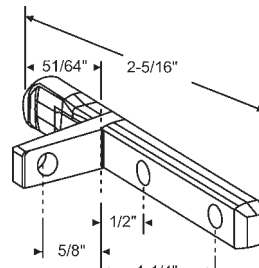

96CQ-27

Round-Head Pivot Bars
Use when converting to quick tilt NC.

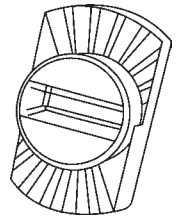

96CQ-18
Friction Adjuster

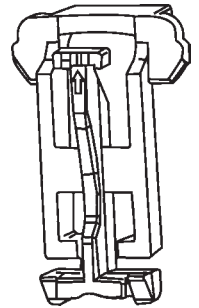

96CQ-17
Tamper Lock

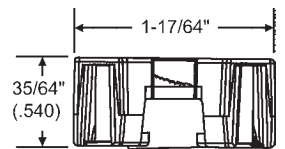
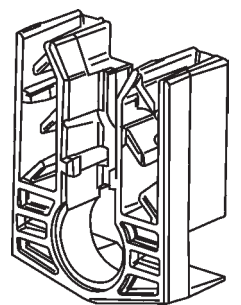

.540 Carrier

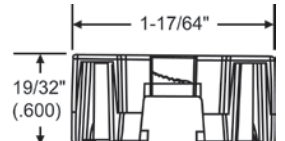

.600 Carrier

SASH SUPPORT SYSTEMS

96CQ SERIES QUICK TILT CONSTANT FORCE BALANCES

Coil balance assemblies are listed by carrier thickness. These carriers use a round head pivot bar. Quick Tilt coil balances are sold as a complete set only.

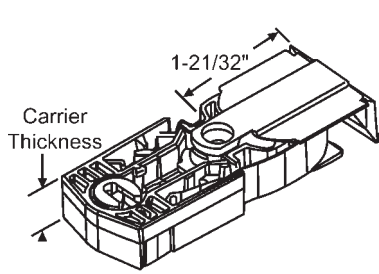

Single (RH Shown)

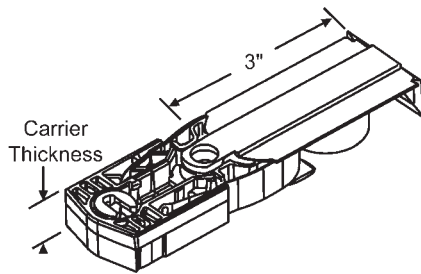

Tandem

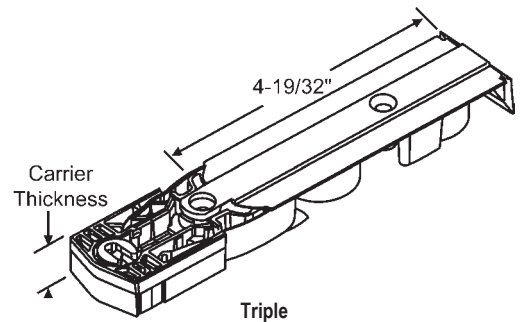

Triple

Weight	Coil	Balance Assembly with .540 Carrier Thickness	Balance Assembly with .600 Carrier Thickness
3 lb. Cover Assy. RH	SINGLE	96CQ-30RH	96CQ-31RH
4 lb. Cover Assy. RH	SINGLE	96CQ-32RH	96CQ-33RH
5 lb. Cover Assy. RH	SINGLE	96CQ-34RH	96CQ-35RH
6 lb. Cover Assy. RH	SINGLE	96CQ-36RH	96CQ-37RH
7 lb. Cover Assy. RH	SINGLE	96CQ-38RH	96CQ-39RH
8 lb. Cover Assy. RH	SINGLE	96CQ-40RH	96CQ-41RH
9 lb. Cover Assy. RH	SINGLE	96CQ-42RH	96CQ-43RH
3 lb. Cover Assy. LH	SINGLE	96CQ-30LH	96CQ-31LH
4 lb. Cover Assy. LH	SINGLE	96CQ-32LH	96CQ-33LH
5 lb. Cover Assy. LH	SINGLE	96CQ-34LH	96CQ-35LH
6 lb. Cover Assy. LH	SINGLE	96CQ-36LH	96CQ-37LH
7 lb. Cover Assy. LH	SINGLE	96CQ-38LH	96CQ-39LH
8 lb. Cover Assy. LH	SINGLE	96CQ-40LH	96CQ-41LH
9 lb. Cover Assy. LH	SINGLE	96CQ-42LH	96CQ-43LH
10 lb. Cover Assy.	TANDEM	96CQ-48	96CQ-49
11 lb. Cover Assy.	TANDEM	96CQ-50	96CQ-51
12 lb. Cover Assy.	TANDEM	96CQ-52	96CQ-53
13 lb. Cover Assy.	TANDEM	96CQ-54	96CQ-55
14 lb. Cover Assy.	TANDEM	96CQ-56	96CQ-57
15 lb. Cover Assy.	TANDEM	96CQ-58	96CQ-59
16 lb. Cover Assy.	TANDEM	96CQ-60	96CQ-61
17 lb. Cover Assy.	TANDEM	96CQ-62	96CQ-63
18 lb. Cover Assy.	TANDEM	96CQ-64	96CQ-65
19 lb. Cover Assy.	TRIPLE	96CQ-66	96CQ-67
20 lb. Cover Assy.	TRIPLE	96CQ-68	96CQ-69
21 lb. Cover Assy.	TRIPLE	96CQ-70	96CQ-71
22 lb. Cover Assy.	TRIPLE	96CQ-72	96CQ-73
23 lb. Cover Assy.	TRIPLE	96CQ-74	96CQ-75
24 lb. Cover Assy.	TRIPLE	96CQ-76	96CQ-77
25 lb. Cover Assy.	TRIPLE	96CQ-78	96CQ-79
26 lb. Cover Assy.	TRIPLE	96CQ-80	96CQ-81
27 lb. Cover Assy.	TRIPLE	96CQ-82	96CQ-83

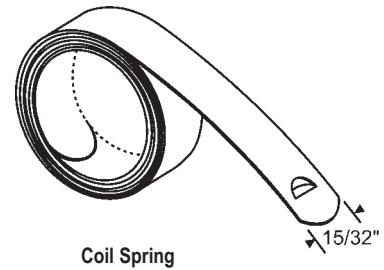

Coil Spring

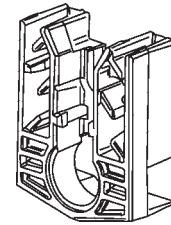

Carrier Body

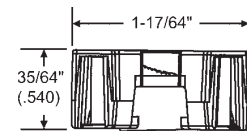

96CQ-13
.540 Carrier

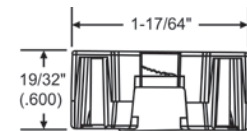

96CQ-15
.600 Carrier

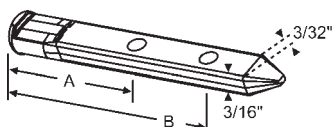

Round Head Pivot Bar

Part #	A	B	Overall Length
96CQ-23	1-1/8"	1-13/16"	2-1/2"
96CQ-24	1-3/8"	2-3/8"	2-7/8"

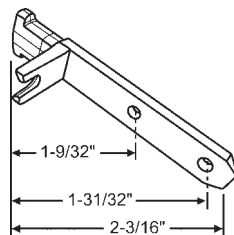

96CQ-28
Quick Tilt Pivot Bar

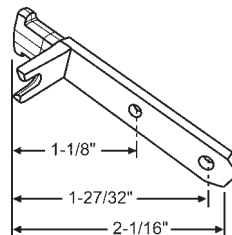

96CQ-29
Quick Tilt Pivot Bar

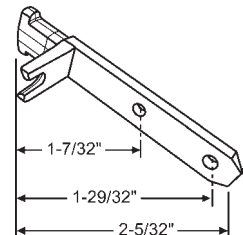

96CQ-30
Quick Tilt Pivot Bar

96CR ROLLER TILT CONSTANT FORCE BALANCE SYSTEM

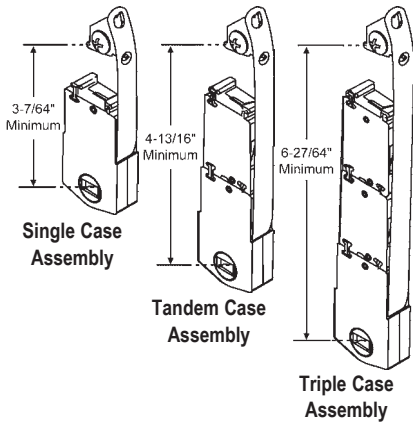

Note: All roller tilt components are sold separately.

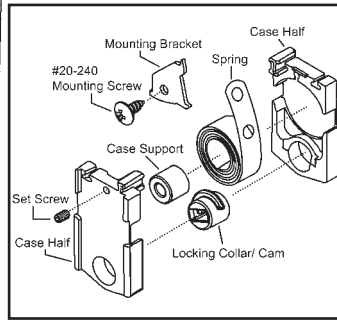

STAINLESS STEEL COIL SPRING

Part #	Spring Capacity
96CR-1	#3
96CR-2	#4
96CR-3	#5
96CR-4	#6
96CR-5	#7
96CR-6	#8
96CR-7	#9
96CR-8	#10

CASE SUPPORT

96CR-521
Not required when using new, improved coil spring.

LOCKING CASE HALVES
Need to order 2 halves to make up 1 case assembly

96CR-522
Shown (2) 96CR-522

96CR-523
Shown (1) 96CR-523 and (1) 96CR-522. For Tie in Bar

96CR-524
Shown (2) 96CR-524

96CR-528
Used to make tandem and triple case assembly. Shown (2) 96CR-528

LOCKING COLLAR

Part #	"A"	Color
96CR-502	3/32"	Blue
96CR-503	7/64"	Black
96CR-504	1/8"	Red

Part #	"A"	Color
96CR-520	7/64"	Black

Tie-In Locking Collar

MOUNTING BRACKETS

96CR-504W
White

96CR-513W
White

SCREWS

20-240
#8 Pan Head
3/8" Long
Mounting Screw.

96CR-506
6-32 x 1/4" Friction
Adjustment Screw.

ANTI DEBRIS WIPER

96CR-517

CHIMNEY BLOCK

96CR-529
Protects balance against dust and prevents air flow in jamb pocket. Cover will automatically position itself during operation of window.

PIVOT BAR

900-15004

96CR-20
Tie-In. Die Cast

85-627

96CR-21
Tie-In. Die Cast

CARRIER ASSEMBLY FOR FLARED PIVOT BARS

Carrier Assy. Part #	Cam Color	"A"
96CR-511	Natural	35/64" (.548)
96CR-509	Orange	37/64" (.581)
96CR-510	Black	39/64" (.613)

SASH SUPPORT SYSTEMS

96M SERIES CONSTANT FORCE BALANCE SYSTEM

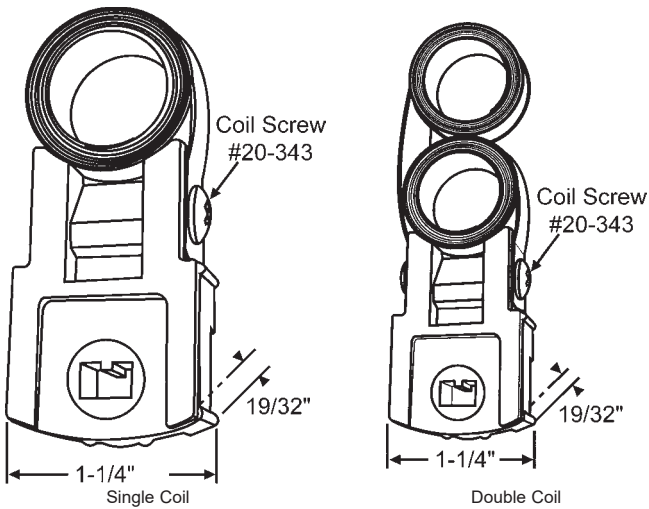

Old Style
Use New Style from Chart Below

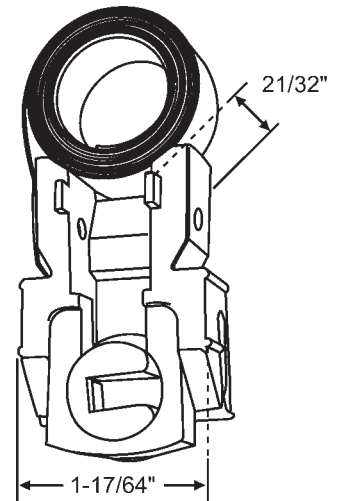
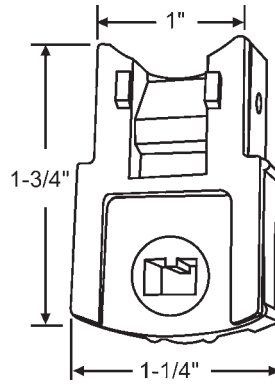

Single or Double Coil	Number Stamped on Coil	Part #
Single	335	96-M26
Single	440	96-M9
Single	5 or 540	96-M5
Single	6 or 640	96-M3
Single	7 or 740	96-M7
Single	8 or 840	96-M28
Single	832	96-M21
Double	335/335	96-M6
Double	440/440	96-M17
Double	440/540	96-M8
Double	540/540	96-M10
Double	540/640	96-M11
Double	640/640	96-M27
Double	740/740	96-M13
Double	840/840	96-M29

Single or Double Coil	Number Stamped on Coil	Part #
Single	5 or 540	96-M22
Single	6 or 640	96-M3F
Single	7 or 740	96-M7F
Single	8 or 840	96-M28F
Single	832	96-M21F
Double	440/440	96-M17F
Double	440/540	96-M2
Double	540/540	96-M18
Double	540/640	96-M25
Double	640/640	96-M27F
Double	840/840	96-M29F
Double	740/740	96-M4
Double	940/940	96-M35F

96M SERIES CONSTANT FORCE BALANCE SYSTEM ACCESSORIES

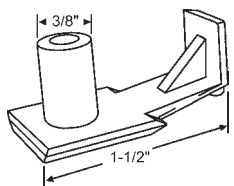

96-M14C
Clip

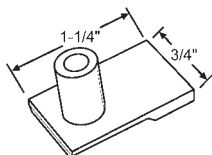

96-M39
Single Post Detent Clip

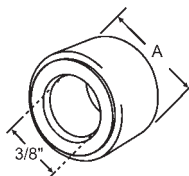

Part #	Color	A
96-M15	Dark Gray	21/32"
96-M15BL	Black	21/32"
96-M15BZ	Bronze	41/64"
96-M15G	Gray	11/16"
96-M15T	Tan	41/64"
96-M15W	White	43/64"

Bushing

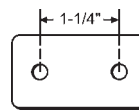

96-M16
Guide

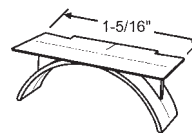

96-M38
White Plastic Air Pad

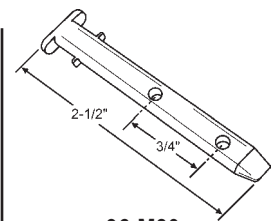

96-M30
Zinc Pivot Bar

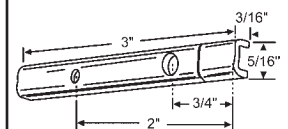

96-M23
Universal Pivot Bar

INTRODUCTION TO VINYL JAMBLINERS

DON'T REPLACE - REPAIR your old wood windows with new, thermally-efficient, rattle-free jambliners!

- Vinyl jambliners can reduce air infiltration dramatically and increase the efficiency of wood windows by over 60%!
- They are an excellent option when your customer's wood sash are in good shape but balances, pulleys and weatherstripping are not sufficient.
- We offer a stocking program of tilt and non-tilt jambliners for 1-1/4" and 1-3/8" sash and can provide custom sizes for most window shapes.
- We also provide single and double hung custom made jambliners for 1-3/4" sash. These are used primarily for historical renovations.
- Please refer to our easy-to-use jambliner chart on page 136 to help you determine the jambliner most suited to your customer's needs.
- We also offer a number of options not shown in this catalog. Please contact your account manager for any special requests!

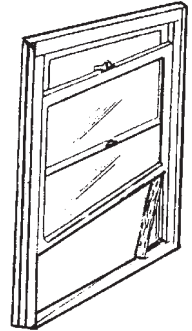

HOW TO MEASURE YOUR EXISTING WINDOW OPENING

WIDTH

To find the width of the sash opening, measure from inside jamb to inside jamb. This measurement should be approximately 4" wider than the glass width.

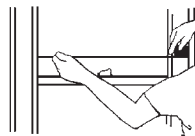
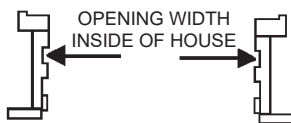

HEIGHT

To find the height of the opening, measure from the header to the sill at the inside edge of the parting bead. This measurement is normally about 6" greater than double the glass height. Also needed is the longest opening height.

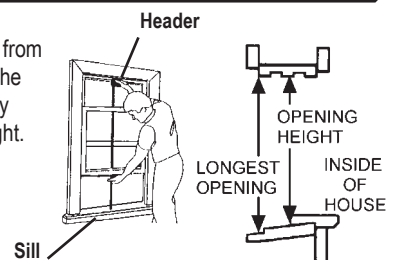

HOW TO INSTALL NON-TILT JAMBLINERS

1. In order to accept our 86A, 86B, 86C, 86D jambliners, you must make a 5/8" wide x 5/8" deep square plough along both sides of the sash.

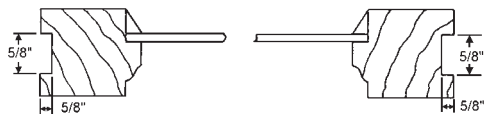

3. Set the lower and upper sash on a chair (per diagram) Note: sash are upside down with the interior (bare wood) towards the chair back.

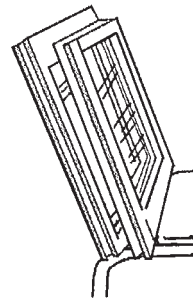

5. Pick up balance with sash so that the interior is facing you. Place the bottom of balance into window frame until it butts outside stop, then ease into position. Raise lower sash, thus driving speed lock into header to secure the balance. Tops of jambliner are slightly aligned for easier installation.

2. If you are replacing sash fitted with ropes or chains, it will be necessary to prepare your opening as follows:

- Cut off ropes or chains.
- Remove sash weight pulleys (four).
- Remove side parting beads; save the head parting bead as it will be reused.

If you are only replacing defective or worn balances, you will need to remove all existing hardware and make room for your new sash/balance system.

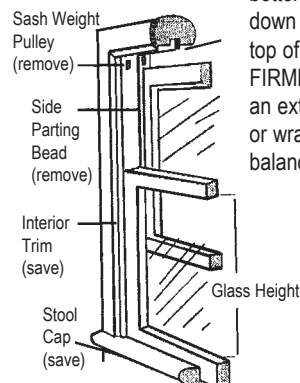

4. Pick up balances with angle cut to top. Place balance with sash platforms resting on bottom of sash. Push sash down about 1-1/2" - 2" below top of balance and HOLD FIRMLY. Note: you may find an extra pair of hands helpful, or wrap tape around sash and balance to assist in handling.

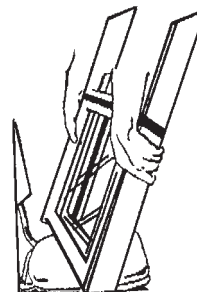

6. Check for proper fit, TEST OPERATION. Then replace stops, head parting bead and remainder of the interior trim.



Jambliner Work Sheet

Sash size doesn't matter because parting bead is removed.

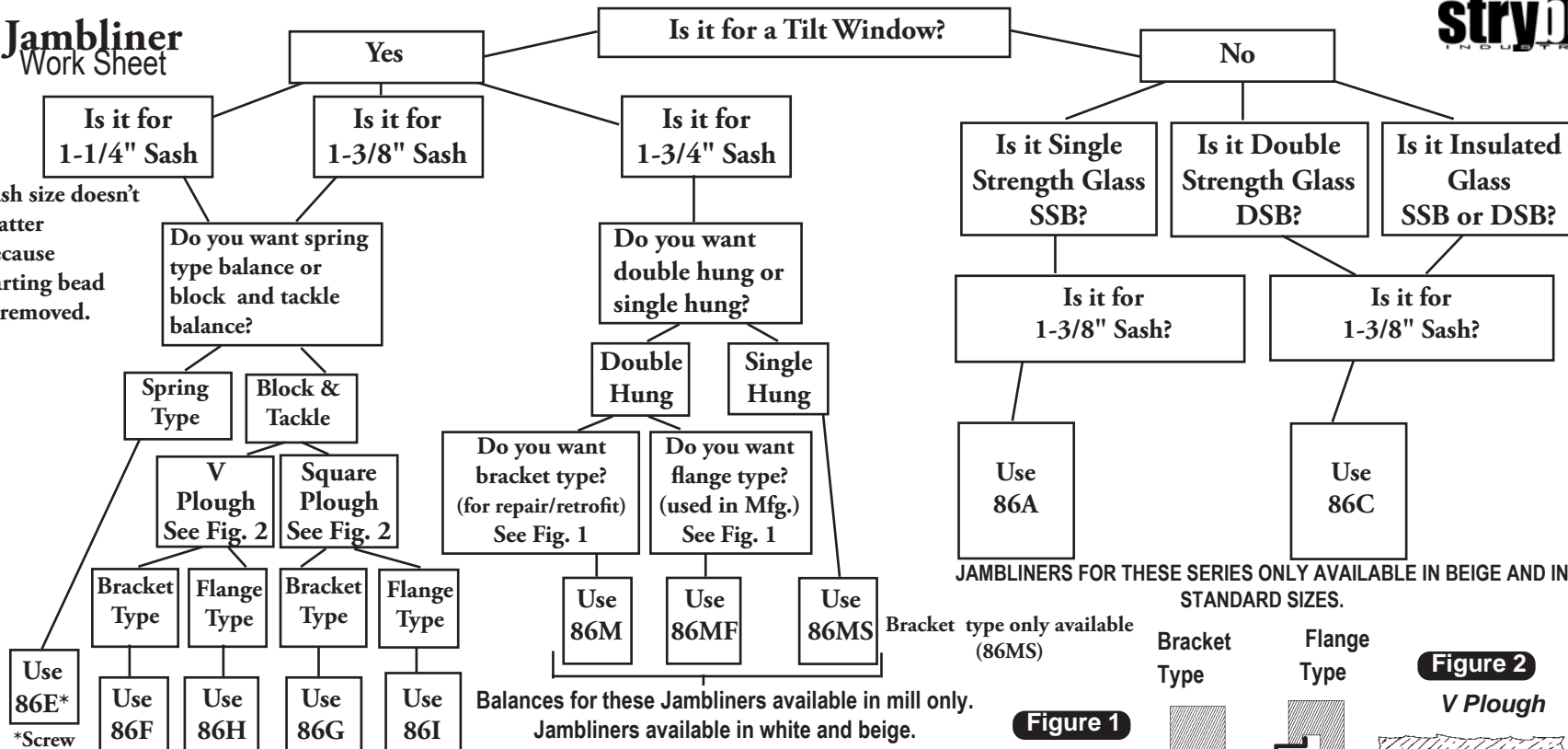

JAMBLINERS FOR THESE SERIES ONLY AVAILABLE IN BEIGE AND IN STANDARD SIZES.

Bracket type only available (86MS)

Bracket Type

Flange Type

Figure 2

V Plough

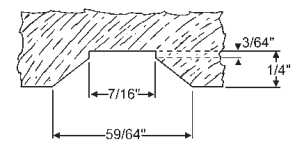

Square Plough

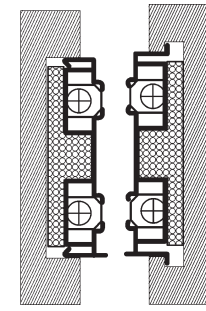
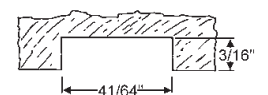

Sash+1-1/2"

Balances for these Jambliners available in mill only. Jambliners available in white and beige.

Figure 1

We suggest ordering square cut so you can make field adjustments. Add 1" or 2" to overall length.

Answer Following Questions

Available in standard size only. Available in custom size. (smallest fraction we can cut is 1/16")

- Circle One: Balance # { 86A, 86B, 86C, 86D, 86E } { 86F, 86G, 86H, 86I, 86M, 86MF, 86MS }
- Circle One: Sill Angle - Square Cut (Recommended), 15° (Most Common), 14°, 9°, 7°, 5°, Other _____
- Circle One: Color: Beige or White (86A, 86B, 86C & 86D Available in Beige Only)
- Circle One: Color of Balance: -Mill (Standard), White, Beige (86M, 86MF & 86MS Available in Mill Only)
- Circle One: Type of Glass: - Single Strength - Double Strength - Single Strength Insulated - Double Strength Insulated - Triple Glazed
- Circle One: Bracket Type - (Primarily used in retrofit) Flange Type - (Used in custom mfg.) - See Figure 1.
- Circle One: V plough or Square plough only applies to 86F, 86H, 86G, 86I. - See Figure 2.
- Visible Glass Height of Top Sash _____ Top Sash Weight _____
- Visible Glass Height of Bottom Sash _____ Bottom Sash Weight _____
- Glass Width (Top and Bottom Same) _____
- Overall Length to Longest Point _____ Shortest Point _____

Note: Rule of thumb formula for calculating longest point is two times glass height plus 6-3/8" equals length to the longest point.

I understand this material is custom made to specifications as stated on this form and is non-returnable and non-cancelable.

Signature of authorized buyer _____

Quantity _____ Part # _____ Price _____

TILT JAMBLINERS WITH BLOCK AND TACKLE BALANCES

7000 SERIES / 9000 SERIES

Jambliners with block and tackle balances carry a higher weight range and provide smoother opening and closing compared to spring type balances. To determine which choice best suits your customer's needs, you need to determine:



- Bracket Type** - Used primarily in retrofit or flange type -used in custom manufacturing. (Refer to Figure 1).
- V Plough or Square Plough** (Refer to Figure 2).
- If converting from a non-tilt to a tilt system** - You will need to cut back sash 1-1/2" (Figure 1) and then plough sash as shown (Figure 2).
Our chart on the following page offers standard industry sizes; however we can provide a variety of options. See our jambliner chart on page 136 for any special requests.
- To purchase ribbed balances separately, see page 53 for 62A series.

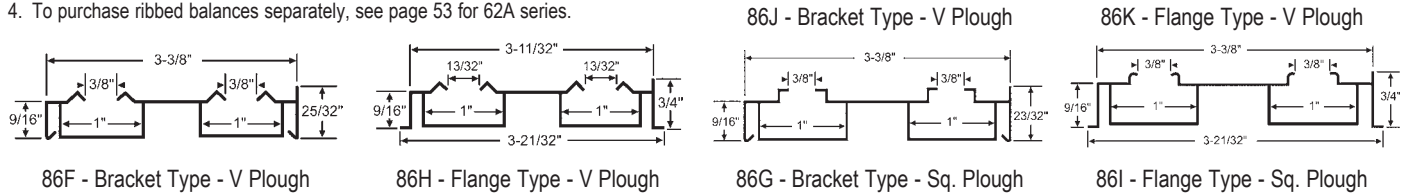
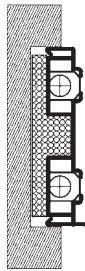
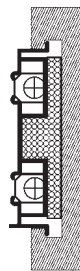

Figure 1

Bracket Type



Flange Type



Sash + 1-1/2"

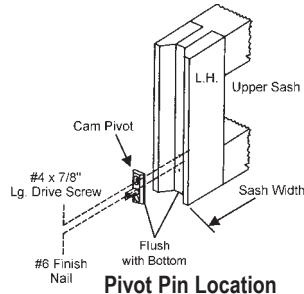

Pivot Pin Location

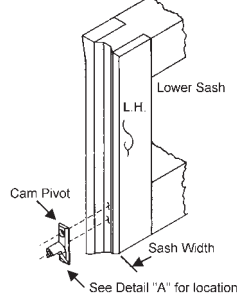

V Plough

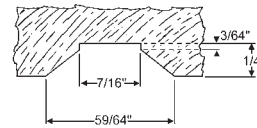
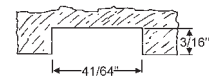
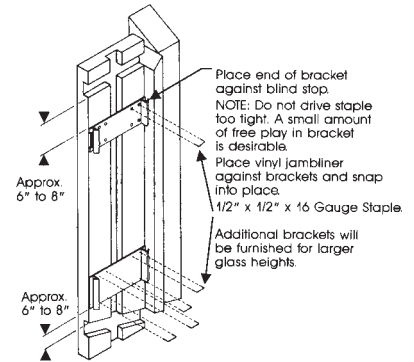

Figure 2

Square Plough



Bracket Installation



7000/9000 SERIES HARDWARE

CAM PIVOTS

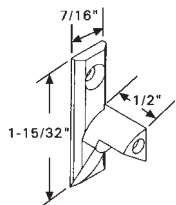

Part #	Description
62-650RH	Zinc
62-649RB	Black Plastic

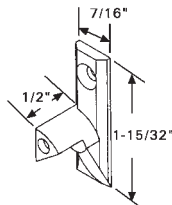

Part #	Description
62-650LH	Zinc
62-649LW	White Plastic

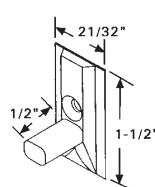

62-652	Die Cast Square Plough
---------------	------------------------

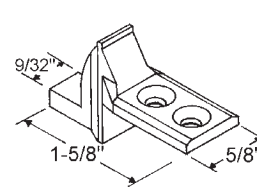

62-656	CARADCO
---------------	----------------

SASH STOP

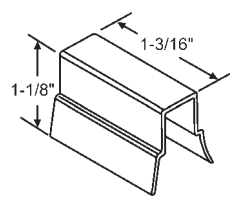

Part #	Color
62-701BG	Beige
62-701	White

BALANCE CLIPS

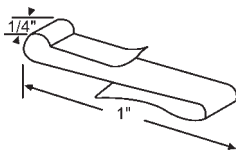

62-517

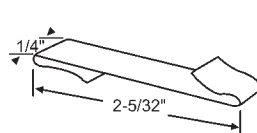

62-518

INSTALLATION BRACKETS

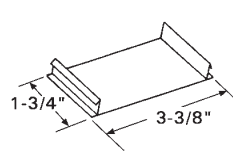

86-21
Vinyl Release

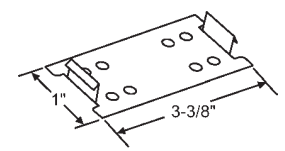

86-22
Standard, Metal

TILT JAMBLINERS WITH BLOCK AND TACKLE BALANCES

7000 Series Part # for Standard Jambliner Sets 15° with Standard Lengths.

When ordering any of these Jambliners, identify the number you need and add part number to Jambliner form, sign and fax to our office.

Glass Height	Number Stamped on Balance	Balance Length	Approx. Sash Weight Capacity	86F White Bracket Type V Plough	86H White Flange Type V Plough	86G White Bracket Type Square Plough	86I White Flange Type Square Plough	Length to Longest Point
12"	12 REG	13"	8-11 lbs.	86F-15°-30-3/8	86H-15°-30-3/8	86G-15°-30-3/8	86I-15°-30-3/8	30-3/8"
12"	12HD	13"	12-14 lbs.	86F-15°-30-3/8HD	86H-15°-30-3/8HD	86G-15°-30-3/8HD	86I-15°-30-3/8HD	30-3/8"
14"	14 REG	15"	10-15 lbs.	86F-15°-34-3/8	86H-15°-34-3/8	86G-15°-34-3/8	86I-15°-34-3/8	34-3/8"
14"	14 HD	15"	15-22 lbs.	86F-15°-34-3/8HD	86H-15°-34-3/8HD	86G-15°-34-3/8HD	86I-15°-34-3/8HD	34-3/8"
16"	16 REG	17"	10-17 lbs.	86F-15°-38-3/8	86H-15°-38-3/8	86G-15°-38-3/8	86I-15°-38-3/8	38-3/8"
16"	16HD	17"	17-22 lbs.	86F-15°-38-3/8HD	86H-15°-38-3/8HD	86G-15°-38-3/8HD	86I-15°-38-3/8HD	38-3/8"
18"	18 REG	19"	10-17 lbs.	86F-15°-42-3/8	86H-15°-42-3/8	86G-15°-42-3/8	86I-15°-42-3/8	42-3/8"
18"	18 HD	19"	17-22 lbs.	86F-15°-42-3/8HD	86H-15°-42-3/8HD	86G-15°-42-3/8HD	86I-15°-42-3/8HD	42-3/8"
20"	20 REG	21"	10-17 lbs.	86F-15°-46-3/8	86H-15°-46-3/8	86G-15°-46-3/8	86I-15°-46-3/8	46-3/8"
20"	20 HD	21"	17-20 lbs.	86F-15°-46-3/8HD	86H-15°-46-3/8HD	86G-15°-46-3/8HD	86I-15°-46-3/8HD	46-3/8"
20"	20 TG	21"	20-30 lbs.	86F-15°-46-3/8TG	86H-15°-46-3/8TG	86G-15°-46-3/8TG	86I-15°-46-3/8TG	46-3/8"
22"	22 REG	23"	10-18 lbs.	86F-15°-50-3/8	86H-15°-50-3/8	86G-15°-50-3/8	86I-15°-50-3/8	50-3/8"
22"	22 HD	23"	18-22 lbs.	86F-15°-50-3/8HD	86H-15°-50-3/8HD	86G-15°-50-3/8HD	86I-15°-50-3/8HD	50-3/8"
22"	22 TG	23"	22-30 lbs.	86F-15°-50-3/8TG	86H-15°-50-3/8TG	86G-15°-50-3/8TG	86I-15°-50-3/8TG	50-3/8"
24"	24 REG	25"	10-18 lbs.	86F-15°-54-3/8	86H-15°-54-3/8	86G-15°-54-3/8	86I-15°-54-3/8	54-3/8"
24"	24 HD	25"	18-22 lbs.	86F-15°-54-3/8HD	86H-15°-54-3/8HD	86G-15°-54-3/8HD	86I-15°-54-3/8HD	54-3/8"
24"	24TG	25"	22-30 lbs.	86F-15°-54-3/8TG	86H-15°-54-3/8TG	86G-15°-54-3/8TG	86I-15°-54-3/8TG	54-3/8"
26"	26 REG	27"	10-19 lbs.	86F-15°-58-3/8	86H-15°-58-3/8	86G-15°-58-3/8	86I-15°-58-3/8	58-3/8"
26"	26 HD	27"	19-24 lbs.	86F-15°-58-3/8HD	86H-15°-58-3/8HD	86G-15°-58-3/8HD	86I-15°-58-3/8HD	58-3/8"
26"	26 TG	27"	24-31 lbs.	86F-15°-58-3/8TG	86H-15°-58-3/8TG	86G-15°-58-3/8TG	86I-15°-58-3/8TG	58-3/8"
28"	28 REG	29"	15-22 lbs.	86F-15°-62-3/8	86H-15°-62-3/8	86G-15°-62-3/8	86I-15°-62-3/8	62-3/8"
28"	28 HD	29"	22-28 lbs.	86F-15°-62-3/8HD	86H-15°-62-3/8HD	86G-15°-62-3/8HD	86I-15°-62-3/8HD	62-3/8"
28"	28 TG	29"	28-35 lbs.	86F-15°-62-3/8TG	86H-15°-62-3/8TG	86G-15°-62-3/8TG	86I-15°-62-3/8TG	62-3/8"
30"	30 REG	31"	15-23 lbs.	86F-15°-66-3/8	86H-15°-66-3/8	86G-15°-66-3/8	86I-15°-66-3/8	66-3/8"
30"	30 HD	31"	23-29 lbs.	86F-15°-66-3/8HD	86H-15°-66-3/8HD	86G-15°-66-3/8HD	86I-15°-66-3/8HD	66-3/8"
30"	30 TG	31"	30-36 lbs.	86F-15°-66-3/8TG	86H-15°-66-3/8TG	86G-15°-66-3/8TG	86I-15°-66-3/8TG	66-3/8"
32"	32 REG	33"	15-24 lbs.	86F-15°-70-3/8	86H-15°-70-3/8	86G-15°-70-3/8	86I-15°-70-3/8	70-3/8"
32"	32 HD	33"	24-29 lbs.	86F-15°-70-3/8HD	86H-15°-70-3/8HD	86G-15°-70-3/8HD	86I-15°-70-3/8HD	70-3/8"
32"	32 TG	33"	29-36 lbs.	86F-15°-70-3/8TG	86H-15°-70-3/8TG	86G-15°-70-3/8TG	86I-15°-70-3/8TG	70-3/8"
34"	34 REG	35"	15-24 lbs.	86F-15°-74-3/8	86H-15°-74-3/8	86G-15°-74-3/8	86I-15°-74-3/8	74-3/8"
34"	34 HD	35"	24-29 lbs.	86F-15°-74-3/8HD	86H-15°-74-3/8HD	86G-15°-74-3/8HD	86I-15°-74-3/8HD	74-3/8"
34"	34 TG	35"	29-36 lbs.	86F-15°-74-3/8TG	86H-15°-74-3/8TG	86G-15°-74-3/8TG	86I-15°-74-3/8TG	74-3/8"
36"	36 REG	37"	15-24 lbs.	86F-15°-78-3/8	86H-15°-78-3/8	86G-15°-78-3/8	86I-15°-78-3/8	78-3/8"
36"	36 HD	37"	24-29 lbs.	86F-15°-78-3/8HD	86H-15°-78-3/8HD	86G-15°-78-3/8HD	86I-15°-78-3/8HD	78-3/8"
36"	36TG	37"	29-38 lbs.	86F-15°-78-3/8TG	86H-15°-78-3/8TG	86G-15°-78-3/8TG	86I-15°-78-3/8TG	78-3/8"
38"	38 REG	39"	15-25 lbs.	86F-15°-82-3/8	86H-15°-82-3/8	86G-15°-82-3/8	86I-15°-82-3/8	82-3/8"
38"	38 HD	39"	24-29 lbs.	86F-15°-82-3/8HD	86H-15°-82-3/8HD	86G-15°-82-3/8HD	86I-15°-82-3/8HD	82-3/8"
38"	38 TG	39"	29-38 lbs.	86F-15°-82-3/8TG	86H-15°-82-3/8TG	86G-15°-82-3/8TG	86I-15°-82-3/8TG	82-3/8"
40"	40 REG	41"	15-25 lbs.	86F-15°-86-3/8	86H-15°-86-3/8	86G-15°-86-3/8	86I-15°-86-3/8	86-3/8"
40"	40 HD	41"	25-30 lbs.	86F-15°-86-3/8HD	86H-15°-86-3/8HD	86G-15°-86-3/8HD	86I-15°-86-3/8HD	86-3/8"
40"	40 TG	41"	30-38 lbs.	86F-15°-86-3/8TG	86H-15°-86-3/8TG	86G-15°-86-3/8TG	86I-15°-86-3/8TG	86-3/8"
42"	42 REG	43"	15-25 lbs.	86F-15°-90-3/8	86H-15°-90-3/8	86G-15°-90-3/8	86I-15°-90-3/8	90-3/8"
42"	42 HD	43"	25-30 lbs.	86F-15°-90-3/8HD	86H-15°-90-3/8HD	86G-15°-90-3/8HD	86I-15°-90-3/8HD	90-3/8"
42"	42 TG	43"	30-38 lbs.	86F-15°-90-3/8TG	86H-15°-90-3/8TG	86G-15°-90-3/8TG	86I-15°-90-3/8TG	90-3/8"

To order beige jambliners, add "B" after part number. Example: 86F-15°-30-3/8HDB

Note: For all variations or specials please refer to chart on page 136.

All balances for jambliners are supplied in mill finish. If color balances are required, please fill out form on page 136.

HEAVY DUTY MAGNUM TILT JAMBLINERS FOR 1-3/4" SASH

- The magnum jambliners are the choice for historical restorations.
- Can carry up to 80 lb. sash weights; however, sash over 48" height and 50 lbs. must have limited travel.
- Magnums are offered for both double hung and single hung. Single hung is an excellent choice when top sash is fixed -cost is dramatically reduced.
- Double hung is offered in bracket type or flange type. Single hung is bracket type only.
- Available in white or beige finishes.
- Sets include hardware. Top retainer and can be used to make jambliners non-tilt. Hardware includes (2) RH and (2) LH pivots, (2) sash stops and (2) sash retainers for lower sash. For bracket type installation up to 54", use (4) brackets per set; up to 84", use (6) brackets per set; 84", use (8) brackets per set.

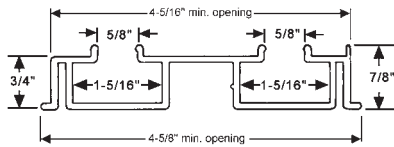

86MF - Flange Type

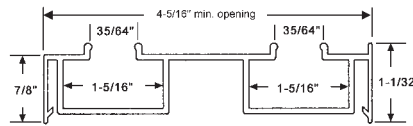

86M - Bracket Type

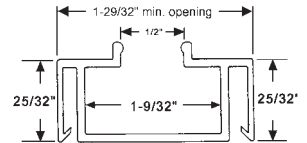

86MS - Bracket Type

***Magnum series is not a stock item and must be custom made. Please fill out information below.
These items are non-returnable.**

1. Circle one: Do you want single hung (86 MS) or double hung jambliner?
2. Circle one: If double hung -do you want bracket type (86M) or flange type (86MF)?
3. Circle one: beige or white
4. Circle one: sill angle-square cut (recommended) 15° (most common), 14°, 9°, 7°, 5°, other _____
5. Visible glass height of top sash _____, top sash weight _____
6. Visible glass height of bottom sash _____, bottom sash weight _____
7. Glass width (top and bottom same) _____
8. Overall length to longest point _____ shortest point _____

Example: 86M-Sq-76S45B means double-hung, bracket type jambliner (86M), square cut (Sq.), 76" long, 45 lbs. beige (B).

86M - 86MF - 86MS HARDWARE

Hardware is included with jambliner set. These items can also be purchased separately.

CAM PIVOTS

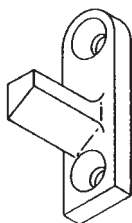

62-651LH

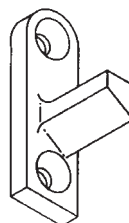

62-651RH

SASH STOP

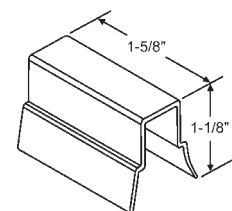

Part #	Color
62-702	White
62-702BG	Beige

SASH RETAINERS

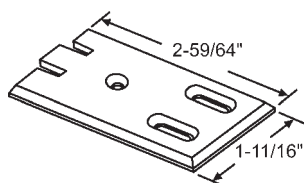

Part #	Color
62-657	White
62-657DBR	Dark Brown

INSTALLATION BRACKETS

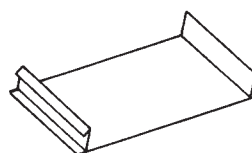

86-16
Single Hung Bracket

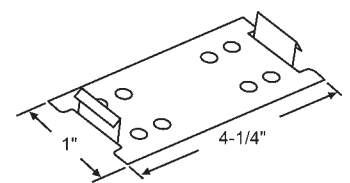

86-9
Double Hung Bracket

Sash Preparation for Single and Double Hung

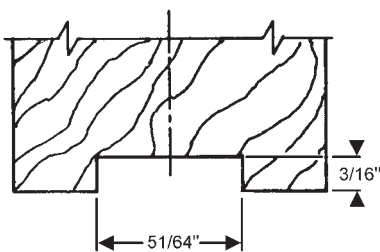

Double Hung Frame Applications and Sash Pre-fit

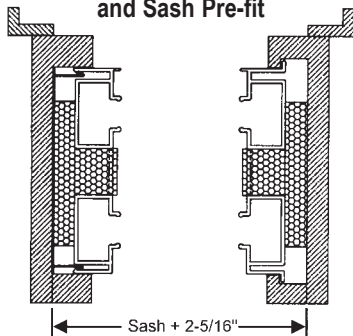

Single Hung Frame Applications and Sash Pre-fit

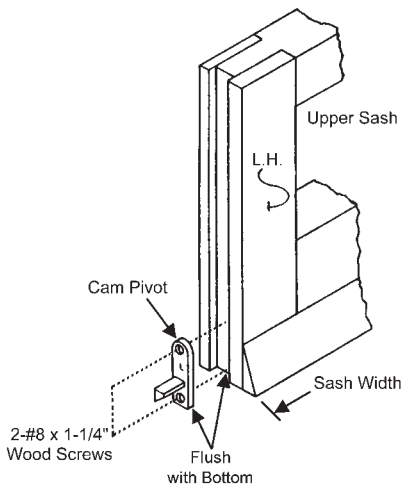
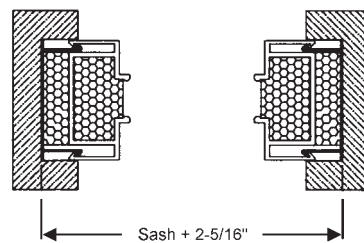

Bracket

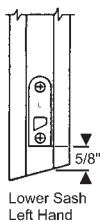

Flange

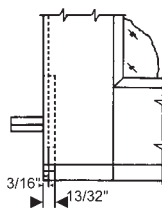

Detail "A"

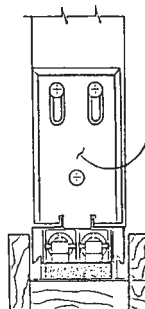
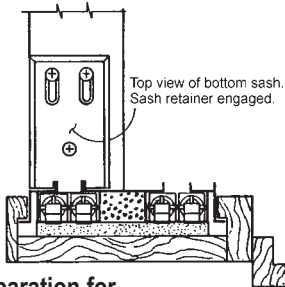
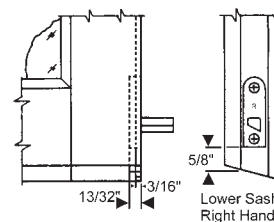

Frame Jamb Preparation for Bracket Application

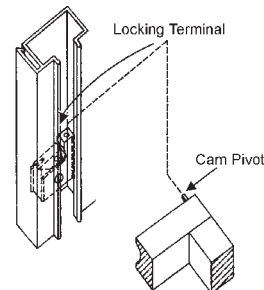
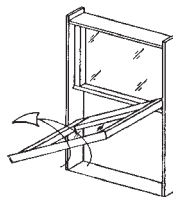
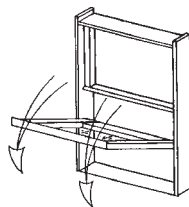
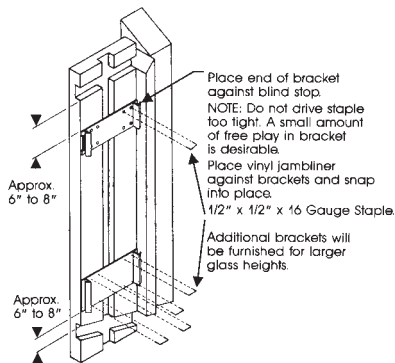
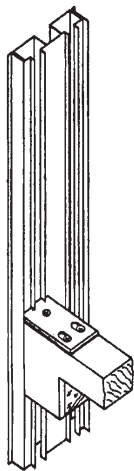

HOW TO INSTALL TILT JAMBLINERS

1. If you are converting a window from a Non-Tilt to a Tilt window or if you are retrofitting a window that previously used pulleys or other balances -you must cut back the sash by 11/16" on each side, reducing the overall sash width by 1-3/8". (See Figure 1.)

Figure 1

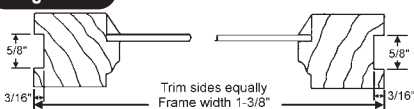

2. Make a 5/8" square x 3/16" deep plough on both sides of sash. (See Figure 1.)

3. Apply jambliners to jambs, with bottom touching the sill and flange side touching the blind stop. Press jambliner and drive screws until head is flush with liner. Readjustment of screws may be necessary during STEP 5.

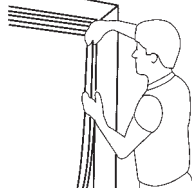

4. Install sash brackets in upper and lower sash as shown below.

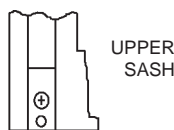

UPPER SASH

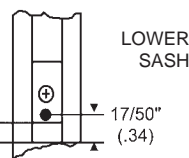

LOWER SASH

5. Insert upper sash into opening in full tilt position. Align pivot pins in the proper channel above carriers. Allow pins to drop into carriers. Pivot sash into place. Repeat for lower sash. Then reinstall the inside trim stops and head parting stop.

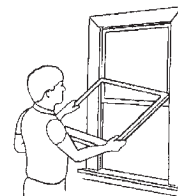

TILT JAMBLINERS

Screw Mount

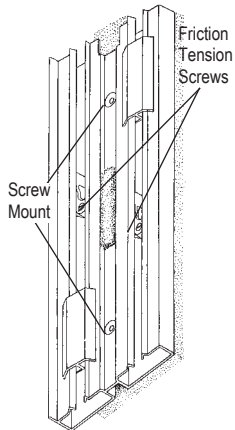

Series 86E

For Tilt Windows with Either Single Strength or Insulated Glass
 86E Series for 1-3/8" or 1-1/4" Sash
 Max Opening Height for 86E Series is 7-6 (90")

Glass Size	Opening Height	Height	Beige Part #	White Part #	Standard Sash Weight	Heavy Duty Beige Part #	Heavy Duty White Part #	Heavy Duty Sash Weight	Length to Longest Point
12"	2-6	30"	-	86E-30W	11 lbs.	-	86E-30HDW	15 lbs.	30-7/16"
14"	2-10	34"	86E-34	86E-34W	13 lbs.	86E-34HD	86E-34HDW	16 lbs.	34-7/16"
16"	3-2	38"	86E-38	86E-38W	14 lbs.	86E-38HD	86E-38HDW	18 lbs.	38-7/16"
18"	3-6	42"	86E-42	86E-42W	15 lbs.	86E-42HD	86E-42HDW	19 lbs.	42-7/16"
20"	3-10	46"	86E-46	86E-46W	16 lbs.	86E-46HD	86E-46HDW	21 lbs.	46-7/16"
22"	4-2	50"	86E-50	86E-50W	18 lbs.	86E-50HD	86E-50HDW	23 lbs.	50-7/16"
24"	4-6	54"	86E-54	86E-54W	19 lbs.	86E-54HD	86E-54HDW	25 lbs.	54-7/16"
26"	4-10	58"	86E-58	86E-58W	20 lbs.	86E-58HD	86E-58HDW	26 lbs.	58-7/16"
28"	5-2	62"	86E-62	86E-62W	22 lbs.	86E-62HD	86E-62HDW	28 lbs.	62-7/16"
30"	5-6	66"	86E-66	86E-66W	23 lbs.	86E-66HD	86E-66HDW	30 lbs.	66-7/16"
32"	5-10	70"	86E-70	86E-70W	24 lbs.	86E-70HD	86E-70HDW	32 lbs.	70-7/16"
34"	6-2	74"	86E-74	86E-74W	26 lbs.	86E-74HD	86E-74HDW	33 lbs.	74-7/16"

JAMBLINER SASH STOP

Items below included in set.

Full cartons contain 16 sets per box • Each set is individually wrapped with hardware enclosed. Stocked in beige color - White available - Special order • 14° standard sill angle. Please contact your account manager for special sizes or Cottage, Carriage and Oriel windows. Refer to chart on page 136.

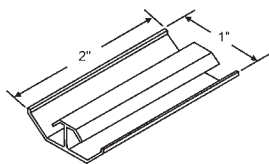

Part #	Color
86E-700BG	Beige
86E-700W	White

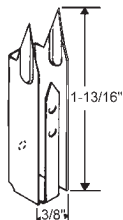

86-701BG
Beige Metal

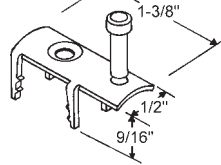

86E-600

PIVOT PINS

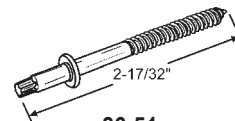

86-51
Torx Head Pivot Pin. #8x18x2
MALTA

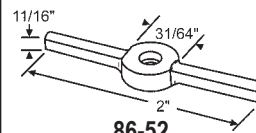

86-52
Propeller Style
MALTA

FRICITION SHOE

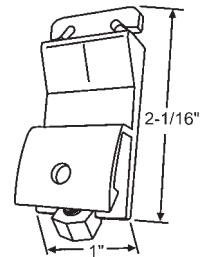

86-511
White
WENCO/JELDWEN

BALANCE SHOE

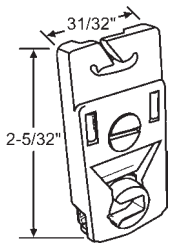

86-66
White With Tan back & Prongs

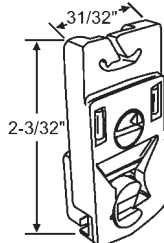

86-67
CAREFREE

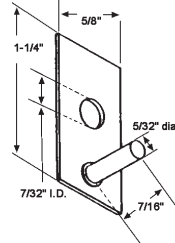

86-10
Pivot Pin

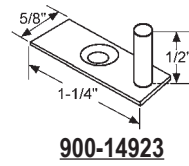

900-14923
Tilt Pin

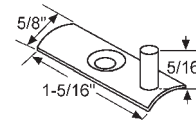

900-15114
Sash Bracket

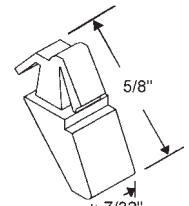

900-21058
Nylon Retainer
NEWELL

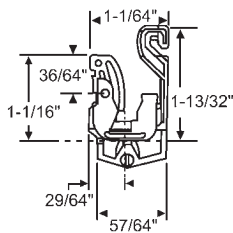

86-64A
No Longer Available.
Use 86-64A-NEW

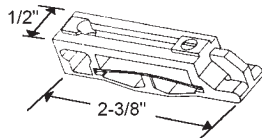

86-24
Heavy Duty Friction Shoe

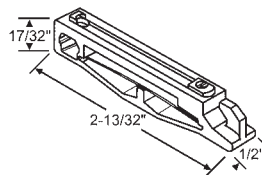

900-21068NS
White Nylon Low Tower Shoe
NEWELL

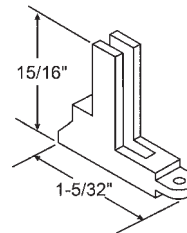

900-5713
Metal Clutch for Jambliner
MARVIN

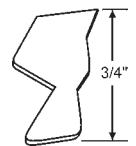

900-5713M
Metal Clutch Actuator for Jambliner
MARVIN

For Single Strength Glass 86A Series for 1-3/8" Sash

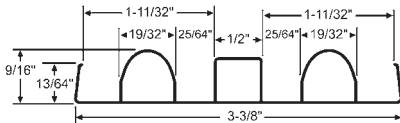
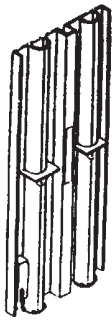

Series 86A

Jambliner Sash Stop

86-701BG
Beige Metal

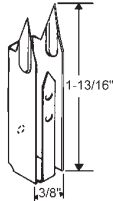

Glass Size	Opening Height	1-3/8" Part #	Maximum Sash Weight	Length to Longest Point
12"	2-6 - 30"	86A-30	7.8 lbs.	30-3/16"
14"	2-10 - 34"	86A-34	8.5 lbs.	34-3/16"
16"	3-2 - 38"	86A-38	9.2 lbs.	38-3/16"
18"	3-6 - 42"	86A-42	9.9 lbs.	42-3/16"
20"	3-10 - 46"	86A-46	10.6 lbs.	46-3/16"
22"	4-2 - 50"	86A-50	11.3 lbs.	50-3/16"
24"	4-6 - 54"	86A-54	12.0 lbs.	54-3/16"
26"	4-10 - 58"	86A-58	12.7 lbs.	58-3/16"
28"	5-2 - 62"	86A-62	13.4 lbs.	62-3/16"
30"	5-6 - 66"	86A-66	14.1 lbs.	66-3/16"
32"	5-10 - 70"	86A-70	14.8 lbs.	70-3/16"
34"	6-2 - 74"	86A-74	15.5 lbs.	74-3/16"
36"	6-6 - 78"	86A-78	15.5 lbs.	78-3/16"

Full cartons contain 20 sets per box.

Only available in beige color • 14° standard sill angle

Please contact your account manager for special sizes or Cottage, Carriage and Oriel Windows. Refer to chart on page 136.

For Insulated or Double Strength Glass 86C Series for 1-3/8" Sash

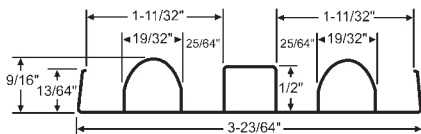
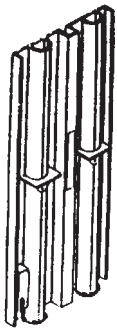

Series 86C

Jambliner Sash Stop

86-701BG
Beige Metal

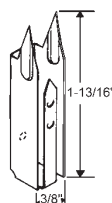

Glass Size	Opening Height	1-3/8" Part #	Maximum Sash Weight	Length to Longest Point
12"	2-6 - 30"	86C-30	11.0 lbs.	30-3/16"
14"	2-10 - 34"	86C-34	12.3 lbs.	34-3/16"
16"	3-2 - 38"	86C-38	13.5 lbs.	38-3/16"
18"	3-6 - 42"	86C-42	14.8 lbs.	42-3/16"
20"	3-10 - 46"	86C-46	16.0 lbs.	46-3/16"
22"	4-2 - 50"	86C-50	17.3 lbs.	50-3/16"
24"	4-6 - 54"	86C-54	18.5 lbs.	54-3/16"
26"	4-10 - 58"	86C-58	19.9 lbs.	58-3/16"
28"	5-2 - 62"	86C-62	21.0 lbs.	62-3/16"
30"	5-6 - 66"	86C-66	22.2 lbs.	66-3/16"
32"	5-10 - 70"	86C-70	23.5 lbs.	70-3/16"
34"	6-2 - 74"	86C-74	24.7 lbs.	74-3/16"
36"	6-6 - 78"	86C-78	26.0 lbs.	78-3/16"

Full cartons contain 20 sets per box.

Only available in beige color • 14° standard sill angle

Please contact your account manager for special sizes or Cottage, Carriage and Oriel Windows. Refer to chart on page 136.

(Brockway Smith)

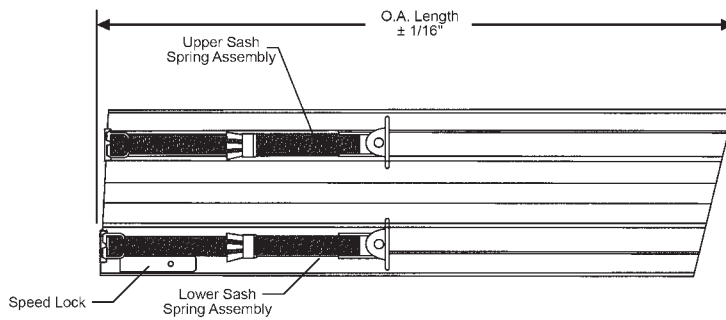
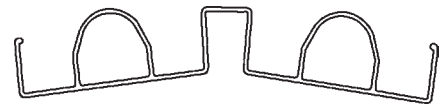
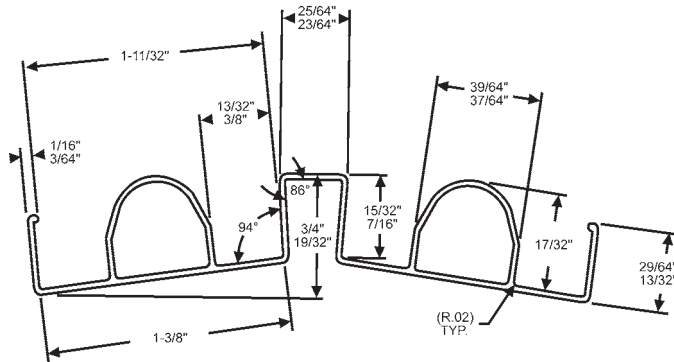

Our Part #	Unit Size	Overall Length $\pm 1/16''$	Color
86BOS-29	2-5	29-23/64"	Beige
86BOS-30	2-6	30-23/64"	Beige
86BOS-31	2-7	31-23/64"	Beige
86BOS-33	3-1	33-23/64"	Beige
86BOS-37	2-5	37-23/64"	Beige
86BOS-41	3-5	41-23/64"	Beige
86BOS-45	3-9	45-23/64"	Beige
86BOS-49	4-1	49-23/64"	Beige
86BOS-16/24	16/24 (Oriel)	45-23/64"	Beige
86BOS-18/26	18/26 (Oriel)	49-23/64"	Beige
86BOS-20/30	20/30 (Oriel)	55-23/64"	Beige
86BOS-24/16	24/16 (Oriel)	45-23/64"	Beige
86BOS-26/18	26/18 (Oriel)	49-23/64"	Beige
86BOS-30/20	30/20 (Oriel)	55-23/64"	Beige

Note: Other sizes and variations are also available. Please contact your account manager for more information

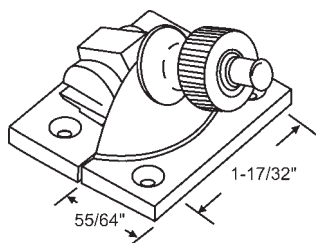

Part #	Finish
50-1096BRS	Polished Brass
50-1096CH	Chrome Plated

Spring Action. Solid Brass
MIGHTON

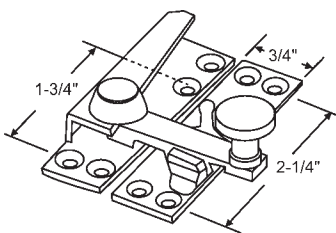

Part #	Finish
50-1097BRS	Polished Brass
50-1097CH	Chrome Plated

Solid Brass
MIGHTON

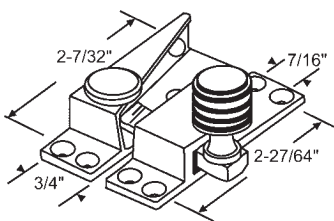

Part #	Finish
50-1098BRS	Polished Brass

Solid Brass
MIGHTON



50-443

The Model 50-443 is a traditional pattern sash lock. It is a beautifully elegant lock in polished brass with a burned finial. It is designed for use on large and heavy sash such as found in institutional or public buildings.
Base Dimensions: 1" X 3"
Strike Dimensions: 1/2" X 3"



50-445

The Model 50-445 sash lock is designed for use on the check rails of large or inaccessible double-hung sash which are to be locked and unlocked using a pole. The extended locking arm on this lock makes it especially suitable for the 1-3/4" and 2-1/4" thick sash usually found in large public or institutional buildings. It is hot-forged from solid brass and comes in a polished and lacquered finish.

Lock Base Dimensions and Strike Base Dimensions: 13/16" X 2-3/8"

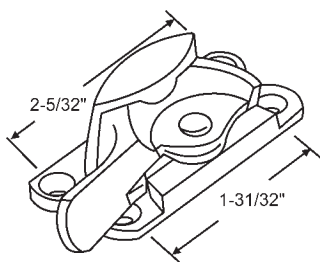

Sweep Height 11/16"

Part #	Finish
50-1099BRS	Polished Brass
50-1099CH	Chrome Plated

Solid Brass
MIGHTON

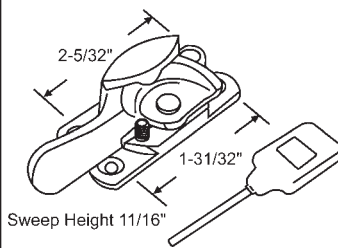

Sweep Height 11/16"

Part #	Finish
50-1100BRS	Polished Brass
50-1100CH	Chrome Plated

Solid Brass
MIGHTON

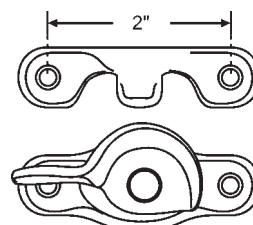

Sweep Height 5/8"

Part #	Finish
50-748	Solid Brass, Polished Lacquered
50-634A	Die Cast, Brass Plated

Includes Keeper



Part #	Finish
50-440	Lacquered Polished Brass
50-440ORBZ	Oil-Rubbed Bronze
50-440PNK	Polished Nickel
50-440SNK	Satin Nickel

The Model 50-440 is a new sash lock developed to combine the best features of traditional spring action locks with an updated narrow strike. No effort has been spared to make the 50-440 the finest, most durable sash lock of its type. The quality of finish and smoothness of function are without equal. All components of this lock are hot-forged brass and stainless steel, precisely machined and hand polished.

Base Dimensions: 1" X 2-7/8"

Strike Dimensions: 7/16" X 2-7/8"

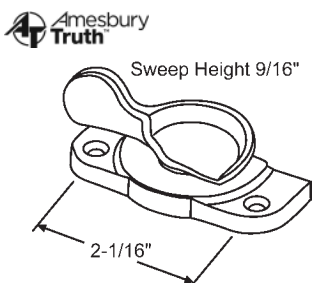

Sweep Height 9/16"

Part #	Finish
50-471-1	Bronze
50-471-5	Brass Plated
50-471-71	Oil-Rubbed Bronze

Zinc die cast Restoration lock.
Screws not included.

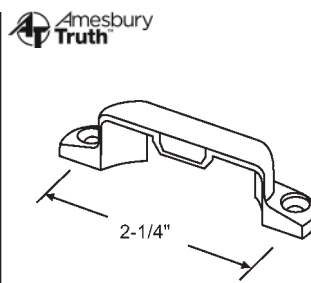

2-1/4"

Part #	Finish
50-472-1	Bronze
50-472-5	Brass Plated
50-472-71	Oil-Rubbed Bronze

Zinc die cast Keeper.
Screws not included.

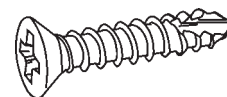

Part #	Finish
20-109-1	Bronze

Screws for 50-471 Sash Lock and 50-472 Keeper

LIFTS & PULLS

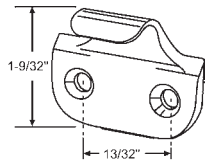

Part #	Finish
50-475-5	Brass Plated
50-475-13	Brushed Copper Nickel
50-475-71	Oil-Rubbed Bronze
50-475-72	Brushed Chrome
50-475-3	White

Includes Two Screws
Zinc Die Cast

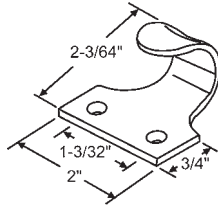

Part #	Finish
50-1101BRS	Polished Brass
50-1101CH	Chrome Plated

Solid Brass
MIGHTON



50-461

The Model 50-461 and 50-462 are hook-type sash lifts based on traditional patterns. They are used singly on sash up to 2 feet wide and in pairs on larger sash. Both lifts are solid, hot-forged brass, hand polished.

Dimensions: 3/4" w X 1-3/8" h X 1" d
Dimensions: 1" w X 1-3/4" h X 1-1/4" d



50-462

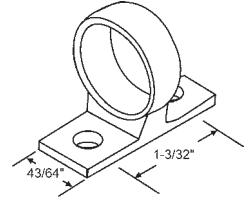

Part #	Finish
50-1102BRS	Polished Brass
50-1102CH	Chrome Plated
50-1102SCH	Satin Chrome

Solid Brass Ring Pull
MIGHTON

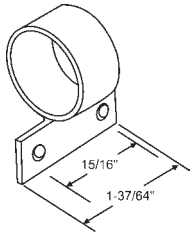

Part #	Finish
50-1103BRS	Polished Brass
50-1103CH	Chrome Plated
50-1103SCH	Satin Chrome

Solid Brass Ring Pull
MIGHTON

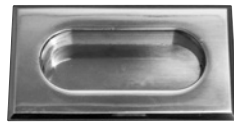

50-449

The Model 50-449 is a flush sash lift based on a traditional pattern. It is used singly on sash up to 2 feet wide and in pairs on larger sash. It is hot-forged from solid brass and hand polished.

Dimensions: 1-3/4" X 3-1/8"



50-451

A solid cast brass handle type sash lift in a traditional pattern. The off-set design improves hand clearance between the handle and window stool, especially when width is limited. Used singly on sash up to 2 feet wide and in pairs on larger sash.

Dimensions: 15/16" X 4-1/4"

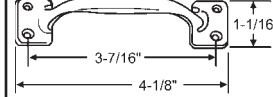

50-455-1

Solid Brass
Bright Brass Finish
with Screws

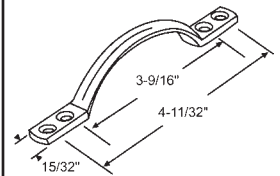

Part #	Finish
50-1104BRS	Polished Brass

D Handle w/Square Edge (shown)

Part #	Finish
50-1104CH	Chrome Plated

Solid Brass D Handle w/Round Edge
MIGHTON

BRASS/STEEL PULLEYS

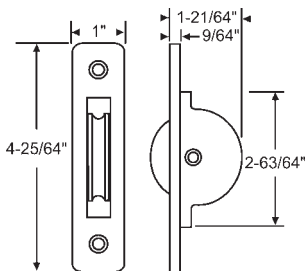

Square Corners - 2 Hole

Part #	Body Material	Body Shape	Face Plate	Wheel Type/Size	Max Load Capacity
96-MT3	Steel Body	Square Corners	Brass	1-3/4" Nylon	55 lbs.
96-MT5	Steel Body	Square Corners	Brass	1-3/4" Brass	55 lbs.
96-MT7	Steel Body	Square Corners	Plated Steel	1-3/4" Nylon	55 lbs.
96-MT9	Steel Body	Square Corners	Plated Steel	1-3/4" Brass	55 lbs.
96-MT11	Steel Body	Square Corners	Chrome Plated Brass	1-3/4" Chrome Plated Brass	110 lbs.

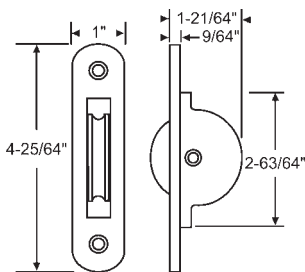

Rounded Corners - 2 Hole

Part #	Body Material	Body Shape	Face Plate	Wheel Type/Size	Max Load Capacity
96-MT4	Steel Body	Round Corners	Brass	1-3/4" Nylon	55 lbs.
96-MT6	Steel Body	Round Corners	Brass	1-3/4" Brass	55 lbs.
96-MT8	Steel Body	Round Corners	Plated Steel	1-3/4" Nylon	55 lbs.
96-MT10	Steel Body	Round Corners	Plated Steel	1-3/4" Brass	55 lbs.
96-MT12	Steel Body	Round Corners	Chrome Plated Brass	1-3/4" Chrome Plated Brass	110 lbs.

BRASS/STEEL PULLEYS

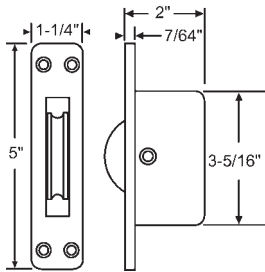

Square Corners - 4 Hole

Part #	Body Material	Body Shape	Face Plate	Wheel Type/Size	Max Load Capacity
96-MT13	Steel Body	Square Corners	Chrome Plated Brass	2" Chrome Plated Brass Ball Bearing	176 lbs.
96-MT15	Steel Body	Square Corners	Chrome Plated Brass	2-1/4" Chrome Plated Brass Ball Bearing	176 lbs.
96-MT17	Steel Body	Square Corners	Brass	2" Brass Ball Bearing	176 lbs.
96-MT19	Steel Body	Square Corners	Brass	2-1/4" Brass Ball Bearing	176 lbs.
96-MT22	Steel Body	Square Corners	Stainless Steel	2" Stainless Steel	55 lbs.

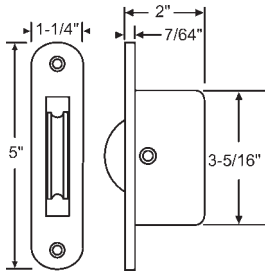

Round Corners - 2 Hole

Part #	Body Material	Body Shape	Face Plate	Wheel Type/Size	Max Load Capacity
96-MT14	Steel Body	Round Corners	Chrome Plated Brass	2" Chrome Plated Brass Ball Bearing	176 lbs.
96-MT16	Steel Body	Round Corners	Chrome Plated Brass	2-1/4" Chrome Plated Brass Ball Bearing	176 lbs.
96-MT18	Steel Body	Round Corners	Brass	2" Brass Ball Bearing	176 lbs.
96-MT20	Steel Body	Round Corners	Brass	2-1/4" Brass Ball Bearing	176 lbs.

POLYSASH PULLEYS

SASH CHAIN



96-P1

The Model 96-P1 is a larger, redesigned version of our popular ball bearing sash pulley. It has been designed to meet the needs of custom high-end window fabricators building large and heavy sash. The Model 96-P1 features a hot forged solid brass 1-1/8" x 5-7/16" radius end faceplate, 2-1/2" solid brass precision turned pulley wheel for chain or cord, and a sealed ball-bearing for many years of smooth operation. The standard finish is satin lacquered. Faceplate Dimensions: 1-1/8" x 5-7/16" Housing Dimensions: 2-3/16" x 3-1/4" x 3/4"

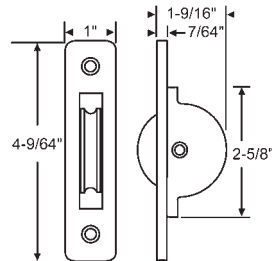

96-MT1

Polyethylene Body, Square Corners, 1-3/4" Nylon Wheel. 2 Holes
Max Load Capacity = 20 lbs.

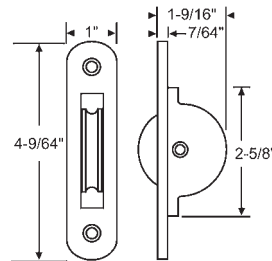

96-MT2

Polyethylene Body, Round Corners, 1-3/4" Nylon Wheel. 2 Holes
Max Load Capacity = 20 lbs.



Part #	Weight
96-805	Up to 70 lbs.
96-806	Up to 165 lbs.

Steel Chain w/Copper Rivets Only. Order Connectors Separately. 50' Rolls

MIGHTON

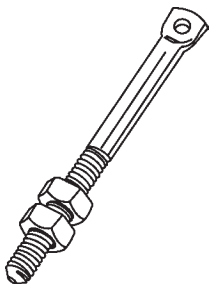

96-807

Weight Connector for Riveted Chain

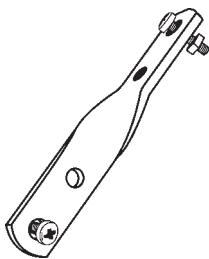

96-808

Sash Connector for Riveted Chain



96-708

Spiral Clip. Fits into 7/8" diameter hole bored into side of sash stile. Threads onto the end of sash chain. Plated steel.

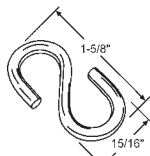

96-709

S Hook. Used for attaching chain to stackable counter weights. Plated steel

Sash Chain is preferred over sash cord in instances where greater longevity is required such as in high quality residential construction, restoration work, and public buildings. Our solid bronze, solid brass, and stainless steel sash chains will give many years of reliable service.

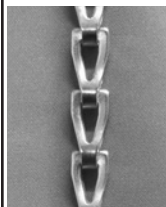

96-701

#45 Solid Bronze Load Limit 160 lbs. 150' per roll.

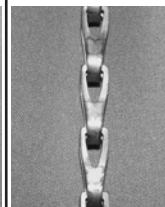

96-702

#25 Solid Bronze Load Limit 80 lbs. 100' per roll.

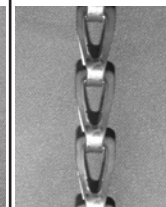

96-706

#35 Stainless Steel Load Limit 225 lbs. 100' per roll.

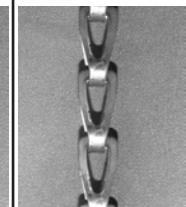

96-810

#45 Stainless Steel Load Limit 320 lbs. 100' per roll.

SASH CORDS & ACCESSORIES

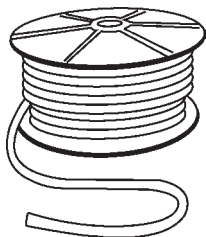

Our pre-stretched, premium waxed cotton sash cord has an inner synthetic-stranded cord for increased strength and flexibility. The outer covering of plaited waxed and polished premium grade cotton is designed specifically for use with pulley systems and will give many years of smooth and trouble-free performance.



Part #	Length
96-802	65' Roll
96-803	164' Roll
96-804	328' Roll

Load Limit 220 lbs.
1/4" Nylon Cord
MIGHTON

Part #	Size	Load	Length
96-704	#8 (1/4")	100 lbs.	100'
96-705	#10 (5/16")	200 lbs.	100'
96-710	#4 (1/8")	20 lbs.	600'

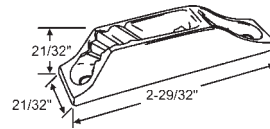

Grabba is an essential piece of kit in the joiners' armory.

- One man operation
- No need for hammer or nails
- Simple sash cord adjustment
- Faster fitting time
- Neat appearance

On bigger windows, where a sash weight is over 22 lbs, there will still be a need to pin the cord.

96-809
Black Plastic

SASH COUNTERWEIGHTS

Our 96 series stackable cast iron counterweights are designed to economically facilitate the balancing of sash in weight and pulley windows. The 1/2" through-hole permits their use with either rope or chain. The square and radius cross-section provides more weight per inch than conventional round weights, essential when dealing with heavier glazing or insulating glass. The 1 lb., 3 lbs., and 5 lbs. sizes permit flexibility and precision in attaining a proper balance. They are suitable for 1-3/4" or larger sash in either new construction or retrofit.



Part #	Weight	Height
96-700-5	5 lbs.	7-7/8"
96-700-3	3 lbs.	5-1/8"
96-700-1	1 lb.	2-3/8"

ACCESSORIES

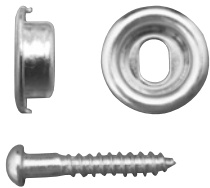

Part #	Finish
19-321	Solid Brass
19-321ORBZ	Oil Rubbed Bronze

Stop Bead Adjuster
A solid brass stop bead adjuster for mounting removable window stops. The slotted screw hole permits 1/8" of lateral adjustment. They are supplied in boxes of 50 pieces with accompanying #8 x 1" wood screws.

SPRING BOLTS



19-317

The Model 19-317 is a surface mounted window spring bolt designed for holding a vertical or horizontal sliding sash in either an open or closed position. The spring plunger may be locked into its fully retracted position by a simple rotation of the spherical knob. The window spring bolt is especially suited for retrofitting to older windows lacking balance systems or to any sash requiring a multi-position lock. The Model 19-317 is precision extruded and machined from solid brass and hand polished. Three strike plates are furnished with each lock. Base Dimensions: 1-1/8" x 1-1/4" Strike Dimensions: 5/8" x 1-7/16"



19-318

The Model 19-318 is a solid brass window spring bolt designed for installation in the wood stile of a vertically sliding sash. This type of hardware is commonly used in pairs on light weight, single hung sash in lieu of a balance system or sash lock, and is designed to be press-fit into a 3/8" diameter hole bored through the sash stile. A hole to accept the spring plunger is then bored in the window jamb to hold the sash at any desired height. The Model 19-318 is precision turned solid brass with a stainless steel spring. Housing Dimensions: 1-7/8" x 3/8" Overall Length: 3-3/8"



39-572

The Model 39-572 pole hook and Model 39-573 pole hook socket are intended to facilitate the operation of large or inaccessible double-hung windows. The pole hook is designed to be mounted on the end of a wooden operating pole of an appropriate length. The 39-573 pole socket is easily mounted in the sash rail, requiring only the boring of a 1" diameter hole. Both items are solid cast brass with a polished and lacquered finish.

Model 39-572 Dimensions:
4"L x 7/8" I.D.

Model 39-573 Dimensions:
1-1/4" x 2-1/4"



39-573

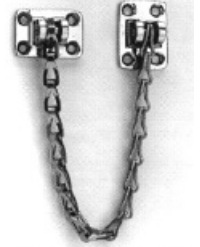

19-320

The Model 19-320 transom chain is designed to limit the opening of transom sash or other bottom hinged windows. The chain brackets are solid, polished and lacquered brass. The 12" chain is solid bronze.

Base Dimensions:
1-3/16" x 1" x 11/16"

VENT LOCKS

Key Operated Vent Lock

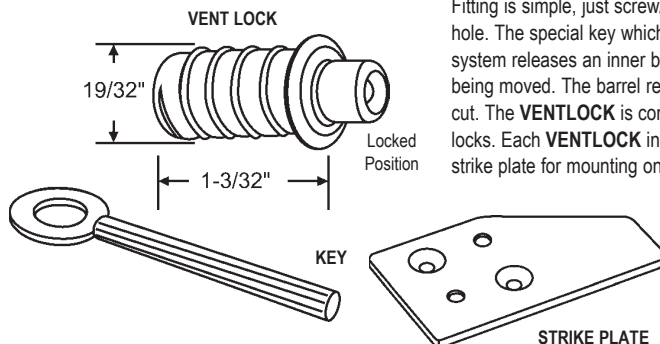

The new innovative **VENTLOCK** acts as a major deterrent to snatch thieves who spot what they consider is an easily opened window. Fitting is simple, just screw/insert it into the appropriate diameter drill hole. The special key which is supplied as part of the **VENTLOCK** system releases an inner barrel which prevents the window from being moved. The barrel revolves freely preventing it from being cut. The **VENTLOCK** is competitively priced against existing window locks. Each **VENTLOCK** includes a steel operation key and a brass strike plate for mounting on the lower sash check rail.

Part #	Finish
50-446	Solid Brass
50-446CH	Chrome

Vent Lock with Key and Strike
MIGHTON

MEETS: ASTM F 2090 Standard Specification for Window Fall Prevention Devices With Emergency Escape (Egress) Release Mechanisms

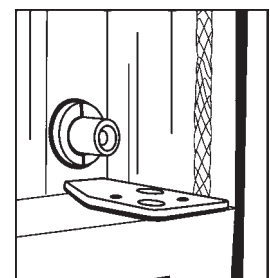

Open Position Shown

Push and Twist Keyless Vent Lock Finger Operated: Push and Turn with Your Finger

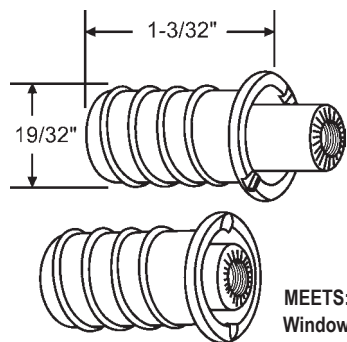

The natural companion product to Key Operated Ventlocks. Use where Fire Egress may be of concern or above ground floor level.

Part #	Finish
50-1201CH	Chrome
50-1201BRS	Solid Brass

Push and Twist Ventlock. Solid Brass
MIGHTON

MEETS: ASTM F 2090 Standard Specification for Window Fall Prevention Devices With Emergency Escape (Egress) Release Mechanisms

Brass Vent Lock for PVC Vinyl Windows

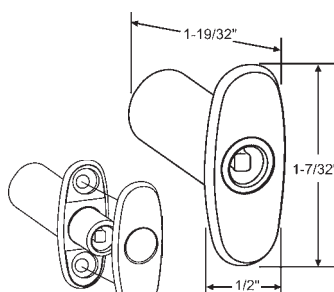

Ventlock is Quick and Easy to Install

1. Drill Hole
2. Insert Ventlock
3. Drill Rivet Holes
4. POP Rivet Ventlock into the Sash
5. Conceal Rivets with Self Adhesive Trims

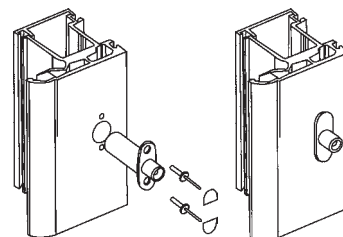

50-1106

Vent Lock for PVC Vinyl Windows
Includes Key
MIGHTON

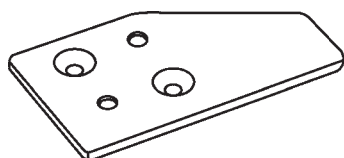

Part #	Finish
50-1105BRS	Solid Brass
50-1105CH	Chrome
50-1105SCH	Satin Chrome

Vent Lock Strike Plate Only
MIGHTON

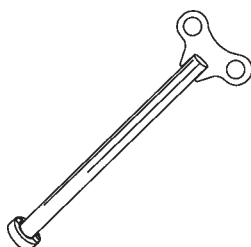

59-73M

Ventlock Hand Tool
MIGHTON

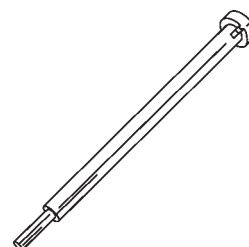

59-73

Ventlock Tool for Cordless Drill
MIGHTON

CASEMENT HARDWARE



Part #	Hand
34-79RH	Shown
34-79LH	Opposite

The Model 34-79 casement fastener is hot-forged solid brass and hand polished. Available either right or left-handed.

Base Dimensions:
11/16" X 2-3/8"

Handle: 2"

Overall Depth: 1-1/4"
Strike sold separately.



Part #	Hand
34-77RH	Shown
34-77LH	Opposite

The newly redesigned Model 34-77 casement fastener is hot-forged from solid brass and hand polished. Available either right or left-handed.

Base Dimensions: 11/16" X
2-3/8"

Handle: 3-1/2"

Overall Depth: 1-7/8"
Strike sold separately.



50-453



50-454



50-463



50-464

Strike Plates for Casement Fasteners

Part #	Description
50-453	Mortise Strike
50-454	Surface Strike
50-463	Rim Strike
50-464	Angle Strike (for use on windows with compression weatherstripping)

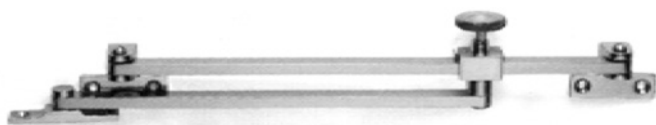

29-204

(Out-Swing Shown/Brackets Invert for In-Swing)

The model 29-204 is a 12-1/2" solid polished brass slide-bar type adjuster for wood in-swing or out-swing windows. Based on a traditional pattern, this beautifully made casement adjuster is designed so as not to interfere with hinged or rolling interior screens whether in the open or closed position. For universal (left or right hand) operation.

Overall Length: 12-1/2"

Overall Height: 2-3/8"

Overall Depth: 1-3/8"

CASEMENT HARDWARE



29-205

The Model 29-205 sliding rod casement adjuster is a highly finished version of a traditional American pattern. It is designed for use on out-swing hinged windows. The 29-205 is hot-forged and precision machined from solid brass and hand polished. Base Dimensions: 15/16" X 2-3/8"
Overall Length: 13-1/2"
Overall Height: 2"



29-206

The Model 29-206 telescopic friction casement stay is a highly finished, heavy-duty version of a pattern common to early 20th century casement windows. It is designed for installation on all types of out-swinging hinged sash. The degree of friction may be adjusted by means of the large brass nut at the barrel end. The 29-206 is offered in solid brass, with a hand polished and lacquered finish.

SCREEN HARDWARE



Part #	Finish
17-155	Polished Lacquered
17-155SNK	Satin Nickel

The newly redesigned Model 17-155 is a solid brass screen or storm door latch set. The lock case, escutcheon plate and strike are hot-forged and precision machined for smooth operation. The spring mechanism is stainless steel. The lever and threaded spindle are hot-forged in one piece for added strength, and the knob is turned from brass bar stock. The latch set is supplied with an angle strike and a rim strike. Backset is 1-9/16". The threaded spindle allows easy adjustment for door thicknesses of 1-1/8" to 1-3/4". Thinner doors can be accommodated by cutting the spindle. Dimensions: Case 2-1/4" X 2"
Back Plate 1-1/4" X 4" Knob 1-5/8" dia.
Overall Depth: Lever side 1-7/16" Knob side 1-1/2"

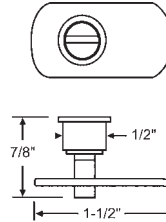

19-319

The Model 19-319 cam fastener is a solid brass assembly designed to fasten wood storm or screen inserts into a combination door or other frame. The standard finish is unlacquered.

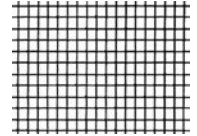

Part #	Size
69-29BR	24" x 100'
69-65BR	36" x 100'
69-77BR	48" x 100'

Bronze Insect Screening

Our heavy-duty solid bronze insect screening is designed for fabrication of high quality window screens and screen doors. It is woven of .011" solid bronze wire into an 18 X 14 mesh.

PARTING BEAD

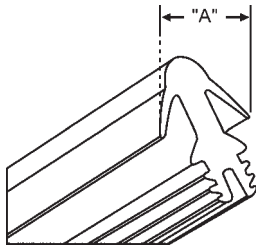

One-piece parting bead that weather-strips both top and bottom sashes. The fins are almost undetectable when installed. Will never rot. Made from UV-stabilized PVC. Simple to install. Can be used on new construction or restoration. Takes the rattle out of old sash windows. Severe weatherproof rating.

Part #	Color	Length	"A"
63-330	White	94-1/2"	15/32"
63-332	White	94-1/2"	5/8"

Minimum Order - 10 Lengths
MIGHTON

BRUSH SEAL

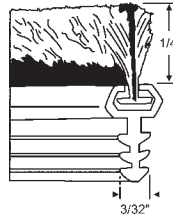

Part #	Color	Length
63-336	White	86-3/4"

Minimum Order - 10 Lengths
MIGHTON

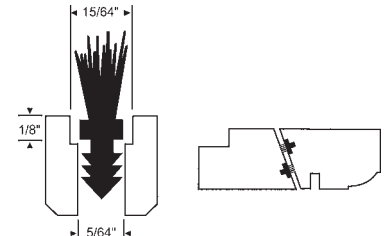

Simple to Install. Low friction pile with single polypropylene fin which provides 50% easier sash movement while providing maximum resistance to air and water penetration. Long life performance.

WEATHERSTRIP

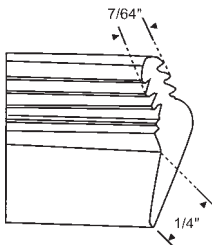

Part #	Finish	Length
63-334	White	94-1/2"
63-335	Brown	94-1/2"

Standard Weatherstrip
Minimum Order - 10 Lengths
MIGHTON

MINI GROOVER

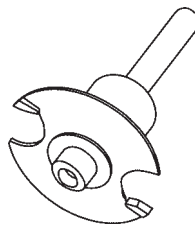

59-74

Mini Groover for Standard Weatherstrip 63-334 & 63-335 Requires 1/4" Chuck.
MIGHTON

HINGES

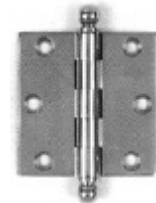

Part #	Size
19-322	3" x 3"
19-323	3-1/2" x 3-1/2"
19-324	4" x 4"

Our 19 series polished brass butt hinges are designed for use on wood casement windows and doors. The hinge body is precision extruded brass, .125" thick, and has removable ball tips. The finish is hand polished and lacquered. Sold in pairs.

WINDOW REPLACEMENT HARDWARE

SWEEP LOCKS & SASH LOCKS



Innovative and Intuitive!

The Roto Flip Lock is an automatic sash lock for single hung, double hung, and sliding windows that's easy to install, easy to operate, and highly intuitive. Flip Lock's excellent balance and durability combined with its intuitive and sleek design, provides you with a superior lock while providing your customers with great comfort, convenience and security.

Features

- The positive action lock, once unlocked and the sash is opened, resets itself and then locks automatically when the sash is closed
- Innovative functionality that makes operation of the lock ergonomically- friendly
- Internal mechanism has two springs to maintain balance
- Four mounting positions
- Unique Breakaway feature - flip lever will stay up unless completely closed
- Meets or exceeds forced entry resistance requirements and hurricane impact testing

Benefits

- Ease of operation and peace of mind knowing that once the window is closed, it is locked
- In the case of arthritic conditions, the lock can be operated with a slim device thus not requiring extensive movement of one's fingers
- Enhanced durability/cycle performance, reliable, consistent functionality
- Ultimate flexibility to position the lock correctly on various profiles
- Acts as a visible indicator that the window is not completely closed, thus not locked
- Adds vital elements of security and strength to the overall performance of the window

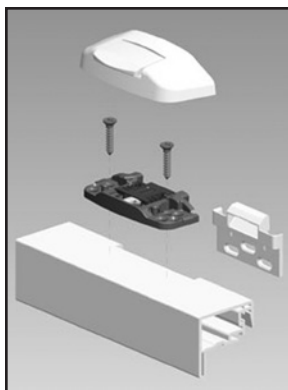

Flip Lock Mechanism

Part Number
50-1326



Face Mount Striker

Part Number	Color
50-1328W	White
50-1328BEW	Blue White
50-1328EB	Earth Brown
50-1328AD	Almond
50-1328ADMK	Dark Almond/Beige



Surface Mount Striker

Part Number	Color
50-1327W	White
50-1327BEW	Blue White
50-1327EB	Earth Brown
50-1327AD	Almond
50-1327ADMK	Almond MK
50-1327AG	Adobe



Flip Lock Cover Assembly

Part Number	Color
50-1325W	White
50-1325BEW	Blue White
50-1325EB	Earth Brown
50-1325AD	Almond
50-1325ADMK	Dark Almond/Beige



Installation Jig

Part Number
59-82

SWEEP LOCKS & SASH LOCKS

In order by mounting hole width (single hole locks first).

Single Hole

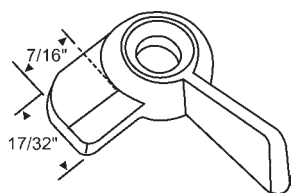

Part #	Finish
900-7277	Unfinished

Zinc Die Cast

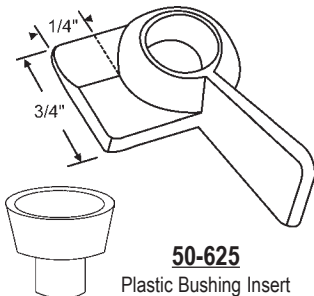

50-625

Plastic Bushing Insert

Lock only

Part #	Hand	Finish
50-624RH	Shown	Brite
50-624LH	Opposite	Brite

Lock with Bushing and Screw

Part #	Hand	Finish
50-624RHA	Shown	Brite
50-624LHA	Opposite	Brite

Zinc Die Cast

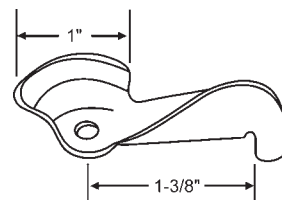

Part #	Hand
50-604	Shown

Stamped Steel

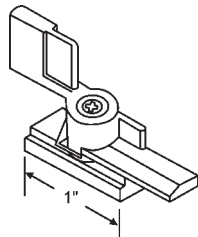

Part #	Finish
50-715	Unfinished

Zinc Die Cast

CROSSLY

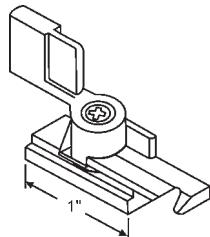

Part #	Finish
50-715HA	Unfinished

Zinc Die Cast with Hook

CROSSLY

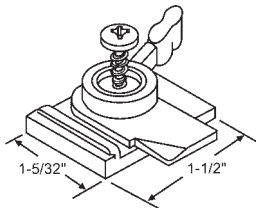

Part #	Hand	Finish
50-619RHA	Shown	White
50-619LHA	Opposite	White

Plastic

THERMALGARD

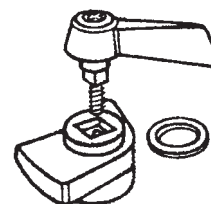

Part #	Finish
50-1127	Black

Slider Latch. Short

HARCAR

WINDOW REPLACEMENT HARDWARE

SWEEP LOCKS & SASH LOCKS

In order by mounting hole width (single hole locks first).

3/4"

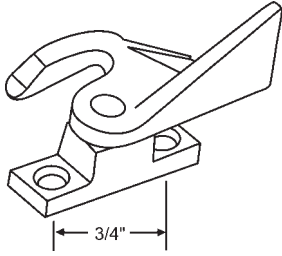

Part #	Finish
50-610	Unfinished

Zinc Die Cast. Use with 50-611 Keeper.
PORTALUME

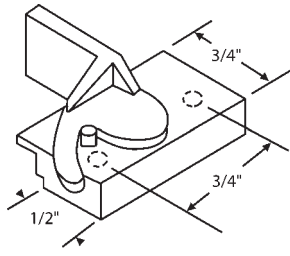

Part #	Hand	Finish
50-705	Shown	Unfinished
50-704	Opposite	Unfinished

Zinc Die Cast
CROSSLY

7/8"

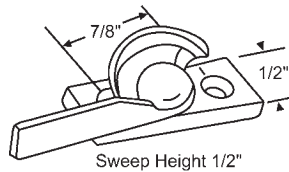

Part #	Hand	Finish
50-637	Shown	Brite
50-638	Opposite	Brite
50-637BR	Shown	Bronze
50-637-10	Shown	Black

Zinc Die Cast. Use with 50-643 Keeper.
STANLEY

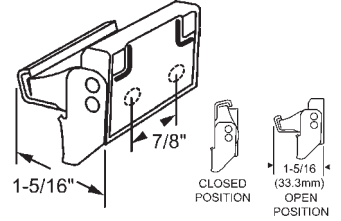

Part #	Finish
50-355-1	Bronze
50-355-2	Gold
50-355-3	White
50-355-10	Black

Check Rail Lock

1"

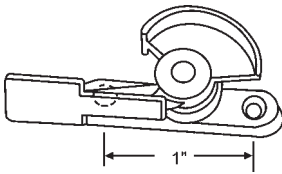

Part #	Finish
50-711	Unfinished

Zinc Die Cast. Use with 50-701 Keeper.

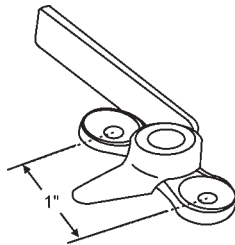

Part #	Finish
900-41WB	White Bronze

Bronze Casting
UALCO

1-1/4"

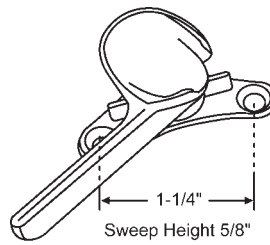

Part #	Finish
50-641	Brite

Zinc Die Cast.
KINCO

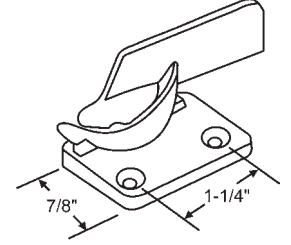

Part #	Finish
50-645	Brite

Zinc Die Cast. Use with 50-646 Keeper.
SEASONALL

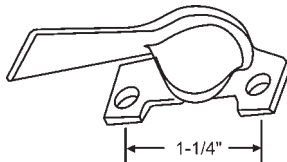

Sash Lock and Keeper

Part #	Finish
50-608A	White Bronze

Sash Lock Only

Part #	Finish
50-651	White Bronze

Bronze Casting. Use with 50-609WB Keeper.

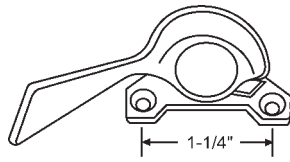

Sweep Height 7/16"

Part #	Finish
50-671	White Bronze

Bronze Casting
Use with 900-8505 Keeper.

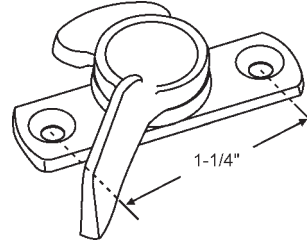

Part #	Finish
50-678	Brite

Die Cast
RUSCO

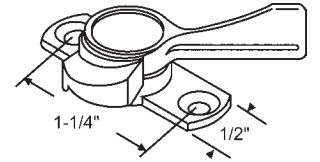

Part #	Finish
50-783B	Black

Height Graduates from 9/32" to 3/8" Max.
Zinc Die Cast
RUSCO

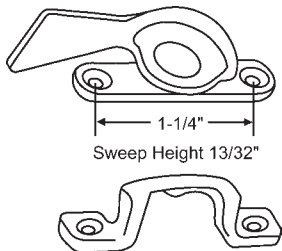

Sweep Height 13/32"

Part #	Finish
50-655A	White Bronze

Bronze Casting. Includes Keeper

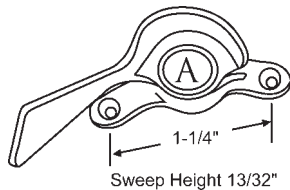

Sweep Height 13/32"

Part #	Finish
50-718A	White Bronze

Sash Lock and Keeper
Bronze Casting. Use with 50-709 Keeper.
ALWINSEAL

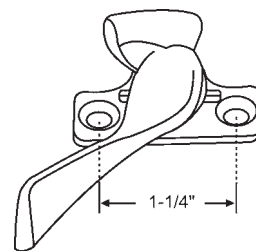

Part #	Finish
900-7267	White Bronze

Bronze Casting
WINDOW MASTER

1-5/16"

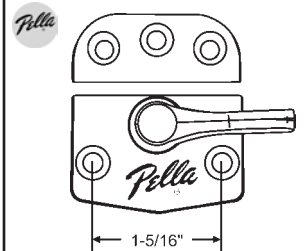

Part #	Finish
50-233	Copperite
50-233CHP	Champagne

Zinc Die Cast. With Keeper and Shim

WINDOW REPLACEMENT HARDWARE

SWEEP LOCKS & SASH LOCKS

In order by mounting hole width (single hole locks first).

1-3/8"

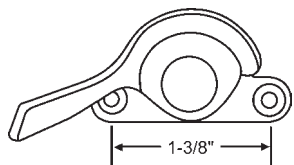

1-3/8"

Part #

900-8503X

Zinc Die Cast. Sweep Height 7/16"
White Bronze Look

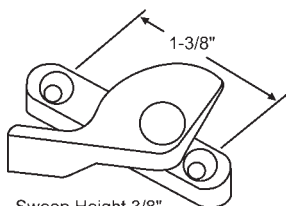

1-3/8"

Sweep Height 3/8"

Part #

50-698

Finish

Unfinished

Zinc Die Cast

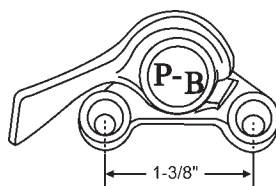

1-3/8"

Part #

900-9158

Finish

White Bronze

Bronze Casting. Sweep Height 3/8"

1-1/2"

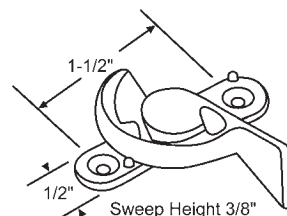

1-1/2"

1/2"

Sweep Height 3/8"

Part #

50-607

Finish

Unfinished

Zinc Die Cast
KELLER

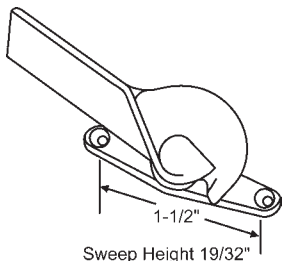

1-1/2"

Sweep Height 19/32"

Part #

50-614

Hand

Shown

Finish

Brite

50-614RH

Opposite

Brite

Zinc Die Cast
PAN AM

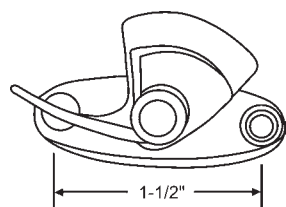

1-1/2"

Part #

50-627

Finish

Brite

50-627B

Bronze

Zinc Die Cast
KELLER

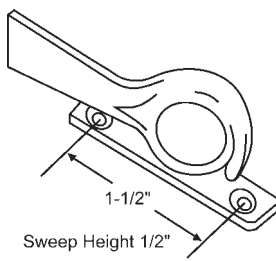

1-1/2"

Sweep Height 1/2"

Part #

50-654

Finish

White Bronze

Bronze Casting
Use with 900-9151 Keeper.

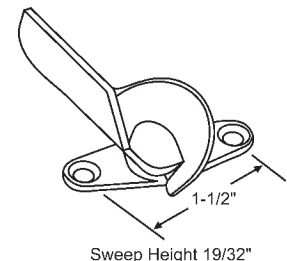

1-1/2"

Sweep Height 19/32"

Part #

50-662

Finish

Brite

Zinc Die Cast

1-17/32"

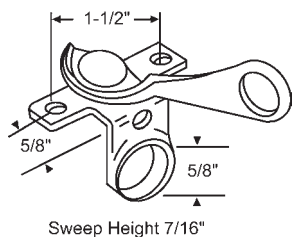

1-1/2"

5/8"

5/8"

Sweep Height 7/16"

Part #

50-653

Finish

White Bronze

Bronze Casting

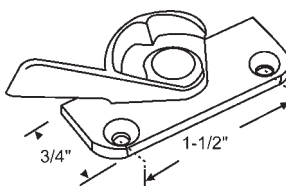

3/4"

1-1/2"

Part #

900-40

Finish

Unfinished

Zinc Die Cast
UALCO

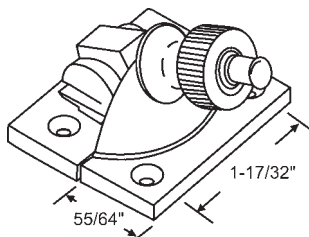

55/64"

1-17/32"

Part #

50-1096BRS

Finish

Polished Brass

Brighton Style Sash Lock and Keeper.
Spring Action. Solid Cast Brass

MIGHTON

50-1096CH

Chrome Plated

1-5/8"

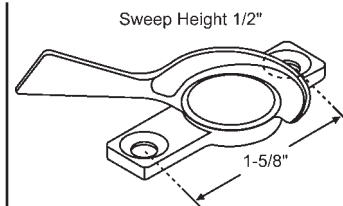

Sweep Height 1/2"

1-5/8"

Part #

50-689

Finish

White Bronze

Bronze Casting. Use with 50-690 Keeper

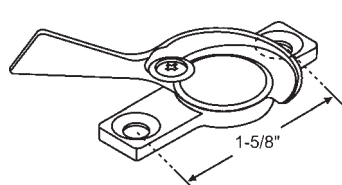

1-5/8"

Part #

50-689S

Finish

White Bronze

with Security Screw

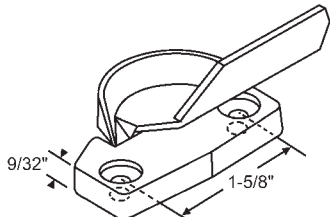

9/32"

1-5/8"

Part #

900-10803LH

Hand

Shown

Finish

Brite

900-10803RH

Opposite

Brite

Zinc Die Cast. Use with 50-800 Keeper.
NUPRIME/SEASONALL

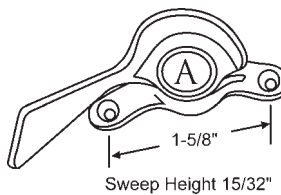

1-5/8"

Sweep Height 15/32"

Part #

50-710

Finish

White Bronze

Bronze Casting. Use with 50-709 Keeper.

ALWINSEAL

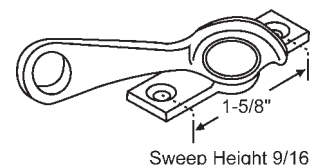

1-5/8"

Sweep Height 9/16"

Part #

900-6706

Hand

Shown

Finish

White Bronze

Bronze Casting. Sweep Height 9/16"

TRACO

WINDOW REPLACEMENT HARDWARE

SWEEP LOCKS & SASH LOCKS

In order by mounting hole width (single hole locks first).

1-11/16"

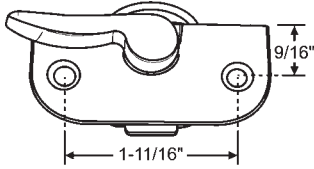

Part Number	Finish
50-2028AB	Antique Brass
50-2028BG	Beige
50-2028BRS	Brass
50-2028DBZ	Dark Bronze
50-2028SNK	Satin Nickel
50-2028W	White

Recessed Sash Lock
UNITED WINDOW & DOOR

1-21/32"

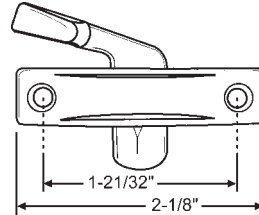

Part #	Finish
50-849B	Black

Zinc Die Cast. Screws #70605B

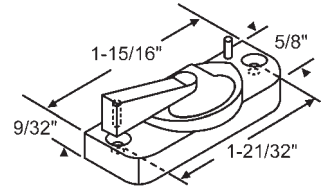

Sweep Height 15/32"

Part #	Finish
50-863	Unfinished

Zinc Die Cast
AMCO

1-3/4"

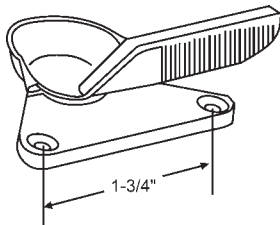

Part #	Hand	Finish
50-612-30R	Shown	Antique Copper
50-612-30L	Opposite	Antique Copper

Zinc Die Cast
FIBERLUX/REMINGTON

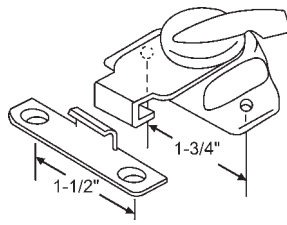

Part #	Finish
50-658A	Chrome Plated
50-658B	Brass Plated

Stamped Steel. Includes Keeper

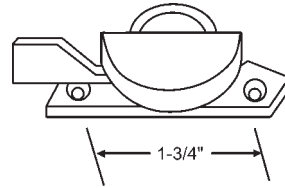

Part #	Finish
50-676	Brite

Zinc Die Cast. Use with 50-643 Keeper.

1-13/16"

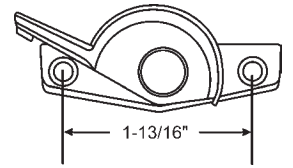

Part #	Finish
50-681	Black

Zinc Die Cast
CROFT

1-7/8"

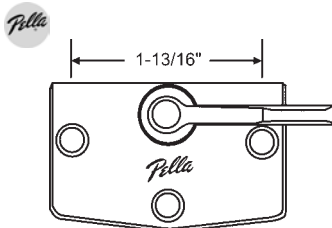

Part #	Finish
50-213CHP	Champagne
50-213BP	Brass Plated

Zinc Die Cast. Use with 50-363 Keeper.

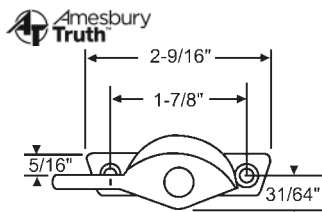

Part #	Finish
50-360-1	Bronze

Low Profile Cam Lock
Zinc Die Cast. Use with Keeper 50-361-1.

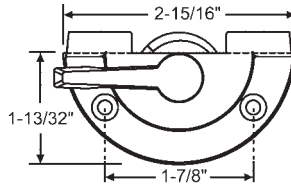

50-1269W
White
ATRIUM

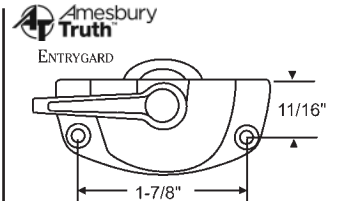

Part #	Finish
50-369-1	Bronze
50-369-3	White
50-369-28	Almond
50-369-8	Chestnut Bronze

Zinc Die Cast. Use with Keepers
50-374-Color and 50-372-Color.

1-31/32"

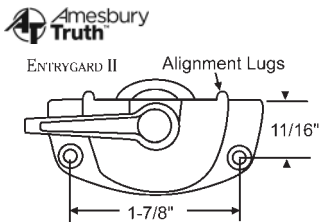

Part #	Finish
50-842-1	Bronze
50-842-3	White

Zinc Die Cast Use with Keepers 50-379-Color, 50-740-Color, 50-373-Color and 50-372-Color.

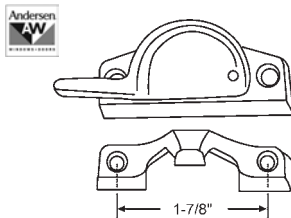

Part #	Finish
750-1630108	Stone

Sash Lock Set (2 Locks, 2 Keepers). Old Style was Zinc Die Cast, New Style is Plastic.

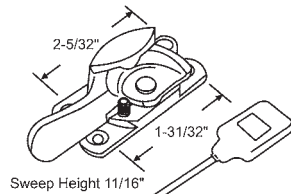

Security Sash Lock and Keeper

Part #	Finish
50-1100BRS	Solid Brass
50-1100CH	Chrome

Solid Cast Brass.

Part #	Description
50-1100SS	Stainless Steel

MIGHTON

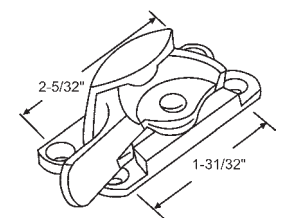

Sweep Height 11/16"

Part #	Finish
50-1099BRS	Solid Brass
50-1099CH	Chrome

Sash Lock and Keeper. Solid Cast Brass

MIGHTON

WINDOW REPLACEMENT HARDWARE

SWEEP LOCKS & SASH LOCKS

In order by mounting hole width (single hole locks first).

2"

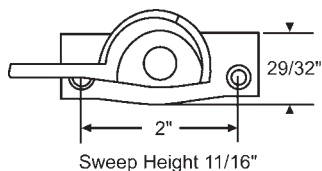

Part #	Finish
50-356-1	Bronze

Zinc Die Cast. Use w/Keeper 50-357-Color or Beveled Keeper 50-358-Color.

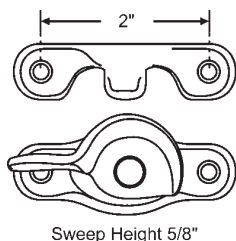

Part #	Finish
50-634A	Zinc Die Cast, Brass Plated
50-748	Solid Brass, Polished Brass

Includes Keeper

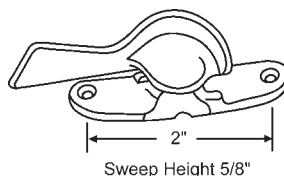

Part #	Finish
50-669	White Bronze

Bronze Casting

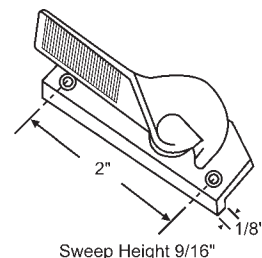

Part #	Finish
900-18881	White

Zinc Die Cast. Sweep Height 9/16"

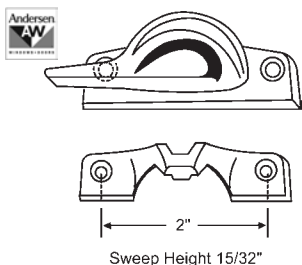

Part #	Finish
750-1630020	Stone

Old Style was Zinc Die Cast, New Style is Plastic. Includes Keeper and Screws.

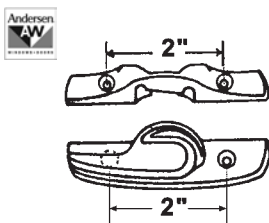

Part #	Finish
750-1630029	White

White Plastic Kit. Includes 1 Sash Lock, 1 Keeper & Screws. Shim Sold Separately: Part# 750-9069437

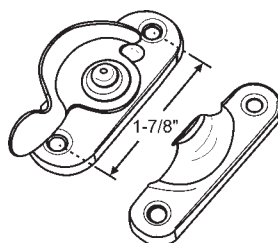

900-6692
Polished Brass

2-1/16"

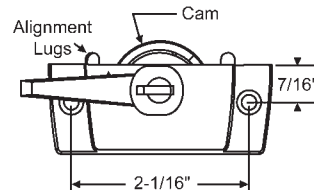

Part #	Finish
50-747-3	White

With Lugs. Comes with Two Keys

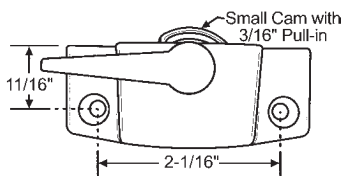

Part #	Finish
50-1070W	White
50-1070BW	Blue White

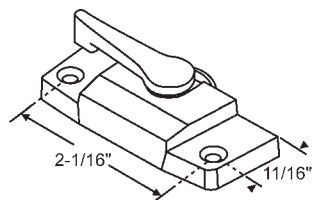

Part #	Finish
50-865B	Black
50-865W	White

Zinc Die Cast. Use with 50-896 Keeper. Standard Cam.

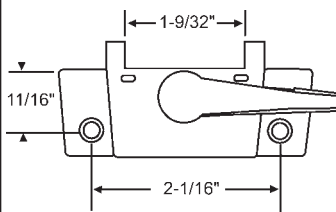

Part #	Finish
50-924-65	Terratone Brown
50-924-47	Bronze

Zinc Die Cast

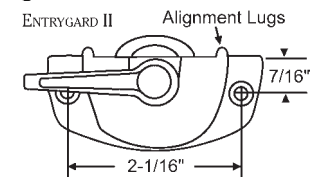

Part #	Finish
50-784-1	Bronze
50-784-3	White

Zinc Die Cast. Use with Keeper 50-379-Color, 50-372-Color and 50-373-Color.

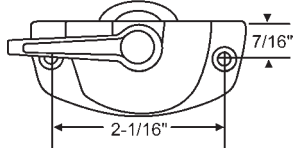

Part #	Finish
50-789-1	Bronze
50-789-3	White

Zinc Die Cast. Use with Keeper 50-374-Color and 50-372-Color.

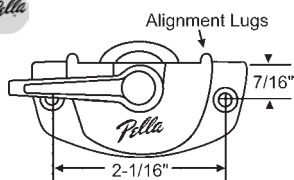

Part #	Finish
50-364-3P	White
50-364-35P	Champagne

Zinc Die Cast. Use with Keeper 50-920-Color.

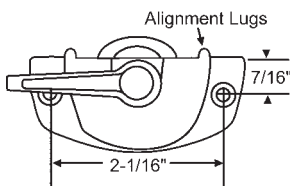

Part #	Finish
50-364-1	Bronze
50-364-3	White
50-364-5	Brass
50-364-10	Black
50-364-9	Beige

Die Cast. Use with Keeper 50-379-color, 50-372-color & 50-373-color.

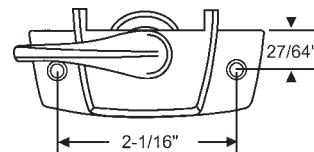

Part #	Finish
50-752W	White

Zinc Die Cast. Use with 50-753W Keeper.

WINDOW REPLACEMENT HARDWARE

SWEEP LOCKS & SASH LOCKS

2-1/16"

In order by mounting hole width (single hole locks first).

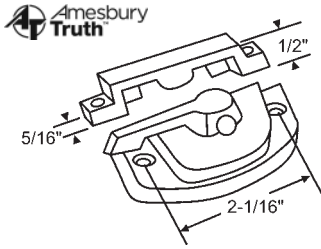

Part #	Finish
50-762	White

Push Button Security Lock
Zinc Die Cast. Includes Keeper

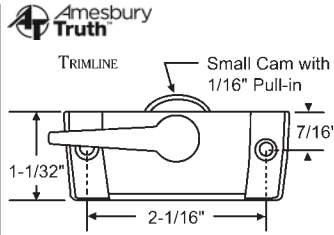

Part #	Finish
50-386-1	Bronze
50-386-3	White

Zinc Die Cast

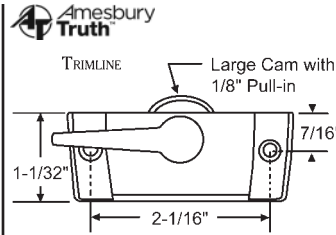

Part #	Finish
50-384-1	Bronze
50-384-2	Gold
50-384-3	White
50-384-10	Black

Zinc Die Cast

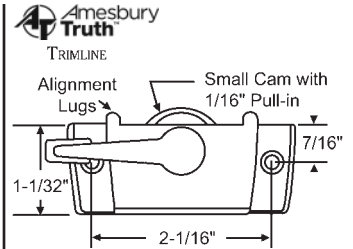

Part #	Finish
50-382-3	White

Zinc Die Cast. Use with 50-392-3 Keeper.

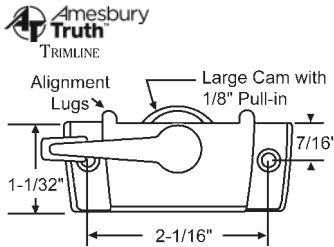

Part #	Finish
50-380-3	White
50-380-6	Clay
50-380-8	Chestnut Bronze

Zinc Die Cast. Use with 50-392 and 50-393 Keepers.

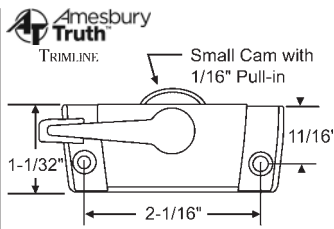

Part #	Finish
50-385-1	Bronze
50-385-3	White

Zinc Die Cast

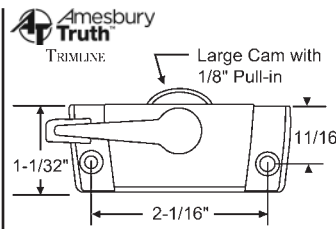

Part #	Finish
50-387-3	White
50-387-5	Polished Brass
50-387-6	Clay

Used with 50-387K Keeper

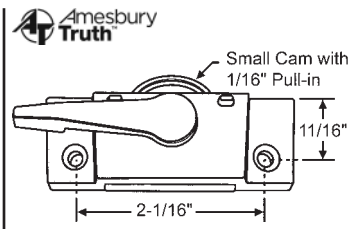

Part #	Finish
50-481-9	Beige
50-481-46	Appliance White
50-481-50	Tan
50-481-55	Metallic Gold

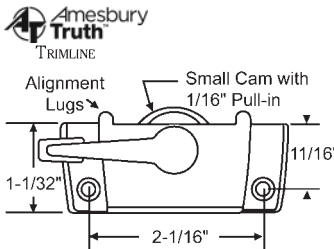

Part #	Finish
50-381-3	White
50-381-8	Chestnut Bronze

Zinc Die Cast. Use with 50-392 and 50-393 Keepers.

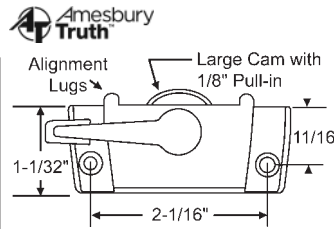

Part #	Finish
50-383-3	White
50-383-4	Coppertone
50-383-6	Clay
50-383-9	Beige

Zinc Die Cast. Use with 50-392 and 50-393 Keeper.

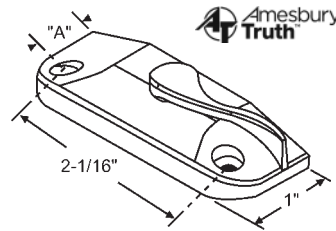

Part #	Finish	"A"
50-939-46	Appliance White	11/16"
50-940-46	Appliance White	7/16"

Zinc Die Cast
Use with 50-1112-46 Keeper.

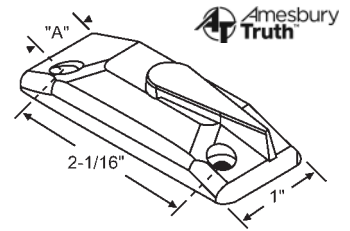

Part #	Finish	"A"
50-937-3	White	7/16"
50-938-46	Appliance White	11/16"

Zinc Die Cast. Use with 50-1109-3 and 50-1112-46 Keeper.

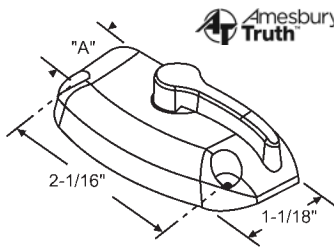

Part #	Finish	"A"
50-941-46	Appliance White	7/16"
50-942-46	Appliance White	11/16"

Zinc Die Cast. Use with 50-1110-46 and 50-1111-46 Keeper.

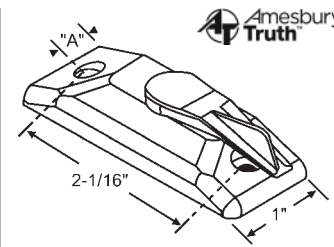

Part #	Finish	"A"
50-943-46	Appliance White	7/16"
50-944-46	Appliance White	11/16"

Zinc Die Cast
Use with 50-1109-46 Keeper.

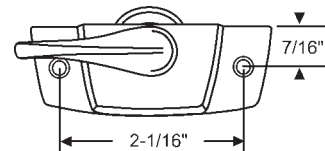

Part #	Finish
50-1016OW	Off-White
50-1016OW-Homepride	Off-White (Homepride stamped on front)
50-1016OW-Interstate	Off-White (Interstate stamped on front)
50-1016AD	Almond
50-1016AD-Homepride	Almond (Homepride stamped on front)
50-1016BP	Brass Plated

WINDOW REPLACEMENT HARDWARE

SWEEP LOCKS & SASH LOCKS

In order by mounting hole width (single hole locks first).

2-1/16"

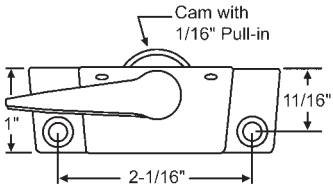

Part #	Finish
50-419-10X	Black

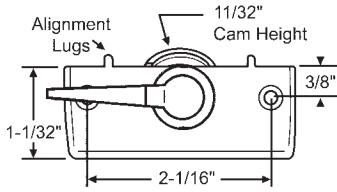

Part #	Finish
50-868	Driftwood

Zinc Die Cast. Use with 50-868K Keeper.
PEACHTREE

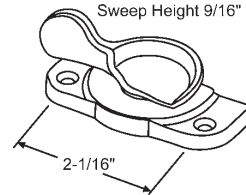

Part #	Finish
50-471-1	Bronze
50-471-5	Polished Brass
50-471-71	Oil-Rubbed Bronze

Restoration Locks. Zinc Die Cast. Use with 50-472-Color Keeper.

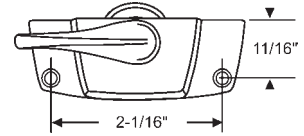

Part #	Finish
50-1019OW	Off-White
50-1019AD	Almond

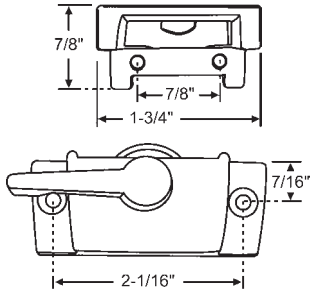

Part #	Finish
50-1181BG	Beige

Sash Lock and Keeper Set

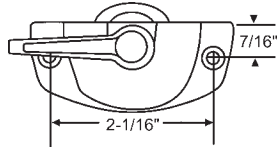

Part #	Finish
50-365-1	Bronze
50-365-2	Gold
50-365-3	White
50-365-6	Clay

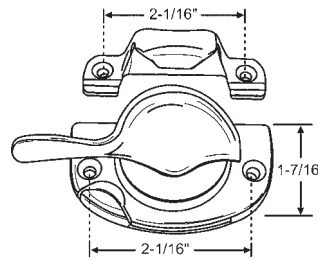

Part #	Finish
50-973-1	Bronze
50-973-3	White

Sash Lock and Keeper Set



Part #	Finish
50-439ORBZ	Oil Rubbed Bronze
50-439PNK	Polished Nickel

Fitch Pattern Sash Lock Set
Base Dimensions: 9/16" x 2-1/8"
Strike Dimensions: 7/16" x 2-1/8"

Interlock PRO-Latch

Featuring automatic locking action and a removable cover, PRO-Latch offers the ability to provide cost-effective proprietary aesthetics as well as architectural finishes.

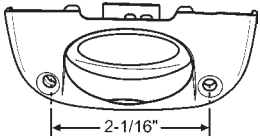

50-1065W

Sash Lock Cover and Mechanism.
White. Used with 50-1066W & 50-1067W
Keepers
INTERLOCK

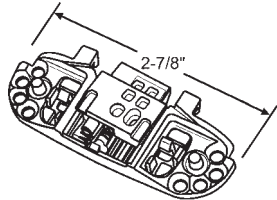

50-1288

PRO-Latch Mechanism
INTERLOCK

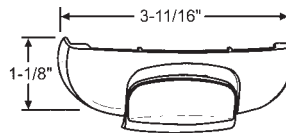

50-1474W

Slimline Cover Assembly. Fits PRO-Latch
Mechanism. White Plastic
INTERLOCK

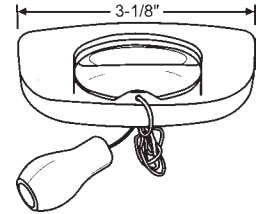

50-1292W

ADA Sash Lock Cover. Fits PRO-Latch
Mechanism. White
INTERLOCK

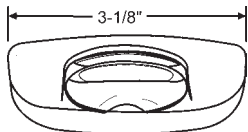

Part #	Finish
50-2014AD	Almond
50-2014CY	Clay
50-2014W	White

Pro and Tru Latch Cover
INTERLOCK

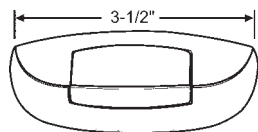

50-2015W

Slim Pro Latch Cover. White Metal
INTERLOCK



Positive Action Lock (Pal System)

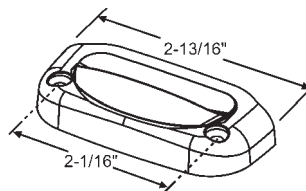

50-2054C-3

White Cover Assembly

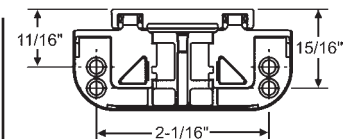

50-2053B

Wide Base Assembly.

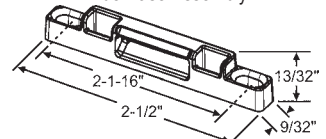

50-1303K-3

Keeper

WINDOW REPLACEMENT HARDWARE

SWEEP LOCKS & SASH LOCKS

In order by mounting hole width (single hole locks first).

2-5/32"

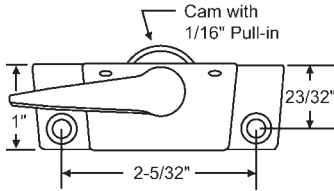

Part #	Finish
50-429-46X	Appliance White

Zinc Die Cast.
Use with 900-21122 Keeper.

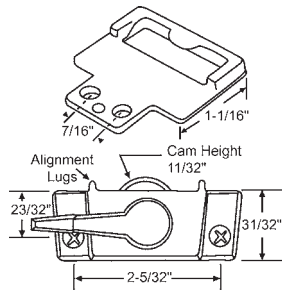

Part #	Finish
900-14379BGA	Beige

Zinc Die Cast. Includes Keeper
FIBERLUX

2-3/16"

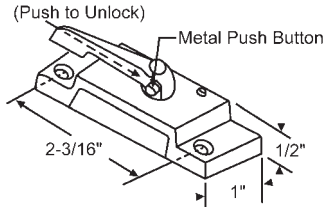

Part #	Finish
50-415-10	Black
50-415-3	White

Zinc Die Cast

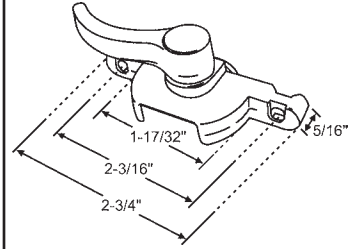

Part #	Finish
50-409-3	White

2-7/32"

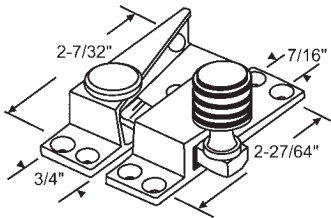

Part #	Finish
50-1098BRS	Brass

Sash Lock and Keeper. Solid Cast Brass
MIGHTON

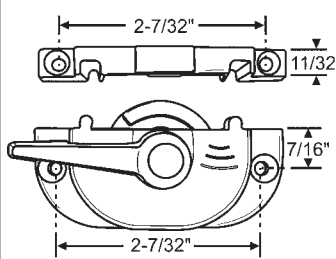

50-892WA

White Sash Lock and Keeper

2-1/4"

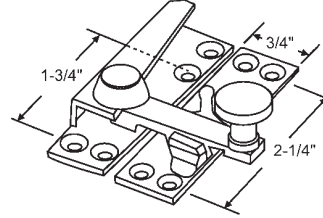

Part #	Finish
50-1097BRS	Solid Brass
50-1097CH	Chrome

Solid Cast Brass
MIGHTON

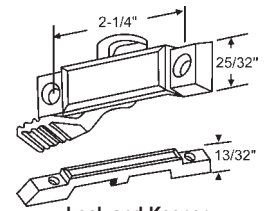

Lock and Keeper

Part #	Finish
50-601A	Chrome
50-601WA	White
50-601BA	Black

Sweep Lock Only

Part #	Finish
50-601-55	Metallic Gold
50-601-8	Dark Bronze

Zinc Die Cast

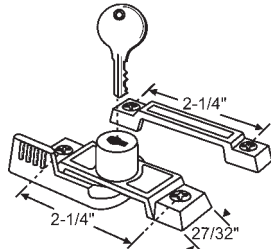

900-11000B

Black. Tongue projects .429 from edge of Housing

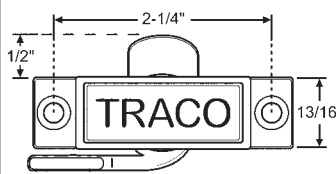

Part #	Finish
50-603W-500T	White
50-603BZ-500T	Bronze

With .500 Throw
TRACO/SECURITY

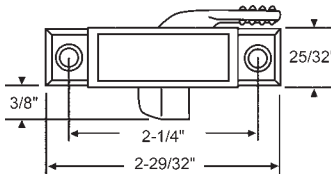

Part #	Hand	Finish
50-1064RHOW	Shown	Off-White

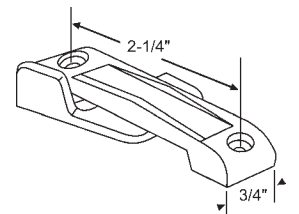

Part #	Finish
50-657B	Black
50-657BZ	Bronze

Zinc Die Cast

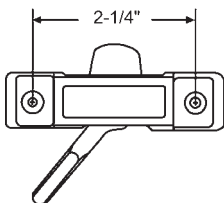

Part #	Finish
900-7903	White Bronze
900-7903P (w/pole hole)	White Bronze

Bronze Casting
SEASONALL

Lock and Keeper

Part #	Finish
50-603A	Chrome
50-603BA	Black
50-603WA	White

Zinc Die Cast
Lock Only

Part #	Finish
50-603B	Black
50-603AD	Almond
50-603BE	Beige
50-603BR	Brown
50-603BW	Bright White
50-603BZ	Bronze
50-603W	White

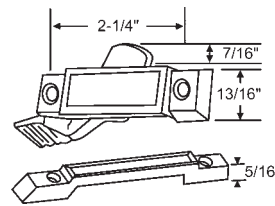

Lock Only with .500 Throw

Part #	Finish
50-603M-500	Mill
50-603W.500	White

Lock Only with Seasonall Logo

Part #	Finish	Description
50-603S	Chrome	Regular Lever (shown)
50-603PS	Chrome	With Pole Ring Lever

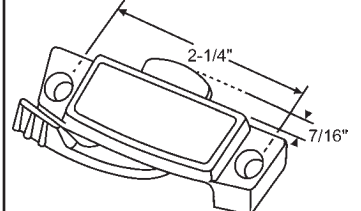

Part #	Finish
50-731B	Black
50-731W	White

Zinc Die Cast. Use with 50-602 Keeper.

WINDOW REPLACEMENT HARDWARE

SWEEP LOCKS & SASH LOCKS

In order by mounting hole width (single hole locks first).

2-1/4"

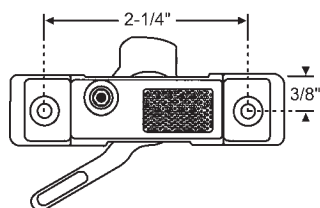

Part #	Finish
50-1205	White Bronze

Includes Set Screw

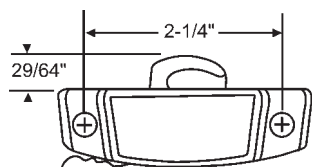

Part #	Finish
900-11005B	Black

Zinc Die Cast. Use with 900-14381 Keeper.

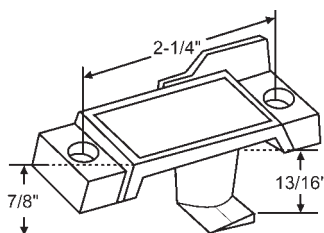

Part #	Finish
50-765	White
50-765B	Black

ACORN

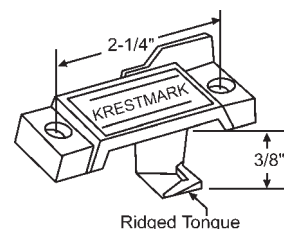

Part #	Finish
900-10798KB	Black

Zinc Die Cast
KRESTMARK

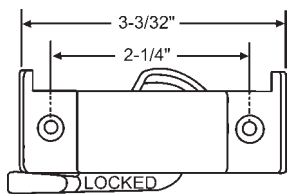

Part #	Finish
900-19656B	Black

Zinc Die Cast. Use with 900-19705BL Keeper.

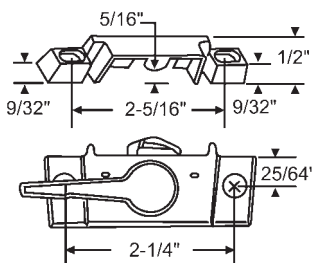

Part #	Finish
50-827-45	Blue White
50-827-70	Dark Brown

Zinc Die Cast. Includes Keeper

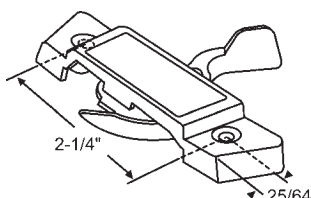

Part #	Hand	Finish
900-19112LH	Shown	Black
900-19112RH	Opposite	Black

Zinc Die Cast
RUSCO

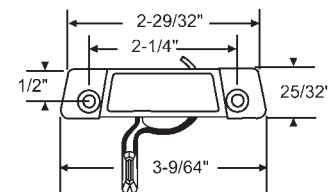

Part #	Hand	Finish
50-971-40LH	Shown	Snow White
50-971-40RH	Opposite	Snow White
50-971-9LH	Shown	Beige
50-971-9RH	Opposite	Beige

Zinc die Cast
MI HOME PRODUCTS

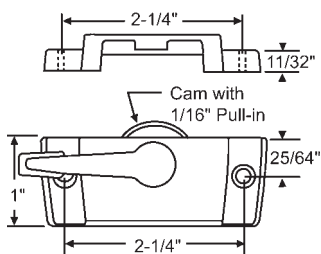

Part #	Finish
50-418-10	Black
50-418-46	Blue White

Zinc Die Cast. Includes Keeper

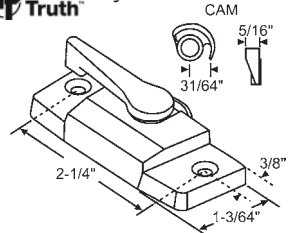

Part #	Finish
900-19228BG	Beige
900-19228W	White

Zinc Die Cast. Use with 900-20118 Face Mount Keeper.

TRACO/ROLLYSON

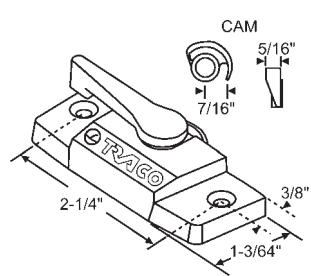

Part #	Finish
900-19778	Black

Zinc Die Cast.
TRACO

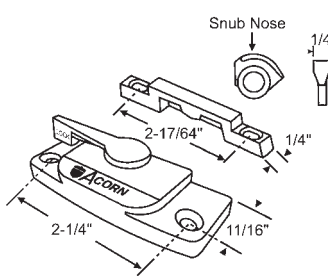

Part #	Finish
50-915	White

Includes Keeper
ACORN

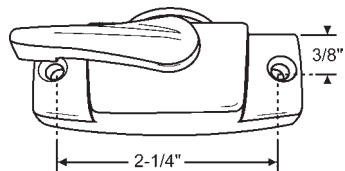

Part #	Finish
50-1027W	White
50-1027B	Black

TRACO 5000

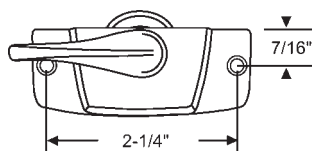

Part #	Finish
50-1022BP	Brass Plated

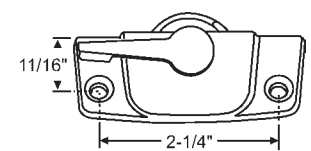

Part #	Finish
50-970B	Black

Zinc Die Cast. Sweep Height 5/16". Use with 50-970KB Keeper.

ACORN

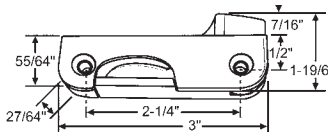

50-1293W
White

WINDOW REPLACEMENT HARDWARE

SWEEP LOCKS & SASH LOCKS

In order by mounting hole width (single hole locks first).

2-3/8"

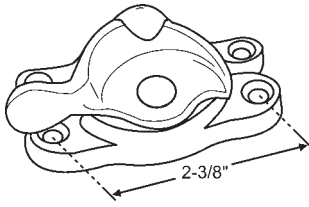

Part #	Finish
50-440	Lacquered Polished Brass
50-440ORBZ	Oil-Rubbed Bronze
50-440PNK	Polished Nickel
50-440SNK	Satin Nickel

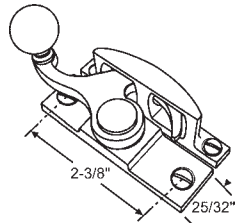

Part #	Finish
50-1323ORBZ	Oil Rubbed Bronze
50-1323PB	Polished Brass
50-1323PNK	Polished Nickel
50-1323SNK	Satin Nickel

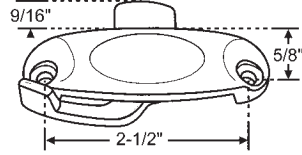

50-1146W
White

2-9/16"

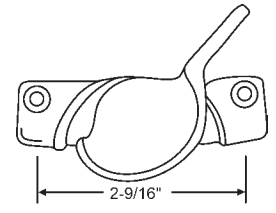

Sweep Height 1"

Part #	Finish
900-7858	Copper

Bronze Casting
Use with 900-7859 Keeper.

2-9/16"

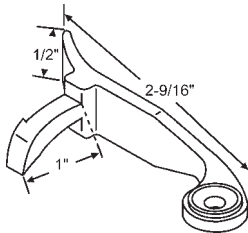

Part #	Finish
900-11288	Chrome

Zinc Die Cast
MODULUME

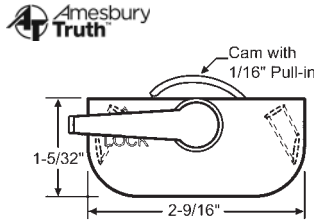

Part #	Finish
50-486-1	Bronze
50-486-46	White

Angled Screw Holes

2-5/8"

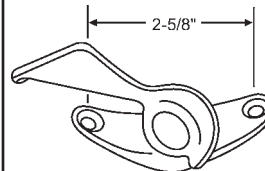

Part #	Finish
50-723	White Bronze

Bronze Casting

DOUBLE HUNG LATCH

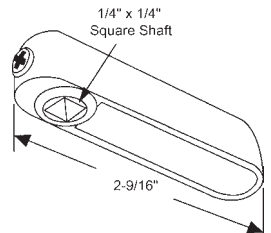

Part #	Finish
900-21337-BG	Driftwood
900-21337-W	White

Plastic Double Hung Latch
PEACHTREE

STAMPED STEEL FACE MOUNTED WINDOW KEEPERS

Stamped steel keepers in order by mounting hole distance and height.

Single Hole

7/16"

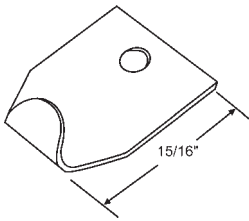

Part #	Finish
50-712SP	Stamped Steel

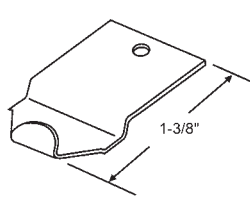

Part #	Finish
50-692	Stamped Steel

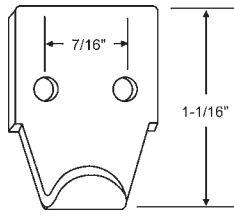

Part #	Finish
50-661	Stamped Steel

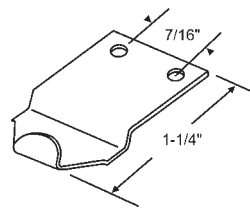

Part #	Finish
50-691	Stamped Steel

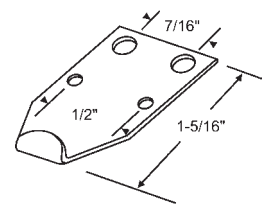

Part #	Finish
50-694	Stamped Steel

15/32"

1/2"

5/8"

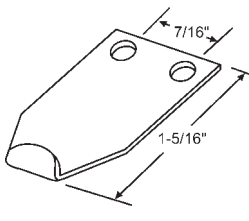

Part #	Finish
50-697	Stamped Steel

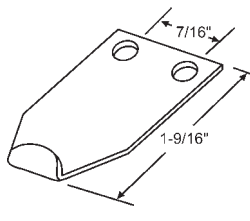

Part #	Finish
900-9744	Stamped Steel
900-9744W	White

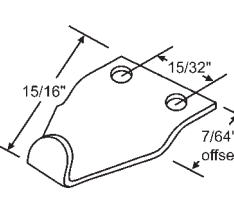

Part #	Finish
50-700	Stamped Steel

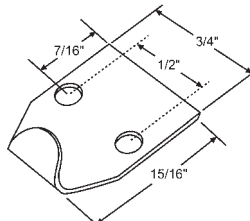

Part #	Finish
900-8359	Stamped Steel

BINNINGS

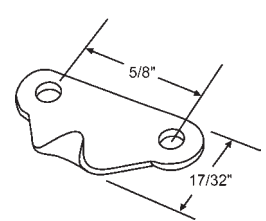

Part #	Finish
50-663	Stamped Steel

WINDOW REPLACEMENT HARDWARE

STAMPED STEEL FACE MOUNTED WINDOW KEEPERS

HUNG & SLIDING FACE MOUNTED WINDOW KEEPERS

Face mounted keepers in order by mounting hole distance and height.

1-1/4"

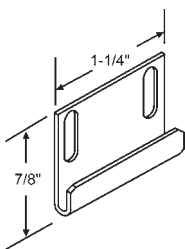

Part #	Finish
50-790	Stamped Steel

Single Hole

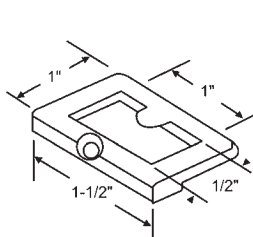

Part #	Finish
50-650	Chrome

Zinc Die Cast

7/16"

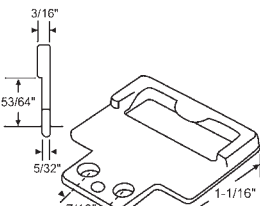

Part #	Finish
900-18531BG	Almond
900-18531BK	Black

Zinc Die Cast

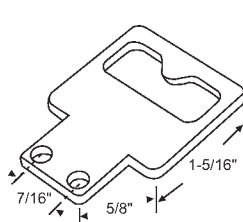

Part #	Finish
900-18880	Antique Copper

Zinc Die Cast

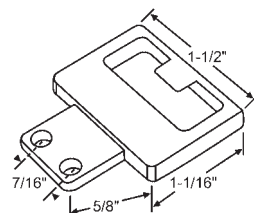

Part #	Finish
50-775-3	White
50-775-30	Antique Copper
50-775-12	Dayton Brown

Zinc Die Cast

1/2"

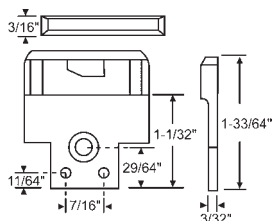

50-390BEW
Blue White

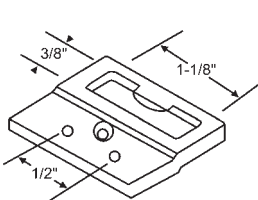

Part #	Finish
50-696	Chrome

Zinc Die Cast

5/8"

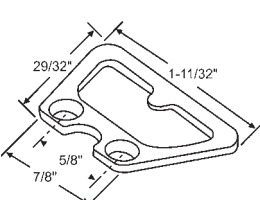

Part #	Finish
900-9920	White Bronze

Bronze Casting

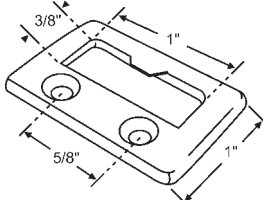

Part #	Finish
50-643	Brite

Zinc Die Cast

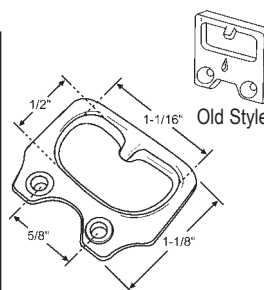

Part #	Finish
50-609WB	White Bronze

New Style
NORANDEX

11/16"

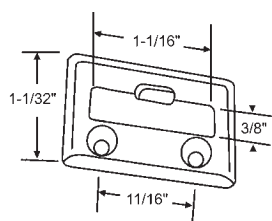

Part #	Finish
50-642	Brite

Zinc Die Cast

3/4"

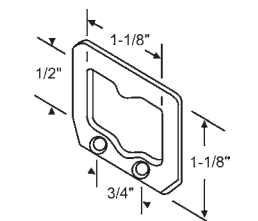

Part #	Finish
50-709	White Bronze

Bronze Casting

25/32"

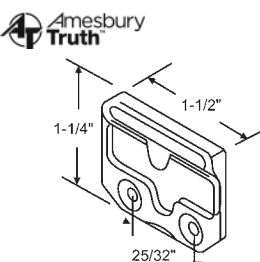

Part #	Finish
50-733K	Brite

Zinc Die Cast

7/8"

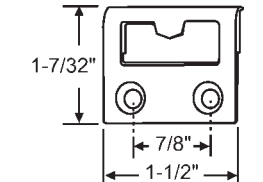

Part #	Finish
50-970KB	Black

Zinc Die Cast

ACORN

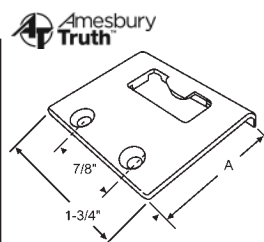

Part #	Finish	A
50-805W	White	1-1/2"
50-896W	White	1-3/16"

Zinc Die Cast

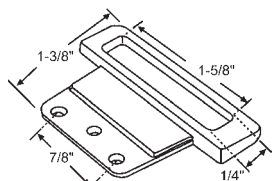

Part #	Finish
50-647	Chrome

Zinc Die Cast
SEASONALL

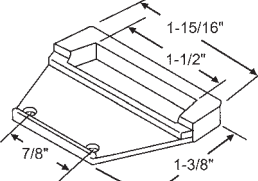

Part #	Finish
900-20101	Chrome

Zinc Die Cast
SEASONALL

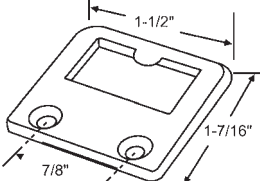

Part #	Finish
50-1004	Brite

Zinc Die Cast
PAN AM

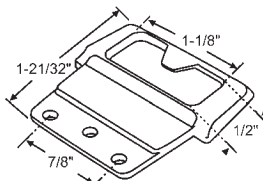

Part #	Finish
50-646	Chrome

Zinc Die Cast
SEASONALL

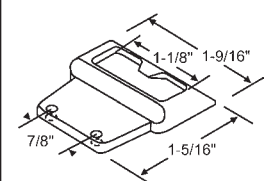

Part #	Finish
50-800	Satin Aluminum

Zinc Die Cast
BETTER-BILT

WINDOW REPLACEMENT HARDWARE

HUNG & SLIDING FACE MOUNTED WINDOW KEEPERS

Face mounted keepers in order by mounting hole distance and height.

1"

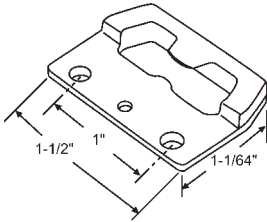

Part #	Finish
50-753W	White

Zinc Die Cast

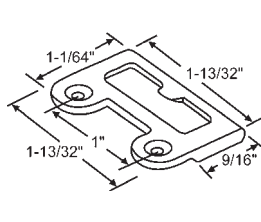

Part #	Finish
900-9929	White Bronze

Bronze Casting

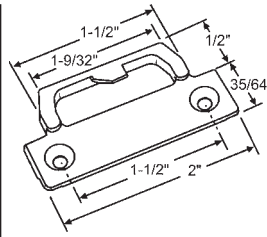

Part #	Finish
50-804BG	Beige
50-804W	White

Zinc Die Cast
ROLLYSON

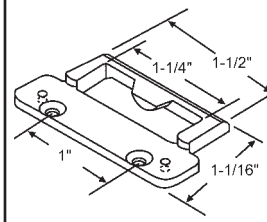

Part #	Finish
900-20118	White

Zinc Die Cast
ROLLYSON

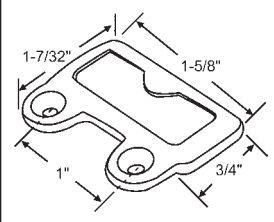

Part #	Finish
900-13581	White Bronze

Bronze Casting

1-21/32"

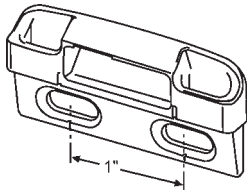

Part #	Finish
50-1067W	White

Used with 50-1065W Sash Lock
INTERLOCK

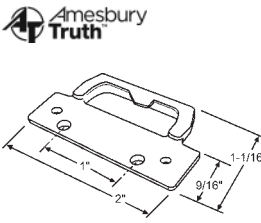

Part #	Finish
900-19782B	Brown
900-19782BG	Beige
900-19782W	Appliance White

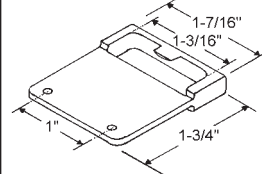

Part #	Finish
900-20075	Appliance White
900-20075BG	Beige
900-20075-10	Black

Zinc Die Cast

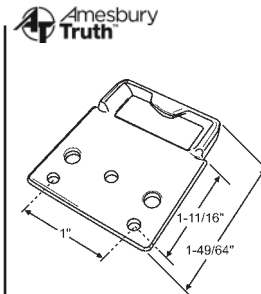

Part #	Finish
50-495-3	White

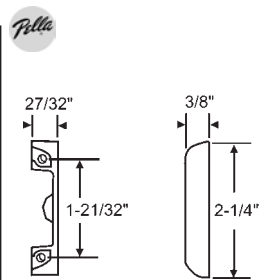

Part #	Finish
50-363-35P	Champagne

Used with 50-213CHP Sash Lock

1-1/32"

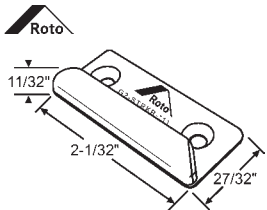

50-955
White Plastic

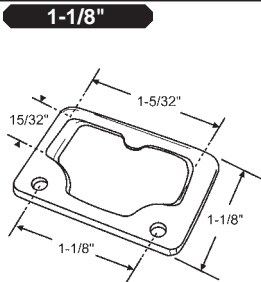

Part #	Finish
50-946	White Bronze

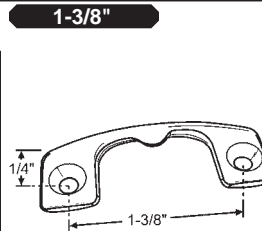

Part #	Finish
900-11333	White Bronze

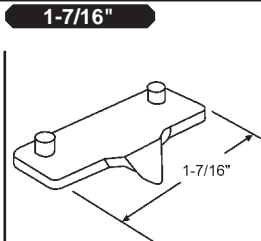

Part #	Finish
50-623	Unfinished

Zinc Die Cast
AIR CONTROL

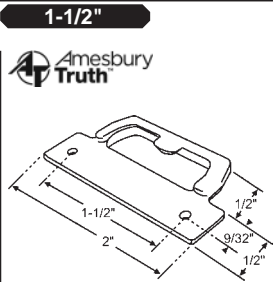

Part #	Finish
900-18551KWT	Snow Blue

1-3/4"

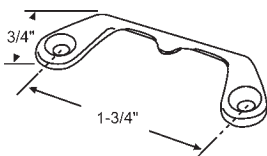

Part #	Finish
900-9151	White Bronze

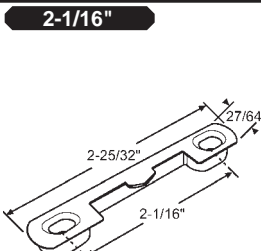

Part #	Finish
50-1404W	White

PGT

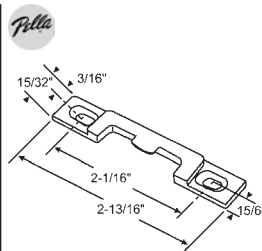

Part #	Finish
50-489-3	White

Vinyl

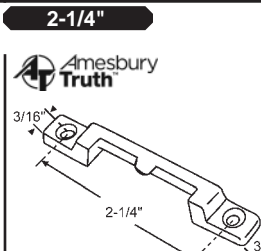

Part #	Finish
50-749	White

Zinc Die Cast

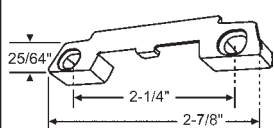

Part #	Finish
50-1076OW	Off White

WINDOW REPLACEMENT HARDWARE

HUNG & SLIDING FACE MOUNTED WINDOW KEEPERS

HUNG & SLIDING TOP MOUNTED WINDOW KEEPERS

In order by mounting hole distance and height.

2-5/16"

1/2"

3/4"

1"

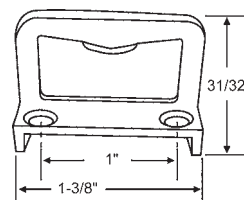
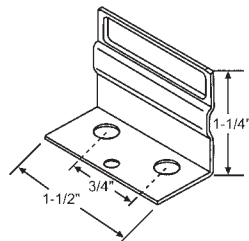
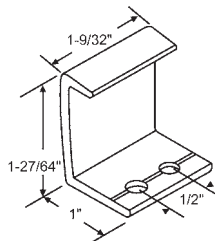
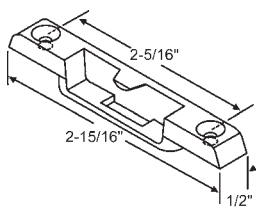
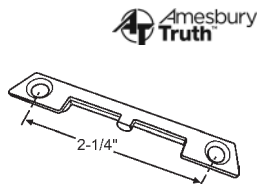

Part #	Finish
900-11293-9	Beige
900-11293-3	White
900-11293-46	Appliance White

PGT

Part #	Finish
50-895	White

Plastic
METAL INDUSTRIES

Part #	Finish
900-18719	Brown

Zinc Die Cast
TRACO

Part #	Finish
900-8728	Aluminum

THERMALGARD

Part #	Finish
50-699	Unfinished

Zinc Die Cast

1-1/16"

1-1/8"

1-11/32"

1-3/8"

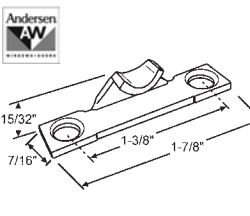
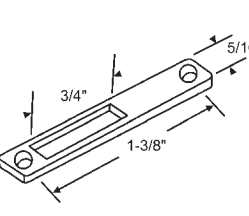
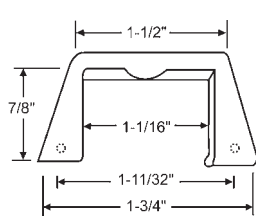
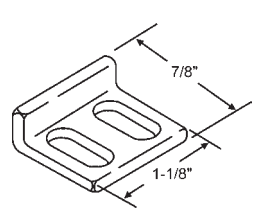
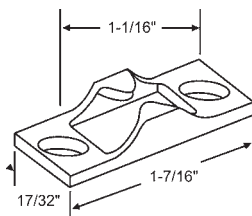

Part #	Finish
50-701	Die Cast

Part #	Finish
50-736	White Bronze

Bronze Casting
SWS

Part #	Finish
50-639	Chrome

Zinc Die Cast
ALENCO

Part #	Finish
50-716	Chrome

Zinc Die Cast
CROSSLY

Part #	Finish
750-1361406	Stone
750-1351340	White

Andersen
AW

1-5/8"

1-7/8"

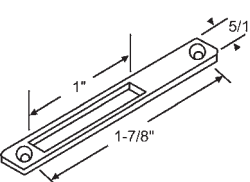
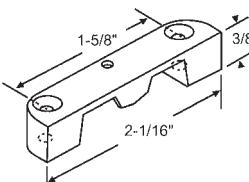
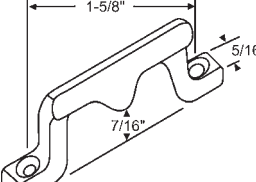
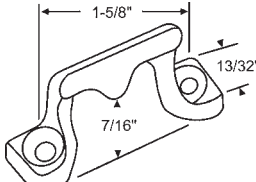
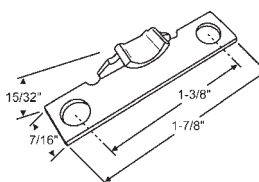

Part #	Finish
50-911K	Beige

Part #	Finish
50-690	White Bronze

Bronze Casting

Part #	Finish
900-12561	White Bronze

Bronze Casting

Part #	Finish
50-801K	Bright Brass

Zinc Die Cast

Part #	Finish
50-611	Chrome

Zinc Die Cast
PORTALUME

1-51/64"

1-27/32"

2"

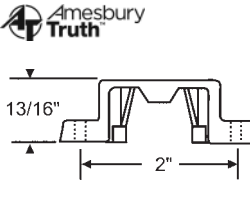
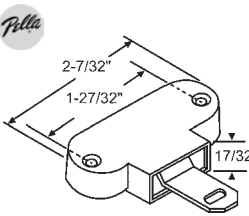
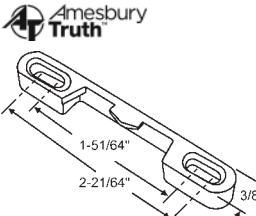
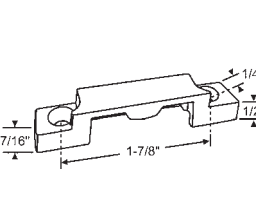
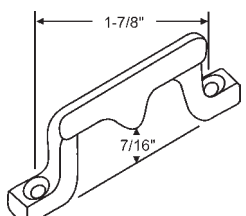

Part #	Finish
50-724	White Bronze

Bronze Casting

Part #	Finish
50-214-46	White
50-214-47	Bronze
50-214-50	Tan

Part #	Finish
50-968-46	White

Zinc Die Cast

Part #	Finish
50-832	Beige

Sash Catch
Plastic with Steel Tongue

Part #	Finish
50-357-3	White

WINDOW REPLACEMENT HARDWARE

HUNG & SLIDING TOP MOUNTED WINDOW KEEPERS

In order by mounting hole distance and height.

2"

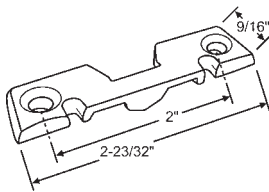

Part #	Finish
50-868K	Driftwood
50-868KW	White

Latch Keeper Kit. Includes 1 Keeper w/ Screws
PEACHTREE

2-1/16"

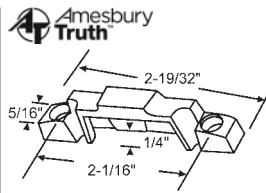

Part #	Finish
50-373-3	White
50-373-5	Bright Brass

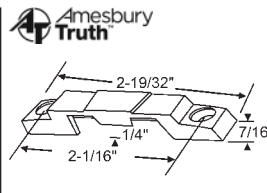

Part #	Finish
50-374-3	White

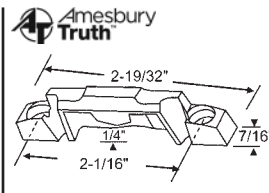

Part #	Finish
50-379-1	Bronze
50-379-3	White
50-379-8	Chestnut Bronze

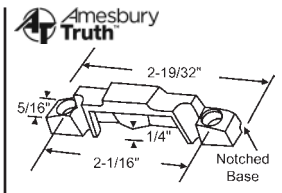

Part #	Finish
50-372-1	Bronze
50-372-3	White
50-372-5	Bright Brass
50-372-6	Clay
50-372-9	Beige

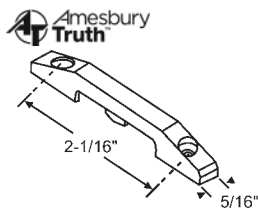

Part #	Finish
50-1112-46	Appliance White

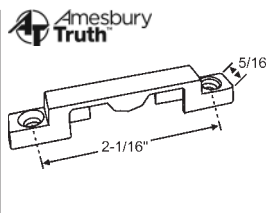

Part #	Finish
50-394-3	White

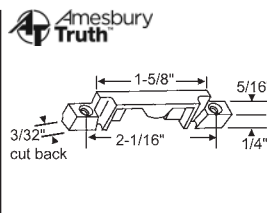

Part #	Finish
50-393-3	White
50-393-9	Beige
50-393-4	Coppertone
50-393-8	Chestnut Bronze

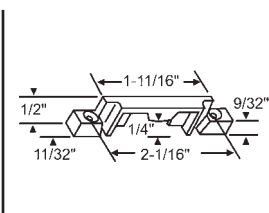

Part #	Finish
50-855	Bronze
50-855BE	Beige
50-855W	White

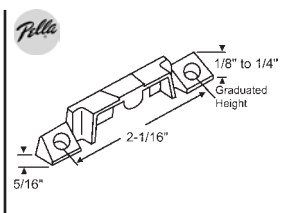

Part #	Finish
50-920-35	Champagne
50-920-3	White

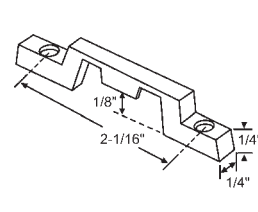

Part #	Finish
50-1033BP	Bras Plated
50-1033BZ	Bronze

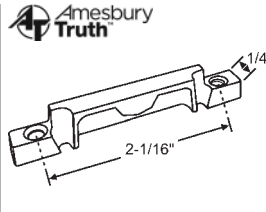

Part #	Finish
50-812-3	White
50-812-4	Coppertone

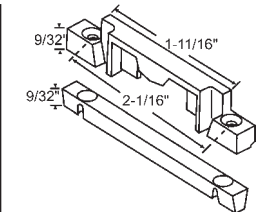

Part #	Finish
900-20056	Beige
900-20056W	White

Includes Screws and Shim
900-20103BE (Beige) or
900-20103W (White)
BETTER BILT

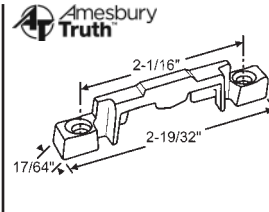

Part #	Finish
50-740-3	White

Keeper with Lugs

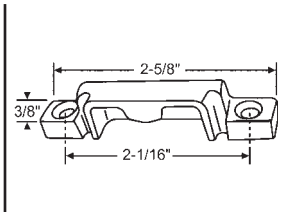

Part #	Finish
50-387-5K	Brass
50-387-6K	Clay
50-387-74K	Snow White

2-1/8"

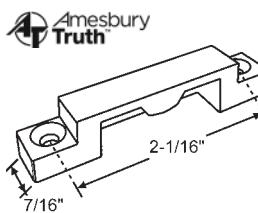

Part #	Finish
50-499-1	Bronze
50-499-3	White
50-499-7	Aluminum
50-499-8	Chestnut Bronze
50-499-9	Beige

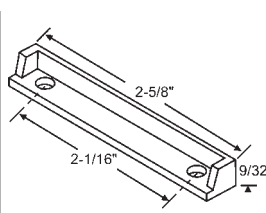

Part #	Finish
900-20045W	White
900-20045B	Black

Keeper Shim
BETTER-BILT

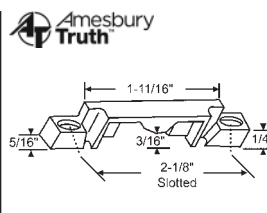

Part #	Finish
50-392-3	White
50-392-1	Bronze
50-392-14	Cocoa Brown
50-392-8	Chestnut Bronze
50-392-6	Clay

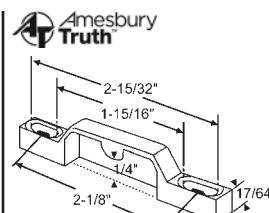

Part #	Finish
900-21122	White
900-21122-65	Brown
900-21122BG	Beige

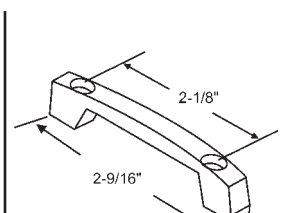

Part #	Finish
900-14377KB	Black

SYN-TECH

WINDOW REPLACEMENT HARDWARE

HUNG & SLIDING TOP MOUNTED WINDOW KEEPERS

In order by mounting hole distance and height.

2-5/32"

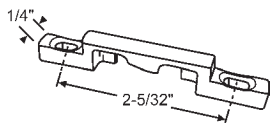

Part #	Finish
50-1071W	White

2-3/16"

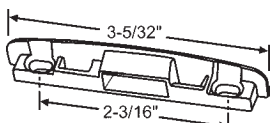

Part #	Finish
50-2072AD	Almond
50-2072W	White

INTERLOCK

2-1/4"

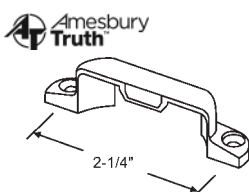

Part #	Finish
50-472-1	Bronze
50-472-5	Polished Brass
50-472-71	Oil-Rubbed Bronze

Keeper. Zinc Die Cast.
Screws not included.

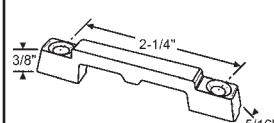

900-19705BL
Black

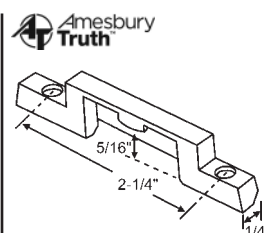

Part #	Finish
900-21121	Black

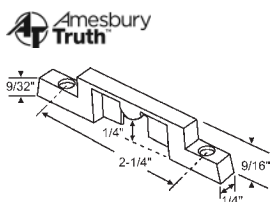

Part #	Finish
50-1431-29	White
50-1431-10	Black

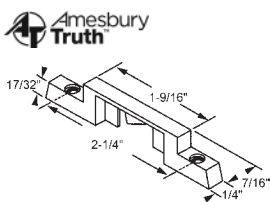

Part #	Finish
900-19229BG	Beige
900-19229AB	Antique Brass
900-19229BZ	Bronze

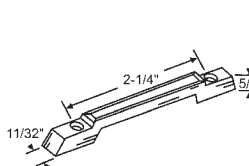

Part #	Finish
50-602	Chrome
50-602B	Black
50-602CP	Antique Copper

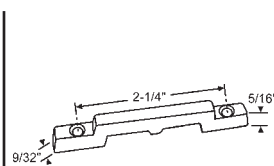

Part #	Finish
900-14381B	Black

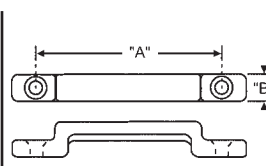

Part #	A	B
50-1206	2-1/4"	5/16"
900-22425	2-1/4"	1/4"

2-1/4"



Part #	Finish
50-601-55K	Metallic Gold
50-601-46K	White
50-601-36K	Antique Brass

Snug-Fit

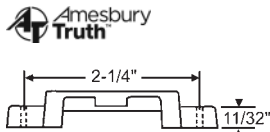

Part #	Finish
50-418-10K	Black
50-418-45K	Blue White
50-418-46K	Appliance White

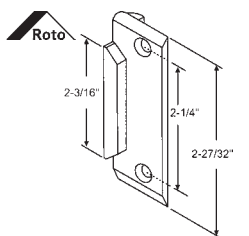

Part #	Finish
50-949WH	White
50-949BG	Beige

Plastic Latch Strike

2-3/8"

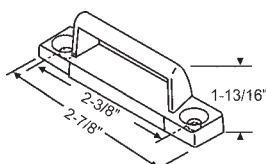

Part #	Finish
50-802	Satin Aluminum

NU-PRIME

2-7/16"

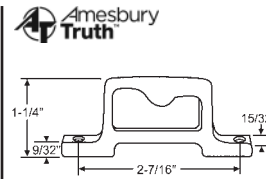

Part #	Finish
900-7859	Bronze

2-17/32"

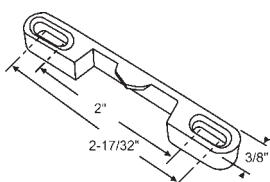

Part #	Finish
50-761-18	Sahara Beige
50-761-1	Bronze

2-3/4"

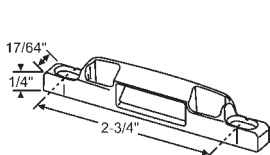

Part #	Finish
50-1066W	White

Used with 50-1065W Keeper

INTERLOCK

SLIDE LOCK

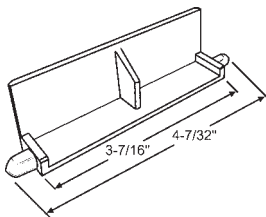

Part #	Finish
50-1194	Black

SPRING TYPE SLIDER LATCHES

Spring type latches in order by mounting hole distance and length.

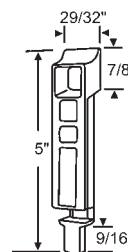

900-8997
Black Lock Bolt
ACORN

WINDOW REPLACEMENT HARDWARE

SPRING TYPE SLIDER LATCHES

Spring type latches in order by mounting hole distance and length.

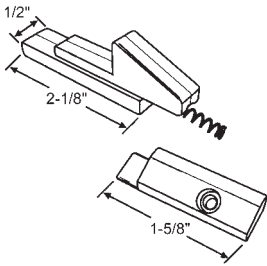

50-956

Black. Sold in Set Only.
Contains 2 Latches, 2 Keepers & 2 Springs.

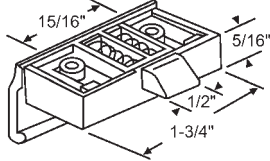

50-600A

Plastic

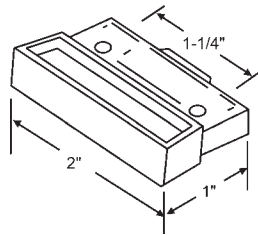

50-688

Nylon

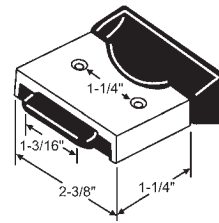

Part #	Finish
50-648A	Chrome and Black
50-648BEA	Chrome and Beige
50-648WHA	Chrome and White

Used with 50-647 Keeper.

SEASONALL

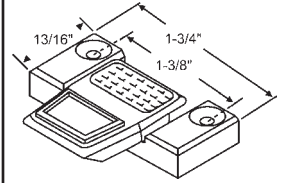

900-9950

Die Cast

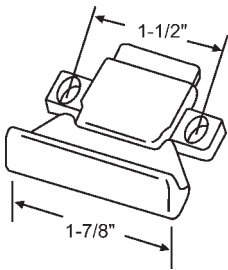

Part #	Finish
50-628A	Aluminum
50-628WA	White Aluminum

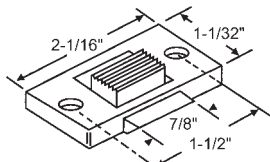

50-730WB

White Bronze

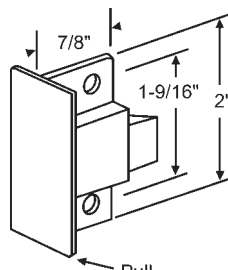

50-1007

Black Die Cast

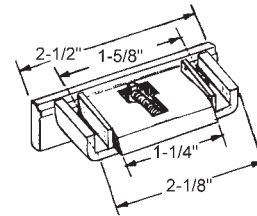

900-9061

Black Die Cast

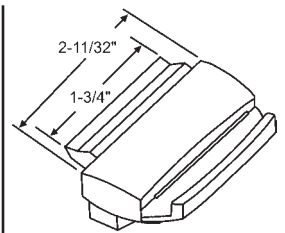

Part #	Finish
900-26	Bronze Lacquer
900-25	Chrome

Aluminum

CROSSLY

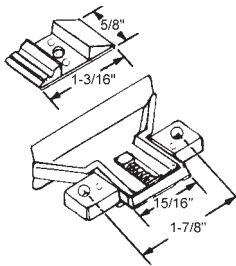

900-8878

Black Die Cast

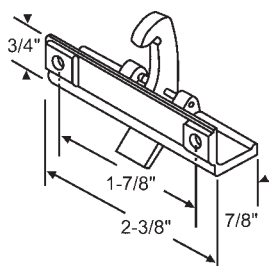

50-735

White Bronze. Used with Keeper 50-736

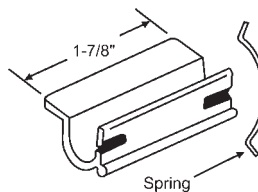

50-633

Nylon

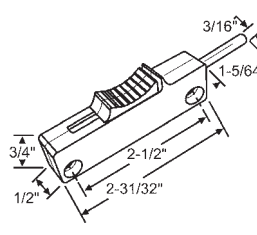

Part #	Finish
50-1395B	Black
50-1395BG	Beige
50-1395BR	Brown
50-1395W	White

Plastic Reversible Window Latch

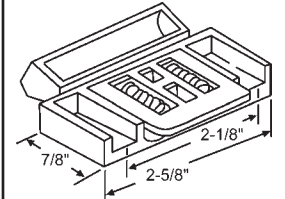

50-660

Nylon

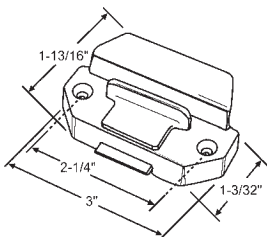

50-1508B

Black

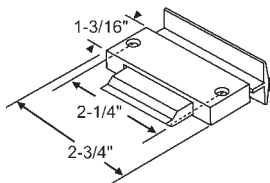

900-11566A

Black Metal
Used with Keeper 900-11567
TRACO TR6000 SERIES

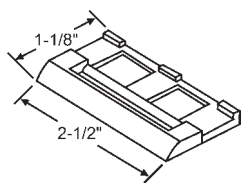

900-11567

Latch Keeper for 900-11566A

TRACO TR6000 SERIES

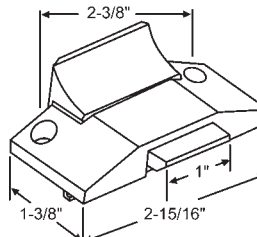

50-725

Black Aluminum
CAPITOL

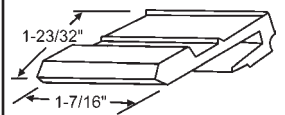

900-7972

Black. Use with 50-725 Latch.
CAPITOL

WINDOW REPLACEMENT HARDWARE

SPRING TYPE SLIDER LATCHES

Spring type latches in order by mounting hole distance and length.

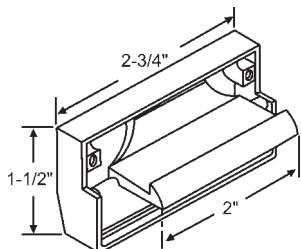

900-11470

Plastic Handle with Metal Housing. Black

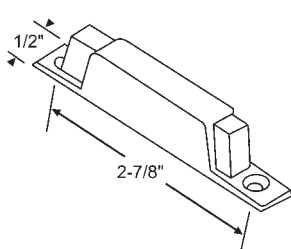

50-615A

Nylon

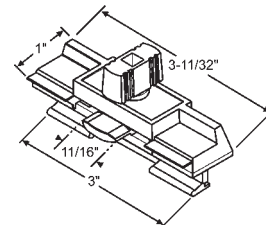

Part #	Finish
50-1484W	White
50-1484B	Black

Pull and Latch. Adjustable

SUPERIOR

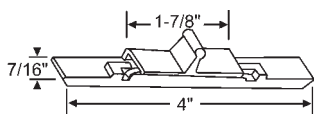

900-9563

Black Plastic

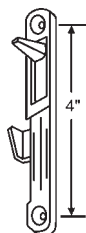

Part #	Hand
52-640	Shown
52-641	Opposite

Slider Lock

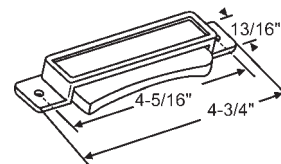

50-848

Black Aluminum

EXTRUDED SASH HANDLES & LIFTS

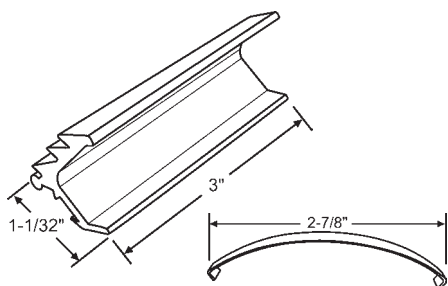

Part #	Finish
50-1405BZ	Bronze
50-1405W	White

Spring Sold Separately
(900-17213)

PGT

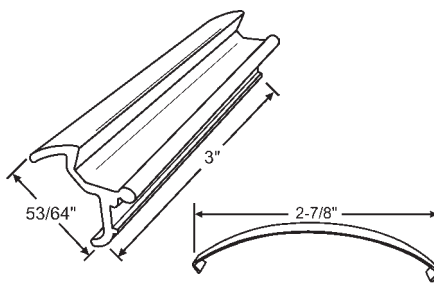

Part #	Finish
50-1406BZ	Bronze
50-1406W	White

Spring Sold Separately
(900-17213)

PGT

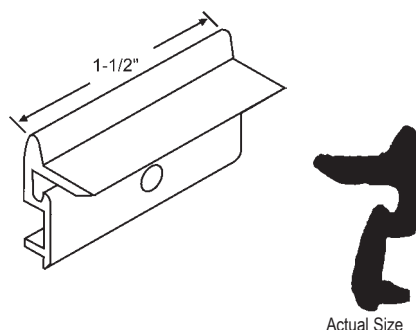

Part #	Finish
900-8615	Black

Glazing Clip, Nylon

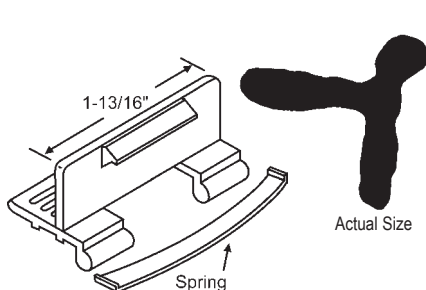

Part #	Finish
50-729	Black

Aluminum
NU-AIRE

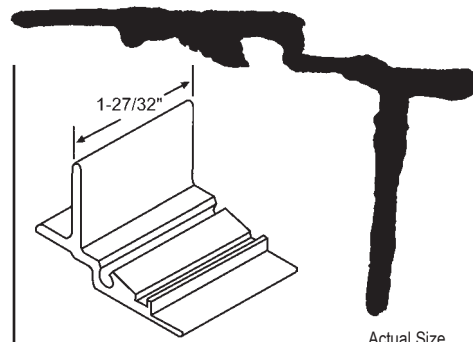

900-10875

No Longer Available

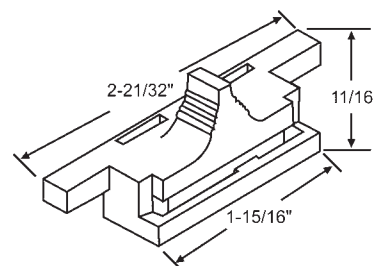

Part #	Finish
900-5484A	White

Plastic Slider Lock with Spring

CROSSLY

WINDOW REPLACEMENT HARDWARE

EXTRUDED SASH HANDLES & LIFTS

Spring type latches in order by mounting hole distance and length.

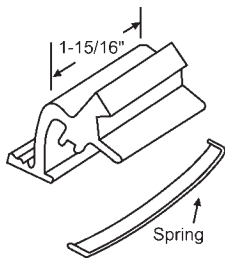

Part #	Finish
50-713	Mill

Aluminum

Actual Size

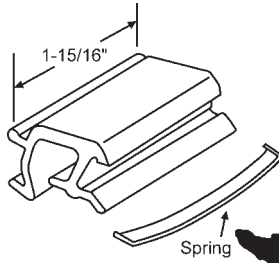

Part #	Finish
50-617A	Bronze

Aluminum

Actual Size

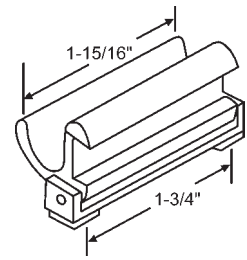

Part #	Finish
50-626	Mill

Aluminum
KELLER

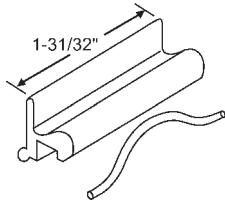

Part #	Finish
50-708	Black
50-708W	White

Plastic

Actual Size

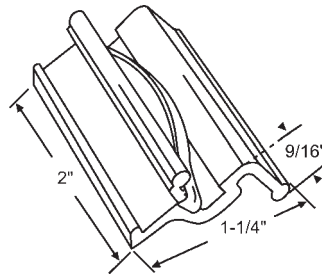

Part #	Finish
50-751A	Earth Brown
50-751WA	White

CAPITOL

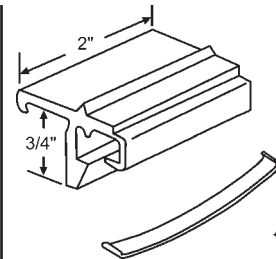

Part #	Finish
50-629A	Mill

Aluminum
CROSSLY

Actual Size

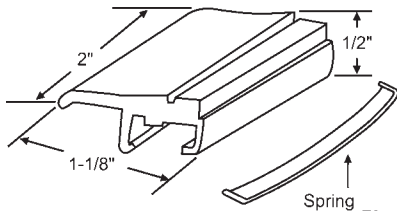

Part #	Finish
50-778W	White
50-778	Mill

Aluminum
ROLLYSON

Actual Size

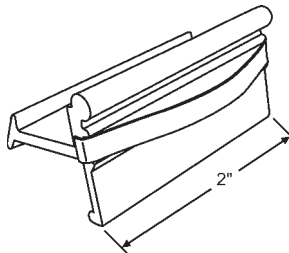

50-1312
Mill. Includes Spring

Actual Size

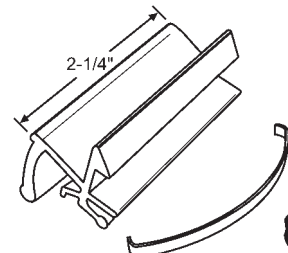

Part #	Finish	Description
900-9560BRA	Brown	with Spring

Aluminum. 900-10495S for Spring Only
ACORN

Actual Size

WINDOW REPLACEMENT HARDWARE

EXTRUDED SASH HANDLES & LIFTS

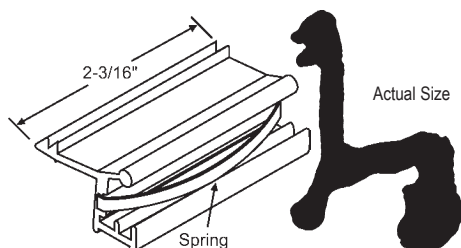

Part #	Finish
900-9559	White
900-9559A	Almond
900-9559B	Bronze
900-9559TN	Tan

Aluminum

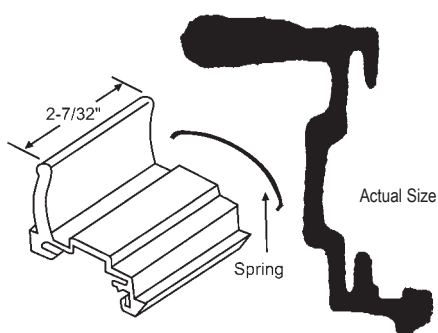

Part #	Finish
50-706	Mill

Aluminum

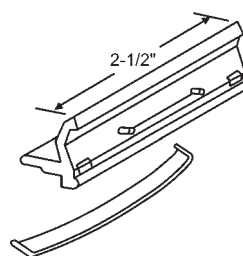

Part #	Finish
50-707	Black

Plastic

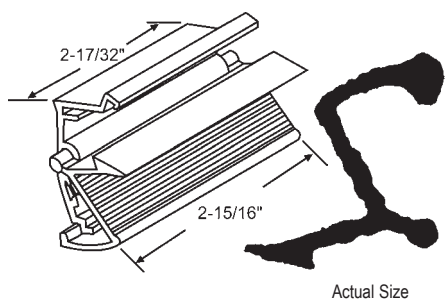

900-11565
No Longer Available
Use: 50-867A

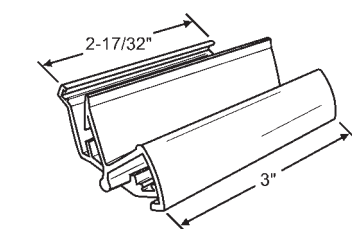

Part #	Finish
50-867A	Black

with Spring
TRACO

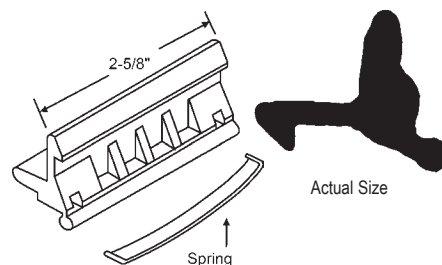

Part #	Finish
50-768WH	White
50-768	Black

Plastic

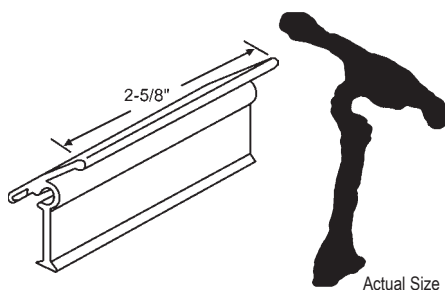

Part #	Finish
900-11342BZ	Bronze

Aluminum
HOWARD

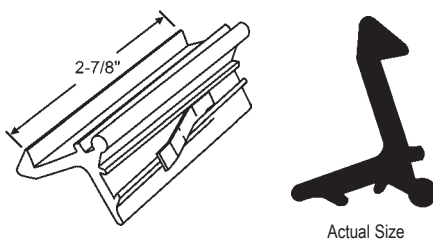

Part #	Finish
50-1313W	White

Includes Spring
ESP

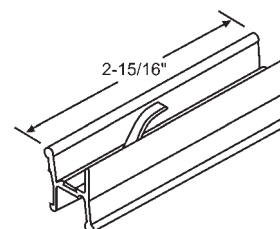

Part #	Finish
50-793W	White
50-793BR	Bronze

Aluminum

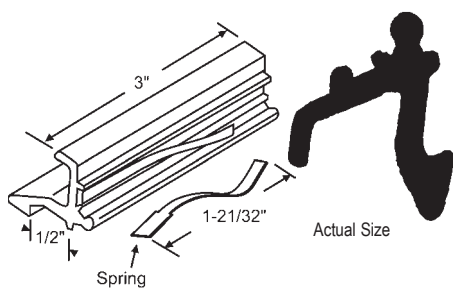

Part #	Finish
900-20772	Mill

Aluminum

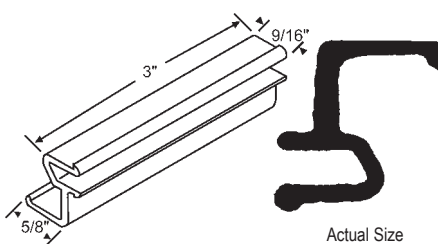

Part #	Finish
900-16656W	White
900-16656B	Black

Aluminum

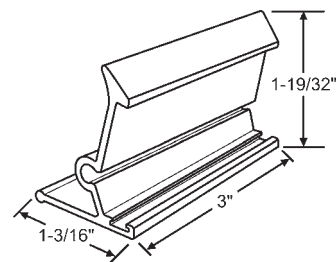

Part #	Finish
50-1324	Mill
50-1324BZ	Bronze
50-1324W	White

Aluminum
TRACO

WINDOW REPLACEMENT HARDWARE

EXTRUDED SASH HANDLES & LIFTS

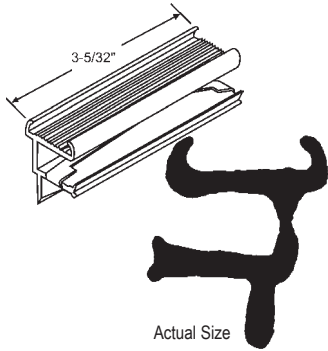

Part #	Finish
900-1088	Black

Plastic

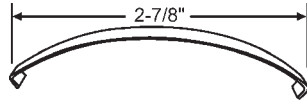

900-17213
Sash Lock Spring
PGT

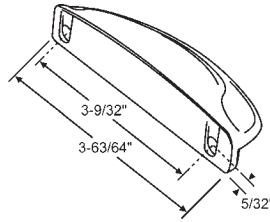

Part #	Finish
50-1311BP	Brass Plated
50-1311W	White

Zinc Die Cast. Matching Screws Included

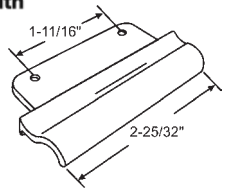

Part #	Finish
50-1310-1	Bronze
50-1310-5	Bright Brass
50-1310-13	Brushed Copper Nickel
50-1310-18	Sahara Beige
50-1310-36	Brushed Antique Brass
50-1310-40	Snow White
50-1310-80SP	Western Pewter

SASH LIFTS

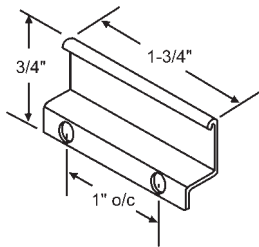

50-839
Meeting Rail Strike Plate. Used with
50-840 and 50-840BZ

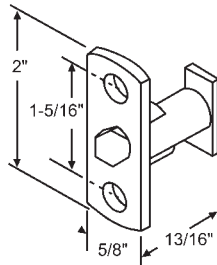

50-841
Auto Lock Plunger. Black Housing with
Aluminum Plunger. Used with 50-839,
50-840 and 50-840BZ

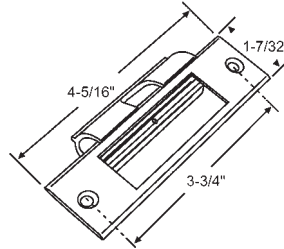

Part #	Finish
50-840	Clear Anodized
50-840BZ	Bronze Anodized

Auto Thumb Spring Lock. Metal
EFCO

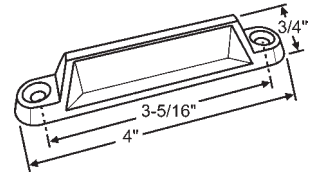

Part #	Finish
50-479	White
50-479B	Black

Plastic
WEATHERSHIELD

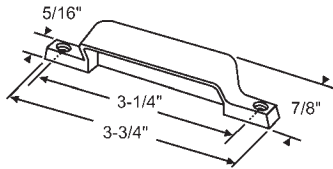

Part #	Finish
50-873W	White
50-873BZ	Bronze

Plastic

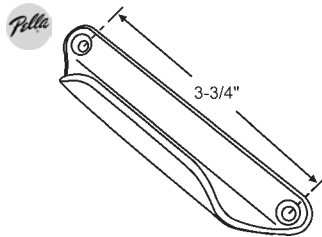

Part #	Finish
50-980CHP	Champagne
50-980W	White
50-980BRS	Brass Plated

Plastic

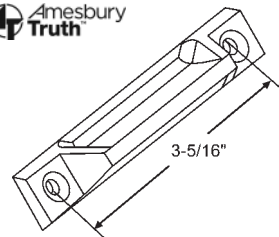

Part #	Finish
50-404-1	Bronze
50-404-3	White
50-404-2	Gold
50-404-4	Coppertone

Zinc Die Cast

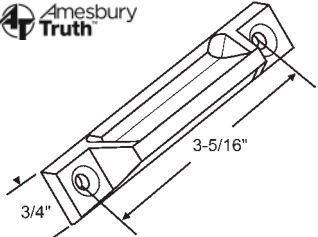

Part #	Finish
900-16321	White
900-16321BR	Brown
900-16321B	Black
900-16321BG	Beige

Plastic

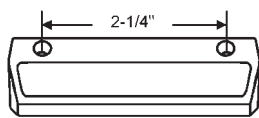

Part #	Finish
900-19442	Beige
900-19442B	Brown
900-19442T	Tan

Plastic

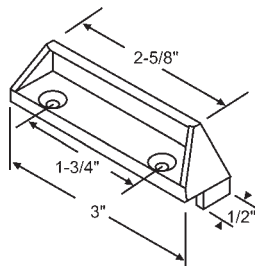

Part #	Finish
900-16287	White

Plastic
SEASONALL

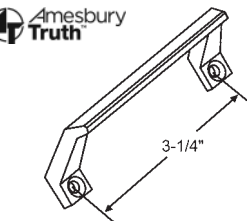

Part #	Finish
50-405-1	Bronze
50-405-3	White
50-405-5	Brass Plated
50-405-6	Clay

Die Cast

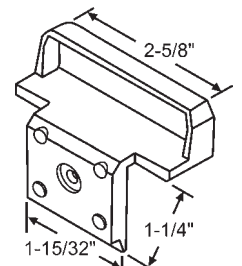

Part #	Finish
900-8729	White

Plastic
THERMALGARD

WINDOW REPLACEMENT HARDWARE

SASH LIFTS

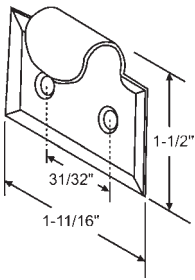

Part #	Finish
50-966	Solid Brass

Hook Lift w/ Screws (2 Per Pack)

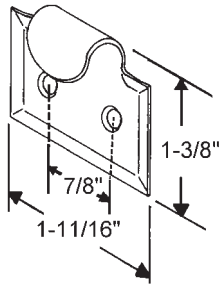

Part #	Finish
900-6687	Brass Plated

Includes Screws

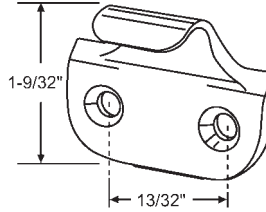

Part #	Finish
50-475-1	Bronze
50-475-3	White
50-475-13	Copper Nickel
50-475-36	Antique Brass
50-475-5	Bright Brass

Zinc Die Cast

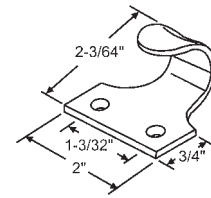

Part #	Finish
50-1101BRS	Solid Brass
50-1101CH	Chrome

Also available in satin chrome finish.

MIGHTON

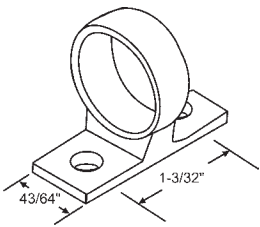

Part #	Finish
50-1102BRS	Solid Brass

Ring Pull. Also available in satin chrome finish.

MIGHTON

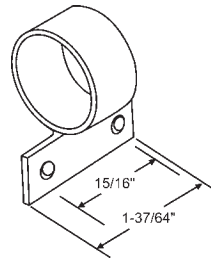

Part #	Finish
50-1103BRS	Solid Brass

Ring Pull. Also available in satin chrome finish.

MIGHTON

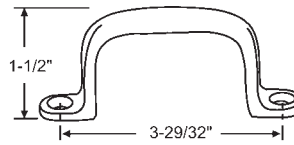

Part #	Finish
900-9194	Bronze

Cast Bronze

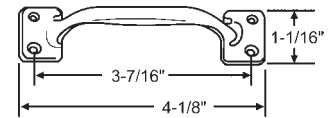

Part #	Finish
50-455-1	Bright Brass

Solid Brass with Screws

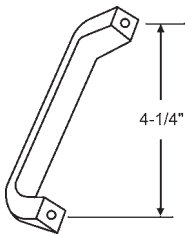

32-281
Natural Finish
THORN

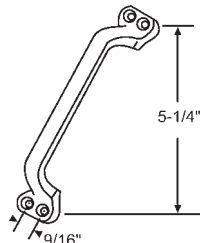

32-282
Natural Finish

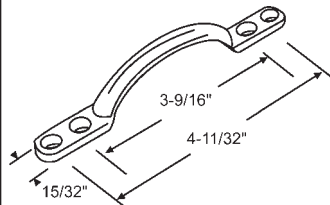

50-1104CH
Round Edge Dee Handle
Chrome
MIGHTON

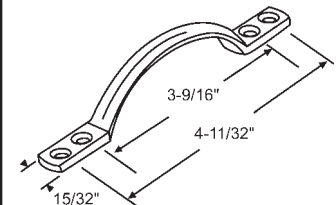

50-1104BRS
Square Edge Dee Handle
Solid Brass
MIGHTON

LIMIT LOCKS

TILT LATCH SWEEP LOCK

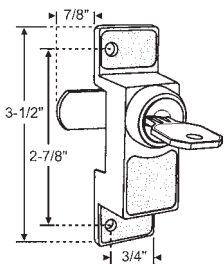

Part #	Finish	Hand
50-1374B	Black	Shown
50-1374W	White	Shown

Window/Door Limit Lock with Key. Zinc Die Cast

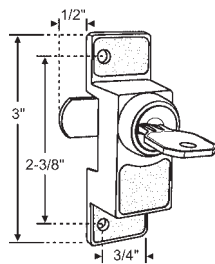

Part #	Finish	Hand
50-737RH	Chrome	Shown
50-737LH	Chrome	Opposite

Window/Door Limit Lock with Key
Zinc Die Cast

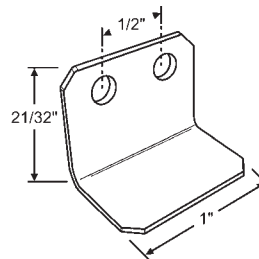

50-837
Metal Keeper for Limit Locks

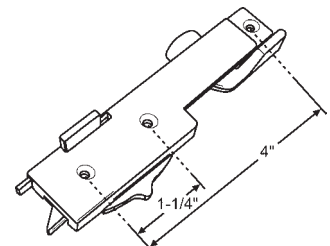

Part #	Finish
50-1258WA	White
50-1258BZA	Bronze

Sold in Sets Only. LH Shown

MILESTONE/FLORIDA EXTRUDERS

WINDOW REPLACEMENT HARDWARE

WINDOW OPENING CONTROL DEVICES (WOCD)

Window Opening Control Device Kit

The ultimate solution in residential window safety is now available with the convenience of an all-inclusive kit. Easy to fit with no routing required, the ASSA ABLOY WOCD Kit is designed for use in windows with a standard 11.1mm (7/16") hardware cavity.



Features

- 4" and 6" lengths available
- Tested and compliant to ASTM F2090-13
- Limits venting to less than 4" of opening
- Compatible with standard countersunk fixings
- Austenitic 304 stainless steel for enhanced corrosion resistance
- Convenience of all-inclusive bagged kit for ease of installation
- No fabrication required - cavity fitting
- Available in 13mm, 16mm and 17mm cavity heights

Part Number	Description	Hand
39-1106LHSS-4KIT	4" Casement WOCD Kit	LH
39-1106RHSS-4KIT	4" Casement WOCD Kit	RH
39-1106LHSS-6KIT	6" Casement WOCD Kit	LH
39-1106RHSS-6KIT	6" Casement WOCD Kit	RH

Packed and Sold as Kit. Kit Contains 11.1mm Pin Strike, 4 Mounting Screws, Operational Sill Sticker, Indication Glass Sticker and Installation Instructions.

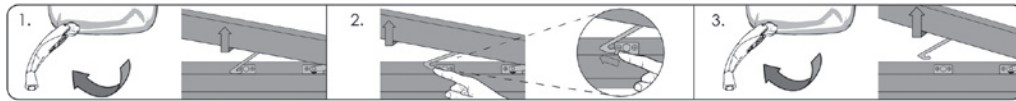

Face Fix Single Action

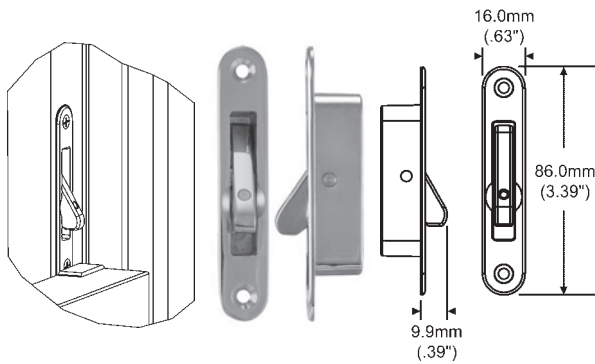

The Face Fix version is fitted into the stiles of the Top Sash - one on either side.

The units are single action, so fitting two ensures compliance with ASTM F2090 2008 and 2010.

The unit is primarily factory fitted as access to the sash is available prior to installation in the window frame. However, provided the sashes can be removed easily, the Face fix version is also suitable for use where the sashes have already been installed.

Two screws are used to fix each unit in place. Fixing is through the front of the unit and into the sash. The Face fix version is for use on Timber, Vinyl, Aluminium and Fibreglass sashes.

Part Number	Color
50-1367FFBRS	Brass
50-1367FFORBZ	Oil Rubbed Bronze
50-1367FFW	White
50-1367FFCH	Chrome
50-1367FFSCH	Satin Chrome

Packed and Sold as Kit. Kit Contains 2 Devices, 4 Screws and 2 Bumpers

Side Fix Single Action

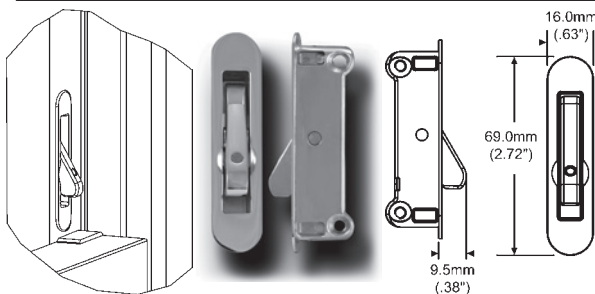

The Side Fix version is fitted into the stiles of the Top Sash - one on either side.

The units are single action, so fitting two ensures compliance with ASTM F2090 2008 and 2010.

These units have been Focus group tested and have been proven to be operable without prior knowledge or tools.

The unit is primarily factory fitted as access to the sash is available prior to installation in the window frame. However, provided the sashes can be removed easily, the Side fix version is also suitable for use where the sashes have already been installed.

Two screws are used to fix each unit in place. Fixing is through the side of the unit and into the sash. Screw holes are not visible and the units are therefore tamper-proof. The Side fix version is for use on Timber, Vinyl, Aluminium and Fibreglass sashes.

Part Number	Color
50-1366SFCH	Chrome
50-1366SFORBZ	Oil Rubbed Bronze
50-1366SFW	White

Packed and Sold in Pairs

WINDOW REPLACEMENT HARDWARE

WINDOW OPENING CONTROL DEVICES (WOCD)

Reverse Retrofit Single Action

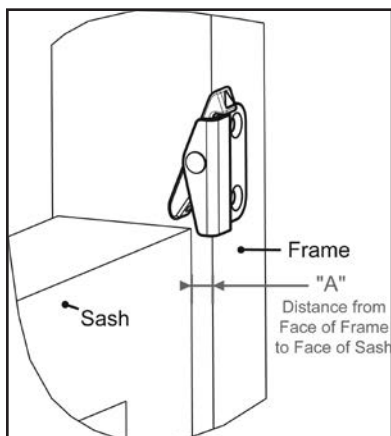

The Reverse Retrofit Angel Ventlock is the ideal limit control device in after-market applications. This Window Opening Control Device (WOCD) can be mounted on a vinyl, wood or aluminum single hung or double hung window.

The Reverse Retrofit Angel Ventlock version attaches to the window frame and must be mounted to restrict the sash opening to less than four inches. These units are single action, so installing one on either side of the window frame ensures compliance with the code ASTM F2090-2008 and 2010.

Various sizes and finishes of the Reverse Retrofit version are shown below. Selection is dependent upon the distance from the face of the frame to the face of the sash. Simply measure the distance between the two and choose the part number from the chart below.

All Reverse Retrofit Angel Ventlocks Packed with Screws & Sold in Pairs (RH Shown).

Made of Stamped Steel with Stainless Steel Pin and Spring

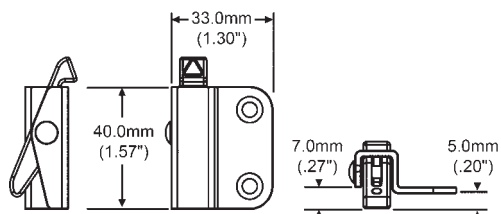

Part Number	Color	"A" Dimension
50-1356XDBCH	Chrome	-5/64" to 0"
50-1356XDBORBZ	Oil Rubbed Bronze	
50-1356XDBW	White	

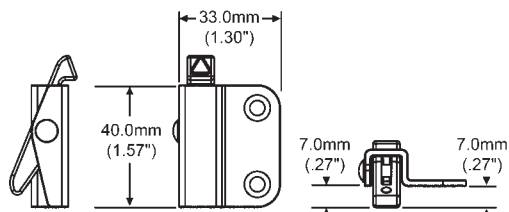

Part Number	Color	"A" Dimension
50-1357DBCH	Chrome	1/32" to 5/64"
50-1357DBORBZ	Oil Rubbed Bronze	
50-1357DBW	White	

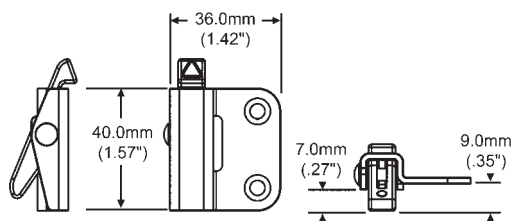

Part Number	Color	"A" Dimension
50-1358MBCH	Chrome	1/8" to 5/32"
50-1358MBORBZ	Oil Rubbed Bronze	
50-1358MBW	White	

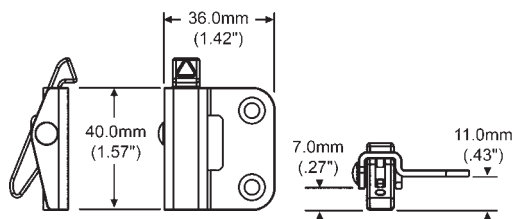

Part Number	Color	"A" Dimension
50-1359MBCH	Chrome	13/64" to 15/64"
50-1359MBORBZ	Oil Rubbed Bronze	
50-1359MBW	White	

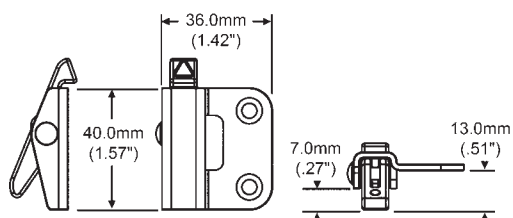

Part Number	Color	"A" Dimension
50-1360SBCH	Chrome	9/32" to 5/16"
50-1360SBORBZ	Oil Rubbed Bronze	
50-1360SBW	White	

WINDOW REPLACEMENT HARDWARE

WINDOW OPENING CONTROL DEVICES (WOCD)

Reverse Retrofit Single Action

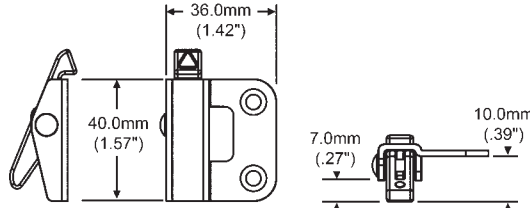
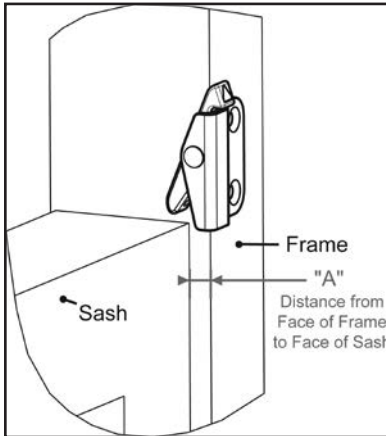

Part Number	Color	"A" Dimension
50-1361XSBCH	Chrome	23/64" to 25/64"
50-1361XSBORBZ	Oil Rubbed Bronze	
50-1361XSBW	White	

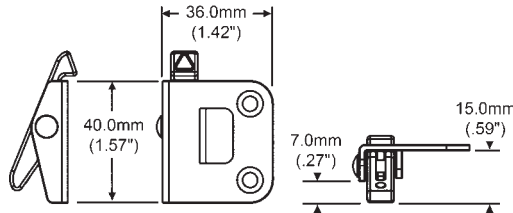

Part Number	Color	"A" Dimension
50-1362FBCH	Chrome	7/16" to 15/32"
50-1362FBORBZ	Oil Rubbed Bronze	
50-1362FBW	White	

Standard Retrofit Single Action

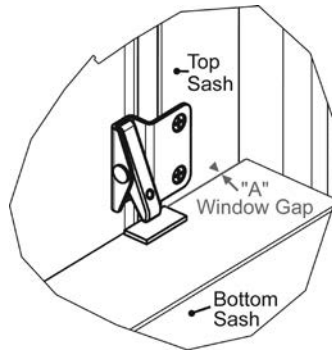

The Standard Retrofit Angel Ventlock is another ideal limit control device for use in after-market applications. This Window Opening Control Device (WOCD) is mounted to the top sash on a double hung wood window.

The Standard Retrofit Angel Ventlock version fits into the stile of the top sash and must be mounted to restrict the bottom sash opening to less than four inches. These units are single action, so installing one on either side of the sash ensures compliance with the code ASTM F2090 - 2008 and 2010.

Various sizes and finishes of the Standard Retrofit version are shown below. Selection is determined by measuring the window gap between the top sash and the bottom sash. Simply measure the distance between the two and select the part number from the chart below.

All standard retrofit single action angel ventlocks packed with screws & sold in pairs (RH Shown). made of stamped steel, with stainless steel pin and spring.

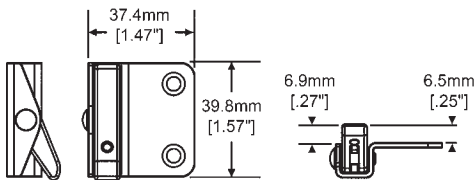

Part Number	Color	Bend	"A" Dimension
50-1363SBORBZ	Oil Rubbed Bronze	Standard	1/8" to 5/32"
50-1363SBW	White	Standard	

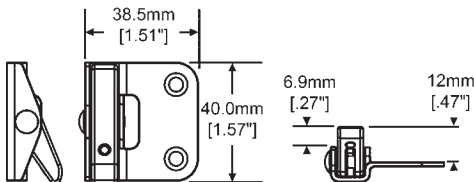

Part Number	Color	Bend	"A" Dimension
50-1364SBCH	Chrome	Shallow	5/16" to 11/32"
50-1364SBW	White	Shallow	

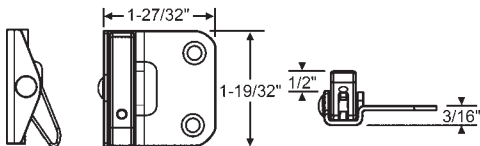

Part Number	Color	Bend	"A" Dimension
50-1390SBXCH	Chrome	Shallow w/ Extended Bracket	5/16" to 11/32"
50-1390SBXORBZ	Oil Rubbed Bronze	Shallow w/ Extended Bracket	
50-1390SBXW	White	Shallow w/ Extended Bracket	

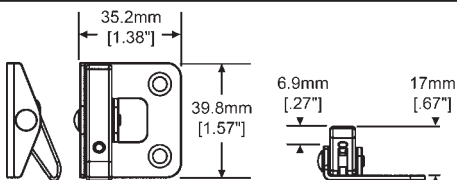

Part Number	Color	Bend	"A" Dimension
50-1365FBCH	Chrome	Flat	33/64" to 35/64"
50-1365FBORBZ	Oil Rubbed Bronze	Flat	
50-1365FBW	White	Flat	

WINDOW REPLACEMENT HARDWARE

WINDOW OPENING CONTROL DEVICES (WOCD)

Reverse Retrofit Dual Action

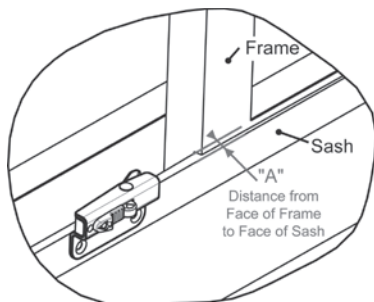

The Dual Action Reverse Retrofit Angel Ventlock is another ideal limit control device for use in aftermarket applications. This Window Opening Control Device (WOCD) is primarily used on sliding windows.

The Dual Action Reverse Retrofit Angel Ventlock version attaches to the window frame and must be mounted to restrict the sash opening to less than four inches. Dual action means that two separate actions are required to operate the unit. Only one dual action unit is required to ensure compliance with the code ASTM F2090-2008 and 2010.

Packed with Screws & Sold Individually Specify RH or LH (RH Shown)
Made of Stamped Steel with Stainless Steel Pin and Spring

Various sizes and finishes of the Dual Action Reverse Retrofit version are shown below. Selection is dependent upon the distance from the face of the frame to the face of the sash. Simply measure the distance between the two and choose the part number from the chart below.

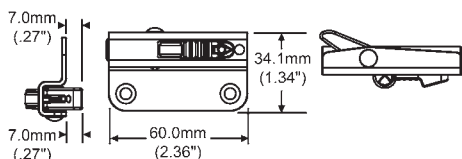

Part Number (Left Hand)	Part Number (Right Hand)	Color	Bend	"A" Dimension
50-1353-DBCH-LH*	50-1353-DBCH-RH	CHROME	DEEP	1/32" to 7/64"
50-1353-DBORBZ-LH*	50-1353-DBORBZ-RH	OIL RUBBED BRONZE		
-	50-1353-DBW-RH	WHITE		

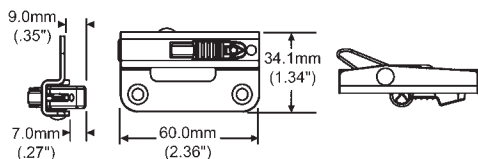

Part Number (Left Hand)	Part Number (Right Hand)	Color	Bend	"A" Dimension
50-1353-MBCH-LH	50-1353-MBCH-RH	CHROME	MEDIUM	1/8" to 3/16"
50-1353-MBORBZ-LH	50-1353-MBORBZ-RH	OIL RUBBED BRONZE		
50-1353-MBW-LH	50-1353-MBW-RH	WHITE		

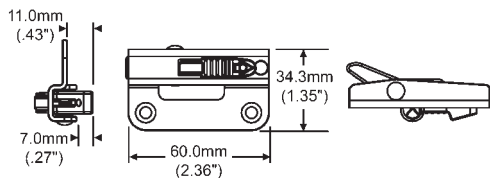

Part Number (Left Hand)	Part Number (Right Hand)	Color	Bend	"A" Dimension
50-1353-M56CH-LH	50-1353-M56CH-RH	CHROME	M56	13/64" to 17/64"
50-1353-M56ORBZ-LH	50-1353-M56ORBZ-RH	OIL RUBBED BRONZE		
50-1353-M56W-LH	50-1353-M56W-RH	WHITE		

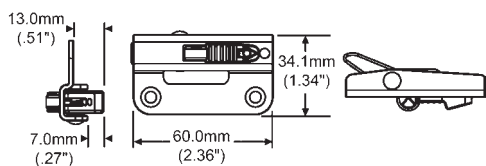

Part Number (Left Hand)	Part Number (Right Hand)	Color	Bend	"A" Dimension
50-1353-SBCH-LH*	50-1353-SBCH-RH	CHROME	SHALLOW	9/32" to 11/32"
50-1353-SBORBZ-LH*	50-1353-SBORBZ-RH	OIL RUBBED BRONZE		
-	50-1353-SBW-RH	WHITE		

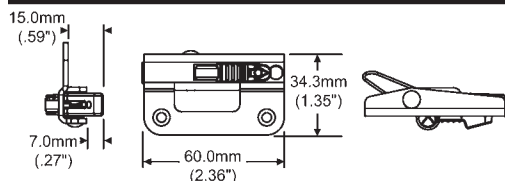

Part Number (Left Hand)	Part Number (Right Hand)	Color	Bend	"A" Dimension
50-1353-XSBCH-LH	50-1353-XSBCH-RH	CHROME	XSB	23/64" to 27/64"
50-1353-XSBORBZ-LH	50-1353-XSBORBZ-RH	OIL RUBBED BRONZE		
50-1353-XSBW-LH	50-1353-XSBW-RH	WHITE		

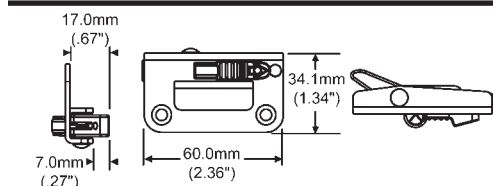

Part Number (Left Hand)	Part Number (Right Hand)	Color	Bend	"A" Dimension
50-1353-FBCH-LH	50-1353-FBCH-RH	CHROME	FLAT	7/16" to 33/64"
50-1353-FBORBZ-LH	50-1353-FBORBZ-RH	OIL RUBBED BRONZE		
50-1353-FBW-LH	50-1353-FBW-RH	WHITE		

*call for availability

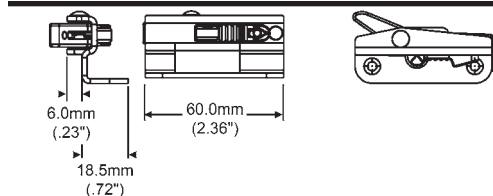

Part Number (Left Hand)	Part Number (Right Hand)	Color
50-1541LHW	50-1541RHW	White

Sill Mounted

WINDOW REPLACEMENT HARDWARE

WINDOW OPENING CONTROL DEVICES (WOCD)

Mini Angel

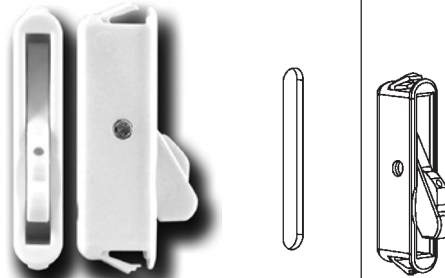
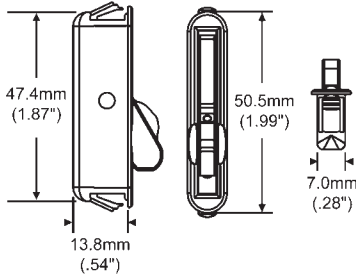

Part Number	Color
50-1453TN	Tan
50-1453W	White

Packed and Sold Individually

The Mini Angel is for use on Vinyl, Aluminum and Fiberglass double and single hung sash windows.

The units are single action, so fitting two ensures compliance with ASTM F2090 - 2008 and 2010.

The Mini Angel is fitted into the stiles of the top sash - one on each side.

The units are single action, so fitting two ensures compliance with ASTM F2090 - 2008 and 2010.

The unit is primarily factory-fitted as access to the sash is required. However, provided the sashes can be removed easily, the Mini Angel is also suitable for use where the sashes have already been installed.

The unit is clipped into a slot in the face of the top sash. The units are therefore tamper-proof.

PLASTIC WINDOW OPENING CONTROL DEVICES (WOCD)

All of the following WOCD single and dual action devices on this page are tested and comply with the ASTM F2090-2008 & 2010 code when properly installed.

Other finishes available but may require minimum quantities. Other WOCD's available upon request. Detailed drawings available with instructions. Please contact your account manager for details.

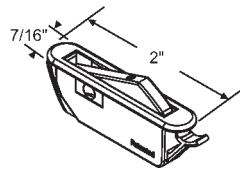

Fits slot size 1.89" x .284"

The 50-2000 series is a single action WOCD. This device is designed to fit into the stile of an opposing sash and is engineered for insertion directly into a standard vent stop slot. With a housing that will fit any wall thickness from (0.05") to (0.13"), the 50-2000 series is the most versatile WOCD on the market. This WOCD can be installed both in the factory and in the field in just a few seconds.

Part Number	Finish
50-2000BEW	Blue White

Part Number	Finish
50-2000WA	White

Sold as Set

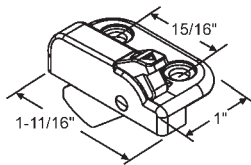

Our 50-2007 series is a single action WOCD designed to install directly to the face of the window jamb and interact with the active sash of any hung or sliding window. This device comes with mounting hardware for proper installation and is available in right & left handing. The 50-2007 series was designed to be applied in the field or in the factory.

Part Number	Finish
50-2007BEW	Blue White

Packed and Sold in Pairs. Left Hand Shown

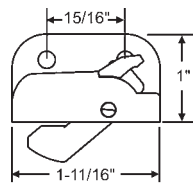

Our 50-2008 series is a single action WOCD designed to install directly to the window jamb extension or return and interact with the active sash of any hung or sliding window. This device comes with mounting hardware to assure proper installation and is available in right & left handing. The 50-2008 series was designed to be applied in the field or in the factory.

Part Number	Finish
50-2008BEW	Blue White

Packed and Sold in Pairs. Left Hand Shown

WINDOW REPLACEMENT HARDWARE

PLASTIC WINDOW OPENING CONTROL DEVICES (W OCD)

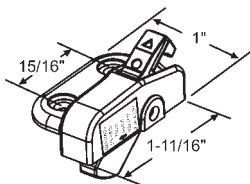

Our 50-2003 series is a dual action W OCD designed to install directly to the face of the window jamb and interact with the active sash of any hung or sliding window. This device comes with mounting hardware to assure proper installation and is available in right & left handing. The 50-2003 series was designed to be applied in the field or in the factory.

Part Number	Handing	Finish
50-2003LHBEW	LH (shown)	Blue White
50-2003RHBEW	RH	Blue White

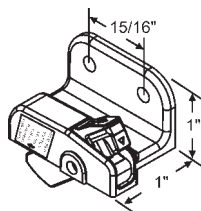

Our 50-2005 series is a dual action W OCD designed to install directly to the window jamb extension or return and interact with the active sash of any hung or sliding window. This device comes with mounting hardware to assure proper installation and is available in right & left handing. The 50-2005 series was designed to be applied in the field or in the factory.

Part Number	Handing	Finish
50-2005LHBEW	LH (shown)	Blue White
50-2005RHBEW	RH	Blue White

WINDOW OPENING CONTROL DEVICES (W OCD)

SafeGard™ Limiting Control Device for Casement Windows



SafeGard™ Provides Peace Of Mind On Casement Window Applications.

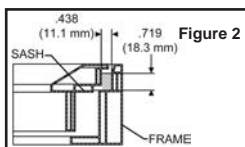
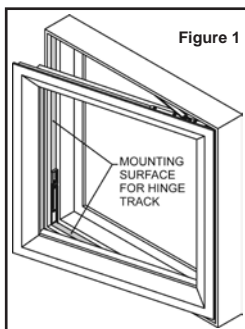

- The SafeGard™ is the Industry's first limiting control device offered for casement windows.
- The SafeGard™ Limit Device was tested & certified to meet ASTM F2090-10 code requirements. The ASTM F2090 addresses window fall prevention, that helps protect against potential falls by children through open windows.
- The SafeGard™ Limit Device provides a means that will limit the venting of the window to less than 4".
- As required by code, the SafeGard™ Limit Device has a two (2) action operation to fully open the window for egress purposes. This operation can be performed without the use of keys or tools.
- Easy to follow opening and release instructions appear on the vent arm. Note: The device will re-latch or reset automatically when window is in closed position.
- The SafeGard™ Limit Device's track, arm and rivet are made entirely of authentic stainless steel with Delran cover and tab.
- The SafeGard™ Limit Device is reliable, easy to install and easy to operate. This device meets today's more stringent safety requirements. Please consult local building codes for W OCD and applicable requirements.

Part Number	Handing
39-933LH	LH
39-933RH	RH

Includes: Arm Assembly, Track Assembly, Template, Window Label, Screw Pack (4 screws) and Operating and Installation Instructions.

Ordering Instructions:

1. Determine window handing by viewing from the outside looking in. If the casement window hinge is on the right side, you need a right hand limiting device.
2. Confirm the hinge cavity on your casement window (See Fig. 2). The hinge cavity needs to be .719 (23/32") wide x .438 (7/16") deep.

Note: The SafeGard™ Limiting Control Device will only work in casement windows that have a standard 2-bar hinge cavity with measurements as stated above.

***This Device is Not Designed for Awning Windows.
This Device is Not Designed for Casement Windows with a 4-Bar Hinge.***



LH Arm



RH Arm

WINDOW REPLACEMENT HARDWARE

VENT LOCKS

Key Operated Vent Lock

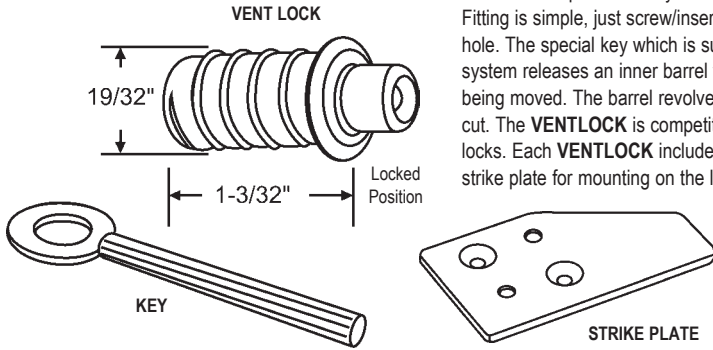

The new innovative **VENTLOCK** acts as a major deterrent to snatch thieves who spot what they consider is an easily opened window. Fitting is simple, just screw/insert it into the appropriate diameter drill hole. The special key which is supplied as part of the **VENTLOCK** system releases an inner barrel which prevents the window from being moved. The barrel revolves freely preventing it from being cut. The **VENTLOCK** is competitively priced against existing window locks. Each **VENTLOCK** includes a steel operation key and a brass strike plate for mounting on the lower sash check rail.

Part #	Finish
50-446	Solid Brass
50-446CH	Chrome

Vent Lock with Key and Strike
MIGHTON

MEETS: ASTM F 2090 Standard Specification for Window Fall Prevention Devices With Emergency Escape (Egress) Release Mechanisms

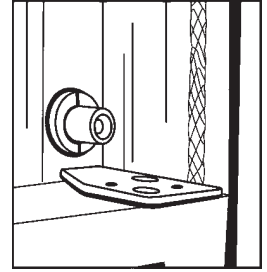

Open Position Shown

Push and Twist Keyless Vent Lock

Finger Operated: Push and Turn with Your Finger

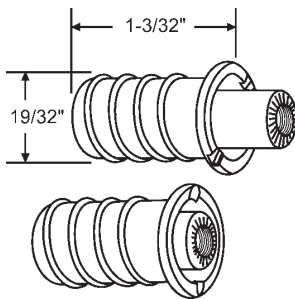

MEETS: ASTM F 2090 Standard Specification for Window Fall Prevention Devices With Emergency Escape (Egress) Release Mechanisms

The natural companion product to Key Operated Ventlocks. Use where Fire Egress may be of concern or above ground floor level.

Part #	Finish
50-1201CH	Chrome
50-1201BRS	Solid Brass

Push and Twist Ventlock. Solid Brass
MIGHTON

Brass Vent Lock for PVC Vinyl Windows

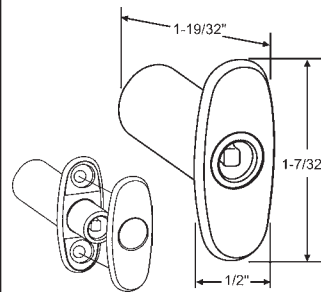

Ventlock is Quick and Easy to Install

1. Drill Hole
2. Insert Ventlock
3. Drill Rivet Holes
4. POP Rivet Ventlock into the Sash
5. Conceal Rivets with Self Adhesive Trims

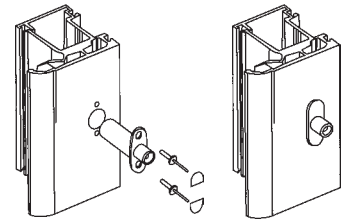

50-1106
Vent Lock for PVC Vinyl Windows
Includes Key
MIGHTON

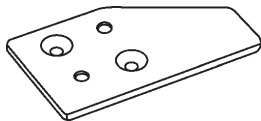

Part #	Finish
50-1105BRS	Solid Brass
50-1105CH	Chrome
50-1105SCH	Satin Chrome

Vent Lock Strike Plate Only
MIGHTON



59-73M
Ventlock Hand Tool
MIGHTON

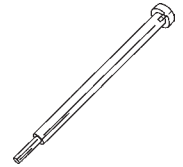

59-73
Ventlock Tool for Cordless Drill
MIGHTON

SASH RESTRICTOR ASSEMBLY KIT

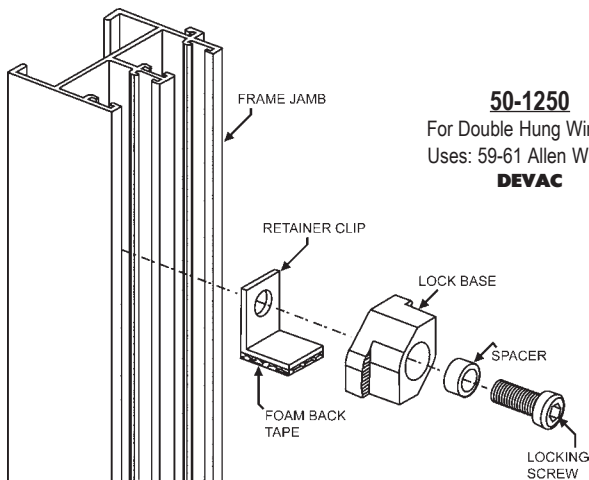

50-1250

For Double Hung Window.
Uses: 59-61 Allen Wrench
DEVAC

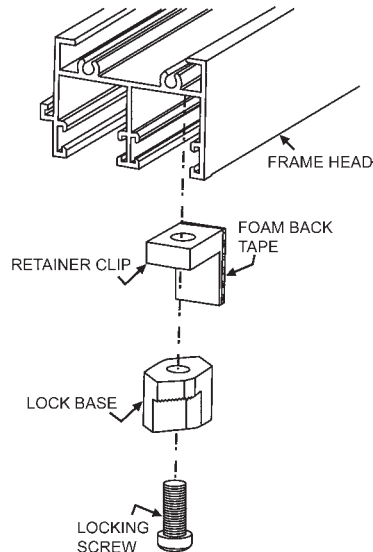

50-1253

For Sliding Window. Uses:
59-61 Allen Wrench
DEVAC

WINDOW REPLACEMENT HARDWARE

SLIDING WINDOW ROLLERS WITH METAL HOUSING

Sliding window rollers in order by roller diameter, length and width.

5/16"

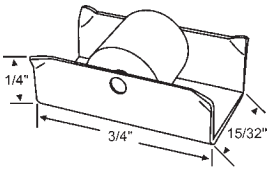

52-615

5/16" Dia. Nylon Wheel

11/32"

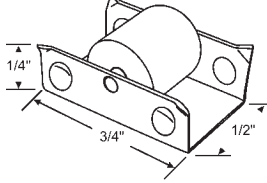

900-1278

11/32" Dia. x 3/8" Nylon Wheel

3/8"

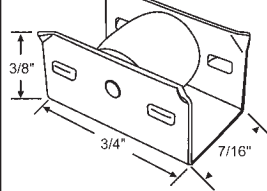

52-616

3/8" Dia. Nylon Wheel

29/64"

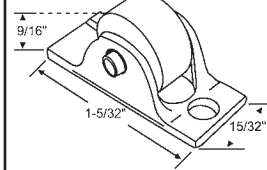

900-10027

29/64" Dia. Nylon Wheel with Die Cast Housing

15/32"

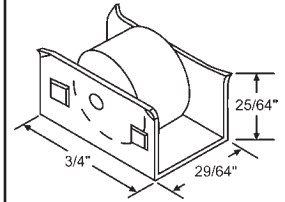

900-1285

15/32" Dia. Flat Nylon Wheel

1/2"

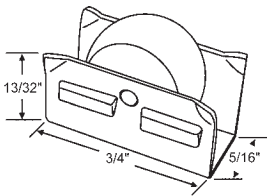

52-614

1/2" Dia. Nylon Wheel

9/16"

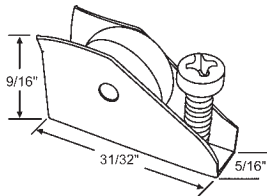

52-683

1/2" Dia. Nylon Wheel
CAPITOL

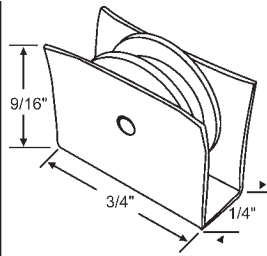

Part #	Description
52-613	Nylon Wheel
52-675	Metal Wheel

9/16" Wheel

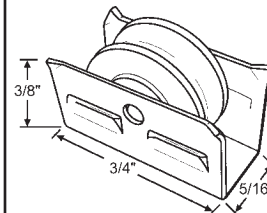

Part #	Description
900-13091	Nylon Wheel
900-13091S	Steel Wheel

9/16" Wheel

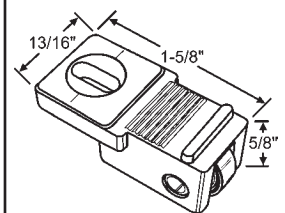

52-682

9/16" Dia. Metal Wheel with Die Cast Housing. Used with Plate 900-16252

SLIDING WINDOW ROLLERS WITH PLASTIC HOUSING

Sliding window rollers in order by roller diameter, length and width.

5/8"

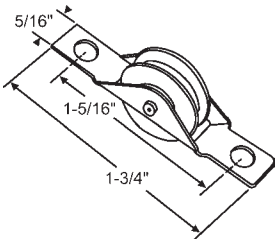

52-650

5/8" Dia. Nylon Wheel

9/32"

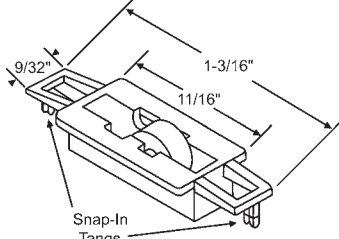

52-766

9/32" Dia. Metal Wheel

5/16"

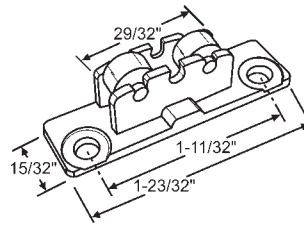

900-10193

Two 9/32" Dia. Aluminum Wheels
Nylon Housing
GENERAL ALUMINUM

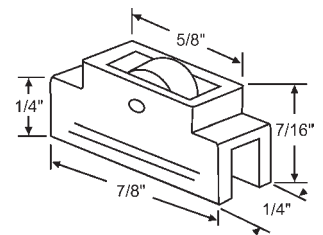

52-643

5/16" Dia. Metal Roller

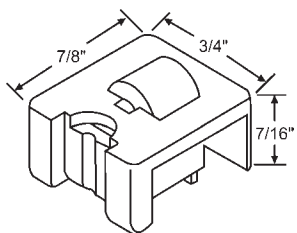

900-11416

5/16" Dia. Metal Wheel
w/Fixed Axle

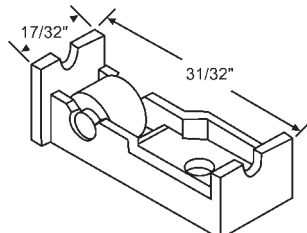

900-14615

5/16" Dia. Flat Nylon Wheel w/Fixed Axle
KRESTMARK

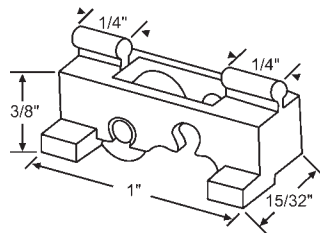

900-22

5/16" Dia. Flat Metal Wheel
w/Fixed Axle

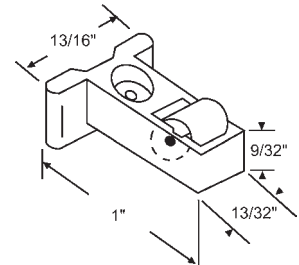

52-638

5/16" Dia. Metal Wheel

WINDOW REPLACEMENT HARDWARE

SLIDING WINDOW ROLLERS WITH PLASTIC HOUSING

Sliding window rollers in order by roller diameter, length and width.

3/8"

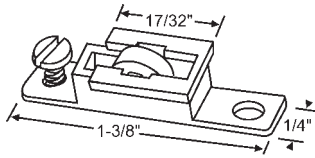

52-856
5/16" Dia. Flat Nylon Wheel
White
ACORN

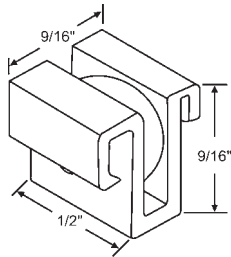

52-646
3/8" Dia. Nylon Wheel

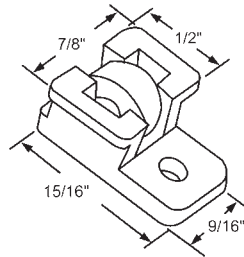

900-18013
3/8" Dia. Flat Metal Wheel
w/Fixed Axle

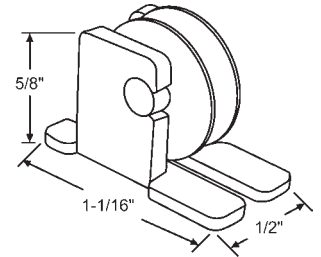

52-644
3/8" Dia. Metal Wheel
FULLVIEW

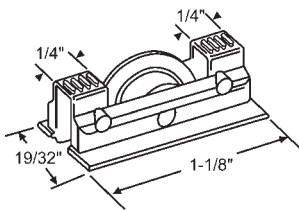

900-10784
3/8" Dia. Nylon Wheel with 1/2" Dia. Single
Side Flange

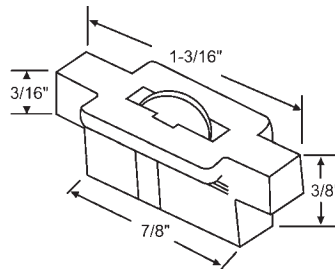

52-648
3/8" Dia. Metal Wheel

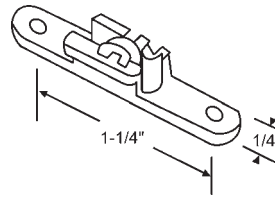

52-649
3/8" Dia. Metal Wheel

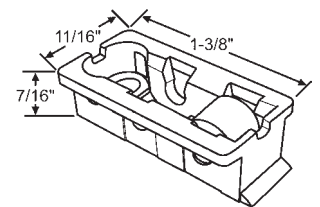

52-913
3/8" Dia. Brass Wheel
Black Nylon

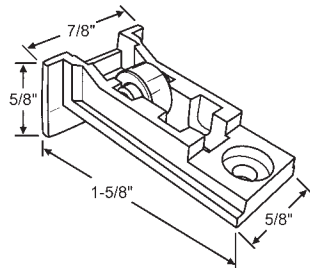

900-10606
White Nylon Housing with 3/8" Brass
Wheel

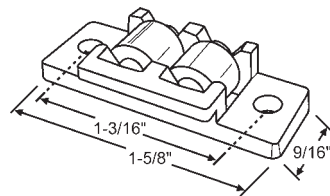

52-737
Two 3/8" Dia. Flat Steel Wheel

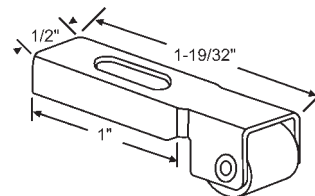

900-1064
3/8" Dia. Flat Nylon Wheel

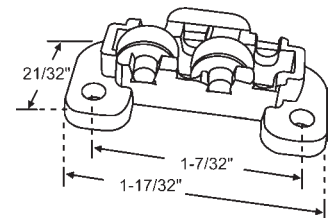

52-789
Two 3/8" Dia. Brass Wheels
Black

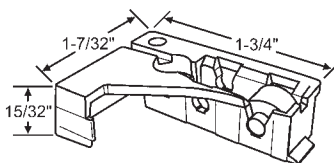

Part #	Hand
52-914LH	Shown
52-914RH	Opposite

3/8" Dia. Brass Wheel
Black Nylon

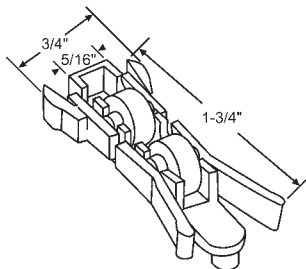

52-724
Two 3/8" Dia. Flat Brass Wheels w/
Separate Axles
REYNOLDS

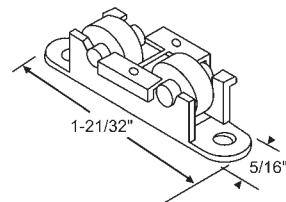

900-10419
Two 3/8" Dia. Nylon Wheels

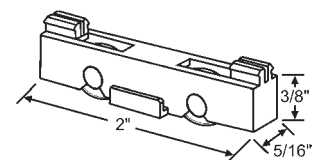

52-985
Two 3/8" Dia. Brass Wheels with Nylon
Housing.
VIKING

WINDOW REPLACEMENT HARDWARE

SLIDING WINDOW ROLLERS WITH PLASTIC HOUSING

Sliding window rollers in order by roller diameter, length and width.

25/64"

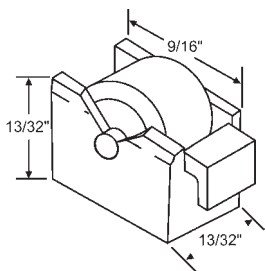

52-647

25/64" Dia. Metal Wheel

13/32"

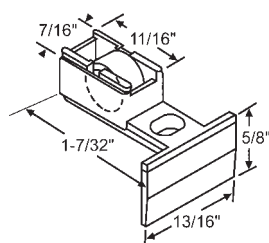

Part #	Description
900-9008	Nylon Wheel
900-9008M	Steel Wheel

13/32" Dia. Flat Wheel w/Fixed Axle

PENNCO

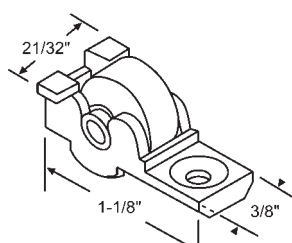

900-9814

13/32" Dia. Nylon Wheel

PENNCO

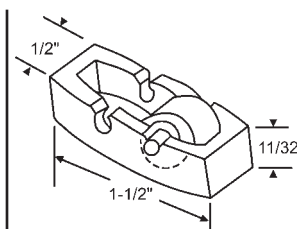

52-629

13/32" Dia. Metal Wheel

CAPITOL

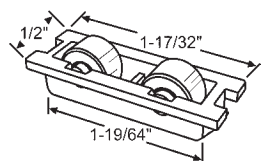

52-540

White Nylon Body w/ (2) 13/32" Brass Wheels

REHAU

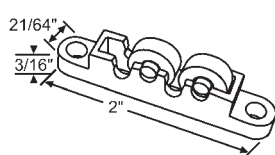

52-722

Two 13/32" Dia. Flat Brass Wheels w/ Separate Axles. White

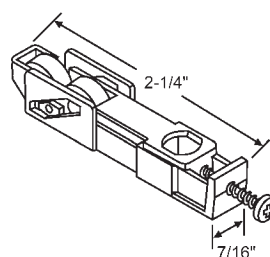

900-19102

Two 13/32" Dia. Wheels

RUSCO

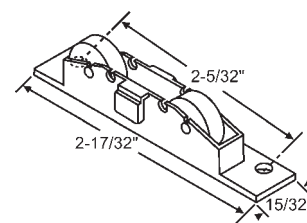

52-799

Two 13/32" Dia. Aluminum Wheels w/ Fixed Axles

7/16"

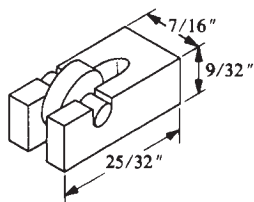

900-12009

7/16" Dia. Nylon Wheel

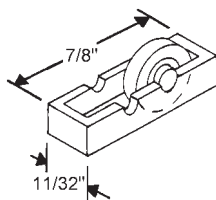

900-9860

7/16" Dia. Flat Metal Roller with Separate Axle

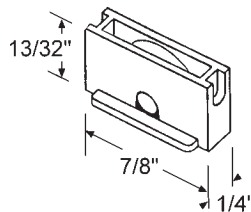

52-716

7/16" Flat Nylon Wheel

BETTER BILT

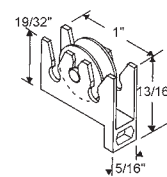

900-11290

7/16" Dia. Metal Wheel w/Fixed Axle

ALENCO

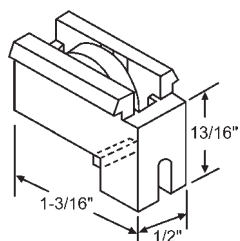

900-11944NS

7/16" Dia. Brass Wheel Projects 1/8" from Housing

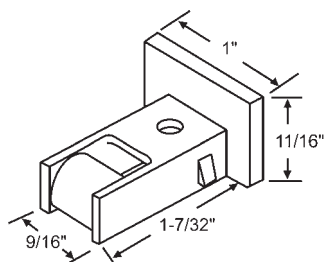

Part #	Description
52-686	Nylon Wheel
52-686M	Steel Wheel

7/16" Dia. Wheel

MEDALLION

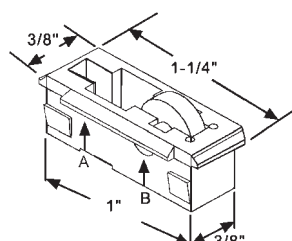

52-733

7/16" Dia. Flat Metal Wheel w/Separate Axles. Roller Projects 1/8" in Position "A" and 1/16" in Position "B".

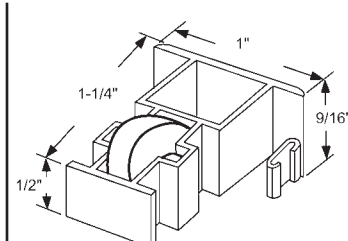

52-843

7/16" Dia. Metal Wheel

NU-AIR

WINDOW REPLACEMENT HARDWARE

SLIDING WINDOW ROLLERS WITH PLASTIC HOUSING

Sliding window rollers in order by roller diameter, length and width.

7/16"

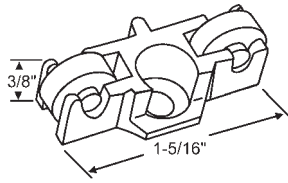

52-658

Two 7/16" Dia. Nylon Wheels

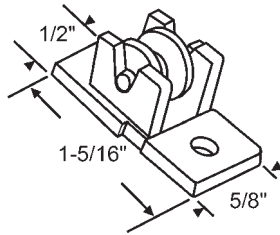

900-19965

7/16" Dia. x 5/16" Wide Concave Wheel w/ Fixed Axle. White

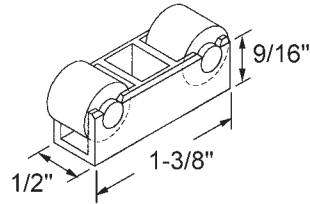

52-514

Two 7/16" Dia. Nylon Wheels

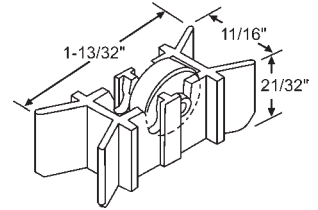

900-12993A

7/16" Dia. Flat Metal Wheel

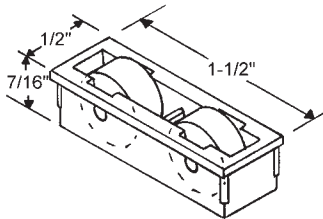

900-17801

Two 7/16" Dia. Brass Wheels
NORANDEX

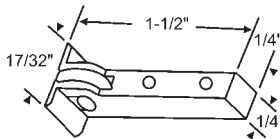

900-92

7/16" Dia. Flat Nylon Wheel
GUARANTEED

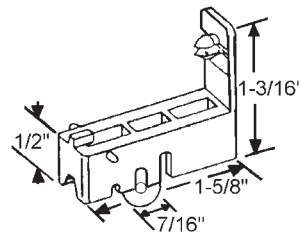

900-1067

7/16" Dia. Nylon Wheel

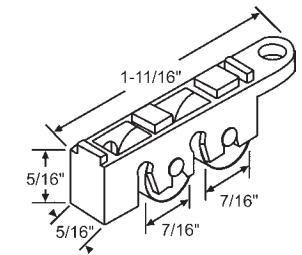

900-19941

Two 7/16" Dia. Brass Wheels
w/Separate Axles

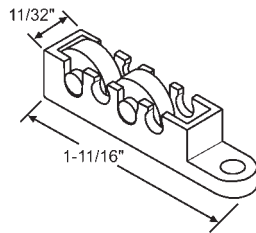

Part #	Description
900-15615	Brass Wheel
900-15615SS	Stainless Steel Wheel

Two 7/16" Dia. Wheels

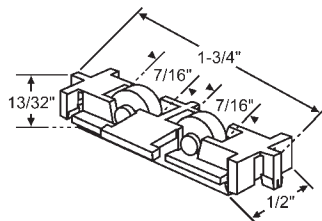

52-917

Nylon

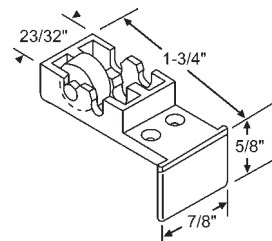

52-690

7/16" Dia. Flat Wheel
w/Fixed Axle
CAPITOL

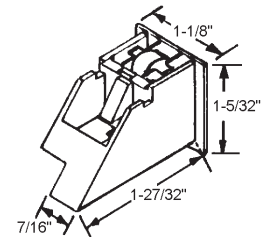

52-715A

RH/LH Set, Black
Two 7/16" Dia. Metal Wheels

15/32"

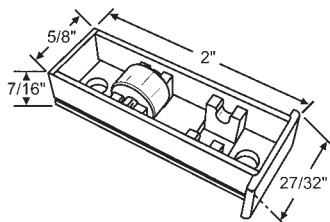

52-981

7/16" Brass Wheel
LAWSON

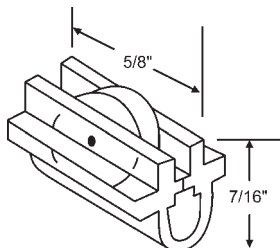

52-661

15/32" Dia. Nylon Wheel

IDA

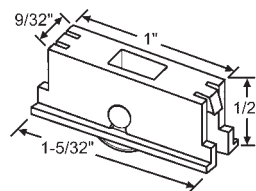

52-417

15/32" Dia. Brass Wheel
White Nylon Housing
ATRIUM

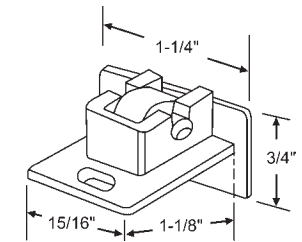

900-17797

15/32" Dia. x 1/4" Wide Flat Metal Wheel
w/Fixed Axle
Black

WINDOW REPLACEMENT HARDWARE

SLIDING WINDOW ROLLERS WITH PLASTIC HOUSING

Sliding window rollers in order by roller diameter, length and width.

15/32"

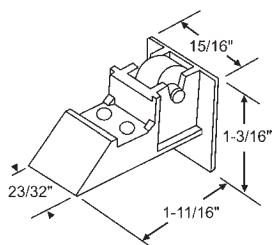

900-19580BA

15/32" Dia. Flat Metal Wheel
w/Fixed Axle. Black
NORANDEX

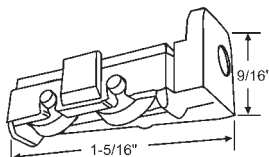

Part #	Hand
900-9391LHA	Shown
900-9391RHA	Opposite

Two 15/32" Dia. Brass Wheel
ACORN

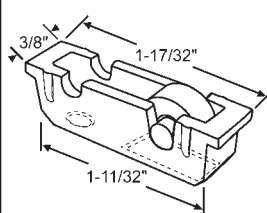

52-823

15/32" Metal Roller w/ Stainless Steel
Axle. Nylon Body

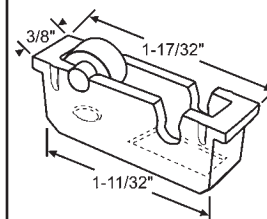

52-823L

15/32" Steel Wheel with Nylon Body.
Wheel in Lower Position

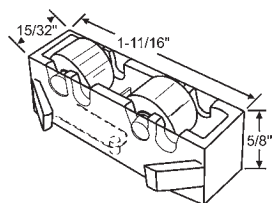

52-533

15/32" Dia. Brass Wheel

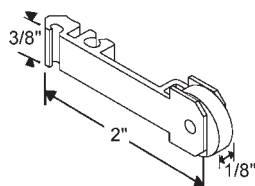

Part #	Description
52-778	Brass Plated Wheel

15/32" Dia. Wheel

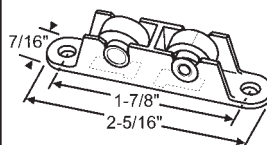

52-810

15/32" Dia. Nylon Body with Nylon Wheel

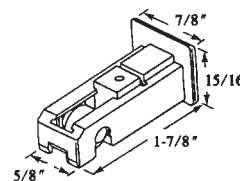

52-695

31/64" Dia. Nylon Wheel

1/2"

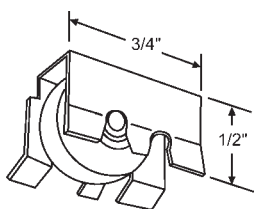

900-14936

1/2" Dia. Metal Wheel

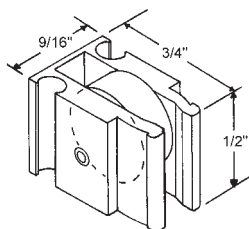

900-12179

1/2" Dia. Flat Steel Wheel

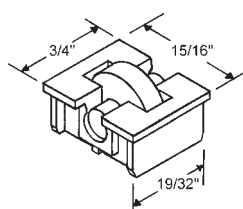

52-718

1/2" Dia. Flat Wheel w/Fixed Axle

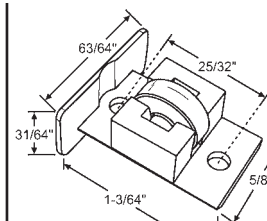

52-882

Nylon Housing w/ 1/2" Dia.
Brass Wheel

MILESTONE/ FLORIDA EXTRUDERS

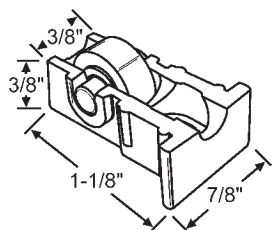

52-517

1/2" Steel Wheel. Black

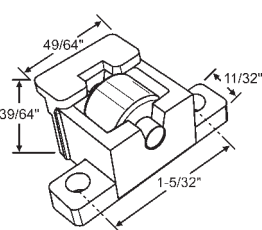

52-781MA

1/2" Brass Roller

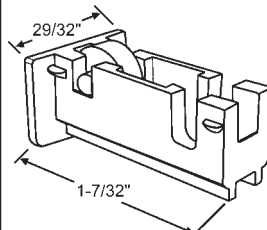

900-10420

1/2" Dia. Brass Wheel

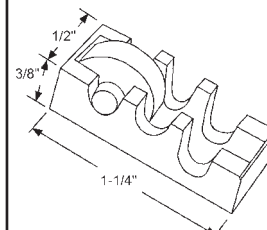

900-8995

1/2" Dia. Flat Metal Wheel w/Separate
Axle

WINDOW REPLACEMENT HARDWARE

SLIDING WINDOW ROLLERS WITH PLASTIC HOUSING

Sliding window rollers in order by roller diameter, length and width.

1/2"

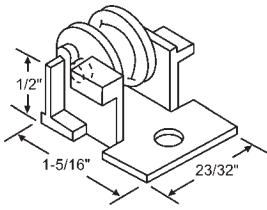

900-10454

1/2" Dia. Metal Wheel
w/Separate Axle
KRESTMARK

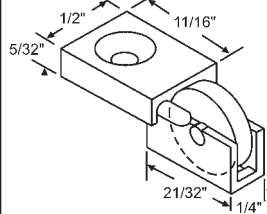

900-8212

1/2" Dia. Flat Nylon Wheel
w/Fixed Axle
KELLER/ACORN

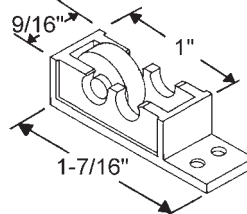

52-712

1/2" Dia. Flat Metal Wheel
w/Fixed Axle

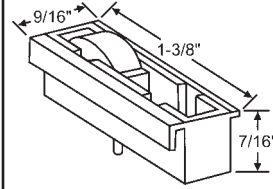

52-938

1/2" Dia. Brass Wheel
KELLER/PGT

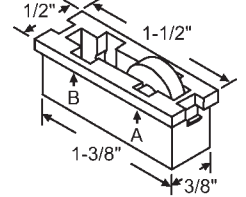

859

Black Housing with 1/2" Dia. Flat
Brass Wheel. Roller Projects
3/32" in Position "A" and 5/32" in
Position "B".

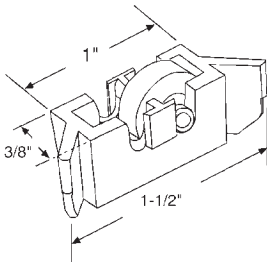

900-12857

1/2" Dia. Brass Wheel
w/Separate Axle

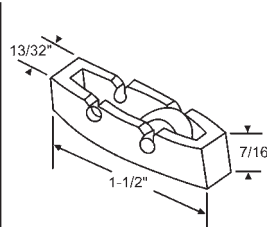

52-632A

1/2" Dia. Aluminum Wheel
and Axle
CAPITOL

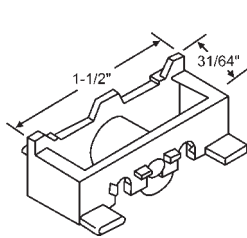

52-684

1/2" Dia. Nylon Wheel

CHAMBERLAIN

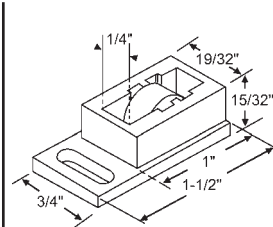

Part #	Description
900-1293	Flat Metal Wheel
900-1293A	Flat Brass Wheel

1/2" Dia. Wheel

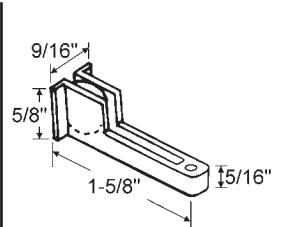

52-790

1/2" Dia. Flat Nylon Wheel

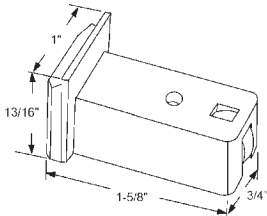

900-10423

1/2" Flat Metal Wheel with Fixed
Axle. Black
MILLER

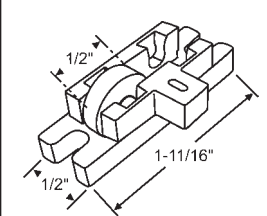

900-20288

1/2" Dia. Brass Roller. Black
Roller Only: 900-20288R
ROLLYSON 500 SERIES

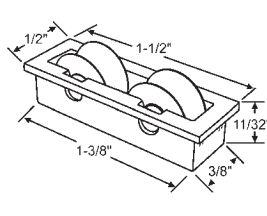

Part #	Description
52-546	Brass Wheel
52-546N	Nylon Wheel
52-546SS	Stainless Steel Wheel

Two 1/2" Dia. Wheels

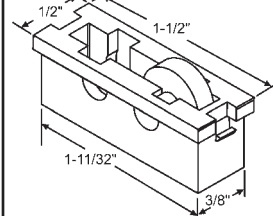

52-826

1/2" Dia. Fixed Axle Metal Rollers
Rollers Project 3/32" from Edge
of Housing. White Housing
with 1 Roller
SILVER LINE

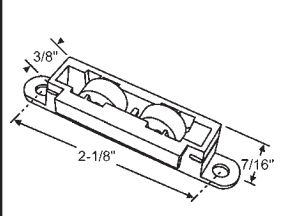

52-937

Two 1/2" Dia. Brass Wheels
Nylon Body

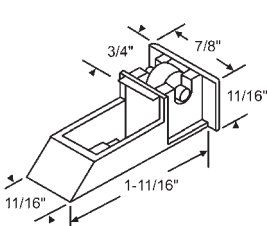

900-16704

1/2" Dia. Flat Metal Wheel
Black

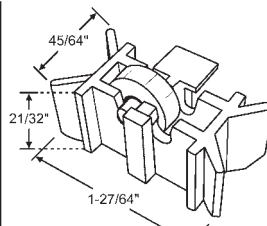

900-20955

White Nylon Housing
with 1/2" Dia. Steel Wheel
ALENCO

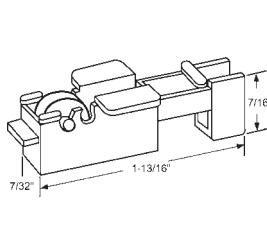

52-807

1/2" Dia. Wheel
ACORN

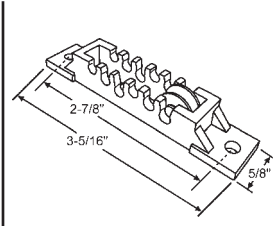

52-534

1/2" Dia. Nylon Wheel

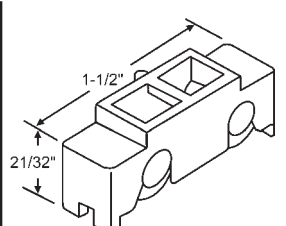

52-689

Two 33/64" Dia. Nylon Wheels
GALLATIN

33/64"

WINDOW REPLACEMENT HARDWARE

SLIDING WINDOW ROLLERS WITH PLASTIC HOUSING

Sliding window rollers in order by roller diameter, length and width.

17/32"

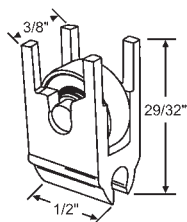

52-732
17/32" Dia. Steel Wheel
Nylon Body

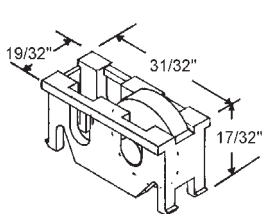

900-8996
17/32" Dia. Metal Wheel
SULLIVAN

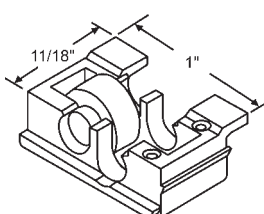

52-713
17/32" Dia. Flat Wheel
CAPITOL

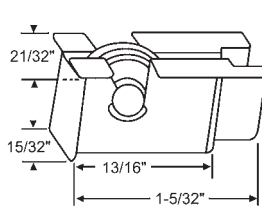

52-707
17/32" Dia. Metal Wheel
REYNOLDS

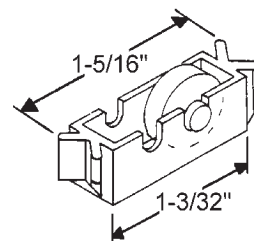

900-10293
17/32" Dia. Flat Metal Wheel
w/Separate Axle

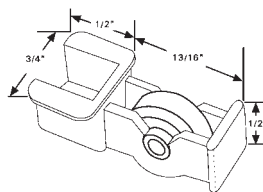

900-9765
17/32" Dia. Flat Ball Bearing
Wheel w/Fixed Axle

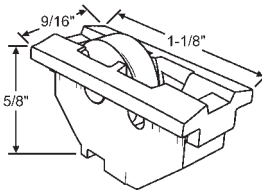

52-301
17/32" Dia. Brass Wheel
Nylon Housing
SEASONSHIELD

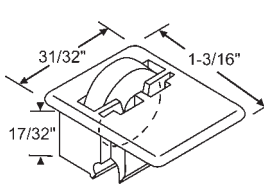

900-10192
17/32" Dia. Flat Metal Wheel
w/Separate Axle

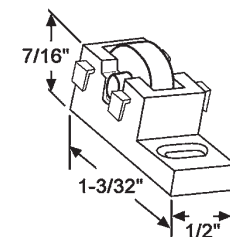

900-20289
17/32" Dia. Flat Metal Wheel w/
Separate Axle
ROLLYSON

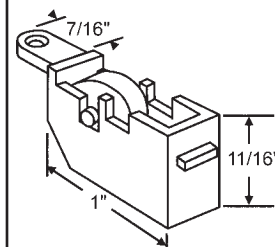

52-536
17/32" Brass Wheel
KENSINGTON

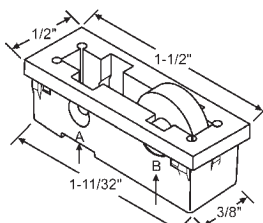

52-411
17/32" Dia. Metal Wheel with
Separate Axle. Roller Projects
1/32" in Position "A" and 1/8" in
Position "B".
ACORN

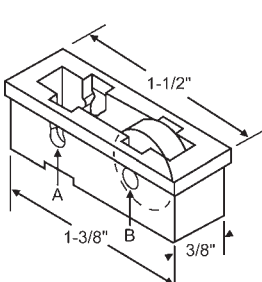

900-12609
17/32" Dia. Wheel
Roller Projects 1/16" in Position
"A" and 3/32" in Position "B".

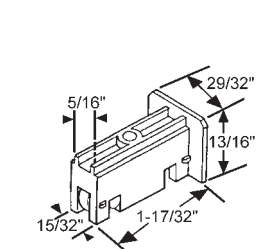

900-20286
17/32" Dia. Flat Ball Bearing
Wheel w/Fixed Axle

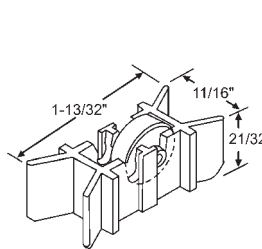

900-12993
17/32" Dia. Wheel

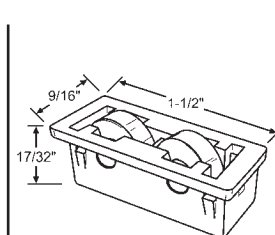

52-934
Two 17/32" Dia. Brass Wheels

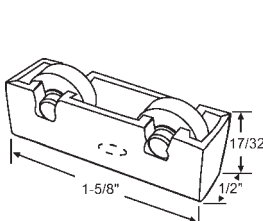

900-11791
Two 17/32" Dia. Metal Wheel
KELLER

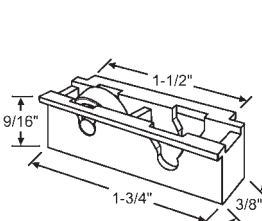

900-11564
17/32" Dia. Steel Ball
Bearing Wheel'
TRACO

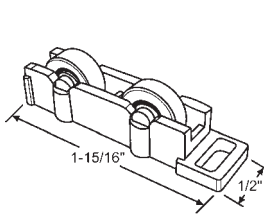

Part #	Description
52-731	Brass Wheel
52-731SS	Stainless Steel Wheel

Two 17/32" Dia. Wheels

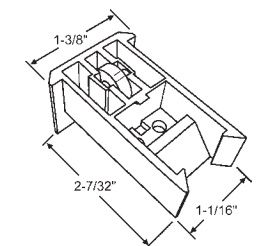

Part #	Description
900-22185	Black Housing
900-22185W	White Housing

17/32" Dia. Brass Wheel
and Axle.

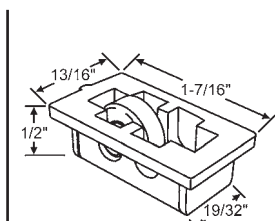

52-676
17/32" Dia. Metal Wheel
ACORN

WINDOW REPLACEMENT HARDWARE

SLIDING WINDOW ROLLERS WITH PLASTIC HOUSING

Sliding window rollers in order by roller diameter, length and width.

35/64"

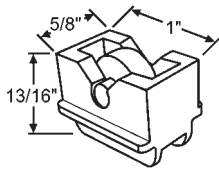

52-1137
White Nylon
35/64" Wheel Size

9/16"

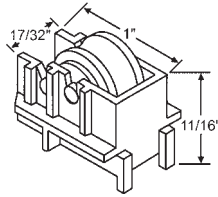

900-11993R
9/16" Dia. Brass Wheel

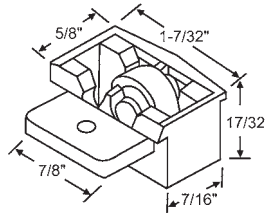

900-10416
9/16" Dia. Steel Ball
Bearing Wheel

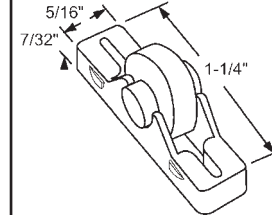

52-728
9/16" Dia. Brass Wheel with
Stainless Steel Axle

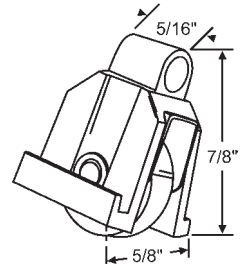

52-931
9/16" Stainless Steel Flat Wheel

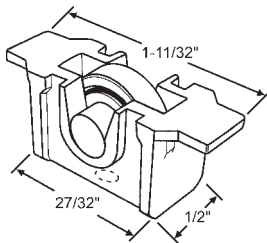

52-553
9/16" Dia. Steel Ball
Bearing Wheel.

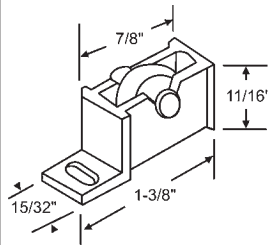

52-680
9/16" Dia. Nylon Wheel
REYNOLDS

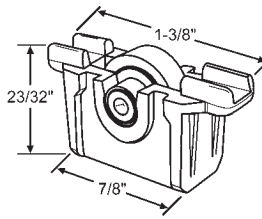

900-19996
9/16" Dia. Steel Ball
Bearing Wheel.

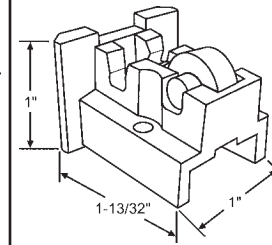

52-535
9/16" Dia. Brass Wheel. Black

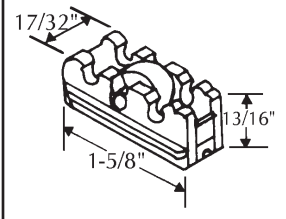

52-625OLD
9/16" Metal Ball Bearing Wheel

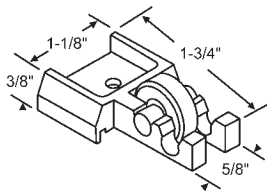

900-8512A
9/16" Dia. Flat Metal Wheel
w/Separate Axle
CAPITOL

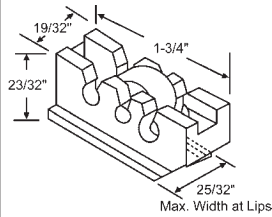

52-622
9/16" Dia. Metal Wheel
CAPITOL

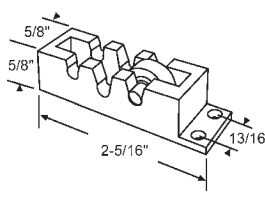

52-808
9/16" Dia. Flat Metal Wheel
w/Separate Axle
CAPITOL

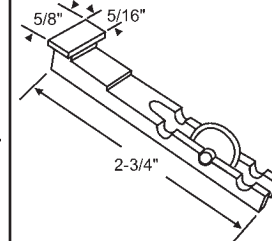

900-8423
9/16" Dia. Nylon Convex Wheel
w/Fixed Axle

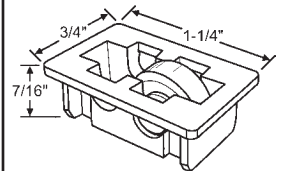

Part #	Wheel Size
900-12811	9/16"
900-12811HD	5/8"

Metal Ball Bearing Wheel

19/32"

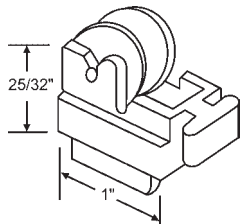

52-642
19/32" Dia. Metal Wheel

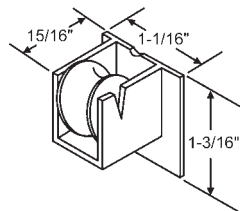

Part #	Hand
52-699LH	Shown
52-699RH	Opposite

5/8" Dia. Metal Wheel
w/Separate Axle

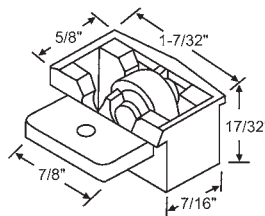

900-10416NS
5/8" Dia. Steel
Ball Bearing Wheel

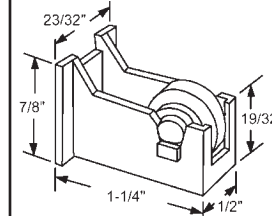

52-685
5/8" Flat Metal Wheel with
Separate Axle
CROWN/PINO

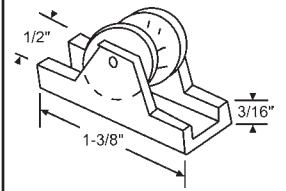

52-671
5/8" Dia. Metal Wheel
ROLLYSON

WINDOW REPLACEMENT HARDWARE

SLIDING WINDOW ROLLERS WITH PLASTIC HOUSING

Sliding window rollers in order by roller diameter, length and width.

5/8"

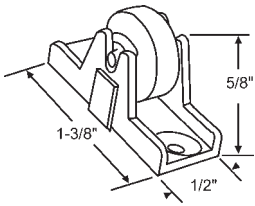

900-68

5/8" Dia. Flat Steel Wheel
w/Separate Axle

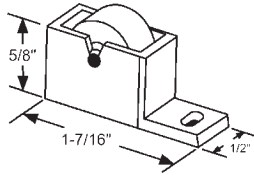

900-1295

5/8" Dia. Flat Brass Wheel
w/Separate Stainless Steel Axle

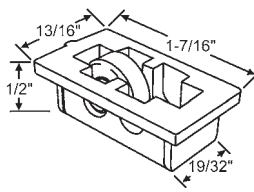

52-676HD

5/8" Dia. Ball Bearing
Metal Wheel
ACORN

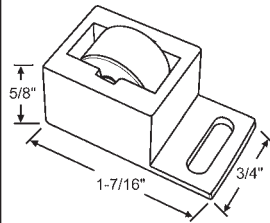

900-1296

5/8" Dia. Brass Wheel. Stainless
Steel Axle

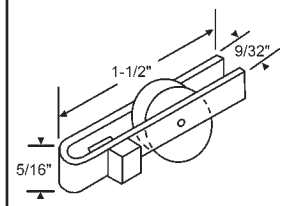

52-626

5/8" Dia. Nylon Wheel

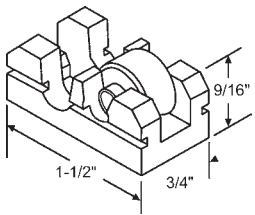

900-20066A

5/8" Dia. Metal Wheel

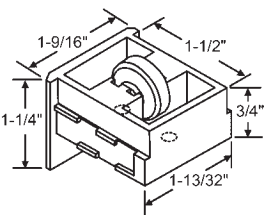

52-714

Cam and Roller Assembly
5/8" Dia. Ball Bearing Wheel

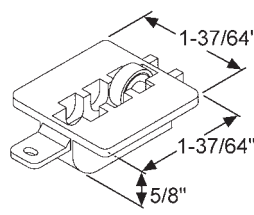

52-805

5/8" Dia. Flat Metal Ball Bearing
Wheel w/Fixed Axles
ACORN

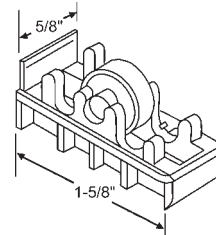

Part #	Color
900-8245A	Black
900-8245WA	White

5/8" Dia. Ball Bearing
Metal Wheel
ACORN

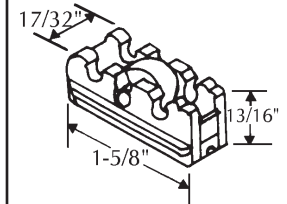

52-625OLD-BB

5/8" Dia. Steel Ball Bearing
Wheel

11/16"

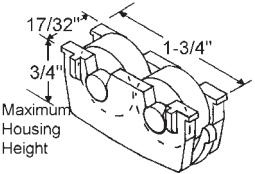

900-1797A

Two 5/8" Dia. Metal Wheels
White
SEASONALL

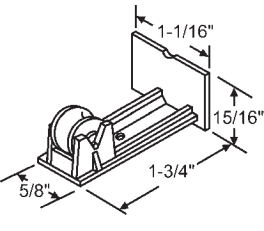

Part #	Hand
52-702	Shown
52-701	Opposite

5/8" Dia. Metal Wheel with
Separate Axle
ALSCO/SUGARCREEK

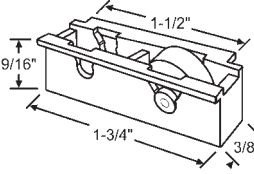

52-982A

5/8" Dia. Steel Ball Bearing
Wheel
TRACO

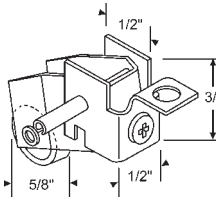

900-13358

5/8" Dia. Flat Ball Bearing
Steel Wheel

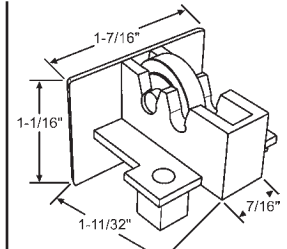

Part #	Color
900-16113	Black
900-16113W	White

11/16" Dia. Flat Ball Bearing
Wheel and Fixed Axle

23/32"

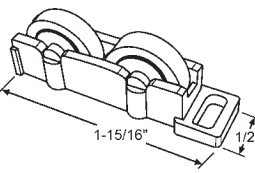

52-946

11/16" Dual Brass Wheels

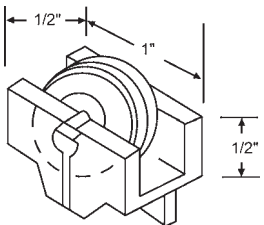

52-609

23/32" Dia. Flat Nylon Wheel
CROSSLY

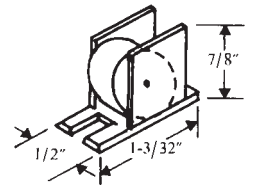

52-623

23/32" Dia. Nylon Wheel

3/4"

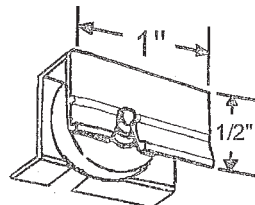

52-694

3/4" Dia. Flat Nylon Ball Bearing Wheel
PREMIERE

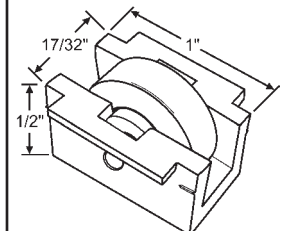

52-321N

3/4" Dia. Flat Nylon Ball Bearing
Wheel. Black

WINDOW REPLACEMENT HARDWARE

SLIDING WINDOW ROLLERS WITH PLASTIC HOUSING

Sliding window rollers in order by roller diameter, length and width.

3/4"

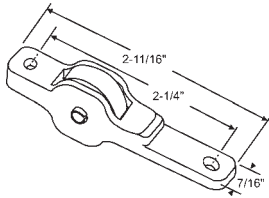

900-20814

3/4" Dia. Flat Nylon Wheel

25/32"

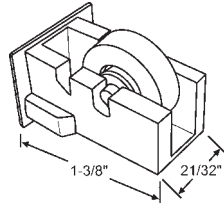

Part #	Description
52-950	Nylon Wheel
52-950BRS	Brass Wheel

3/4" Dia. Wheel
SECURITY

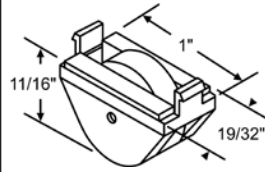

900-17156

25/32" Dia. Wheel

27/32"

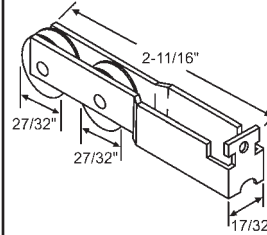

52-738SS

27/32" Stainless Steel Wheel

EFCO

7/8"

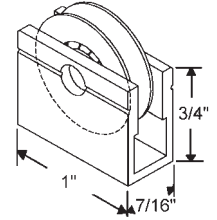

Part #	Description
900-10693	Nylon Wheel

7/8" Dia. Wheel

CORNER BLOCK

WEEP COVERS

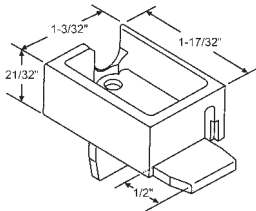

Part #	Hand
900-1878LHW	Shown
900-1878RHW	Opposite

Corner Block, White
REYNOLDS

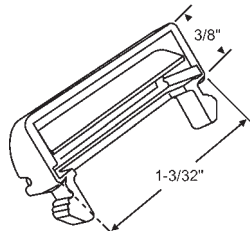

Part #	Color
900-20137	White
900-20137BE	Beige

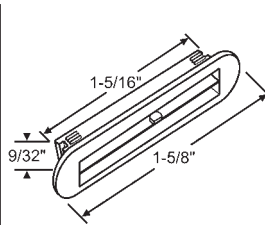

85-1133ABG

Bronze

PGT

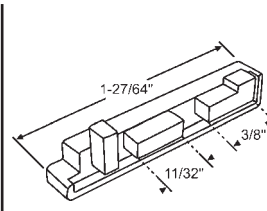

900-2478

White

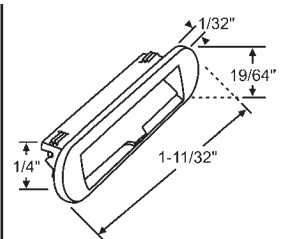

Part #	Color
85-968W	White
85-968BG	Beige

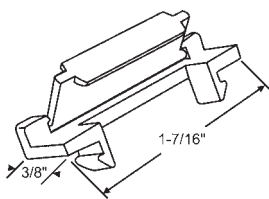

Part #	Color
900-17790W	White
900-17790	Beige
900-17790BL	Black

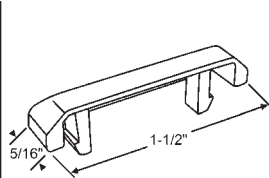

85-879W

White

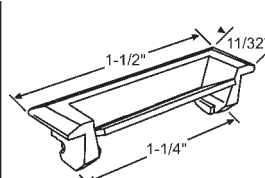

Part #	Color
85-742BG	Beige
85-742W	White

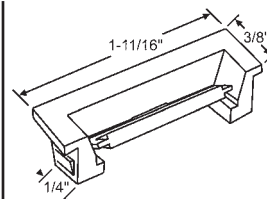

Part #	Color
85-730	Beige
85-730BW	Blue White
85-730WW	Warm White

ACORN

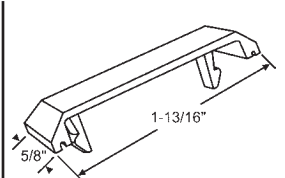

Part #	Color
900-19761	Beige
900-19761W	White
900-19761B	Black

VINYL BUILDING PRODUCTS

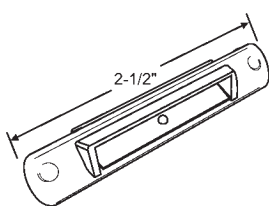

52-989

White
PGT

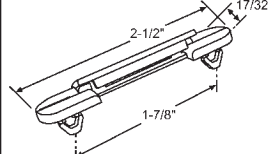

Part #	Color
60-711	White
60-711B	Black
60-711BE	Beige

BETTER-BILT

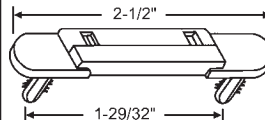

Part #	Color
900-19413W	Bright White
900-19413BG	Beige
900-19413B	Black
900-19413BR	Brown

ROLLYSON/NORANDEX

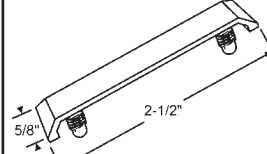

Part #	Color
900-21193	Beige
900-21193B	Black
900-21193W	White

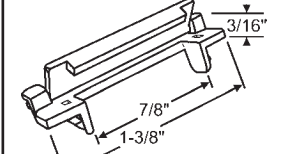

Part #	Color
900-19417	Tan
900-19417BZ	Bronze

PGT

WINDOW REPLACEMENT HARDWARE

SLIDING WINDOW WHEELS

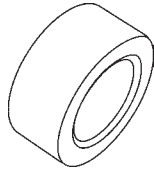
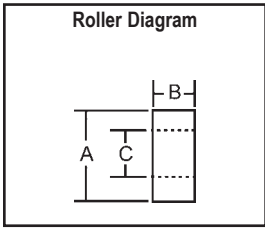

52-693		
A	B	C
7/16"	3/16"	1/4"

Flat Metal



52-619		
A	B	C
9/16"	7/32"	5/16"

Brass



52-683R				
A	B	C	D	E
1/2"	5/32"	1/8"	1/32"	15/64"

Nylon

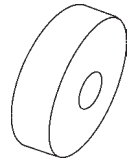

52-634		
A	B	C
17/32"	9/64"	1/8"

Nylon

SLIDING WINDOW WHEELS WITH FIXED AXLE



900-10189		
A	B	C
9/16"	13/16"	3/16"

Steel Ball Bearing Wheel

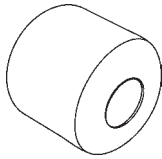

900-5704		
A	B	C
7/16"	7/16"	3/16"

White Nylon with Molded Axle

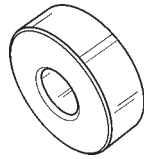

900-20288R		
A	B	C
17/32"	3/16"	3/16"

Brass

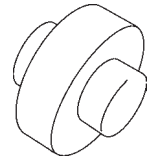
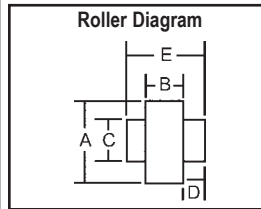

900-8618				
A	B	C	D	E
9/32"	3/32"	5/32"	1/16"	7/32"

Nylon Vent

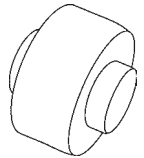

900-10418				
A	B	C	D	E
3/8"	3/16"	3/16"	1/16"	5/16"

Nylon

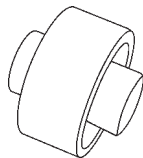

900-9814W			
A	B	C	E
25/64"	3/16"	3/16"	3/8"

Nylon with Offset Axle

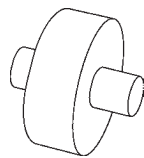

900-2041				
A	B	C	D	E
7/16"	5/32"	1/8"	1/8"	13/32"

Nylon

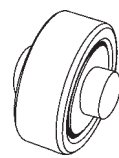

900-9764				
A	B	C	D	E
17/32"	3/16"	3/16"	3/32"	3/8"

Steel with Ball Bearings

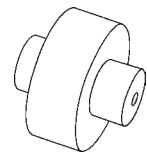

52-679				
A	B	C	D	E
9/16"	1/4"	1/4"	1/8"	1/2"

Nylon

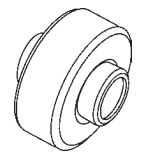

11-147				
A	B	C	D	E
9/16"	7/32"	1/4"	9/64"	7/16"

Steel with Ball Bearings

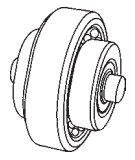

900-15444A				
A	B	E	H	I
5/8"	3/16"	3/8"	1/2"	1/8"

Steel with Ball Bearings

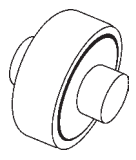

900-9564				
A	B	C	D	E
5/8"	1/4"	1/4"	1/8"	1/2"

Steel with Ball Bearings
ACORN

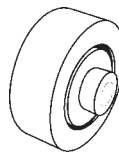

52-982				
A	B	C	D	E
5/8"	7/32"	3/16"	3/32"	3/8"

Steel with Ball Bearings
PAN AM

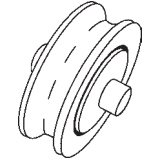

52-703R				
A	B	C	D	E
3/4"	1/4"	5/32"	3/32"	1/2"

Concave Nylon with Steel Hub and Ball Bearings

SLIDING WINDOW WHEELS WITH AXLE

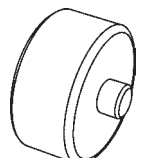

52-937W				
A	B	C	D	E
1/2"	1/4"	1/8"	1/16"	3/8"

Brass
PGT

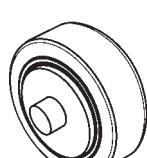

11-229				
A	C	D	H	I
23/32"	5/16"	1/4"	1/2"	5/32"

Nylon Ball Bearing with Axle

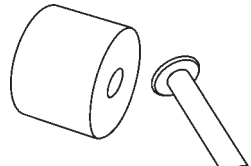
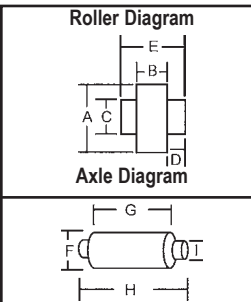

52-653				
A	B	C	H	I
3/8"	9/32"	3/32"	19/32"	3/32"

Nylon with Aluminum Axle

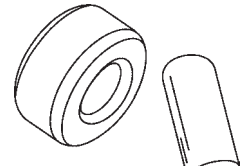

52-628				
A	B	C	F	H
29/64"	7/32"	3/16"	3/16"	1/2"

Steel

WINDOW REPLACEMENT HARDWARE

SLIDING WINDOW WHEELS WITH AXLE

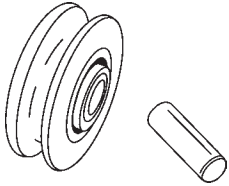

52-651

A	B	C	E	F	H
5/8"	13/64"	1/8"	1/4"	1/8"	3/8"

Ball Bearing Roller with Axle

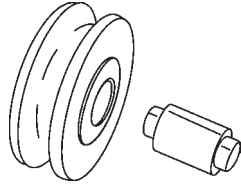

52-652

A	B	C	E	F	G	H	I
5/8"	13/64"	3/16"	7/32"	3/16"	1/4"	3/8"	1/8"

Nylon Roller with Metal Axle

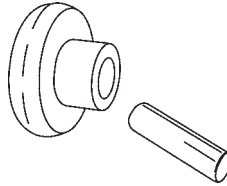

52-610

A	B	C	D	H	I
1/2"	1/8"	1/8"	5/32"	13/32"	1/64"

Nylon with Steel Axle

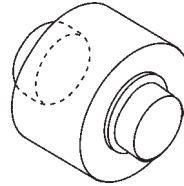

52-688

F	G	I	D	H
1/2"	9/32"	1/4"	1/16"	27/64"

Nylon

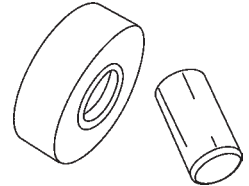

900-11791W

A	B	C	D	E
17/32"	13/64"	3/16"	3/32"	3/8"

Steel

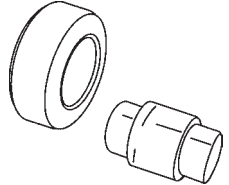

52-621

A	B	C	F	G	H	I
9/16"	1/4"	1/4"	5/16"	1/4"	1/2"	1/4"

Aluminum with Steel Axle

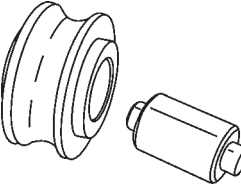

52-700

A	B	C	E	F	G	H	I
19/32"	3/8"	1/4"	23/64"	1/4"	3/8"	1/2"	1/8"

Concave Metal. Axle Included

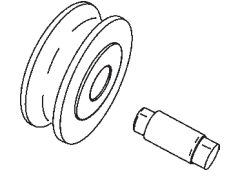

52-703RNEW

A	B	C	E	F	G	H	I
3/4"	1/4"	3/16"	3/16"	3/16"	5/16"	1/2"	5/32"

Nylon with Brass Axle

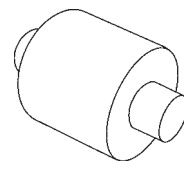

900-11416R

F	G	I	D	H
5/16"	19/64"	1/8"	3/32"	15/32"

Steel

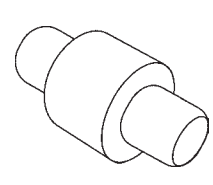

900-8952

F	G	I	D	H
5/16"	1/4"	13/64"	3/16"	21/32"

Steel

STORM CAM LATCH

SLIDER GUIDES

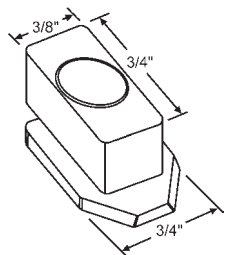

52-868

ACORN 2330 SERIES

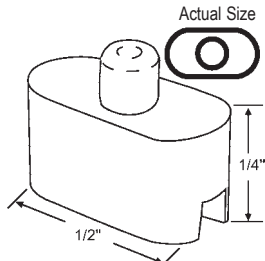

52-668

ADOR HILTE

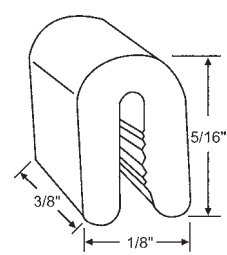

52-725

ACORN

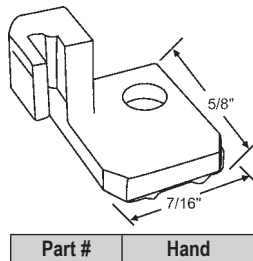

Part #	Hand
900-9556RH	Shown
900-9556LH	Opposite

ACORN

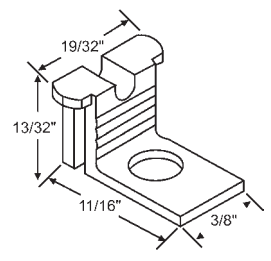

900-5215

KING

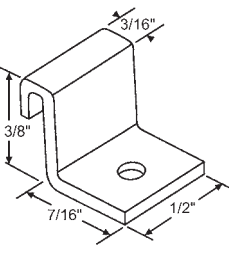

900-8380

KELLER/AIRCONTROL

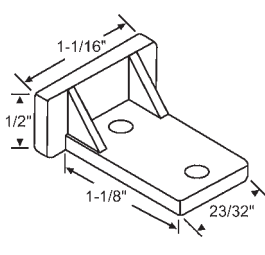

900-5159

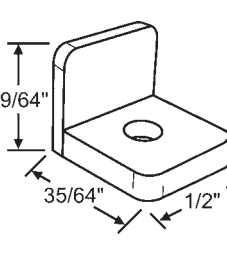

900-17365

White

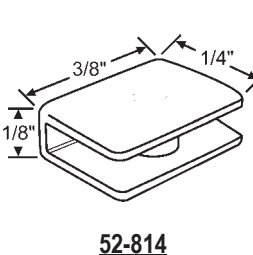

52-814

Nylon Guide
PAN AM

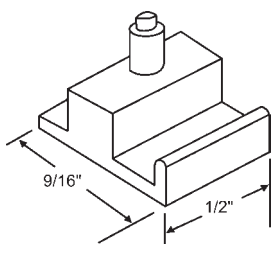

52-669

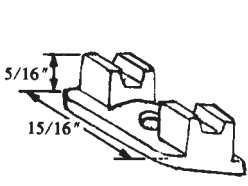

900-5766

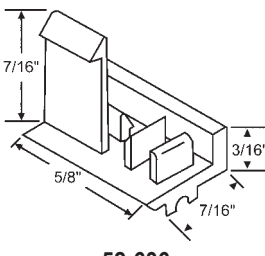

52-636

RH Storm Slider

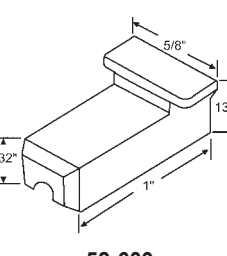

52-639

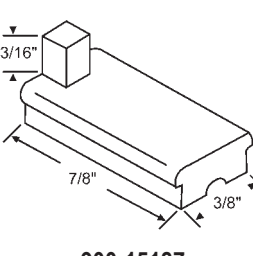

900-15187

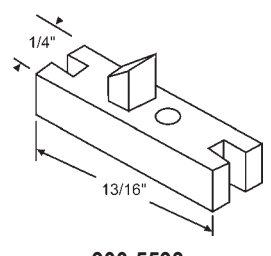

900-5593

COLE SEWELL

WINDOW REPLACEMENT HARDWARE

SLIDER GUIDES

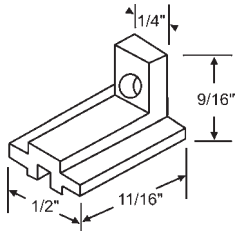

52-674

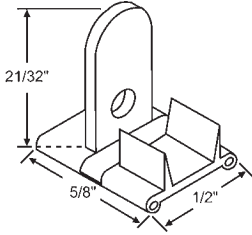

900-11181
Black

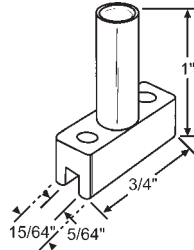

900-6116
White

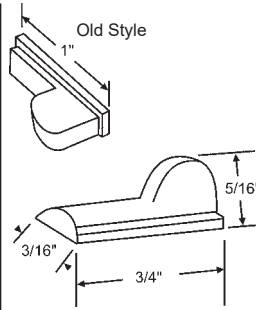

900-6902
CROSSLY/LUMIDOR

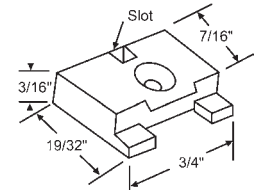

Part #	Color	Slot
52-673	Natural	Yes
52-673B	Black	Yes
52-673OLD	Natural	No
52-673B-OLD	Black	No

Nylon. Screws Sold Separately #20-416
CROWN

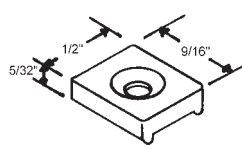

900-1624
Nylon
KELLER

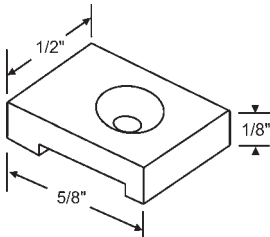

52-677
Nylon
REYNOLDS

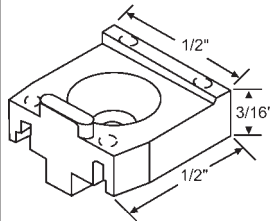

900-20307B
Black

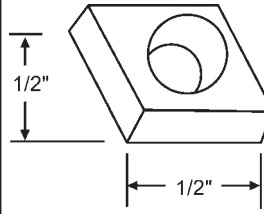

52-635
Insert Retainer

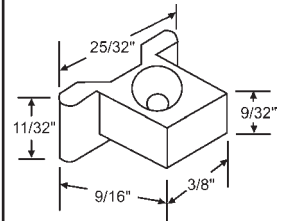

52-602
KELLER

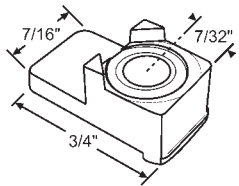

900-6901
Nylon Face Guide. Black
ATRIUM/PHILIPS

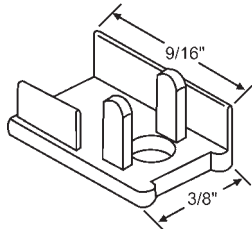

900-20104
Interlock Cap
BETTER-BILT

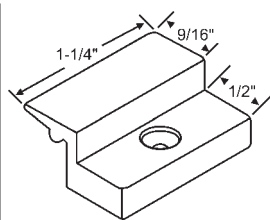

Part #	Color
900-15598	Black
900-15598W	White

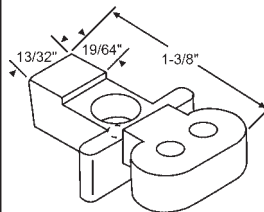

900-14207

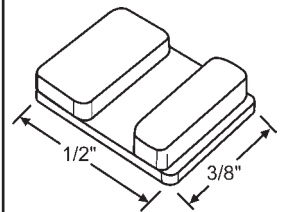

900-5884
White

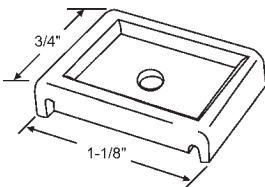

900-11537
Rail Slide

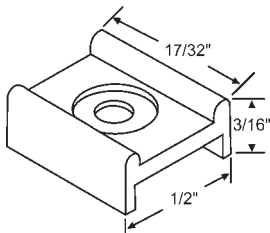

900-5613

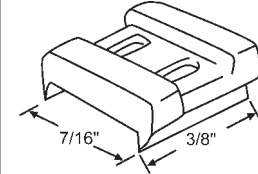

900-21136
CAPITOL

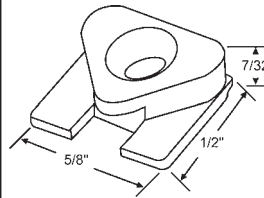

52-818
Slider Guide

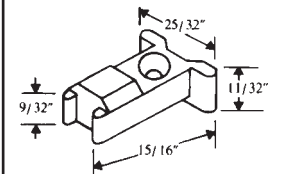

52-601
KELLER

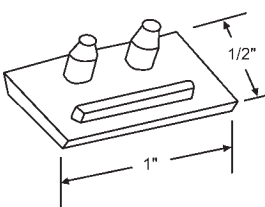

52-664
CROSSLY

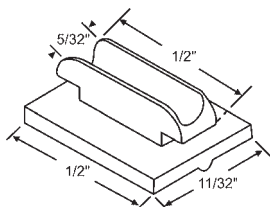

52-665
Insert for 52-667

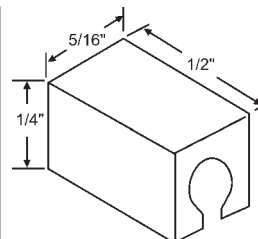

52-828
Nylon Spacer, Black
ACORN

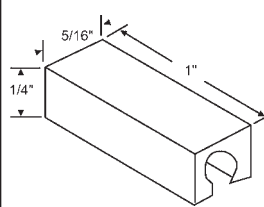

52-829
Nylon Spacer, Black
ACORN

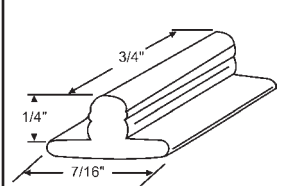

52-706

WINDOW REPLACEMENT HARDWARE

SLIDER GUIDES

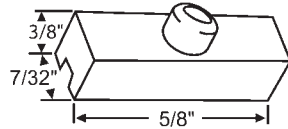
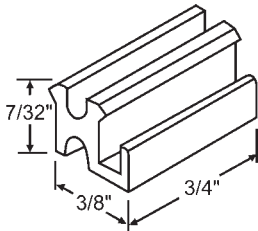

52-720
Repair Kit (2 of each)
ALENCO

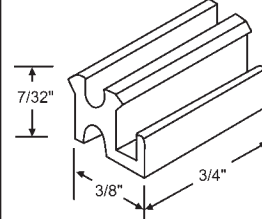
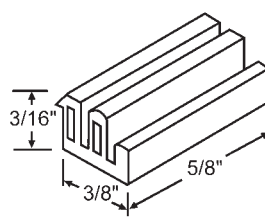

52-608
ALENCO

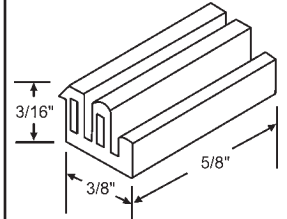

52-670
Nylon
ALENCO

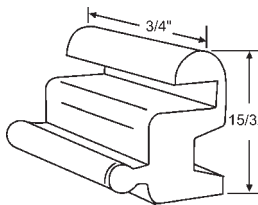

52-845

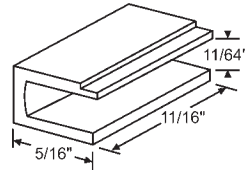

900-6894
Sash Guide

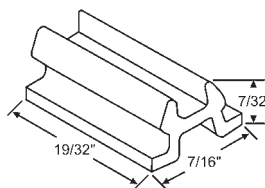

900-1105
Gray

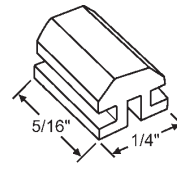

52-846
White
PAN AM/BINNINGS

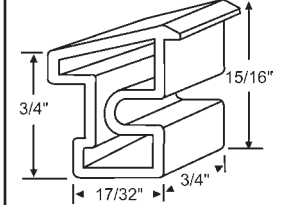

52-7000
Sash Lift Stop. Black
ACORN

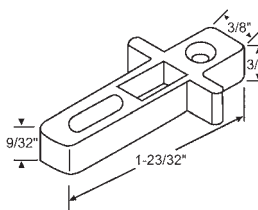

52-600

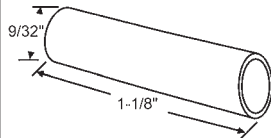

52-633
Slider Pressure Tubes

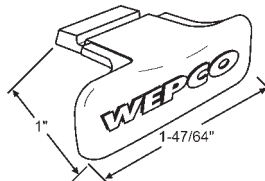

900-5976
White

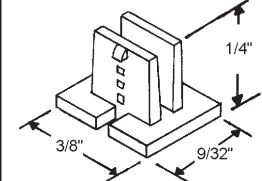

900-5422
Nylon

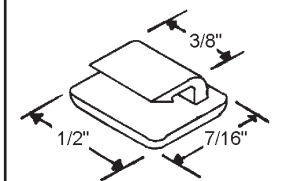

900-5598
Nylon

PIVOT SHOE

SLIDE BOLT

ANTI-RATTLE PLUG

GUIDE BUTTON

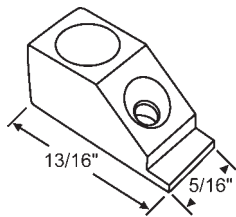

900-5749
Nylon
MALTA

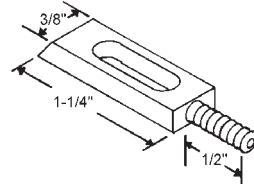

900-1888
White Plastic

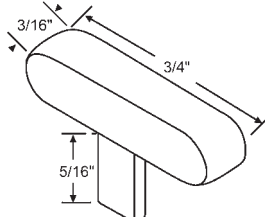

900-2405
Anti-Rattle Plug

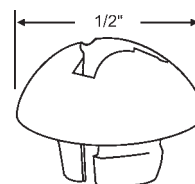

900-9195
CAPITOL

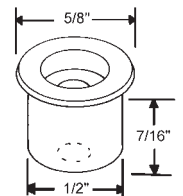

Part #	Color
900-20046BG	Beige
900-20046	White

Reinforcing Button

ANGLES / CORNERS

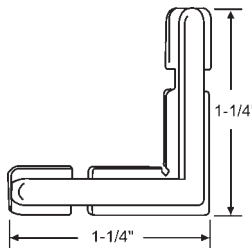

52-605
Slider Guide Angle
Plastic

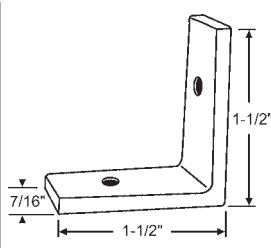

52-604
Slider Guide Angle
Aluminum

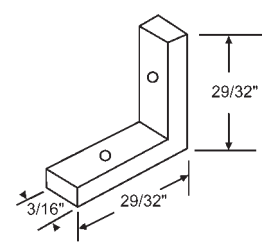

52-603
Slider Corner Angle
Die Cast

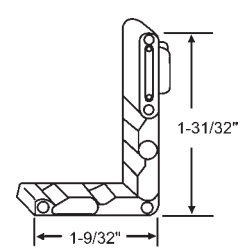

52-667
Slider Corner Key
Die Cast with Plastic Insert
REYNOLDS/PORTALUME

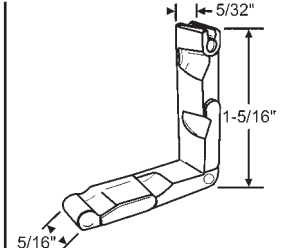

52-672
Slider Corner Key
Die Cast

WINDOW REPLACEMENT HARDWARE

MISCELLANEOUS

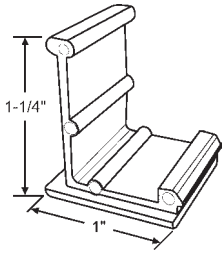

52-990
End Cap. White
PGT

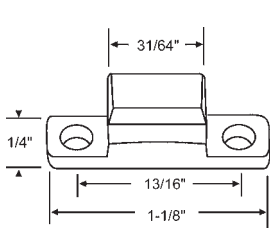

900-2003
Nylon Bottom Rail Slide
Black

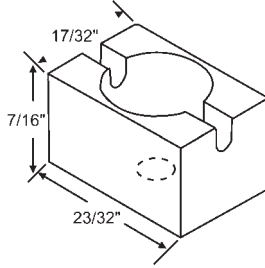

900-5571
Glide Block
**ALENCO/KRESTMARK/
KELLER**

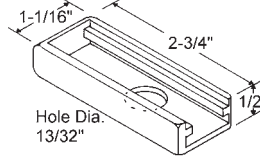

Part #	Color
900-20099BE	Beige
900-20099B	Black
900-20099W	White

Slide Bolt Cover

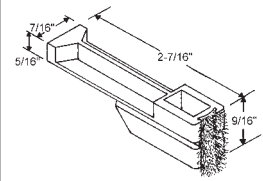

900-20105
Anti-Draft Block

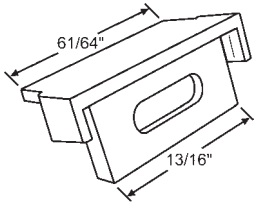

52-992
End Cap. White
PGT

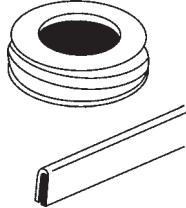

52-705
Sliding Window Repair Track.
Vinyl. Install over worn or
damaged tracks. Sold in 100 ft.
rolls only, Gray

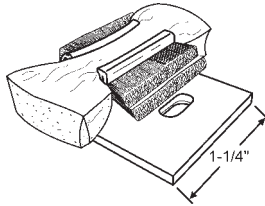

900-11534
Interlock Seal Assembly. Red
CAPITOL

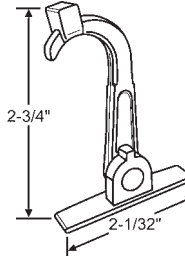

52-986
Sliding Window Pull. Black Plastic
CROSSLY

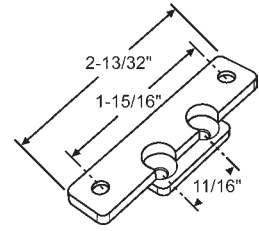

900-22206
Transom Bracket. White Plastic
ACORN/REHAU

FASTENERS

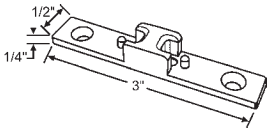

52-1126
Fixed Mounting Rail Bracket
PGT

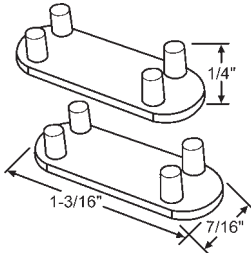

52-1127
Frame Plug
PGT

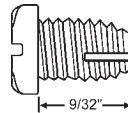

20-518
Pan Head Self Tapping Screw
Type #1. 10-24 x 9/32"

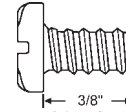

20-515
Pan Head Screw. 10-24 x 3/8"
Bronze

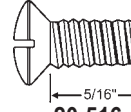

20-516
Oval Head Screw. 10-24 x 5/16"
Bronze

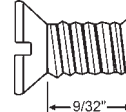

20-517
Flat Head Screw. 10-24 x 9/32"

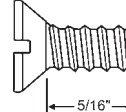

20-519
Flat Head Screw. 12-24 x 5/16"

PROJECT-OUT ONE HOLE CAM HANDLES

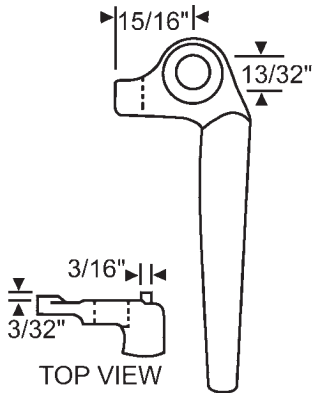

Part #	Hand	Finish
32-208	Shown	Dark Bronze
32-207	Opposite	Dark Bronze

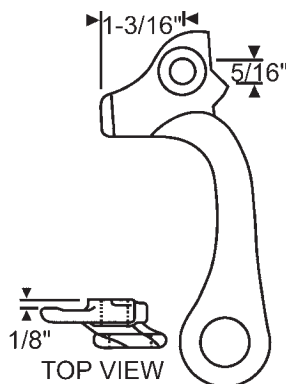

Part #	Finish
32-238	Copper

Water Rolled Finish

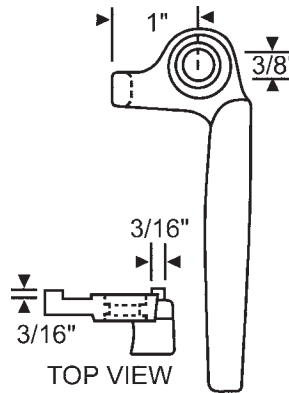

Part #	Hand	Finish
32-254	Shown	Dark Brown
32-255	Opposite	Dark Brown

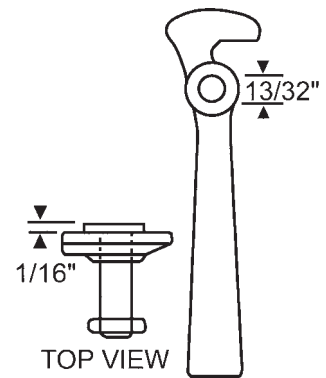

Part #	Finish
32-222	Aluminum

WINDOW REPLACEMENT HARDWARE

PROJECT-OUT ONE HOLE CAM HANDLES

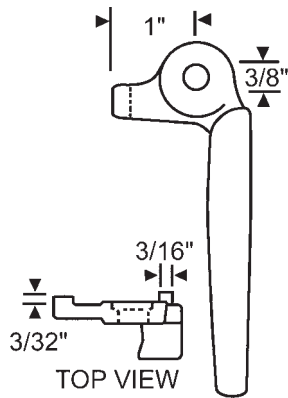

Part #	Finish
32-223	Light Bronze

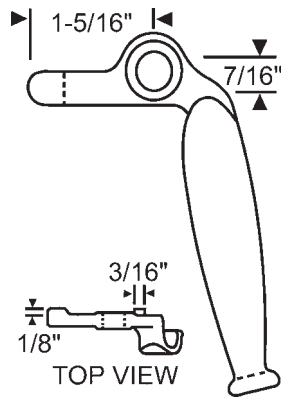

Part #	Hand	Finish
32-230	Shown	Dark Bronze
32-231	Opposite	Dark Bronze

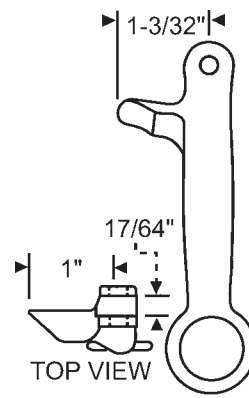

Part #	Finish
32-232	Dark Bronze

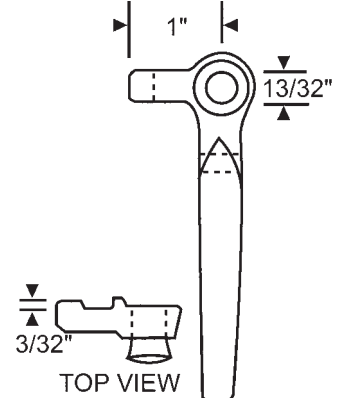

Part #	Hand	Finish
32-236	Shown	Dark Bronze
32-237	Opposite	Dark Bronze

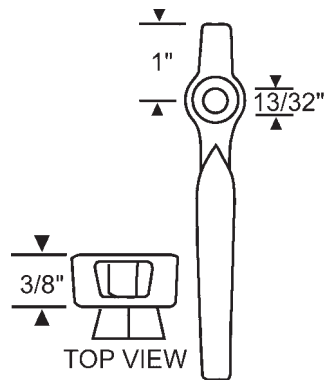

Part #	Finish
32-239	Dark Bronze

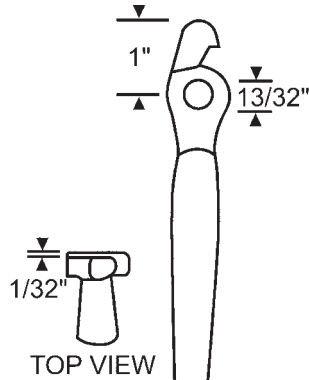

Part #	Finish
32-240	Dark Bronze

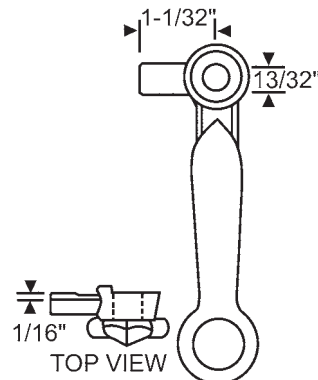

Part #	Hand	Finish
32-272	Shown	Aluminum
32-214	Opposite	Aluminum

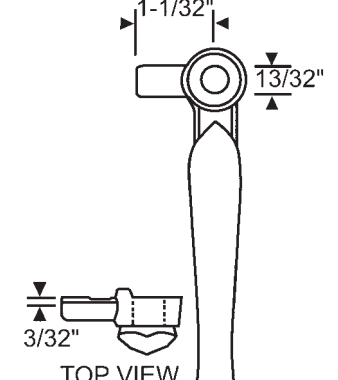

Part #	Hand	Finish
32-247	Shown	Dark Bronze
32-248	Opposite	Dark Bronze

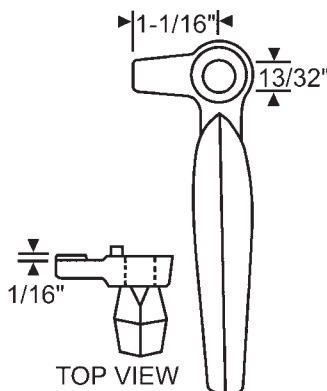

Part #	Hand	Finish
32-249	Shown	Copper
32-250	Opposite	Copper

Water Rolled Finish

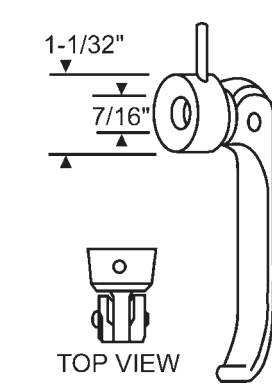

Part #	Finish
32-288A	Aluminum

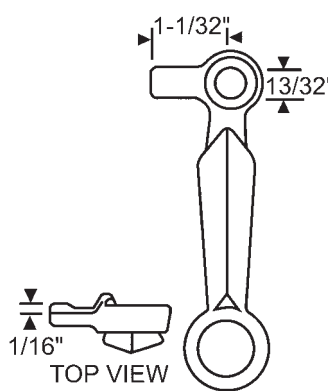

Part #	Finish
32-215	Dark Bronze

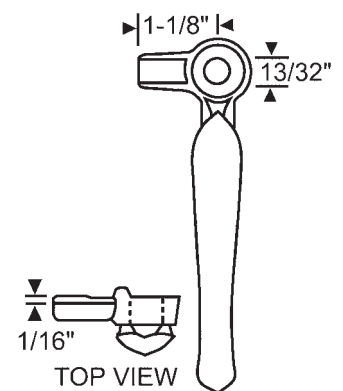

Part #	Hand	Finish
32-219	Shown	Bronze
32-217	Opposite	Bronze

WINDOW REPLACEMENT HARDWARE

PROJECT-OUT MOUNTING HARDWARE FOR CAM HANDLES



Part #	Finish
32-204	Dark Bronze
32-204A	Aluminum

Clevis

32-204 and 20-022
 Use on: 32-207, 32-208, 32-215, 32-236, 32-237,
 32-239, 32-240, 32-247, 32-248, 32-273

32-204A and 20-022A

Use on: 32-214, 32-216, 32-217, 32-218, 32-219,
 32-222, 32-272

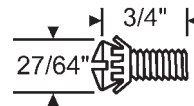

Part #	Finish
20-022	Dark Bronze
20-022A	Aluminum

Clevis Screw with Lock Washer
 Thread Size: 1/4 -20

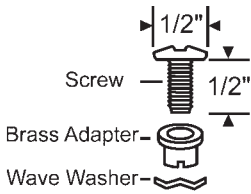

20-027

Dark Bronze Finish. Thread Size: 1/4 -20
 Use on 32-254 and 32-255

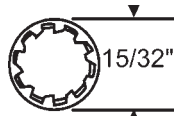

900-9452

Clevis Lock Washer
 Use on 32-230 and 32-231

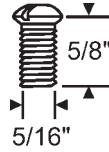

900-7977

Clevis Screw, Dark Bronze
 Use on 32-230 and 32-231

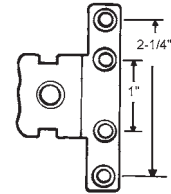

900-7979

Mounting Bracket, Dark Bronze
 Use on 32-230 and 32-231

PROJECT-OUT TWO HOLE CAM HANDLES

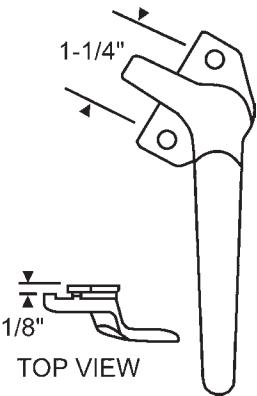

Part #	Hand	Finish
32-242	Shown	Dark Bronze
32-243	Opposite	Dark Bronze

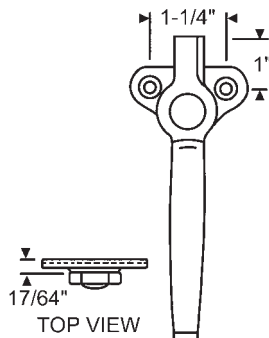

Part #	Finish
32-235	Dark Bronze

Use Screw 20-030

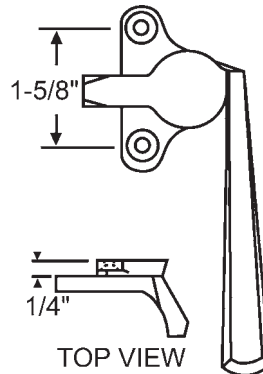

Part #	Hand	Finish
32-560RH	Shown	Aluminum
32-560LH	Opposite	Aluminum

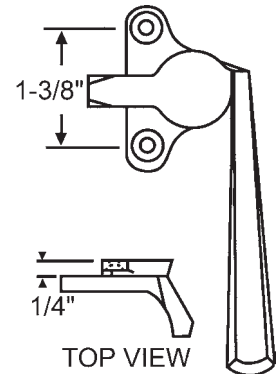

Part #	Hand	Finish
32-295	Shown	Light Bronze
32-294	Opposite	Light Bronze
32-295A	Shown	Aluminum
32-294A	Opposite	Aluminum

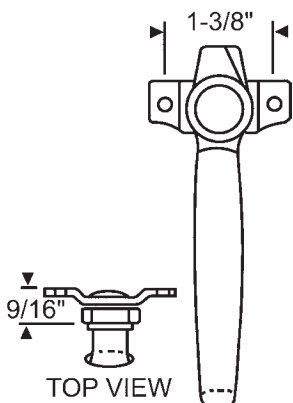

Part #	Finish
32-225	Dark Bronze

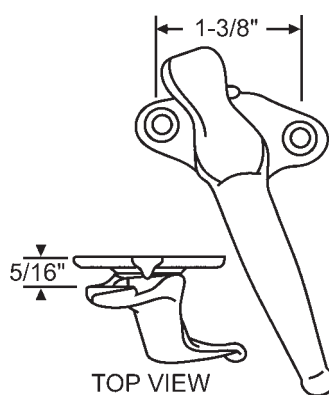

Part #	Finish
32-279	Dark Bronze

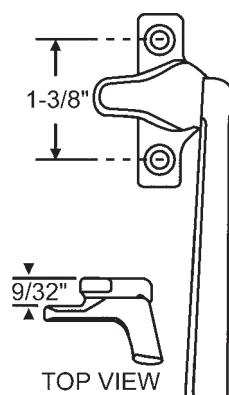

Part #	Hand	Finish
32-301	Shown	White Bronze
32-300	Opposite	White Bronze

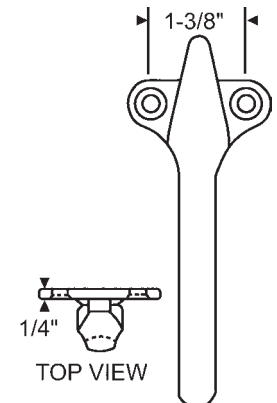

Part #	Finish
32-211	Satin Bronze

WINDOW REPLACEMENT HARDWARE

PROJECT-OUT TWO HOLE CAM HANDLES

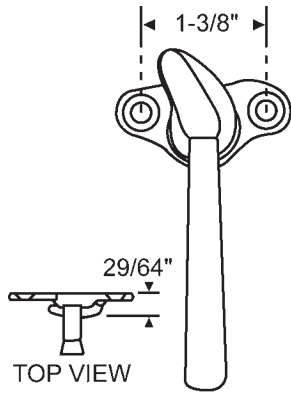

Part #	Finish
32-203	Dark Bronze

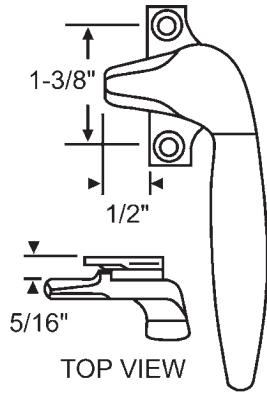

Part #	Hand	Finish
32-221	Shown	White Bronze
32-221DBZ	Shown	Dark Bronze
32-220	Opposite	White Bronze
32-220DBZ	Opposite	Dark Bronze

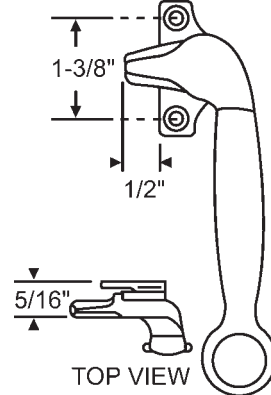

Part #	Hand	Finish
32-308	Shown	White Bronze
32-307	Opposite	White Bronze
32-307MB	Opposite	Medium Bronze

Pole Hole
EFCO

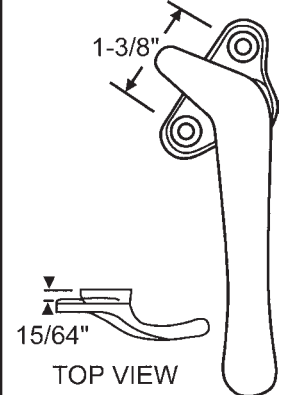

Part #	Hand	Finish
32-263	Shown	Water Rolled Copper
32-241	Opposite	Water Rolled Copper

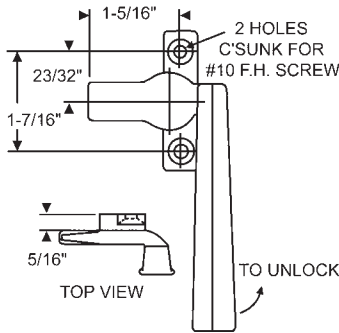

Part #	Hand	Finish
900-8959RH	Shown	White Bronze
900-8959LH	Opposite	White Bronze
900-8959RMB	Shown	Medium Bronze

Use with 900-9132 Keeper

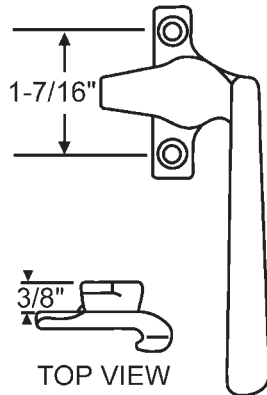

Part #	Hand	Finish
32-257	Shown	White Bronze
32-257LH	Opposite	White Bronze

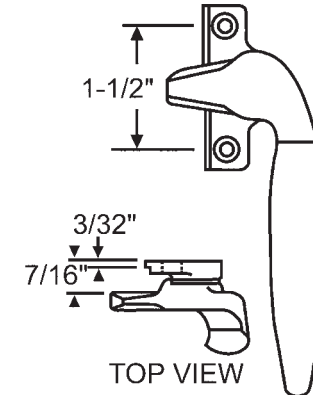

Part #	Hand	Finish
32-252	Shown	White Bronze
32-253	Opposite	White Bronze

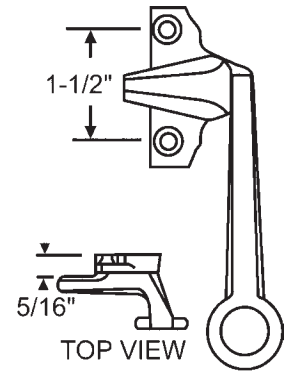

Part #	Finish
32-270	White Bronze

Pole Hole
WARE

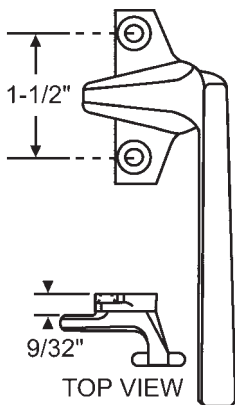

Part #	Hand	Finish
900-198LH	Opposite	White Bronze
900-198RH	Shown	White Bronze

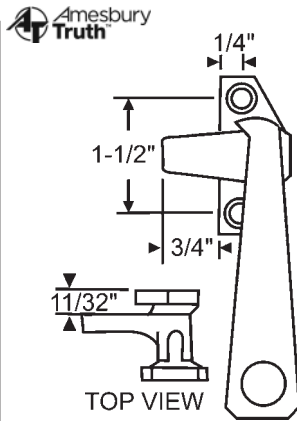

Part #	Hand	Finish
32-319-8	Shown	Chestnut Bronze
32-318-8	Opposite	Chestnut Bronze

Offset Base. Pole Hole. Die Cast

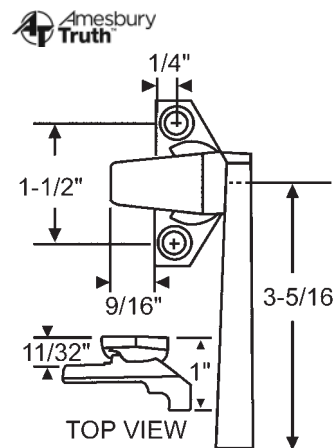

Part #	Hand	Finish
32-311-1	Shown	Bronze
32-311-3	Shown	White
32-311-7	Shown	Aluminum
32-311-8	Shown	Chestnut Bronze
32-311-10	Shown	Black
32-311-11	Shown	Red
32-310-1	Opposite	Bronze
32-310-3	Opposite	White
32-310-7	Opposite	Aluminum
32-310-8	Opposite	Chestnut Bronze
32-310-10	Opposite	Black
32-310-11	Opposite	Red

Offset Base. Die Cast

WINDOW REPLACEMENT HARDWARE

PROJECT-OUT TWO HOLE CAM HANDLES

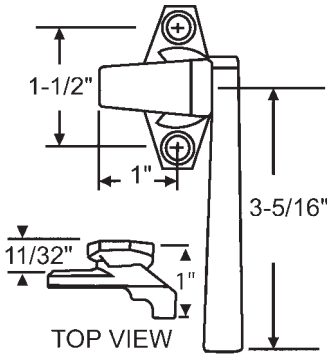

Part #	Hand	Finish
32-313-1	Shown	Bronze
32-313-3	Shown	White
32-313-7	Shown	Aluminum
32-313-12	Shown	Medium Bronze
32-312-1	Opposite	Bronze
32-312-3	Opposite	White
32-312-7	Opposite	Aluminum
32-312-12	Opposite	Medium Bronze

In Line Base. Die Cast
Pole Hole Version Available. Call Account Manager for Details.

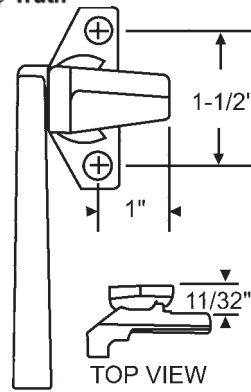

Part #	Hand	Finish
32-449-14	Shown	Cocoa Brown
32-448-14	Opposite	Cocoa Brown
32-449-9	Shown	Beige
32-448-9	Opposite	Beige

Offset Base. Die Cast

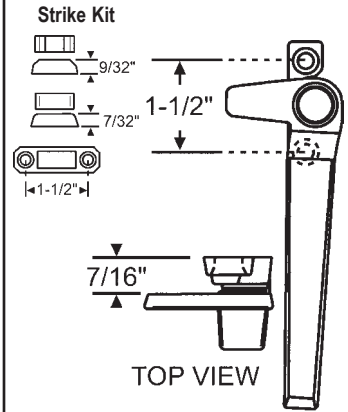

Part #	Finish
32-406RHB	Black

w/ Strike Kit

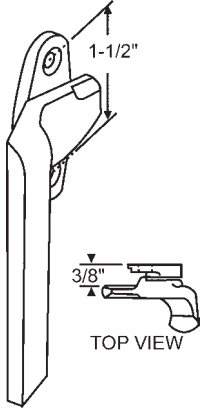

Part #	Finish
32-403	White
32-403BG	Beige

Plastic. Use Keeper 50-836
KASSON/KELLER

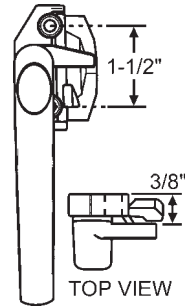

Part #	Hand	Finish
32-552LHW	Shown	White
32-552RHW	Opposite	White
32-552LHB	Shown	Black
32-552RHB	Opposite	Black

Wedgeless Cam Handle.
Aluminum Die Cast Body with Injection Moulded Nylon Flap

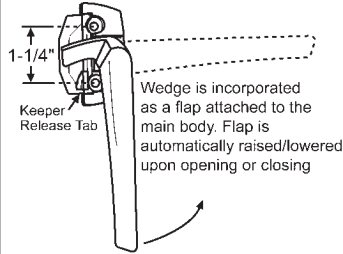

Part #	Hand	Finish
32-455RW	Shown	White
32-455LW	Opposite	White
32-455RB	Shown	Black
32-455LB	Opposite	Black

Wedgeless Cam Handle

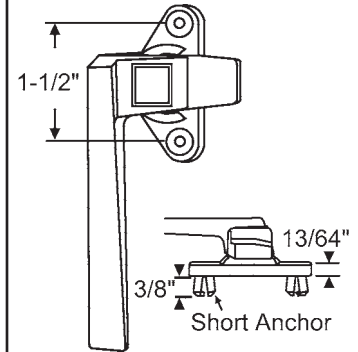

Part #	Hand	Finish
32-464LH	Shown	White
32-464RH	Opposite	White

Plastic

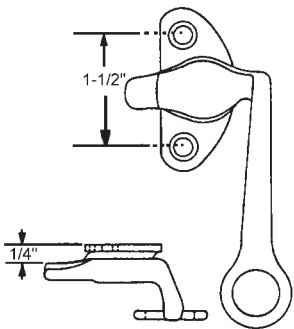

Part #	Hand	Finish
900-8988RH	Shown	Red Bronze
900-8988LH	Opposite	Red Bronze

Pole Hole
BAYLEY

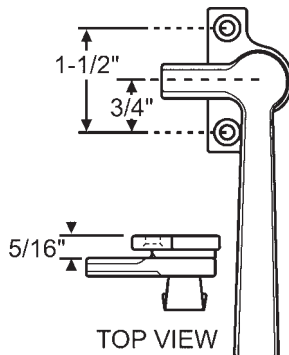

Part #	Hand	Finish
32-274B	Shown	Aluminum
32-275B	Opposite	Aluminum

Two Hole Replacement for
32-274 & 32-245

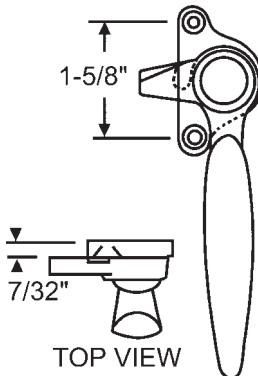

Part #	Finish
32-251	Copper

Water Rolled Finish
Project Out Handle

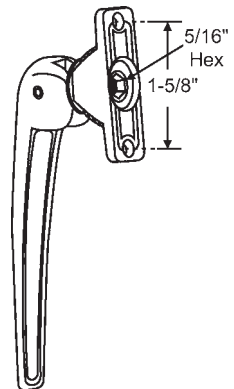

Part #	Finish
900-10729	Black Plastic with Die Cast Hex
900-10729WB	All White Bronze

CLEARVIEW

WINDOW REPLACEMENT HARDWARE

PROJECT-OUT THREE & FOUR HOLE CAM HANDLES

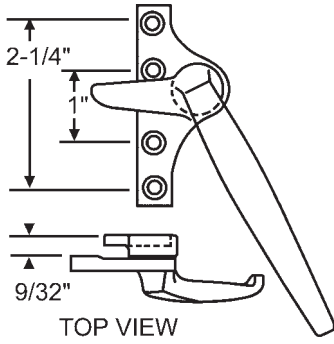

Part #	Hand	Finish
32-233	Shown	Red Bronze
32-234	Opposite	Red Bronze

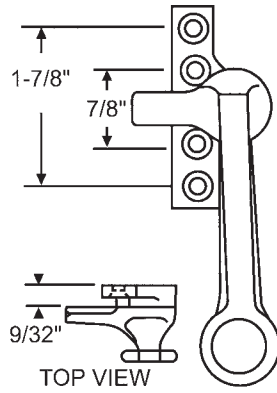

Part #	Finish
32-283	White Bronze

Pole Hole

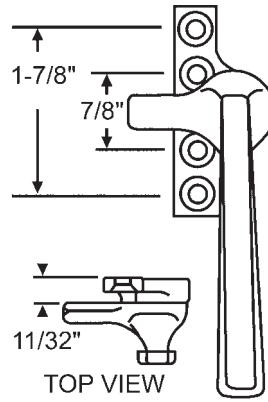

Part #	Hand	Finish
32-210	Shown	White Bronze
32-209	Opposite	White Bronze

THORN

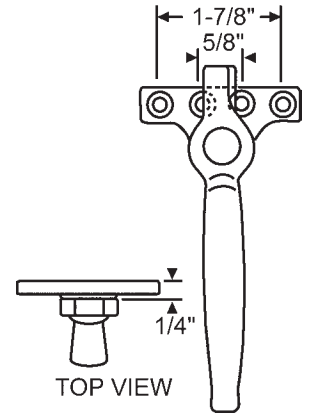

Part #	Finish
32-224	Red Bronze

Use Screw 20-030

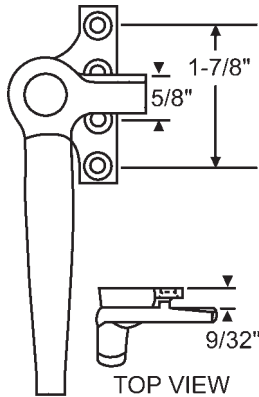

Part #	Hand	Finish
32-227	Shown	Dark Bronze
32-226	Opposite	Dark Bronze

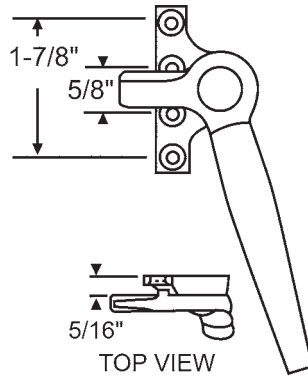

Part #	Hand	Finish
32-228DB	Shown	Dark Bronze
32-228	Shown	Red Bronze
32-229	Opposite	Red Bronze

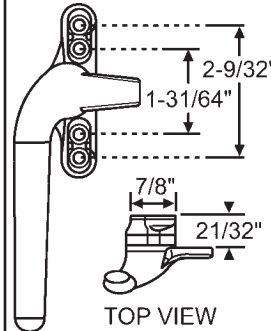

Part #	Hand	Finish
32-587LHW	Shown	White
32-587RHW	Opposite	White

Die Cast

PROJECT-OUT INSIDE MOUNT CAM HANDLES

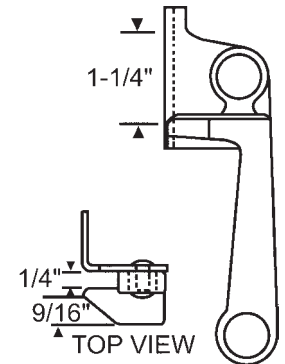

Part #	Finish
32-206	Copper

Water Rolled Finish

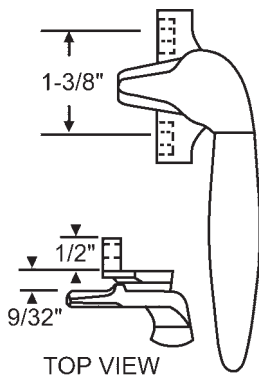

Part #	Hand	Finish
32-285	Shown	White Bronze
32-285LH	Opposite	White Bronze

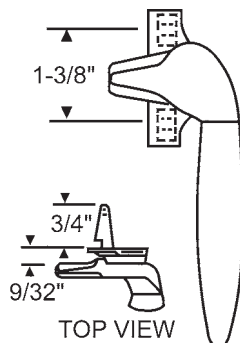

Part #	Hand	Finish
32-258	Shown	White Bronze
32-258LH	Opposite	White Bronze

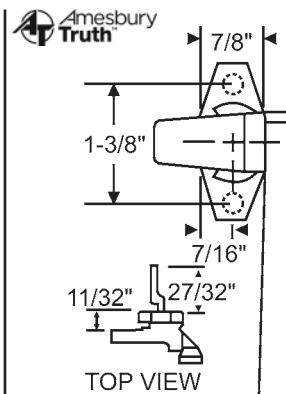

Part #	Hand	Finish
32-315-7	Shown	Aluminum
32-315-8	Shown	Chestnut Bronze
32-314-7	Opposite	Aluminum
32-314-8	Opposite	Chestnut Bronze

In Line Base. Die Cast

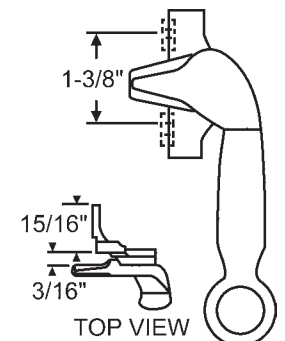

Part #	Hand	Finish
32-259RH	Shown	White Bronze
32-259LH	Opposite	White Bronze

with Pole Hole (shown)

Part #	Hand	Finish
900-18541RH	Shown	White Bronze
900-18541LH	Opposite	White Bronze

No Pole Hole

WINDOW REPLACEMENT HARDWARE

PROJECT-OUT INSIDE MOUNT CAM HANDLES

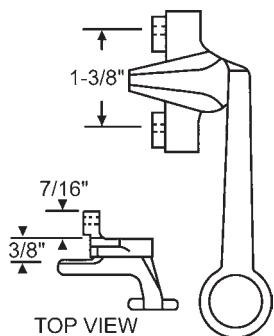

Part #	Finish
32-262	White Bronze

Holes Tapped 10-24

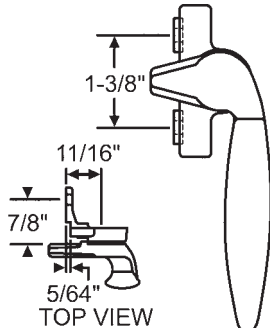

Part #	Hand	Finish
900-9798RH	Shown	White Bronze
900-9798LH	Opposite	White Bronze

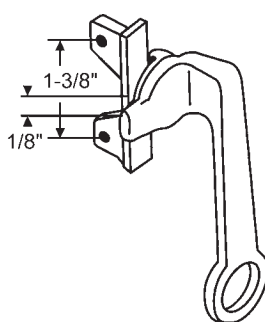

Part #	Hand	Finish
1206PR	Shown	Bronze
1206PL	Opposite	Bronze

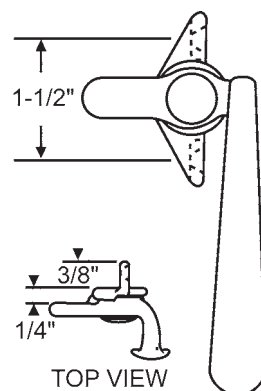

Part #	Finish
32-305	White Bronze

PROJECT-IN HANDLES

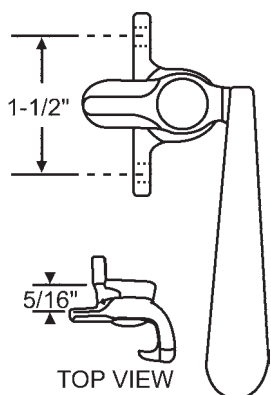

Part #	Finish
900-8601	White Bronze

Used with Keeper 50-726

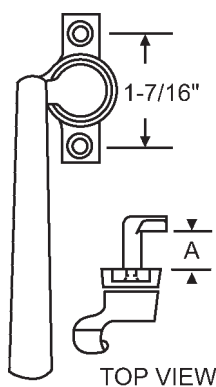

Part #	A	Finish
32-268	9/16"	White Bronze
32-268-.5	1/2"	White Bronze

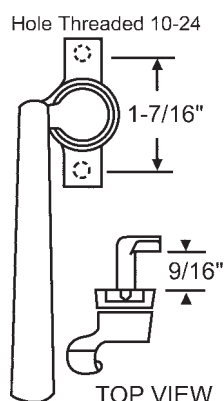

Part #	Hand	Finish
32-269LH	Shown	White Bronze
32-269RH	Opposite	White Bronze

Bottom Mount

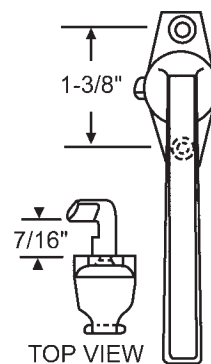

Part #	Hand	Finish
32-266	Shown	White Bronze
32-267	Opposite	White Bronze

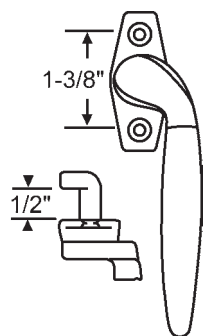

Part #	Hand	Finish
900-207RH	Shown	White Bronze
900-207LH	Opposite	White Bronze

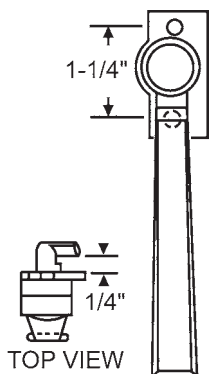

Part #	Finish
32-276	Copper

Water Rolled Finish

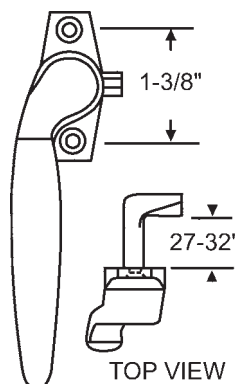

Part #	Finish
32-287	White Bronze

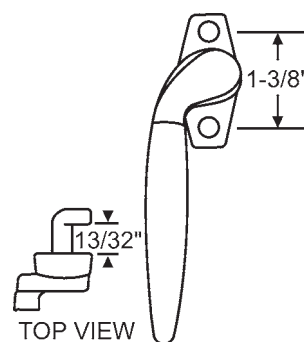

Part #	Finish
32-556	White Bronze

Top Mount

WINDOW REPLACEMENT HARDWARE

PROJECT-IN HANDLES

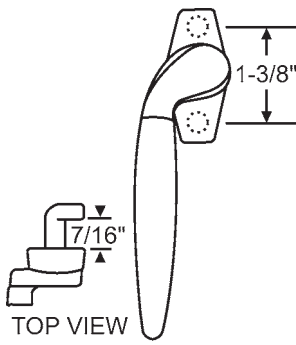

Part #	Finish
32-290	White Bronze

Bottom Mount

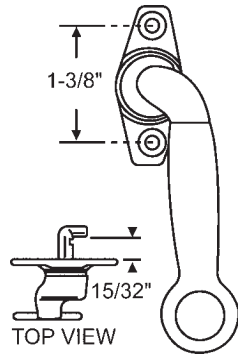

Part #	Hand	Finish
900-210RH	Shown	White Bronze
900-210LH	Opposite	White Bronze

Pole Ring

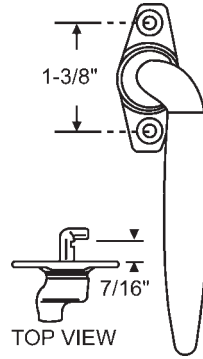

Part #	Hand	Finish
32-303	Shown	White Bronze
32-302	Opposite	White Bronze

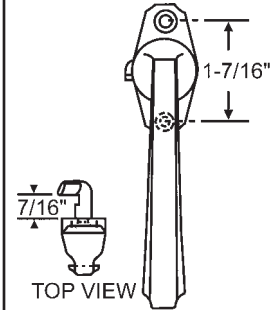

Part #	Hand	Finish
900-9799	Shown	Copper
900-9800	Opposite	Copper

WARE

HANDLESS FASTENERS

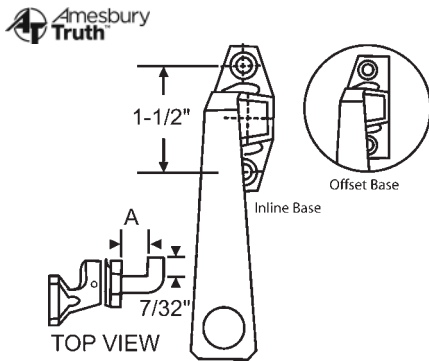

Part #	Finish	A	Base Type	Hand
32-341-8	Chestnut Bronze	7/16"	Offset	Shown
32-342-8	Chestnut Bronze	7/16"	Offset	Opposite
32-345-7	Aluminum	7/16"	In-line	Shown
32-346-7	Aluminum	7/16"	In-line	Opposite
32-347-8	Chestnut Bronze	1/2"	In-line	Shown
32-348-8	Chestnut Bronze	1/2"	In-line	Opposite

Pole Ring, Die Cast

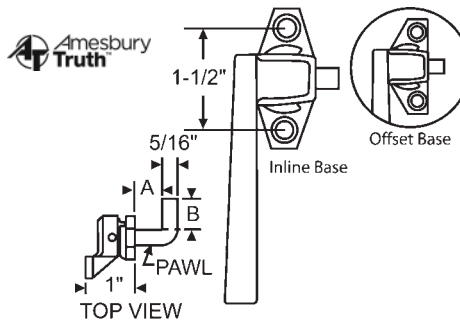

Part #	Finish	A	B	Base Type	Hand
32-329-8	Chestnut Bronze	7/16"	7/32"	Offset	Shown
32-330-8	Chestnut Bronze	7/16"	7/32"	Offset	Opposite
32-334-8	Chestnut Bronze	33/64"	11/32"	Offset	Opposite
32-335-8	Chestnut Bronze	7/16"	7/32"	In-line	Shown
32-335-7	Aluminum	7/16"	7/32"	In-line	Shown
32-336-7	Aluminum	7/16"	7/32"	In-line	Opposite
32-337-7	Aluminum	1/2"	7/32"	In-line	Shown
32-337-8	Chestnut Bronze	1/2"	7/32"	In-line	Shown
32-338-8	Chestnut Bronze	1/2"	7/32"	In-line	Opposite
32-339-8	Chestnut Bronze	33/64"	11/32"	In-line	Shown

Die Cast

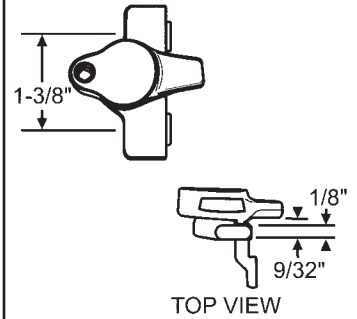

900-20321
White Bronze

CASEMENT HANDLES

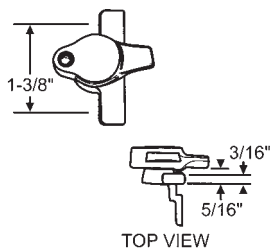

32-450
White Bronze
ACORN

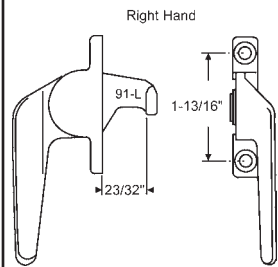

Part #	Hand	Finish
34-61	Opposite	Light Bronze
34-62	Shown	Light Bronze

Used with 50-717 Keeper
HOPE'S

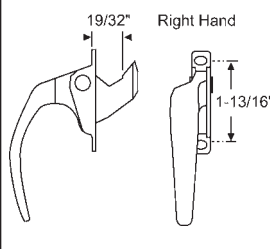

Part #	Hand	Finish
34-74	Shown	Bronze
34-75	Opposite	Bronze

HOPE'S

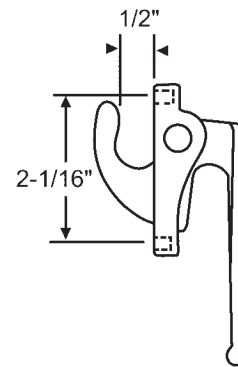

Part #	Finish
34-68	White Bronze

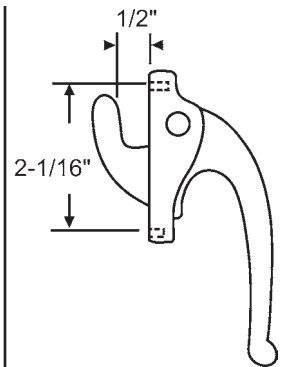

Part #	Finish
34-53	Dark Bronze

WINDOW REPLACEMENT HARDWARE

CASEMENT HANDLES

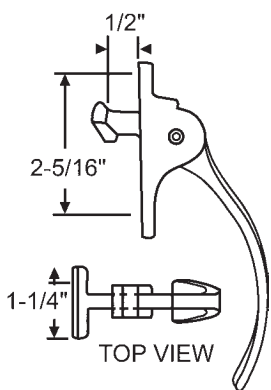

Part #	Finish
34-67DC	Light Bronze

Die Cast. Double Locking
Used with 50-717 Keeper

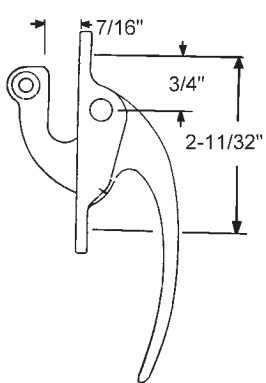

Part #	Finish
900-8977	White Bronze

Lower Casement Handle

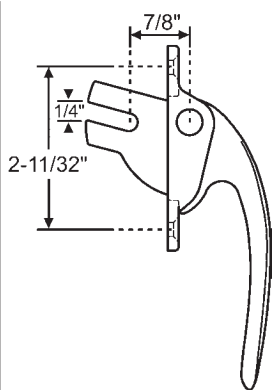

34-178
White Bronze
Euro Groove
TRACO/KAWNEER

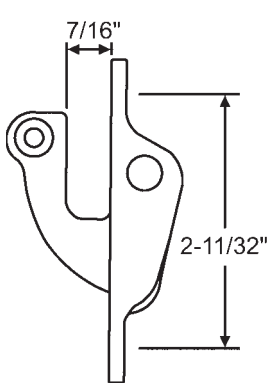

Part #	Finish
900-14118	White Bronze

Upper Locking Cam

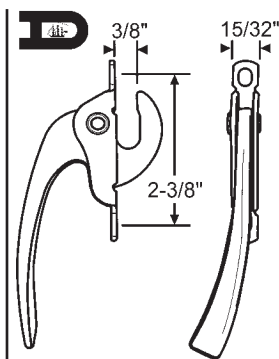

Part #	Hand	Finish
34-54	Shown	Brown
34-55	Opposite	Brown
34-56	Shown	Aluminum
34-57	Opposite	Aluminum

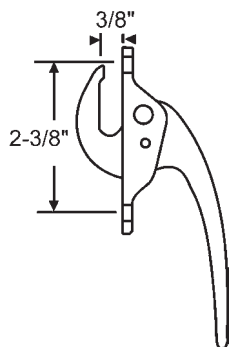

Part #	Finish
34-58	Gray
34-58B	Bronze
34-58W	White

Straight Handle. Die Cast.

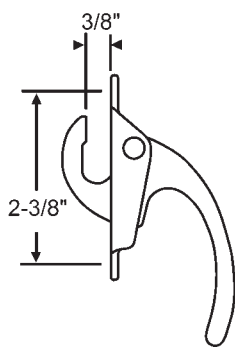

Part #	Finish
34-70	Brown

Die Cast

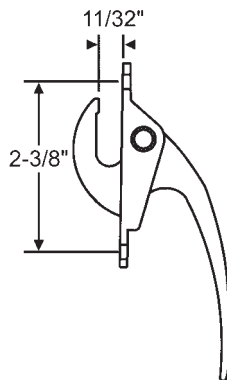

Part #	Finish
34-76	Dark Bronze

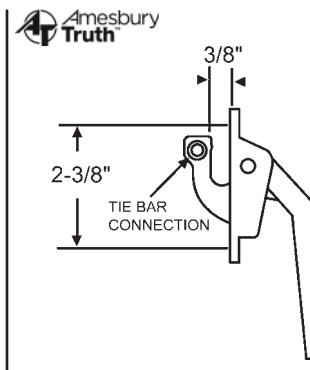

Part #	Finish
34-82-3	White
34-82-7	Aluminum
34-82-8	Chestnut Bronze

Dual Locking Handle. Die Cast

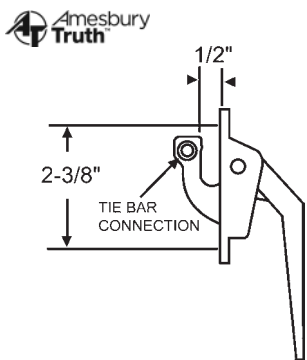

Part #	Finish
34-84-3	White
34-84-8	Chestnut Bronze
34-84-7	Aluminum
34-84-13	Brushed Copper Nickel

Dual Locking Handle. Die Cast

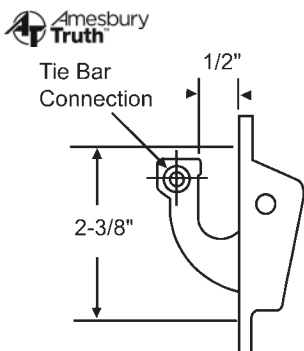

Part #	Finish
34-85-3	White
34-85-7	Aluminum
34-85-8	Chestnut Bronze
34-85-10	Black

Upper Locking Cam. Die Cast

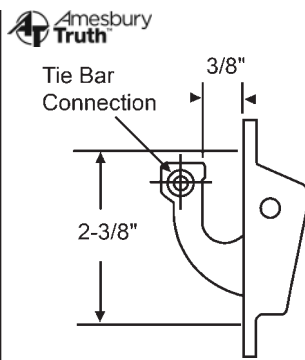

Part #	Finish
34-83-3	White
34-83-7	Aluminum
34-83-8	Chestnut Bronze
34-83-10	Black

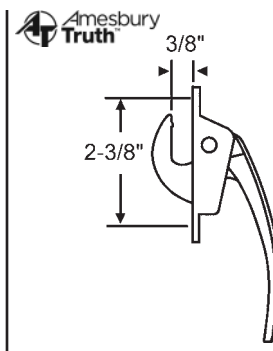

Part #	Finish
34-80-3	White
34-80-8	Chestnut Bronze
34-80-7	Aluminum
34-80-12	Medium Bronze

Die Cast

WINDOW REPLACEMENT HARDWARE

CASEMENT HANDLES

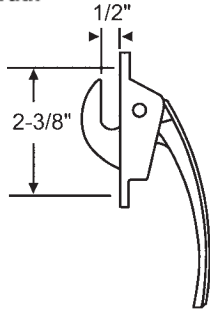

Part #	Finish
34-81-3	White
34-81-8	Chestnut Bronze

Die Cast

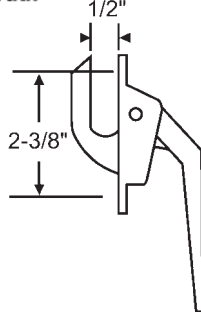

Part #	Finish
34-91-3	White

Die Cast

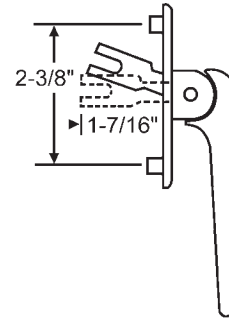

Part #	Finish
34-3	White

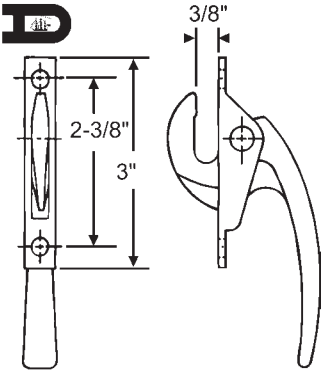

Part #	Finish
34-71	Light Bronze

Die Cast. Straight Handle

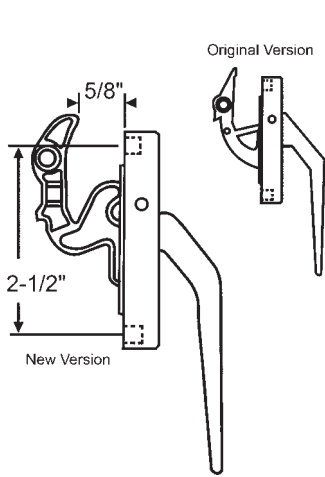

Part #	Finish
900-14723	Bronze

ACORN

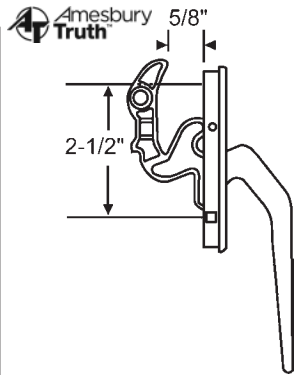

Part #	Finish
34-95-1	Bronze
34-95-3	White
34-95-8	Chestnut Bronze
34-95-9	Beige
34-95-7	Aluminum
34-95-10	Black
34-95-29	Bright White

Die Cast Lock Bar

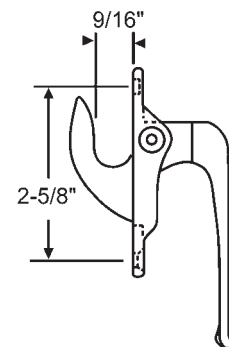

Part #	Hand	Finish
34-51	Shown	White Bronze
34-50	Opposite	White Bronze

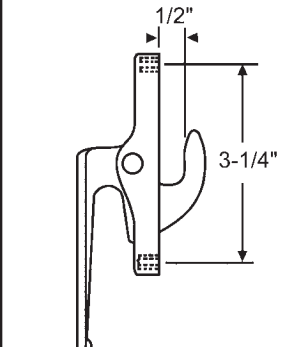

Part #	Finish
34-52	Dark Bronze

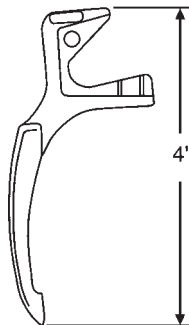

Part #	Color
34-113	White
34-111	Brass
34-115	Champagne

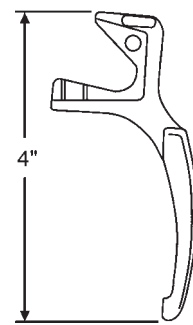

Part #	Color
34-112	White
34-110	Brass
34-114	Champagne

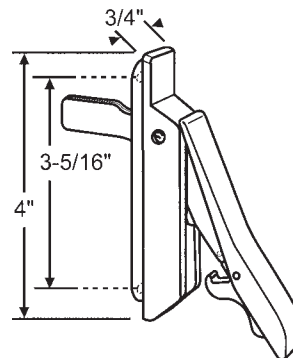

854-11000
Casement Window Multipoint Locking Handle. White. Nylon Housing. Metal Lever

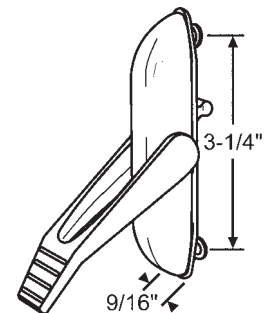

34-917WA
LH & RH Set (RH Shown). White
SILVER LINE

WINDOW REPLACEMENT HARDWARE

CASEMENT LOCKS

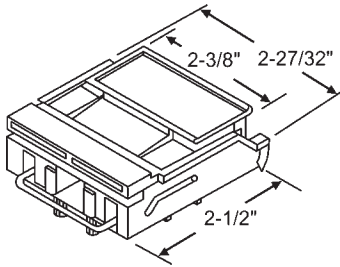

Part #	Finish
900-12199	Driftwood
900-12199W	White

PEACHTREE

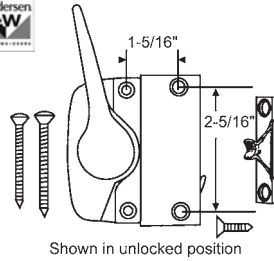

Part #	Hand	Finish
750-0531708	Shown	Bronze
750-0531712	Opposite	Bronze

Replaces Andersen numbers
0533508/0533512, 0533509/0533513
and 0533608/0533612

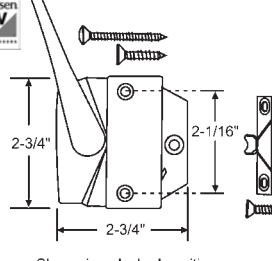

Part #	Hand	Finish
750-1351408	Shown	Stone
750-1351410	Opposite	Stone
750-1351420	Shown	White
750-1351422	Opposite	White

Replaces Andersen numbers
0565708/0565712

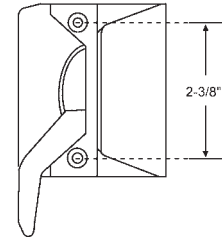

Part #	Hand	Finish
34-42-1	Shown	Bronze
34-43-1	Opposite	Bronze
34-42-3	Shown	White
34-43-3	Opposite	White
34-42-87	Shown	Gold
34-43-87	Opposite	Gold

Die Cast. Uses 50-435 Keeper

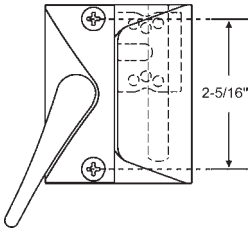

Part #	Finish
34-102-1	Bronze
34-102-3	White
34-102-5	Bright Brass

Primary Lock. Non-Handed. Die Cast

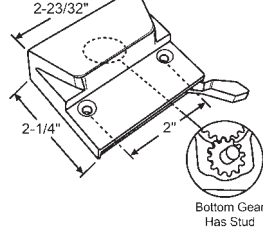

Part #	Finish
34-129-3	White
34-129-5	Brass
34-129-8	Chestnut Bronze

Low Profile Sash Lock

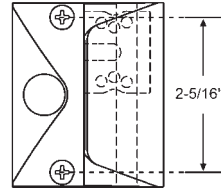

Part #	Finish
34-103-1	Bronze
34-103-3	White
34-103-5	Bright Brass

Secondary Lock. Non-Handed, Die Cast

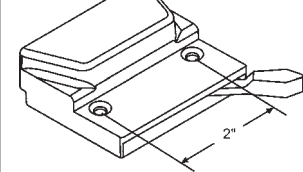

Part #	Finish
34-47-1	Bronze
34-47-3	White
34-47-9	Beige
34-47-87	Gold

Non-Handed. Die Cast

MULTIPOINT LOCKS

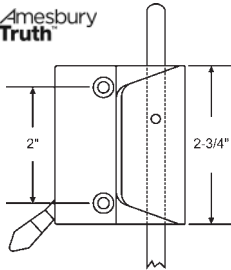

Part #	Finish
34-46-1	Bronze
34-46-3	White
34-46-29	Bright White

Non-Handed; for tandem application with
use of tie bar (hole drilled through bottom
gear piece). Die Cast

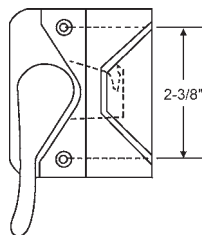

Part #	Hand	Finish
34-64-1	Opposite	Bronze
34-64-2	Opposite	Gold
34-63-3	Shown	White

Die Cast

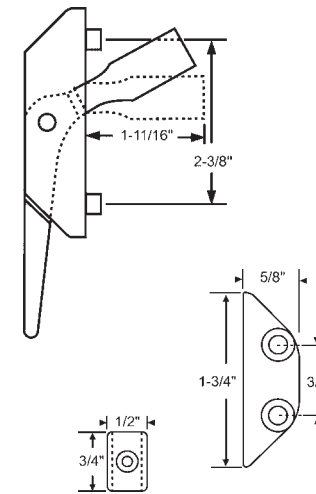

Part #	Finish	Description
34-159	White	Handle
39-610	White	Keeper
39-611	White	Slider Block

SILVER LINE

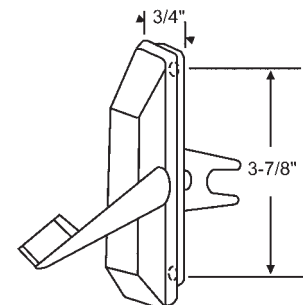

Part #	Finish
34-126BG	Beige
34-126EB	Earth Brown

WINDOW REPLACEMENT HARDWARE

MULTIPOINT LOCKS

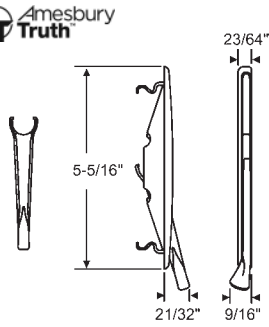

34-170-3

Encore Handle & Escutcheon
White

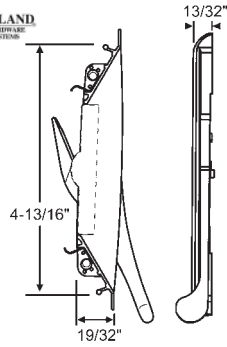

Part #	Finish
34-179BP	Brass Plated
34-179BZ	Bronze
34-179W	White

Casement Handle & Bezel

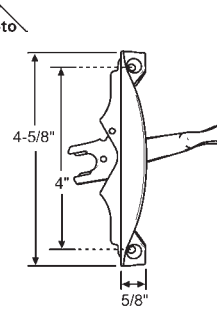

Part #	Hand
39-604CHP	Champagne

Handle & Escutcheon Kit

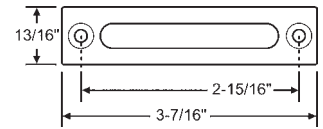

39-603W

Plastic Guide Housing. White

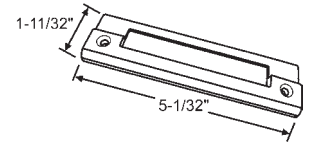

39-835

Lock Slide Housing. White Nylon
SILVERLINE

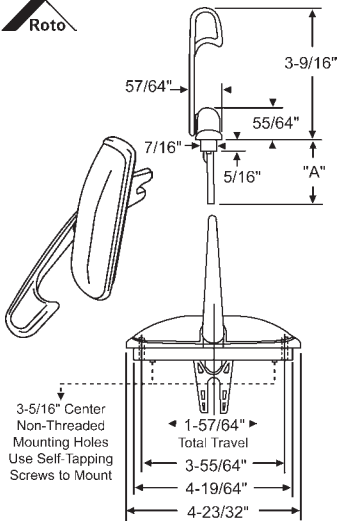

3-5/16" Center Non-Threaded Mounting Holes Use Self-Tapping Screws to Mount

Part #	"A"	Finish
34-165-29W	1-9/64" (29mm)	White
34-165-29SV	1-9/64" (29mm)	Silver
34-165-37W	1-29/64" (37mm)	White
34-165-37AD	1-29/64" (37mm)	Almond

34-169

Encore Lock Drive Assembly

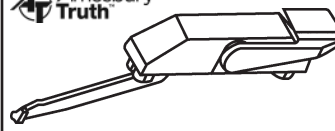
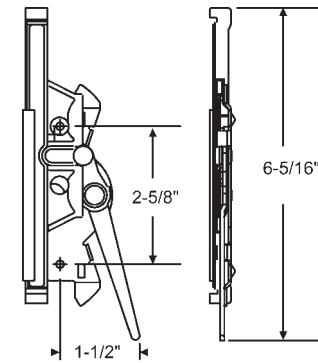

Part #	Hand	Finish
34-100-15NEG	Shown	Non E-Gard, Off White
34-99-15NEG	Opposite	Non E-Gard, Off White
34-100-1	Shown	Bronze
34-100-1NEG	Shown	Non E-Gard, Bronze
34-99-1	Opposite	Bronze
34-99-1NEG	Opposite	Non E-Gard, Bronze
34-100-3	Shown	White
34-99-3	Opposite	White
34-100-8	Shown	Chestnut Bronze
34-99-8	Opposite	Chestnut Bronze
34-100-29	Shown	Bright White
34-99-29	Opposite	Bright White
34-99-9	Opposite	Beige

Used in Tie Bar Applications

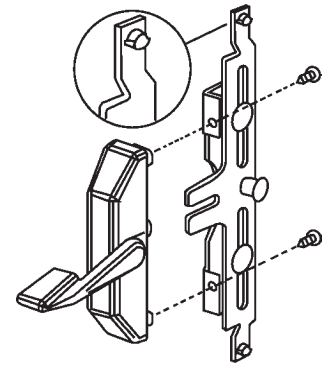

Part #	Hand	Finish
34-93-3	Shown	White
34-94-3	Opposite	White

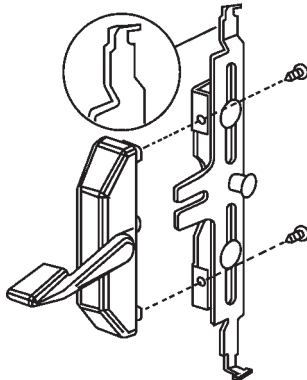

Part #	Hand	Finish
34-127-3	Shown	White
34-128-3	Opposite	White

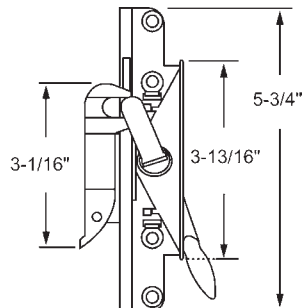

Part #	Hand	Finish
34-134-1	Shown	Bronze
34-135-1	Opposite	Bronze
34-134-15	Shown	Off White
34-135-15	Opposite	Off White

MARVIN

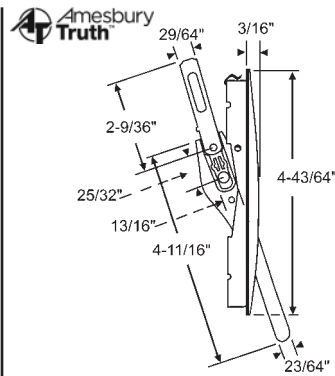

Part #	Hand	Finish
34-136-3	Shown	White
34-136-1	Shown	Bronze
34-136-4	Shown	Coppertone

Truth Mirage. Includes Locking Handle, Escutcheon and Backplate. Used with Keeper 50-883

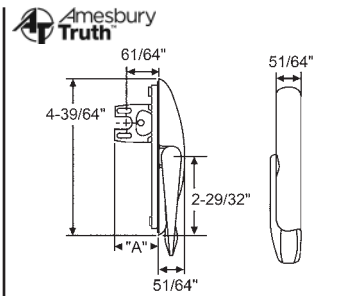

Part #	Finish	"A"
34-140-3G	White	1-25/64"
34-140-5G	Brass Plated	1-25/64"
34-144-3G	White	1-41/64"
34-144-9G	Beige	1-41/64"
34-144-10G	Black	1-41/64"
34-141-3G	White	1-57/64"

Truth Maxim® Lock with Gasket Non-Handed

WINDOW REPLACEMENT HARDWARE

MULTIPOINT LOCKS

SPACIO TILT AND TURN HANDLE

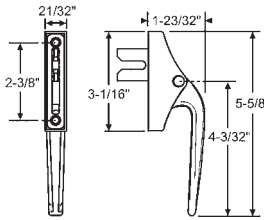

Part #	Finish
34-230W	White

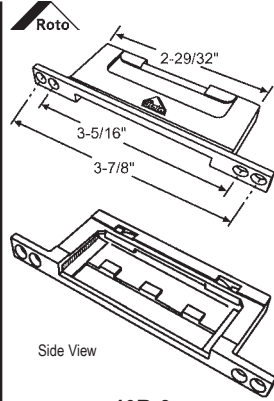

40R-3
Safety Lock Device. Zinc Die Cast

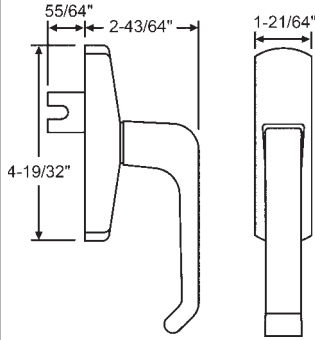

GU

Part Number	Finish
854-14661	Silver
854-14662	Dark Bronze
854-14663	White

Used w/ AK8 Hardware System (Uses hinges that clamp in the frame groove)
Spacio

Part Number	Finish
854-14658	Silver
854-14659	Dark Bronze
854-14660	White

Used w/ AS130 Hardware System (Uses hinges that required drilling the frame)

SPRING CATCHES

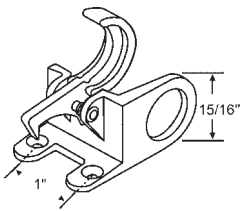

900-18718
Snap Lock with Pole Ring. White Bronze. Use Screw 20-447

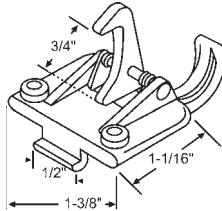

32-393
Lower Automatic Lock. White Bronze
SEASONALL

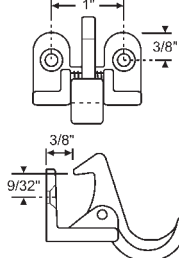

32-395
White Bronze

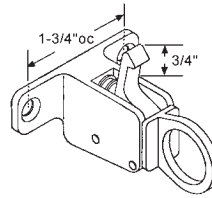

900-20322
White Bronze
SWS

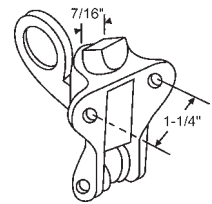

32-280

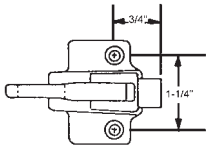

900-11332
White Bronze

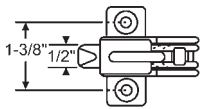

900-16312

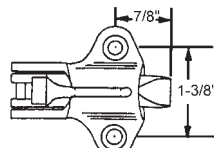

900-9258
White Bronze

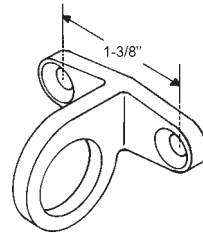

900-8650
Pole Ring
White Bronze

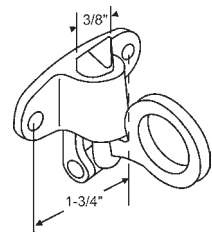

32-277
Aluminum Finish
Use with 900-9107 Keeper.

CUSTODIAL/VENT LOCKS

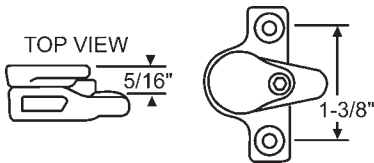

32-256
White Bronze Finish
Use with 900-218 Key.

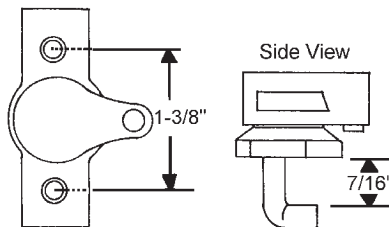

900-13324
White Bronze

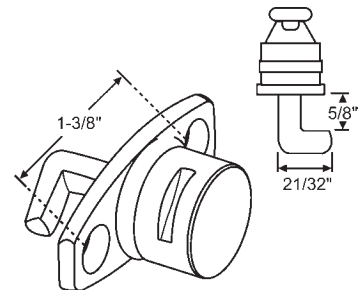

32-603BZ
Bronze

WINDOW REPLACEMENT HARDWARE

CUSTODIAL/VENT LOCKS

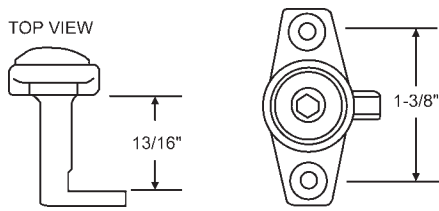

32-284

White Bronze. Use with 900-19637 Key.

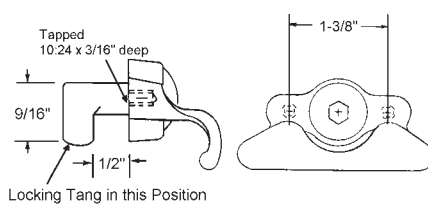

900-11108

White Bronze
Use with 900-19637 Key.

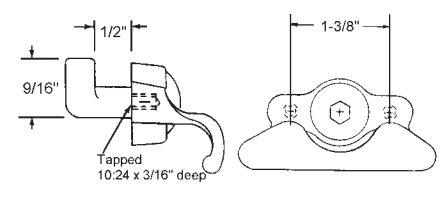

900-1221

White Bronze
Use with 900-19637 Key.

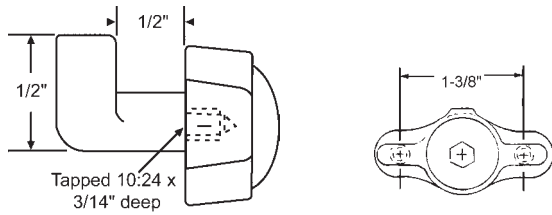

900-7970

White Bronze
Use with 900-19637 Key.

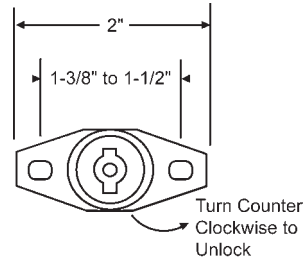

Part #	Finish
32-379-7	Aluminum
32-379-8	Chestnut Bronze

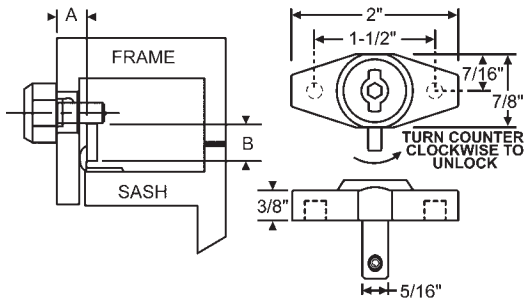
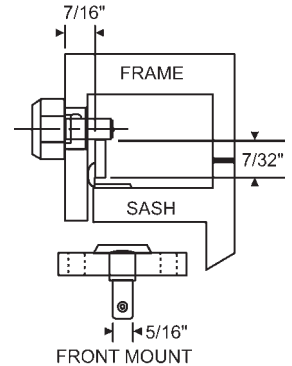

REAR MOUNT

Part Number	Finish	A	B	Forced Entry Resistance
32-373-10	Black	7/16"	7/32"	300 LBS.
32-373-8	Chestnut Bronze	7/16"	7/32"	300 LBS.
32-373-3	White	7/16"	7/32"	300 LBS.
32-373-00	Primed	7/16"	7/32"	300 LBS.
32-374-3	White	7/16"	11/32"	250 LBS.
32-374-7	Aluminum	7/16"	11/32"	250 LBS.
32-374-8	Chestnut Bronze	7/16"	11/32"	250 LBS.
32-376-7	Aluminum	7/8"	7/32"	300 LBS.
32-376-10	Black	7/8"	7/32"	300 LBS.
32-376-12	Medium Bronze	7/8"	7/32"	300 LBS.
32-376-8	Chestnut Bronze	7/8"	7/32"	300 LBS.
32-376-3	White	7/8"	7/32"	300 LBS.
32-376-13	Brushed Copper Nickel	7/8"	7/32"	300 LBS.
32-377-1	Bronze	7/8"	11/32"	250 LBS.
32-377-10	Black	7/8"	11/32"	250 LBS.
32-377-12	Medium Bronze	7/8"	11/32"	250 LBS.
32-377-6	Clay	7/8"	11/32"	250 LBS.
32-377-7	Aluminum	7/8"	11/32"	250 LBS.
32-377-8	Chestnut Bronze	7/8"	11/32"	250 LBS.

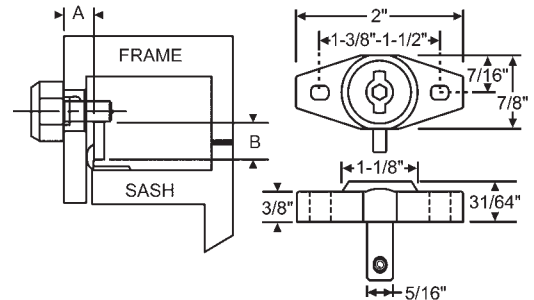

FRONT MOUNT

Part Number	Finish	A	B	Forced Entry Resistance
32-379-12	Medium Bronze	7/16"	7/32"	300 LBS.
32-379-3	White	7/16"	7/32"	300 LBS.
32-379-7	Aluminum	7/16"	7/32"	300 LBS.
32-379-8	Chestnut Bronze	7/16"	7/32"	300 LBS.
32-381-12	Medium Bronze	7/16"	9/16"	160 LBS.
32-381-7	Aluminum	7/16"	9/16"	160 LBS.
32-381-8	Chestnut Bronze	7/16"	9/16"	160 LBS.
32-382-12	Medium Bronze	7/8"	7/32"	300 LBS.
32-382-3	White	7/8"	7/32"	300 LBS.
32-382-7	Aluminum	7/8"	7/32"	300 LBS.
32-382-8	Chestnut Bronze	7/8"	7/32"	300 LBS.
32-385-12	Medium Bronze	7/8"	9/16"	160 LBS.
32-385-13	Brushed Copper Nickel	7/8"	9/16"	160 LBS.
32-385-7	Aluminum	7/8"	9/16"	160 LBS.
32-385-8	Chestnut Bronze	7/8"	9/16"	160 LBS.
32-387-12	Medium Bronze	7/8"	15/16"	50 LBS.
32-387-3	White	7/8"	15/16"	50 LBS.
32-387-5	Bright Brass	7/8"	15/16"	50 LBS.
32-387-7	Aluminum	7/8"	15/16"	50 LBS.
32-387-8	Chestnut Bronze	7/8"	15/16"	50 LBS.

WINDOW REPLACEMENT HARDWARE

REMOVABLE HANDLE KEYS

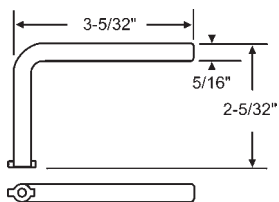

39-91

Custodial Lock Handle Key

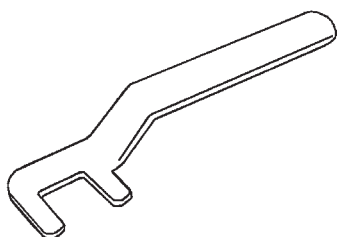

39-90

Spanner Tool for Truth Die Cast Locks

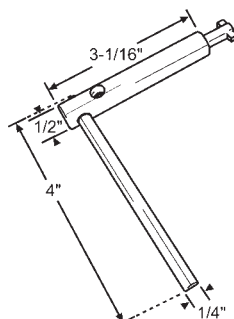

39-942

Custodial Lock Handle Key, Black



900-21413

Handle Cam Wrench with 1/8" Hex



900-11209

Handle Cam Wrench
with 5/32" Hex

EFCO/GRAHAM/KAWNEER

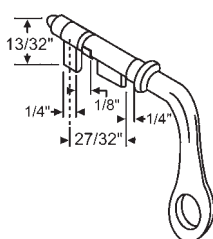

900-10521

Window Key

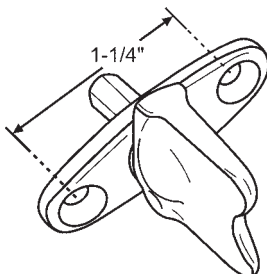

900-21510

AC Key with 7/32" Hex

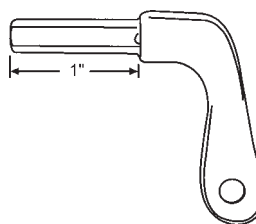

900-19637

1/4" Hex

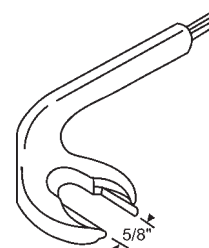

900-218

Hex fits 5/32" Allen Set Screw
for bronze handles.

PROJECT IN, PROJECT OUT, & CASEMENT KEEPERS & STRIKES

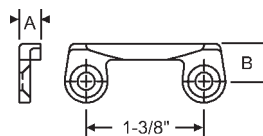

Part #	A	B
50-1107	7/16"	3/8"
900-9131	11/32"	7/16"
50-664	7/16"	7/16"
900-7262	1/4"	7/16"
900-11816	11/32"	5/16"

These standard keepers are typically concealed in the frame. They are designed to work with the 156 and 158 series handles and come in many varieties to fit your specific profile. White Bronze

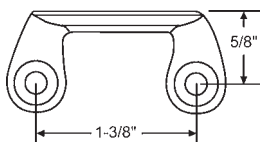

50-668

White Bronze

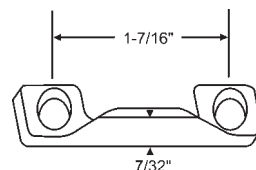

50-693

White Bronze

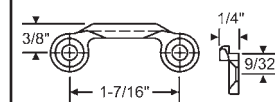

900-22624

This Keeper features an edge designed to fit over a rib on and extruded frame.

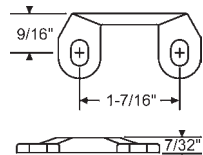

900-21734

This keeper features slotted mounting holes to allow the fit to be adjusted on sight to maximize the window compression for optimal performance.

White Bronze

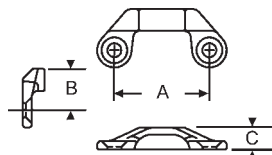

Part #	A	B	C	Finish
50-665B	1-3/8"	1/2"	5/32"	Black
50-665	1-3/8"	1/2"	5/32"	White Bronze
50-674	1-3/8"	1/2"	3/16"	White Bronze
50-244WBZ	1-3/8"	7/16"	5/16"	White Bronze
50-683	1-3/8"	13/32"	9/32"	White Bronze
50-728	1-3/8"	19/32"	5/16"	White Bronze
50-928	1-1/2"	15/32"	3/16"	White Bronze
50-667	1-3/8"		11/64"	White Bronze

This popular strike design keeps the mounting holes away from the locking surface to allow the strike pad to be placed as close to the edge of the frame as possible.

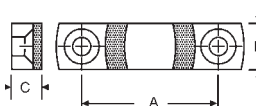

Part #	A	B	C
50-1079	1-3/8"	1/2"	11/64"
900-18263	1-1/2"	1/2"	21/64"
900-19827	1-1/2"	7/16"	7/32"
50-1302WBZ	1-1/2"	7/16"	3/16"
50-695	1-7/16"	1/2"	3/16"

These simple flat strikes are perfect for installations that have narrow mounting conditions on the frame. White Bronze

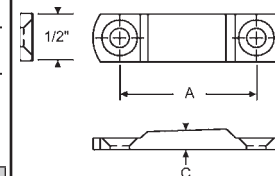

Part #	A	C
900-964	1-7/16"	9/64"
900-7861	1-7/16"	13/64"

These strikes feature an angled cam surface to gently engage the handle and compress the window seal. White Bronze

WINDOW REPLACEMENT HARDWARE

PROJECT IN, PROJECT OUT, & CASEMENT KEEPERS & STRIKES

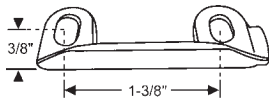

900-22584
White Bronze

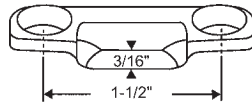

900-12905
White Bronze Burnished

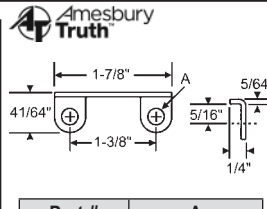

Part #	A
50-406	13/64"
50-407	1/4"

Stainless Steel. Low Profile

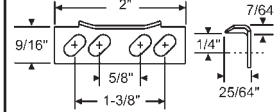

50-408
Stainless Steel. Adjustable Keeper

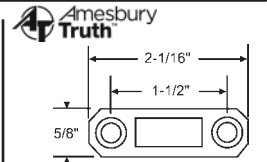

Part #	Finish
50-1251-1	Bronze
50-1251-3	White
50-1251-7	Aluminum
50-1251-8	Chestnut Bronze

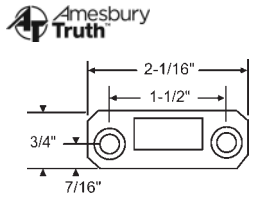

Part #	Finish
50-1252-3	White
50-1252-8	Chestnut Bronze
50-1252-12	Medium Bronze

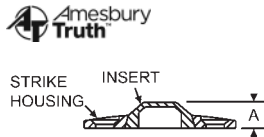

Part #	A
39-81-10	7/32"
39-82-10	9/32"
39-83-10	11/32"

Black Nylon Strike Insert.

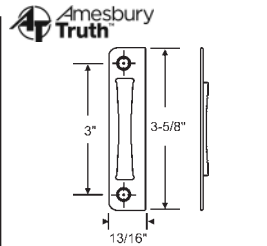

Part #	Finish
39-87-3	White
39-87-9	Beige
39-87-10	Black

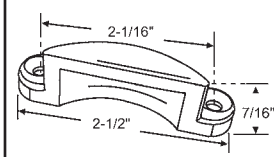

Part #	Finish
50-8360W	Off White

Plastic
KASSON/KELLER

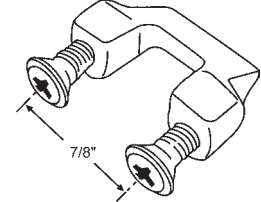

Part #	Finish
900-19680	White Bronze

SEASONALL

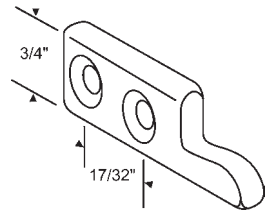

50-717
Brass. Keeper for 34-67DC.

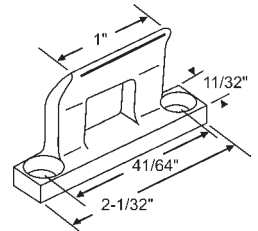

900-9107
Zinc Die Cast. Keeper for 32-277

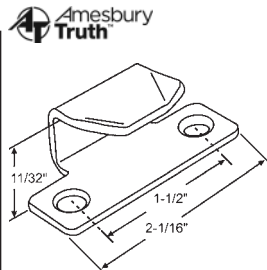

Part #	Finish
50-774-3	White
50-774-9	Beige

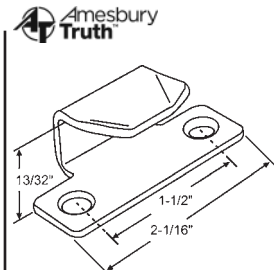

Part #	Finish
50-814-3	White
50-814-9	Beige

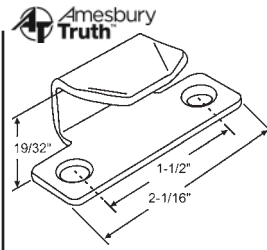

Part #	Finish
50-755-1	Bronze
50-755-3	White
50-755-14	Cocoa Brown

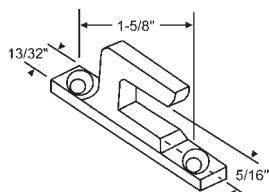

Part #	Finish
50-714	Red Bronze

Hook Type. Used with 32-224, 32-228, 32-229 Handles

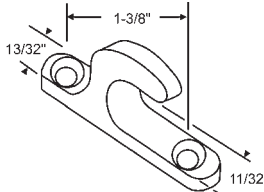

Part #	Finish
50-675	Dark Bronze

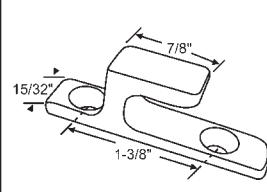

Part #	Finish
900-9761	White Bronze

Hook Type

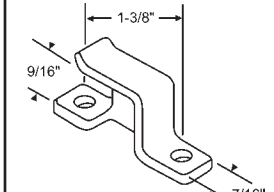

Part #	Finish
50-672	Dark Bronze

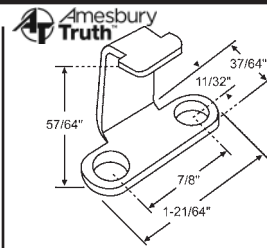

Part #	Finish
50-413	E-Gard Finish
50-759	Stainless Steel
50-739	High Strength

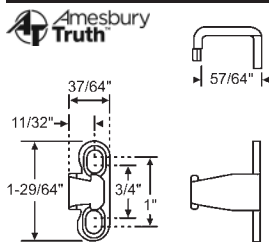

Part #	Finish
50-890	Steel

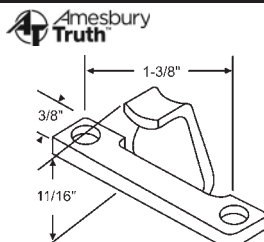

Part #	Finish
50-644	Steel

Use with 34-64, 34-63, 34-65, 34-66

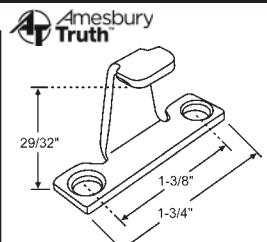

Part #	Finish
50-435	E-Gard
50-435SS	Stainless Steel

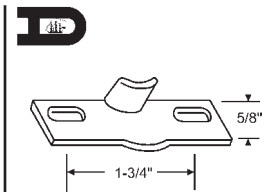

Part #	Finish
50-659	Aluminum

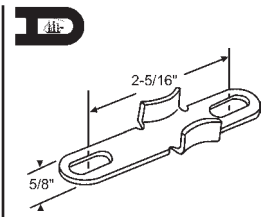

Part #	Finish
50-685A	Aluminum

WINDOW REPLACEMENT HARDWARE

PROJECT IN, PROJECT OUT, & CASEMENT KEEPERS & STRIKES

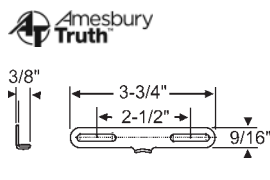

39-202
Stainless Steel

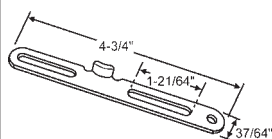

39-920
Stainless Steel. 7/64" Thick
TRACO

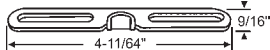

900-20912
Dichromate
ACORN

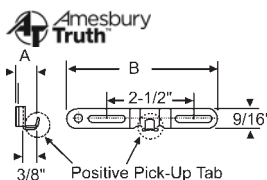

Part #	A	B
39-183	19/32"	4-19/32"
39-208	3/8"	4-47/64"
39-658	5/8"	3-43/64"

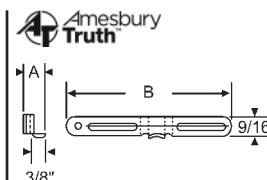

Part #	A	B
39-78	1/2"	4-41/64"
39-79	9/16"	4-19/32"

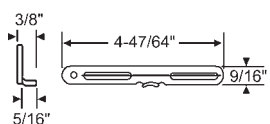

39-77
Die Cast

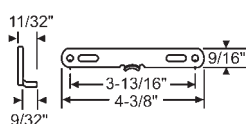

39-729
Die Cast

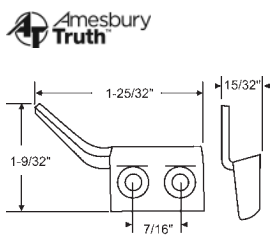

Part #	Hand
39-220	Shown
39-221	Opposite

Maxim® Multipoint Lock Keeper.
For Cone Roller System

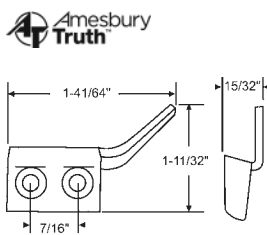

Part #	Hand
50-227	Shown
50-226	Opposite

Maxim® Multipoint Lock Keeper.
Used with Cone Tie Bars.

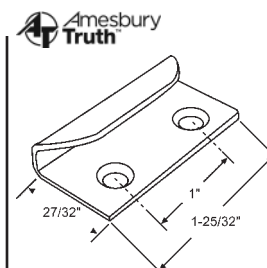

Part #	Finish
50-921	Beige

Zinc Die Cast. Maxim®

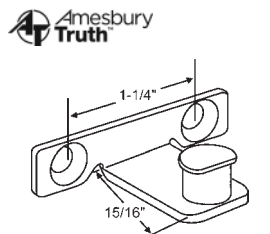

Part #	Finish
50-883	E-Gard Finish

Maxim®. For Concealed
Multipoint

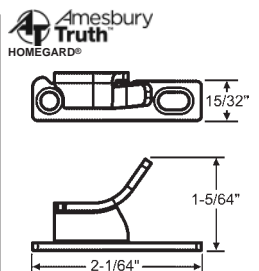

Part #	Hand	Finish
50-1117	Shown	E-Gard
50-1118	Opposite	E-Gard

HOMEWARD®

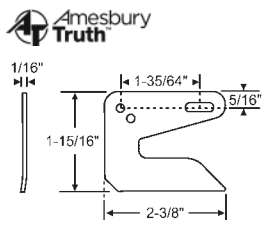

Part #	Hand
50-772	Shown
50-771	Opposite

For Interlock Roller System

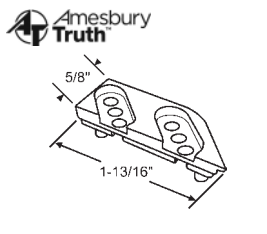

Part #	Hand
39-895	Shown
39-896	Opposite

White Nylon

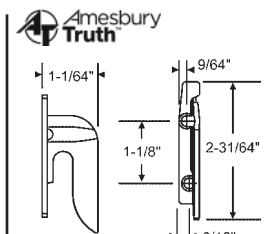

Part #	Hand
50-1115LH	Shown
50-1115RH	Opposite

Flange Keeper. Steel E-Gard

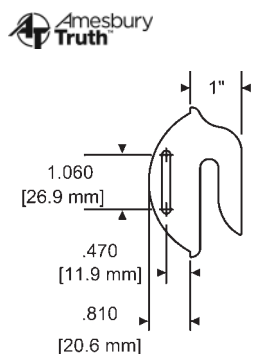

50-1113SS
Biscuit Keeper
Stainless Steel

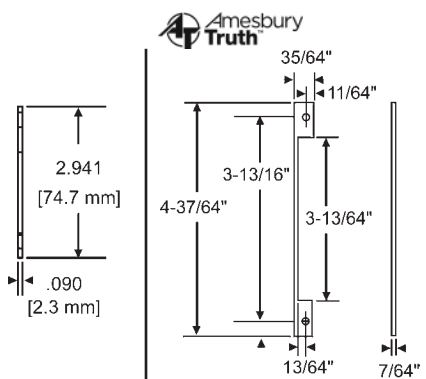

34-145
Support Plate

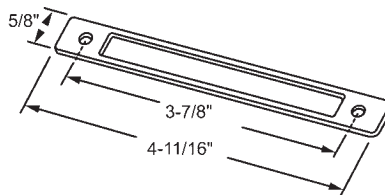

34-153
Handle Plate Guide. White. Plastic

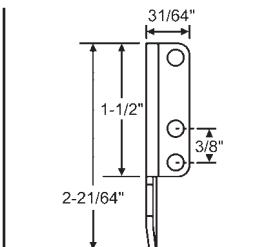

Part #	Hand
34-215LH	Shown
34-215RH	Opposite

WINDOW REPLACEMENT HARDWARE

FACE MOUNTED CASEMENT OPERATORS

TRUTH'S SINGLE ARM CASEMENT OPERATORS - FRONT MOUNT

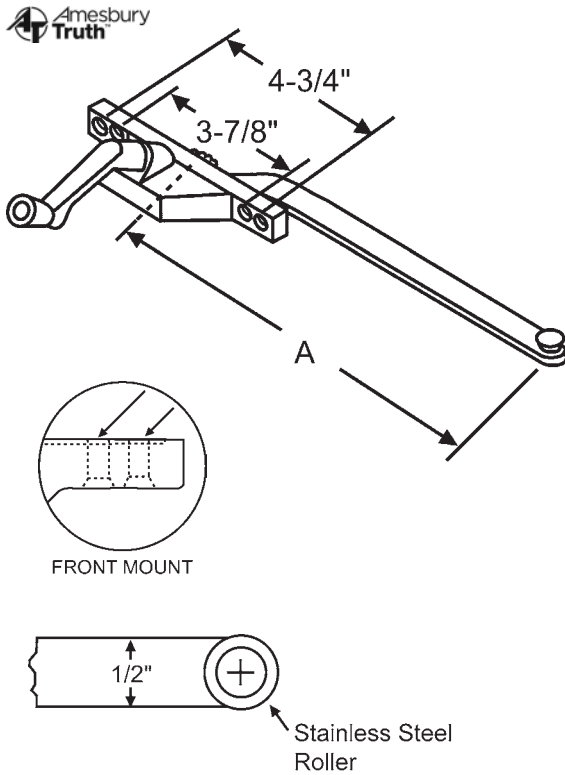

Part #	Hand	Arm Length ("A")	Finish	Roller
36-323-8	Shown	7-1/2"	Chestnut Bronze	Stainless Steel
36-324-8	Opposite	7-1/2"	Chestnut Bronze	Stainless Steel
36-323-10	Shown	7-1/2"	Black	Stainless Steel
36-324-10	Opposite	7-1/2"	Black	Stainless Steel
36-433-1	Shown	9-1/2"	Bronze	Stainless Steel
36-434-1	Opposite	9-1/2"	Bronze	Stainless Steel
36-433-3	Shown	9-1/2"	White	Stainless Steel
36-434-3	Opposite	9-1/2"	White	Stainless Steel
36-433-8	Shown	9-1/2"	Chestnut Bronze	Stainless Steel
36-434-8	Opposite	9-1/2"	Chestnut Bronze	Stainless Steel
36-433-10	Shown	9-1/2"	Black	Stainless Steel
36-434-10	Opposite	9-1/2"	Black	Stainless Steel
36-431-1	Shown	13-1/2"	Bronze	Stainless Steel
36-432-1	Opposite	13-1/2"	Bronze	Stainless Steel
36-431-8	Shown	13-1/2"	Chestnut Bronze	Stainless Steel
36-432-8	Opposite	13-1/2"	Chestnut Bronze	Stainless Steel
36-431-10	Shown	13-1/2"	Black	Stainless Steel
36-432-10	Opposite	13-1/2"	Black	Stainless Steel

Handle sold separately. See Pages 253 - 257

TRUTH'S SINGLE ARM CASEMENT OPERATORS - REAR MOUNT

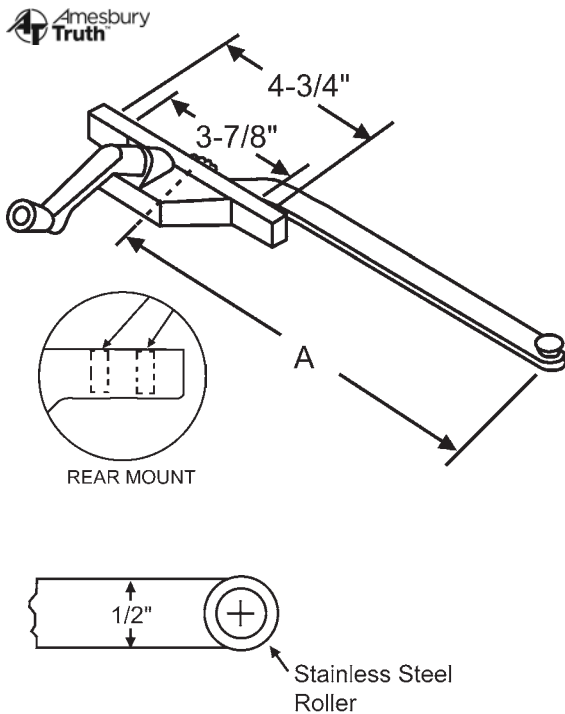

Part #	Hand	Arm Length ("A")	Finish	Roller
36-338-9	Shown	7-1/2"	Beige	Stainless Steel
36-339-9	Opposite	7-1/2"	Beige	Stainless Steel
36-338-10	Shown	7-1/2"	Black	Stainless Steel
36-339-10	Opposite	7-1/2"	Black	Stainless Steel
36-444-3	Shown	9-1/2"	White	Stainless Steel
36-445-3	Opposite	9-1/2"	White	Stainless Steel
36-444-8	Shown	9-1/2"	Chestnut Bronze	Stainless Steel
36-445-8	Opposite	9-1/2"	Chestnut Bronze	Stainless Steel
36-444-13	Shown	9-1/2"	Brush Copper Nickel	Stainless Steel
36-445-13	Opposite	9-1/2"	Brush Copper Nickel	Stainless Steel
36-439-1	Shown	13-1/2"	Bronze	Stainless Steel
36-440-1	Opposite	13-1/2"	Bronze	Stainless Steel
36-439-3	Shown	13-1/2"	White	Stainless Steel
36-440-3	Opposite	13-1/2"	White	Stainless Steel
36-439-7	Shown	13-1/2"	Aluminum	Stainless Steel
36-440-7	Opposite	13-1/2"	Aluminum	Stainless Steel
36-439-8	Shown	13-1/2"	Chestnut Bronze	Stainless Steel
36-440-8	Opposite	13-1/2"	Chestnut Bronze	Stainless Steel
36-439-10	Shown	13-1/2"	Black	Stainless Steel
36-440-10	Opposite	13-1/2"	Black	Stainless Steel
36-439-13	Shown	13-1/2"	Brush Copper Nickel	Stainless Steel
36-440-13	Opposite	13-1/2"	Brush Copper Nickel	Stainless Steel

Handle sold separately. See Pages 253 - 257

WINDOW REPLACEMENT HARDWARE

FACE MOUNTED CASEMENT OPERATORS

TRUTH'S SINGLE ARM CASEMENT OPERATORS - FRONT & REAR MOUNT

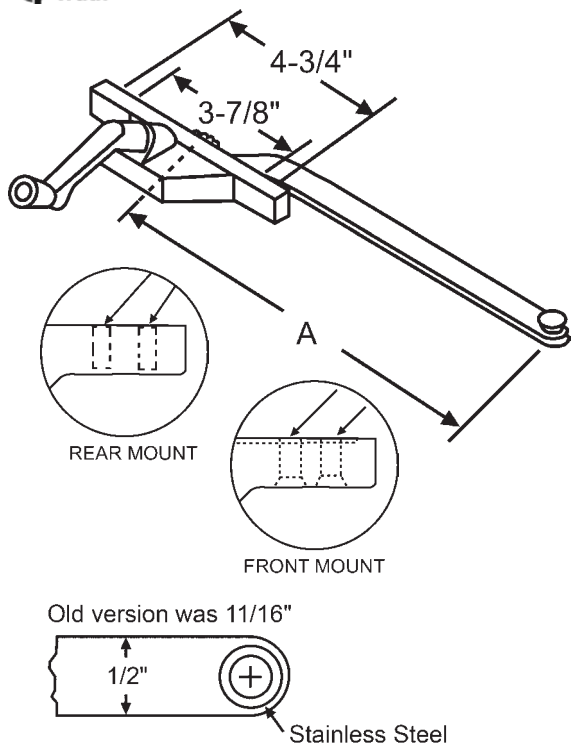

Part #	Hand	Mounting	Arm Length ("A")	Finish
36-230-8	Shown	Front	6"	Chestnut Bronze
36-231-8	Opposite	Front	6"	Chestnut Bronze
36-220-3	Shown	Front	9"	White
36-221-3	Opposite	Front	9"	White
36-220-7	Shown	Front	9"	Aluminum
36-221-7	Opposite	Front	9"	Aluminum
36-220-8	Shown	Front	9"	Chestnut Bronze
36-221-8	Opposite	Front	9"	Chestnut Bronze
36-222-1	Shown	Front	11"	Bronze
36-223-1	Opposite	Front	11"	Bronze
36-222-3	Shown	Front	11"	White
36-223-3	Opposite	Front	11"	White
36-222-6	Shown	Front	11"	Clay
36-223-6	Opposite	Front	11"	Clay
36-222-7	Shown	Front	11"	Aluminum
36-223-7	Opposite	Front	11"	Aluminum
36-222-8	Shown	Front	11"	Chestnut Bronze
36-223-8	Opposite	Front	11"	Chestnut Bronze
36-223-10	Opposite	Front	11"	Black
36-224-3	Shown	Rear	9"	White
36-225-3	Opposite	Rear	9"	White
36-224-13	Shown	Rear	9"	Brushed Copper Nickel
36-225-13	Opposite	Rear	9"	Brushed Copper Nickel
36-226-3	Shown	Rear	11"	White
36-227-3	Opposite	Rear	11"	White
36-226-8	Shown	Rear	11"	Chestnut Bronze
36-227-8	Opposite	Rear	11"	Chestnut Bronze
36-226-10	Shown	Rear	11"	Black
36-227-10	Opposite	Rear	11"	Black

Handle sold separately. See Pages 253 - 257

TRUTH'S REAR MOUNT DYAD CASEMENT OPERATORS

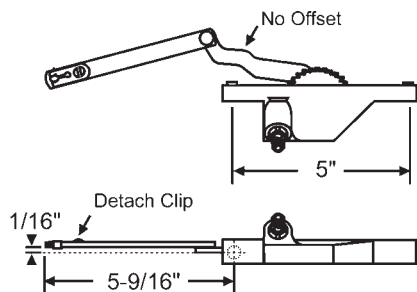

Part #	Hand	Finish
36-240-3	Shown	White
36-241-3	Opposite	White
36-241-6	Opposite	Clay
36-240-10	Shown	Black
36-241-10	Opposite	Black

Handle sold separately. See Pages 253 - 257
Note: Detached clips can be reversed in the field.

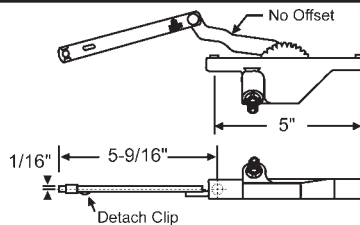

Part #	Hand	Finish
36-244-1	Shown	Bronze
36-245-1	Opposite	Bronze
36-244-3	Shown	White
36-245-3	Opposite	White
36-244-8	Shown	Chestnut Bronze
36-245-8	Opposite	Chestnut Bronze
36-244-8NEG	Shown	Chestnut Bronze (Non E-Gard)
36-245-8NEG	Opposite	Chestnut Bronze (Non E-Gard)
36-244-14	Shown	Cocoa Brown
36-245-14	Opposite	Cocoa Brown
36-244-14NEG	Shown	Cocoa Brown (Non E-Gard)
36-245-14NEG	Opposite	Cocoa Brown (Non E-Gard)
36-244-29	Shown	Bright White
36-245-29	Opposite	Bright White
36-244-29NEG	Shown	Bright White (Non E-Gard)
36-245-29NEG	Opposite	Bright White (Non E-Gard)

Handle sold separately. See Pages 253 - 257
Note: Detached clips can be reversed in the field.

WINDOW REPLACEMENT HARDWARE

FACE MOUNTED CASEMENT OPERATORS

TRUTH'S REAR MOUNT DYAD CASEMENT OPERATORS

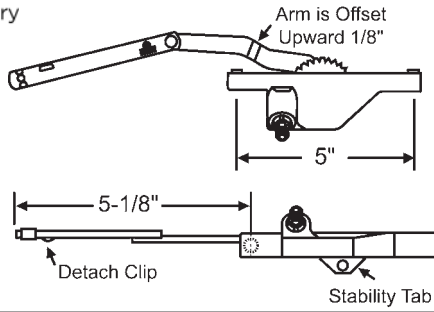

Part #	Hand	Finish
36-280-1	Shown	Bronze
36-281-1	Opposite	Bronze
36-280-9	Shown	Beige
36-281-9	Opposite	Beige
36-280-29	Shown	Bright White
36-281-29	Opposite	Bright White

Handle sold separately. See Pages 253 - 257
Note: Detached clips can be reversed in the field.

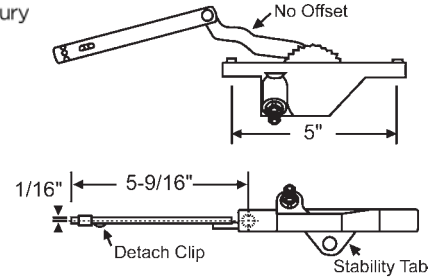

Part #	Hand	Finish
36-264-3	Shown	White
36-265-3	Opposite	White
36-264-9	Shown	Beige
36-265-9	Opposite	Beige
36-264-9CG	Shown	Coast-Gard
36-265-9CG	Opposite	Coast-Gard
36-264-29	Shown	Bright White
36-265-29	Opposite	Bright White

Handle sold separately. See Pages 253 - 257
Note: Detached clips can be reversed in the field.

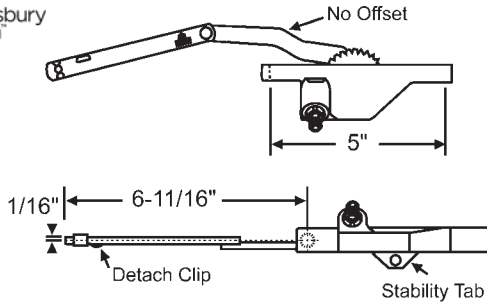

Part #	Hand	Finish
36-274-3	Shown	White
36-275-3	Opposite	White
36-274-6NEG	Shown	Clay
36-275-6NEG	Opposite	Clay
36-274-9	Shown	Beige
36-275-9	Opposite	Beige

Handle sold separately. See Pages 253 - 257
Note: Detached clips can be reversed in the field.

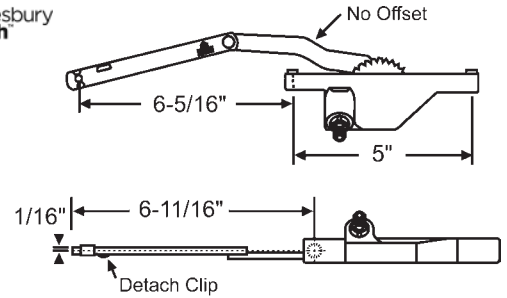

Part #	Hand	Finish
36-254-3	Shown	White
36-255-3	Opposite	White
36-254-6	Shown	Clay
36-255-6	Opposite	Clay
36-254-1	Shown	Bronze
36-255-1	Opposite	Bronze

Handle sold separately. See Pages 253 - 257
Note: Detached clips can be reversed in the field.

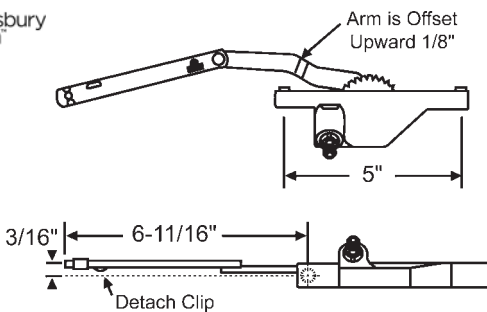

Part #	Hand	Finish
36-256-8	Shown	Chestnut Bronze
36-257-8	Opposite	Chestnut Bronze
36-256-4	Shown	Coppertone
36-257-4	Opposite	Coppertone

Handle sold separately. See Pages 253 - 257
Note: Detached clips can be reversed in the field.

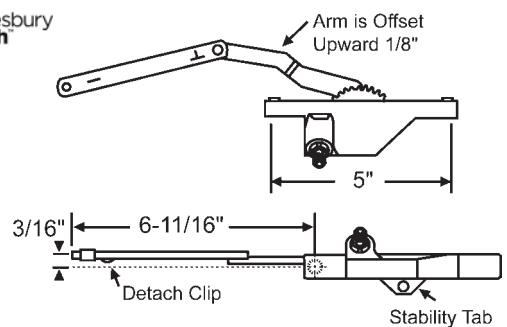

Part #	Hand	Finish
36-276-3	Shown	White
36-277-3	Opposite	White

Handle sold separately. See Pages 253 - 257
Note: Detached clips can be reversed in the field.

WINDOW REPLACEMENT HARDWARE

FACE MOUNTED CASEMENT OPERATORS

TRUTH'S REAR MOUNT DYAD CASEMENT OPERATORS

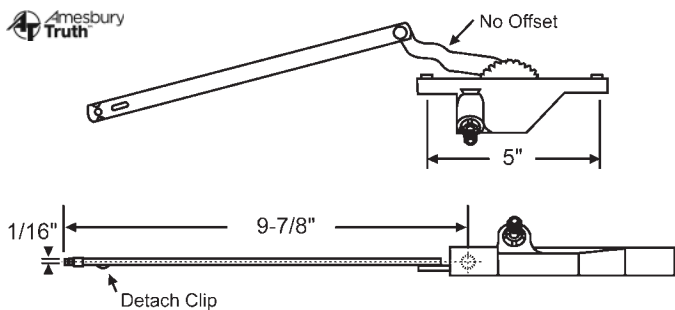

Part #	Hand	Finish
36-248-1	Shown	Bronze
36-249-1	Opposite	Bronze
36-248-3	Shown	White
36-249-3	Opposite	White

Handle sold separately. See Pages 253 - 257

Note: Detached clips can be reversed in the field.

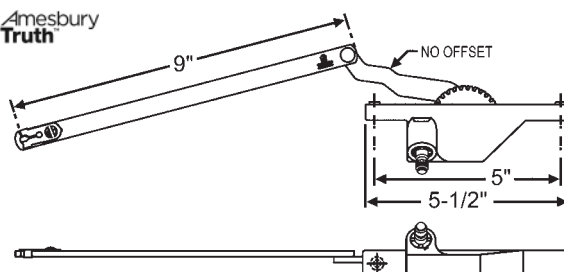

Part #	Hand	Finish
36-238-10	Shown	Black
36-239-10	Opposite	Black
36-238-3	Shown	White
36-239-3	Opposite	White
36-238-8	Shown	Chestnut Bronze
36-239-8	Opposite	Chestnut Bronze
36-238-6	Shown	Clay
36-239-6	Opposite	Clay

Handle sold separately. See Pages 253 - 257

Note: Detached clips can be reversed in the field.

FACE MOUNTED CASEMENT OPERATORS

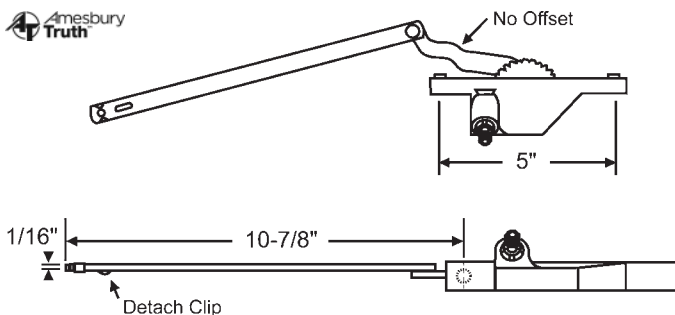

Part #	Hand	Finish
36-252-1	Shown	Bronze
36-253-1	Opposite	Bronze
36-252-3NEG	Shown	White
36-253-3NEG	Opposite	White

Handle sold separately. See Pages 253 - 257

Note: Detached clips can be reversed in the field.

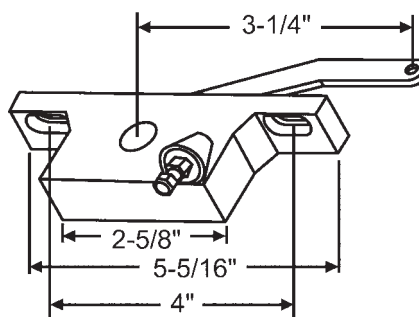

No Longer Available

Handle Sold Separately. See 37-159 or 37-159W on Page 254.

Some Covers are Available. See Page 252-253

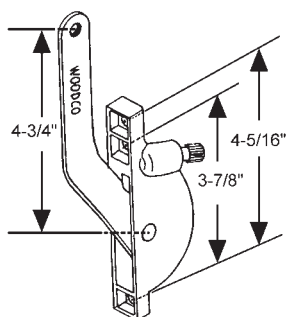

Part #	Description	Finish
900-14122	Flat Arm (shown)	Aluminum

Handle Included
WOODCO

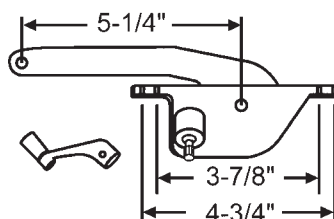

Part #	Hand	Finish	"T" Handles	Handle Only
36-138	Shown	Bronze	37-106BR	37-111
36-139	Opposite	Bronze	37-106BR	37-111
36-140	Shown	Aluminum	37-106	37-112
36-141	Opposite	Aluminum	37-106	37-112

Handle Included. Hand knobs use 5/16" size only.

WINDOW REPLACEMENT HARDWARE

FACE MOUNTED CASEMENT OPERATORS

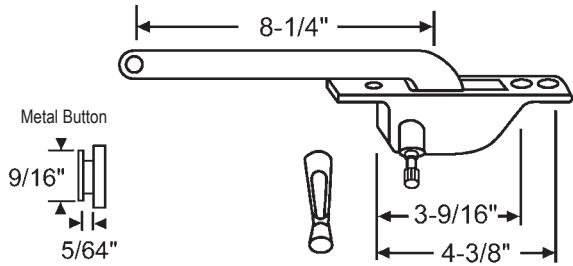

Part #	Hand	Finish	"T" Handles	Handle Only
36-134	Shown	Brown	37-106BR	37-111
36-135	Opposite	Brown	37-106BR	37-111

Die Cast - Handle Included
THORN/DORCHESTER

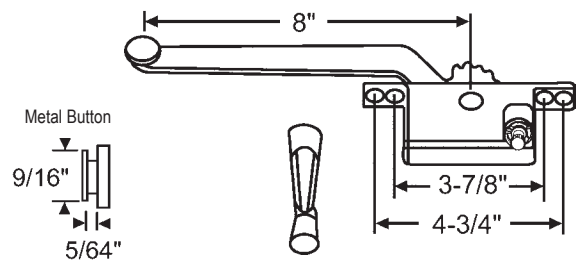

Part #	Hand	Finish	"T" Handles	Handle Only
36-110	Shown	Aluminum	37-113	37-100
36-104	Opposite	Aluminum	37-113	37-100
36-111	Shown	Brown	37-113B	37-101
36-109	Opposite	Brown	37-113B	37-101

Handle Included

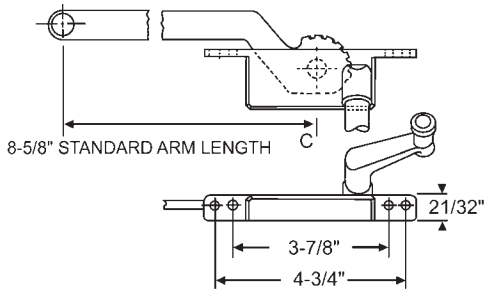

Part #	Hand	Finish
36-143	Opposite	Light Bronze
36-142	Shown	Light Bronze
36-143AL	Opposite	Aluminum
36-142AL	Shown	Aluminum

Handle Included.
DORCHESTER

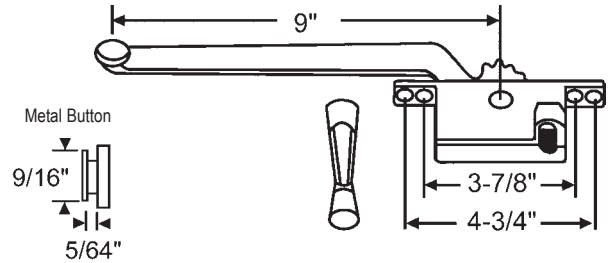

Part #	Hand	Finish	"T" Handles	Handle Only
36-114	Shown	Aluminum	37-113	37-100
36-112	Opposite	Aluminum	37-113	37-100
36-114W	Shown	White	37-113W	37-100W
36-112W	Opposite	White	37-113W	37-100W
36-115	Shown	Brown	37-113B	37-101
36-113	Opposite	Brown	37-113B	37-101

Die Cast - Handle Included. Hand knobs use 3/8" size only.

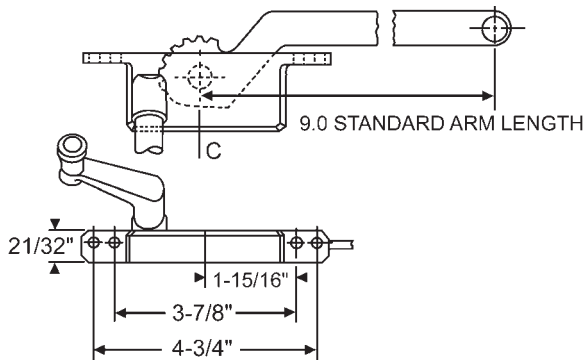

Part #	Hand	Finish	Package
36-143-9	Shown	Light Bronze	Bagged
36-142AL-9	Opposite	Aluminum	Bagged

Handle Included
DORCHESTER

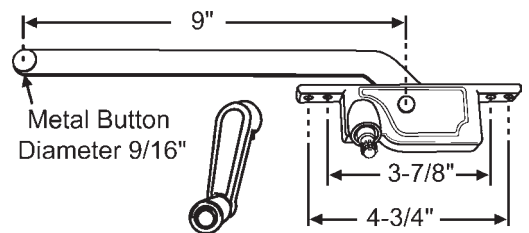

Part #	Hand	Finish
36-448	Shown	Aluminum
36-446	Opposite	Aluminum
36-449	Shown	WCM Bronze
36-447	Opposite	WCM Bronze

Handle Included

WINDOW REPLACEMENT HARDWARE

FACE MOUNTED CASEMENT OPERATORS

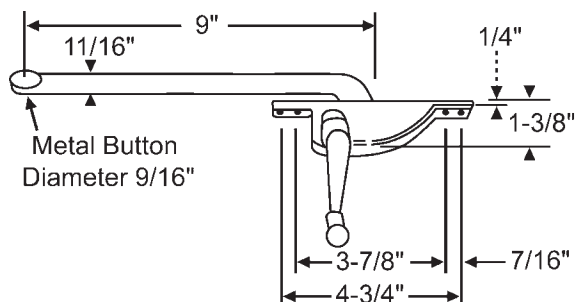

Part #	Hand	Finish
36-314	Shown	Aluminum
36-312	Opposite	Aluminum
36-313	Shown	Bronze
36-311	Opposite	Bronze

Handle Included

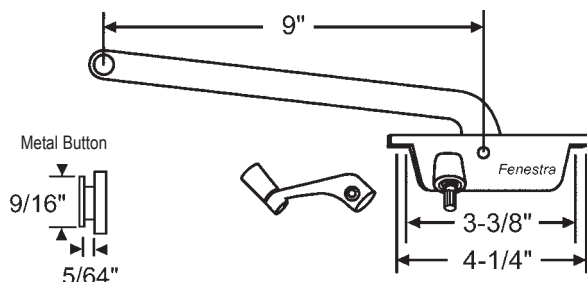

Part #	Hand	Finish
36-130	Shown	Aluminum
36-131	Opposite	Aluminum
36-130BZ	Shown	Bronze
36-131BZ	Opposite	Bronze

Handle Included

T-Handle Only: 37-106 (Aluminum); Additional Crank Handle: 37-112 (Aluminum)

FENESTRA

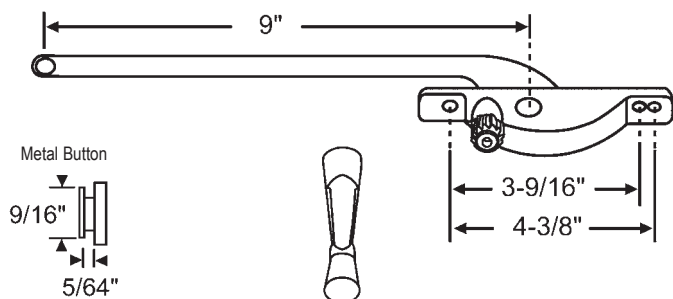

Part #	Hand	Finish	"T" Handles	Handle Only
36-102	Shown	Aluminum	37-106	37-112
36-100	Opposite	Aluminum	37-106	37-112
36-103	Shown	Brown	37-106BR	37-111
36-101	Opposite	Brown	37-106BR	37-111

Handle Included

THORN

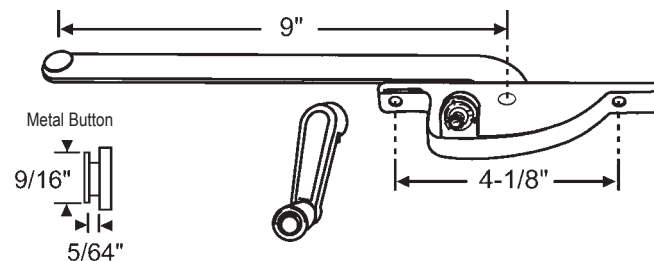

Part #	Hand	Finish	"T" Handles	Handle Only
36-118	Shown	Aluminum	37-106	37-112
36-116	Opposite	Aluminum	37-106	37-112
36-119B	Shown	Bronze	37-106BR	37-111
36-117B	Opposite	Bronze	37-106BR	37-111

Handle Included

HOPE'S

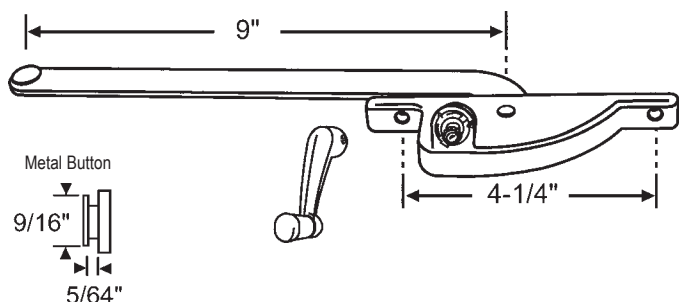

Part #	Hand	Finish	"T" Handles	Handle Only
36-107	Shown	Aluminum	37-106	37-112
36-105	Opposite	Aluminum	37-106	37-112
36-108	Shown	Brown	37-106BR	37-111
36-106	Opposite	Brown	37-106BR	37-111

Handle Included

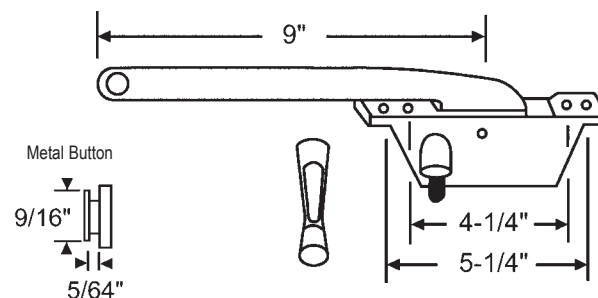

Part #	Hand	Finish	"T" Handles	Handle Only
36-136	Shown	Aluminum	37-106	37-112
36-137	Opposite	Aluminum	37-106	37-112
36-136BZ	Shown	Bronze	37-106BR	37-112DBZ
36-137BZ	Opposite	Bronze	37-106BR	37-112DBZ

Handle Included

Use with Casement Track 38-51.

FENESTRA

WINDOW REPLACEMENT HARDWARE

FACE MOUNTED CASEMENT OPERATORS

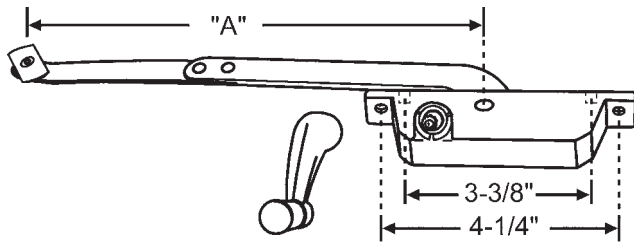

Part #	Hand	Finish	"A"
36-150-9	Shown	Aluminum	9"
36-151-9	Opposite	Aluminum	9"
36-150	Shown	Aluminum	13"
36-151	Opposite	Aluminum	13"

Handle Included. Hand knobs use 5/16" size only.

FENESTRA

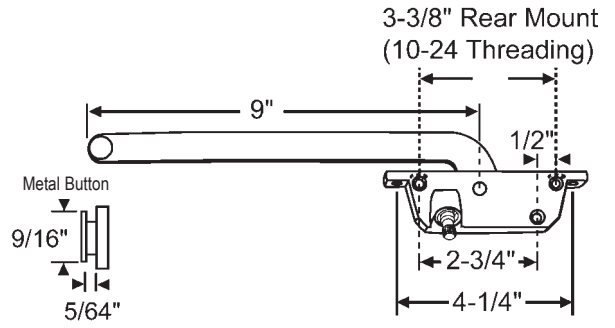

Part #	Hand	Finish
36-132	Shown	Brown
36-133	Opposite	Brown
36-132AL	Shown	Aluminum
36-133AL	Opposite	Aluminum

Die Cast - Handle Included

FENESTRA

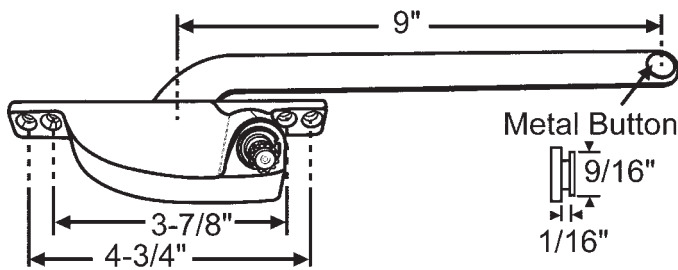

Part #	Hand	Finish
900-8889	Opposite	White Bronze
900-8890	Shown	White Bronze

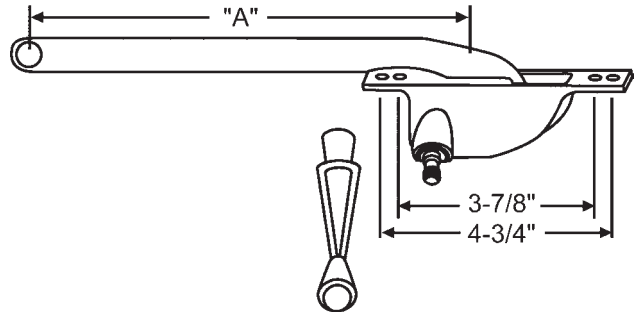

Part #	Hand	Finish	"A"
900-19855LH	Opposite	Aluminum	9"
900-19855RH	Shown	Aluminum	9"
900-13148LH	Opposite	Aluminum	11"
900-13148RH	Shown	Aluminum	11"

Intermediate Operator. Handle & Installation Screws #20-283 Included
Hope's 9003HD Replacement

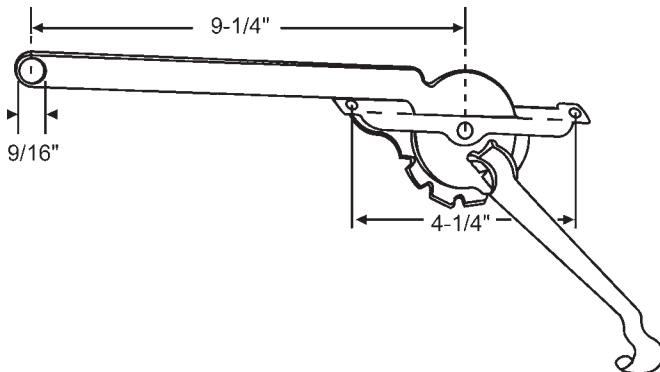

Part #	Hand	Finish	Handle Length
36-524RH-9SV	Shown	Silver	9"
36-524LH-9SV	Opposite	Silver	9"

Lever Operator

FENESTRA

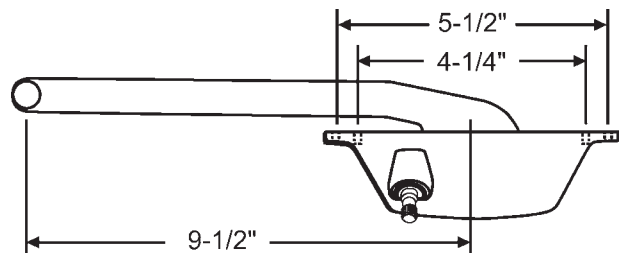

Part #	Hand	Finish
900-9653LH	Opposite	White Bronze
900-9653RH	Shown	White Bronze

Handle Included
Polished Lacquered Finish

WINDOW REPLACEMENT HARDWARE

GREENHOUSE OPERATOR

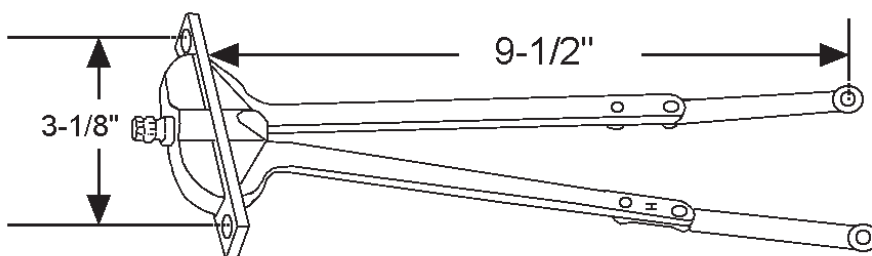

Part #	Finish
900-21266BK	Black

Handle Included
2 Hole Greenhouse Operator

SILL MOUNTED CASEMENT OPERATORS

TRUTH'S ENTRYGARD DUAL ARM OPERATORS

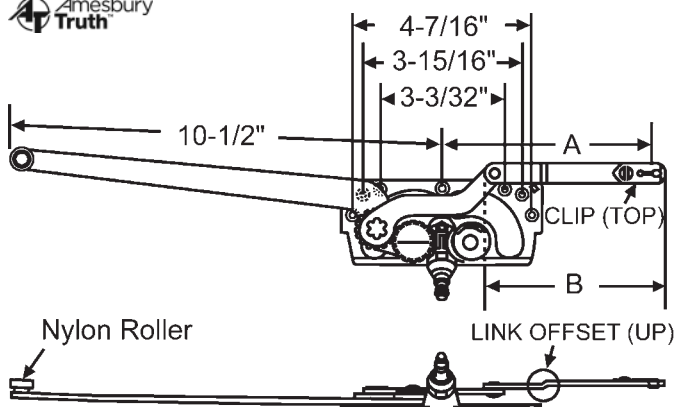

Part #	A	B	Hand	Link Offset	Clip	Finish
36-173	5-17/64"	4-7/16"	Shown	Up	Top	E-Gard
36-174	5-17/64"	4-7/16"	Opposite	Up	Top	E-Gard
36-181	5-17/64"	4-7/16"	Shown	Up	Top	Stainless Steel
36-182	5-17/64"	4-7/16"	Opposite	Up	Top	Stainless Steel
36-192	5-17/64"	4-7/16"	Shown	Down	Top	E-Gard
36-191	5-17/64"	4-7/16"	Opposite	Down	Top	E-Gard
36-335	5-17/64"	4-7/16"	Shown	Down	Bottom	E-Gard
36-336	5-17/64"	4-7/16"	Opposite	Down	Bottom	E-Gard
36-183	2-59/64"	2-7/8"	Shown	Up	Top	E-Gard
36-184	2-59/64"	2-7/8"	Opposite	Up	Top	E-Gard
36-186	4-5/8"	3-3/4"	Shown	Up	Top	E-Gard
36-185	4-5/8"	3-3/4"	Opposite	Up	Top	E-Gard

Handle and cover sold separately. See Pages 252 - 257

Note: Detached clips can be reversed in the field.

TRUTH'S ENTRYGARD DYAD ARM OPERATORS

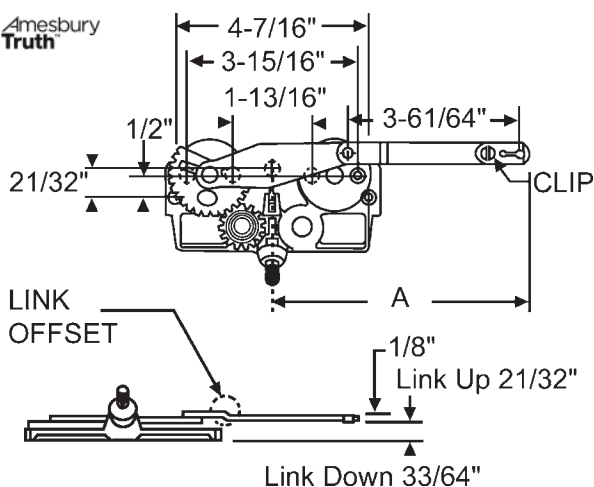

Part #	Hand	Link Offset	Clip	A	Arm
36-177	Shown	Down	Top	6"	Bent
36-178	Opposite	Down	Top	6"	Bent
36-177MOD	Shown	Down	Top	8-1/2"	Straight
36-178MOD	Opposite	Down	Top	8-1/2"	Straight
36-193	Shown	Up	Top	6"	Bent
36-194	Opposite	Up	Top	6"	Bent
36-199	Opposite	Down	Bottom	6"	Bent
36-199CG	Opposite	Down	Bottom	6"	Bent
36-200	Shown	Down	Bottom	6"	Bent
36-200CG	Shown	Down	Bottom	6"	Bent

Handle and cover sold separately. See Pages 252 - 257

Note: Detached clips can be reversed in the field.

WINDOW REPLACEMENT HARDWARE

SILL MOUNTED CASEMENT OPERATORS

TRUTH'S ENTRYGARD SINGLE ARM OPERATORS

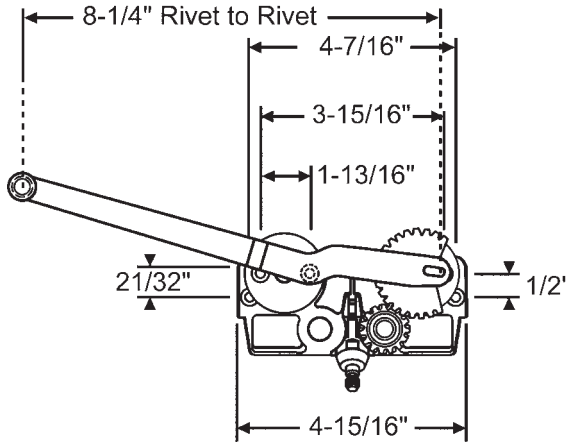

Part #	Hand
36-290LH	Shown
36-290RH	Opposite

Handle and cover sold separately. See Pages 252 - 257

TRUTH'S ENTRYGARD FOLDING HANDLE CONVERSION KIT

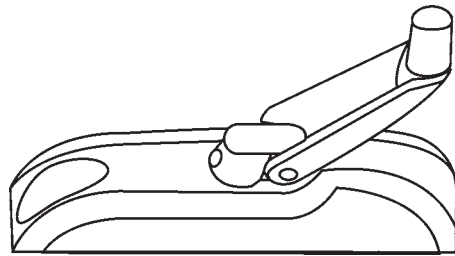

Gives a Home a New Look!

Converts crank handle to a folding handle. Just remove handle and cover, and install over operator.

Part #	Finish
37-220-1	Bronze
37-220-3	White

Folding Handle System. Non-Hand. Fits all Entrygard products. Other finishes available

Before tightening set screw, close window and lock sash. Remove handle and reposition as shown.

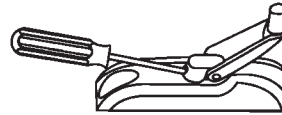

Tighten Set Screw

SILL MOUNTED CASEMENT OPERATORS

NOTE: Truth Hardware has Discontinued their 15 Series "Traditional Case" Style Operators. They will be replaced by the **Ellipse Case** which is a more Contour and Contemporary Design. They are a Direct Replacement, only difference is the case design.

Presently, we still have inventory on some of the Traditional Case Design; but once Our Stock has been depleted you will need to begin ordering the replacement Ellipse Case Design.

We have laid out Our Catalog pages showing both designs side by side to make this transition a little easier for your ordering.

SINGLE ARM OPERATORS

TRUTH'S TRADITIONAL STYLE CASE

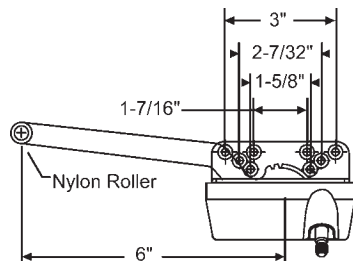

Part #	Hand	Finish
36-213-1S	Shown	Bronze
36-211-3S	Opposite	White
36-213-6	Shown	Clay
36-211-6	Opposite	Clay

Handle sold separately. See Pages 253 - 257

TRUTH'S ELLIPSE STYLE CASE

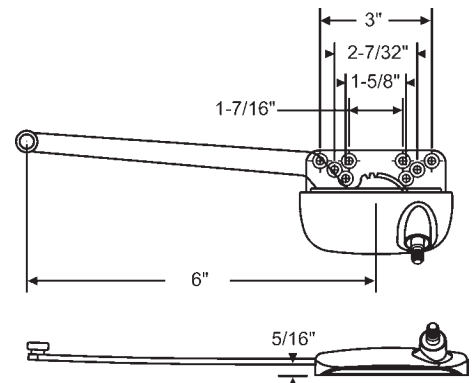

Part #	Hand	Finish
36-213-3E	Shown	White
36-211-3E	Opposite	White
36-213-1E	Shown	Bronze
36-211-1E	Opposite	Bronze

Handle sold separately. See Pages 253 - 257

WINDOW REPLACEMENT HARDWARE

SILL MOUNTED CASEMENT OPERATORS

SINGLE ARM OPERATORS

TRUTH'S TRADITIONAL STYLE CASE

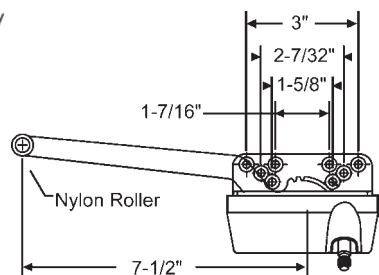

Part #	Hand	Finish
36-216-1S	Shown	Bronze
36-216-2S	Shown	Gold
36-215-2S	Opposite	Gold
36-216-3S	Shown	White
36-215-3S	Opposite	White

Handle sold separately. See Pages 253 - 257

TRUTH'S ELLIPSE STYLE CASE

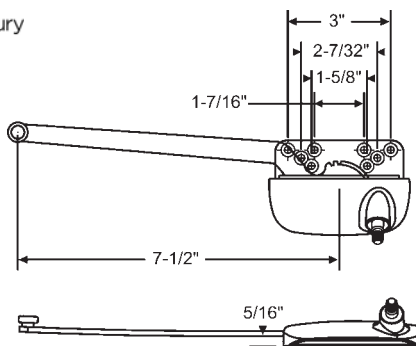

Part #	Hand	Finish
36-216-3E	Shown	White
36-215-3E	Opposite	White
36-216-1E	Shown	Bronze
36-215-1E	Opposite	Bronze

Handle sold separately. See Pages 253 - 257

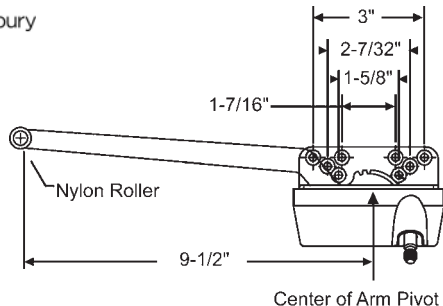

Part #	Hand	Finish
36-128-1S	Shown	Bronze
36-129-2S	Opposite	Gold
36-129-3S	Opposite	White
36-129-3SSS	Opposite	White Stainless Steel

Handle sold separately. See Pages 253 - 257

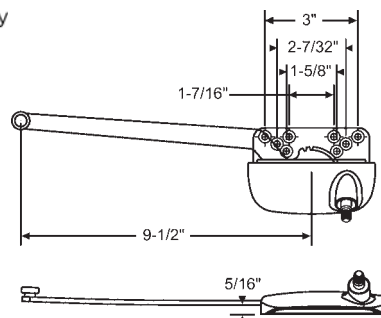

Part #	Hand	Finish
36-128-3E	Shown	White
36-129-3E	Opposite	White
36-128-1E	Shown	Bronze
36-129-1E	Opposite	Bronze
36-128-87E	Shown	Gold
36-129-87E	Opposite	Gold

Handle sold separately. See Pages 253 - 257

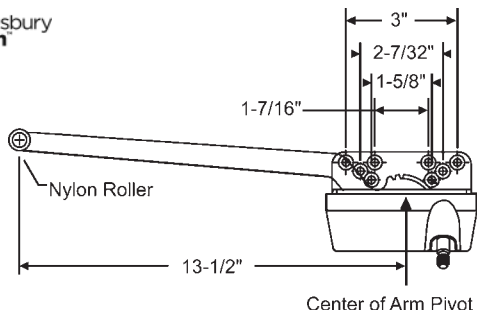

This operator is no longer available.
Use Ellipse Style

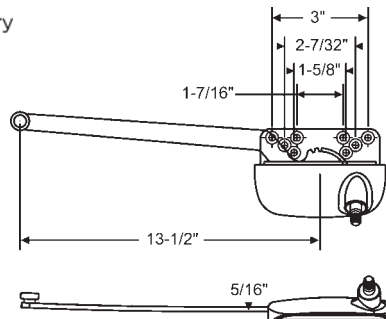

Part #	Hand	Finish
36-152-3E	Shown	White
36-154-3E	Opposite	White
36-152-1E	Shown	Bronze
36-154-1E	Opposite	Bronze
36-152-87E	Shown	Gold
36-154-87E	Opposite	Gold

Handle sold separately. See Pages 253 - 257

WINDOW REPLACEMENT HARDWARE

SILL MOUNTED CASEMENT OPERATORS

SPLIT ARM OPERATORS

TRUTH'S TRADITIONAL STYLE CASE

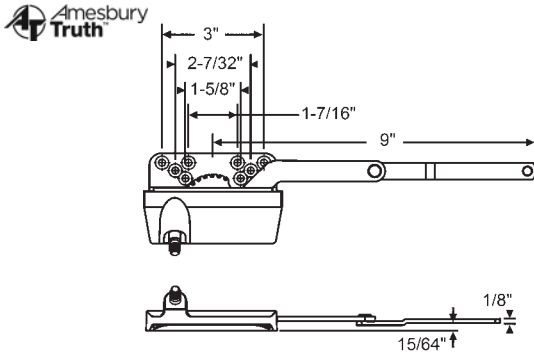

This operator is no longer available.
Use Ellipse Style

TRUTH'S ELLIPSE STYLE CASE

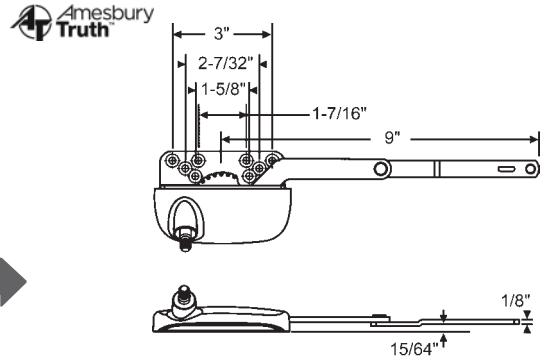

Part #	Hand	Finish
36-410-3E	Shown	White
36-411-3E	Opposite	White

Handle sold separately. See Pages 253 - 257

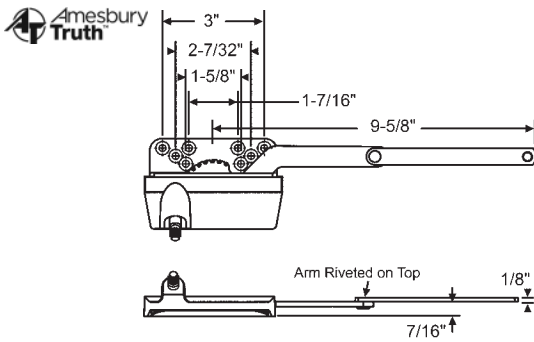

Part #	Hand	Finish
36-391-3S	Shown	White

Dyad Operator without Detach Clip

Uses: 39-21 and 39-22 stud brackets. Detach clip sold separately as 39-207.

Handle sold separately. See Pages 253 - 257

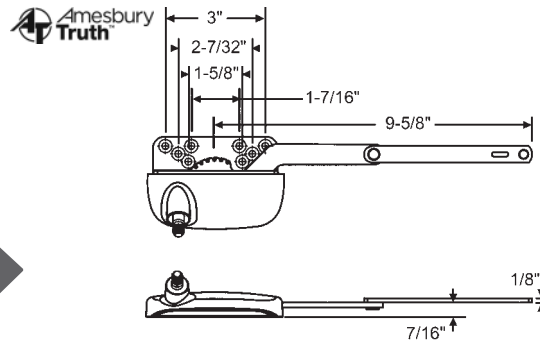

Part #	Hand	Finish
36-391-3E	Shown	White
36-390-3E	Opposite	White
36-391-87E	Shown	Gold (New)
36-390-87E	Opposite	Gold (New)
36-390-2E	Opposite	Gold

Handle sold separately. See Pages 253 - 257

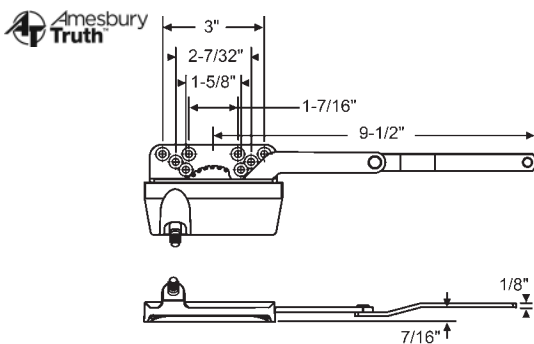

This operator is no longer available.
Use Ellipse Style

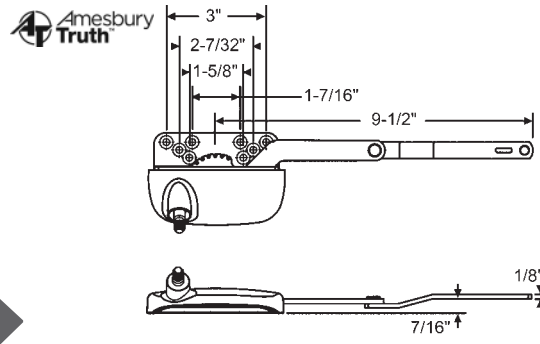

Part #	Hand	Finish
36-205-1E	Shown	Bronze
36-206-1E	Opposite	Bronze
36-205-3E	Shown	White
36-206-3E	Opposite	White
36-205-87E	Shown	Gold (New)
36-206-87E	Opposite	Gold (New)

Handle sold separately. See Pages 253 - 257

WINDOW REPLACEMENT HARDWARE

SILL MOUNTED CASEMENT OPERATORS

SINGLE ARM OPERATORS

TRUTH'S TRADITIONAL STYLE CASE

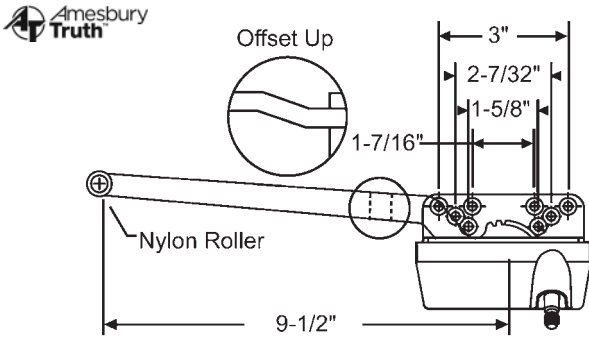

Part #	Hand	Finish
36-377-3S	Shown	White
36-378-3S	Opposite	White

Handle sold separately. See Pages 253 - 257

TRUTH'S ELLIPSE STYLE CASE

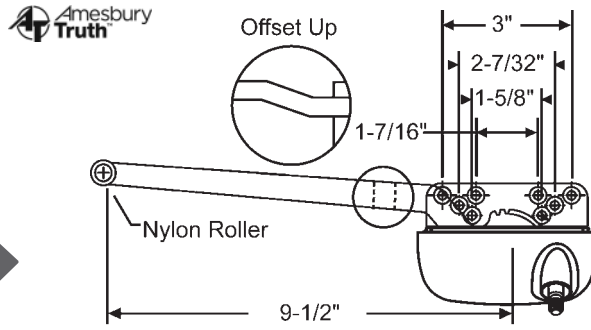

Part #	Hand	Finish
36-377-3E	Shown	White
36-378-3E	Opposite	White

Handle sold separately. See Pages 253 - 257

SPLIT ARM OPERATORS

TRUTH'S TRADITIONAL STYLE CASE

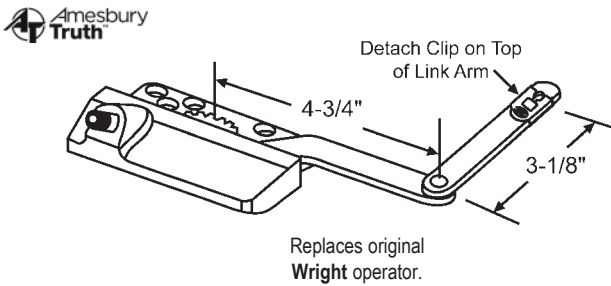

This operator is no longer available.
Use Ellipse Style

TRUTH'S ELLIPSE STYLE CASE

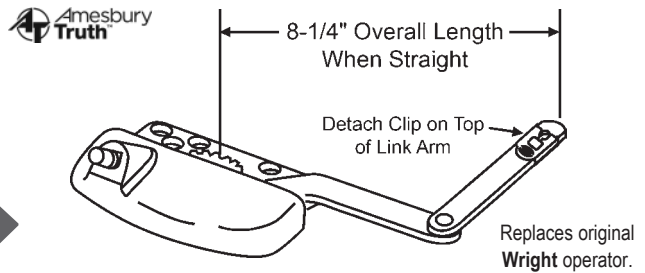

Part #	Hand	Finish
36-296-3E	Shown	White
36-295-3E	Opposite	White
36-296-87E	Shown	Gold (New)
36-295-87E	Opposite	Gold (New)

Split-Arm Operator

Handle sold separately. See Pages 253 - 257

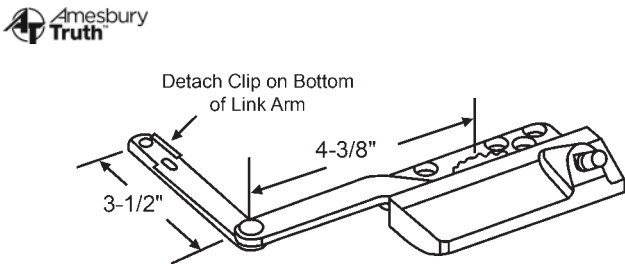

This operator is no longer available.
Use Ellipse Style

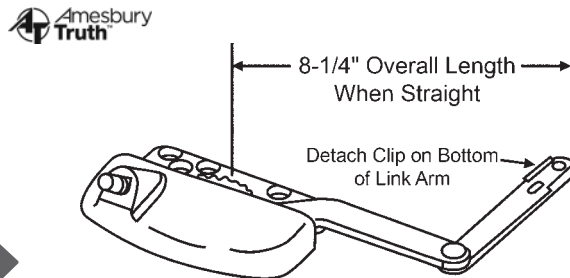

Part #	Hand	Finish
36-395-3E	Shown	White
36-396-3E	Opposite	White

Split Arm Operator

Handle sold separately. See Pages 253 - 257

WINDOW REPLACEMENT HARDWARE

SILL MOUNTED CASEMENT OPERATORS

SPLIT ARM OPERATOR

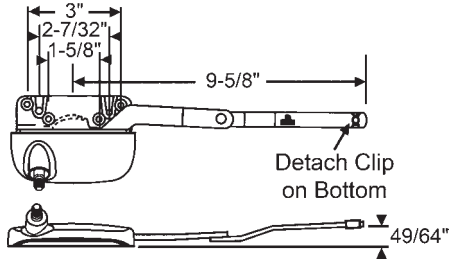

Part #	Hand	Finish
36-327-3E	Shown	White
36-328-3E	Opposite	White

Dyad Operator without Detach Clip

Note: Detached clips can be reversed in the field.

Handle sold separately. See Pages 253 - 257

TRUTH'S MAXIM® SERIES OPERATORS

The Maxim® Series is a window operating "system" where the hinges and operators are developed to work together to meet or exceed the "maximum" performance requirements of larger, more versatile casement and awning windows.

The Maxim® Series Dual Arm Operator is designed to operate sash sizes from 24" to 40" wide, 84" high and weighing up to 108 lbs.

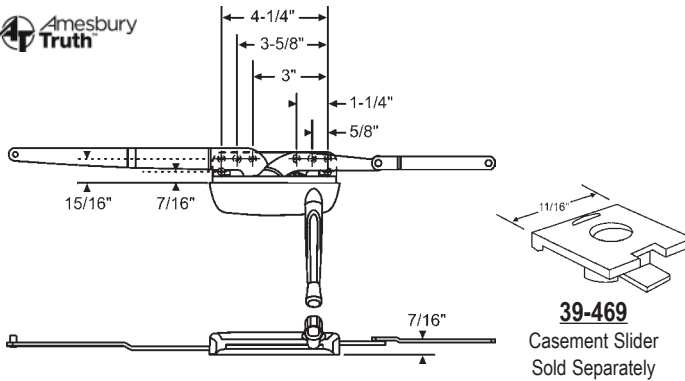

Part #	Hand	Finish	Handle Only
36-368-1	Shown	Bronze	37-150-1
36-369-1	Opposite	Bronze	37-150-1
36-368-3	Shown	White	37-150-3
36-369-3	Opposite	White	37-150-3
36-368-9	Shown	Beige	37-150-9
36-369-9	Opposite	Beige	37-150-9
36-368-14	Shown	Cocoa Brown	37-150-14
36-369-14	Opposite	Cocoa Brown	37-150-14
36-368-87	Shown	Gold (New)	37-150-87
36-369-87	Opposite	Gold (New)	37-150-87

Handle sold separately. See Pages 253 - 257

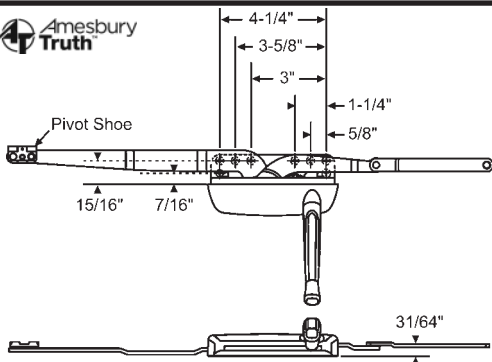

The Maxim® Series Dual Arm Low Profile Operator is designed to operate sash sizes up to 24" to 40" wide, 84" high and weighing up to 108 lbs.

Part #	Hand	Finish	Handle Only
36-464-3	Shown	White	37-150-3
36-465-3	Opposite	White	37-150-3
36-465-14	Opposite	Cocoa Brown	37-150-14

Handle sold separately. See Pages 253 - 257

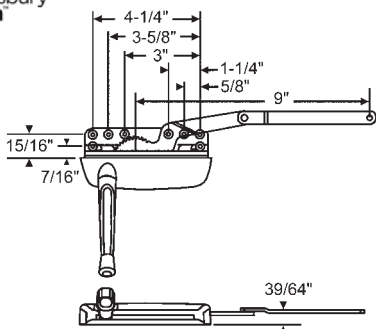

The Maxim® Series Dyad Operator is designed for narrow windows, but will operate a frame width from 16" to 32"; height up to 72" and a sash weight of up to 55 lbs.

Part #	Hand	Finish	Handle Only
36-371-1	Shown	Bronze	37-150-1
36-372-1	Opposite	Bronze	37-150-1
36-371-3	Shown	White	37-150-3
36-372-3	Opposite	White	37-150-3
36-371-9	Shown	Beige	37-150-9
36-372-9	Opposite	Beige	37-150-9
36-371-14	Shown	Cocoa Brown	37-150-14
36-372-14	Opposite	Cocoa Brown	37-150-14
36-371-29	Shown	Bright White	37-150-29
36-372-29	Opposite	Bright White	37-150-29

Handle sold separately. See Pages 253 - 257

WINDOW REPLACEMENT HARDWARE

SILL MOUNTED CASEMENT OPERATORS

TRUTH'S MAXIM® SERIES OPERATORS

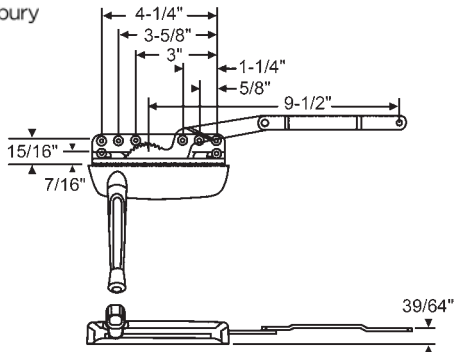

The Maxim® Series Reverse Dyad operators are designed for narrow windows, but will operate a frame width from 16" to 32"; height up to 72" and a sash weight up to 55 lbs.

Part #	Hand	Finish	Handle Only
36-373-1	Shown	Bronze	37-150-1
36-374-1	Opposite	Bronze	37-150-1
36-373-3	Shown	White	37-150-3
36-374-3	Opposite	White	37-150-3

Handle sold separately. See Pages 253 - 257

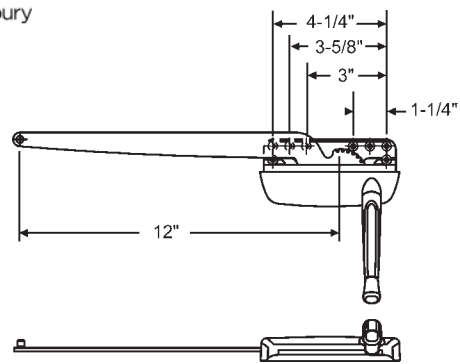

The Maxim® Series Single Arm operators are designed for casement windows that operate sash sizes from 20" to 32" wide, up to 72" high and weighing up to 73 lbs.

Part #	Hand	Finish
36-402-3	Shown	White
36-403-3	Opposite	White

Handle sold separately. See Pages 253 - 257

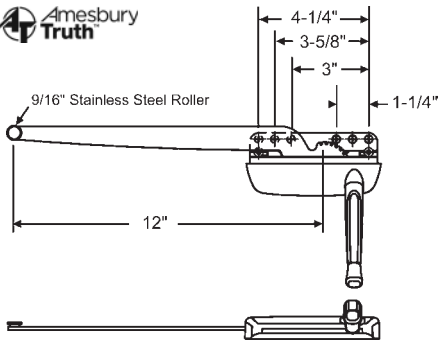

The Maxim® Series Single Arm low profile operators are designed for casement windows that operate sash sizes from 20" to 32" wide, up to 72" high and weighing up to 73 lbs.

Part #	Hand	Finish
36-428-3	Shown	White
36-429-3	Opposite	White
36-428-29	Shown	Bright White
36-429-29	Opposite	Bright White

Handle sold separately. See Pages 253 - 257

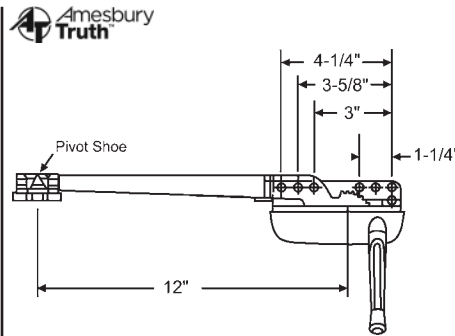

Part #	Hand	Finish
36-423-3	Shown	White
36-424-3	Opposite	White

Handle sold separately. See Pages 253 - 257

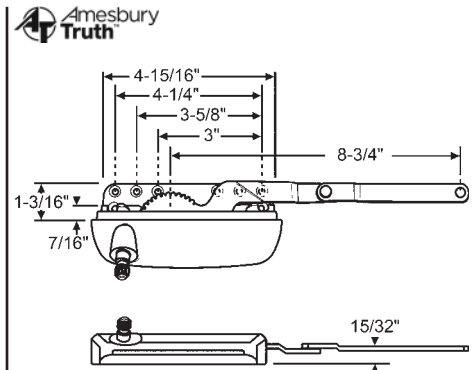

Part #	Hand	Finish
36-555-3	Shown	White
36-556-3	Opposite	White

Handle sold separately. See Pages 253 - 257

MAXIM® FOLDING HANDLE & COVER



Converts crank handle to folding handle. Just snap onto top of operator.

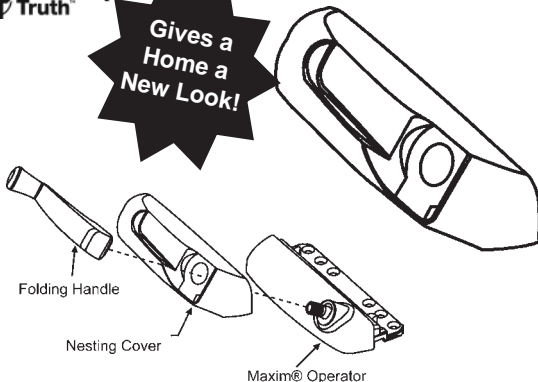

Part #	Hand	Finish
36-368NCV-1	Shown	Bronze
36-369NCV-1	Opposite	Bronze
36-368NCV-3	Shown	White
36-369NCV-3	Opposite	White

Plastic Nesting Cover for Maxim® Operators
Furnished with double sided tape pre-applied to cover for attaching cover to Maxim® Operator

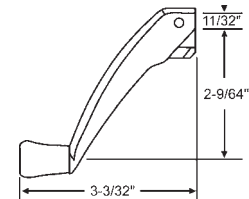

Part #	Finish
37-109FH-1	Bronze
37-109FH-3	White

Folding Handle (Must be ordered Separately)

WINDOW REPLACEMENT HARDWARE

SILL MOUNTED CASEMENT OPERATORS

TRUTH'S ENCORE™ SYSTEM OPERATORS

The Encore™ family of operators are engineered to incorporate all the strengths and performance characteristics as Truth's Maxim® Series

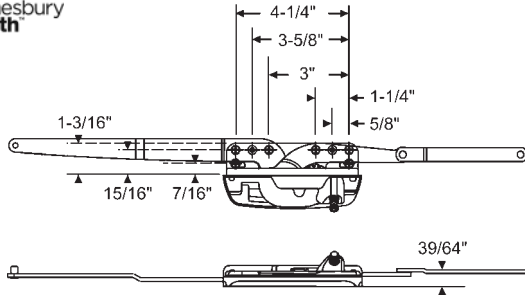

The Encore™ series dual arm operator is designed to operate sash sizes from 24" to 40" wide, up to 84" high and weighing up to 108 lbs.

Part #	Hand
36-368EN	Shown
36-369EN	Opposite

Handle and cover sold separately. See Pages 252- 257

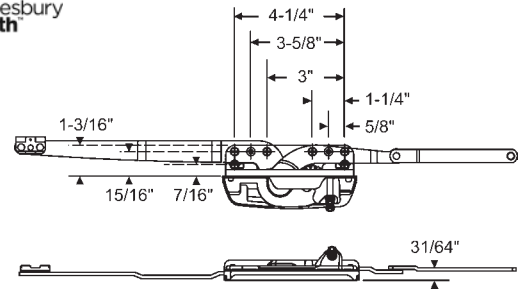

The Encore™ series dual arm low profile operator is designed to operate sash sizes from 24" to 40" wide, up to 84" high and weighing up to 108 lbs.

Part #	Hand
36-467EN	Shown
36-468EN	Opposite

Handle and cover sold separately. See Pages 252- 257

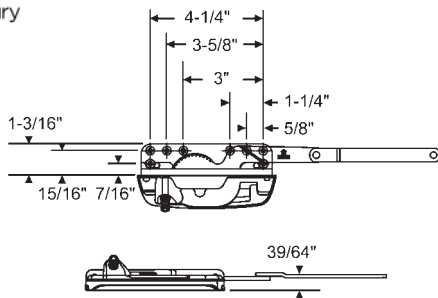

The Encore™ series Dyad operator is designed for narrow windows and will operate sash sizes from 16" to 32" wide, up to 72" high and weighing up to 55 lbs.

Part #	Hand
36-371EN	Shown
36-372EN	Opposite

Handle and cover sold separately. See Pages 252- 257

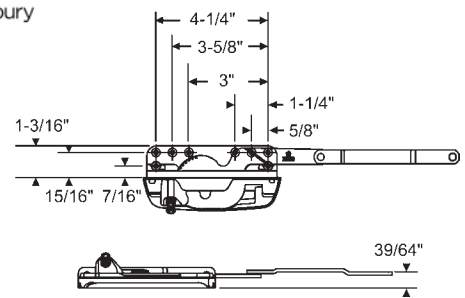

The Encore™ series reversed Dyad operator is designed for narrow windows and will operate sash sizes from 16" to 32" wide, up to 72" high and weighing up to 55 lbs.

Part #	Hand
36-470EN	Shown
36-471EN	Opposite

Handle and cover sold separately. See Pages 252- 257

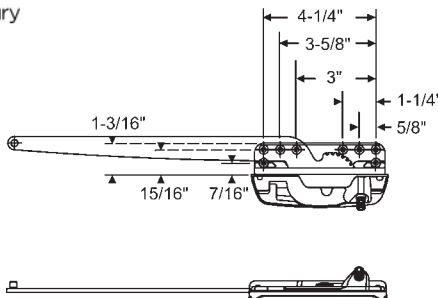

The Encore™ series single arm operators are designed for casement windows with sash sizes from 20" to 32" wide, up to 72" high and weighing up to 73 lbs.

Part #	Hand
36-402EN	Shown
36-403EN	Opposite

Handle and cover sold separately. See Pages 252- 257

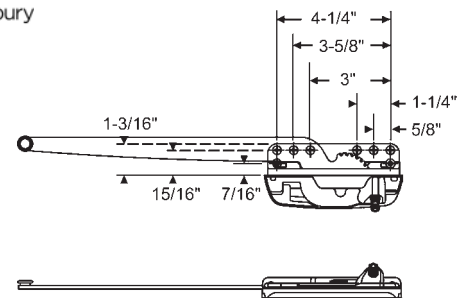

The Encore™ series single arm low profile operators are designed for casement windows with sash sizes from 20" to 32" wide, up to 72" high and weighing up to 73 lbs.

Part #	Hand
36-402ENLP	Shown
36-403ENLP	Opposite

Handle and cover sold separately. See Pages 252- 257

TRUTH'S ENCORE™ TANGO FOLDING HANDLE & COVER

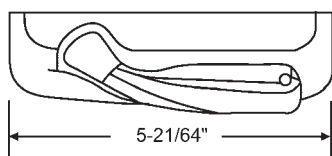

Part #	Hand	Finish
37-215-1	Shown	Bronze
37-216-1	Opposite	Bronze
37-215-3	Shown	White
37-216-3	Opposite	White
37-215-71	Shown	Oil Rubbed Bronze

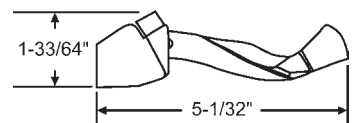

WINDOW REPLACEMENT HARDWARE

SILL MOUNTED CASEMENT OPERATORS

Sill Mounted Operators Sorted by Manufacturer

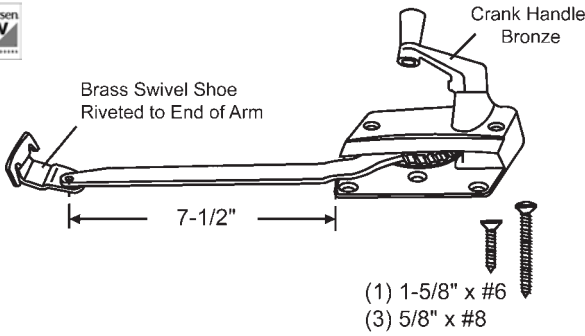

- (1) 1-5/8" x #6
- (3) 5/8" x #8

Part #	Hand	Finish
750-0536512	Shown	Bronze

Crank Handle Included

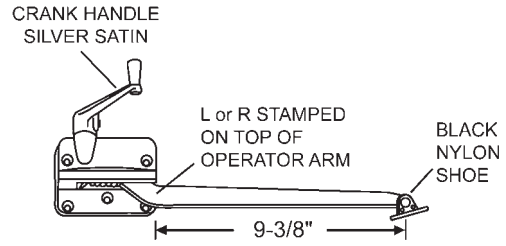

Part #	Hand	Finish	Handle Only
750-1360008	Shown	Silver Satin	750-1361008
750-1360012	Opposite	Silver Satin	750-1361008

Handle sold separately. See Pages 253 - 257
Only available in Silver Satin finish.

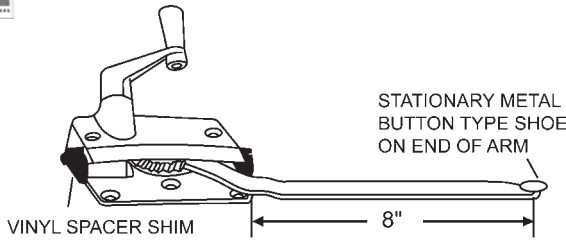

This operator is no longer available.
Replace with new style operator and new style track.

Part #	Hand	Finish	New Style Track
750-0531008	Shown	Bronze	750-0532108
750-0531012	Opposite	Bronze	750-0532108

Handle Included

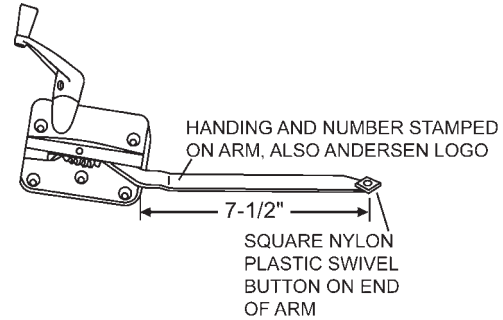

Part #	Hand	Finish
750-0531108	Shown	Bronze
750-0531112	Opposite	Bronze

Crank Handle Included

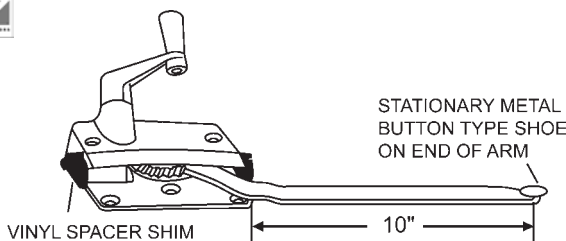

This operator is no longer available.
Replace with new style operator and new style track.

Part #	Hand	Finish	New Style Track
750-0566008	Shown	Bronze	750-0532108
750-0566012	Opposite	Bronze	750-0532108

Handle Included

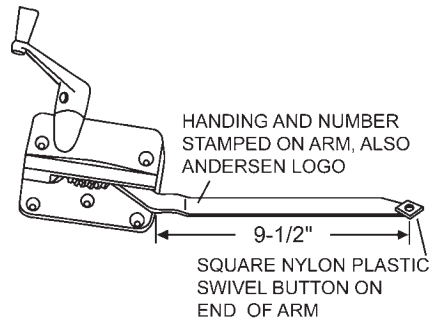

Part #	Hand	Finish
750-0566208	Shown	Bronze
750-0566212	Opposite	Bronze

Crank Handle Included

WINDOW REPLACEMENT HARDWARE

SILL MOUNTED CASEMENT OPERATORS

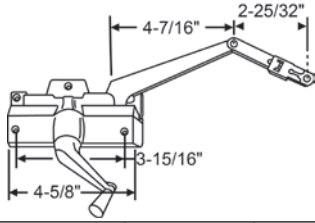

Part #	Hand	Finish	Handle Only
750-1361316	Shown	Stone	750-0532408
750-1361318	Opposite	Stone	750-0532408

Split Arm Operator

Handle sold separately. See Pages 253 - 257

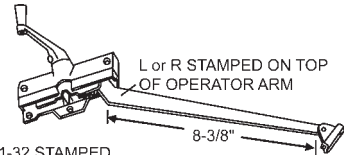

NO. 7191-32 STAMPED ON BOTTOM OF OPERATOR HOUSING

STONE NYLON SHOE WITH SLOT FOR CHANNEL. SHOE IS MOUNTED ON TOP OF OPERATOR ARM.

Part #	Hand	Finish	Handle Only
750-1361312	Shown	Stone	750-0532408
750-1361314	Opposite	Stone	750-0532408

Handle sold separately. See Pages 253 - 257

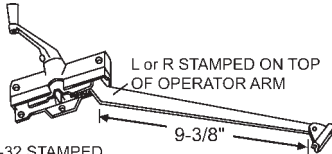

NO. 7191-32 STAMPED ON BOTTOM OF OPERATOR HOUSING

STONE NYLON SHOE WITH SLOT FOR CHANNEL. SHOE IS MOUNTED ON TOP OF OPERATOR ARM.

Part #	Hand	Finish	Handle Only
750-1361308C	Shown	Stone	750-0532408
750-1361310C	Opposite	Stone	750-0532408

Handle sold separately. See Pages 253 - 257

Operator assembly with cover, track and screws.

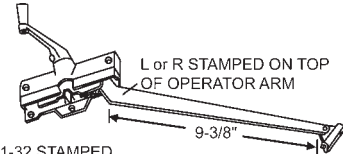

NO. 7191-32 STAMPED ON BOTTOM OF OPERATOR HOUSING

BLACK NYLON SHOE WITH SLOT FOR CHANNEL. SHOE IS MOUNTED UNDER OPERATOR ARM.

Part #	Hand	Finish	Handle Only
750-0565616	Shown	Stone	750-0532408
750-0565620	Opposite	Stone	750-0532408

Handle sold separately. See Pages 253 - 257

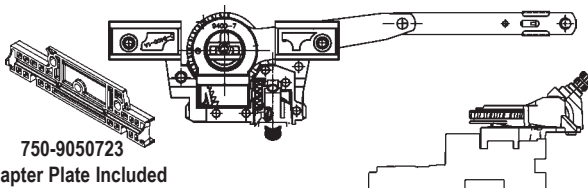

750-9050723
Adapter Plate Included

Perma-Shield Enhanced Casement Split Arm Operator. **Non-handed**

Operator Part #	Sash Bracket	Bracket Hand	Type
750-1361399	750-1361409	LH	Standard
750-1361399	750-1361408	RH	Standard
750-1361933	750-1361411	LH	Corrosion Resistant
750-1361933	750-1361410	RH	Corrosion Resistant

Handle and cover sold separately. See Pages 252- 257

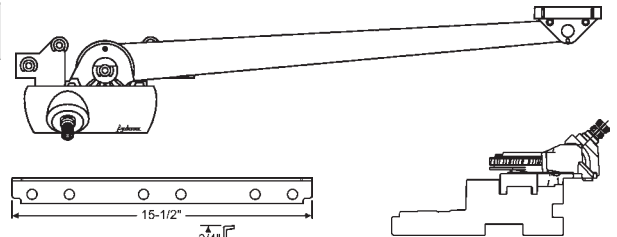

Part #	Hand	Track Only
750-9015119	Shown	750-9052563
750-9015120	Opposite	750-9052563

Perma-Shield Enhanced Casement Straight Arm Operator. Corrosion Resistant

Handle and cover sold separately. See Pages 252- 257

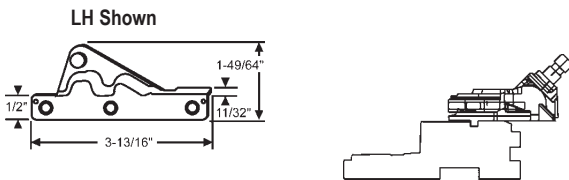

Perma-Shield Improved/E-Z Casement Split Arm Operator. **Non-handed**

Operator Part #	Sash Bracket	Bracket Hand	Type
750-1361484	750-1361409	LH	Standard
750-1361484	750-1361408	RH	Standard
750-1361481	750-1361411	LH	Corrosion Resistant
750-1361481	750-1361410	RH	Corrosion Resistant

Handle and cover sold separately. See Pages 252- 257

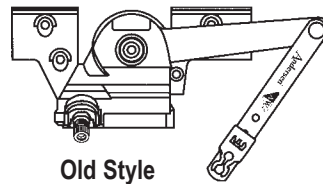

Old Style

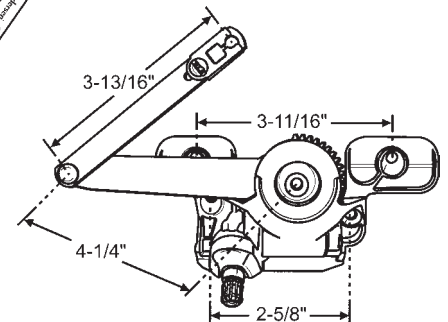

New Style

WINDOW REPLACEMENT HARDWARE

SILL MOUNTED CASEMENT OPERATORS

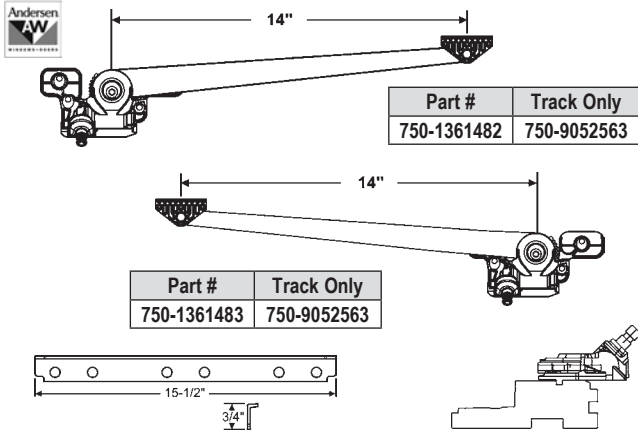

If Prior to 2001 you need to order a 750-9050723 adapter plate (sold separately)
Perma-Shield Improved/E-Z Casement Straight Arm Operator. Corrosion Resistant
Handle and cover sold separately. See Pages 252- 257

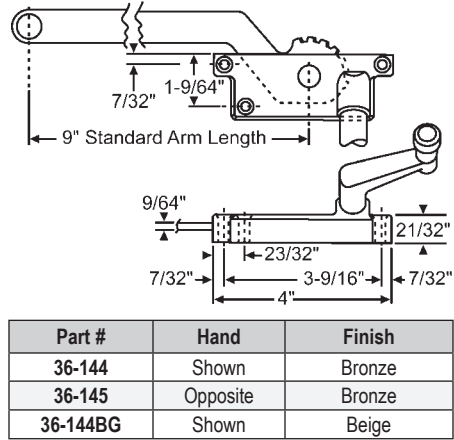

Part #	Hand	Finish
36-144	Shown	Bronze
36-145	Opposite	Bronze
36-144BG	Shown	Beige

Handle Included. Hand knobs use 5/16" size only.
Additional handle only use 900-7821.

DORCHESTER

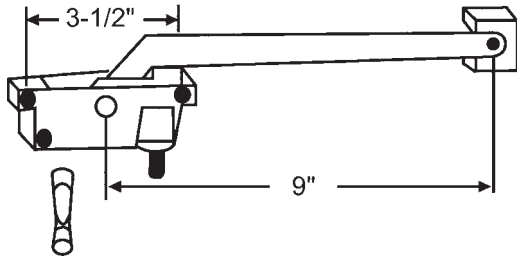

Part #	Hand	Finish
900-366LH	Shown	Bronze
900-366RH	Opposite	Bronze

Swing Lite Operator
Handle Included. No Bar

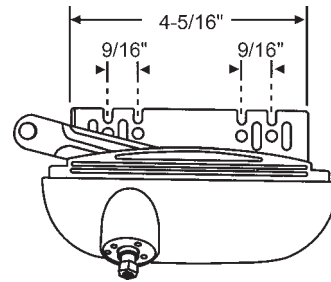

Part #	Hand	Finish
36-392LHW	Shown	White
36-392RHW	Opposite	White
36-392LHBEW	Shown	Blue White
36-392RHBEW	Opposite	Blue White
36-392LHAD	Shown	Almond
36-392RHAD	Opposite	Almond
36-392LHCY	Shown	Clay
36-392RHCY	Opposite	Clay
36-392LHMTBZ	Shown	Metallic Bronze
36-392RHMTBZ	Opposite	Metallic Bronze

Casement Split Arm.

Handle sold separately. See Pages 253 - 257
ROTO/INTERLOCK

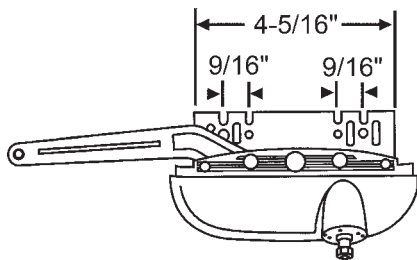

Part #	Hand	Finish
36-485RHW	Shown	White
36-485LHW	Opposite	White
36-485RHAD	Shown	Almond
36-485RHBEW	Shown	Blue White

Casement Operator with 6" Arm.

Handle sold separately. See Pages 253 - 257
ROTO/INTERLOCK

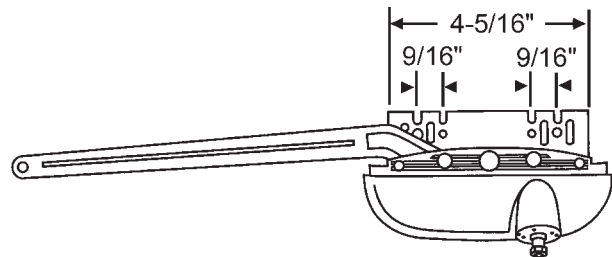

Part #	Hand	Finish
36-486RHBEW	Shown	Blue White
36-486LHBEW	Opposite	Blue White
36-486RHAD	Shown	Almond
36-486RHW	Shown	White
36-486LHW	Opposite	White

Casement Operator with 10" Arm

Handle sold separately. See Pages 253 - 257
ROTO/INTERLOCK

WINDOW REPLACEMENT HARDWARE

SILL MOUNTED CASEMENT OPERATORS

ROTO X-DRIVE & PRO-DRIVE OPERATORS

Roto X-Drive operators are a direct replacement for Roto's Pro Drive operators.

The Pro Drive operators take crank handles with a 5/16" hex male broach that snaps into the operator. See 37-221 on page 254

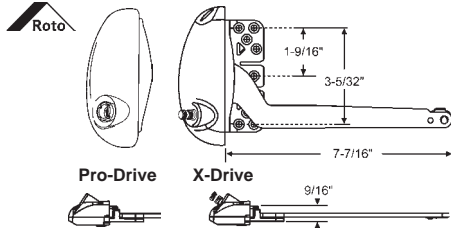

Part #	Hand	Finish	Style
36-498W-XD	Shown	White	X-Drive
36-497W-XD	Opposite	White	X-Drive
36-497AD	Opposite	Almond	Pro-Drive
36-498BEW	Shown	Blue White	Pro-Drive
36-497BEW	Opposite	Blue White	Pro-Drive
36-498EB	Shown	Earth Brown	Pro-Drive

7-1/2" Single Arm. For Vinyl Window Application.

Handle sold separately. See Pages 253 - 257

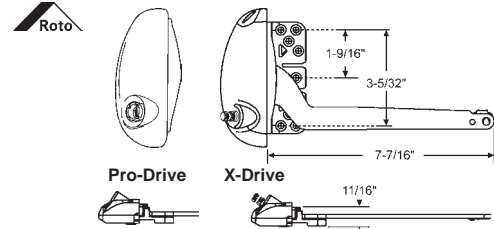

Part #	Hand	Finish	Style
36-496W-XD	Shown	White	X-Drive
36-495W-XD	Opposite	White	X-Drive
36-496W	Shown	White	Pro-Drive
36-495W	Opposite	White	Pro-Drive
36-496BEW	Shown	Blue White	Pro-Drive
36-496LAD	Shown	G2 Almond	Pro-Drive

7-1/2" Single Arm. Notched for Wood Application.

Handle sold separately. See Pages 253 - 257

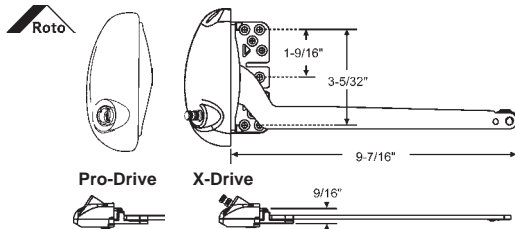

Part #	Hand	Finish	Style
36-500W-XD	Shown	White	X-Drive
36-501W-XD	Opposite	White	X-Drive
36-500BEW-XD	Shown	Blue White	X-Drive
36-501BEW-XD	Opposite	Blue White	X-Drive
36-500EB	Shown	Earth Brown	Pro-Drive
36-501EB	Opposite	Earth Brown	Pro-Drive
36-500MTBZ	Shown	Metallic Bronze	Pro-Drive
36-501MTBZ	Opposite	Metallic Bronze	Pro-Drive

9-1/2" Single Arm. For Vinyl Window Application.

Handle sold separately. See Pages 253 - 257

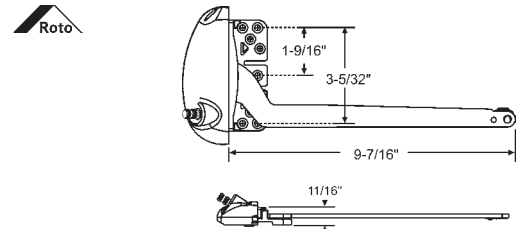

Part #	Hand	Finish	Style
36-490EW-XD	Shown	Euro White	X-Drive
36-491EW-XD	Opposite	Euro White	X-Drive

9-1/2" Single Arm. Notched for Wood Application.

Handle sold separately. See Pages 253 - 257

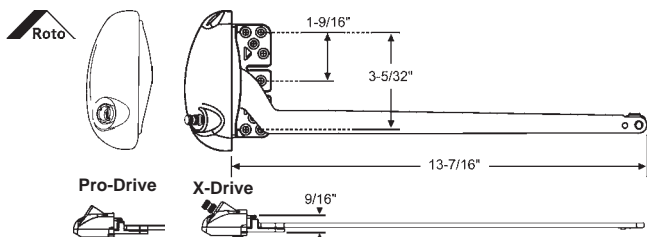

Part #	Hand	Finish	Style
36-514W-XD	Shown	White	X-Drive
36-510W-XD	Opposite	White	X-Drive
36-514AD	Shown	Almond	Pro-Drive
36-510AD	Opposite	Almond	Pro-Drive
36-514LAD	Shown	G2 Almond	Pro-Drive

13-1/2" Single Arm. For Vinyl Window Application.

Handle sold separately. See Pages 253 - 257

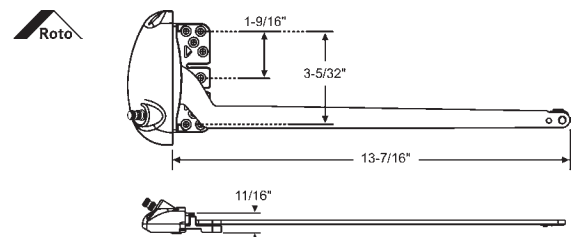

Part #	Hand	Finish	Style
36-543LHW-XD	Shown	White	X-Drive
36-543RHW-XD	Opposite	White	X-Drive

13-1/2" Single Arm. Notched for Wood Application.

Handle sold separately. See Pages 253 - 257

WINDOW REPLACEMENT HARDWARE

SILL MOUNTED CASEMENT OPERATORS

ROTO X-DRIVE & PRO-DRIVE OPERATORS

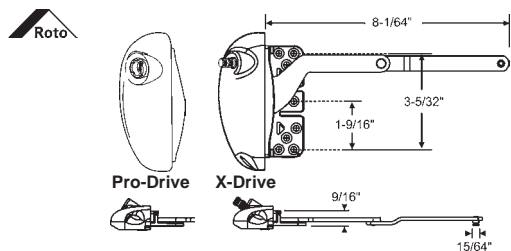

Part #	Hand	Finish	Style
36-511W-XD	Shown	White	X-Drive
36-525W-XD	Opposite	White	X-Drive
36-511AD	Shown	Almond	Pro-Drive
36-511BEW	Shown	Blue White	Pro-Drive
36-525BEW	Opposite	Blue White	Pro-Drive
36-511DBR	Shown	Dark Brown	Pro-Drive
36-525DBR	Opposite	Dark Brown	Pro-Drive
36-511EB	Shown	Earth Brown	Pro-Drive
36-525EB	Opposite	Earth Brown	Pro-Drive
36-511ORBZ	Shown	Oil Rubbed Bronze	Pro-Drive
36-525ORBZ	Opposite	Oil Rubbed Bronze	Pro-Drive

Split Arm. For Vinyl Window Application.

Handle sold separately. See Pages 253 - 257

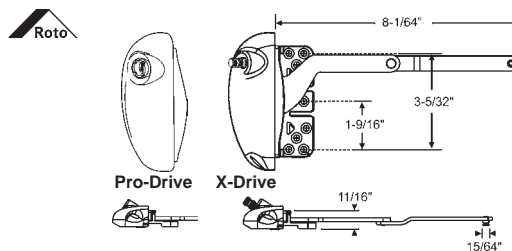

Part #	Hand	Finish	Style
36-539LHW-XD	Shown	White	X-Drive
36-539RHW-XD	Opposite	White	X-Drive
36-539LHW	Shown	White	Pro-Drive
36-539RHW	Opposite	White	Pro-Drive

Split Arm. Notched for Wood Application.

Handle sold separately. See Pages 253 - 257

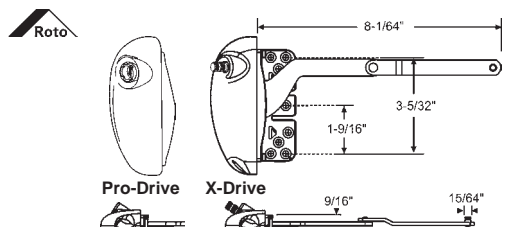

Part #	Hand	Finish	Style
36-508W-XD	Shown	White	X-Drive
36-509W-XD	Opposite	White	X-Drive
36-508EW	Shown	G1 White	Pro-Drive
36-509LAD	Opposite	G2 Almond	Pro-Drive

Split Arm Inverted. For Vinyl Window Application.

Handle sold separately. See Pages 253 - 257

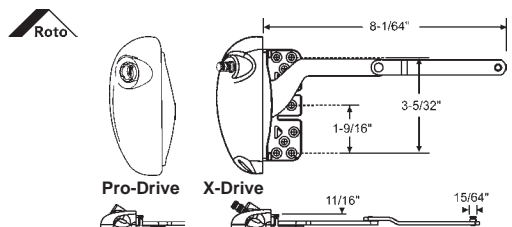

Part #	Hand	Finish	Style
36-540LHW-XD	Shown	White	X-Drive
36-540RHW-XD	Opposite	White	X-Drive
36-540LHW	Shown	White	Pro-Drive
36-540RHW	Opposite	White	Pro-Drive

Split Arm Inverted. Notched for Wood Application.

Handle sold separately. See Pages 253 - 257

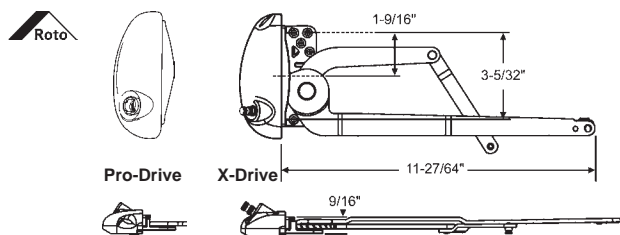

Part #	Hand	Finish	Style
36-517W-XD	Shown	White	X-Drive
36-518W-XD	Opposite	White	X-Drive
36-517DBR	Shown	Dark Brown	Pro-Drive
36-518DBR	Opposite	Dark Brown	Pro-Drive
36-517EB	Shown	Earth Brown	Pro-Drive
36-518EB	Opposite	Earth Brown	Pro-Drive
36-517W	Shown	White	Pro-Drive
36-518W	Opposite	White	Pro-Drive
36-518EW	Opposite	G1 White	Pro-Drive
36-517EW	Shown	G1 White	Pro-Drive

Dual Arm. For Vinyl Window Application.

Handle sold separately. See Pages 253 - 257

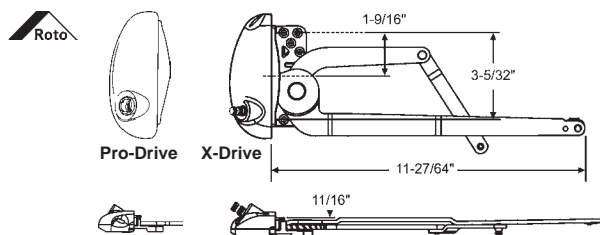

Part #	Hand	Finish	Style
36-528LHW-XD	Shown	White	X-Drive
36-528RHW-XD	Opposite	White	X-Drive
36-528LHW	Shown	White	Pro-Drive
36-528RHW	Opposite	White	Pro-Drive
36-528LHBEW	Shown	Blue White	Pro-Drive

Dual Arm. Notched for Wood Application.

Handle sold separately. See Pages 253 - 257

WINDOW REPLACEMENT HARDWARE

SILL MOUNTED CASEMENT OPERATORS

Pella

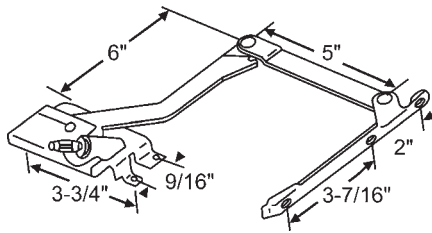

Part #	Hand
900-8865	Shown
900-8866	Opposite

Handle and cover sold separately. See Pages 252- 257

Pella

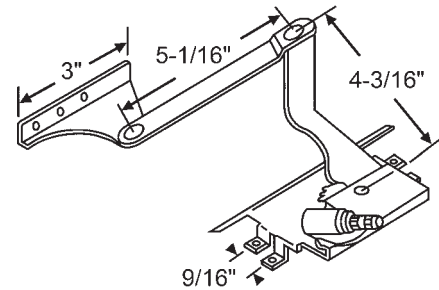

Part #	Hand
36-362	Shown
36-363	Opposite

Handle and cover sold separately. See Pages 252- 257

Pella

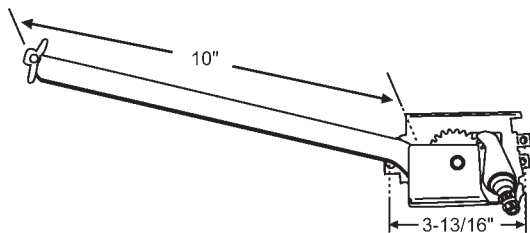

Part #	Hand
900-19619	Shown
900-19620	Opposite

Handle and cover sold separately. See Pages 252- 257

Pella

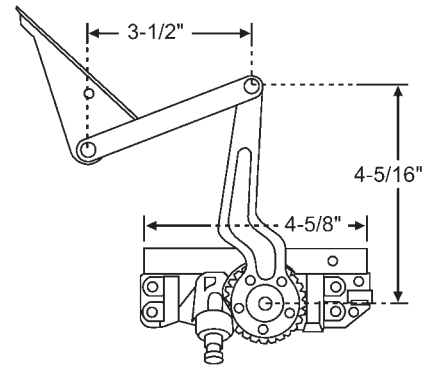

Part #	Hand
36-488	Shown
36-489	Opposite

Handle and cover sold separately. See Pages 252- 257

Original G-U operators had a plastic housing and a slight bend in the arm. Currently being replaced with metal die cast housing and stainless steel worm gear and straight arm. Replacement does not have bent arm.

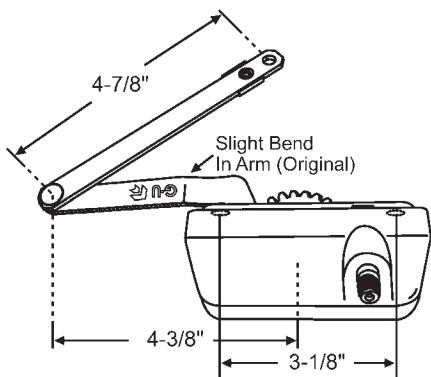

Part #	Hand	Finish	Handle
36-516RHBW	Shown	Blue White	37-137-3
36-516LHBW	Opposite	Blue White	37-137-3

G-U/SILVER LINE

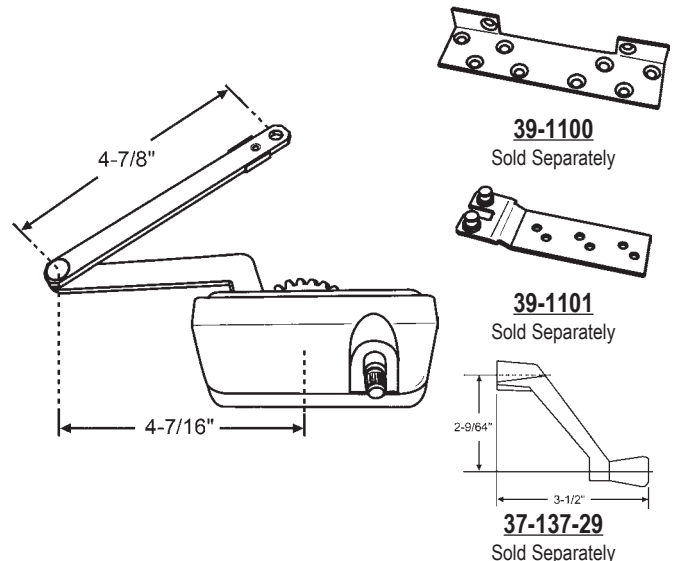

Part #	Hand	Finish
36-516RHWMA	Shown	White
36-516LHWMA	Opposite	White

Dyad Operator. Fits G-U.
SILVER LINE

WINDOW REPLACEMENT HARDWARE

SILL MOUNTED CASEMENT OPERATORS

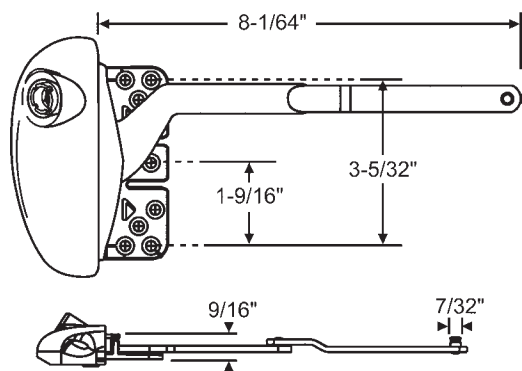

Part #	Hand
36-559LHBEW	Shown

Blue White. 3/16" Pin Height
SILVER LINE

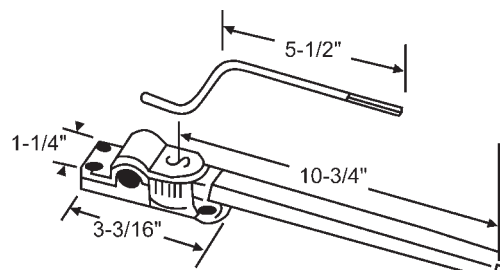

Part #	Finish
900-12962	Chrome Plated
900-12962BP	Brass Plated

Non-Handed, Handle Included.
Handle Only Available: #900-14106

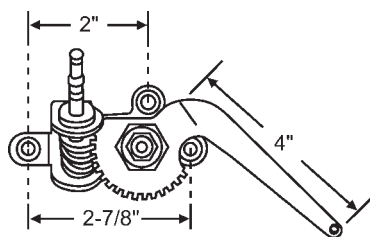

Part #
900-9834

Non-handed. Uses 900-9690 Crank Handle
For Drag Link, See Page 258
PEACHTREE

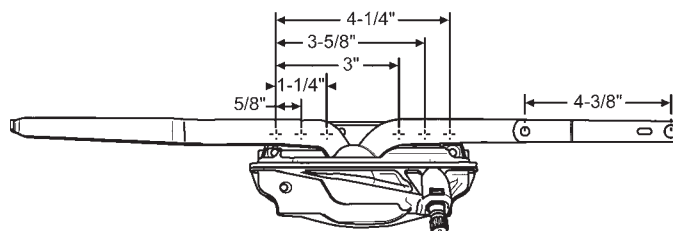

Part #	Hand
36-565SS	Shown
36-566SS	Opposite

Dual Arm Operator

BILTBEST

Replaces old style operators with repair kit as shown below.

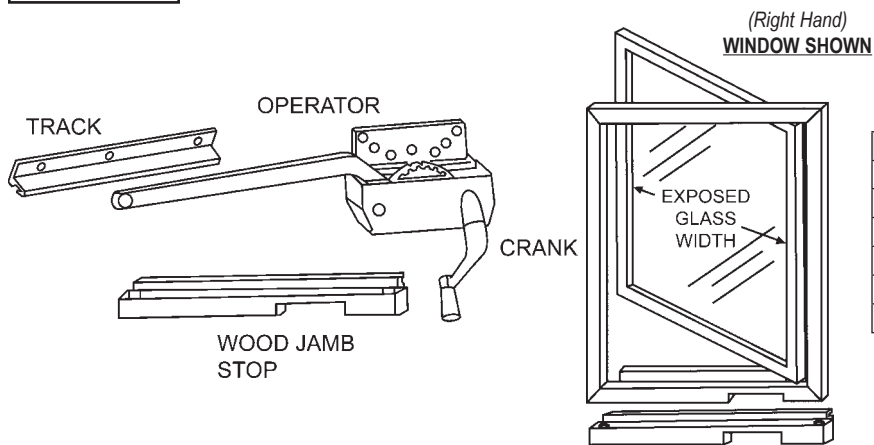

Part #	Glass Width Size	Hand	Sill Length
900-21850	14-5/8"	LH	16-1/8"
900-21849	14-5/8"	RH	16-1/8"
900-21852	19-1/8"	LH	20-5/8"
900-21851	19-1/8"	RH	20-5/8"
900-22703	22"	LH	24-7/16"
900-22703OP	22"	RH	24-7/16"

Casement Operator
Replacement Kit

Kits come with 9-1/2" Truth single arm operator.
Operator only see page 218 part number 36-128 & 36-129.

WINDOW REPLACEMENT HARDWARE

LEVER OPERATORS

Note: See lever operator brackets on page 250.

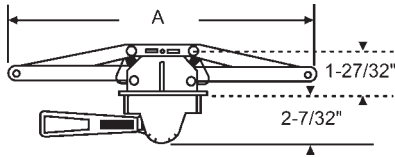

Part #	Hand	Finish	A
36-168-1	Shown	Bronze	13-1/8"
36-168-2	Shown	Gold	13-1/8"
36-168-3	Shown	White	13-1/8"
36-168-5	Shown	Bright Brass	13-1/8"
36-169-3	Opposite	White	13-1/8"
36-153-1	Shown	Bronze	20-1/2"
36-153-3	Shown	White	20-1/2"
36-153-5	Shown	Bright Brass	20-1/2"
36-157-1	Opposite	Bronze	20-1/2"
36-157-2	Opposite	Gold	20-1/2"

Other finishes available. Handle shown in locked position
See Lever Operator Brackets on Page 250. Available with Removable Escutcheon

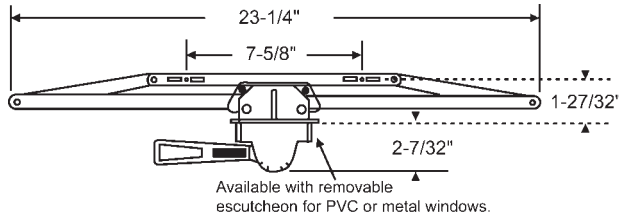

Part #	Hand	Finish
36-162-1	Shown	Bronze
36-162-3	Shown	White
36-163-1	Opposite	Bronze
36-163-3	Opposite	White
36-163-75	Opposite	Copper

Other finishes available. Handle shown in locked position
See Lever Operator Brackets on Page 250. Available with Removable Escutcheon

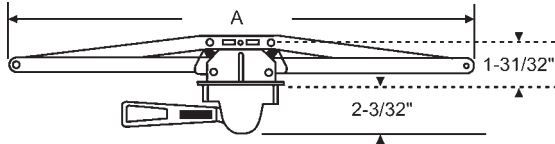

Part #	Hand	Finish	A
36-160-1	Shown	Bronze	20-1/2"
36-161-1	Opposite	Bronze	20-1/2"
36-161-2	Opposite	Gold	20-1/2"
36-166-1	Shown	Bronze	23-1/4"

Other finishes available. Handle shown in locked position
See Lever Operator Brackets on Page 250.

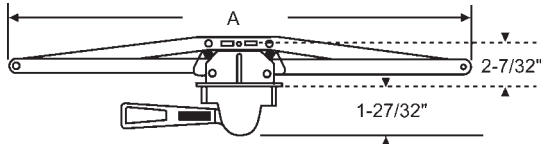

Part #	Hand	Finish	A
36-158-1	Shown	Bronze	20-1/2"
36-158-87	Shown	Gold	20-1/2"
36-159-2	Opposite	Gold	20-1/2"
36-164-1	Shown	Bronze	23-1/4"
36-164-87	Shown	Gold	23-1/4"

Other finishes available. Handle shown in locked position
See Lever Operator Brackets on Page 250.

ROTO INVISIBLE MOTORIZED AND MANUAL SKYLIGHT OPERATOR SYSTEMS

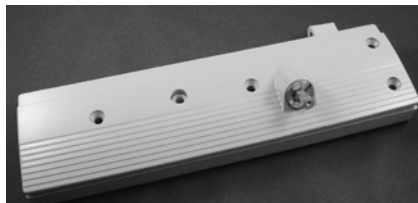

Part #	Color
36-536SND	Sandstone

Manual skylight operator with round end connector.

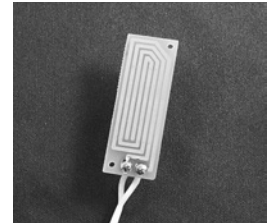

39-803

Motorized skylight conversion kit rain sensor only.

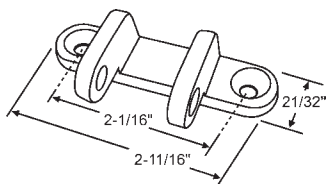

39-792

Mounting bracket only for round end connector. White

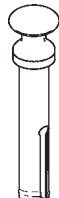

39-838

Mounting bracket pin for round end connector. White

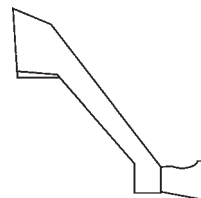

37-235SND

Handle for manual skylights with 5/16" hex spline. Sandstone

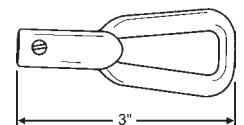

39-492

Eyelet with 5/16" hex spline Sandstone

WINDOW REPLACEMENT HARDWARE

MOTORIZED OPERATORS FOR SKYLIGHTS



Introducing Truth's next generation of power window system... Sentry II HS® for heavy skylights. Based on the powerful and reliable mechanics from our previous SkySentry® Motorization Systems, they've added a new digital electronics package with built in power conversion to take this system to a whole new level of service and reliability.

Sentry II HS Motorized Skylight System & Synchronous Skylight Motor Kits 39-634

39-642
Switch Only



39-640
Remote Only



Cover for Sentry II HS

Part #	Color
39-637-3	White
39-637-7	Aluminum
39-637-8	Chestnut Bronze
39-637-9	Beige
39-637-15	Off White

Many Finishes Available

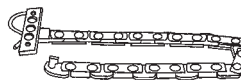
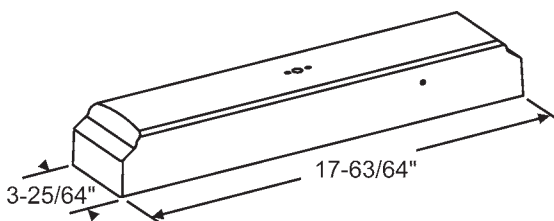

Part #	Length
39-388	12"
39-416	9"

Chain Assembly for Skylight Operator with Bracket & Pin

The New Electronics Package provides many new features to enhance a home's comfort and its owner's peace of mind.

Quick and Easy Installation of the skylight is possible when motor system is pre-installed and programmed by skylight manufacturer at their facility. The electrician needs only to connect line voltage power and the skylight is completely ready for operation -no further set up would be required by the installer or homeowner!

Power Conversion built right into the skylight mounted control package which accepts direct connection of line voltages from 100 to 240 VAC at 47 to 440 Hz. No more transformers to complicate and add expense to the installation.

Power Blind System Compatible. Centralized window control is now possible with Sentry II's ability to accept and control most 24 VDC power blind systems. The Sentry II RF remote or wall switch controls both skylight and blind motors for convenient, centralized control.

Power Protected Memory eliminates the need to "reset" or retrain the control system after a power outage. Once the installation is complete, the motor never needs further service or adjustments - even after prolonged power outages!

RF Remote Compatibility built into all motor control packages as a standard feature. Simply order the optional remote to add new and exciting control capability for the homeowner.

Rain Sensor, standard on all kits, automatically closes the skylight at the first sign of moisture. Corrosion resistant sensor decreases mechanisms cleaning requirements and extends service life.

Easily Adapts for new construction or retrofit applications. Please consult with your electrical contractor for a retrofit evaluation.

ETL Listed and CE Approved. Meets all requirements for Class II installations.

Safety -Automatic Motor Reversal has been engineered into the system which is intended to reverse the motor should an obstruction stop the skylight while closing. In addition, a screen interlock is provided which, when properly installed, electrically disconnects the motor when the screen is removed. These features are intended to help prevent personal injury which could result from reaching into the skylight area during its operation.

Synchronized Operation of multiple motors is now standard on the HS motor system. The same Sentry II HS motor system can now be used on single motor applications or it can be ganged with up to four motor units on a large single skylight. Multiple motors on a single skylight add stability and capacity.

Awning Windows Can also be fitted with the Sentry II HS Motor System. Skylight hardware systems work great on awning windows with butt hinges.

Building Automation Systems can easily be tied into the control electronics for virtually limitless ventilation possibilities.

SENTRY II HS CAPACITY

Truth's Sentry II HS for heavy skylights is load rated at 80 lbs. at the chain. This equates to a total skylight hatch weight of 160 lbs. Sentry II HS power skylight system is rated at 50 watts.

Sentry II HS for heavy skylights
Order 1 per skylight

- 39-634 - Sentry II HS System
- 39-637-X - Cover (X denotes finish code)

Order 1 Hand Held Remote and/or Wall Switch

- 39-640 - Hand Held RF Remote
- 39-642 - Wall Switch

WINDOW REPLACEMENT HARDWARE

MOTORIZED OPERATORS FOR CASEMENT & AWNING WINDOWS



Introducing Truth's Next Generation of Power Window Systems... Sentry II WLS® for Windows and Light Skylights. Based on the powerful and reliable mechanics from their previous motorization system, they've added a new digital electronics package with built in power conversion. This New Sentry II WLS System truly takes over where Truth's Sentry 2000® left off.

Sentry II WLS Motorized Power Window & Skylight System
39-635

Sentry II WLS Motorized Power Window & Skylight System for **Pella** Windows
39-636



39-640
Remote Only

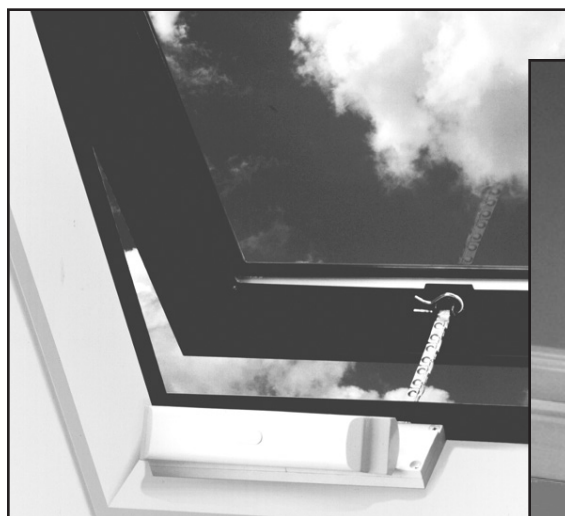

Cover for Sentry II WLS

Part #	Color
39-638-1	Bronze
39-638-3	White
39-638-35	Champagne
39-638-7	Aluminum

Many Finishes Available

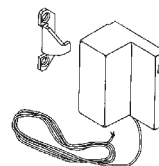
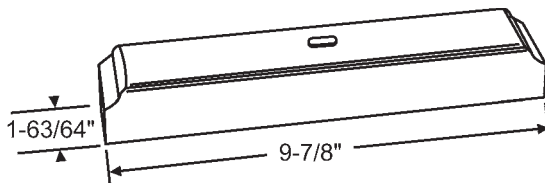

Part #	Color
39-326-3	White

Motorized Sash Lock Kit.
Includes Lock, Decorative Cover and Hardware Pack



Part #	Length
39-388	12"
39-416	9"

Chain Assembly for Skylight Operator with Bracket & Pin

The New Electronics Package provides many new features to enhance a home's comfort and its owner's peace of mind.

Retrofits onto casement and awning windows and light skylights operated with a hand crank manufactured by Truth Hardware. The motor system drives the same input the handle is attached to.

Power Conversion built right into the wall mounted control package which accepts direct connection of line voltages from 100 to 240 VAC at 47 to 440 Hz. No more transformers to complicate and add expense to the installation.

Power Blind System Compatible. Centralized power window system control is now possible with Sentry II's ability to accept and control most 24 VDC power blind systems. The Sentry II's remote and wall switch can be used to control both window and blind motors for convenient, centralized control.

Power Protected Memory eliminates the need to "reset" or retrain the motor after a power outage. Once the installation is complete the motor never needs further service or adjustments - even after prolonged power outages!

RF remote compatibility built into all motor control packages as a standard feature. Simply order the optional remote to add new and exciting control capability for the homeowner.

Rain Sensor -standard with all kits, automatically closes the window or skylight at the first sign of moisture. Corrosion resistant sensor decreases maintenance cleaning requirements and extends service life.

No Special Preparation is required by the window or skylight manufacturer. The kits are suitable for new construction or retrofit applications. Please consult with your electrical contractor for a retrofit evaluation.

ETL Listed and CE Approved. Meets all requirements for Class II installations.

Safety - Automatic motor reversal has been engineered into the system which is intended to reverse the motor should an obstruction stop the window while closing. In addition, a screen interlock is provided which, when properly installed, electrically disconnects the motor when the screen is removed. These features are intended to help prevent personal injury which could result from reaching into the window area during its operation.

Motorized Sash Locks are available for use with the WLS system for casement and awning windows.

Building Automation Systems can easily be tied into the control electronics for virtually limitless ventilation possibilities.

SENTRY II WLS CAPACITY

- When used on light skylights, Truth's Sentry II WLS is load rated at 40 lbs at the chain. This equates to a total skylight hatch weight of 80 lbs.
- When used on casement windows, the Sentry II WLS is designed to work on all window systems meeting the AAMA-101 hardware load requirements.
- When used on awning windows, the Sentry II WLS is designed to work on awning windows with a properly sized counter-balance hinge and operator. (Consult awning operator specifications).

Sentry II WLS for windows and light skylights
Order 1 each per window:

- 39-635 - Sentry II WLS System
- 39-638-X - Cover (X denotes finish code)

Order 1 Hand Held Remote (optional):

- 39-640 - Hand Held RF Remote

WINDOW REPLACEMENT HARDWARE

MOTORIZED OPERATORS FOR SKYLIGHTS, TAKE OUT & AWNING WINDOWS



NEW Marvel™ Sleek and Petite Motorized Operating System

Truth Hardware's new Marvel™ power operator system for windows and skylights proves that simpler can be better. Challenged with the expectation of window and skylight manufacturers with providing a small and sleek motorized system that is simple to install, easy to operate and above all affordable - Truth is confident that the Marvel System is the answer.

Easy to Install and Operate

With installation templates provided in each kit, the mounting brackets used to help secure the Marvel Operator to the center of your window makes this system one of the easiest systems to install.

- Three styles of mounting brackets accompany this product to allow for easy mounting.
- Can be face-mounted or mounted to applications with sills.
- Rated to lift skylight sashes that weigh up to 90 lbs.
- Rated for use in outdoor applications only.
- Controlled using a standard, single pole / double throw, center off momentary contact switch. (Not Supplied)
- Durable double link chain produces 9.5" of chain travel.
- Electronic limit switch controls the opening position while the closing position is controlled through an internal current sensing feature.
- Users can operate multiple units from one control switch.

Note: When used on awning windows, the Marvel System is designed to work on awning windows with a properly sized counter balance hinge such as Truth 13 series or 34 series hinges.

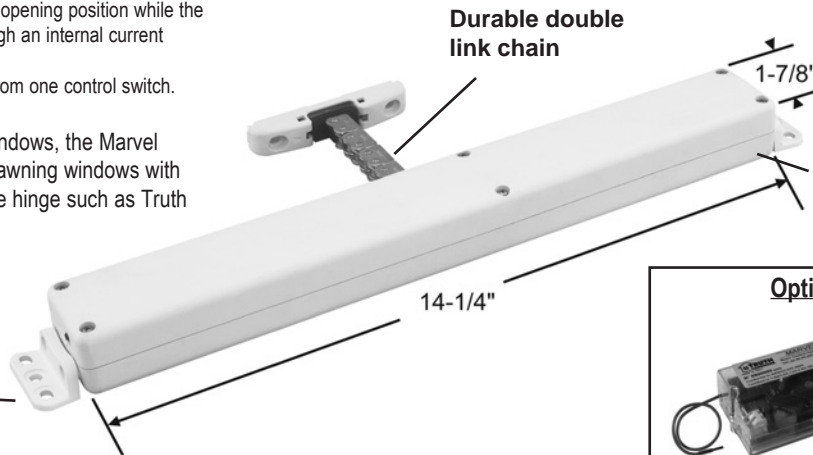

No transformer required. Operates from 110 volt household current.

Three styles of mounting brackets to allow for easy mounting

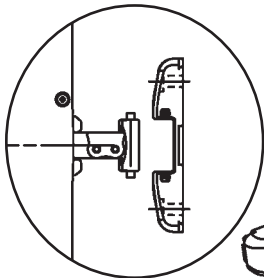

Snap Bracket Type

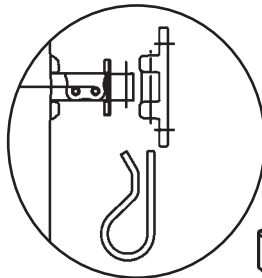

Pull Pin Bracket Type

Part #	Truth #	Finish
39-760-1	42.90.03.100	Bronze
39-760-32	42.90.38.100	White (Weathershield)

Part #	Truth #	Finish
39-789-1	42.90.03.101	Bronze
39-789-32	42.90.38.101	White

Optional Accessories



39-840
Receiver



39-908
Rain Sensor



39-866
Switch

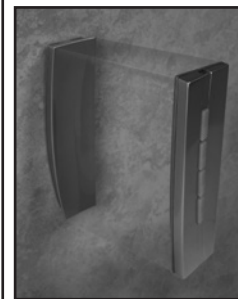

39-841
Remote with Wall Mount

WINDOW REPLACEMENT HARDWARE

MANUAL SKYLIGHT OPERATORS & ACCESSORIES



Add Value to Your Operable Skylight

The Truth Skylight Operator System offers you the flexibility the marketplace demands, the quality your windows deserve, easy factory or field installation and a means to keep your skylight hardware inventories both cost effective and efficient. The Truth Skylight Operator system is easy to install and compatible with wood, metal or vinyl framed skylights. Upgrading is easier and faster. Truth's special high gear reduction provides the low torque needed to lift a maximum sash weight of 160 pounds. Choose from two Manual Drive modules for the application that best meets your needs. Each easily mounts to the base module.

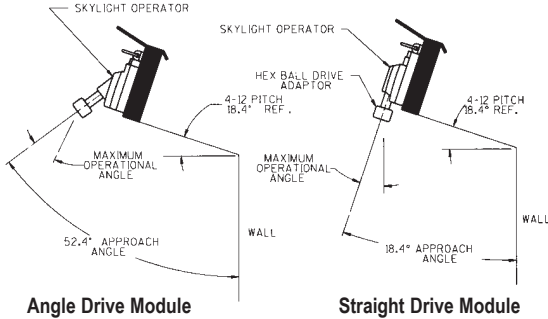

Angle Drive

Part #	Color
36-342-1	Bronze
36-342-3	White

Straight Drive

Part #	Color
36-345-1	Bronze
36-345-3	White

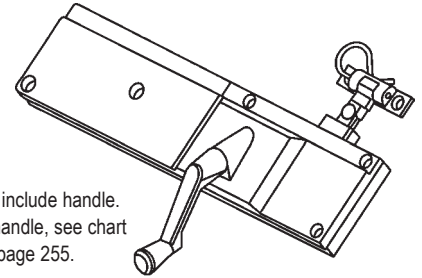

Does not include handle.
 To order handle, see chart on page 255.

UNIVERSAL POLE RING SYSTEM

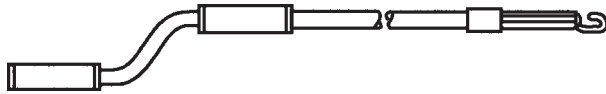
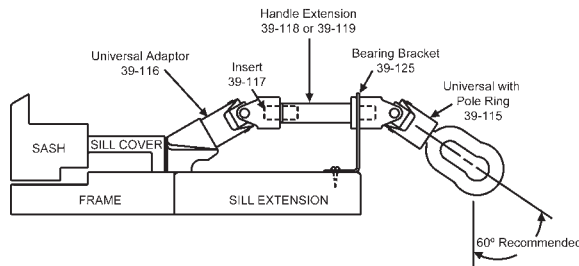

Description	Part #	Collapsed	Extended
Pole with Hook	39-198	48"	73"
Pole with Hook	39-102	74-1/8"	122-3/4"



Description	Part #	Collapsed	Extended
Pole with Hex Ball	39-199	48"	73"
Pole with Hex Ball	39-101	73-3/8"	122"

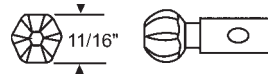

39-94
 Hex Ball Drive

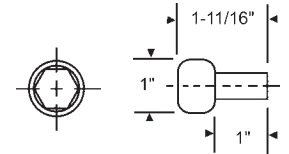

Part #	Color
39-100-1	Bronze
39-100-3	White

Hex Ball Adapter

Fits Truth

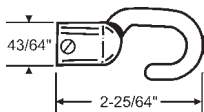

39-95
 Hook Drive

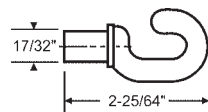

39-95SP
 Hook Drive

Fits Truth

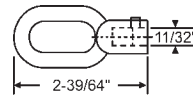

Part #	Color
39-97	Unpainted
39-97-1	Bronze
39-97-3	White

Eyelet Adapter. Fits Truth

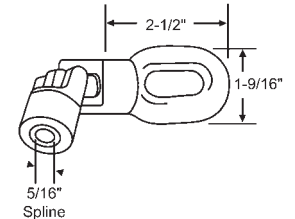

900-15576
 5/16" Universal Joint
 Aluminum Finish

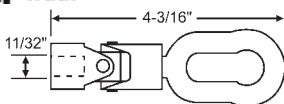

Part #	Color
39-115-1	Bronze
39-115-3	White
39-115-7	Aluminum

Universal with Pole Ring

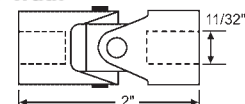

Part #	Color
39-116-1	Bronze
39-116-3	White
39-116-7	Aluminum

Universal Adaptor



Part #	Color	A
39-118-1	Bronze	2"
39-118-3	White	2"
39-119-1	Bronze	4"
39-119-3	White	4"

11/32" Male/Female Handle Extension

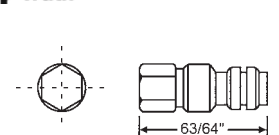

39-117
 Insert

WINDOW REPLACEMENT HARDWARE

MANUAL SKYLIGHT OPERATOR ACCESSORIES

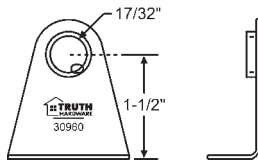

Part #	Color
39-125-1	Bronze
39-125-3	White
39-125-7	Aluminum

Bearing Bracket

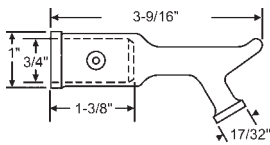

900-16815
White Bronze Pole Hook

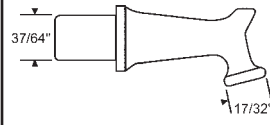

900-16843
Pole Hook

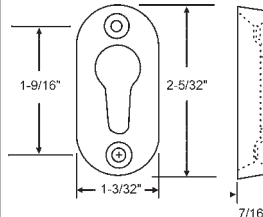

900-16844
Pole Hook Hanger
White Bronze

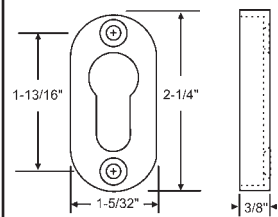

900-16845A
Pole Hook Hanger
White Bronze

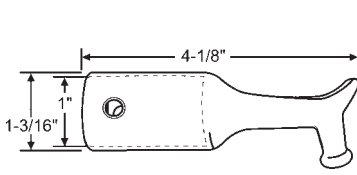

900-11299
Aluminum Pole Hook

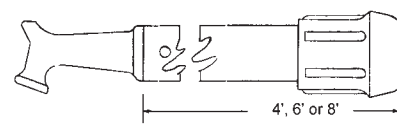

Part #	Length
900-16842-4	4'
900-16842-6	6'
900-16842-8	8'

Pole Hook Assembly
Aluminum Tube with Rubber End

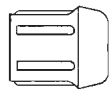

900-18245
Rubber Tip Only

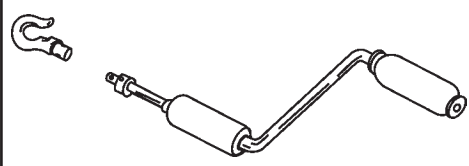

Part #	Description
39-672	CL Pole with AGR & HK - 5'
39-673	CL Pole 5' Extension

VELUX SKYLIGHT OPERATOR & ACCESSORIES

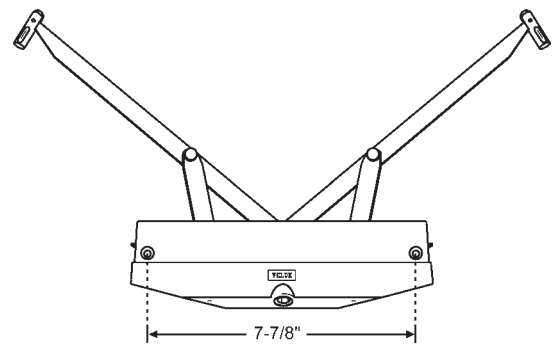

900-21657
10" Split Arm Operator. Gold

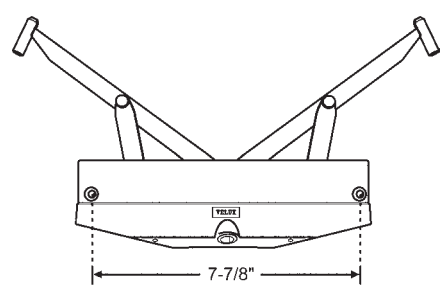

900-21658
8" Split Arm Operator. Gold
Must Order Snap-In Hex Adapter Separately.

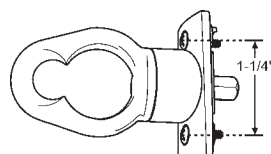

37-180
Hook Adapter for Skylight

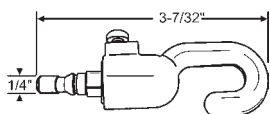

39-755
Hook for Velux Operator

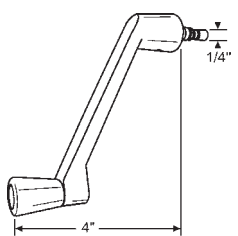

37-171
Long Handle for Velux Operators

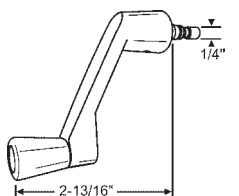

37-172
Short Handle for Velux Operators

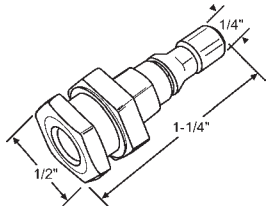

900-22073
Snap-In Metal Hex Adapter

WINDOW REPLACEMENT HARDWARE

REAR MOUNT AWNING OPERATOR

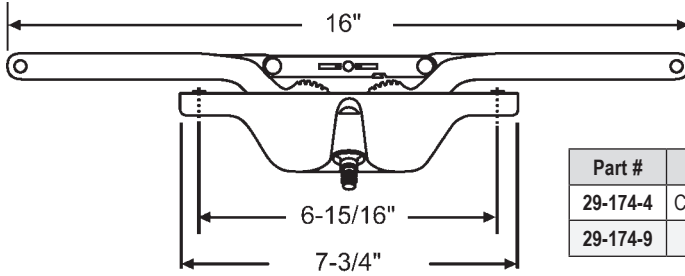

Part #	Finish	Mounting Style
29-174-4	Coppertone	Rear
29-174-9	Beige	Rear

LEVER AWNING OPERATOR

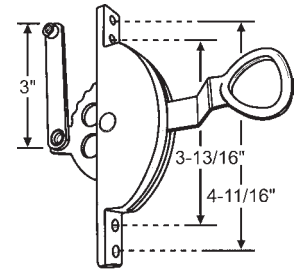

29-276W
Lever Operator. White

CLERESTORY WINDOW WANDS

Put those operable clerestory windows to energy-saving use with our 39-series clerestory extension crank. High mounted windows are excellent for capturing light while providing privacy, but they can also be "excellent" heat traps. It is now possible to vent the heat that rises to these areas as easily as opening any other window in the home.

It's inexpensive and can easily retrofit to existing or new window installations. By simple removal of the existing crank handle and replacement with an adapter (see adapter selection chart), the crank will open and close any operable clerestory window. It is not necessary to replace the current operator. Remember that you will only need one clerestory crank to operate all windows at the same height.

The removable extension crank is available in many standard sizes for either sill or jamb mounted operators. Refer to the selection chart to the right. The standard finish for the crank is natural anodized aluminum.

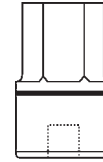
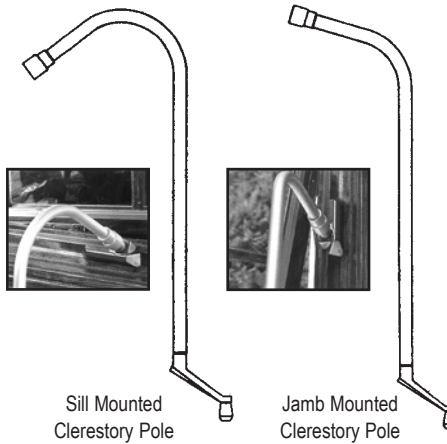

Female

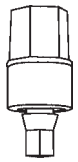

Male

Female Crank Handle Adapters

Part #	Fits
39-105A	Andersen
39-105PELLA	Pella
39-105	Truth, Marvin, Caradco, Weather Shield, Hurd, Biltbest, Eagle, Vetter, Roto X-Drive, Others
39-105PT	Getty, Peachtree
39-105HEX	Milgard

Male Crank Handle Adapters

Part #	Fits
39-105ROTO-OLD	Roto Pro Drive (OPO5)

Adapters Used with Clerestory Window Wands

Manual Window Wand Selection Chart



Part #	Location of Operator	Crank Length	Distance from Floor
39-104-3	Sill	3'	7'
39-527-3	Jamb	3'	7'
39-104-4	Sill	4'	8'
39-527-4	Jamb	4'	8'
39-104-5	Sill	5'	9'
39-527-5	Jamb	5'	9'
39-104-6	Sill	6'	10'
39-527-6	Jamb	6'	10'
39-104-7	Sill	7'	11'
39-527-7	Jamb	7'	11'
39-104-8	Sill	8'	12'
39-527-8	Jamb	8'	12'
39-104-9	Sill	9'	13'
39-527-9	Jamb	9'	13'
39-104-10KD	Sill	10'	14'
39-527-10KD	Jamb	10'	14'
39-104-12KD	Sill	12'	16'
39-527-12KD	Jamb	12'	16'

WINDOW REPLACEMENT HARDWARE

FACE MOUNTED AWNING OPERATORS

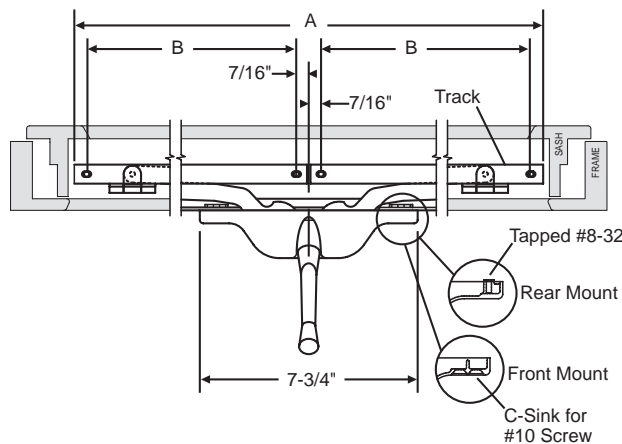

Part #	Arm Length	Overall Length "A" Including Track	Finish	Mounting Style	Track Part #	Track Length "B"
29-129-8	5-1/2"	16-3/4"	Chestnut Bronze	Front	38-66	7-1/2"
29-129-10	5-1/2"	16-3/4"	Black	Front	38-66	7-1/2"
29-129-13	5-1/2"	16-3/4"	Brushed Copper Nickel	Front	38-66	7-1/2"
29-130-3	9"	25-3/4"	White	Front	38-57	12"
29-130-7	9"	25-3/4"	Aluminum	Front	38-57	12"
29-130-8	9"	25-3/4"	Chestnut Bronze	Front	38-57	12"
29-128-1	11"	27-3/4"	Bronze	Front	38-58	13"
29-128-3	11"	27-3/4"	White	Front	38-58	13"
29-128-7	11"	27-3/4"	Aluminum	Front	38-58	13"
29-128-8	11"	27-3/4"	Chestnut Bronze	Front	38-58	13"
29-128-12	11"	27-3/4"	Medium Bronze	Front	38-58	13"
29-128-13	11"	27-3/4"	Brushed Copper Nickel	Front	38-58	13"
29-185-3	11"	27-3/4"	White	Rear	38-58	13"

Pivot Shoe Operator. Designed for Single Vent Awning Windows.

Handle sold separately. See Pages 253 - 257

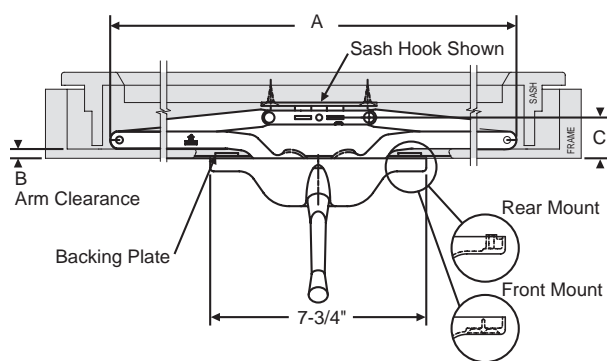

Part #	Overall Width "A"	Arm Clearance "B"	Dimension "C"	Finish	Mounting	Approximate Sash Opening
29-181-1	16"	11/32"	1-1/2"	Bronze	Rear	10"
29-181-3	16"	11/32"	1-1/2"	White	Rear	10"
29-182-3	16"	11/32"	1-1/2"	White	Front	10"
29-177-3	21-1/2"	1/4"	1-3/32"	White	Front	15"
29-199-1	21-1/2"	1/4"	1-3/32"	Bronze	Rear	15"
29-199-3	21-1/2"	1/4"	1-3/32"	White	Rear	15"
29-199-8	21-1/2"	1/4"	1-3/32"	Chestnut Bronze	Rear	15"
29-159-3	21-1/2"	11/32"	1-1/2"	White	Rear	15"
29-159-10	21-1/2"	11/32"	1-1/2"	Black	Rear	15"

Scissors Arm Operator

Handle sold separately. See Pages 253 - 257

WINDOW REPLACEMENT HARDWARE

SILL MOUNTED AWNING OPERATORS

TRUTH'S ENTRYGARD SERIES AWNING OPERATORS

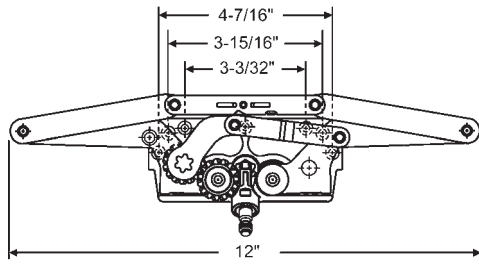

29-167

Handle and cover sold separately. See Pages 252 - 257
Single Pull

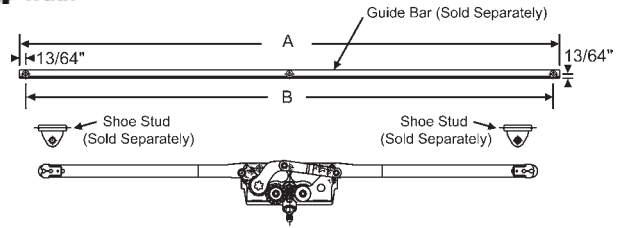

Part #	A	B	Shoe Stud	Guide Bar
29-166	22-3/4"	22-1/8"	39-42	39-320
29-168	30-3/4"	30-1/8"	39-42	39-354

Note: Order Shoe Studs and Guide Bar Separately.

Handle and cover sold separately. See Pages 252 - 257

TRUTH'S TRADITIONAL SERIES AWNING OPERATORS

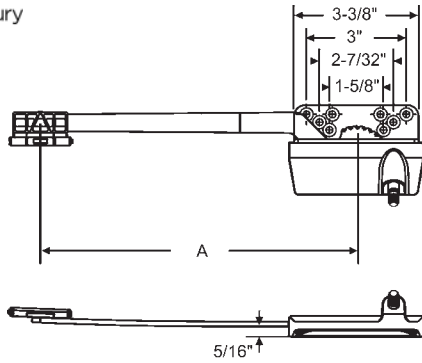

Part #	A
36-301-3	9-1/2"
36-337-3	13-1/2"

Single Arm

Handle sold separately. See Pages 253 - 257

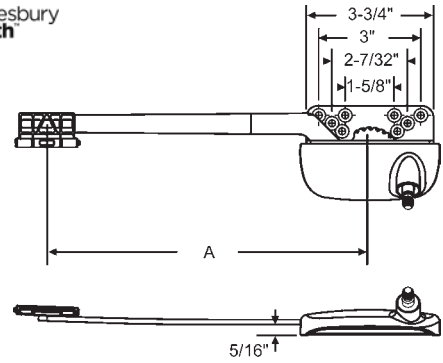

Part #	A
36-301-3E	9-1/2"
36-337-3E	13-1/2"

Single Arm

Handle sold separately. See Pages 253 - 257

TRUTH'S MAXIM® SERIES AWNING OPERATORS

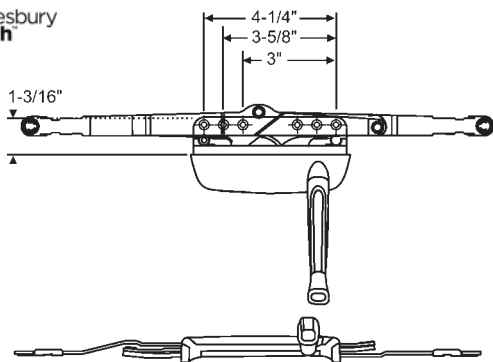

Part #	Finish	Handle Only
29-179-1	Bronze	37-150-1
29-179-3	White	37-150-3

Other Finishes Available.

Handle sold separately. See Pages 253 - 257

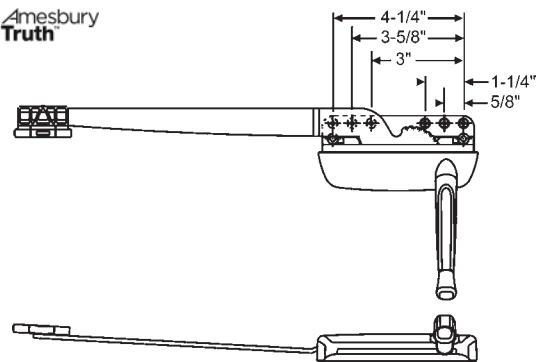

Part #	Finish	Handle Only
29-191-1	Bronze	37-150-1
29-191-3	White	37-150-3

Other Finishes Available

Handle sold separately. See Pages 253 - 257

WINDOW REPLACEMENT HARDWARE

SILL MOUNTED AWNING OPERATORS

TRUTH'S MAXIM® SERIES NARROW AWNING OPERATORS

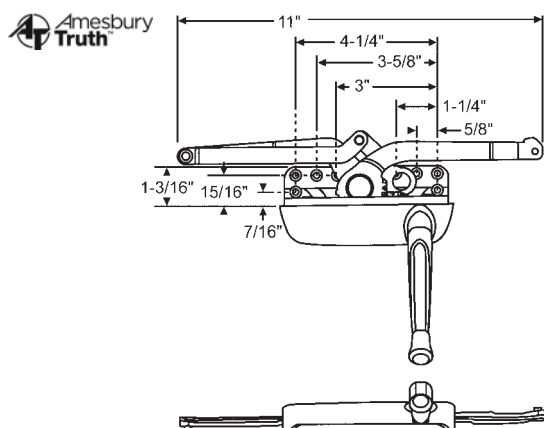

Part #	Finish	Handle Only
29-240-3	White	37-150-3

Other Finishes Available

Handle sold separately. See Pages 253 - 257

TRUTH'S ENCORE SERIES AWNING OPERATORS

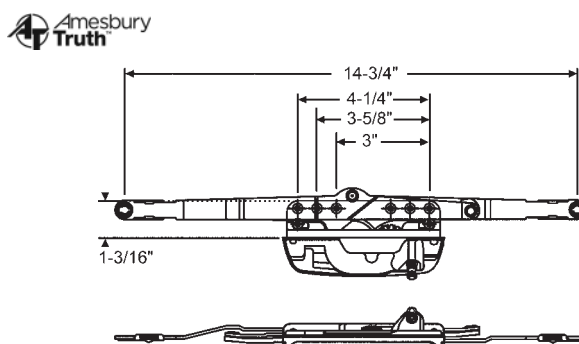

29-179EN

Handle and cover sold separately. See Pages 252 - 257

TRUTH'S ENCORE SERIES NARROW AWNING OPERATORS

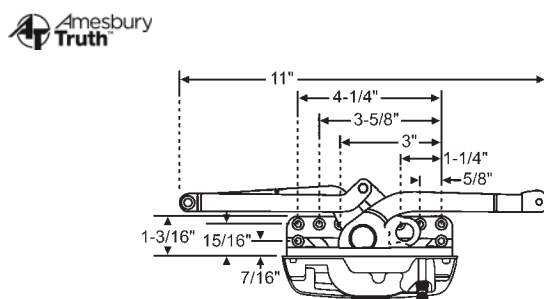

Part #	Description
29-240EN	Steel
29-240ENSS	Stainless Steel

Other Finishes Available

Handle and cover sold separately. See Pages 252 - 257

TRUTH'S AWNING OPERATORS

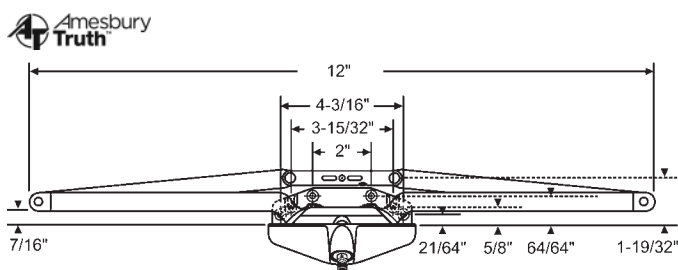

Part #	Finish
29-156-1	Bronze
29-156-3	White

Single Pull.

Handle sold separately. See Pages 253 - 257

TRUTH'S AWNING OPERATORS

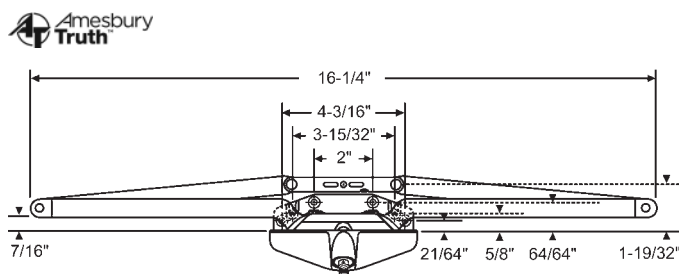

Part #	Finish
29-119-1	Bronze
29-119-3	White
29-119-6	Clay
29-119-9	Beige

Single Pull.

Handle sold separately. See Pages 253 - 257

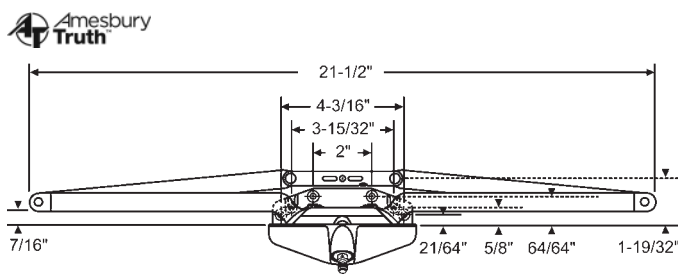

Part #	Finish
29-118-1	Bronze
29-118-3	White
29-118-6	Clay
29-118-8	Chestnut Bronze
29-118-87	Gold
29-118-9	Beige

Single Pull.

Handle sold separately. See Pages 253 - 257

WINDOW REPLACEMENT HARDWARE

SILL MOUNTED AWNING OPERATORS

TRUTH'S AWNING OPERATORS

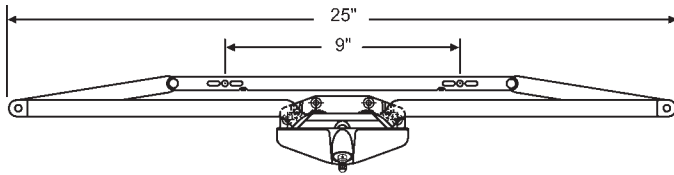

Part #	Finish
29-120-1	Bronze
29-120-87	Gold (New)
29-120-3	White

Dual Pull

Handle sold separately. See Pages 253 - 257
Other Finishes Available

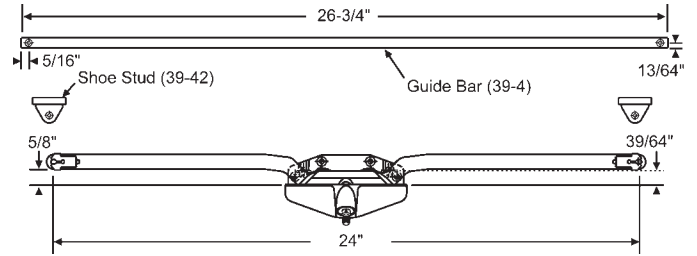

Part #	Finish
29-121-1	Bronze
29-121-87	Gold (New)
29-121-3	White
29-121-10	Black

Note: Must Order Shoe 39-42 Stud and 39-4 Guide Bar Separately
Handle sold separately. See Pages 253 - 257

ANDERSEN AWNING OPERATORS

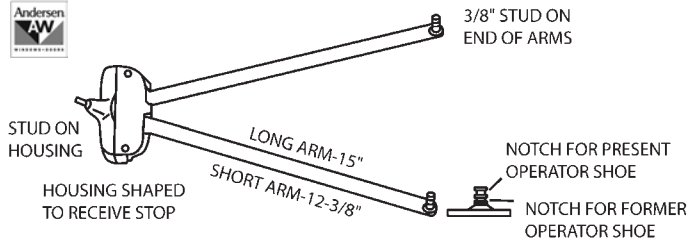

750-0338908

Shoe Sold Separately

Part #	Finish	Arm Length	Handle Only
750-0333808	Bronze	12-3/8"	750-1361358
750-0333908	Bronze	15"	750-1361358

Comes Complete with Handle and Rods

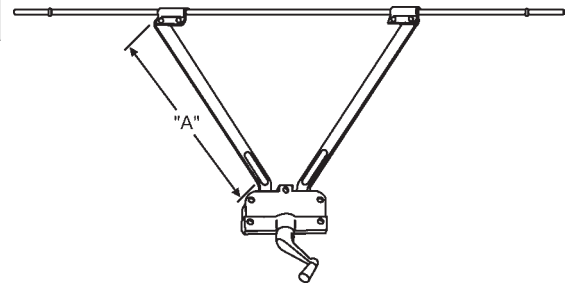

Part #	Finish	A	Handle Only
750-1521604	Stone	11"	750-0532408
750-1521606	Stone	15"	750-0532408

Includes Rods, Brackets and Screws

Handle sold separately. See Pages 253 - 257

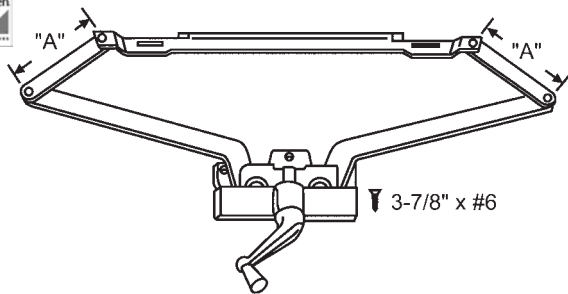

This operator is no longer available.
Replace with 750-1521608 Operator and use Brackets in
Place of Existing Track.

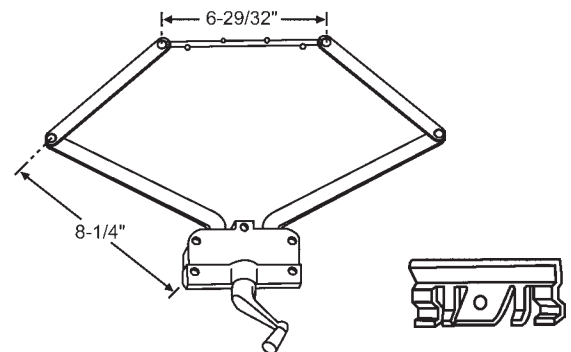

Part #	Finish	Handle Only
750-1521608	Stone	750-0532408

Includes Bracket and Screws.

Handle sold separately. See Pages 253 - 257

WINDOW REPLACEMENT HARDWARE

SILL MOUNTED AWNING OPERATORS

ROTO AWNING OPERATORS

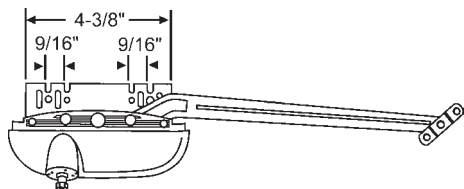

Part #	Finish
36-484AD	Almond
36-484BEW	Blue White
36-484EW	Euro White
36-484W	White

Awning Operator with 10" Arm
Handle sold separately. See Pages 253 - 257

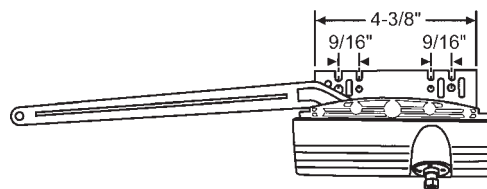

Part #	Finish
29-208BEW	Blue White
29-208BG	Beige

Awning Operator with 10" Arm
Handle sold separately. See Pages 253 - 257

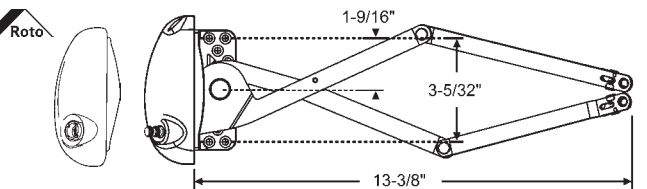

Pro-Drive X-Drive

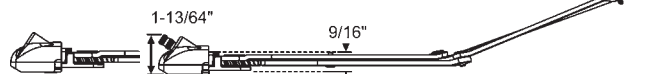

Part #	Finish	Style
29-253W-XD	White	X-Drive
29-253DBR	Dark Brown	Pro-Drive
29-253EB	Earth Brown	Pro-Drive
29-253EW	G1 White	Pro-Drive
29-253AD	Almond	Pro-Drive

For Vinyl Window Application.
Handle sold separately. See Pages 253 - 257

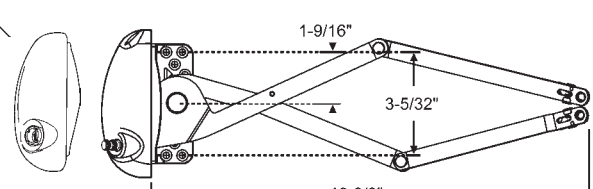

Pro-Drive X-Drive



Part #	Finish	Style
29-254W-XD	White	X-Drive
29-254W	White	Pro-Drive

Notched for Wood Window Application.
Handle sold separately. See Pages 253 - 257

MISCELLANEOUS AWNING OPERATOR

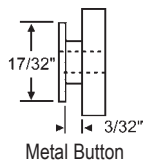
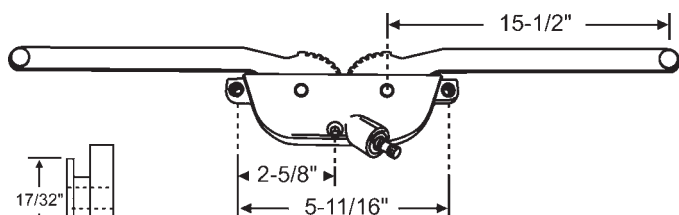

Part #	Finish
29-111	Bronze

Dual Arm Operator for Wood Windows. Handle Included

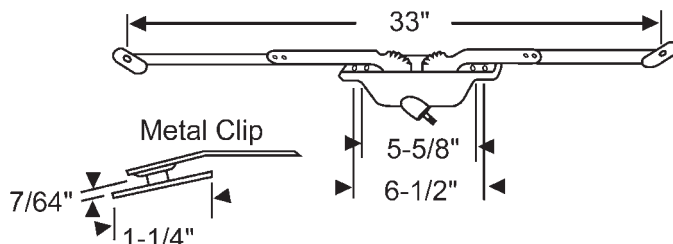

Part #	Finish
29-102	Aluminum

WINDOW REPLACEMENT HARDWARE

MILL FINISH AWNING OPERATORS - MIAMI TYPE

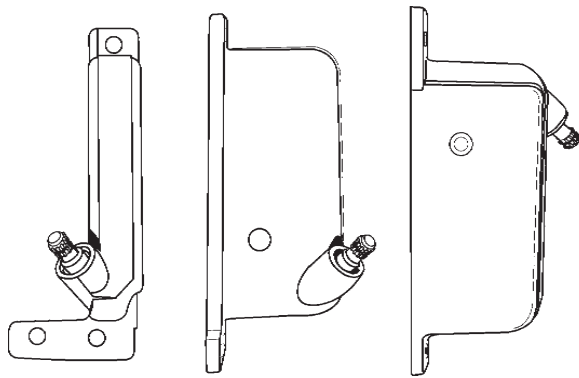
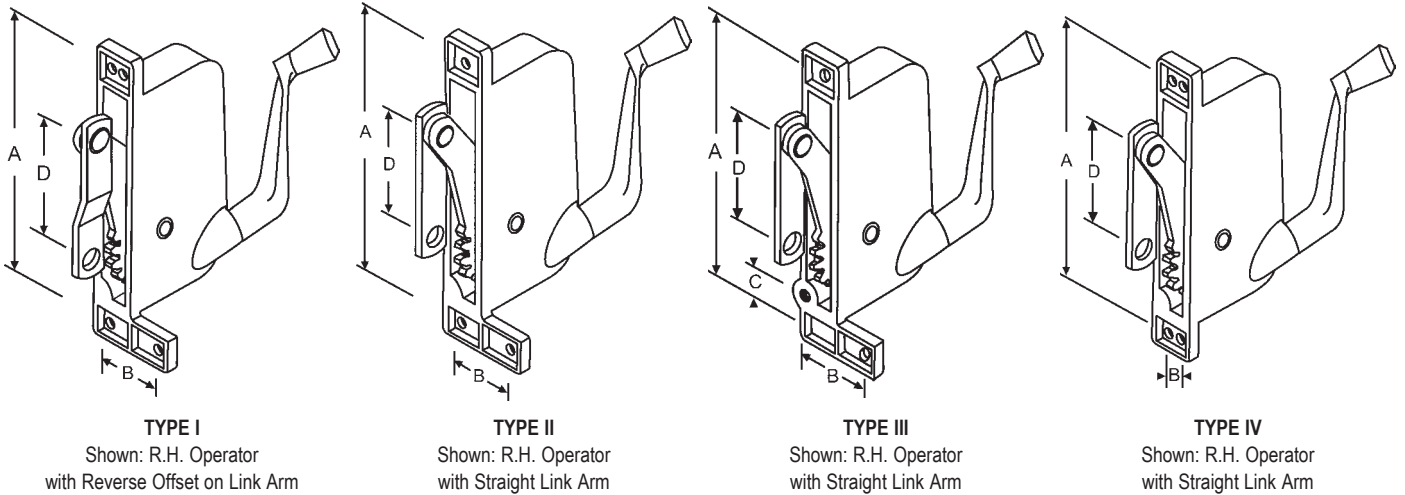

Classic Style Awning Operator - Part Numbers Ending in HD

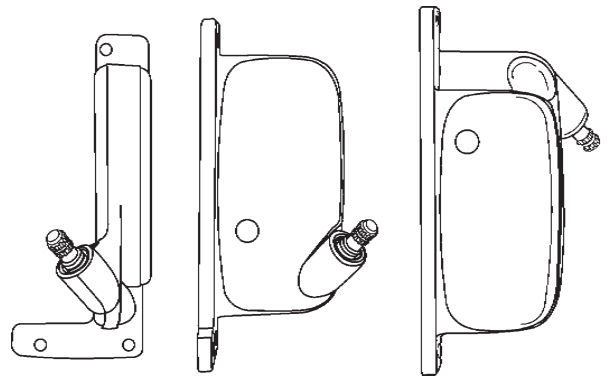

Contemporary Style Awning Operator - Part Numbers Ending in D

RH Part #	LH Part #	Window Name	Housing Type	Dim "A"	Dim "B"	Dim "C"	Dim "D"	Straight/Offset	Link End
41-200P D	41-201P D	Pan American	I	5-1/4"	1-5/16"	N/A	2-5/8"	S	5/16-18 Thread
41-207P D	41-206P D	Stanley	I	5-1/4"	1-3/8"	N/A	2-3/16"	OS	3/8 Hole
41-259P D	41-260P D	Lenahan	I	5-1/4"	13/16"	N/A	2-11/16"	S	3/8 Hole
41-271P HD	41-270P HD	Yale - Ogron	I	5-1/4"	7/8"	N/A	2-3/16"	S	3/8 Hole
41-296P D	41-295P D	Ware	I	5-1/4"	7/8"	N/A	2-3/16"	OS	3/8 Hole
41-205P D*	41-204P D*	Keller - Air Control - PGT	II	5-1/4"	1-1/8"	N/A	2-5/16"	S	1/4-20 Thread
41-214P D	41-215P D	ABC	II	5-1/4"	1-1/4"	N/A	2-7/16"	S	3/8 Hole
41-230P D*	41-231P D*	Look - Rusco	II	5-1/4"	1-3/8"	N/A	2-7/16"	S	1/4-20 Thread
41-257P D*	41-258P D*	Tucker	II	5-1/4"	1-1/4"	N/A	2-3/8"	S	10-24 Thread Bushing
41-263P D	41-264P D	Nu-Aire	II	5-1/8"	15/16"	N/A	2-5/8"	S	3/8 Hole
41-395P D	41-396P D	Stanley - CE	II	5-1/4"	1-3/8"	N/A	2-3/16"	OS	3/8 Hole
41-636P D	41-637P D	Remington - Silver Line	II	5-1/4"	1-1/8"	N/A	2-7/16"	S	10-24 Thread Bushing
41-211P D	41-210P D	Miami	III	5-1/8"	1-1/2"	1/2"	2"	OS	5/16-18 Thread
41-212P D	41-213P D	ABC	III	5-1/16"	1-7/16"	1/2"	2-3/16"	S	1/4 E-Ring Stud
41-232P HD	41-233P HD	Superior	III	5-1/16"	1-7/16"	1/2"	2-1/8"	S	5/16-18 Thread
41-234P D	41-235P D	Crown	III	5-1/6"	1-7/16"	1/2"	2-1/4"	S	3/8 Hole
41-236P D*	41-237P D*	Tucker	III	5-1/16"	1-7/16"	1/2"	2-1/2"	S	10-24 Thread Bushing
41-388P D	41-387P D	Harcar	III	5-1/16"	1-7/16"	1/2"	2-7/16"	OS	5/16-18 Thread
41-457P D	41-455P D	VE Anderson	III	5-1/16"	1-7/16"	1/2"	2-1/2"	OS	3/8 Hole
41-223P D*	41-224P D*	Look - Rusco	IV	5-1/4"	7/16"	N/A	2-1/8"	S	5/16-18 Thread

For Additional Sizes and Colors Contact Your Account Manager. Items Above also Available Carded

* Top hole is offset, not centered.

WINDOW REPLACEMENT HARDWARE

JALOUSIE OPERATORS

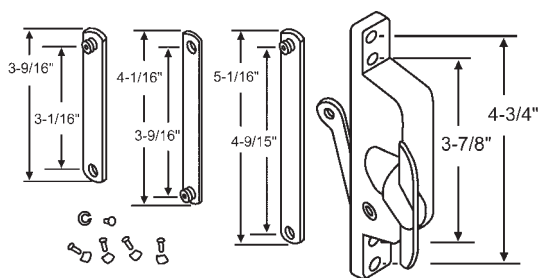

Part #	Finish
41J-4000PK	Aluminum
41J-4000PKW	White

Universal Jalousie Operator Kit

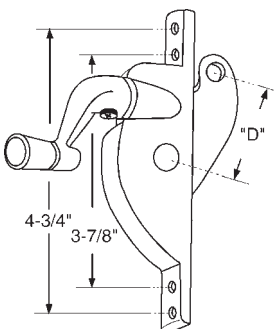

Part #	Packaging	Finish	Hand	Link	"D"
41J-208P	Bagged	Aluminum	Shown		1-1/2"
41J-209P	Bagged	Aluminum	Opposite		1-1/2"
41J-242P	Bagged	Aluminum	Opposite		2"
41J-243P	Bagged	Aluminum	Shown		2"
41J-809P	Bagged	Aluminum	Opposite		1-1/4"
41J-810P	Bagged	Aluminum	Shown		1-1/4"
41J-882P	Bagged	Aluminum	Shown	3" Link	1-1/2"
41J-883P	Bagged	Aluminum	Opposite	3" Link	1-1/2"

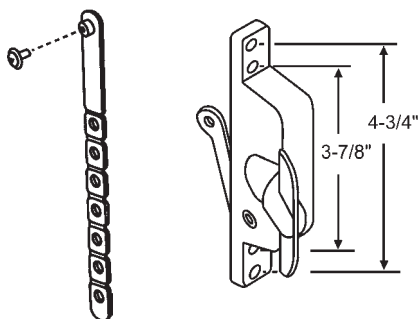

Part #	Finish
29-160	Aluminum
29-161	Bronze

Break-Away Operator Kit, Includes Screws

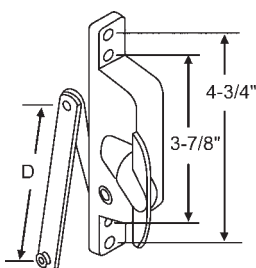

Part #	Packaging	Finish	Description	"D"
41J-300P	Bagged	Aluminum	Air Control	3-1/32"
41J-300PB	Bagged	Bronze	Air Control	3-1/32"
41J-300PW	Bagged	White	Air Control	3-1/32"
41J-301P	Bagged	Aluminum	Stanley	3-11/32"
41J-302P	Bagged	Aluminum	ABC	1-23/32"
41J-303P	Bagged	Aluminum	Pan Am	3-5/8"
41J-303PB	Bagged	Bronze	Pan Am	3-5/8"
41J-303PW	Bagged	White	Pan Am	3-5/8"
41J-441P	Bagged	Aluminum	Look	3-5/8"
41J-464P	Bagged	Aluminum	Superior	4"
41J-464PB	Bagged	Bronze	Superior	4"
41J-464PW	Bagged	White	Superior	4"
41J-1421P	Bagged	Aluminum	Crown	4-1/2"
41J-3338P	Bagged	Aluminum	Nu Air	4-1/4"

AWNING AND JALOUSIE ACCESSORIES

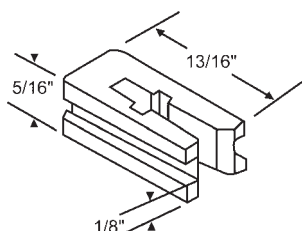

33-138

Awning Window Guide
Nylon

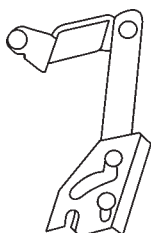

28-91

Awning Vent Hinge
Assemblies (Pair)
BINNINGS PAN AM

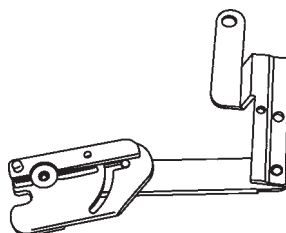

900-9732

Vent Hinge (Pair)
ANDERSON

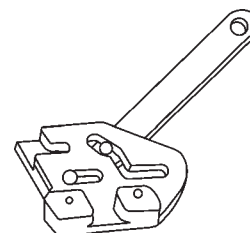

900-236

Harcar Lock Assembly (Pair)
HARCAR

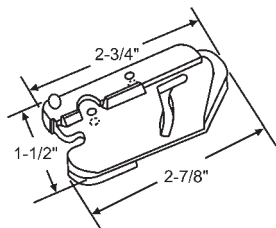

33-142

Vent Lock - Pair

ANDERSON

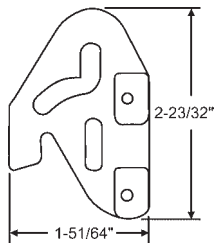

33-123

Natural Nylon Cam Lock
with Rivets
HARCAR

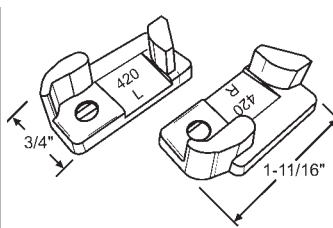

900-299

Black Plastic Awning Window Vent Lock
Set (RH/LH)

STANLEY

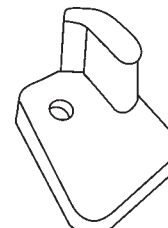

900-300

Top Vent Lock (Pair)

STANLEY

WINDOW REPLACEMENT HARDWARE

AWNING AND JALOUSIE ACCESSORIES

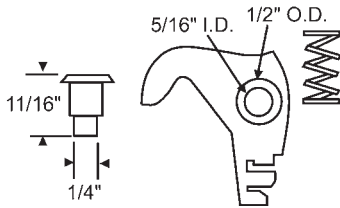

900-7949

Bottom Nylon Vent Hook Set
(2 Guides, 2 Rivets, 2 Springs)

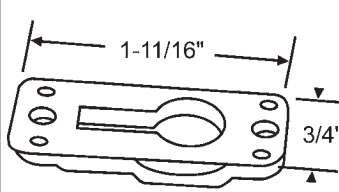

900-301

Control Bracket
Use with 900-301C Cam
STANLEY

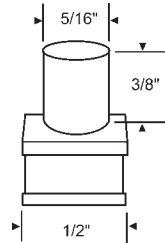

900-304

Locking Pin

AIR CONTROL

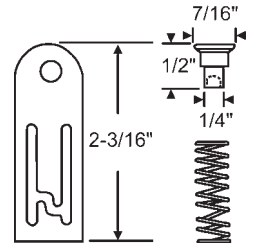

900-9874

Locking Spring/Guide Set

CROSSLY

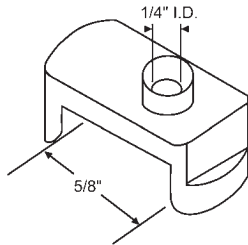

33-124

Draw Bar Bearing

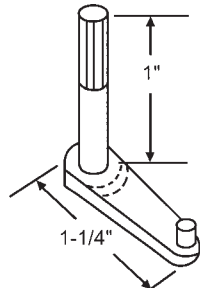

33-134

Cline Link

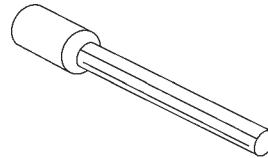

Part #	Color
33-122AL	Aluminum
33-122BZ	Bronze
33-122W	White

6" Standard Length Cut to Size in Field.
Male 5/16" Hex to 3/8" Female Spline.

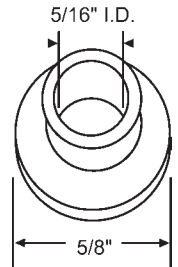

900-20934

Nylon Bushing

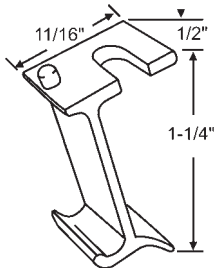

900-10447

Sliding Window Pivot Bracket
ACORN

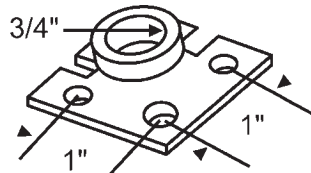

526P

Torque Bar Bearing
LUDMAN

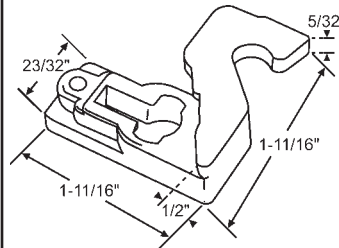

33-126

Vent Lock

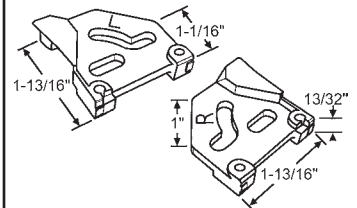

1924X

Vent Lock Set. White
NU-AIR

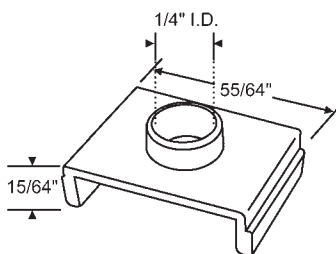

33-129

Slide Bar Guide
Plastic
AIR CONTROL

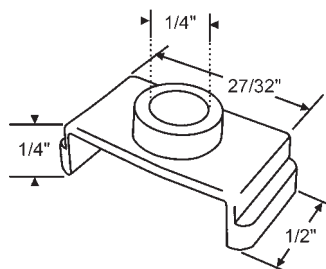

1932P

Slide Bar Guide
NU-AIR

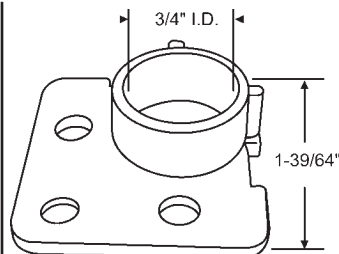

900-259

Torque Bar Bearing
Plastic
MIAMI

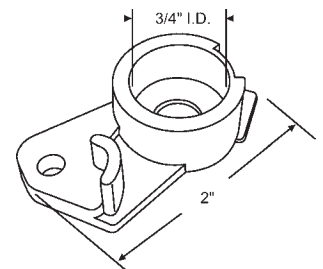

900-279

Torque Bar Bearings (Pair)
Plastic
STANLEY

WINDOW REPLACEMENT HARDWARE

AWNING AND JALOUSIE ACCESSORIES

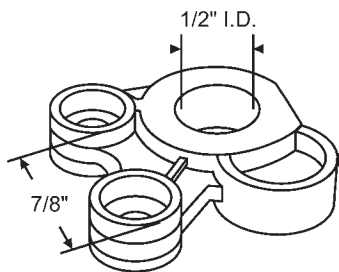

900-275
Torque Shaft Bearing
CROSSLY

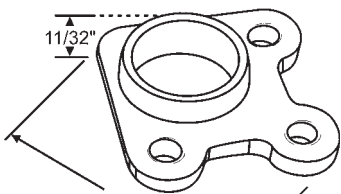

900-271
Torque Bar Bearings
SILVER LINE



900-267
Torque Bar Bearings

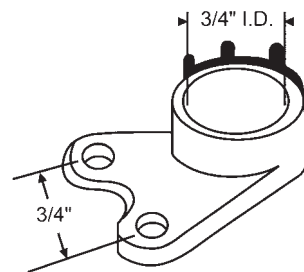

900-282
RH/LH Torque Bar Bearings (Set)

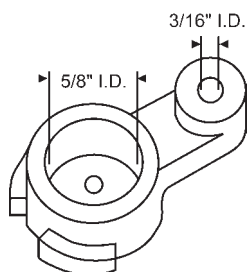

33-125
Torque Bar Bearing

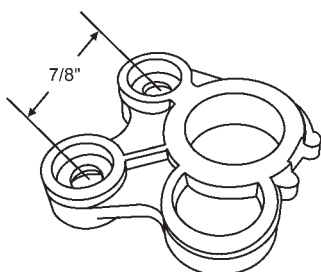

900-274
Torque Shaft Bearing

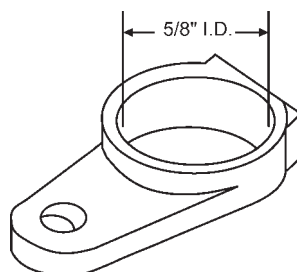

900-6903
Torque Bar Bearing

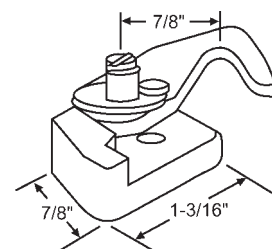

33-107
Block Hook Assembly
Nylon Base with Aluminum Hook
Sold in Sets Only
KELLER

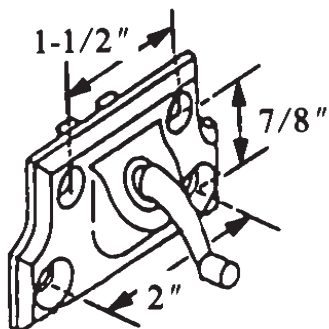

900-7349
Center Operator with Handle
100 Series
UALCO

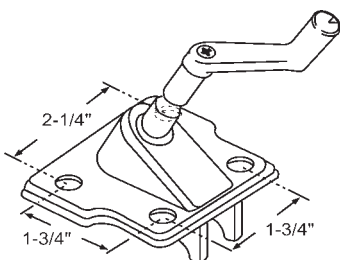

900-7967
Center Operator with Handle
200 Series
UALCO

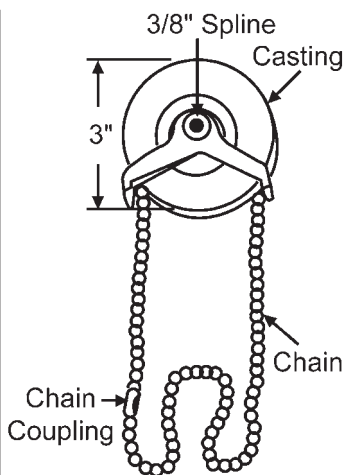

Part #	Description
33-146	Chain Wheel Only
33-135	#13 Large Chain
33-136	Chain Coupling

#13 chain sold by the foot. All items need to be ordered separately

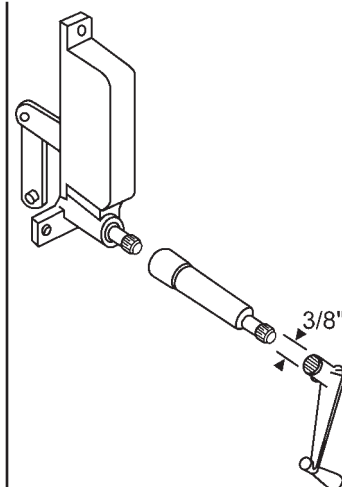

Part #	Extension	Finish
37-161-6AL	6"	Aluminum
37-161-6W	6"	White
37-161-2AL	2"	Aluminum

ATW Extension Link Only
Male to Female 3/8" Spline.

WINDOW REPLACEMENT HARDWARE

AWNING AND JALOUSIE ACCESSORIES

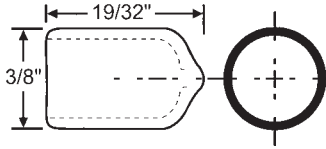

39-449
Plastic Spline Cap. Red

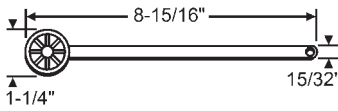

900-20144
Basement Hopper Roller Guide

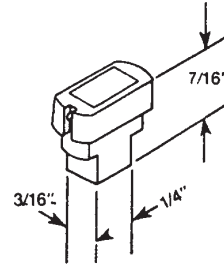

33-112
Die Cast Balance Arm Button

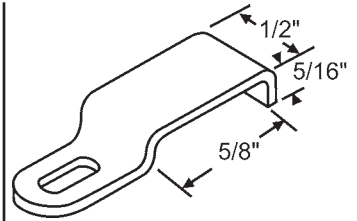

Part #	Finish
33-101W	White
33-101BZ	Bronze

KELLER

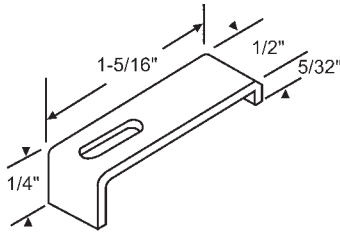

33-100W
White Panel Clip

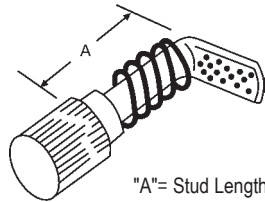

"A" = Stud Length

Part #	"A"
33-105	7/8"
900-12157	1"
900-12158	3/4"

Panel Screw. Aluminum

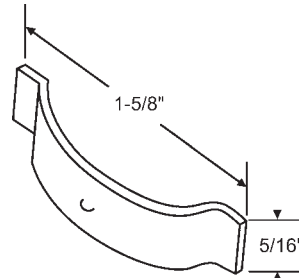

900-16054
Stamped Steel Spring Clip
CLEARVIEW

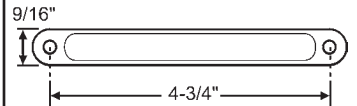

Part #	Finish
900-15138	Aluminum
900-15138BZ	Bronze
900-15138W	White

Cover Plate
PAN AM

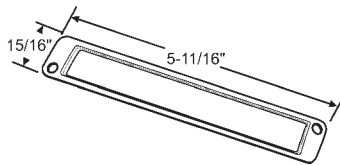

Part #	Finish
33-128	Mill
33-128W	White
33-128BZ	Bronze

Cover Plate. Offset Hole

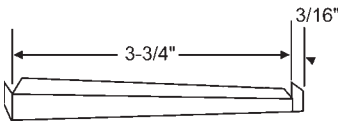

900-15108
Jalousie Wedge.
Sold in Pairs Only (RH & LH)
ARNOLD ALTEX

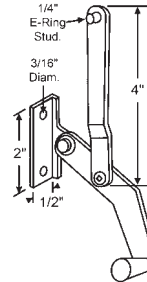

Part #	Hand
900-21293RH	Shown
900-21293LH	Opposite

Push Operator

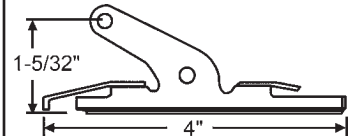

Part #	Finish
JWC-002-ML	Mill
JWC-002-WH	White

Jalousie Clip
PAN-AM / LOOK

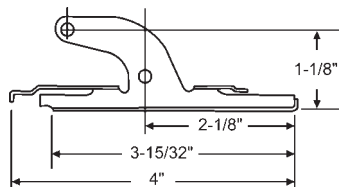

Part #	Finish
900-7713	Aluminum

Sold in Sets Only (1 Right & 1 Left Clip)

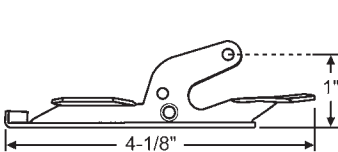

33-180
Aluminum. Sold in Pairs
AIR MASTER

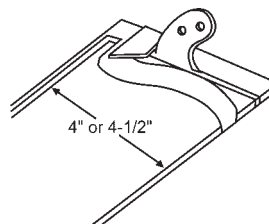

Part #	Glass Size	Length
33-111-4	4"	3-1/16"
33-111-4 1/2	4-1/2"	3-3/8"

Security Clips. Stainless Steel Clips Apply Pressure and Prevent Glass Removal from Outside. One Clip Under Each End Bracket Affords Extra Security.

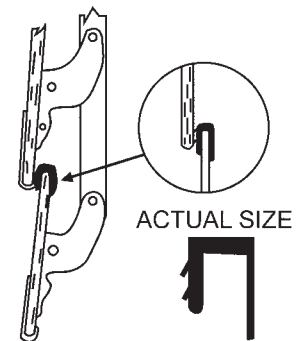

33-106
Jalousie Seal. 36' per Bag.
Seals Out The Drafts

WINDOW REPLACEMENT HARDWARE

3/4" ALUMINUM AWNING WINDOW TORQUE BAR ASSEMBLIES

Typical Torque Bar Assembly

Many Types in Stock
Minimum Order Required
for Non-Stocked Items

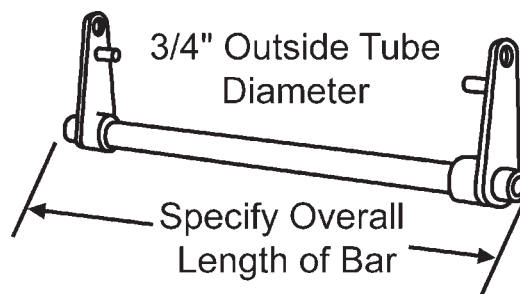

Part #	Manufacturer
33-113	Yale Ogron
33-151	Superior/Miami
33-152	Airelok
33-153	Old Tropical
33-154	Stanley 45
33-155	Pan Am/Daryl
33-156	ABC
33-157	Old Air Control
33-158	Anderson

Part #	Manufacturer
33-159	Keller/Air Control
33-160	Old Ware
33-161	Miami Highlander
33-162	Wallace
33-163	Stanley
33-164	Ludman
33-165	Old Crossly
33-166	Old Tucker
33-178	Security
33-183	Stanley Narrow Vent

Ordering Instructions

1. Identify manufacturers name of torque bar arms from drawings below
2. Match manufactures name from torque bar assembly chart and choose part number.
3. Measure length of bar including torque bar arms.
4. To create part number, combine #2 and #3.

Example

- Torque bar arm matches manufacturer Yale Ogron
- Yale Ogron matches torque bar assembly Part Number 33-113
- Length of bar including torque bar arms is 25-1/2"
- Order part number 33-113-25-1/2

Ordering Instructions: Identify manufacturer, then specify overall length, including torque bar arm.





TORQUE BAR ARMS

(Available Separately)

<p>900-12807 YALE OGRON</p>	<p>33-167 SUPERIOR/MIAMI</p>	<p>33-168 AIRELOK</p>	<p>33-169 OLD TROPICAL</p>	<p>33-133 PAN AM/DARYL</p>	<p>900-21437 ABC</p>
<p>900-8283 OLD AIR CONTROL</p>	<p>900-22269 ANDERSON</p>	<p>900-11364 KELLER/AIR CONTROL</p>	<p>33-172 OLD WARE</p>	<p>33-173 MIAMI/HIGHLANDER</p>	
<p>33-174 WALLACE</p>	<p>900-331 STANLEY</p>	<p>33-175 LUDMAN</p>	<p>33-176 OLD CROSSLY</p>	<p>33-177 OLD TUCKER</p>	

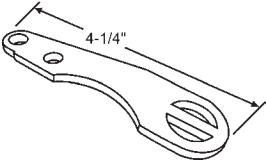
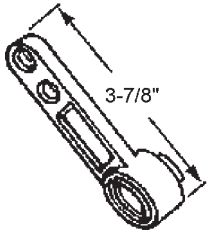
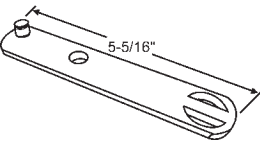
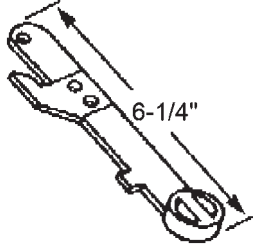
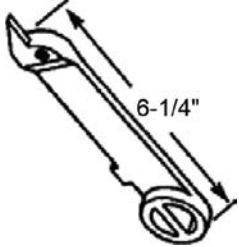
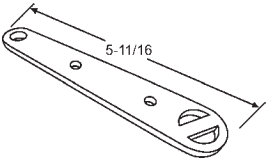
WINDOW REPLACEMENT HARDWARE

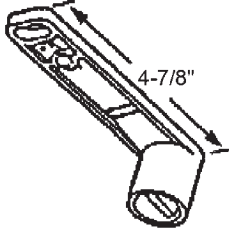
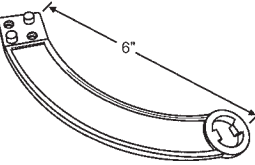
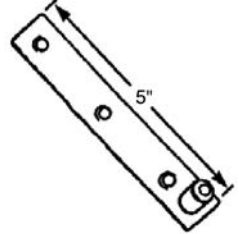
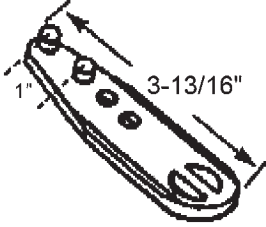
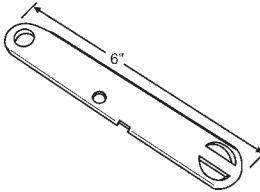
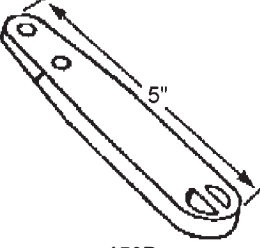
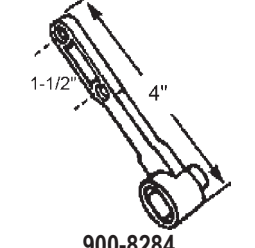
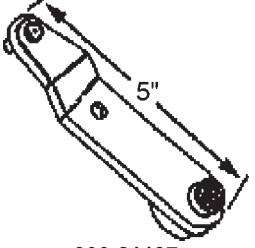
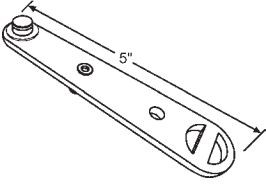
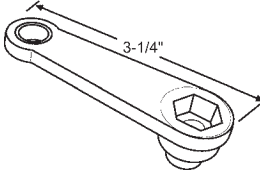
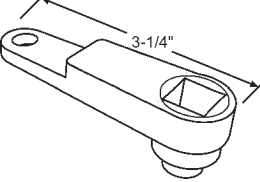
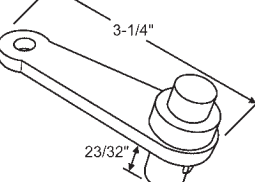
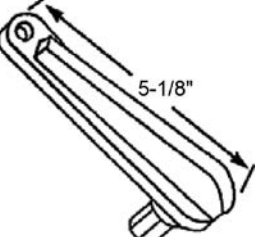
TORQUE BAR ARMS

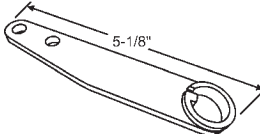
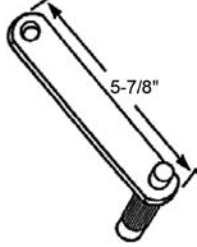
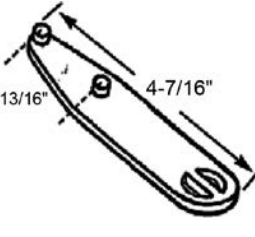
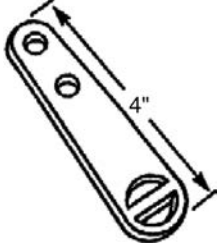
 <p>33-179 SECURITY</p>	 <p>547P Die Cast ARNOLD/ALTEX</p>	 <p>640P Pair DURAL</p>	 <p>900-9997 Pair UALCO SERIES 300</p>	 <p>900-7660 Pair UALCO SERIES 200</p>
 <p>644P UNIVERSAL</p>	 <p>AWT 10</p>	 <p>105P LOOK</p>	 <p>467P Pair MIAMI RADIAL ARM</p>	 <p>AWT 18</p>
 <p>638P STANLEY NARROW VENT</p>	 <p>439P PALM BEACH</p>	 <p>150P HAR CAR</p>	 <p>900-8284 Die Cast AIR CONTROL OLD SLOT</p>	 <p>900-21137 VE ANDERSON MODEL 405</p>
 <p>900-21435 NU-AIRE</p>	 <p>900-21003H GENERAL HEX</p>	 <p>900-21003 SQUARE</p>	 <p>900-21433 GENERAL ROUND</p>	 <p>AWT 50 ORIGINAL AWN-WIN</p>
 <p>AWT 52 No Longer Available KELLER '90</p>	 <p>142P ARNOLD ALTEX</p>	 <p>AWT 56</p>	 <p>AWT 61 WILLIAMS</p>	 <p>AWT 64 AIR MASTER</p>

WINDOW REPLACEMENT HARDWARE

CASEMENT AND AWNING OPERATOR BRACKETS

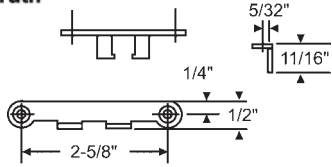

Part #	Description
39-364	E-Gard Finish

Sash Hook

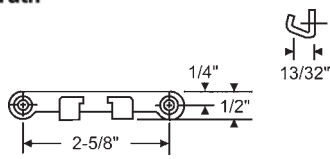

Part #	Description
39-1	E-Gard Finish
39-1CG	Coast-Gard Finish

Sash Hook for Lever Operator

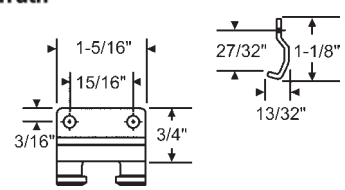

39-241

Center Hook for Lever Operator

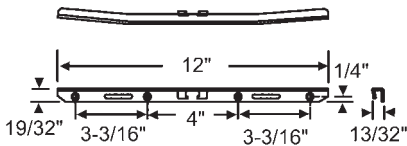

Part #	Description
39-2	E-Gard Finish
39-2CG	Coast-Gard Finish

Torsion Bar for Lever Operator

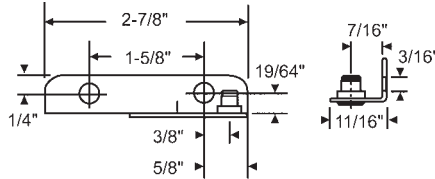

Part #	Hand
39-409	Shown
39-410	Opposite

Dual Arm Operator Bracket. E-Gard Finish

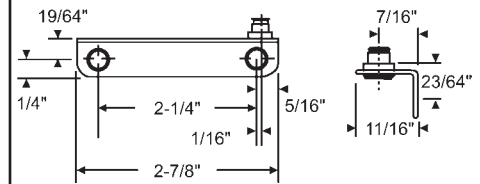

Part #	Hand
39-412	Opposite

Dual Arm Operator Bracket. E-Gard Finish

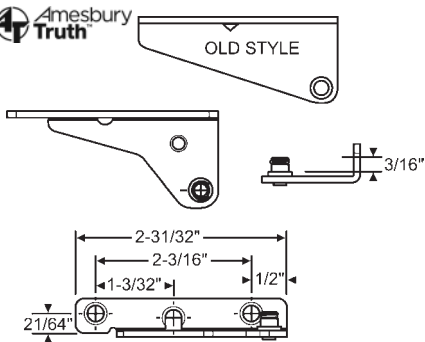

Part #	Hand
39-299	Shown
39-298	Opposite
39-299CG (Coast-Gard)	Shown
39-298CG (Coast-Gard)	Opposite

Clip-on Type

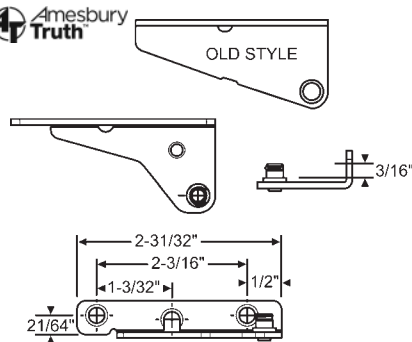

Part #	Hand
39-21	Shown
39-21SS (Stainless Steel)	Shown
39-22	Opposite
39-22SS (Stainless Steel)	Opposite

Snap-on Type

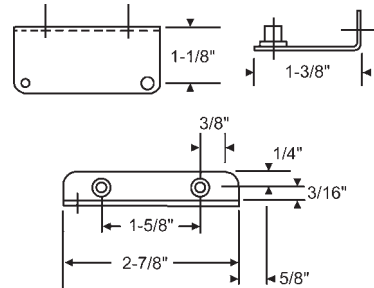

Part #	Hand
39-9 (E-Gard)	Shown
39-10 (E-Gard)	Opposite
39-9CG (Coast-Gard)	Shown
39-10CG (Coast-Gard)	Opposite

Stud Bracket

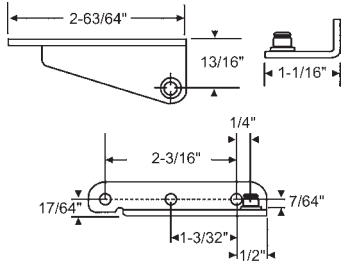

Part #	Hand	Clip Type
39-534 (E-Gard)	Shown	Snap Stud
39-535 (E-Gard)	Opposite	Snap Stud
39-534CG (Coast-Gard)	Shown	Snap Stud
39-535CG (Coast-Gard)	Opposite	Snap Stud

Stud Bracket

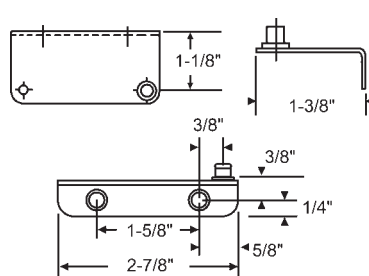

Part #	Hand
39-65	Shown
39-66	Opposite

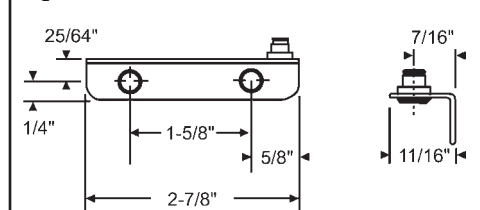

Part #	Hand
39-5	Shown
39-6	Opposite
39-5SS (Stainless Steel)	Shown
39-6SS (Stainless Steel)	Opposite

Stud Bracket

WINDOW REPLACEMENT HARDWARE

CASEMENT AND AWNING OPERATOR BRACKETS

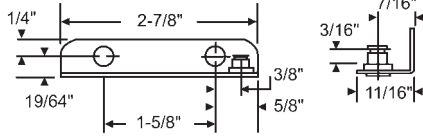

Part #	Hand
39-7	Shown
39-8	Opposite

Stud Bracket

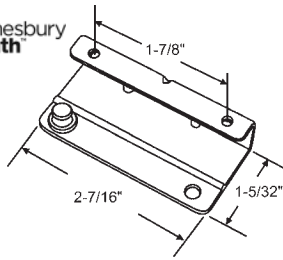

Part #	Hand
39-48	Shown
39-49	Opposite

Stud Bracket

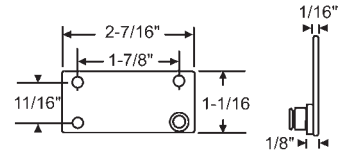

Part #	Hand
39-50	Shown
39-51	Opposite

Stud Bracket

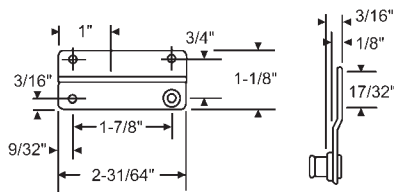

Part #	Hand
39-52	Shown
39-53	Opposite

Stud Bracket

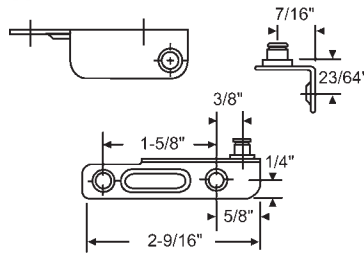

Part #	Hand
39-15	Shown
39-16	Opposite

Stud Bracket

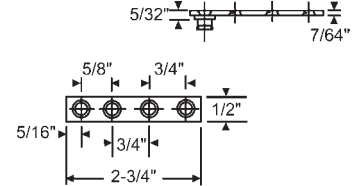

Part #	Material	Description
39-64	E-Gard	No Snap Stud
39-64CG	Coast-Gard	No Snap Stud
39-403	E-Gard	With Snap Stud
39-403CG	Coast-Gard	With Snap Stud

Non-Hand

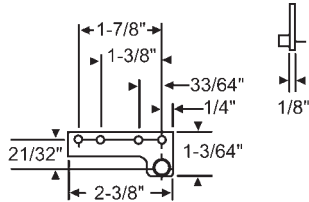

Part #	Hand
39-569	Shown
39-570	Opposite

Stud Bracket

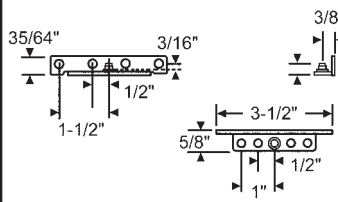

39-418
Non-Hand Snap Stud Bracket

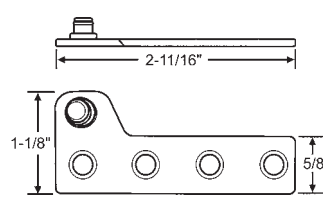

Part #	Hand
39-460	Shown
39-461	Opposite

Snap Stud Bracket

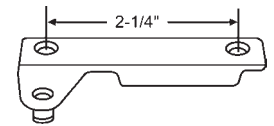

Part #	Hand
750-1361208	Shown
750-1361210	Opposite

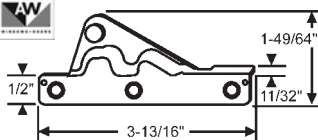

Part #	Hand	Type
750-1361409	Shown	Standard
750-1361408	Opposite	Standard
750-1361411	Shown	Corrosion Resistant
750-1361410	Opposite	Corrosion Resistant

Sash Bracket for 750-1361484

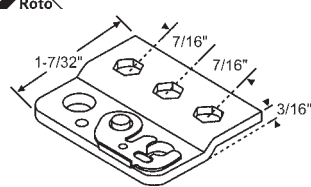

Part #	Hand
39-737LH	Shown
39-737RH	Opposite

Sash Bracket

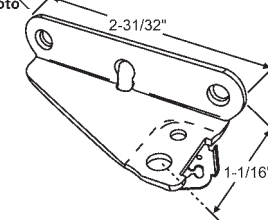

Part #	Hand
39-698	Shown
39-699	Opposite

Sash Bracket Assembly. 35mm,
Face Mount

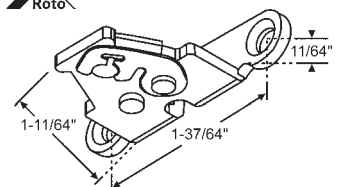

Part #	Hand
39-700	Shown
39-701	Opposite

Sash Bracket Assembly. 30mm,
Face Mount

WINDOW REPLACEMENT HARDWARE

CASEMENT AND AWNING OPERATOR BRACKETS

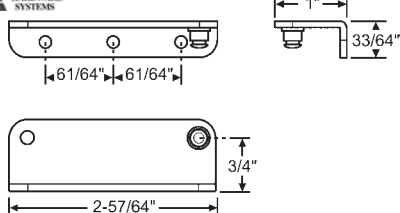

Part #	Hand
39-900LH	Shown
39-900RH	Opposite

Bracket

FENESTRATOR

Sash Window Hardware (Window Assistance)



39-234
MIGHTON



Heavy modern sash windows can sometimes be difficult for the elderly or disabled to operate, excluding them from enjoying the classic design of sash windows. With an aging population the need for a cost effective, innovative, solution has never been greater. Fenestrator is the answer, a manually operated system that allows the heaviest sliding sash window - timber or PVCU - to be opened easily. A key benefit of Fenestrator is that it can be retrofitted without the need for any specialist skills.

OPERATOR COVERS



MAXIM® OPERATOR COVER

Plastic Nesting Cover for Maxim® Operators

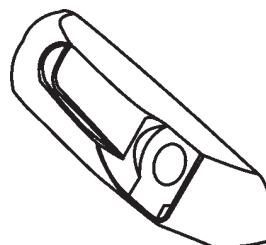
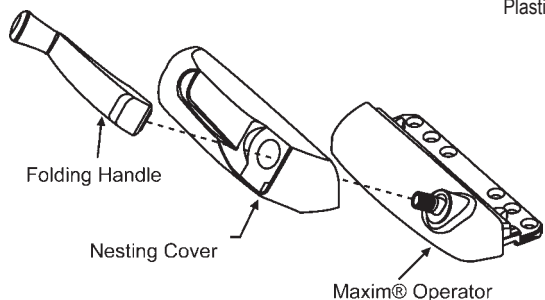

Handle Sold Separately
37-109FH

Converts Crank Handle to Folding Handle.
Just Snap on Top of Operator.

Part #	Hand	Finish
36-368NCV-1	Shown	Bronze
36-369NCV-1	Opposite	Bronze
36-368NCV-3	Shown	White
36-369NCV-3	Opposite	White

Furnished with Double Sided Tape
Pre-Applied to Cover for Attaching Cover
to Maxim® Operator

TRUTH'S ENCORE™ TANGO FOLDING HANDLE & COVER

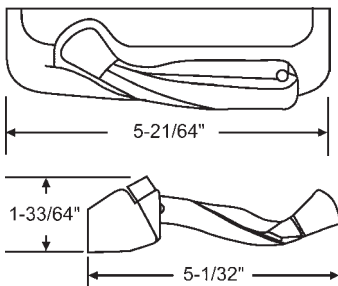

Part #	Hand	Finish
37-215-1	Shown	Bronze
37-216-1	Opposite	Bronze
37-215-3	Shown	White
37-216-3	Opposite	White
37-215-71	Shown	Oil Rubbed Bronze

ENTRYGARD FOLDING HANDLE & COVER

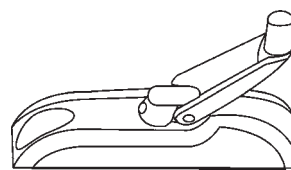

Non-Hand. Fits All Entrygard Products

Converts Crank Handle to a Folding
Handle. Just Remove Handle & Cover,
and Install over Operator.

Part #	Finish
37-220-3	White
37-220-1	Bronze

Folding Handle System.
Other Finishes Available

AMESBURYTRUTH™ CONTEMPORARY COVER & HANDLE FOR ENCORE OPERATORS



AmesburyTruth™ has created a new Contemporary Cover and Handle for our Encore casement operator. It features a sleek, straight-line design with fresh modern colors.

This product sets the standard for our Contemporary family of products. Combine the new handle and cover with our Maxim, Signature, or Sentry products for a unified Contemporary look throughout the home.

The Contemporary Cover and Handle has the similar appearance of the AmesburyTruth™ Low Profile Encore Lock.

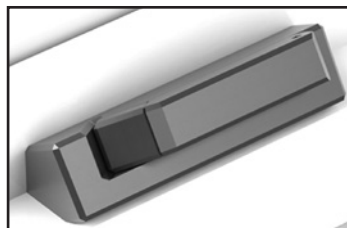

Key Features & Benefits

- Fits on all Encore operators
- Metal cover and handle
- Adds a contemporary look to other AT products
- Modern and Sleek Design
- Painted and plated options available

Part #	Hand	Finish
37-266-79	RH	Matte Black
37-265-79	LH	Matte Black
37-266-51	RH	Faux Oil Rubbed Bronze
37-265-51	LH	Faux Oil Rubbed Bronze
37-266-10	RH	Black
37-265-10	LH	Black
37-266-36	RH	Antique Brass
37-265-36	LH	Antique Brass
37-266-3	RH	White
37-265-3	LH	White

WINDOW REPLACEMENT HARDWARE

OPERATOR COVERS

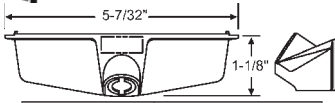

Part #	Finish
36-173CV-1	Bronze
36-173CV-3	White
36-173CV-5	Brass
36-173CV-6	Clay
36-173CV-8	Chestnut Bronze
36-173CV-9	Beige
36-173CV-14	Cocoa Brown
36-173CV-15	Off-White
36-173CV-29	Bright White
36-173CV-87	Gold (New)

Plastic

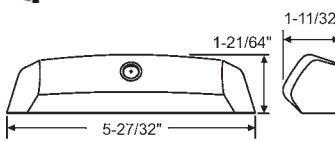

Part #	Finish
36-173MC-1	Bronze
36-173MC-3	White
36-173MC-38	Tuscan Bronze
36-173MC-71	Oil Rubbed Bronze

Metal

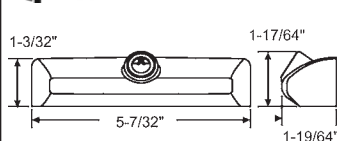

Part #	Finish
36-173PCV-1	Bronze
36-173PCV-2	Gold
36-173PCV-3	White

Plastic Contour Cover

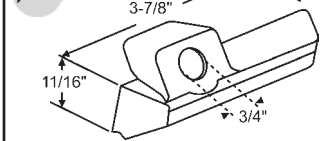

Part #	Hand	Finish
36-201LH	Shown	Copperite
36-201RH	Opposite	Copperite
36-201LHW	Shown	White
36-201RHW	Opposite	White
36-201LHCHP	Shown	Champagne
36-201RHCHP	Opposite	Champagne

Square Cover

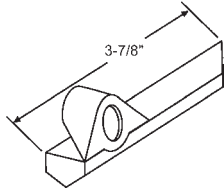

Part #	Hand	Finish
36-202LHW	Shown	White
36-202RHW	Opposite	White
36-202LHCHP	Shown	Champagne
36-202RHCHP	Opposite	Champagne
36-202LHBP	Shown	Bright Brass Plated
36-202RHBP	Opposite	Bright Brass Plated

Round Cover

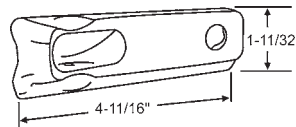

Part #	Hand	Finish
36-219RHCHP	Shown	Champagne
36-219LHCHP	Opposite	Champagne
36-219RHBP	Shown	Bright Brass Plated
36-219LHBP	Opposite	Bright Brass Plated
36-219RHW	Shown	White
36-219LHW	Opposite	White

Integrated Folding Handle Cover

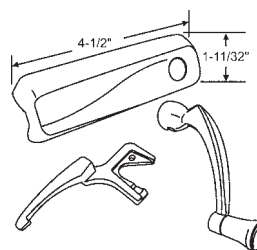

Part #	Hand	Finish
36-505LHW	Shown	White
36-505RHW	Opposite	White

Crank Kit

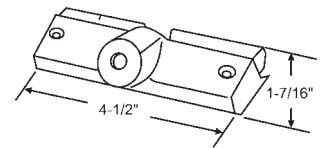

Part #	Finish
750-0532610	Stone
750-1351330	White

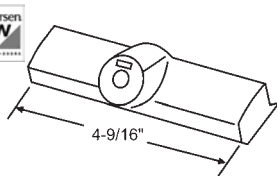

Part #	Finish
750-0532608	Stone

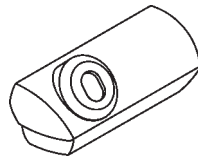

Part #	Finish
750-1361530	Stone
750-1361529	White

Classic Style



Part #	Finish
750-1361531	Stone
750-1361532	White

Metro Style

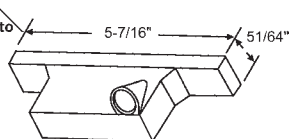

Part #	Hand	Finish
36-333CV-54	Shown	Brown
36-333CV-28	Shown	Almond
36-333CV-1	Shown	Bronze
36-333CV-10	Shown	Black

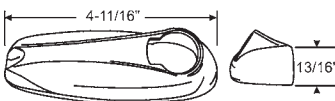

Part #	Hand	Finish
37-225BCH	Shown	Bright Chrome
37-226BCH	Opposite	Bright Chrome
37-225BRS	Shown	Brass Plated
37-226BRS	Opposite	Brass Plated
37-225ORBZ	Shown	Oil Rubbed Bronze
37-226ORBZ	Opposite	Oil Rubbed Bronze

Metal. Other Finishes Available

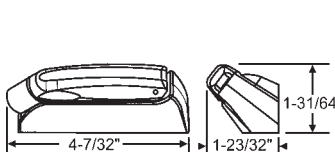

Part #	Hand	Finish
37-254LW	Shown	White
37-254RW	Opposite	White

Cover Only.
Order Handle Separately #37-240

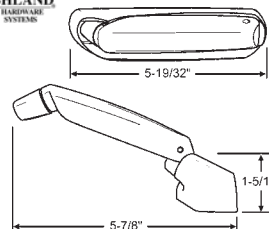

Part #	Hand	Finish
37-248W	Opposite	White
37-249W	Shown	White
37-248BZ	Opposite	Bronze
37-249BZ	Shown	Bronze

Handle and Cover

CRANK HANDLES

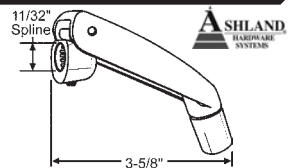

Part Number	Finish
37-239DP	Dark Pewter Plated
37-239ORBZ	Oil Rubber Bronze Plated
37-239PB	Polished Brass Plated
37-240BZ	Bronze Painted
37-240G	Gold Painted
37-240SBZ	Satin Bronze Painted
37-240W	White Painted

Operator Folding Handle

WINDOW REPLACEMENT HARDWARE

CRANK HANDLES

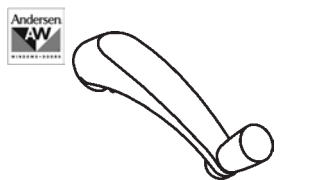

Part #	Finish
750-1361358	Stone
750-1361356	White

Classic Crank Handle with 3/8" Spline. Used with Classic Operator Cover 750-1361530



Part #	Finish
750-1361360	Stone
750-1361362	White

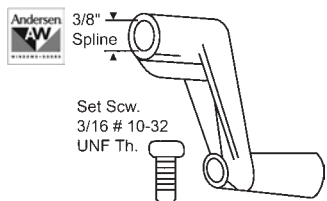

Part #	Finish
750-0532308	Bronze

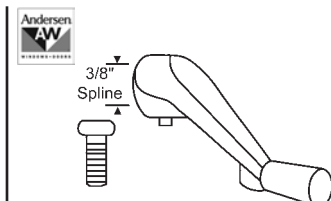

Part #	Finish
750-0532408	Stone
750-1351332	White

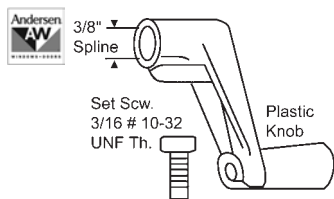

Part #	Finish
750-1361008	Silver

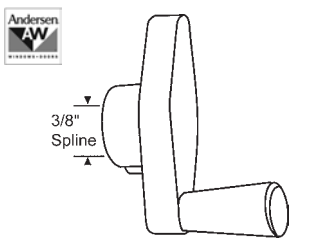

Part #	Finish
750-1361804	Stone
750-1351334	White

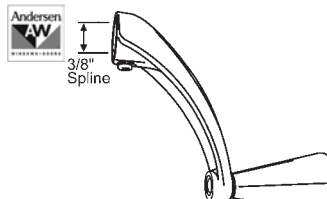

Part #	Finish
750-1361378	Stone
750-1361377	White

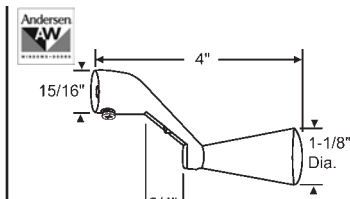

Part #	Finish
750-1361806	Stone
750-1351335	White

Easy Grip Handle

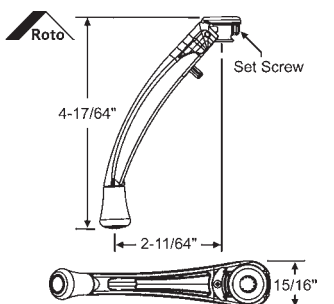

Part #	Finish
37-224W	White
37-224BCH	Bright Chrome
37-224BRS	Brass Plated
37-224ORBZ	Oil Rubbed Bronze
37-224BEW	Blue White

Folding Handle For X-Drive Operators. Other Finishes Available.

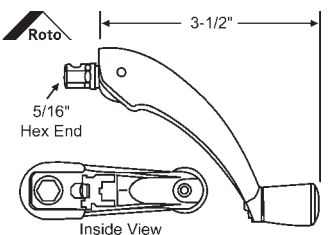

Part #	Finish
37-221BEW	Blue White
37-221W	White
37-221AD	Almond
37-221DBR	Dark Bronze
37-221EB	Earth Brown
37-221LAD	G2 Almond
37-221ORBZ	Oil Rubbed Bronze
37-221SV	Silver
37-221EW	G2 White

Folding Handle For Roto Pro Drive Operators

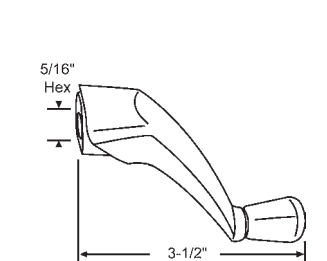

Part #	Finish
37-213BEW	Blue White
37-213AD	Almond
37-213CY	Clay
37-213EW	Euro White
37-213W	White

Folding Handle
ROTO/INTERLOCK

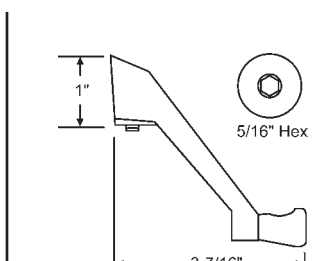

Part #	Finish
37-157W	White
37-157BEW	Blue White
37-157	Almond

With Set Screw
ROTO/INTERLOCK

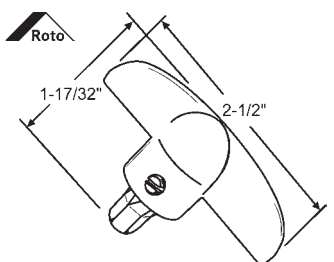

Part #	Finish
37-227W	White

Fits Old Style OP05 Pro Drive Operators

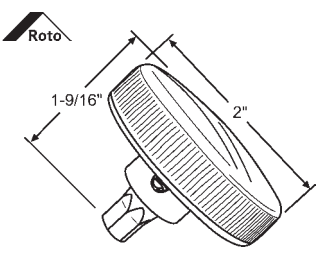

Part #	Finish
37-241W	White

Fits Old Style OP05 Pro Drive Operators

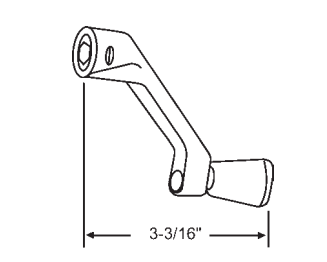

Part #	Finish
37-159WH	White
37-159	Aluminum

Fits Roto Operators 36-333SP, 36-334SP
5/16" Hex

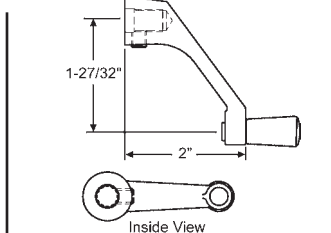

Part #	Finish
900-8890H	White Bronze w/ Stainless Steel Knob
900-8890HDBZ	Dark Bronze
900-8890HRBZ	Red Bronze
900-8890HWBZ	White Bronze

Fits Roto #900-8890 Operators

WINDOW REPLACEMENT HARDWARE

CRANK HANDLES

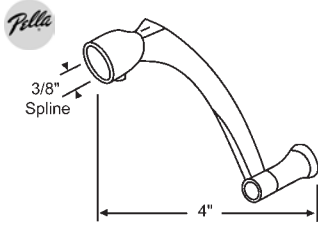

Part #	Finish
900-8869	Copperite
900-8869CH	Champagne
900-8869WH	White
900-8869BR	Brass Plated

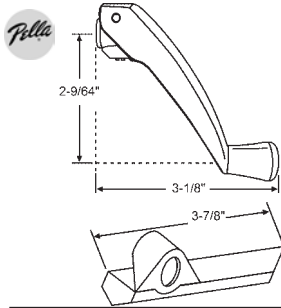

Part #	Finish
900-8869BR-F	Brass
900-8869CH-F	Champagne

Folding Handle and Cover Kit

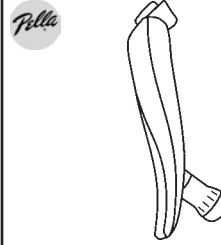

Part #	Finish
37-207W	White
37-207CHP	Champagne
37-207BP	Brass Plated

Integrated Crank Handle

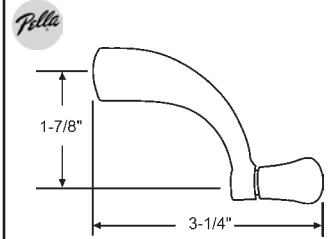

Part #	Finish
37-201-45	Blue White

TRUTH OPERATOR HANDLES (ONLY FIT TRUTH 11/32" SPLINE)

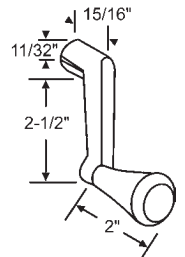
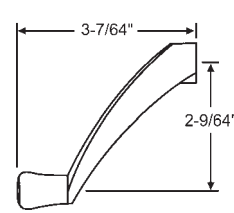
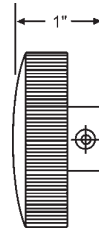
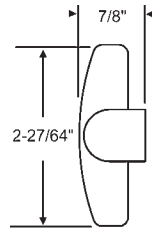
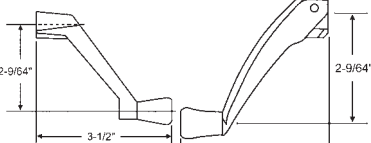
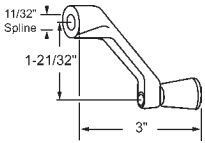

37-109 Old Style
Replace with 37-137

Snap Fit

Finish	Long	Folding	"T"	Round	Contour Handle	ADA
Bronze	37-137-1	37-109FH-1	37-125-1	37-138-1	37-150-1	37-149-1
Gold			-	37-138-2		-
White	37-137-3	37-109FH-3	37-125-3	37-138-3	37-150-3	37-149-3
Brass	37-137-5	37-109FH-5	-	-	37-150-5	37-149-5
Clay	37-137-6	37-109FH-6	-	37-138-6	37-150-6	-
Aluminum	37-137-7	37-109FH-7	37-140-7	37-138-7	37-150-7	-
Chestnut Bronze	37-137-8	37-109FH-8	37-140-8	37-138-8	37-150-8	37-149-8
Beige	37-137-9	37-109FH-9	-	37-138-9	37-150-9	37-149-9
Medium Bronze	37-137-12	-	-	-	-	-
Brush Copper Nickel	37-137-13	37-109FH-13	-	-	37-150-13	37-149-13
Off-White	37-137-15	37-109FH-15		-	-	37-149-15
Black	37-137-10	37-109FH-10	37-140-10	-	37-150-10	-
Coppertone	-	37-109FH-75	-	37-138-75	37-150-75	-
Cocoa Brown	37-137-14	-	37-140-14	-	37-150-14	-
Satin Nickel	37-137-21	37-109FH-21	37-140-21	37-138-21	37-150-21	37-149-21
Bright White	37-137-29	37-109FH-29	37-140-29	-	37-150-29	-
Tuscan Bronze	37-137-38	37-109FH-38	-	-	37-150-38	-
Oil Rubbed Bronze	37-137-71	37-109FH-71	37-140-71	-	37-150-71	-
Gold (New)	37-137-87	37-109FH-87	-	-	37-150-87	-

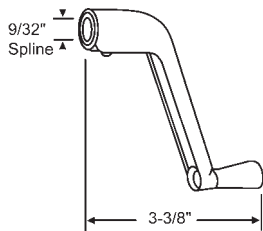

Part #	Finish
900-9690	Driftwood
900-9690W	White
900-9690B	Polished Brass

PEACHTREE

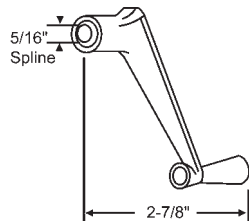

Part #	Finish
37-102	Aluminum
37-103	Light Bronze

DORCHESTER

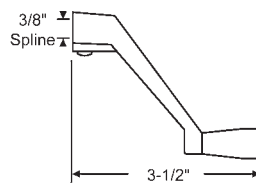

Part #	Finish
37-212	Aluminum
37-212BZ	Bronze
37-212W	White

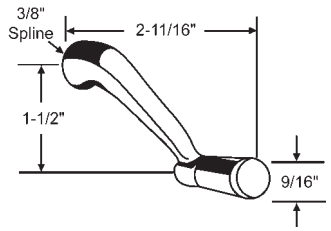

Part #	Finish
37-100	Aluminum
37-101	Brown
37-100W	White
37-101B	Bronze

WINDOW REPLACEMENT HARDWARE

CRANK HANDLES

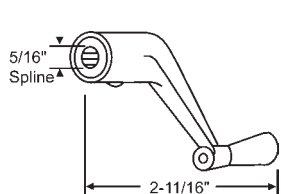

Part #	Finish
37-112	Aluminum
37-111	Brown
37-112DBZ	Dark Bronze
37-112W	White

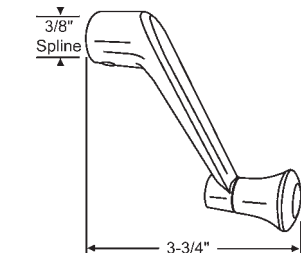

Part #	Finish
37-210	Mill
37-210W	White

YALE

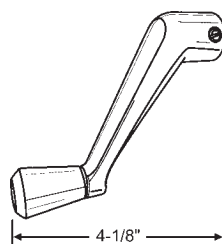

Part #	Finish
900-10708	Silver

7/16" Crank Handle

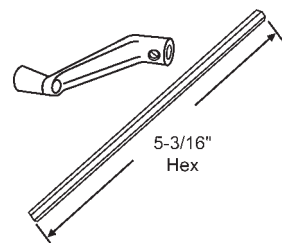

Part #	Finish
37-147	Mill

5/16" Hex Handle and Shaft

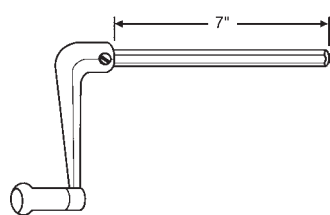

Part #	Finish
900-10738	Mill

5/16" Hex Handle and Shaft

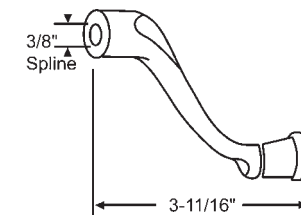

Part #	Finish
37-104	Aluminum
37-104W	White
37-105	Brown

For Awning Operators

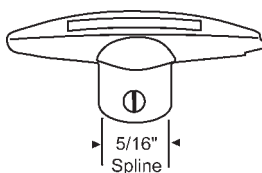

Part #	Finish
37-120	Mill
37-120B	Bronze

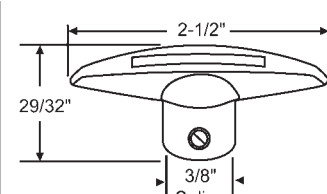

Part #	Finish
37-119	Aluminum
37-119B	Bronze
37-119W	White

Fits Old Style Steel Casement Operators

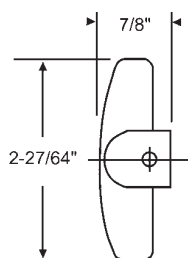

Part #	Finish
37-125-1	Bronze
37-125-3	White
37-125-4	Coppertone
37-125-8	Chestnut Bronze
37-125-9	Beige

Fits All Truth Operators with 11/32" Spline

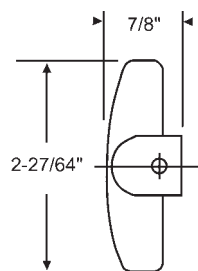

"T" Handle

Part #	Fits Mfg.	Spline Style	Finish
37-126	Andersen	3/8"	Stone
37-123	Peachtree	9/32"	Driftwood
37-123W		9/32"	White
37-113	Old Style Steel Casement	3/8"	Aluminum
37-113W	Old Style Steel Casement	3/8"	White
37-113B	Old Style Steel Casement	3/8"	Brown
37-106	Old Style Steel Casement	5/16"	Aluminum
37-106BR	Old Style Steel Casement	5/16"	Brown
900-161	Jalousie	5/16"	Aluminum
37-127	Jalousie	7/16"	Bronze

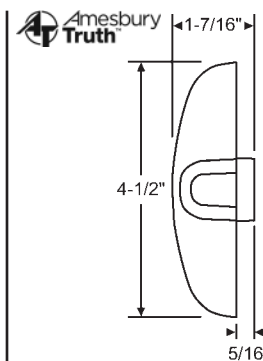

37-236

Black Plastic Construction Tee Handle
PGT

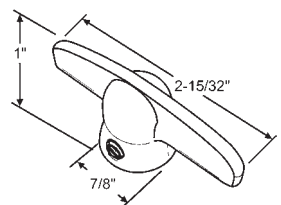

Part #	Spline Style	Finish
37-124	3/8 - 11	Copperite
37-124W	3/8 - 11	White
37-124CH	3/8 - 11	Champagne

Fits Pella

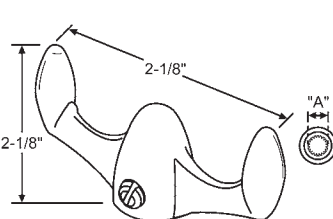

Part #	A
900-7837	5/8"
900-7837-3/8	3/8"

Aluminum Finish
PARLYN

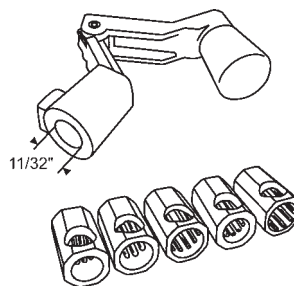

Fit-All Folding Handle Kit. Includes 5 adapters: 11/32", 5/16", 3/8", 9/32", 3/8" special. Will fit Truth, Andersen, Pella, Peachtree and various old style casement and jalousie operators

Part #	Finish
37-165U-2	Gold
37-165U-24	Brown
37-165U-3	White
37-165U-7	Aluminum
37-165U-75	Coppertone
37-165U-9	Beige
37-165U-MTBZ	Metallic Bronze

WINDOW REPLACEMENT HARDWARE

CRANK HANDLES

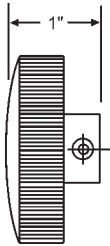

Round Hand Knob

Part #	Fits Mfg.	Spline Style	Finish
37-133	Pella	3/8-11	Copperite
37-133W		3/8-11	White
37-133-35		3/8-11	Champagne
37-129	Andersen	3/8	Stone (Dark Gray)
37-129W		3/8	White
37-128	Peachtree	5/16	Light Brown

PUSH BARS

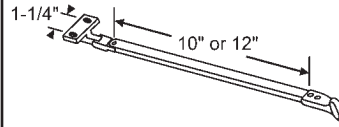

Part #	Length
29-105-10A	10"
29-105-12A	12"

Aluminum

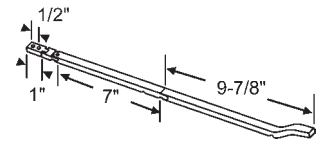

29-107
Aluminum

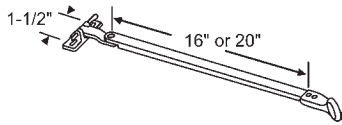

Part #	Length
29-109-20	20"

Aluminum Bar with Nickel Bronze Ends

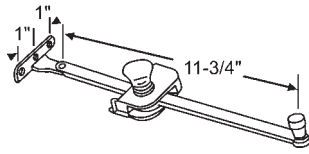

Part #	Hand
36-120	Shown
36-121	Opposite

Solid Brass Housing & Push Bar with Bracket. 29-110 Available Upon Request
FENESTRA

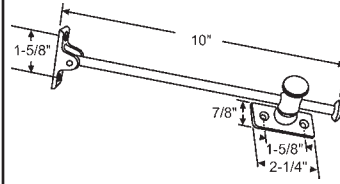

Part #	Length
900-339SNK	Satin Nickel
900-339BRS	Bright Brass

Casement Adjuster

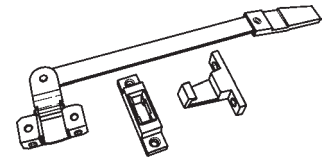

29-270
Red R/V Push Bar Assembly
KINRO

TELESCOPING PUSH BARS



Anderberg 44AL Series For Aluminum Windows

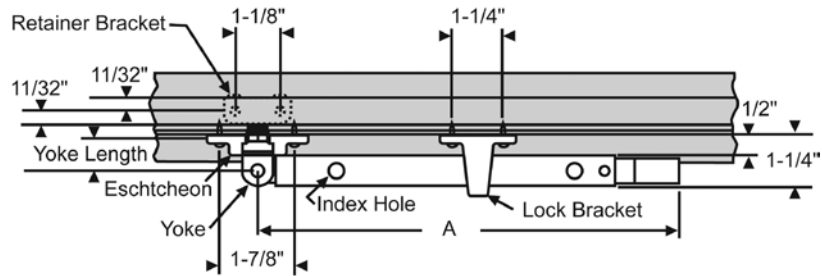

These Items Can Be Purchased Separately

39-158-7
Nylon Escutcheon

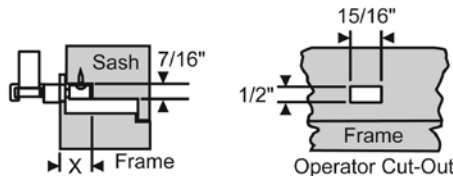

Truth Part #	Our Part #	X Dimension	Yoke Length	A Dimension		Finish
				Closed	Extended	
12.40.00.100	29-131-7	15/16"	25/32"	10-1/2"	16-1/4"	Aluminum
12.41.00.100	29-132-7	1"	27/32"	10-1/2"	16-1/4"	Aluminum
12.46.03.100	29-137-1	1-9/16"	1-13/32"	8"	11"	Bronze

WINDOW REPLACEMENT HARDWARE

TELESCOPING PUSH BARS



Anderberg 44WD Series For Wood Windows

This Item Can Be
Purchased Separately
39-158-7
Nylon Escutcheon

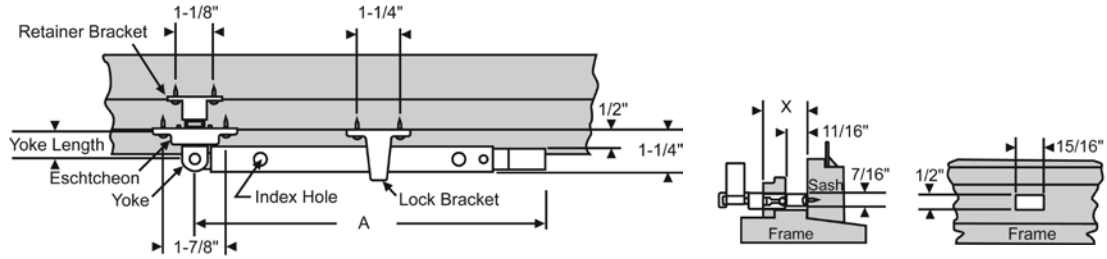

Truth Part #	Our Part #	X Dimension	Yoke Length	"A" Closed	"A" Extended	Finish
12.50.00.100	29-145-7	1"	27/32"	8"	11"	Aluminum
12.52.00.100	29-150-7	1-7/16"	1-9/32"	8"	11"	Aluminum

VENT ARMS WITH BRACKETS

Our machine shop facilities can duplicate a variety of sizes and shapes of vent arms.

The drawings below are just a representation of the various vent arms that are available. Please send us your sample so we can provide an exact replacement.

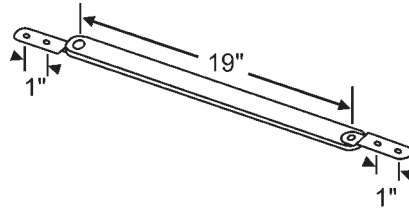
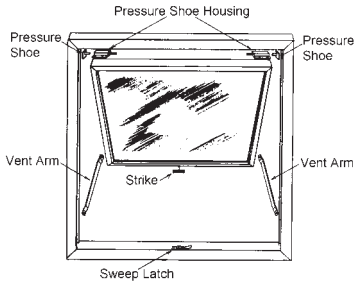

28-50
2 Brackets. Aluminum

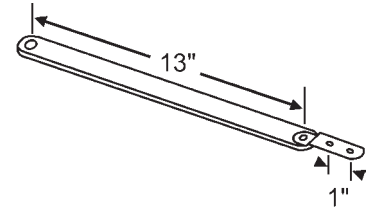

28-51
1 Bracket. Aluminum

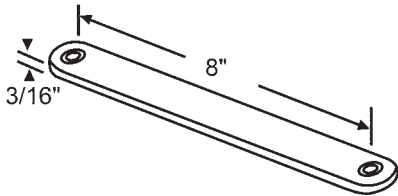

28-52
Aluminum
Bushing Only: 8-361

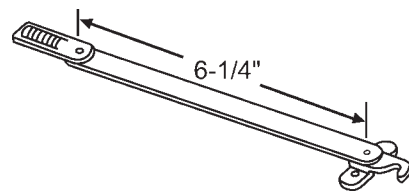

28-53
Aluminum with Nylon End Piece and Hook. Set Includes
Right Hand and Left Hand

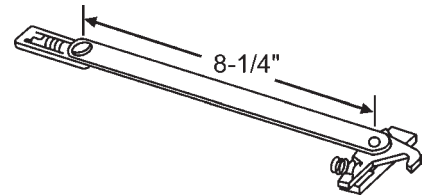

28-61
Aluminum with Nylon End Piece and Hook. Set Includes
Right Hand and Left Hand

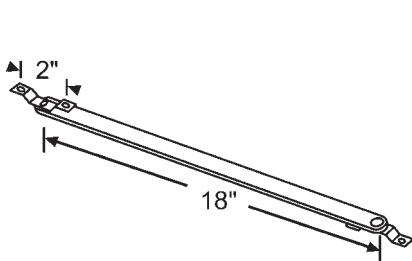

28-55
Aluminum

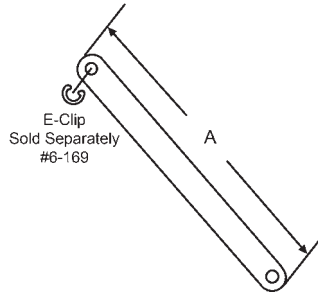

Part #	Description	A
28-79A	for 24" Wide Vent	6-1/2"
28-79B	for 18" Wide Vent	3-1/2"
28-79C	for 30" to 36" Wide Vent	9-7/16"

Drag Arm
PEACHTREE

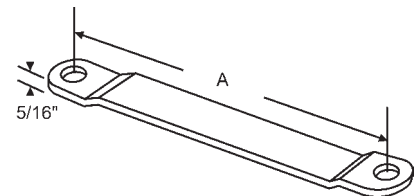

Part #	"A"
900-10601	7-3/4"
900-10602	18-1/4"

Aluminum

WINDOW REPLACEMENT HARDWARE

PRESSURE SHOES, FRICTION SHOES & HOUSINGS

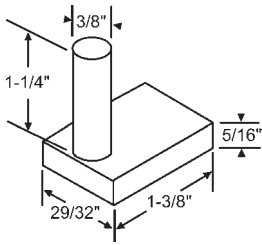

26-118

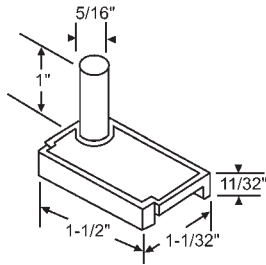

Part #	Hand
26-121	Shown
26-120	Opposite

Nylon Shoes

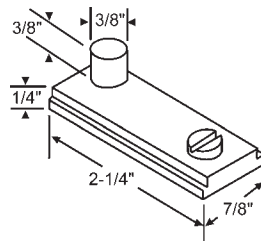

Part #	Hand
26-59	Shown
26-58	Opposite

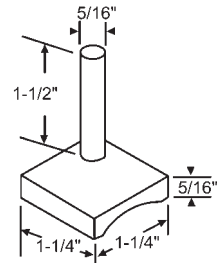

Part #	Hand
26-66	Shown
26-65	Opposite

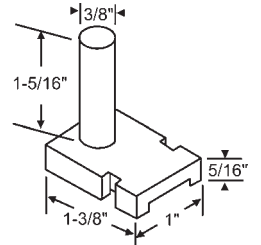

26-68
Notched

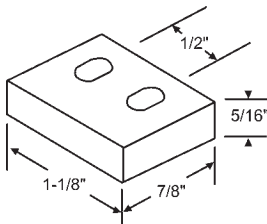

26-76
Housing Only

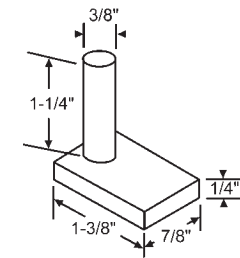

Part #	Hand
26-111	Shown
26-110	Opposite

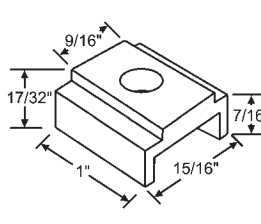

26-100

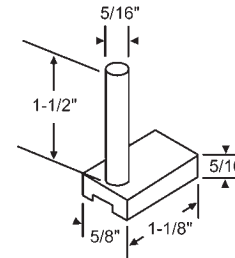

26-101

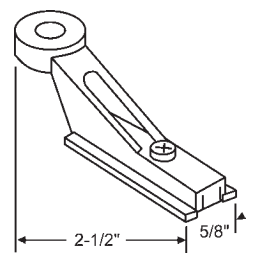

26-102

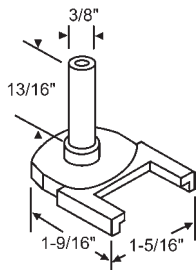

26-103
Used with Bushing 8-361

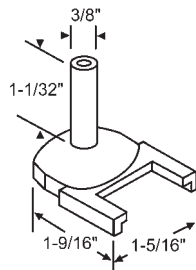

26-104

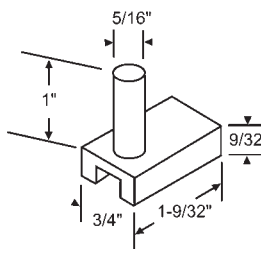

26-105

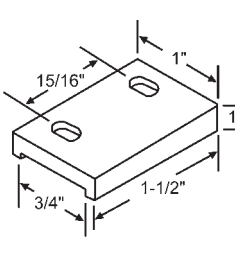

26-116

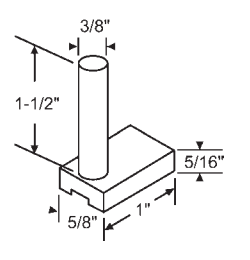

26-117

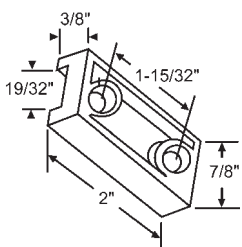

26-123

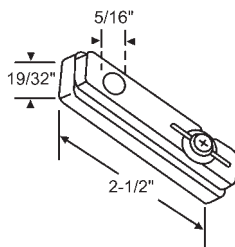

26-122

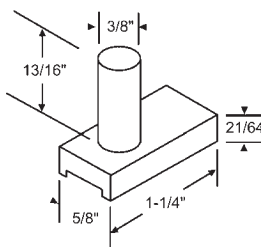

26-55
Metal Pin

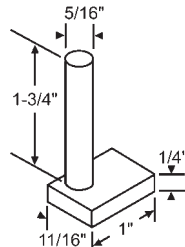

Part #	Hand
26-57	Shown
26-56	Opposite

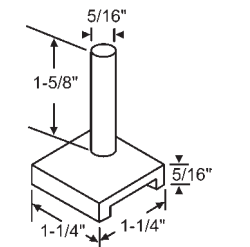

Part #	Hand
26-63	Shown
26-62	Opposite

WINDOW REPLACEMENT HARDWARE

PRESSURE SHOES, FRICTION SHOES & HOUSINGS

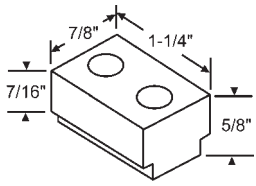

26-67
Aluminum

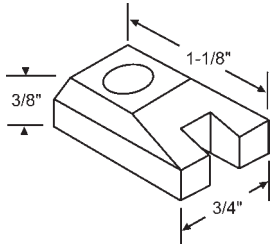

26-74

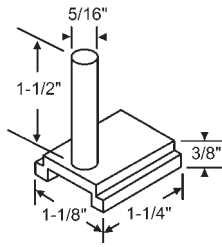

26-69

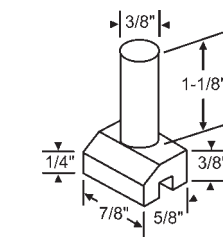

Part #	Base Type
26-72	Nylon

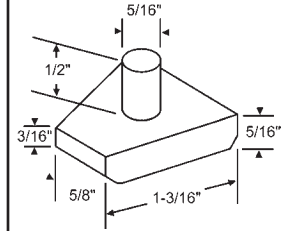

26-81

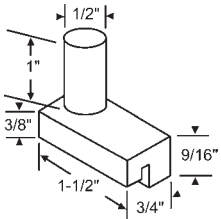

Part #	Hand
26-84	Shown
26-83	Opposite

Nylon Shoe with Aluminum Pin

Part #	Hand
26-84P	Shown

Nylon Shoe with Nylon Pin

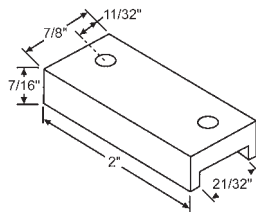

26-85
Fits both RH and LH
White Nylon

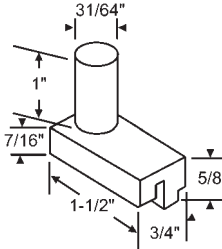

Part #	Hand
26-88	Shown
26-87	Opposite

Nylon Shoe with Aluminum Pin

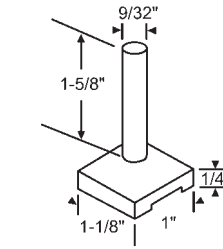

Part #	Hand
26-99	Shown
26-98	Opposite

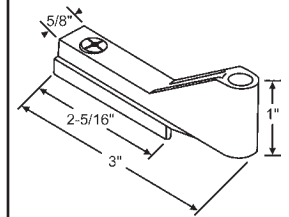

900-20957
Nylon with Metal Bracket

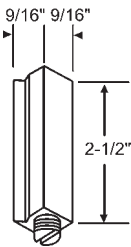

26-113
Housing with Screw.
Aluminum

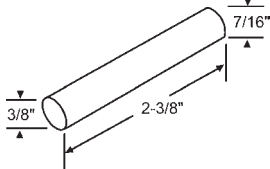

26-115
Pressure Shoe Pin

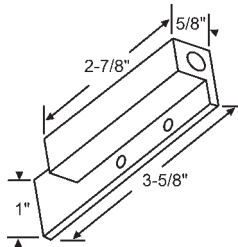

Part #	Hand
26-61	Shown
26-60	Opposite

Aluminum

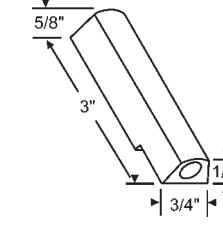

26-75
Three 10-24 Tapped Mounting
Holes on Underside; Set Screw
Only: 26-75S

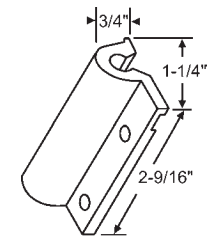

Part #	Hand
26-80	Shown
26-79	Opposite

Aluminum

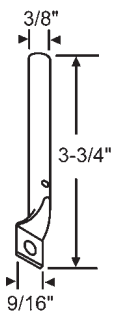

26-82
Brass

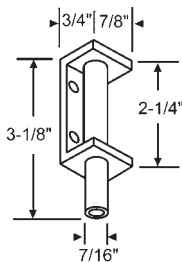

26-89
Aluminum



900-12627
Pressure Shoe Spring
.50 Gauge Steel.

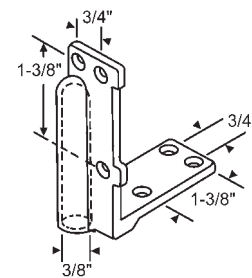

Part #	Hand
26-129	Shown
26-128	Opposite

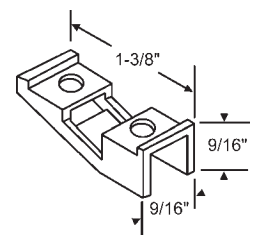

26-124
Project Out Guide

WINDOW REPLACEMENT HARDWARE

CASEMENT AND AWNING TRACKS

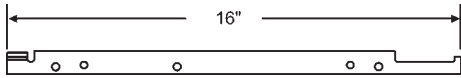

Part #	Hand
750-1361412	Shown
750-1361413	Opposite

Steel

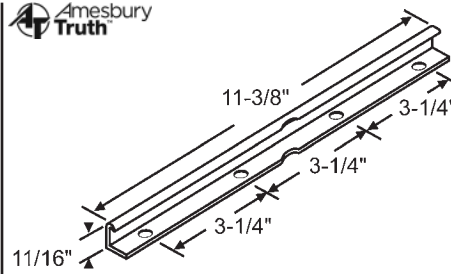

Part #	Material
38-53	Steel
38-53CG	Coast-Gard

For Casement Windows

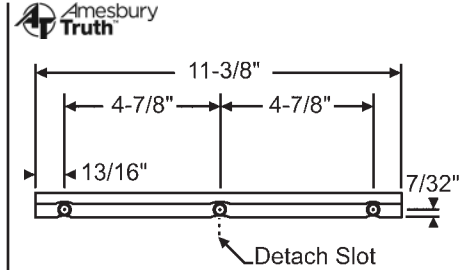

Part #	Material
38-55	Steel
38-55SS	Stainless Steel

For Casement Windows

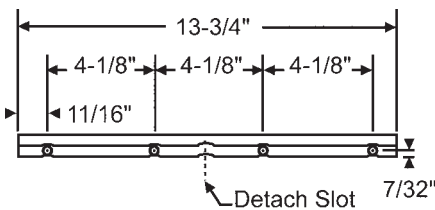

Part #	Material
38-59	Steel

For Casement Windows

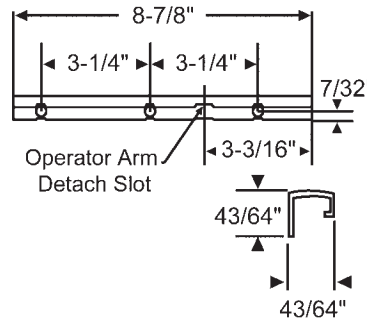

Part #	Material
38-65	Steel

For Casement Windows

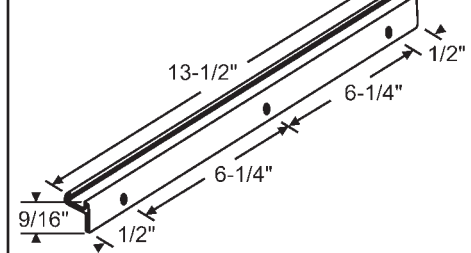

Part #	Material
38-54	Aluminum

For Casement Windows
DORCHESTER

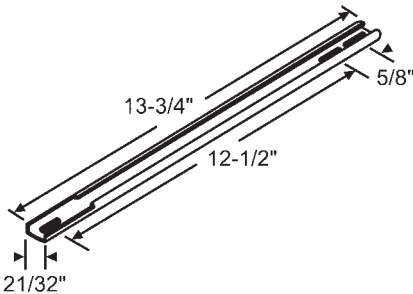

Part #	Material
38-51ST	Steel

For Casement Windows
DORCHESTER

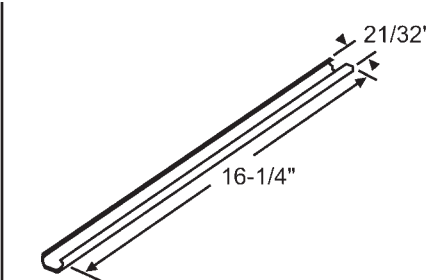

Part #	Material
38-52	Steel

Rust Resistant Coating
For Awning Windows

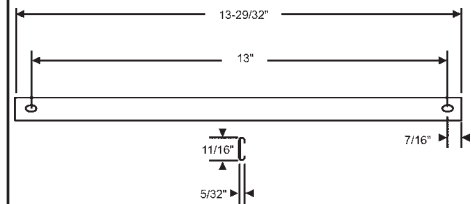

Part #	Material
38-58	Stainless Steel

For Awning Windows

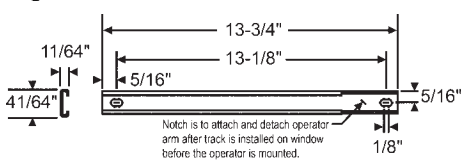

Part #	Material
38-60	Stainless Steel

For Casement Windows

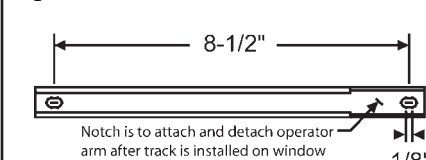

Part #	Material
38-62	Stainless Steel

For Casement Windows

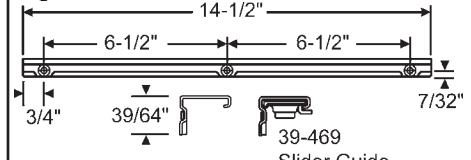

Part #	Material
38-67	Aluminum
38-67SS	Stainless Steel

Maxim® Casement Track with Slider Guide

WINDOW REPLACEMENT HARDWARE

CASEMENT AND AWNING TRACKS

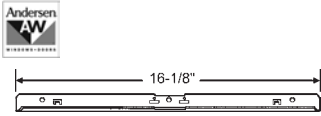

Part #	Material
750-0565808	Aluminum

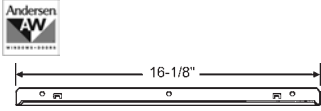

Part #	Material
750-1361204	Aluminum

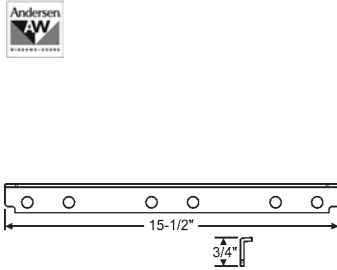

Part #	Material
750-9052563	Stainless Steel

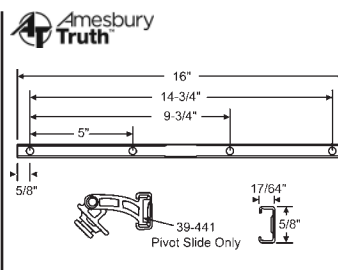

Part #	Material
38-68	Aluminum
38-68SS	Stainless Steel

For Awning Windows with Pivot Slides (2)

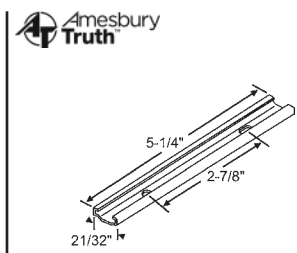

Part #	Material
38-1	Steel

For Casement Windows

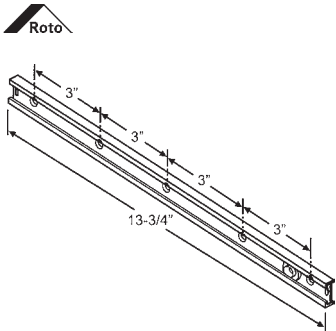

Part #	Material
38-172	Aluminum

Surface Mount Track & Roller

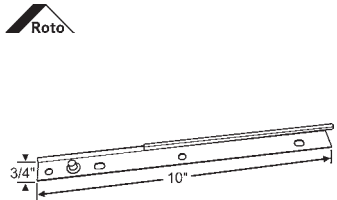

Part #	Material
900-21353T	Steel

For Casement Windows. Pair

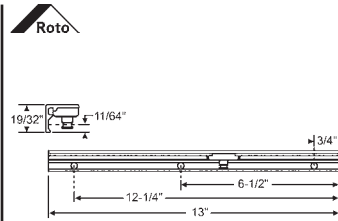

Part #	Material
38-21	Aluminum

Face Mount Track Assembly. Use with Slider Guide 39-753 on page 273.

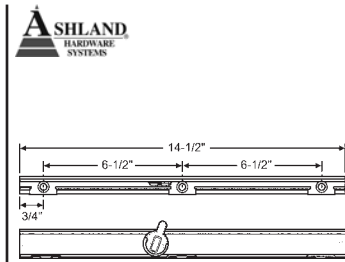

Part #	Material
38-78	Stainless Steel

AWNING HINGES

TRUTH 13 CONCEALED AWNING HINGE

Truth Part #	Finish	Our Part #	Sash Height	Maximum Sash Weight	Hinge Length "L"	"B"	"C"	"D"	"E"
13.13	E-Gard	28-10-14LH & RH	10"-14"	7 LBS.	10"	6-1/4"	4-1/4"	2-5/8"	1-1/4"
13.43	Stainless Steel	28-10-14LHSS & RHSS	10"-14"	7 LBS.	10"	6-1/4"	4-1/4"	2-5/8"	1-1/4"
13.14	E-Gard	28-14-14LH & RH	14"-19"	20 LBS.	14"	6-1/4"	4-1/4"	2-5/8"	1-1/4"
13.44	Stainless Steel	28-14-14LHSS & RHSS	14"-19"	20 LBS.	14"	6-1/4"	4-1/4"	2-5/8"	1-1/4"
13.15	E-Gard	28-18-14LH & RH	19"-26"	38 LBS.	18"	8-1/4"	6-1/4"	2-5/8"	1-1/4"
13.42	Stainless Steel	28-18-14LHSS & RHSS	19"-26"	38 LBS.	18"	8-1/4"	6-1/4"	2-5/8"	1-1/4"
13.16	E-Gard	28-22-14LH&RH	26"-34"	50 LBS.	22"	10-1/4"	6-1/4"	2-5/8"	1-1/4"
13.45	Stainless Steel	28-22-14LHSS & RHSS	26"-34"	50 LBS.	22"	10-1/4"	6-1/4"	2-5/8"	1-1/4"
13.17	E-Gard	28-26-14LH&RH	34"-42"	61 LBS.	26"	12-1/4"	8-1/4"	5-7/16"	2-5/8"

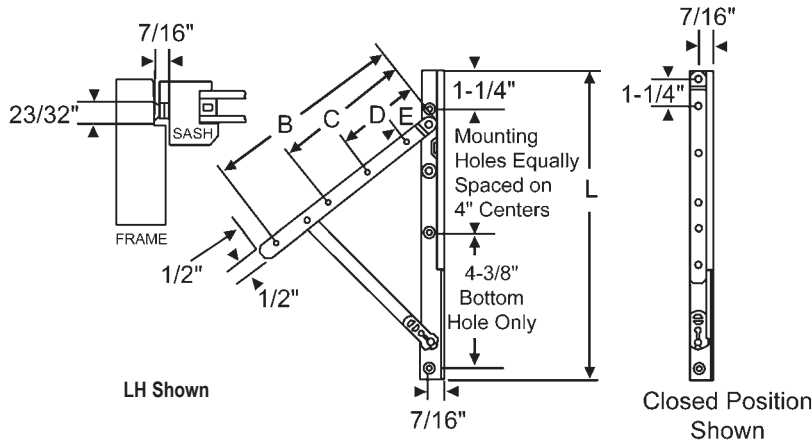

Screws sold separately.

Arm Screws: 20-136

Track Screws: 20-142

WINDOW REPLACEMENT HARDWARE

CASEMENT HINGES

TRUTH 14 CONCEALED CASEMENT HINGE

Truth Part #	Finish	Our Part #	"A"	"C"	"D"	"L"	Arm & Rivet	Attachment
14.05	E-Gard	28-15-37 (LL-UR) / 28-15-38 (UL-LR)	4-29/32"	9-5/8"	4-15/16"	10"	Steel	Adjustable Brass Snap-Stud
14.06	E-Gard	28-15-43 (LL-UR) / 28-15-44 (UL-LR)	5-17/32"	9-5/8"	4-15/16"	10"	Steel	Adjustable Brass Snap-Stud
14.08	E-Gard	28-15-49 (LL-UR) / 28-15-50 (UL-LR)	6-15/16"	13-5/8"	4-51/64"	14"	Steel	Adjustable Brass Snap-Stud
14.75	E-Gard	28-15-5 (LL-UR) / 28-15-6 (UL-LR)	4-29/32"	9-5/8"	4-15/16"	10"	Steel	Standard Brass Snap-Stud
14.80	Stainless Steel	28-15-5SS (LL-UR) / 28-15-6SS (UL-LR)	4-29/32"	9-5/8"	4-15/16"	10"	Stainless Steel	Stainless Steel Snap-Stud
14.76	E-Gard	28-15-7 (LL-UR) / 28-15-8 (UL-LR)	5-17/32"	9-5/8"	4-15/16"	10"	Steel	Standard Brass Snap-Stud
14.91	Stainless Steel	28-15-7SS (LL-UR) / 28-15-8SS (UL-LR)	5-17/32"	9-5/8"	4-15/16"	10"	Stainless Steel	Stainless Steel Snap-Stud
14.77	E-Gard	28-15-9 (LL-UR) / 28-15-10 (UL-LR)	2-9/32"	9-5/8"	4-15/16"	10"	Steel	Standard Brass Snap-Stud
14.93	Stainless Steel	28-15-9SS (LL-UR) / 28-15-10SS (UL-LR)	2-9/32"	9-5/8"	4-15/16"	10"	Stainless Steel	Stainless Steel Snap-Stud
14.17	E-Gard	28-15-1 (LL-UR) / 28-15-2 (UL-LR)	6-15/16"	13-5/8"	4-25/32"	14"	Steel	Standard Brass Snap-Stud

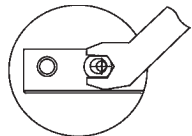

Screws sold separately.
Arm Screws: 20-136
Track Screws: 20-142

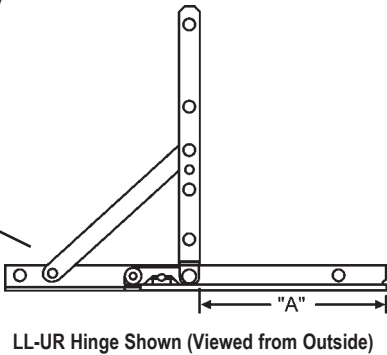

Not for Use on Awning Windows.

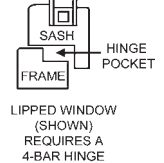
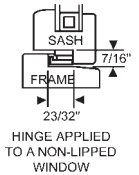
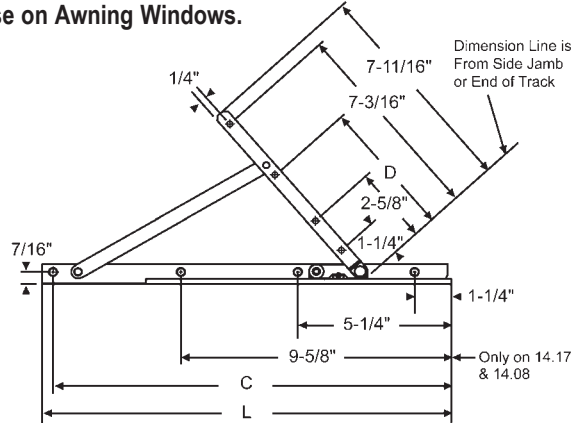

Instructions for Sash Adjustment

1. The amount of sash sag that the HP hinge will correct for is dependent on the ratio of the sash width vs. sash height. To calculate the amount of drag adjustment for any given sash size, take the ratio of width to height multiplied by 1/16". Example: Sash size equals 24" x 36", width to height ratio is .667. Total adjustment is $.667 \times 1/16" = .042$ (approx. 3/64").
2. To adjust a casement sash, first fully open the casement window. Next, loosen the two screws in the bottom hinge adjustment block approximately three turns (do not remove screws). Next, move heel of the sash towards the lock side of the window and re-tighten screws. For severe sash drag, repeat this procedure to the top hinge, except the adjustment is made by shifting the top of the window away from the lock side.

CONCEALED MAXIM® HINGES

14.97 Washability Hinge has the ability to support a 40" x 84" sash weighing up to 96 lbs., when used with the Maxim® Dual Arm Operator.

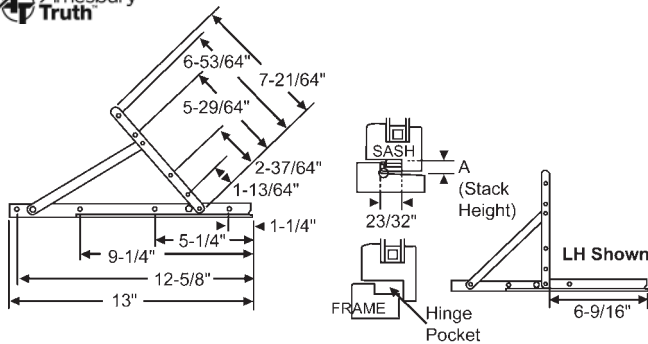

Truth Part #	Part #	Hand	Finish	A
14.97	28-15-39	Shown	E-Gard	7/16"
14.97	28-15-40	Opposite	E-Gard	7/16"
14.97	28-15-39SS	Shown	Stainless Steel	7/16"
14.97	28-15-40SS	Opposite	Stainless Steel	7/16"
14.92	28-15-57	Shown	E-Gard	1/2"
14.92	28-15-58	Opposite	E-Gard	1/2"
14.92	28-15-57SS	Shown	Stainless Steel	1/2"
14.92	28-15-58SS	Opposite	Stainless Steel	1/2"

14.12 Egress Hinge has the ability to support a sash weighing up to 69 lbs., when used with the Maxim® Dual Arm Operator.

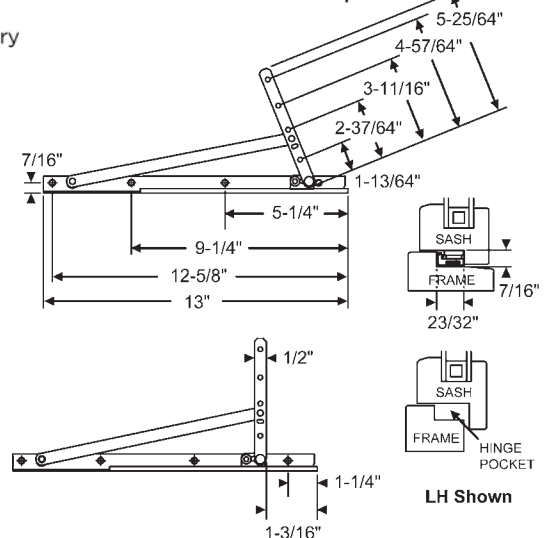

Truth Part #	Part #	Hand	Finish
14.12	28-15-41	Shown	E-Gard
14.12	28-15-42	Opposite	E-Gard
14.12	28-15-41SS	Shown	Stainless Steel
14.12	28-15-42SS	Opposite	Stainless Steel

WINDOW REPLACEMENT HARDWARE

CASEMENT AND AWNING HINGES

ANDERBERG 77AL SERIES HINGE

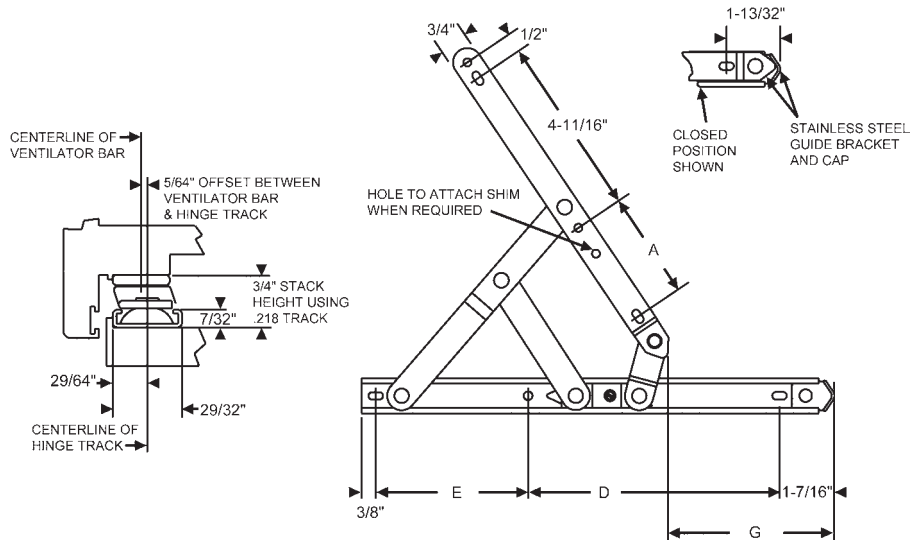

Our Part #	Hinge Length	A	D	E	G
28-10-6	10"	1-13/16"	6-11/32"	2-1/4"	4"
28-12-6	12"	2-13/16"	6-19/32"	4"	4"
28-14-6	14"	3-13/16"	6-15/16"	5-21/32"	4-3/8"
28-16-6	16"	4-13/16"	7-21/32"	6-15/16"	5-1/4"
28-18-6	18"	5-13/16"	8-9/32"	8-5/16"	5-3/4"

Truth Part #	Size	Description	Vent Height Range	Max. Vent Weight	Degree of Opening	Our Part Number	Features
34.47.00.105	10"	Aluminum 4 Bar Hinge w/Stop	12" - 20"	58	63°	28-10-6-06	.350 Track with .187 Shim
34.47.00.107	10"	Aluminum 4 Bar Hinge w/Stop	12" - 20"	58	63°	28-10-6-09	.385 Track with No Shim
34.48.00.107	12"	Aluminum 4 Bar Hinge w/Stop	20" - 23"	67	54°	28-12-6-10	.218 Track with No Shim
34.48.00.103	12"	Aluminum 4 Bar Hinge w/Stop	20" - 23"	67	54°	28-12-6-37	.350 Track with .187 Shim
34.49.00.102	14"	Aluminum 4 Bar Hinge w/Stop	23" - 27"	79	50°	28-14-6-24	.350 Track with No Shim
34.49.00.105	14"	Aluminum 4 Bar Hinge w/Stop	23" - 27"	79	50°	28-14-6-36	.350 Track with .125 Shim
34.49.00.104	14"	Aluminum 4 Bar Hinge w/Stop	23" - 27"	79	50°	28-14-6-25	.385 Track with No Shim
34.50.00.104	16"	Aluminum 4 Bar Hinge w/Stop	27" - 30"	88	50°	28-16-6-22	.350 Track with No Shim
34.50.00.101	16"	Aluminum 4 Bar Hinge w/Stop	27" - 30"	88	50°	28-16-6-25	.385 Track with No Shim
34.51.00.100	18"	Aluminum 4 Bar Hinge w/Stop	30" - 35"	102	50°	28-18-6-18	.218 Track with No Shim
34.51.00.101	18"	Aluminum 4 Bar Hinge w/Stop	30" - 35"	102	50°	28-18-6-19	.218 Track with .187 Shim
34.51.00.103	18"	Aluminum 4 Bar Hinge w/Stop	30" - 35"	102	50°	28-18-6-22	.350 Track with No Shim

WINDOW REPLACEMENT HARDWARE

CASEMENT AND AWNING HINGES

ANDERBERG 201 SERIES HINGE

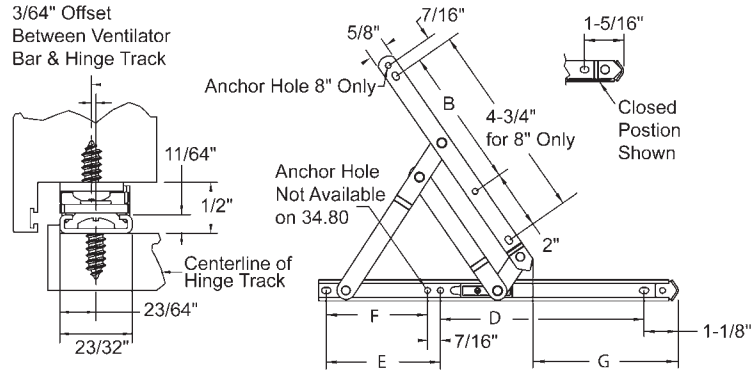

SS - Stainless Steel
ST - Steel

Material	Length	Truth Part #	Our Part #	Stop/No Stop	Ventilator Bar	Track	STD Stop	No Stop Track	"G"		Degree of Opening
					"B"	"D"	"E"	"F"	STD Stop	No Stop	Stop
SS	8"	34.10.00.101	28-8-2-03	Stop	N/A	5-5/32"	1-5/8"	1-1/4"	3"	4-1/4"	54°
ST	8"	34.17.00.104	28-8-1-03	Stop	N/A	5-5/32"	1-5/8"	1-1/4"	3"	4-1/4"	54°
SS	10"	34.11.00.102	28-10-2-07	Stop	3-3/4"	6-1/32"	2-3/4"	2"	4"	5-13/32"	55°
SS	12"	34.12.00.100	28-12-2-07	Stop	4-3/4"	6-29/32"	3-7/8"	3"	4-7/8"	6-1/2"	55°
SS	14"	34.13.00.102	28-14-2-07	Stop	5-3/4"	7-25/32"	5"	3-3/4"	5-3/4"	7-23/32"	55°
SS	16"	34.14.00.100	28-16-2-07	Stop	6-3/4"	8-21/32"	6-1/8"	4-1/2"	6-1/8"	8-7/8"	55°
ST	16"	34.21.00.102	28-16-1-07	Stop	6-3/4"	8-21/32"	6-1/8"	4-1/2"	6-1/8"	8-7/8"	55°
SS	18"	34.15.00.102	28-18-2-07	Stop	7-3/4"	9-17/32"	7-1/4"	5-1/4"	7-7/16"	10"	55°
SS	20"	34.16.00.100	28-20-2-07	Stop	8-3/8"	10-13/32"	8-3/8"	6-1/4"	8-9/32"	11-5/32"	55°

Note: Ask Account Manager About Variations if Chart Does not Meet Requirements

STANDARD DUTY STAINLESS STEEL 4-BAR EGRESS HINGES - ANDERBERG 222SS AND 224SS SERIES

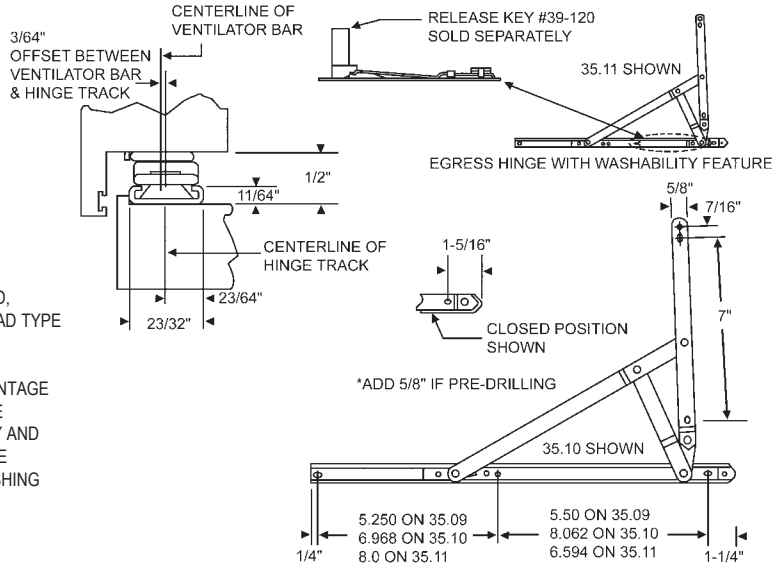

RECOMMENDED SCREWS:

6- NO .10 SLOTTED OR NO. 6 PHILLIPS, PAN HEAD, STAINLESS STEEL SCREWS (LENGTH AND THREAD TYPE TO BE DETERMINED BY PROFILE DESIGN).

NOTE: THE 35.11 HINGE OFFERS YOU THE ADVANTAGE OF ALLOWING THE OUTSIDE OF THE VENT TO BE WASHED FROM THE INSIDE BY INSERTING A KEY AND SLIDING THE CASEMENT WINDOW TOWARDS THE CENTER OF THE FRAME OPENING GIVING A WASHING SPACE OF APPROXIMATELY 4-1/2".

Truth Part #	Part Number	Description	Stop
35.09.00.100	28-12.2-00	12-1/4" w/Stop	90°
35.09.00.101	28-12.2-01	12-1/4" w/Stop and Loose Rivet	90°
35.10.00.100	28-16.2-00	16-1/8" w/Stop	90°
35.10.00.101	28-16.2-01	16-1/8" w/Stop and Loose Rivet	90°
35.11.00.100	28-16.2-02	16-1/8" w/Stop and Washability Feature	90°

WINDOW REPLACEMENT HARDWARE

CASEMENT AND AWNING HINGES

ANDERBERG 301SS, 301ST and 301AL SERIES HINGE



Part Number Guide

Add the suffix of the specific feature you require on the hinge to complete our part number

Material	Size	Truth Part #	Our Part #	Stop	No Stop	Loose Rivets*	.125 Shim	.187 Shim	.250 Shim	.312 Shim
SS	10"	34.24.00	28-10-3	-03	-00	-04	-06	-07	-84	-87
ST	10"	34.33.00	28-10-4	-03			-06	-05		
SS	12"	34.25.00	28-12-3	-14			-17			-18
SS	14"	34.26.00	28-14-3	-21	-00		23	22	-84	
ST	14"	34.35.00	28-14-4	-21			-23	21B		
SS	16"	34.27.00	28-16-3	-25			-01		29	
ST	16"	34.36.00	28-16-4	25						
SS	18"	34.28.00	28-18-3	25			08		84	
ST	18"	34.37.00	28-18-4					-27		
SS	20"	34.29.00	28-20-3	-25			-28	-27	29	
ST	20"	34.38.00	28-20-4	-25						
SS	24"	34.31.00	28-24-3	-09			-08	-11	-12	
ST	24"	34.39.00	28-24-4	-09				-07		
SS	28"	34.86.00	28-28-3	45						

Dark Gray Vertical Columns Denote Hinges without Stops (Maximum Opening)

*Loose rivets are usually used when less friction is needed and used with an operator.

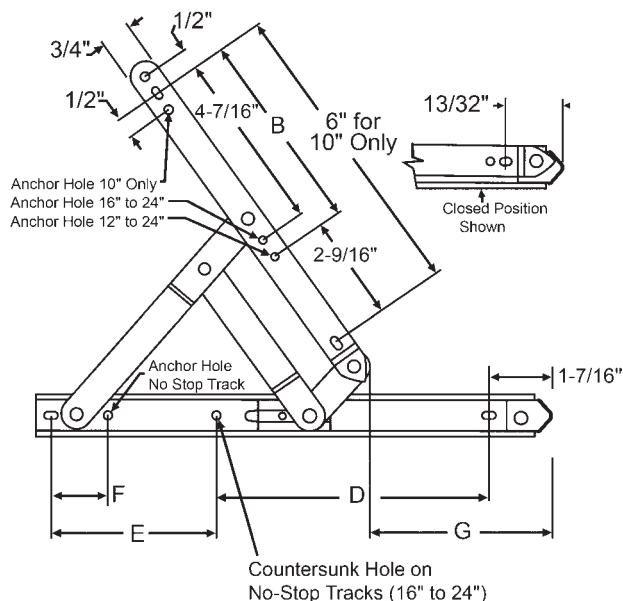
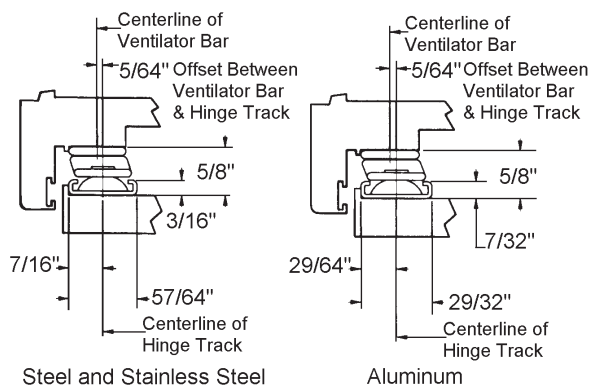

Truth Part #.			Hinge Length	Vent Hinge Range	Maximum Vent Wt.	Ventilator Bar B	Track D	Std. Stop E	No-Stop Track F	G		Degree of Opening	
SS	ST	AL								Std. Stop	No Stop	Std. Stop	No Stop
34.24	34.33	34.41	10"	12"-20"	58	N/A	6-11/32"	2-1/4"	1-3/8"	4"	6-1/4"	58°	77°
34.25	34.34	34.42	12"	20"-25"	73	4-15/16"	6-19/32"	4"	1-5/8"	4-1/4"	7-3/4"	52°	77°
34.26	34.35	34.43	14"	23"-29"	85	5-15/16"	6-15/16"	5-21/32"	2-1/8"	4-1/4"	9-1/4"	48°	77°
34.27	34.36	34.44	16"	25"-34"	99	6-15/16"	7-21/32"	6-15/16"	2-5/8"	5-3/32"	10-3/4"	49°	77°
34.28	34.37	34.45	18"	32"-37"	108	7-15/16"	8-9/32"	8-5/16"	8-1/8"	5-3/4"	12-1/4"	49°	77°
34.29	34.38	34.46	20"	34"-40"	117	8-15/16"	8-31/32"	9-5/8"	3-5/8"	6-7/16"	13-13/16"	49°	77°
34.31	34.39	N/A	24"	40"-44"	129	10-15/16"	9-3/32"	13-1/2"	4-5/8"	6-3/4"	16-7/8"	45°	77°
34.86	N/A	N/A	28"	50"-64"	175	12-15/16"	9-19/32"	17"	N/A	7-1/2"	N/A	40°	N/A

WINDOW REPLACEMENT HARDWARE

CASEMENT AND AWNING HINGES

HEAVY DUTY STAINLESS STEEL 4-BAR EGRESS HINGES - ANDERBERG 333SS AND 334SS SERIES



RECOMMENDED SCREWS:

6- NO. 10 PHILLIPS, PAN HEAD, STAINLESS STEEL SCREWS (LENGTH AND THREAD TYPE TO BE DETERMINED BY PROFILE DESIGN).

NOTE: 1- THE 35-13 HINGE OFFERS YOU THE ADVANTAGE OF ALLOWING THE OUTSIDE OF THE VENT TO BE WASHED FROM THE INSIDE BY INSERTING A KEY AND SLIDING THE CASEMENT WINDOW TOWARDS THE CENTER OF THE FRAME OPENING GIVING A WASHING SPACE OF APPROXIMATELY 4-1/2".

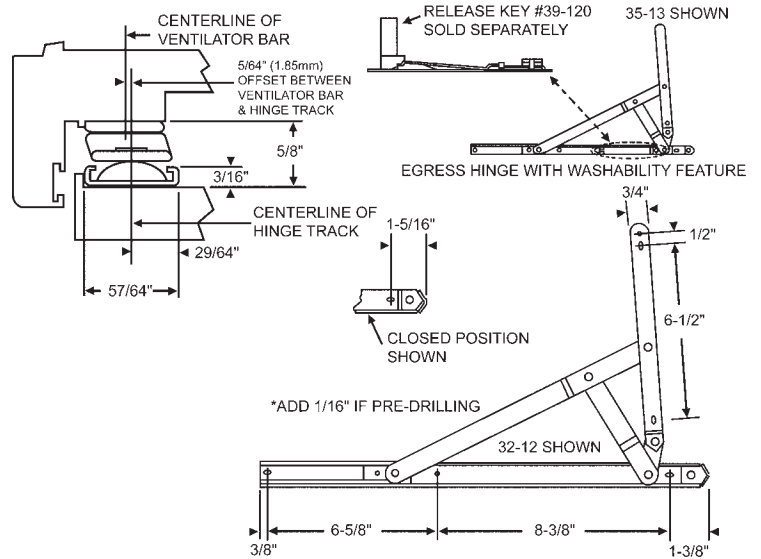

Truth Part #	Part Number	Description	Stop
35.12.00.100	28-16.5-00	16-1/2" w/Stop	90°

STANDARD DUTY STAINLESS STEEL CASEMENT HINGES - ANDERBERG 401 SERIES

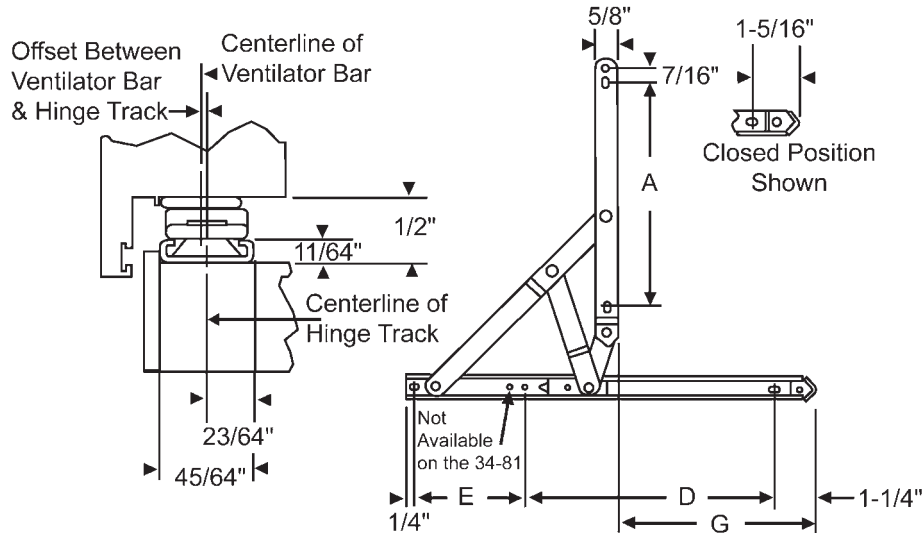

Truth Part #	Our Part #	Hinge Length	"A"	"D"	"E"	"G"	Stop
34.55.00.100	28-12-12-0	12"	6-3/4"	7-15/32"	3-5/16"	5-15/16"	90°
34.56.00.100	28-14-12-0	14"	7-9/32"	8-5/32"	4-5/8"	6-3/16"	90°

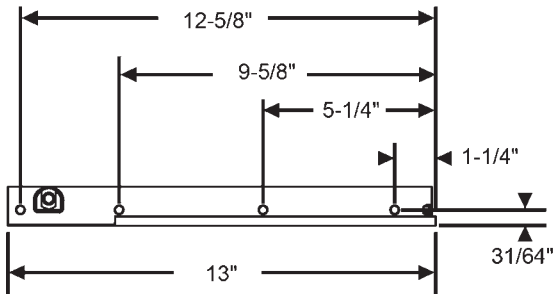
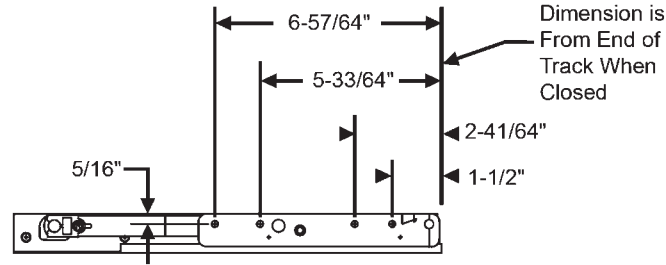
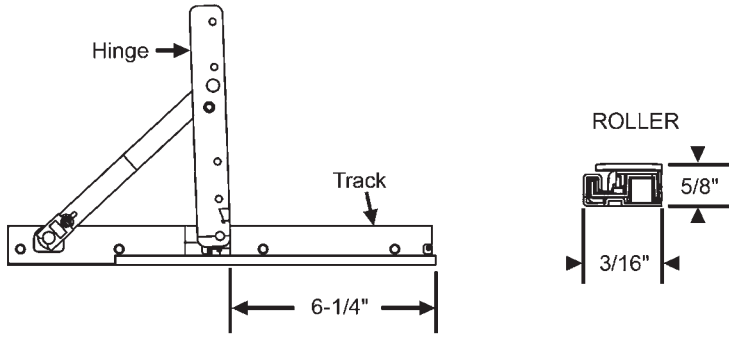

Truth Part #	Our Part Number	Description	Finish
14.10.00.511.1	28-166T	LL/UR Track Only	Stainless Steel
14.10.00.513.1	28-166	LL/UR Hinge Arm Only	Stainless Steel
14.10.00.512.1	28-169T	UL/LR Track Only	Stainless Steel
14.10.00.514.1	28-169	UL/LR Hinge Arm Only	Stainless Steel

High Performance Hinge Stop

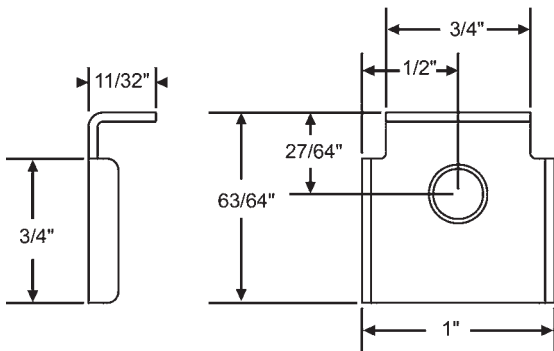

39-966

1. Capable of supporting a 140 lb. sash
2. Hinge allows use of triple pane glass and laminate glass package in larger windows.
3. Engineered to fit into larger 5/8" x 1-3/16" hinge cavity.
4. Hinge made with stainless steel track, arms, rivets, metal shoe insert, UV resistance plastic shoe housing and heavy duty brass stud.
5. Track and hinge sold separately

Concealed Snubber, Die Cast

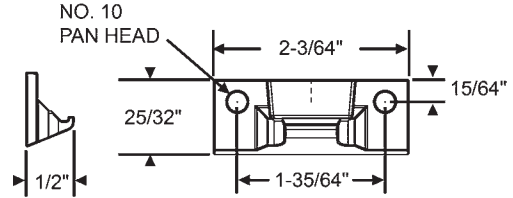

39-967

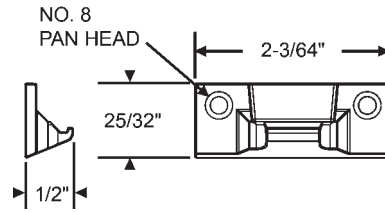

39-968

Hinge Spacer for Use in .625 Hinge Pocket

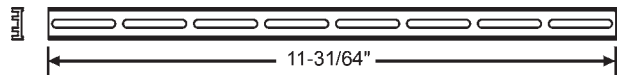
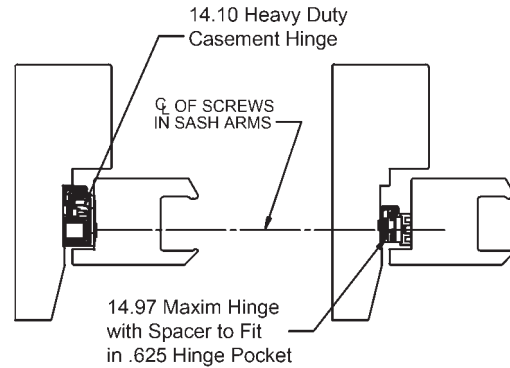

39-971

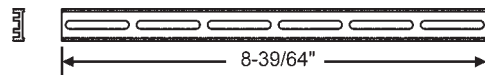

39-970

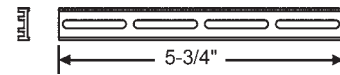

39-969

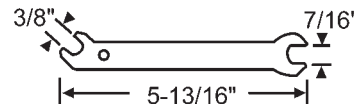

39-462

Adjusting Wrench

WINDOW REPLACEMENT HARDWARE

CASEMENT AND AWNING HINGES

HEAVY DUTY STAINLESS STEEL CASEMENT HINGES - ANDERBERG 601 SERIES

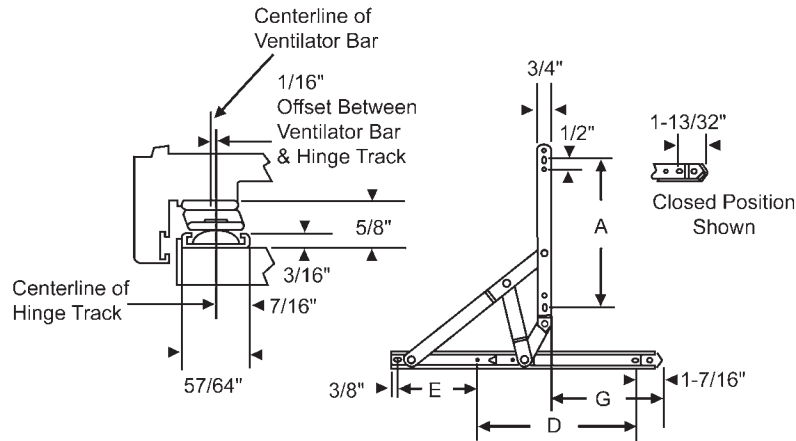

Truth Part #	Our Part #	Hinge Length	"A"	"D"	"E"	"G"	Stop
34.59.00.100	28-14-13-0	14"	8"	8-13/32"	4-3/16"	6"	90°
34.60.00.100	28-16-13-0	16"	8"	7-29/32"	6-11/16"	5-5/8"	90°
34.61.00.100	28-18-13-0	18"	8"	7-21/32"	8-15/16"	5-7/16"	90°

TRUTH'S SUPERIOR 4-BAR HINGE - ANDERBERG 301 SERIES

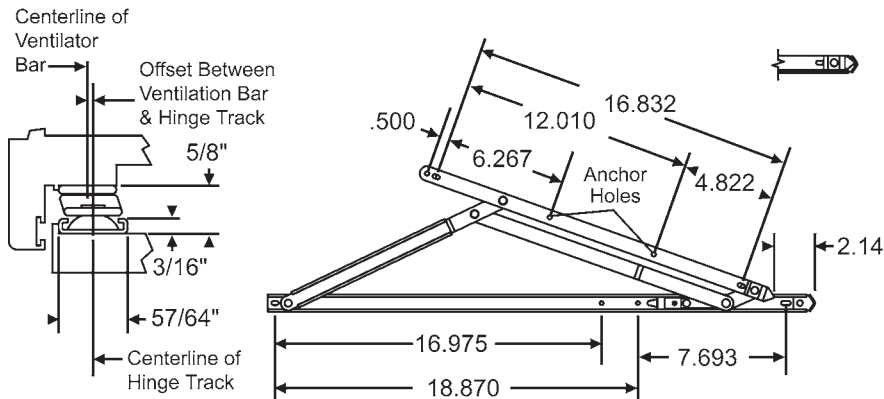

Truth Part #	Our Part #	Hinge Length	Vent Height Range	Degree of Opening	Maximum Vent Weight
34.87	28-28-15-2S	28"	64" to 86"	20°	300 lbs.

10" HP200 TRACK AND ARM CASEMENT HINGE ASSEMBLY

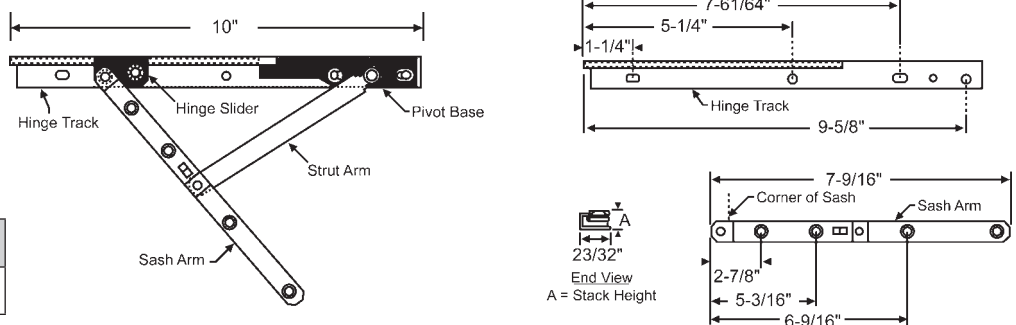

Part #	"A" Stack Height
28-10-23	1/2"

4pc. Set (2 Track & 2 Arms)

WINDOW REPLACEMENT HARDWARE

CASEMENT AND AWNING HINGES

HG05 CASEMENT HINGE*

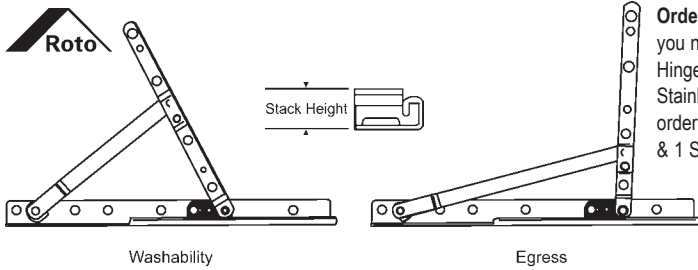

Ordering Example: If you need two 10" Steel Hinge Arms and two 10" Stainless Steel Tracks order 1 Set # 28R-10-1 & 1 Set # 28R-10T

The Roto HG05 Hinge series features 10" and 13" washability versions as well as a 10" egress version and is suitable for most casement and awning window applications (wood, vinyl, aluminum, and fiberglass). They are available in both 7/16" and 1/2" stack height versions, so there is no need for a spacer. The use of high quality materials and manufacturing processes makes this one of the strongest hinges on the market. The hinges are available in powder coated steel or Stainless Steel versions.

Features

Each hinge is equipped with Roto's quick disconnect feature that allows for easy snap connection between the sash and frame. With a simple turn of a wrench, the hinge adjusts to compensate for sash sag or window manufacturing variations, up to 3mm (.125). Additional holes in the hinge arms allow for installation into a bow/bay window and for adding a limiting device.

Performance

Hinge arms are rounded at the edges to resist binding and the track/slider overlaps by 2.7mm (0.106") to prevent disengagement. The hinge slider is reinforced with a stainless steel insert for greater rigidity and furnishes a 2mm clearance, eliminating interference with screws.

The HG05 hinge is AAMA 904 life cycle compliant at 125 lbs. on the 13" hinge and at 110 lbs. on the 10" version. Both steel versions are AAMA 907 corrosion compliant at 750 hours for powder coated and over 1000 hours for stainless steel. The hinges also pass ASTM E1886 and ASTM E1996 hurricane impact testing.

Hinge Arm Set	Arm Finish	Stainless Steel Hinge Track Set	Size	Stack Height	Version
28R-10-1	Powder Coated Steel	28R-10T	10"	7/16"	Washability
28R-10-1SS	Stainless Steel	28R-10T	10"	7/16"	Washability
28R-10-1E	Powder Coated Steel	28R-10T	10"	7/16"	Egress
28R-10-2	Powder Coated Steel	28R-10T	10"	1/2"	Washability
28R-10-2SS	Stainless Steel	28R-10T	10"	1/2"	Washability
28R-10-2E	Powder Coated Steel	28R-10T	10"	1/2"	Egress
28R-13-1	Powder Coated Steel	28R-13T	13"	7/16"	Washability
28R-13-2	Powder Coated Steel	28R-13T	13"	1/2"	Washability

* Direct replacement for the Roto HG04 Casement Hinge.

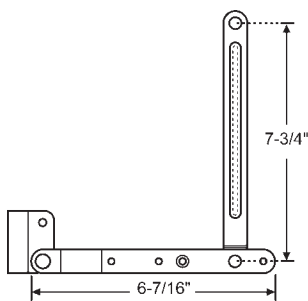

Part #	Hand
28-81RH	Shown
28-81LH	Opposite

Top Hinge Assembly
PEACHTREE

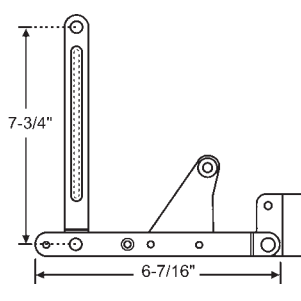

Part #	Hand
28-80RH	Shown
28-80LH	Opposite

Bottom Hinge Assembly
PEACHTREE

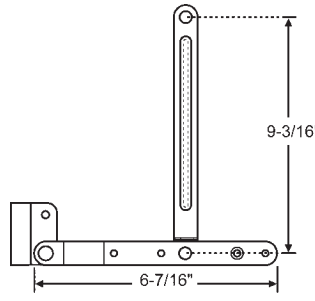

Part #	Hand
28-82RH	Shown
28-82LH	Opposite

Egress Top Hinge Assembly
PEACHTREE

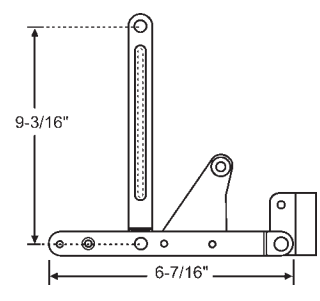

Part #	Hand
28-83RH	Shown
28-83LH	Opposite

Egress Bottom Hinge Assembly
PEACHTREE

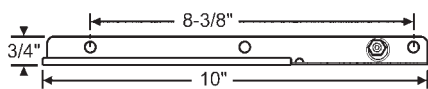

Part #	Hand
28-01-10ARH	Shown
28-01-10ALH	Opposite

Casement Hinge Track

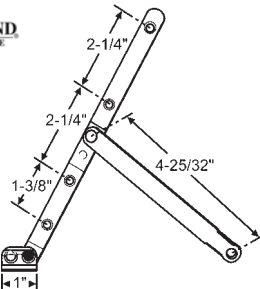

Part #	Hand
28-03-10SS-RHA	Shown
28-03-10SS-LHA	Opposite

Stainless Steel Casement Hinge Arm

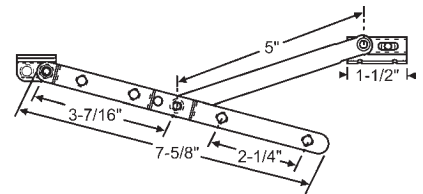

28-120NSA
Casement Hinge Set
BILTBEST

WINDOW REPLACEMENT HARDWARE

SASH CONTROL DEVICES

TRUTH'S HEAVY DUTY FRICTION ADJUSTERS

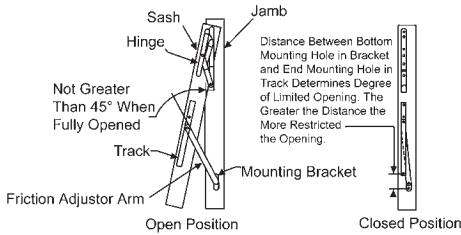

TRUTH'S STANDARD DUTY FRICTION ADJUSTERS ANDERBERG FA22SS SERIES

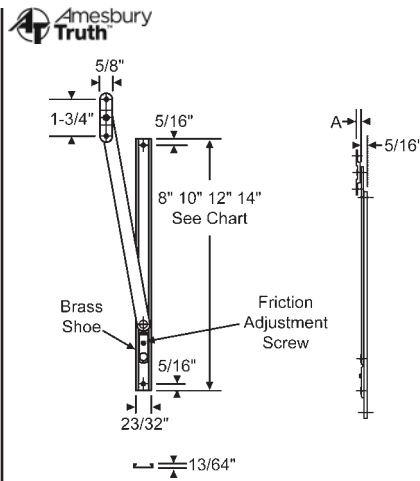

Truth Part #	Our Part #	Track Length	"A" Dimension
37.35.00.100	28-8-9-00	8"	15/64" (.235)
37.36.00.100	28-10-9-00	10"	15/64" (.235)
37.37.00.100	28-12-9-00	12"	15/64" (.235)
37.38.00.100	28-14-9-00	14"	15/64" (.235)

Note: Bar length is always 2" shorter than track length.

TRUTH'S HEAVY DUTY FRICTION ADJUSTERS ANDERBERG FA33SS SERIES

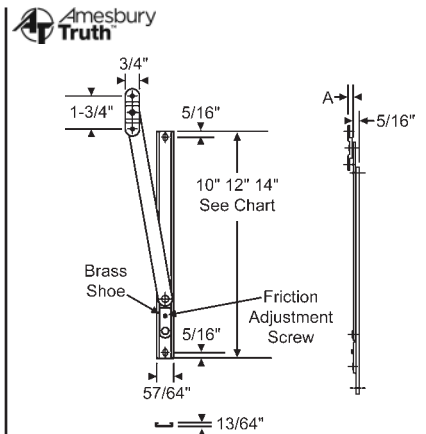

Truth Part #	Our Part #	Track Length	"A" Dimension
37.41.00.100	28-10-10-0	10"	15/64" (.235)
37.42.00.100	28-12-10-0	12"	15/64" (.235)
37.43.00.100	28-14-10-0	14"	15/64" (.235)

Note: Bar length is always 2" shorter than track length. Must specify bracket height from chart if not a standard bracket. Please contact Account Manager for correct part number.

TRUTH'S STANDARD DUTY LIMIT DEVICE WITH KEY RELEASE - ANDERBERG FA220SS SERIES

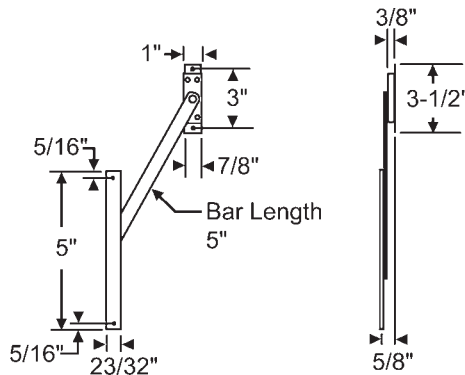
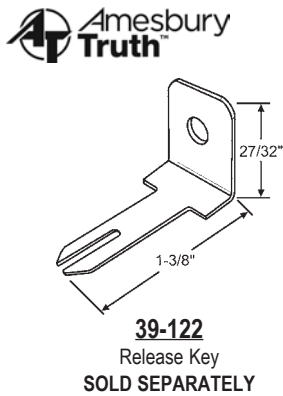

Truth Part #	Our Part #	Track Length	Bar Length
37.26.00.100	28-5-11-0	5"	5"
37.27.00.100	28-6-11-0	6"	6"
37.28.00.100	28-7-11-0	7"	7"
37.29.00.100	28-8-11-0	8"	8"
37.31.00.100	28A-10-11-0	10"	8"
37.31.00.101	28-10-11-0	10"	10"
37.33.00.100	28B-12-10-0	12"	6"
37.33.00.102	28-12-11-0	12"	12"
37.34.00.101	28-14-11-0	14"	14"

Note: If a bracket is not specified it comes with the standard 15/64" bracket (.235).

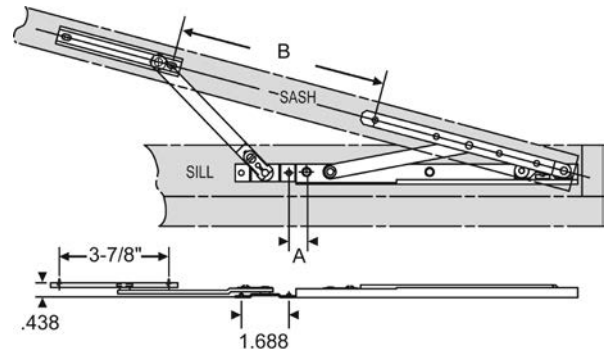
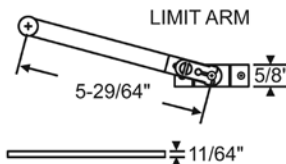
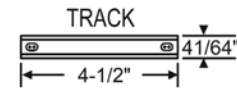

99.20 Limit Device
99.24 Stainless Steel Limit Device

Part #	Description
39-167	5" Limit Device (Arm Only)
39-167SS	Stainless Steel 5" Limit Device (Arm Only)
39-481	Track Only
39-482	Arm & Track Assembly
39-482SS	Stainless Steel Arm & Track Assembly

Degrees Opening	A	B
5	6.125 (1.55.6 mm)	14.188 (360.4 mm)
10	.625 (15.9 mm)	8.375 (212.7 mm)
15	.625 (15.9 mm)	7.656 (194.5 mm)
20	.625 (15.9 mm)	6.625 (168.3 mm)

WINDOW REPLACEMENT HARDWARE

SASH CONTROL DEVICES

TRUTH SUPPORT ARMS - ANDERBERG 88SS SERIES

TRUTH SUPPORT ARMS WITH LIMIT DEVICE- ANDERBERG 880SS SERIES

APPLICATION OF TRUTH'S SUPPORT ARMS

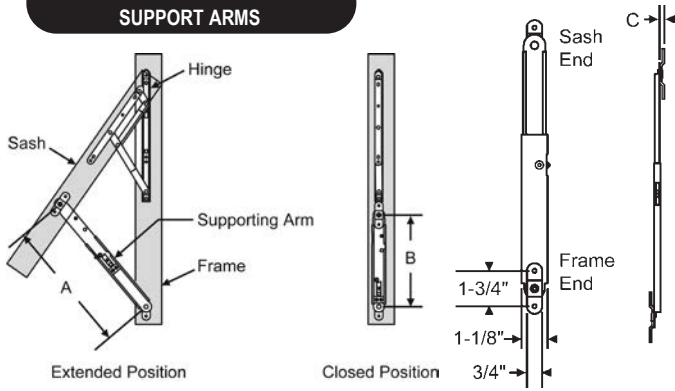

APPLICATION OF TRUTH'S SUPPORT ARMS

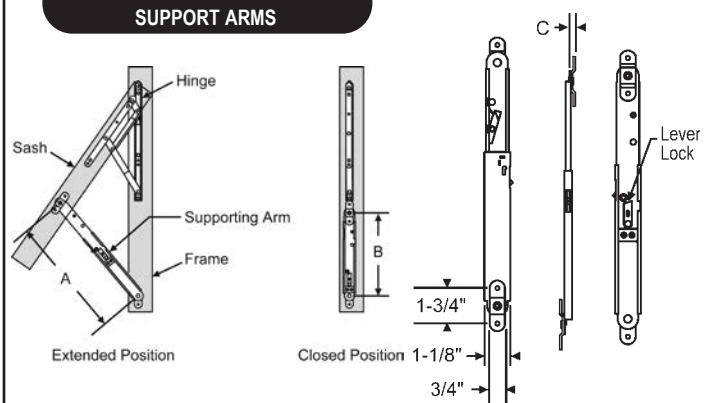

Truth Part #	Part #	A	B	Description (C)
37.10.00.100	28-10-7-01	10"	7"	with two .110 Brackets
37.10.00.103	28-10-7-07	10"	7"	with two .235 Brackets
37.11.00.104	28-12-7-01	12"	8"	with two .110 Brackets
37.11.00.102	28-12-7-07	12"	8"	with two .235 Brackets
37.12.00.100	28-14-7-01	14"	9"	with two .110 Brackets
37.13.00.106	28-16-7-01	16"	10"	with two .110 Brackets
37.13.00.103	28-16-7-07	16"	10"	with two .235 Brackets
37.14.00.100	28-18-7-01	18"	11"	with two .110 Brackets
37.15.00.102	28-20-7-01	20"	12"	with two .110 Brackets
37.17.00.105	28-24-7-01	24"	14"	with two .110 Brackets
37.18.00.101	28-26-7-01	26"	15"	with two .110 Brackets

Other lengths and bracket attachments available.
Contact your Sales Representative for details.

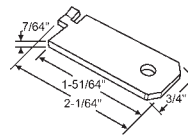

To Extend, #39-121
Release Key is Needed.
Sold Separately

Truth Part #	Part #	A	B	Description (C)
37.20.00.100	28-12-8-01	12"	8-1/2"	with two .110 Brackets
37.21.00.103	28-16-8-01	16"	10-1/2"	with two .110 Brackets
37.21.00.110	28-16-8-04	16"	10-1/2"	with two .180 Brackets
37.22.00.100	28-20-8-01	20"	12-1/2"	with two .110 Brackets
37.23.00.114	28-24-8-01	24"	14-1/2"	with two .110 Brackets
37.23.00.113	28-24-8-04	24"	14-1/2"	with two .180 Brackets
37.24.00.107	28-28-8-02	28"	16-1/2"	with two .180 Brackets

Other lengths and bracket attachments available.
Contact your Sales Representative for details.

TOP HUNG HINGE ASSEMBLY

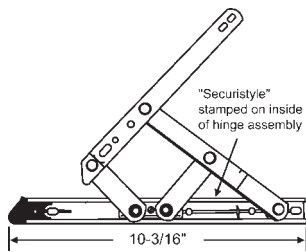

28-93-10

10" Storm Hinge (Pair). Stack Height 5/8".
RH Shown. Stainless Steel
SECURISTYLE

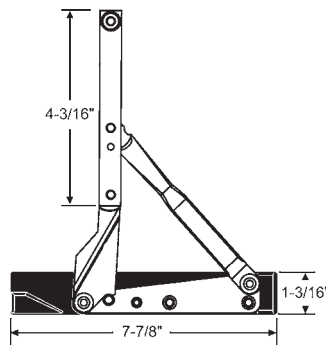

28-135C

Friction Hinge Set. RH Shown.
Stainless Steel.
CERTAINTEED INSULATE

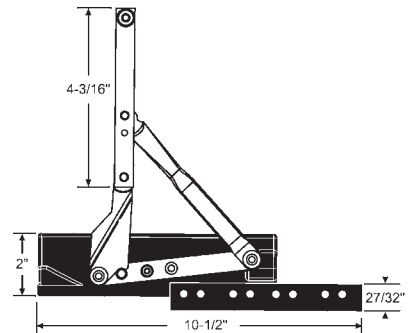

Part #	Hand
28-135ML	Shown
28-135MR	Opposite

Stainless Steel.
MILGARD

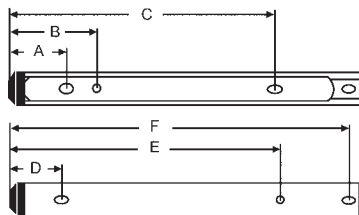

Part No.	Size	Recommended Maximum Sash		
		Width	Height	Weight in lbs.
900-21941-16	16"	47-1/4"	29-1/2"	48.5

Size	Fixing Hole Details in Millimeters					
	A	B	C	D	E	F
16"	36.1	139	271.9	30.8	309	407.2

G-U HARDWARE

WINDOW REPLACEMENT HARDWARE

MISCELLANEOUS OPERATOR HARDWARE

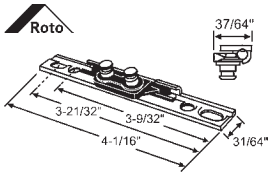

39-692
Surface Mount Awning Bracket Assembly.

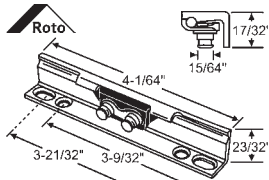

39-691
Face Mount Awning Bracket Assembly.

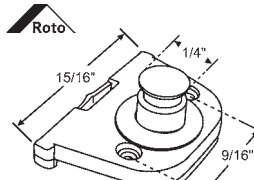

39-753
Slider for 38-21 Track

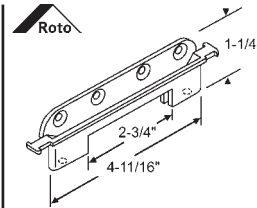

39-351
Use: 39-614

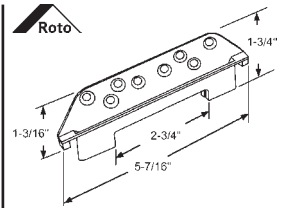

39-614
Die Cast Witteman Counterpart Spacer. Replaces Old Spacer 39-351

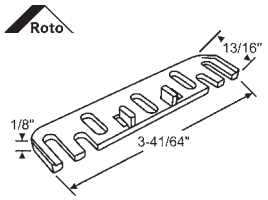

39-665
Black Nylon Spacer for Pro-Drive Operator

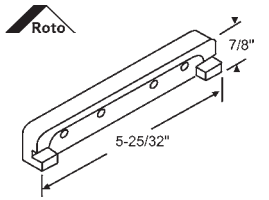

Part #	Color
39-350W	White

Plastic Support

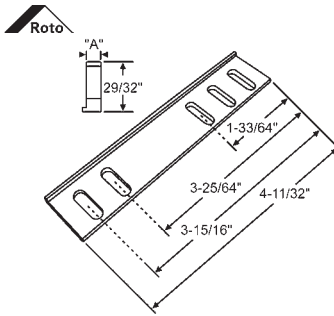

Part #	"A"
39-687	3/32"
39-687A	11/64"
39-687B	1/4"
39-687C	21/64"
39-687D	13/32"

Operator Bottom Spacer.
Black

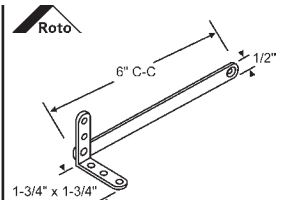

39-352
Connecting Arm with Bracket for 36-333 and 36-334. Zinc Dichromate

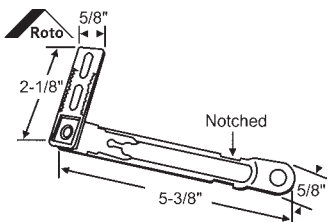

39-497
Stainless Steel Connect Arm with Die Cast Bracket.

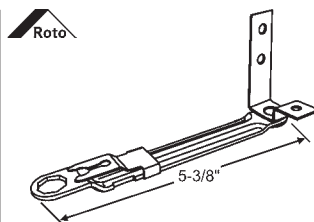

39-794
Stainless Steel Connect Arm Assembly with Stainless Steel Bracket

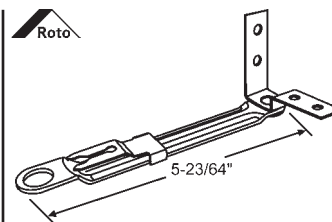

39-817
Stainless Steel Connect Arm Assembly with Stainless Steel Bracket

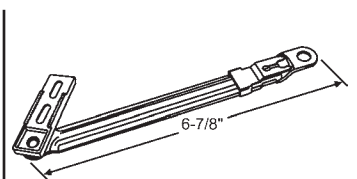

39-791
Connect Arm w/ Modified Clip 160 mm **INTERLOCK**

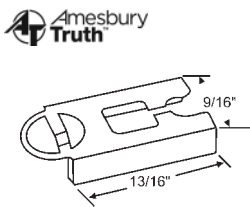

39-207
Detach Clip Bracket

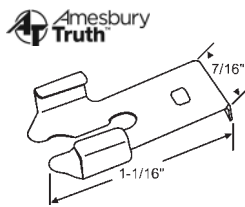

39-323
Stainless Steel Detach Clip

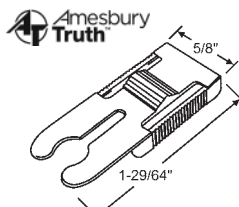

39-758
Black Plastic Detach Clip



39-379
Pivot Shoe Assembly

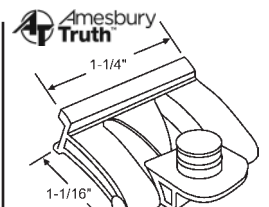

39-441
Pivot Slide Assembly
Black, Plastic

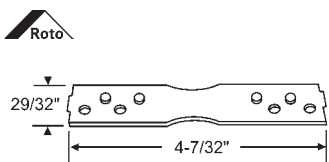

39-602
4-1/8" Black Top Spacer
3.5mm Thick x 22.5mm High

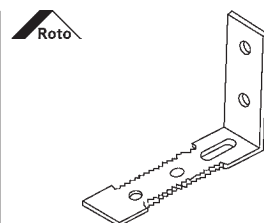

39-575
Sash Adapter Bracket for Casement Window. Stainless Steel

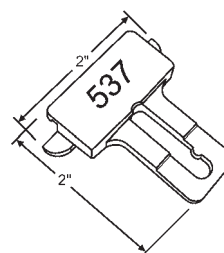

39-836
Slide Lock. White Nylon
SILVER LINE

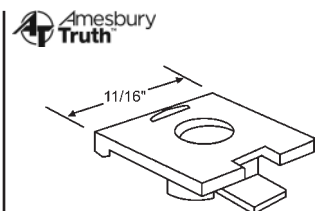

39-469
Black Casement Slider

WINDOW REPLACEMENT HARDWARE

MISCELLANEOUS OPERATOR HARDWARE

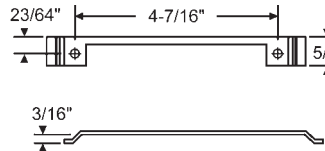

39-763

Maxim® Dual Arm Operator Back Plate

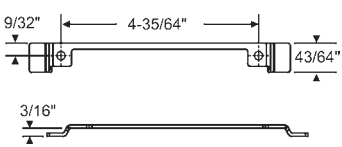

39-733

Encore™ Dyad Operator Back Plate

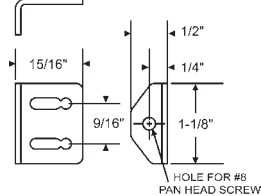

Part #	Finish
39-738-3	White
39-738-8	Chestnut Bronze

Stabilizing Tab. Includes 2 screws for attachment to operator.

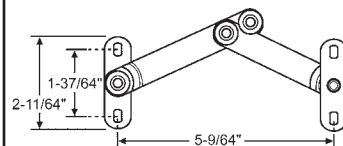

39-910

Sash Restrictor. Stainless Steel
INTERLOCK

TIE BAR GUIDE

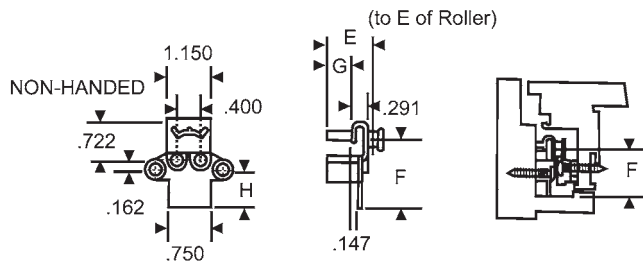

Part Number	E		F	G	H
	Interlock Roller	Cone Roller			
39-641	21/64"	25/64"	.765	.010	.219
39-448	21/64"	25/64"	.862	.010	.316
39-589	21/64"	25/64"	1.039	.010	.493
39-608	25/64"	29/64"	.837	.066	.291
39-594	13/32"	31/64"	1.077	.089	.531
39-195	27/64"	15/32"	1.147	.097	.601
39-649	27/64"	33/64"	1.163	.199	.617
39-191A	31/64"	9/16"	.902	.168	.356
39-654	31/64"	9/16"	.017	.170	.471
39-476	33/64"	37/64"	1.177	.192	.631
39-459A	31/64"	19/32"	1.128	.203	.582
39-426	17/32"	39/64"	.940	.216	.394
39-644	17/32"	39/64"	1.000	.216	.454
39-192	35/64"	5/8"	1.102	.229	.556
39-656	19/32"	43/64"	1.073	.274	.527

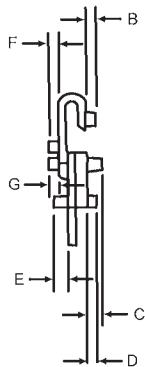
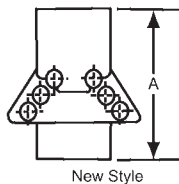

Part Number	A	B	C	D	E	F	G
39-576	1.155				.325		.225
39-577	1.395	.260	.250				
39-579	1.337	.091					
39-580	1.274	.010			.329	.229	
39-581	1.421	.090	.193	.193			
39-582	1.421	.045	.193	.193			
39-583	1.157		.153	.153			

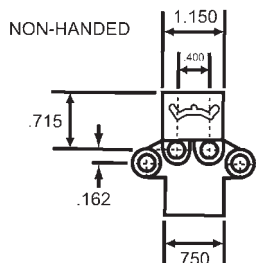

39-649

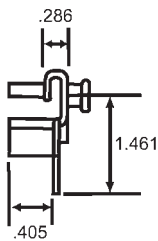

39-459B

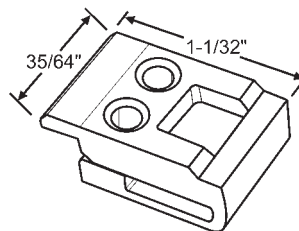

WINDOW REPLACEMENT HARDWARE

MISCELLANEOUS OPERATOR HARDWARE

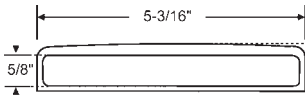

39-417

Gasket for Maxim® Operator

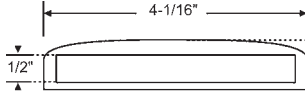

39-511

Gasket for Ellipse Operator

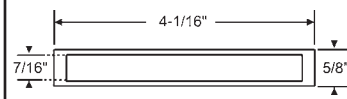

39-512

Gasket for Traditional Operator

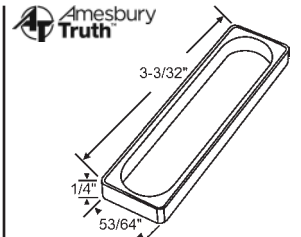

Part #	Finish
39-696-3	White
39-696-8	Chestnut Bronze

Spacer

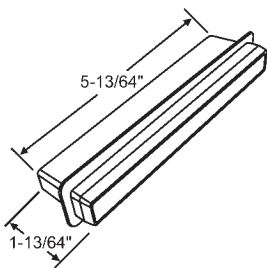

39-536

Gasket Applicator for Maxim® Operators

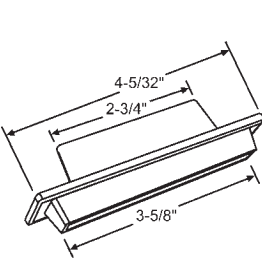

39-513

Gasket Applicator

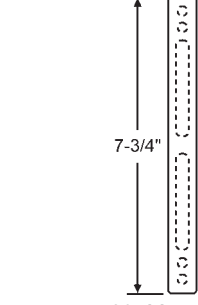

39-44

Operator Gasket

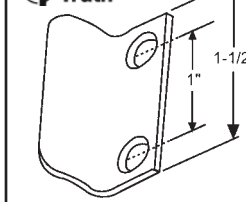

Part #	Finish
39-112	E-Gard Finish
39-112-3	White

Side Jam Snubber

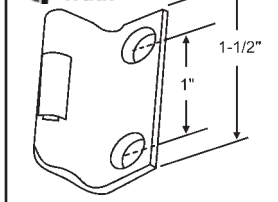

Part #	Finish
39-114-9	Beige
39-114-14	Cocoa Brown
39-114-23	Sandstone

Side Jam Snubber with Vinyl Insert

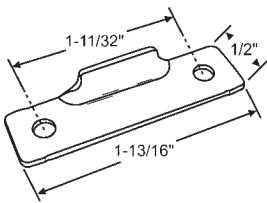

Part #	Finish
39-303	E-Gard
393-303SS	Stainless Steel

Concealed Snubber

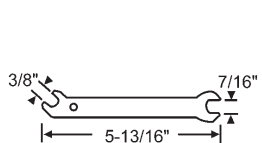

39-462

Combo Stud Wrench



Part #	Description	"A"
39-519	Clear Plastic	7/16"
39-519W	White	7/16"
39-520	Clear Plastic	1/2"
39-437	White	1/2"

Casement Ramp

ACORN

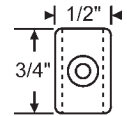
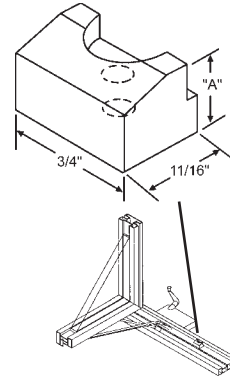

39-611

Slide Block. White
SILVER LINE

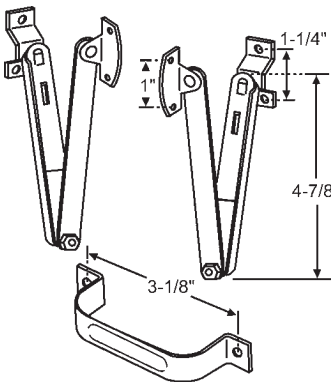

900-15453

Storm Window Adjuster - Pair
Locks window securely when closed.

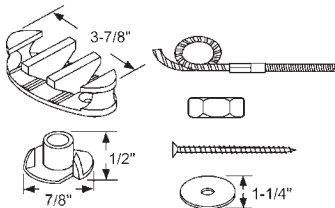

900-22378

Window Cable Support Kit for Bay Window

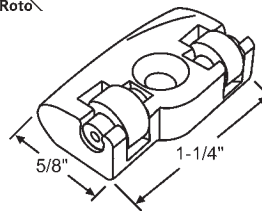

Part #	Finish
39-702B	Black
39-702W	White

Sash Lift

FINGER LATCHES & SLIDE BOLTS

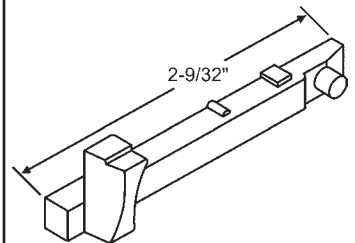

Part #	Hand
900-5736	Shown
900-5735	Opposite

Slide Bolt. Natural Nylon
NEWELL

WINDOW REPLACEMENT HARDWARE

FINGER LATCHES & SLIDE BOLTS

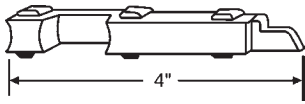

Part #	Finish
46-15A	Natural Nylon

Slide Bolt Set (LH/RH)

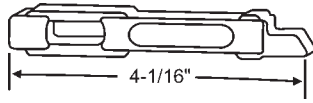

Part #	Finish
46-2A	Mill
46-2WA	White
46-2BA	Brown

Die Cast Set (LH/RH)
CAPITOL

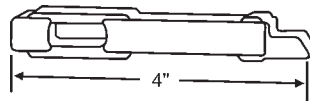

Part #	Finish
46-23A	Natural Nylon

Slide Bolt Set (LH/RH)

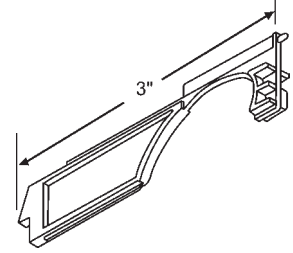

46-30
Die Cast

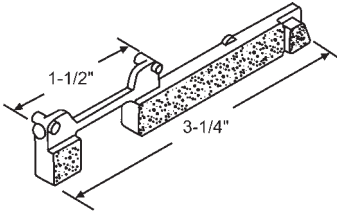

Part #	Hand
46-32	Shown
46-31	Opposite

Die Cast

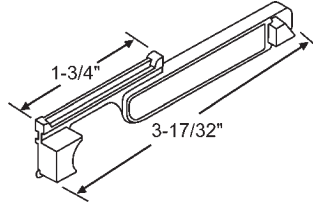

Part #	Hand
46-39	Shown
46-40	Opposite

Die Cast

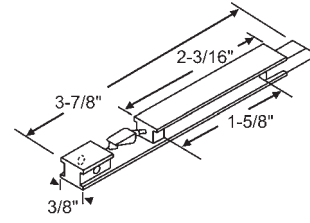

Part #	Finish
46-50A	White Nylon

LH/RH Slide Bolt. Sold in Set (RH Shown)

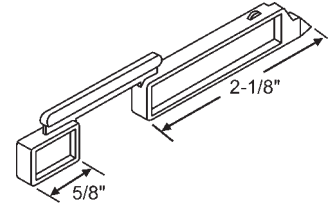

Part #	Hand
46-52	Shown
46-53	Opposite

Natural Nylon

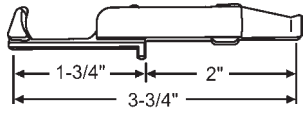

Part #	Hand
900-18534LH	Shown
900-18534RH	Opposite

Die Cast

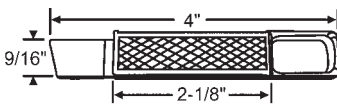

Part #	Hand
900-13501RH	Shown
900-13501LH	Opposite

Bright Zinc, Die Cast

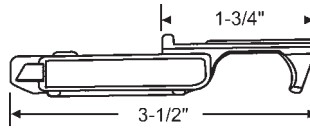

Part #	Hand
900-11890	Shown
900-11891	Opposite

Die Cast

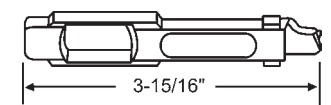

Part #	Hand
900-11877	Shown
900-11878	Opposite

Die Cast
SEASONALL

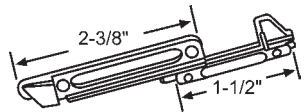

Part #	Hand
900-22011RH	Shown
900-22011LH	Opposite

Die Cast

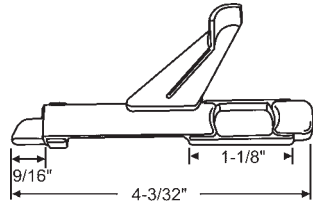

Part #	Hand
900-9297	Shown
900-9298	Opposite

Die Cast
CAPITOL

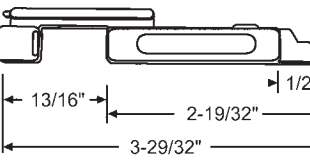

Part #	Finish
900-12146A	Natural Nylon

Slide Bolt Set (LH/RH)

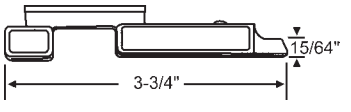

Part #	Hand
46-164LH	Opposite
46-164RH	Shown

White Nylon

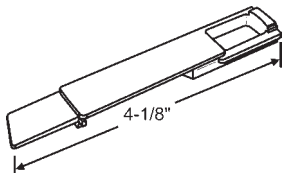

Part #	Hand
900-19289LH	Shown
900-19289RH	Opposite

White Nylon

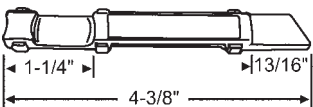

Part #	Hand
900-18849	Shown
900-18850	Opposite

Die Cast

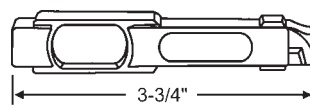

Part #	Hand
900-10187LH	Opposite
900-10187RH	Shown

Die Cast
SEASONALL

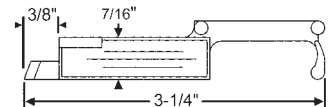

Part #	Hand
900-18535LH	Shown
900-18535RH	Opposite

Die Cast

WINDOW REPLACEMENT HARDWARE

FINGER LATCHES & SLIDE BOLTS

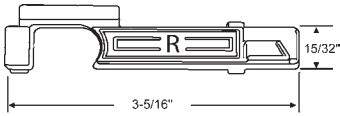

Part #	Hand
46-4	Shown
46-5	Opposite

Die Cast

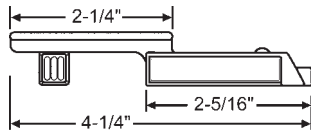

46-358P

Slide Bolt Set (LH/RH). RH Shown. White Plastic.

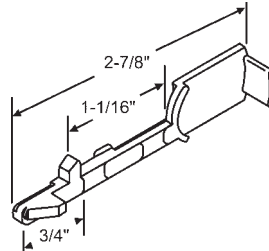

Part #	Hand
900-445LH	Shown
900-445RH	Opposite

Die Cast

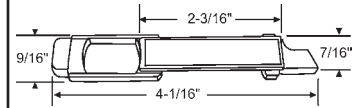

900-17495

Die Cast Set (RH/LH) with Springs
RH Shown

TRACO

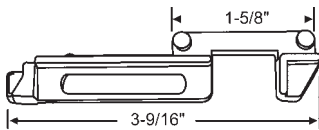

Part #	Hand
900-12610LH	Shown
900-12610RH	Opposite

Die Cast

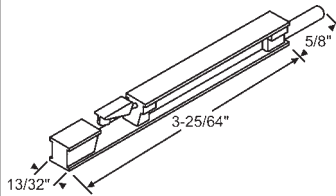

900-1725

Natural Nylon, Non-Hand

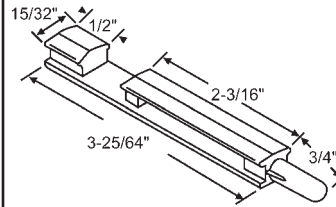

46-280W

Nylon, Non-Hand. White

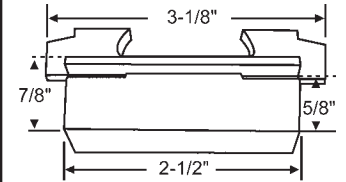

46-122

Black, Plastic

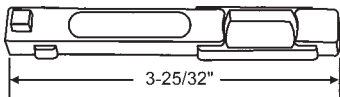

Part #	Hand
46-118	Shown
46-119	Opposite

Die Cast

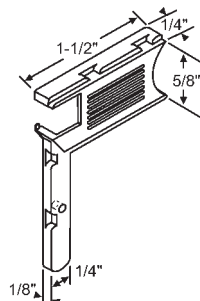

Part #	Hand
900-9229RH	Shown
900-9229LH	Opposite

Die Cast

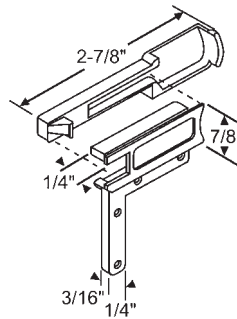

46-33A

Die Cast
Sold in Sets Only

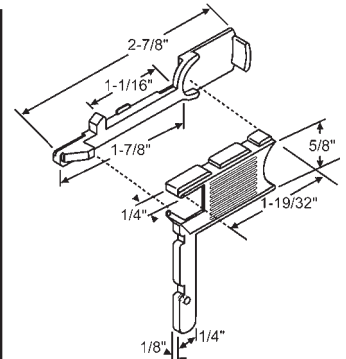

900-1831BA

Plastic Slide Bolt Black
Sold in Sets Only

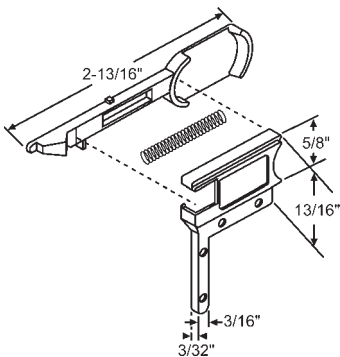

900-18624A

Die Cast Slide Bolt Set. Black
Sold In Sets Only.

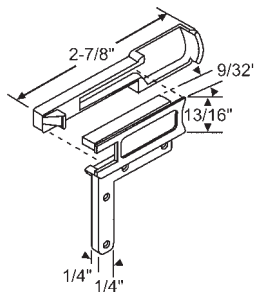

46-35A

Finger Latch Set (LH/RH)
Die Cast

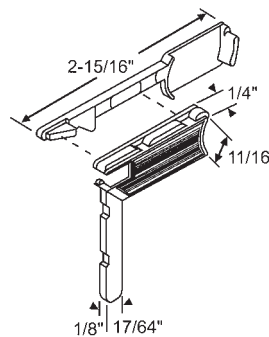

Part #	Hand
46-37	Shown
46-38	Opposite

Die Cast

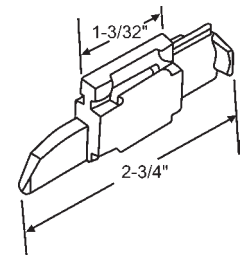

Part #	Hand
900-13382LH	Shown
900-13382RH	Opposite

Die Cast

WINDOW REPLACEMENT HARDWARE

SLIDE BOLT ACCESSORIES

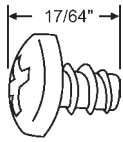

900-13382S
Screw for 900-13382LH/RH

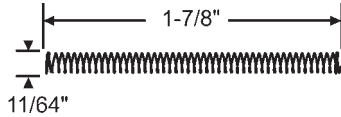

900-13382SP
Spring for 900-13382LH/RH

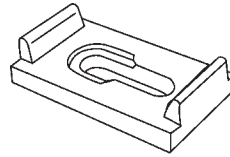

900-13382L
Limit Stop for 900-13382LH & 900-13382RH. Black

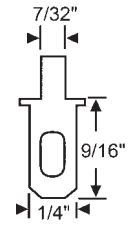

900-13382R
Spring Retainer
Zinc

SLIDE BOLT SPRINGS

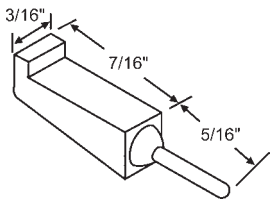

900-5732
Natural Nylon Spring Insert for
900-5735 Slide Bolts/Finger
Latch

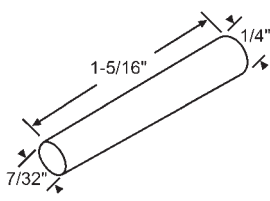

900-17455
Storm Slide Bolt Extension
Natural Nylon

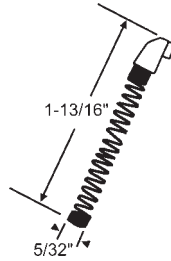

46-10
Plastic Tip

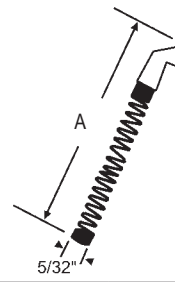

Part #	A
46-28	1-63/64
46-28S	1-5/16"

Plastic Tip

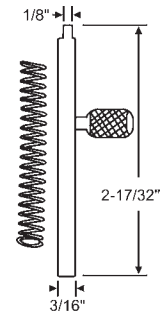

900-9573
Latch Pin Bar with Spring
Aluminum

ANTI-BOW PIN

THERMAL ISOLATOR ASSEMBLY CLIPS

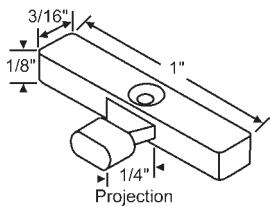

900-11894
Anti-Bow Pin
Die Cast

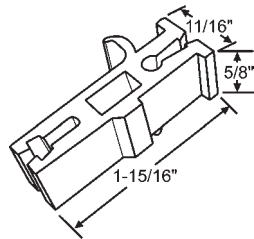

900-5371MODB
White Plastic
ALSCO ANACONDA

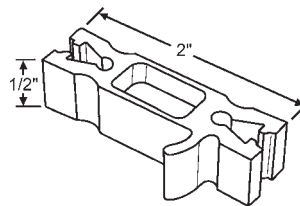

46-386
1"

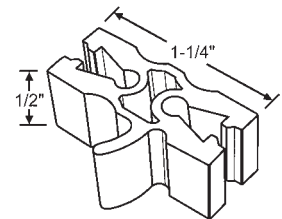

46-386.25

INSERT CLIPS

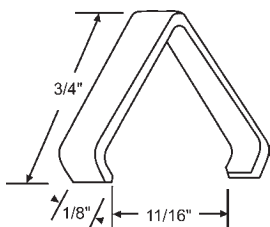

46-1

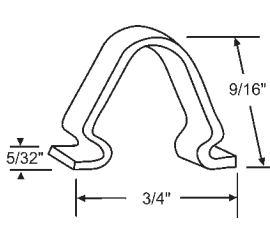

46-6

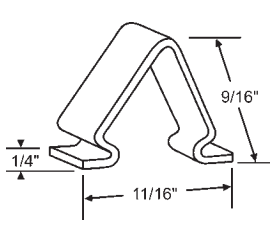

46-22

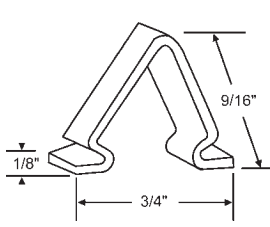

46-126

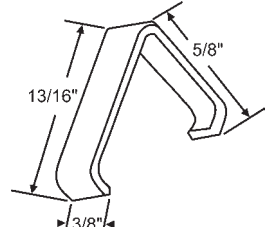

46-218

WINDOW REPLACEMENT HARDWARE

CORNER KEYS

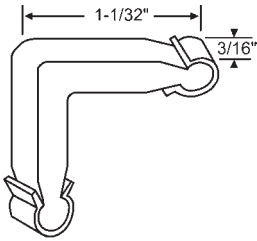

46-11
Universal. Die Cast

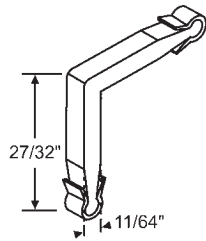

46-124
Die Cast

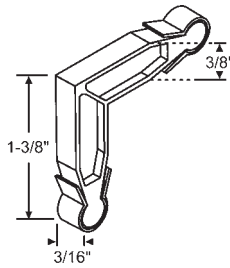

900-17541
Die Cast

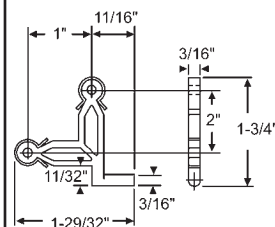

900-17541T
Tilt Window Screen Corner
Die Cast
TRACO

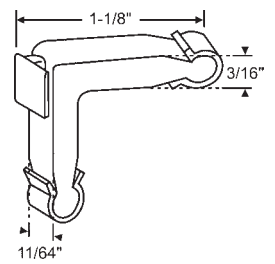

46-9
Die Cast
CAPITOL

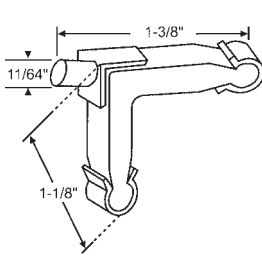

46-8
Die Cast
CAPITOL

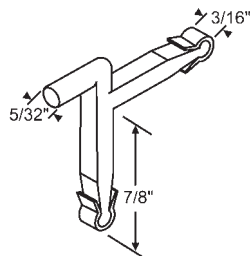

46-125
Die Cast

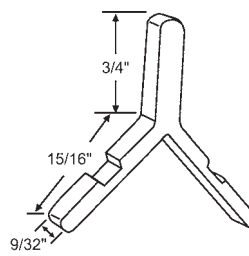

46-21
Aluminum

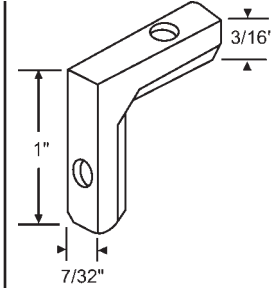

46-12
Die Cast

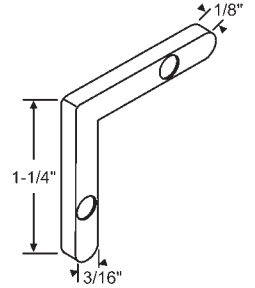

900-479
Die Cast

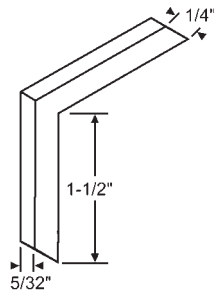

900-14556
Aluminum

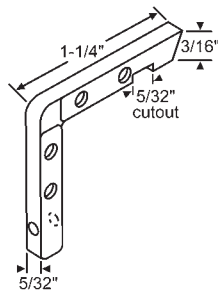

900-11892
Die Cast

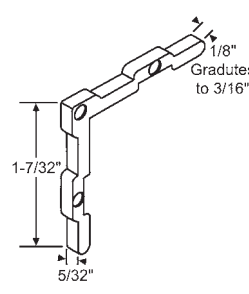

900-11008
Die Cast

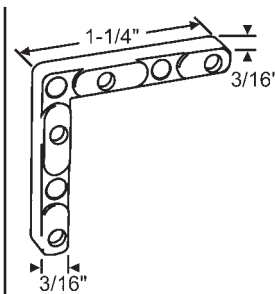

900-481
Die Cast

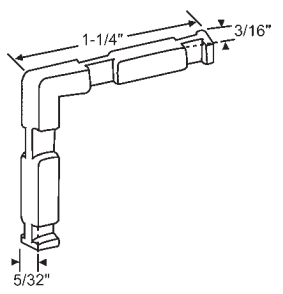

46-66
Die Cast

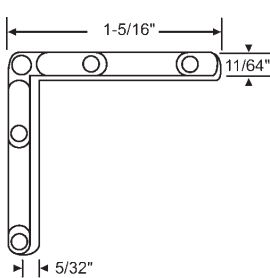

900-15214
Die Cast

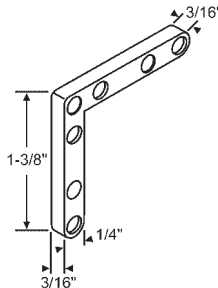

900-12611
Die Cast

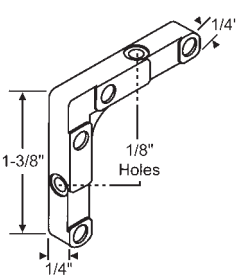

900-14537
Die Cast

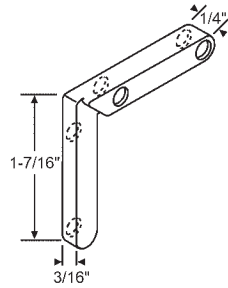

Part #	Hand
900-12612LH	Shown
900-12612RH	Opposite

Die Cast

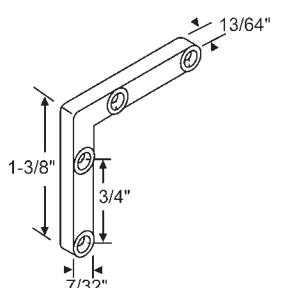

900-21287
Die Cast

WINDOW REPLACEMENT HARDWARE

CORNER KEYS

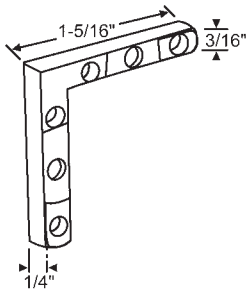

46-86
Die Cast

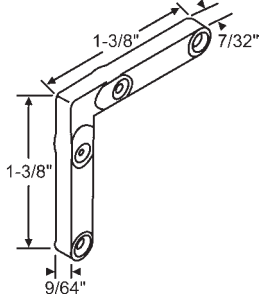

46-80
Die Cast

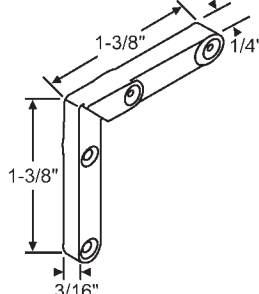

46-82A
Sold in Sets Only
LH Shown. Die Cast

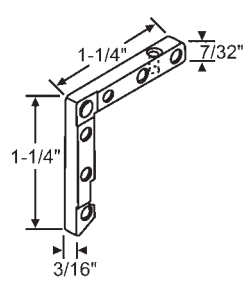

46-120
Die Cast

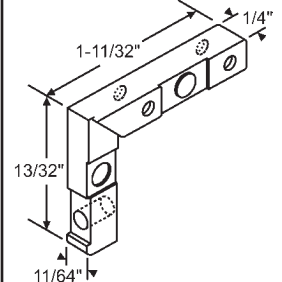

Part #	Hand
900-19065	Shown
900-19066	Opposite

Die Cast

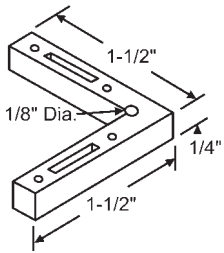

900-7303
Natural Nylon
CROSSLY

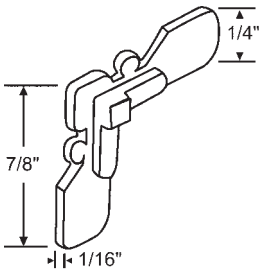

46-25
Die Cast

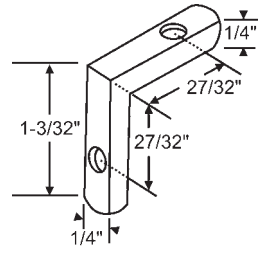

46-263
Zinc Die Cast
HARCAR

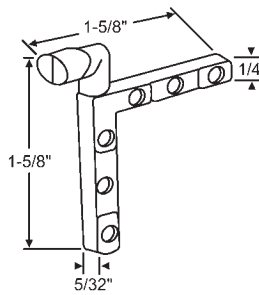

46-27A
Die Cast
Sold in Sets Only
1RH (Shown) & LH

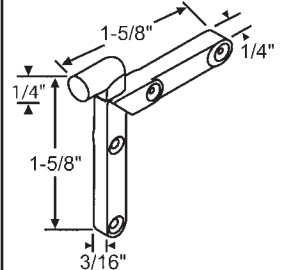

Part #	Hand
46-85	Shown
46-84	Opposite

Die Cast

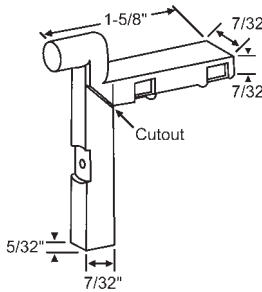

Part #	Hand
46-90	Shown
46-89	Opposite

Die Cast

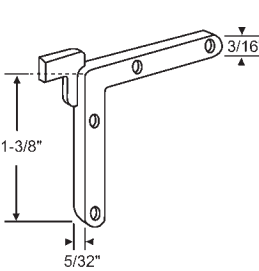

46-7
Die Cast

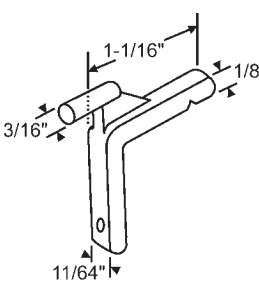

46-142
Die Cast
With Hole & Screw

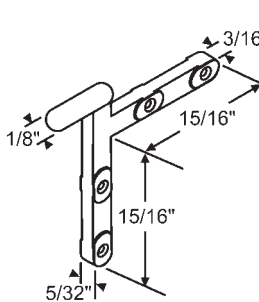

900-18318
Corner Key
Die Cast

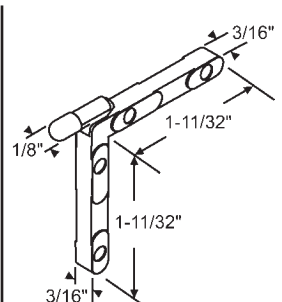

900-464
Die Cast

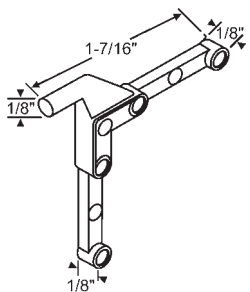

Part #	Hand
900-17595LH	Shown
900-17595RH	Opposite

Die Cast Corner Swivel

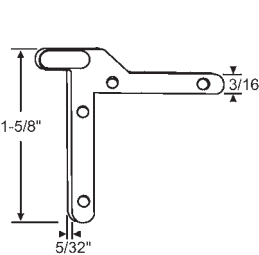

900-11012
Corner Key Pair (LH/RH)
Die Cast

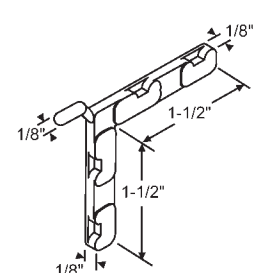

Part #	Hand
900-11924LH	Shown
900-11924RH	Opposite

Die Cast

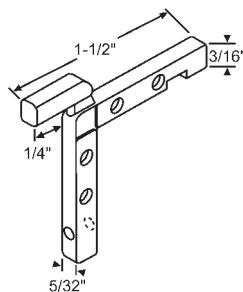

900-11893
Die Cast

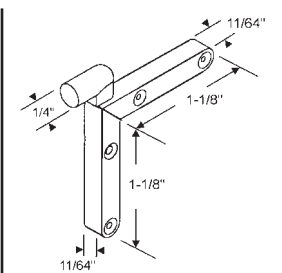

Part #	Hand
900-12613LH	Shown
900-12613RH	Opposite

Die Cast

WINDOW REPLACEMENT HARDWARE

CORNER KEYS

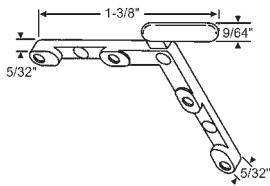

900-19063
Die Cast

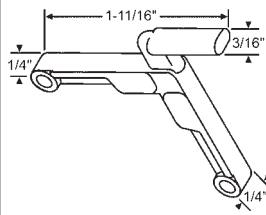

900-19067
Die Cast, Gray

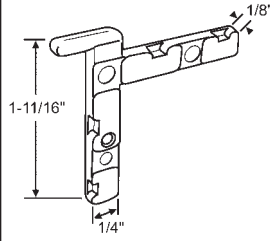

Part #	Hand
900-456LH	Shown
900-456RH	Opposite

Die Cast Tilt Key

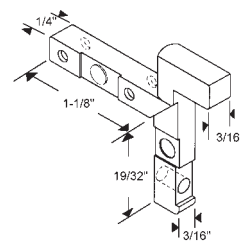

900-19068
Die Cast

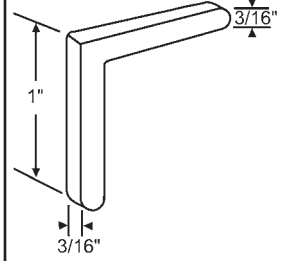

46-19
Natural Nylon

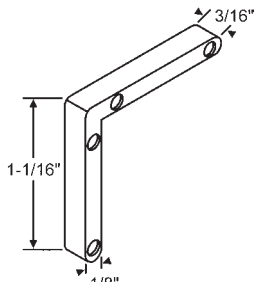

46-121
Natural Nylon
SEASONALL

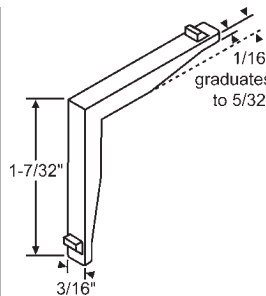

46-138
White Nylon

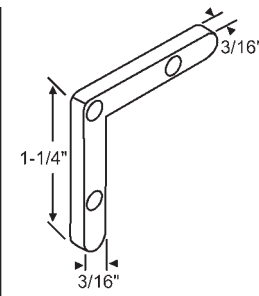

900-2229
Universal
Natural Nylon

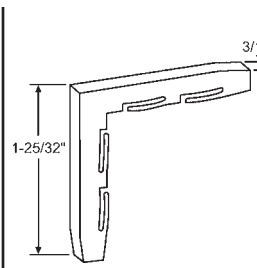

900-19237
White Plastic

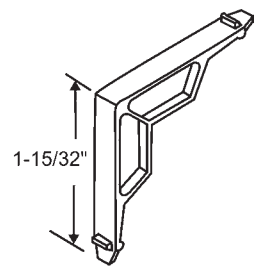

900-2251
Natural Nylon

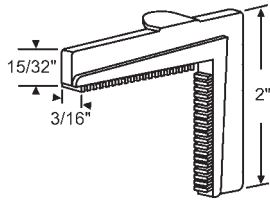

Part #	Hand
900-2256	Shown
900-2257	Opposite

White Nylon

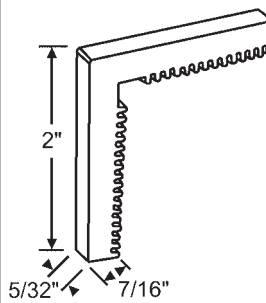

900-2260
White

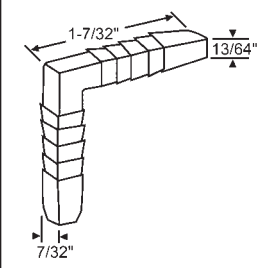

900-2278
White Nylon

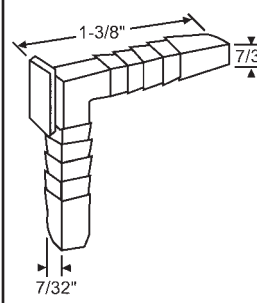

46-20
White Nylon

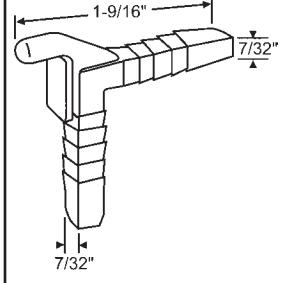

46-26
White Nylon

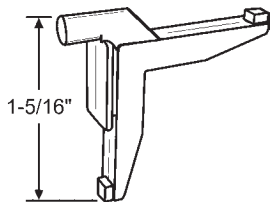

900-9071
White. Top
CAREFREE

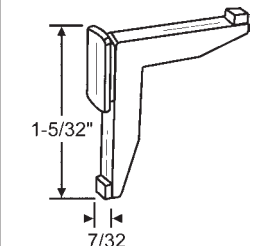

900-9070
White. Bottom.
CAREFREE

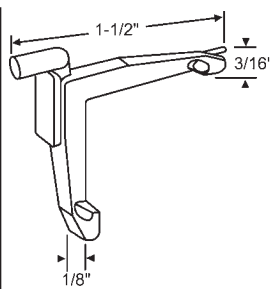

46-17
Universal
Natural Nylon

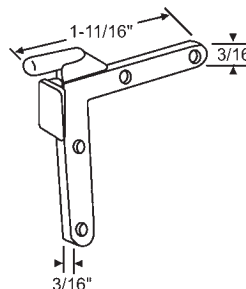

46-18
Nylon
White

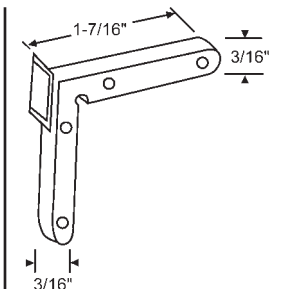

900-2209
Universal
Natural Nylon

WINDOW REPLACEMENT HARDWARE

CORNER KEYS, TILT KEYS

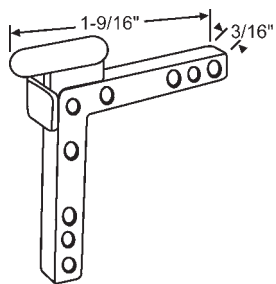

46-163
White Nylon Tilt Key

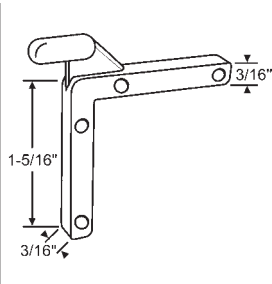

46-285
Universal
White Nylon

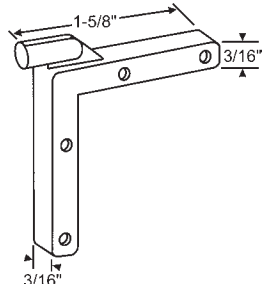

900-2157
Natural Nylon Tilt Key

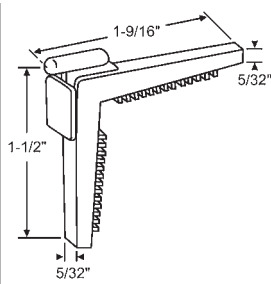

900-2269
Black Nylon Tilt Key

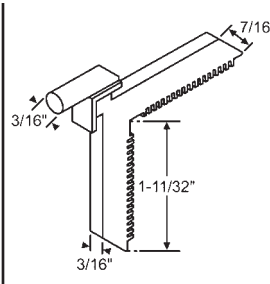

900-15773
Natural Nylon Tilt Corner Key

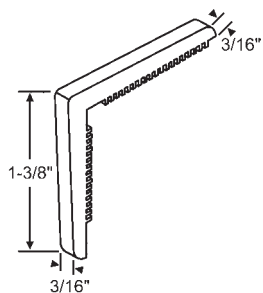

900-15772
Nylon

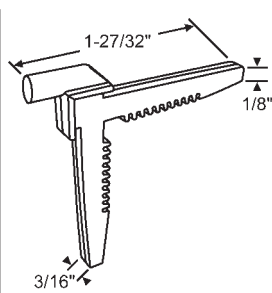

46-107
White Nylon. Saw Tooth Design

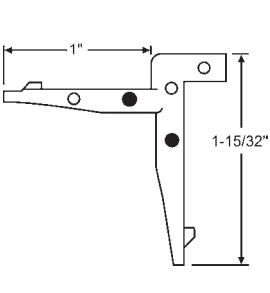

46-137
White Nylon with Edge

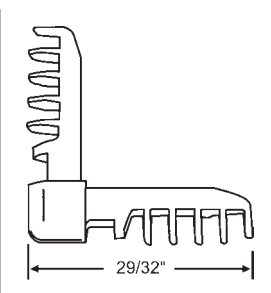

46-269
White Nylon

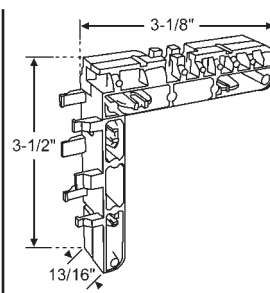

900-19043
White Nylon

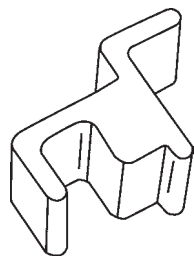

900-21654
Storm Sash Control Button
Die Cast

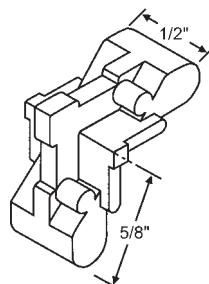

900-14559
Die Cast

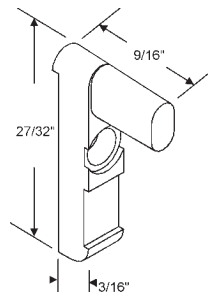

900-10188N
Pivot Key without Screw
Nylon

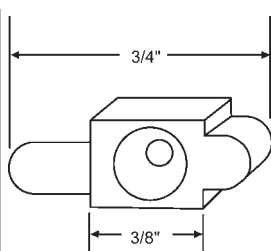

900-5359
Tilt Key. Nylon
Black
ALENCO

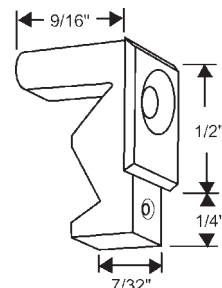

900-5941
Natural Nylon Tilt Key
GALLITAN

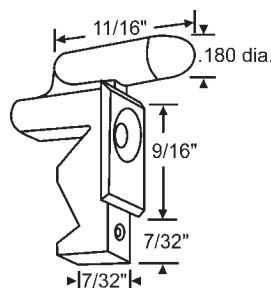

900-5939
Natural Nylon Tilt Key
GALLITAN

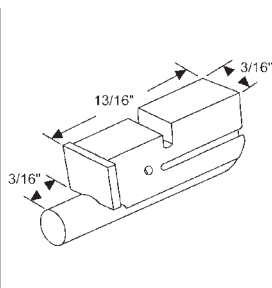

900-2353
Tilt Key
White Nylon

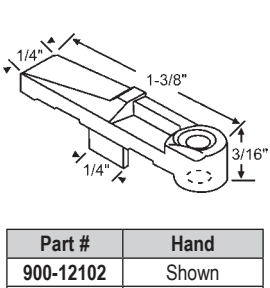

Part #	Hand
900-12102	Shown
900-12101	Opposite

Die Cast. Storm Window &
Door Anti-Bow Latch For Wood
Windows
SEASONALL

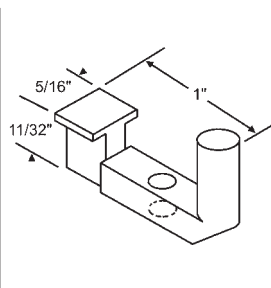

46-116
White
Nylon Tilt Key
SUGARCREEK

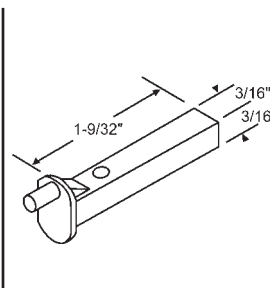

900-2331
Natural Nylon Tilt Key

C-Sash® Components Make Assembly and Installation Easy.

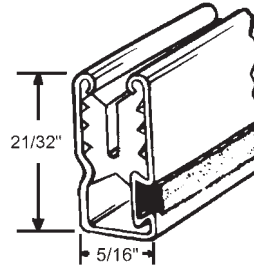
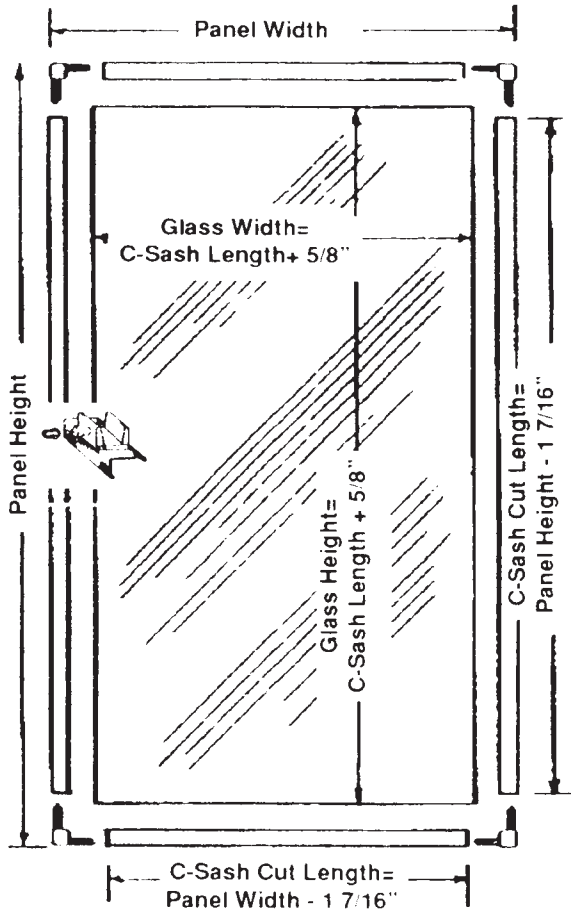

8 Ft. Lengths - 20 lengths per carton

Part #	Color
90-496W-8	White

12 Ft. Lengths - 100 lengths per carton

Part #	Color
90-492M-12	Mill
90-492B-12	Bronze
90-492W-12	White

Press-Lock™ Corners eliminate the need for mitering. Just push into a square-cut corner, no need for staking. Made of high-impact ABS.

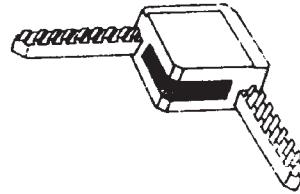

Part #	Color
90-489M	Mill
90-489B	Bronze
90-489W	White

Sill Expander A vinyl section which includes pile weather-strip, slides onto the C-Sash® frame to correct for sill irregularities and to provide weather-scaling along the base of frame.



Part #	Color
90-491B	Bronze
90-491W	White

42" Length

C-Sash® has been a proven performer in the storm window and storm door industry for years. Its unique roll-formed combination of aluminum, gasketing and weather-stripping reduce fabrication time and simplify inventory control. This reliable framing member can be used for:

- External Storm Panels
- Internal Window Panels
- Additional Thermal Protection for
- Picture and Bay Windows
- Storm Door Window Panels
- Up to 1/8" Glass Thickness

*Note C-Sash® cut lengths = Panel Width - 5/8"

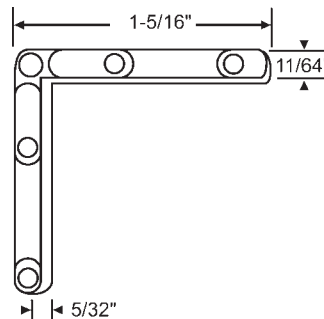

Die Cast Corner Key Zinc Die Cast used for mitered corners.

900-15214

RV & MOBILE HOME HARDWARE

CRANKS, KNOBS, HANDLES AND EXTENSIONS

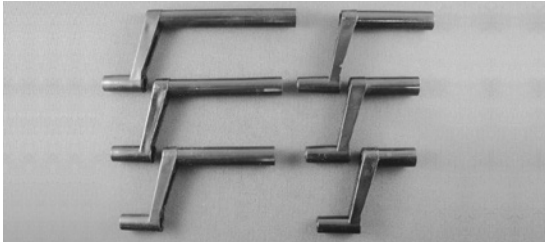

Black Plastic Crank Handle w/Screw
1 Per Card

Part #	Description
838C BLK	1" Plastic Crank
748C BLK	1-3/8" Plastic Crank
881C BLK	1-3/4" Plastic Crank
750C BLK	2-1/4" Plastic Crank
771C BLK	2-1/2" Plastic Crank
712C BLK	3-3/16" Plastic Crank

Black Plastic Crank Handle w/Screw
25 Polybagged

Part #	Description
838P BLK	1" Plastic Crank
748P BLK	1-3/8" Plastic Crank
881P BLK	1-3/4" Plastic Crank
750P BLK	2-1/4" Plastic Crank
771P BLK	2-1/2" Plastic Crank
712P BLK	3-3/16" Plastic Crank

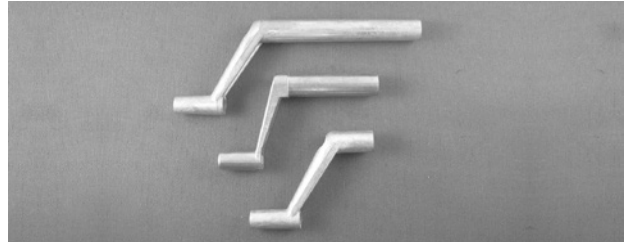

Metal Crank Handle w/Screw
1 Per Card

Part #	Description
889C	1" Metal Crank
795C	1-3/4" Metal Crank
796C	3-1/2" Metal Crank

Metal Crank Handle w/Screw
25 Polybagged

Part #	Description
889P	1" Metal Crank
795P	1-3/4" Metal Crank
796P	3-1/2" Metal Crank



2-1/4" Outside Diameter Black Plastic Knob Handle w/Screw
1 Per Card

Part #	Description
743C BLK	5/16" Shaft
743CE BLK	7/8" Shaft

25 Polybagged

Part #	Description
743P BLK	5/16" Shaft
743PE BLK	7/8" Shaft

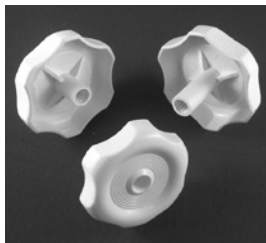

2-1/4" Outside Diameter White Plastic Knob Handle w/Screw
1 Per Card

Part #	Description
743C WHT	5/16" Shaft
743CE WHT	7/8" Shaft

25 Polybagged

Part #	Description
743P WHT	5/16" Shaft
743PE WHT	7/8" Shaft



2-1/8" Outside Diameter White Plastic Kinro Knob Handle w/Screw
1 Per Card

Part #	Description
710C WHT	9/16" Shaft
710CE WHT	13/16" Shaft

Bulk

Part #	Description
710P WHT	9/16" Shaft
710PE WHT	13/16" Shaft



2-1/8" Outside Diameter Black Plastic Kinro Knob Handle w/Screw
1 Per Card

Part #	Description
710C BLK	9/16" Shaft
710CE BLK	13/16" Shaft

1 Polybagged

Part #	Description
710P BLK	9/16" Shaft
710PE BLK	13/16" Shaft



1-5/8" Outside Diameter Mini Black Plastic Knob Handle w/Screw
1 Per Card

Part #	Description
713C BLK	9/16" Shaft

1 Polybagged

Part #	Description
713P BLK	9/16" Shaft



Plastic Tee Handle w/Screw
1 Per Card

Part #	Description
837C	13/16" Shaft

25 Polybagged

Part #	Description
837P	13/16" Shaft



Metal Tee Handle w/Screw
1 Per Card

Part #	Description
776C	1/2" Shaft

10 Polybagged

Part #	Description
776P	1/2" Shaft

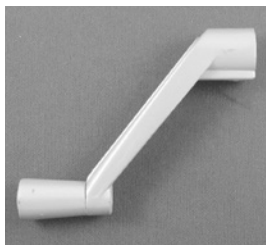

Metal Crank Handle
1 Per Card

Part #	Description
155C	5/16" Hex

1 Polybagged

Part #	Description
37-159	5/16" Hex

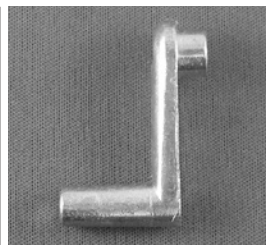

Roof Vent Crank Handle w/Screw
1 Per Card

Part #	Description
783C	1/4" Shaft

1 Polybagged

Part #	Description
783P	1/4" Shaft

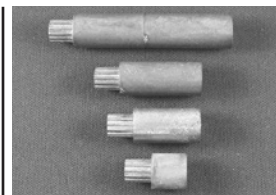

Metal Extension w/Screw
1 Per Card

Part #	Description
831C	1/2" Metal Extension
832C	7/8" Metal Extension
833C	1-1/8" Metal Extension
834C	2" Metal Extension

25 Polybagged

Part #	Description
831P	1/2" Metal Extension
832P	7/8" Metal Extension
833P	1-1/8" Metal Extension
834P	2" Metal Extension

OPERATORS AND OPERATOR KITS

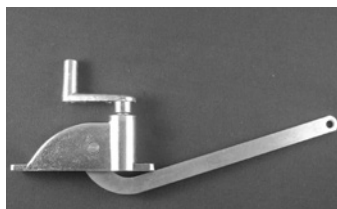

Roof Vent Operator Kit
2-15/16" cc Mounting Holes
1 Kit Per Card

Part #	Description
898CK	5" Arm
806CK	5-3/8" Arm
807CK	7-11/16" Arm

1 Kit Polybagged

Part #	Description
898PK	5" Arm
806PK	5-3/8" Arm
807PK	7-11/16" Arm



Roof Vent Operator Kit
2-15/16" cc Mounting Holes.
1 Kit Per Card

Part #	Description
814CK	6" Arm

1 Kit Polybagged

Part #	Description
814PK	6" Arm



Slant Sill Side Mount Torque Operator
1/2" ID Hole, w/ 3/16" Hub Projection.
1 Per Card

Part #	Description
761C	RH Operator - Shown
762C	LH Operator - Opposite

1 Polybagged

Part #	Description
761P	RH Operator - Shown
762P	LH Operator - Opposite

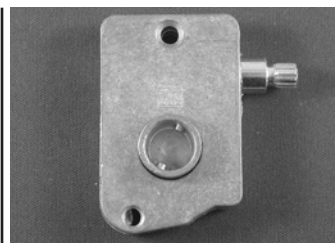

Philips Side Mount Operator
1/2" ID Hole, w/3/16" Hub Projection.
1 Per Card

Part #	Description
735C	RH Operator - Shown
736C	LH Operator - Opposite

1 Polybagged

Part #	Description
735P	RH Operator - Shown
736P	LH Operator - Opposite

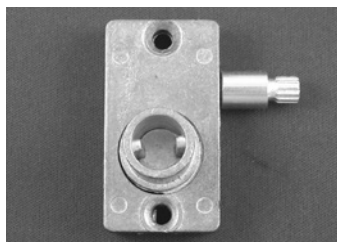

Small Side Mount Operator
1/2" ID Hole, w/ 5/8" Hub Projection (pictured)
1 Polybagged

Part #	Description
758PR	RH Operator - Shown
758PL	LH Operator - Opposite

1/2" ID Hole, w/ 1/8" Hub Projection

Part #	Description
804PR	RH Operator - Shown
804PL	LH Operator - Opposite



Philips Side Mount Operator
1/2" ID Hole, w/11/16" Hub Projection.
1 Per Card

Part #	Description
787CR	RH Operator - Shown
787CL	LH Operator - Opposite

1 Polybagged

Part #	Description
787PR	RH Operator - Shown
787PL	LH Operator - Opposite

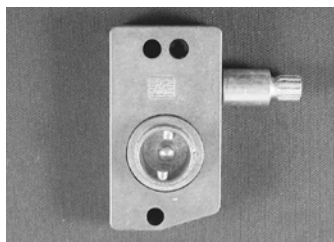

Side Mount Operator
1/2" ID Hole, w/1/4" Hub Projection.
1 Per Card

Part #	Description
1712C	RH Operator - Shown
1713C	LH Operator - Opposite

1 Polybagged

Part #	Description
1712P	RH Operator - Shown
1713P	LH Operator - Opposite



Side Mount Operator
1/2" ID Hole, w/1/2" Hub Projection.
1 Per Card

Part #	Description
1716C	RH Operator - Shown
1717C	LH Operator - Opposite

1 Polybagged

Part #	Description
1716P	RH Operator - Shown
1717P	LH Operator - Opposite

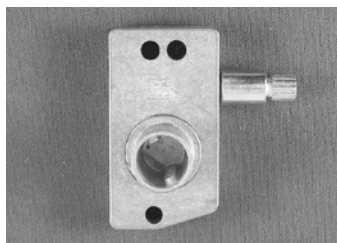

Side Mount Operator
1/2" ID Hole, w/11/16" Hub Projection.
1 Per Card

Part #	Description
1718C	RH Operator - Shown
1719C	LH Operator - Opposite

1 Polybagged

Part #	Description
1718P	RH Operator - Shown
1719P	LH Operator - Opposite



Side Mount Operator
1/2" ID Hole, w/1/2" Hub Projection.
1 Per Card

Part #	Description
808CR	RH Operator - Shown
808CL	LH Operator - Opposite

1 Polybagged

Part #	Description
808PR	RH Operator - Shown
808PL	LH Operator - Opposite



Side Mount Torque Bar Operator Kit
1/2" ID Hole, w/1/2" Hub Projection.
1 Per Card

Part #	Description
808CKR	RH Operator - Shown
808CKL	LH Operator - Opposite

1 Polybagged

Part #	Description
808PKR	RH Operator - Shown
808PKL	LH Operator - Opposite

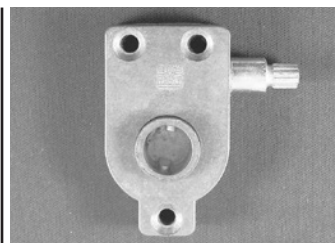

Side Mount Operator
1/2" Hole, w/1/8" Hub Projection
1 Per Card

Part #	Description
747CR	RH Operator - Shown
747CL	LH Operator - Opposite

1 Polybagged

Part #	Description
747PR	RH Operator - Shown
747PL	LH Operator - Opposite



Side Mount Operator

3/8" Square w/1/8" Hub Projection
1 Per Card

Part #	Description
749CR	RH Operator - Shown
749CL	LH Operator - Opposite

1 Polybagged

Part #	Description
749PR	RH Operator - Shown
749PL	LH Operator - Opposite

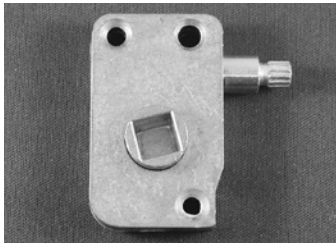

RH Side Mount Operator

3/8" Square w/3/16" Hub Projection
1 Per Card

Part #	Description
733C	Non-Handed

1 Polybagged

Part #	Description
733P	Non-Handed

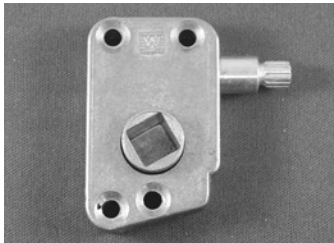

Slant Sill Side Mount Operator

3/8" Square w/1/4" Hub Projection.
1 Per Card

Part #	Description
715CR	RH Operator - Shown
715CL	LH Operator - Opposite

1 Polybagged

Part #	Description
715PR	RH Operator - Shown
715PL	LH Operator - Opposite



Side Mount Operator

3/8" Square with No Hub Projection (Flush)
1 Polybagged

Part #	Description
1709P	Non-Handed



Side Mount Operator

1/2" ID Hole, w/1/8" Hub Projection.
1 Per Card

Part #	Description
751CR	RH Operator - Shown

1 Polybagged

Part #	Description
751PR	RH Operator - Shown

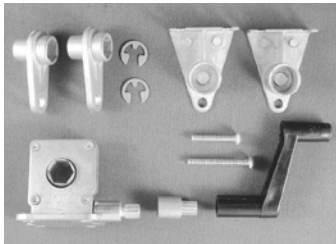

Center Mount Operator Kit w/3/8" Hex

1 Kit Per Card

Part #	Description
802CK	1-1/4" x 1" Mounting Holes

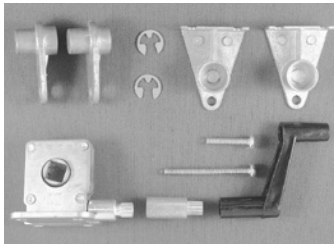

Center Mount Operator Kit w/5/16" Square

1 Kit Per Card

Part #	Description
803CK	1-1/4" x 1" Mounting Holes

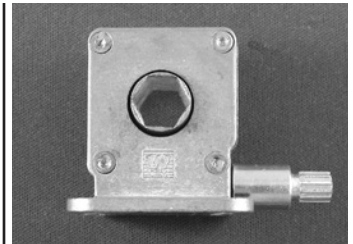

Center Mount Operator with 3/8" Hex

1 Per Card

Part #	Description
802C	1-1/4" x 1" Mounting Holes

1 Polybagged

Part #	Description
802P	1-1/4" x 1" Mounting Holes

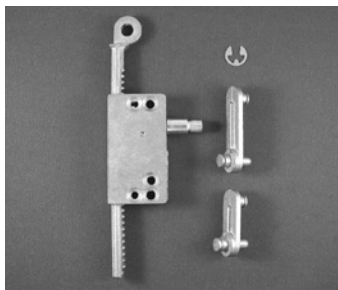

Rack Operator with Links and E-Ring

1 Per Card

Part #	Description
800C	2-1/8" Mounting Holes

1 Kit Polybagged

Part #	Description
800P	2-1/8" Mounting Holes

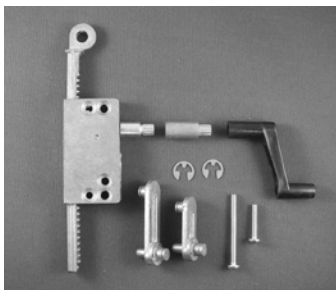

Rack Gear Replacement Operator Kit

1 Kit Per Card

Part #	Description
800CK	2-1/8" or 1-25/32" cc Mounting Holes

1 Kit Polybagged

Part #	Description
800PK	2-1/8" or 1-25/32" cc Mounting Holes

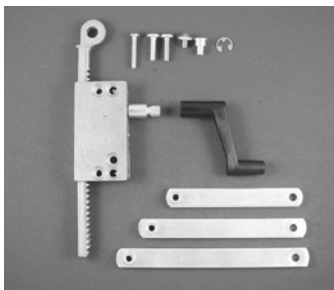

Rack Gear Replacement Operator Kit

1 Kit Per Card

Part #	Description
816C	2-1/8" or 1-25/32" cc Mounting Holes

1 Kit Polybagged

Part #	Description
816P	2-1/8" or 1-25/32" cc Mounting Holes

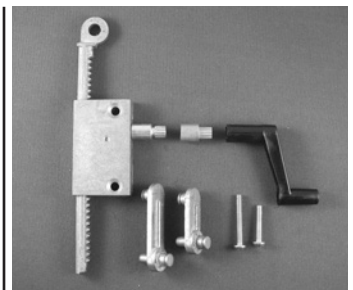

Rack Gear Replacement Operator Kit

1 Kit Per Card

Part #	Description
801CK	1-25/32" cc Mounting Holes

1 Kit Polybagged

Part #	Description
801PK	1-25/32" cc Mounting Holes

E-RINGS AND GROOVE PINS

TORQUE BAR BEARINGS



E-Ring
8 Per Card

Part #	Description
325CE	Small 3/16"
328CE	Large 1/4"
324CE	X-Large 5/16"

8 Polybagged

Part #	Description
325PE	Small 3/16"
328PE	Large 1/4"
6-110	X-Large 5/16"



Groove Pin w/Clip
4 Per Card

Part #	Description
328C	Large 1/4"
325C	Groove Pin Only

1 Polybagged

Part #	Description
20-409	Large 1/4"
325P	Groove Pin Only



Nylon Torque Bar Bearing
1 Per Card

Part #	Description
763C	1/2" ID x 7/8" High

2 Per Card

Part #	Description
763C2	1/2" ID x 7/8" High

25 Polybagged

Part #	Description
763P	1/2" ID x 7/8" High

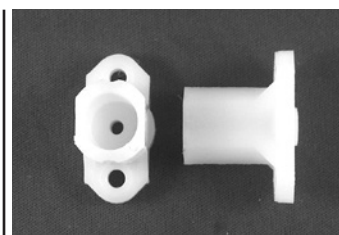

Nylon Torque Bar Bearing
1 Per Card

Part #	Description
784C	1/2" ID x 1-1/16" High

2 Per Card

Part #	Description
784C2	1/2" ID x 1-1/16" High

25 Polybagged

Part #	Description
784P	1/2" ID x 1-1/16" High



Nylon Torque Bar Bearing
1 Per Card

Part #	Description
1774C	1/2" ID x 3/4" High

2 Per Card

Part #	Description
1774C2	1/2" ID x 3/4" High

25 Polybagged

Part #	Description
1774P	1/2" ID x 3/4" High



Nylon Torque Bar Bearing
1 Per Card

Part #	Description
1770C	1/2" ID x 3/4" High

2 Per Card

Part #	Description
1770C2	1/2" ID x 3/4" High

25 Polybagged

Part #	Description
1770P BLK	1/2" ID x 3/4" High

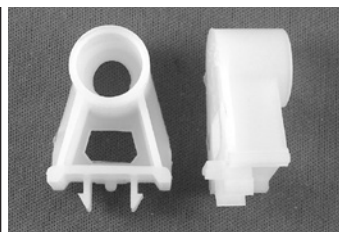

Nylon Torque Bar Bearing
2 Per Card

Part #	Description
1703C	1/2" ID

25 Polybagged

Part #	Description
1703P	1/2" ID

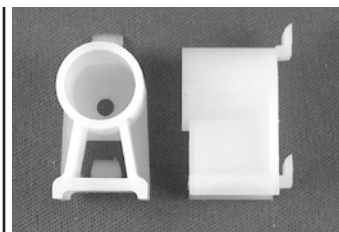

Nylon Philips Torque Bar Bearing
2 Per Card

Part #	Description
738C	1/2" ID

25 Polybagged

Part #	Description
738P	1/2" ID



Nylon Torque Bar Bearing
2 Per Card

Part #	Description
33-184C	Nylon Torque End Bearing

1 Per Poly Bag

Part #	Description
33-184	Nylon Torque End Bearing

KINRO

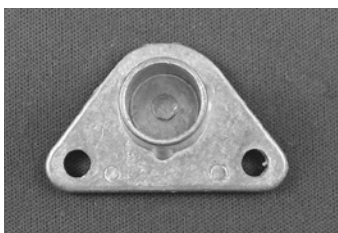

Metal Torque Bar Bearing 1/2" ID
1 Per Polybag

Part #	Description
719P	1-5/16" CC Mounting Holes



Torque Bar Bearing
2 Per Card

Part #	Description
1778C	Torque Bar Bearing

1 Per Poly Bag

Part #	Description
1778P	Torque Bar Bearing

KINRO



Metal Torque Bar Bearing 1/2" ID
1 Per Polybag

Part #	Description
760P	7/8" x 9/16" Bottom Measurements

RV & MOBILE HOME HARDWARE

TORQUE BAR BEARINGS

TORQUE BAR BUSHING

TORQUE BAR ARMS

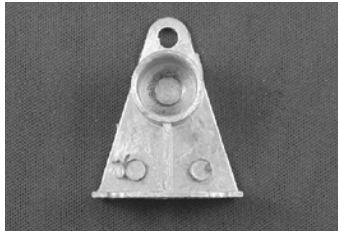

Metal Torque Bar Bearing
1/2" ID
1 Per Polybag

Part #	Description
845P	7/8" cc Bottom Mounting Holes



Torque Bar Bushing
2 Per Card

Part #	Description
720C	Metal Torque Bar Bushing

1 Per Poly Bag

Part #	Description
720P	Metal Torque Bar Bushing

HEHR

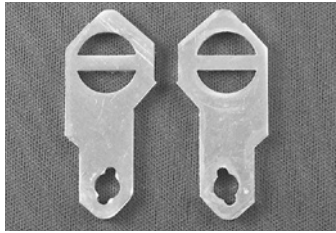

Metal Philips Torque Bar Arm
2 Per Card

Part #	Description
785C	1/2" ID / 1-11/16" Long

25 Polybagged

Part #	Description
785P	1/2" ID / 1-11/16" Long



Metal Torque Bar Arm
1 Per Polybag

Part #	Description
788P	For 1/2" OD Bar / 1-11/16" Long

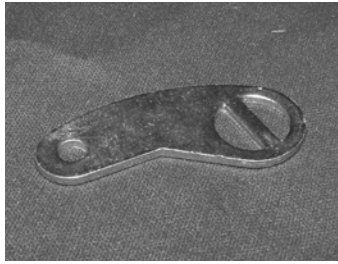

Metal Torque Bar Arm
2 Per Card

Part #	Description
33-185C	Metal Torque Bar Arm

1 Per Poly Bag

Part #	Description
33-185	Metal Torque Bar Arm

KINRO



Metal Torque Bar Arm
1 Per Polybag

Part #	Description
724PS	3/8" Square / 1-9/16" Long



Metal Torque Bar Arm
2 Per Card

Part #	Description
33-191C	Short Torque Arm

1 Per Poly Bag

Part #	Description
33-191	Short Torque Arm

HEHR



Metal Torque Bar Arm
2 Per Card

Part #	Description
33-192C	Long Torque Arm

1 Per Poly Bag

Part #	Description
33-192	Long Torque Arm

HEHR

LINK ARMS

TORQUE BARS



Metal Link Arm
2 Per Card

Part #	Description
33-193C	Short Link Arm

1 Per Poly Bag

Part #	Description
33-193	Short Link Arm

HEHR



Metal Link Arm
2 Per Card

Part #	Description
33-194C	Link Arm

1 Per Poly Bag

Part #	Description
33-194	Link Arm

KINRO

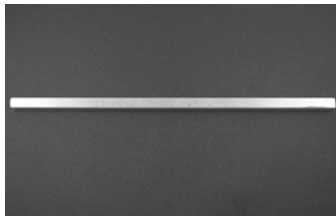

Square Torque Bar
1 Per Polybag

Part #	Description
752PY	5/16" Dia. x 48" Long

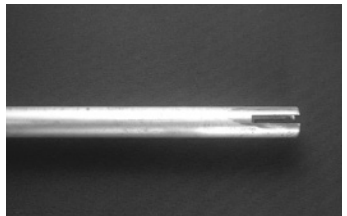

Round Torque Bar
1 Per Polybag

Part #	Description
756PX	1/2" Dia. x 36" Long

756PY	1/2" Dia. x 48" Long
-------	----------------------

VENT HINGES

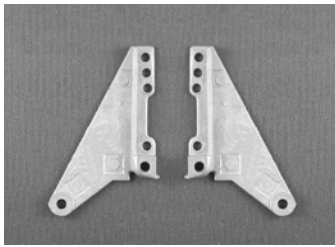

Hehr Small Metal Vent Hinge
1 Pair Per Card

Part #	Description
729C	Vent Hinge

1 Per Polybag

Part #	Description
729P	Vent Hinge

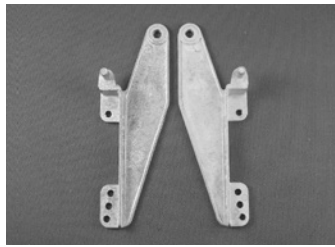

Metal Vent Hinge w/Stud
1 Pair Per Card

Part #	Description
835C	4-3/8" Long

25 Polybagged

Part #	Description
835P	4-3/8" Long

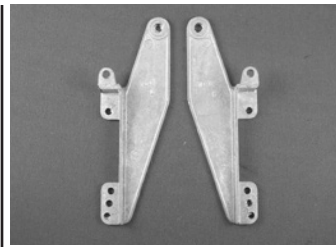

Metal Vent Hinge without Stud
1 Pair Per Card

Part #	Description
836C	4-3/8" Long

25 Polybagged

Part #	Description
836P	4-3/8" Long

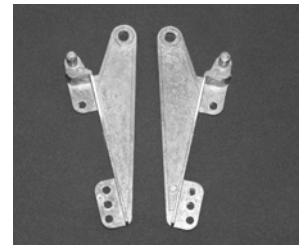

Metal Vent Hinge
1 Pair Per Card

Part #	Description
786C	3-7/8" Long

25 Polybagged

Part #	Description
786P	3-7/8" Long

WINDOW LATCH



Metal Vent Hinge
1 Pair Per Card

Part #	Description
826C	4-5/16" Long

25 Polybagged

Part #	Description
826P	4-5/16" Long

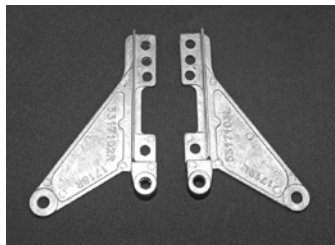

Metal Vent Hinge
1 Pair Per Card

Part #	Description
1749C	Metal Vent Hinge Set

1 Pair Per Polybag

Part #	Description
1749P	Metal Vent Hinge Set

KINRO



Philips Nylon Window Latch Set
1 Set Per Card

Part #	Description
1723C	Black Latch Set - LH/RH

1 Set Per Polybag

Part #	Description
1723P	Black Latch Set - LH/RH

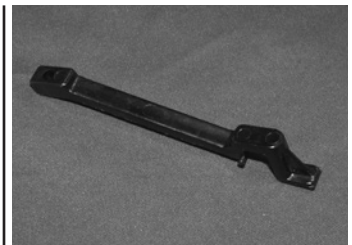

Window Latch Set
2 Per Card

Part #	Description
90-1139C	Black Nylon

1 Per Poly Bag

Part #	Description
90-1139	Black Nylon

HEHR

UNIVERSAL SLIDE LATCH

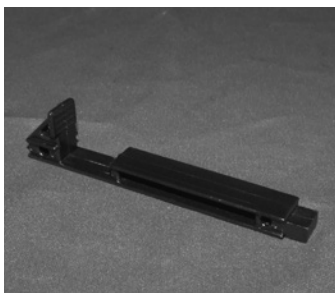

Universal Slide Latch
2 Per Card

Part #	Description
46-365BC	Black Nylon

1 Per Poly Bag

Part #	Description
46-365B	Black Nylon

KINRO

LATCH ASSEMBLY



Latch Assembly
1 Per Card

Part #	Description
50-1131C	Black Nylon

1 Per Poly Bag

Part #	Description
50-1131	Black Nylon

KINRO

NYLON SASH LOCK BRACKET



Nylon Sash Lock Bracket
1 Per Card

Part #	Color
50-1451C	Black
50-1451RDC	Red

1 Per Poly Bag

Part #	Color
50-1451	Black
50-1451RD	Red

1-5/8" Tall

ATWOOD



Nylon Sash Lock Bracket
1 Per Card

Part #	Color
50-1452C	Black
50-1452RDC	Red

1 Per Poly Bag

Part #	Color
50-1452	Black
50-1452RD	Red

2" Tall

ATWOOD

SASH LOCKS

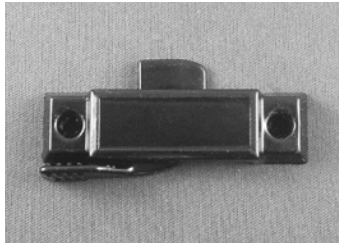

Single Hung Black Sash Lock w/Screws
1 Per Card

Part #	Description
4290C BLK	2-1/4" cc Mounting Holes

1 Set Per Polybag

Part #	Description
50-603B	2-1/4" cc Mounting Holes



Single Hung Black Sash Lock w/Screws
1 Per Card

Part #	Description
50-766C	Black Nylon

1 Per Poly Bag

Part #	Description
50-766	Black Nylon

HEHR

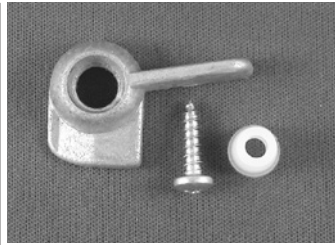

Single Hung Sash Lock Assembly
1 Per Card

Part #	Description
1233C	Chrome Sash Lock - RH

5 Per Polybag

Part #	Description
50-624RHA	Chrome Sash Lock - RH

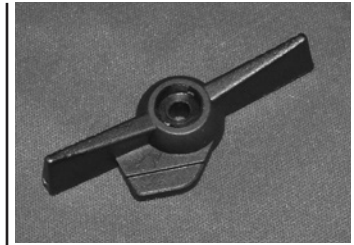

Black Plastic Sash Latch
1 Pair Per Card

Part #	Description
50-1450C	RH/LH Pair

1 Per Poly Bag

Part #	Description
50-1450LH	LH Sash Latch (Shown)
50-1450RH	RH Sash Latch (Opposite)

HEHR

LEVER LATCHES

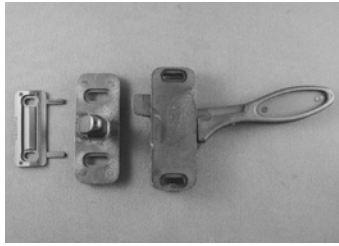

Philips Storm Door Lever Latch
1 Per Card

Part #	Description
17-180RHBC	RH Black - Shown
17-180LHBC	LH Black - Opposite

1 Per Polybag

Part #	Description
17-180RHB	RH Black - Shown
17-180LHB	LH Black - Opposite



Screen Door Lever Handle
1 Per Card

Part #	Description
17-192RHBC	RH Black - Shown

1 Per Polybag

Part #	Description
17-192RHB	RH Black - Shown



Amerimax Storm Door Lever Latch
1 Per Card

Part #	Description
17-166RHBC	RH Black - Shown
17-166LHBC	LH Black - Opposite

1 Per Polybag

Part #	Description
17-166RHB	RH Black - Shown
17-166LHB	LH Black - Opposite

PUSH BAR ASSEMBLY

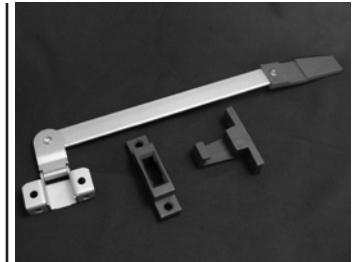

Push Bar Assembly
1 Set Per Card

Part #	Description
29-270C	Red R/V Push Bar Assembly

1 Set Per Poly Bag

Part #	Description
29-270	Red R/V Push Bar Assembly

KINRO

METAL SPRING

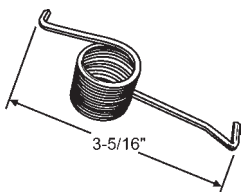

1 Pair Per Card

Part #	Description
5-124C	RH/LH Pair

1 Per Poly Bag

Part #	Description
5-124LH	LH Spring (Shown)
5-124RH	RH Spring (Opposite)

HEHR

JALOUSIE OPERATOR & HANDLE



Universal Kit - Aluminum Finish
1 Per Card

Part #	Description
4000CK	Jalousie Operator

1 Per Polybag

Part #	Description
41J-4000PK	Jalousie Operator



Jalousie Tee Handle
1 Per Card

Part #	Description
306CAJ	5/16" Aluminum

1 Per Polybag

Part #	Description
37-106	5/16" Aluminum

TRAILER LATCH



1 Per Card

Part #	Description
4244CA	Low Profile Trailer Lock w/Key

1 Per Polybag

Part #	Description
17-21KA	Low Profile Trailer Lock w/Key

Aluminum

INSECT SCREENING

SCREEN SPLINE



Charcoal Fiberglass
1 Roll

Part #	Description
69-61-7	36" Wide x 7' Long



Hollow Round Gray Screen Spline
1 Per Card

Part #	Description
310C	.156 (5/32") dia. x 20 ft.

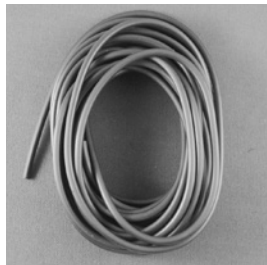

Hollow Round Black Screen Spline
1 Per Card

Part #	Description
309C BLK	.140 (9/64") dia. x 20 ft.
310C BLK	.156 (5/32") dia. x 20 ft.



Hollow Serrated Gray Screen Spline
1 Per Card

Part #	Description
2327C	.140 (9/64") dia. x 20 ft.



Hollow Serrated Black Screen Spline
1 Per Card

Part #	Description
2327C BLK	.140 (9/64") dia. x 20 ft.

INSTALLATION TOOL

RADIUS SCREEN CORNER

SCREEN CLIP

CLIPS



Screen Installation Tool
1 Per Card

Part #	Description
1201C	1/16" Nylon Wheels
1202C	5/32" Nylon Wheels

Bulk

Part #	Description
59-10SP	1/16" Nylon Wheels
59-10	5/32" Nylon Wheels

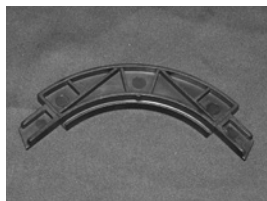

Radius Screen Corner
2 Per Card

Part #	Description
90-1136C	Black

1 Per Poly Bag

Part #	Description
90-1136	Black

HEHR

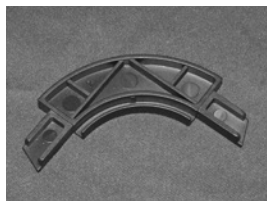

Radius Screen Corner
2 Per Card

Part #	Description
90-1137C	Black

1 Per Poly Bag

Part #	Description
90-1137	Black

HEHR

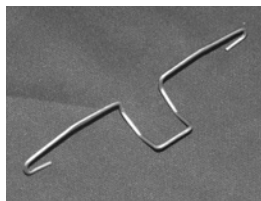

Metal Screen Clip
2 Per Card

Part #	Description
90-1138C	Metal

1 Per Poly Bag

Part #	Description
90-1138	Metal

HEHR

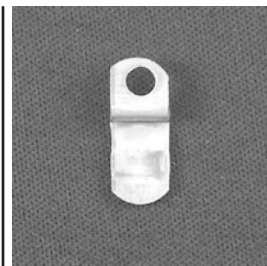

Zee Clip w/Screws
6 Per Card

Part #	Description
350C	Metal / 1/8" Offset

CLIPS

LAVATORY AND TUB STOPPER



Nylon Screen Clip w/Screws
6 Per Card

Part #	Description
492C	Flush
494C	1/16" Offset
495C	3/16" Offset
496C	1/4" Offset
497C	5/16" Offset
498C	3/8" Offset
499C	7/16" Offset



Nylon Screen Clip, No Screws
25 Polybagged

Part #	Description
90-834	Flush
90-78	1/16" Offset
90-381	3/16" Offset
90-837	1/4" Offset
90-332	5/16" Offset
90-379	3/8" Offset
90-380	7/16" Offset

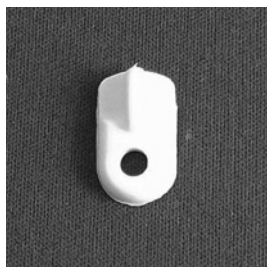

Nylon Screen Clip w/Screws
6 Per Card

Part #	Description
490C	Flat, No Offset

Nylon Screen Clip No Screws
25 Polybagged

Part #	Description
90-77	Flat, No Offset



Lavatory Stopper
1 Per Card

Part #	Finish
P-500C	Chrome
P-500WC	White

1 Poly Bag

Part #	Description
P-500	Chrome
P-500W	White



Tub Stopper
1 Per Card

Part #	Finish
P-600C	Chrome
P-600WC	White

1 Poly Bag

Part #	Description
P-600	Chrome
P-600W	White

RV & MOBILE HOME HARDWARE

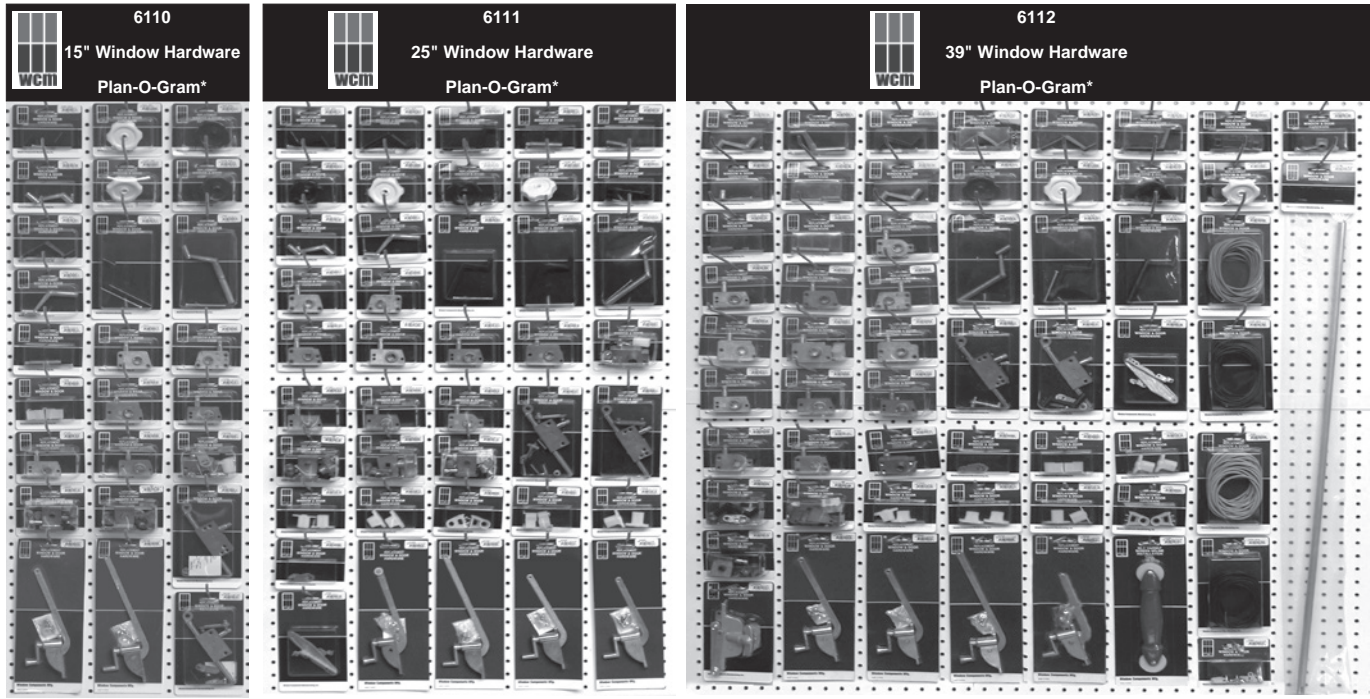

All plan-o-grams include a 16" x 9" header sign, standard peg hooks, and reorder cards for each SKU.

Part #	Description	Peg Qty.	6110	6111	6112
1202C	5/32" Screen Installation Tool w/ Nylon Wheels	3			*
1233C	Single Hung Chrome Sash Lock	3			*
1703C	Nylon 1/2" Torque Bar Bearing	3		*	*
1712C	RH Side Mount Operator 1/2" Hole, w/ 1/4" Hub Projection	3		*	*
1716C	RH Side Mount Operator 1/2" Hole, w/ 1/2" Hub Projection	3	*	*	*
1718C	RH Side Mount Operator 1/2" Hole, w/ 11/16" Hub Projection	3	*	*	*
1770C2	Nylon Torque Bar Bearing 3/4" High	3		*	*
1774C2	Nylon Torque Bar Bearing 3/4" High	3		*	*
309C	140 Hollow Round Gray Screen Spline	3			*
309C BLK	140 Hollow Round Black Screen Spline	3			*
310C	156 Hollow Round Gray Screen Spline	3			*
310C BLK	156 Hollow Round Black Screen Spline	3			*
4000CK	Universal Jalousie Operator Kit	3		*	*
4290C BLK	Miller Single Hung Black Sash Lock	3		*	*
492C	Flush Clear Plastic Screen Clip w/ Screw	3		*	*
712C BLK	3-3/16" Black Plastic Crank Handle w/ Screw	3	*	*	*
715CR	RH Slant Sill Side Mount Operator 3/8" Square w/ 1/4" Hub Projection	3		*	*
733C	RH Side Mount 3/8" Square, w/ 3/16" Hub Projection	3		*	*
735C	RH Side Mount Phillips Operator 1/2" Hole, w/ 3/16" Hub Projection	3	*	*	*
738C	Nylon Phillips Torque Bar Bearing	3	*	*	*
743C BLK	Black Plastic Knob Handle w/ Screw	3	*	*	*
743C WHT	White Plastic Knob Handle w/ Screw	3	*	*	*
743CE BLK	Black Plastic Knob Handle w/ Screw	3	*	*	*
743CE WHT	White Plastic Knob Handle w/ Screw	3	*	*	*
747CR	RH Side Mount Operator 1/2" Hole, w/ 1/8" Hub Projection	3		*	*
748C BLK	1-3/8" Black Plastic Crank Handle w/ Screw	3		*	*
749CR	RH Side Mount Operator 3/8" Square w/ 1/18" Hub Projection	3		*	*
750C BLK	2-1/4" Black Plastic Crank Handle w/ Screw	3		*	*
756PX	1/2" Diameter x 36" Round Torque Bar	3		*	*
761C	RH Slant Sill Side Mount Torque Operator 1/2" Hole, w/ 3/16" Hub Projection	3	*	*	*
762C	LH Slant Sill Side Mount Torque Operator 1/2" Hole, w/ 3/16" Hub Projection	3	*	*	*
763C2	Nylon 7/8" High Torque Bar Bearing	3		*	*
771C BLK	2-1/2" Black Plastic Crank Handle w/ Screw	3		*	*
781C	RH Side Mount Operator 1/2" Hole, w/ 1/2" Hub Projection	3		*	*
783C	Roof Vent Metal Crank Handle w/ Screw	3		*	*
784C2	Nylon 1-1/16" High Torque Bar Bearing	3		*	*
785C	Metal Phillips Torque Bar Arm	3		*	*
787CR	RH Side Mount Phillips Operator 1/2" Hole, w/ 11/16" Hub Projection	3	*	*	*
795C	1-3/4" Metal Crank Handle w/ Screw	3	*	*	*
796C	3-1/2" Metal Crank Handle w/ Screw	3	*	*	*
800CK	Rack Gear Replacement Operator Kit 2-1/8" cc Mounting	3	*	*	*
801ck	Rack Gear Replacement Operator Kit 1-25/32" cc Mounting	3	*	*	*
802ck	Center Mount Operator Kit 3/8" Hex, w/ 1" cc Mounting Holes	3	*	*	*
803ck	Center Mount Operator Kit 5/16" Square, w/ 1" cc Mounting Holes	3	*	*	*
806ck	Arm Gear Roof Vent Operator Kit, w/ 5-3/8" Arm 2-15/16" cc Mounting	3	*	*	*
807ck	Arm Gear Roof Vent Operator Kit, w/ 7-11/16" Arm 2-15/16" cc Mounting	3	*	*	*
808CKR	RH Side Mount Torque Bar Operator Kit, w/ 1/2" Hole, 1/2" Hub Projection	3	*	*	*
812CK	Center Mount Operator Kit 3/8" Square, w/ 1" cc Mounting Holes	3	*	*	*
814CK	Arm Gear Roof Vent Operator Kit, w/ 7-11/16" Arm 2-15/16" cc Mounting	3	*	*	*
831C	1/2" Metal Extension w/ Screw	3		*	*
832C	7/8" Metal Extension w/ Screw	3		*	*
833C	1-1/8" Metal Extension w/ Screw	3		*	*
834C	2" Metal Extension w/ Screw	3	*	*	*
835C	Vent Hinge w/ Stud	3		*	*
838C BLK	1" Black Plastic Crank Handle w/ Screw	3	*	*	*
881C BLK	1-3/4" Black Plastic Crank Handle w/ Screw	3	*	*	*
889C	1" Metal Crank Handle w/ Screw	3	*	*	*
898ck	Arm Gear Roof Vent Operator Kit w/ 5-3/8" Arm, 2-15/16" cc Mounting	3	*	*	*
6110	15" Window Hardware Plan-o-gram				
6111	25" Window Hardware Plan-o-gram				
6112	39" Window Hardware Plan-o-gram				

Each Display Contains 3 each of the following window handles.



2-1/8" Outside Diameter Kinro Knob Handle w/Screw

Part #	Description	Finish
710C WHT	9/16" Shaft	White
710C BLK	9/16" Shaft	White
710CE BLK	13/16" Shaft	Black

Plastic, White Shown

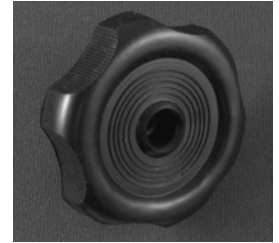

2-1/4" Outside Diameter Plastic Knob Handle w/Screw

Part #	Description	Finish
743C WHT	5/16" Shaft	White
743CE WHT	7/8" Shaft	White
743C BLK	5/16" Shaft	Black
743CE BLK	7/8" Shaft	Black

Plastic, Black Shown

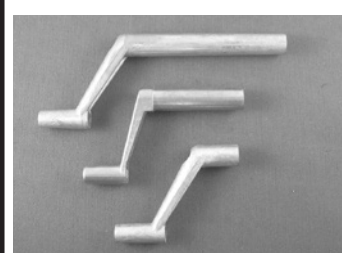

Metal Crank Handle w/Screw

Part #	Description
889C	1" Metal Crank
795C	1-3/4" Metal Crank
796C	3-1/2" Metal Crank

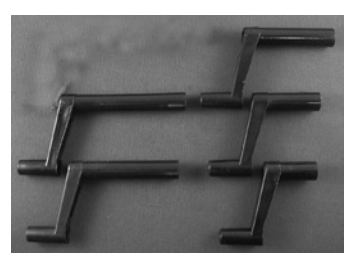

Black Plastic Crank Handle w/Screw

Part #	Description
838C BLK	1" Plastic Crank
881C BLK	1-3/4" Plastic Crank
750C BLK	2-1/4" Plastic Crank
771C BLK	2-1/2" Plastic Crank
712C BLK	3-3/16" Plastic Crank

Part #500-400

RV WINDOW HANDLE SPINNING COUNTER DISPLAY - Attention RV Dealers

Make life easier for your customers by displaying the most popular RV window handles on your counter. Strybuc's spinning rack display includes (15) SKU's packaged for retail. Display also includes black, plastic spinning rack display that takes up little room on your retail counter.

The benefit to your customers is that they will be able to easily identify the RV window handle they need. Spinning display comes with window handles with different finishes (white, black, mill) and includes peg hooks and sign.

For more information, contact your Strybuc Account Manager at #800.352.0800 (PA) or #800.780.5051 (Florida).

Additional RV Displays Available!

Call Your Account Manager for Details.

WINDOW/DOOR GLAZING & WEATHERSTRIPPING

SNAP-IN-VINYL GLAZING BEAD

Glazing bead is grouped by shape. Sold per foot - Available in 6ft. lengths unless otherwise specified, minimum 120'

3 LINE SHAPE



Example

Please Consult Your Representative for Additional Colors, Styles and Sizes

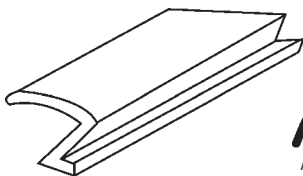

Actual Size

Part #	Color
65-30	White
65-29	Lt. Gray

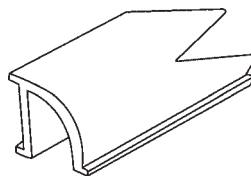

Actual Size

Part #	Color
65-26	Dk. Gray
65-25	White

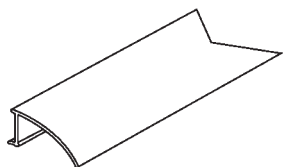

Actual Size

Part #	Color
65-8	Brown
65-8W	White

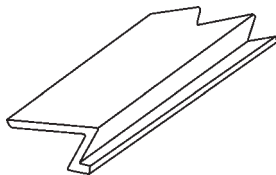

Actual Size

Part #	Color
65-1	Lt. Gray
65-59	Black
65-1BG	Beige

PORTALUME

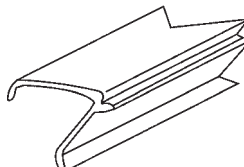

Actual Size

Part #	Color
65-69	Brown
65-69W	White

CAPITOL - 800 SERIES

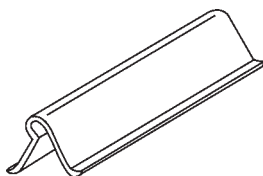

Actual Size

Part #	Color
65-60	White
65-60B	Black

DECO

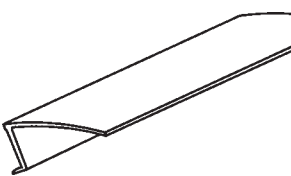

Actual Size

Part #	Color
65-61	White
65-61B	Black

SILVER LINE

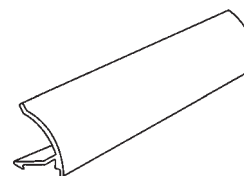

Actual Size

Part #	Color
65-66	Gray
65-67	White

Muntin Bar Bead Refer to page 302.
Used on 65-36 Bead Only - All 6" Lengths

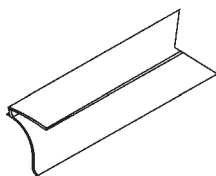

Actual Size

Part #	Color
65-78B	Black
65-78W	White

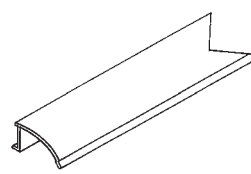

Actual Size

Part #	Color
900-16303	Gray
900-16303W	White

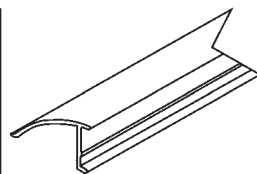

Actual Size

Part #	Color
900-11480	Brown
900-11480W	White

CAPITOL

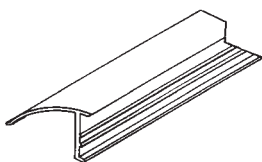

Actual Size

Part #	Color
900-11481	Brown
900-11481W	White

CAPITOL

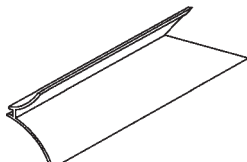

Actual Size

Part #	Color
900-14895	Black
900-14895W	White

KRESTMARK

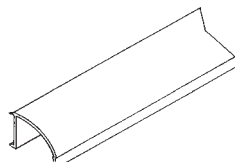

Actual Size

Part #	Color
900-16724	White
900-16724DB	Bronze

WINDOW/DOOR GLAZING & WEATHERSTRIPPING

SNAP-IN-VINYL GLAZING BEAD

Glazing bead is grouped by shape. Sold per foot - Available in 6ft. lengths unless otherwise specified, minimum 120'

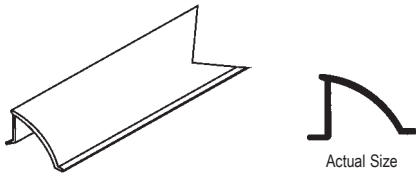

Part #	Color
900-16422	White
900-16422BK	Black
900-16422DB	Dark Bronze
900-16422G	Gray

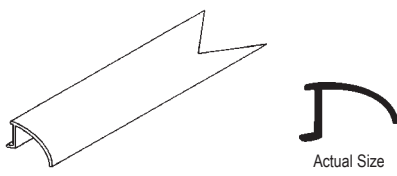

Part #	Color
900-16344	Gray
900-16344B	Black
900-16344DB	Dark Bronze
900-16344W	White

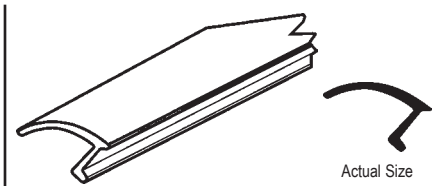

Part #	Color
65-4	White
65-5	Lt. Gray
65-4BR	Bronze

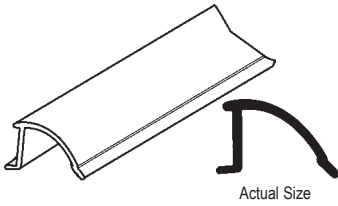

Part #	Color
65-352	White

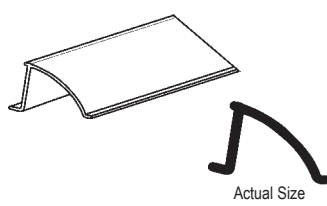

Part #	Color
65-595BZ	Bronze

GENERAL ALUMINUM

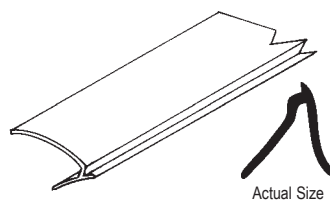

Part #	Color
900-17190	White

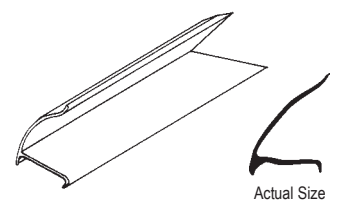

Part #	Color
900-18492	White

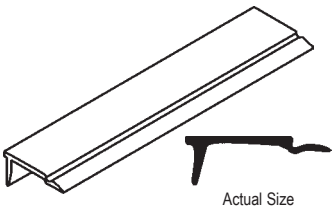

Part #	Color
900-17870	White
900-17870BZ	Bronze

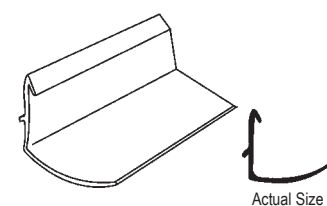

Part #	Color
900-11015DB	Bronze
900-11015W	White

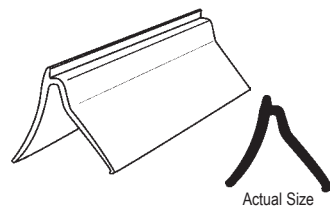

Part #	Color
65-350W	White
65-350BZ	Bronze

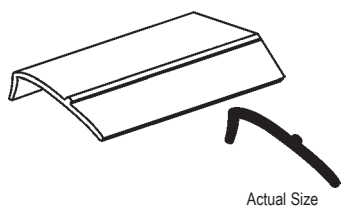

Part #	Color
900-21521	Black

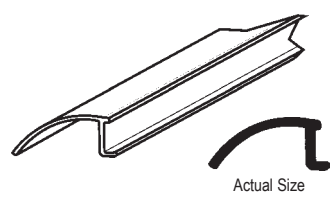

Part #	Color
65-466	White

VE ANDERSON

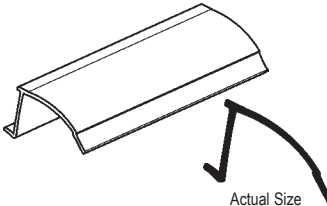

Part #	Color
65-613	White

Sold by the foot in 6' Lengths 120' Minimum

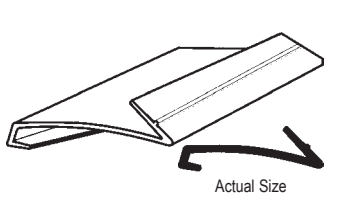
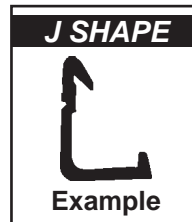

Part #	Color
65-321B	Black
65-321W	White

ALENCO

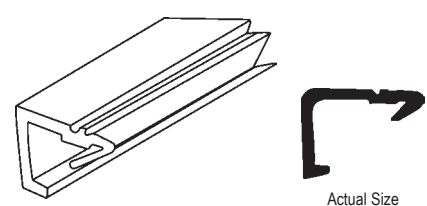

Part #	Color
65-42	Black
65-42W	White

REYNOLDS

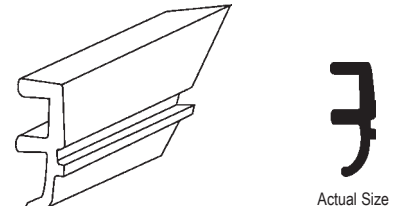

Part #	Color
65-44	Lt. Gray

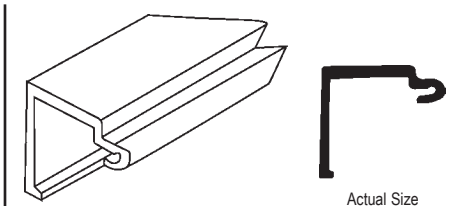

Part #	Color
65-20	White

KELLER

Note: Large minimum required

WINDOW/DOOR GLAZING & WEATHERSTRIPPING

SNAP-IN-VINYL GLAZING BEAD

Glazing bead is grouped by shape. Sold per foot - Available in 6ft. lengths unless otherwise specified, minimum 120'

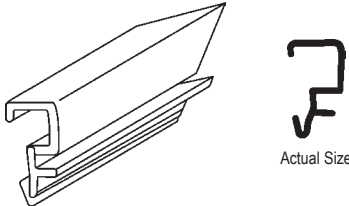

Actual Size

Part #	Color
65-45	White
65-46	Brown

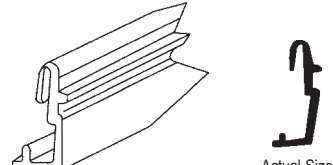

Actual Size

Part #	Color
65-48	Brown
65-48LBR	Light Brown
65-49	White

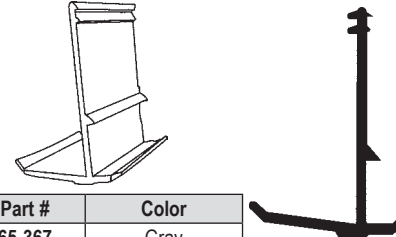

Actual Size

Part #	Color
65-367	Gray

Dual Durometer. Sold in 8' Length with 15 Length Minimum

PENNCO

CRESTLINE/PEACHTREE

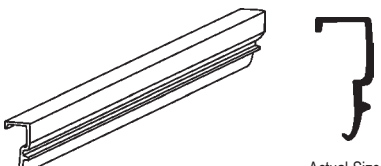

Actual Size

Part #	Color
65-57	Brown
65-58	White

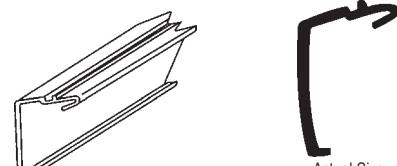

Actual Size

Part #	Color
65-47	Brown
65-47W	White

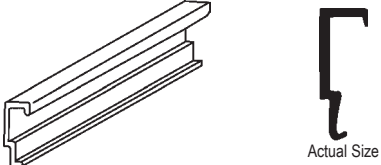

Actual Size

Part #	Color
65-50	White

CAPITOL

PENNCO

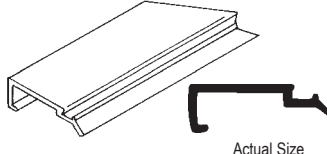

Actual Size

Part #	Color
65-52	White
65-52B	Black



Actual Size

Part #	Color
900-9093	White

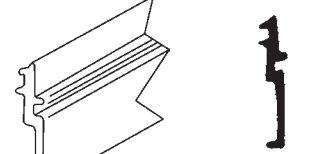

Actual Size

Part #	Color
900-8745	Black

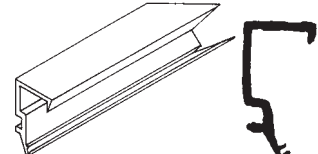

Actual Size

Part #	Color
900-16144	Dark Bronze

CAPITOL

ACORN

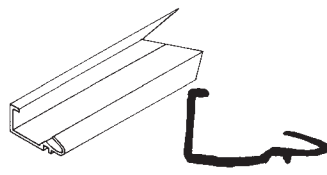

Actual Size

Part #	Color
900-17559	Black

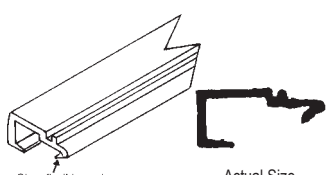

Actual Size

Clear flexible seal integrated here

Part #	Color
900-12029W	White
900-12029	Bronze

Dual Durometer

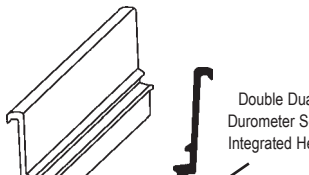

Actual Size

Double Dual Durometer Seal Integrated Here

Part #	Color
65-101NS	Black

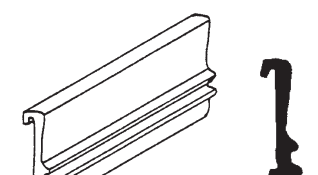

Actual Size

Part #	Color
65-101	Black

PENNCO

ACORN 2300 SERIES

ACORN 2300 SERIES

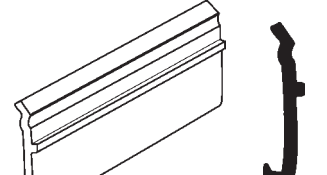

Actual Size

Part #	Color
65-104	Black
65-104W	White

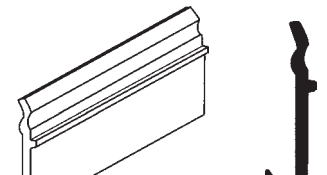

Actual Size

Part #	Color
65-106	Black
65-106W	White

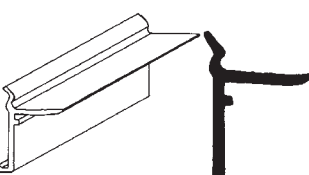

Actual Size

Part #	Color
65-105	Black
65-105W	White

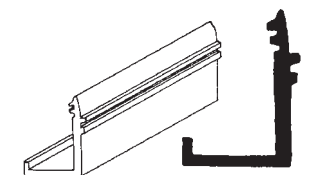

Actual Size

Part #	Color
65-108	Black

ACORN 2300 SERIES

ACORN 2900 SERIES

ACORN 2300/3300 SERIES

WINDOW/DOOR GLAZING & WEATHERSTRIPPING

SNAP-IN-VINYL GLAZING BEAD

Glazing bead is grouped by shape. Sold per foot - Available in 6ft. lengths unless otherwise specified, minimum 120'

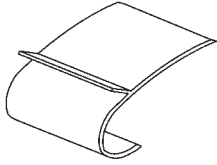

Actual Size

Part #	Color
65-88	Gray
65-88BZ	Bronze

Part #	Color	Length
65-168	Bronze	50-1/2"

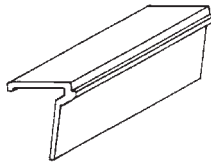

Actual Size

Part #	Color
65-89B	Black
65-89BZ	Bronze
65-89W	White

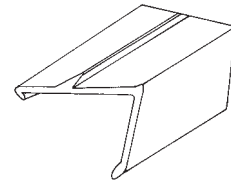

Actual Size

Part #	Color
65-90	White

Dual Durometer. Old Wenco Bead Cut 6' Lengths
WENCO

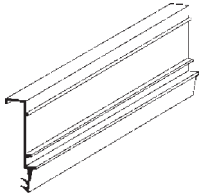

Actual Size

Part #	Color
900-11865	Black
900-11865W	White

ACORN

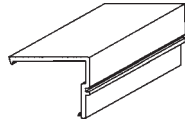

Actual Size

Part #	Color
900-11563	Brown
900-11563W	White

Dual Durometer

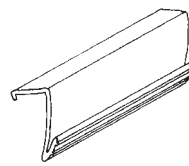

Actual Size

Part #	Color
900-16067	White
900-16067AG	Adobe Gray
900-16067B	Black

ACORN

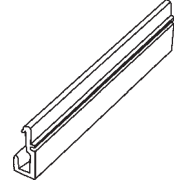

Actual Size

Part #	Color
900-17496	White
900-17496BZ	Bronze

Dual Durometer
PENCO

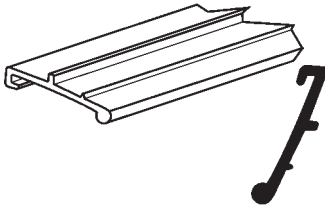

Actual Size

Part #	Color
900-20445	Black

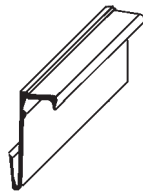

Actual Size

Part #	Color
900-18453BL	Black
900-18453W	White

WINTERSEAL

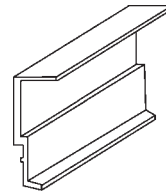

Actual Size

Part #	Color
900-18550	White

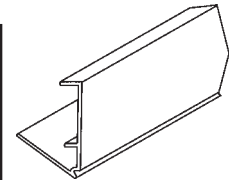

Actual Size

Part #	Color
65-531W	White
65-531BZ	Bronze

For Insulated Glass
MILESTONE/FLORIDA EXTRUDERS

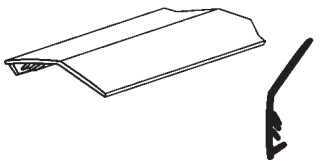

Actual Size

Part #	Color
65-444B	Black

ALUMINUM INDUSTRIES

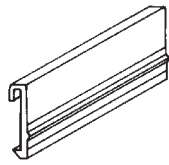

Actual Size

Part #	Color
900-17499	White
900-17499BR	Brown

PENCO

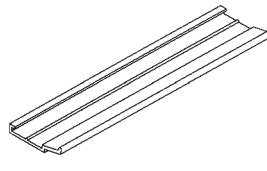

Actual Size

Part #	Color
900-17510	White

Head Vinyl Glazing Stop

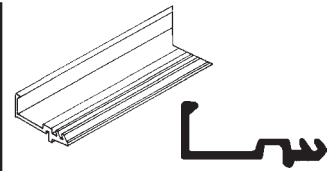

Actual Size

Part #	Color
900-8744	Black

Dual Durometer

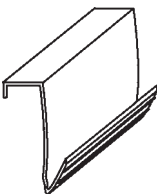

Actual Size

Part #	Color
65-135	White
65-135AG	Adobe Gray

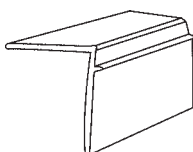

Actual Size

Part #	Color
65-240W	White

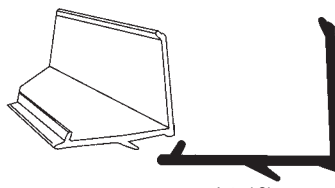

Actual Size

Part #	Color
65-365W	White

Sold in 8' Lengths w/ 15 Length Minimum

BARBER & ROSS

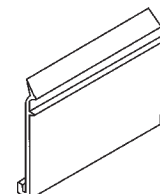

Actual Size

Part #	Color
65-132	Black
65-132W	White

WINDOW/DOOR GLAZING & WEATHERSTRIPPING

SNAP-IN-VINYL GLAZING BEAD

Glazing bead is grouped by shape. Sold per foot - Available in 6ft. lengths unless otherwise specified, minimum 120'

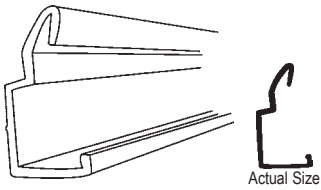

Actual Size

Part #	Color
900-15383	Dark Gray

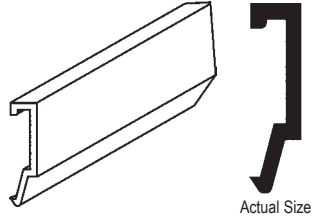

Actual Size

Part #	Color
65-545W	White

Sold in 8' Lengths w/ 15 Length Minimum
VEKA

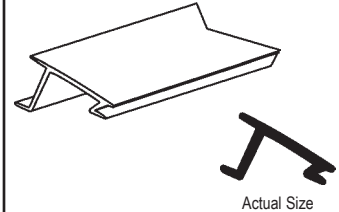
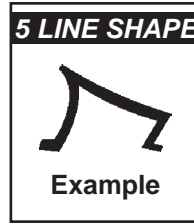

Actual Size

Part #	Color
900-10477W	White

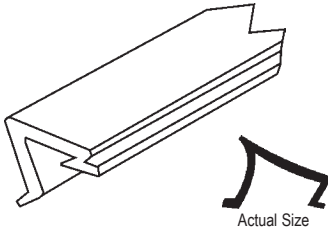

Actual Size

Part #	Color
65-41	White
65-40	Lt. Gray



Actual Size

Part #	Color
65-32BR	Bronze
65-32	Brown
65-33	White
65-43	Black

CROSSLY

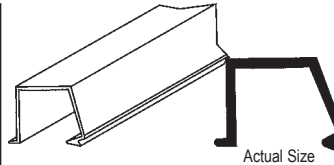

Actual Size

Part #	Color
65-533W	White
65-533BZ	Bronze

For Single Pane Glass
**MILESTONE 1000 SERIES/
FLORIDA EXTRUDERS**

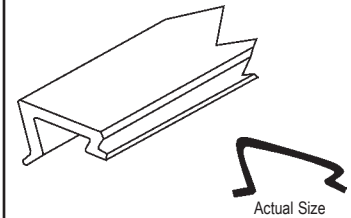

Actual Size

Part #	Color
65-28	White
65-27	Black

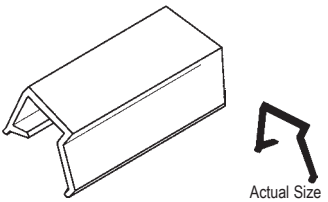

Actual Size

Part #	Color
65-281W	White
65-281TN	Tan

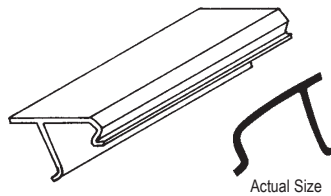

Actual Size

Part #	Color
900-12920W	White
900-12920BZ	Bronze

ROLLYSON 2000 SERIES

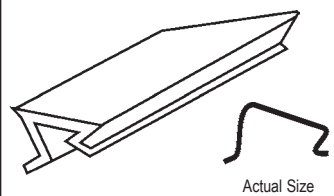

Actual Size

Part #	Color
65-16	Black
65-15	Brown

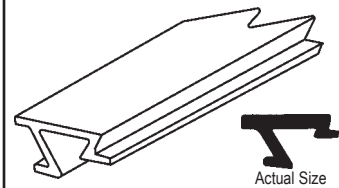

Actual Size

Part #	Color
65-17	Lt. Gray
65-12	Black
65-3	White

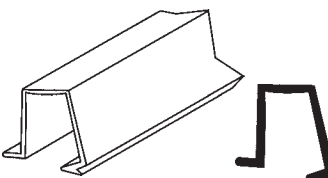

Actual Size

Part #	Color
65-532W	White

For Impact Glass
MILESTONE/FLORIDA EXTRUDERS

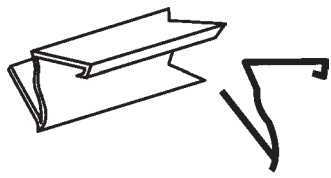

Actual Size

Part #	Color
65-71	Black
65-71W	White

BINNINGS

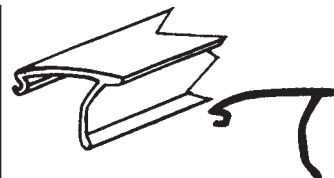

Actual Size

Part #	Color
900-8668	White
900-8668B	Black

BINNINGS

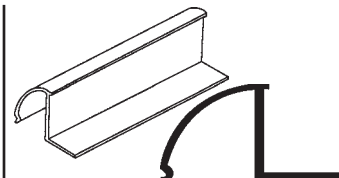

Actual Size

Part #	Color
900-16683	White
900-16683BZ	Bronze

BELLVIEW

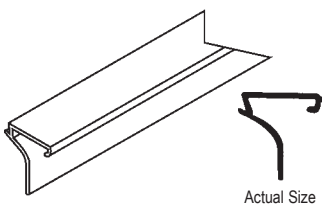

Actual Size

Part #	Color
900-17038	Black
900-17038W	White

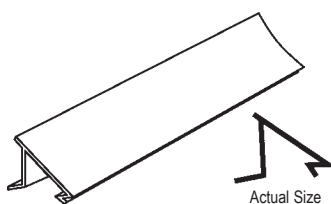

Actual Size

Part #	Color
65-87	Gray
65-87B	Black

ROLLYSON

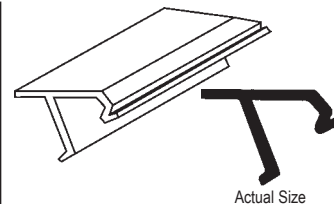

Actual Size

Part #	Color
900-10613	Bronze
900-10613W	White

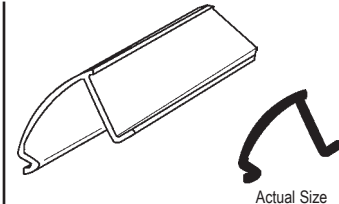

Actual Size

Part #	Color
65-85	White
65-85BZ	Bronze

CE

WINDOW/DOOR GLAZING & WEATHERSTRIPPING

SNAP-IN-VINYL GLAZING BEAD

Glazing bead is grouped by shape. Sold per foot - Available in 6ft. lengths unless otherwise specified, minimum 120'

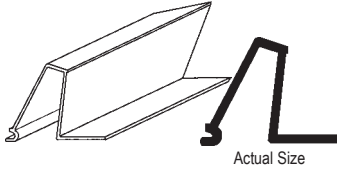

Part #	Color
65-384W	White
65-384B	Black
65-384BRZ	Bronze

Come in 6' Length 144' Minimum

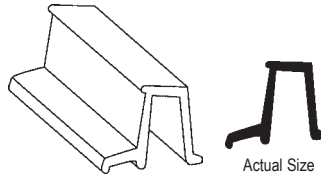

Part #	Color
900-14969BL	Black
900-14969	White
900-14969BZ	Bronze

PHILIPS/AIR CONTROL

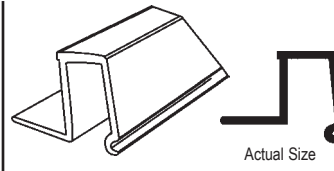

Part #	Color
900-19000	Black
900-19000BR	Brown
900-19000BZ	Bronze
900-19000W	White

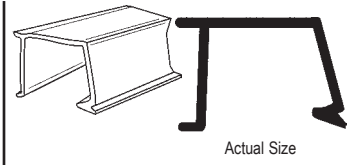

Part #	Color
65-467W	White

**MILESTONE 2000 SERIES
FLORIDA EXTRUDERS**

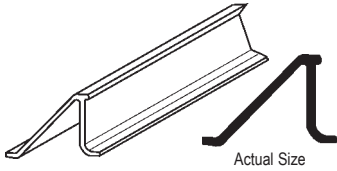

Part #	Color
900-18979	Gray
900-18979BZ	Bronze
900-18979W	White

144' Minimum. Order in Multiples of 144'

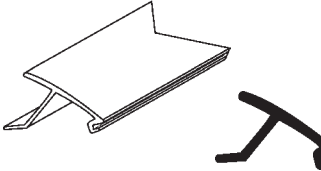

Part #	Color
65-564B	Black
65-564W	White

MILCO

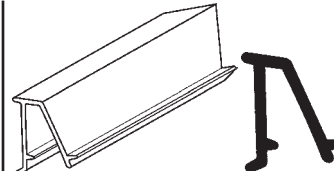

Part #	Color
65-253B	Black
65-253W	White

ALCAN/ANDERSON

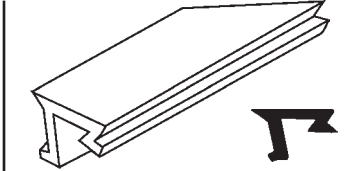

Part #	Color
65-11	Black

AIRMASTER

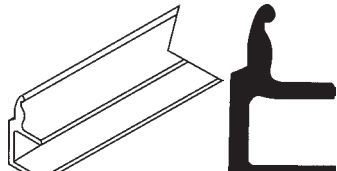

Part #	Color
900-13327	Black

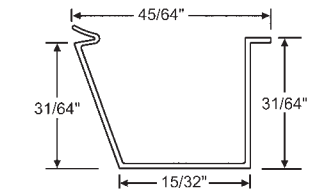

Part #	Color
65-488W	White
65-488BZ	Bronze

**MILESTONE/FLORIDA
EXTRUDERS**

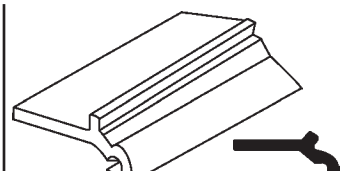
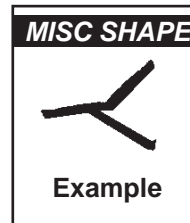

Part #	Color
65-39	Lt. Gray

CAPITOL

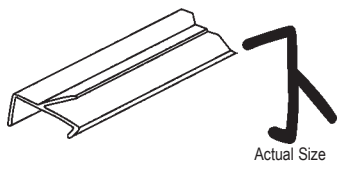

Part #	Color
65-84B	Black
65-84WH	White

Sold in 6' Lengths/120' Minimum

VE ANDERSON/ALCAN

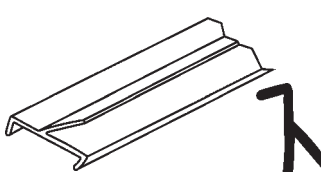

Part #	Color
65-83	Black

VE ANDERSON

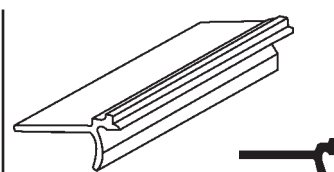

Part #	Color
65-91	White
65-91B	Black

ROLLYSOY 1500 SERIES

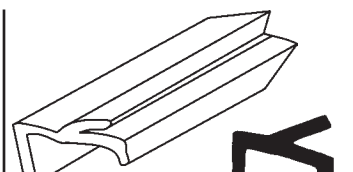

Part #	Color
65-6	White
65-7	Black

V.E. ANDERSON

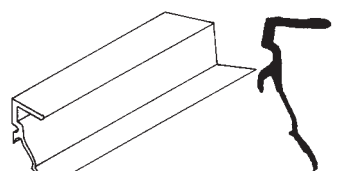

Part #	Color
900-14844	White

WINTERSEAL

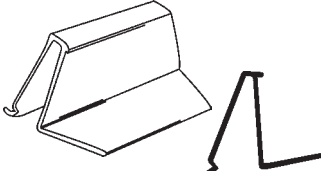

Part #	Color
900-9954	Black
900-9954W	White

KELLER

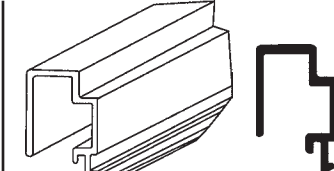

Part #	Color
900-11386	Black

ACORN 2300 SERIES

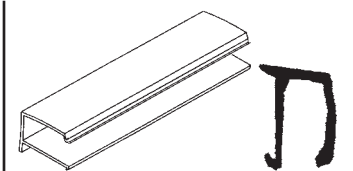

Part #	Color
900-18970BL	Black
900-18970W	White

WINDOW/DOOR GLAZING & WEATHERSTRIPPING

SNAP-IN-VINYL GLAZING BEAD

Glazing bead is grouped by shape. Sold per foot - Available in 6ft. lengths unless otherwise specified, minimum 120'

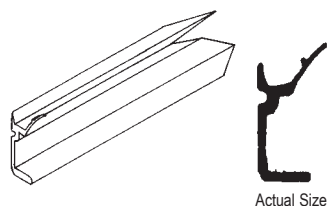

Part #	Color
900-15075	White

WINTERSEAL

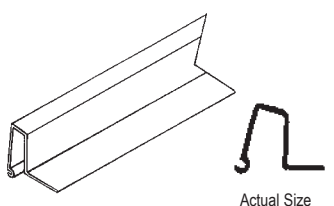

Part #	Color
900-16343	Bronze
900-16343W	White

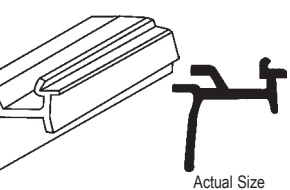

Part #	Color
900-20292	White
900-20292BR	Brown

ROLLYSON 2500 SERIES

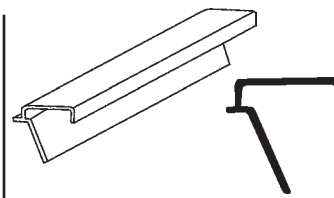

Part #	Color
65-64	Brown
65-64W	White

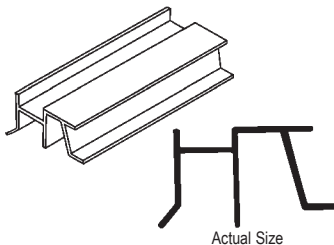

Part #	Color
65-53	White

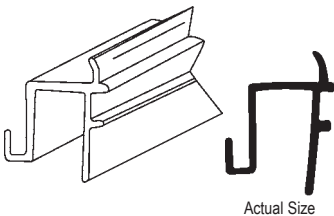

Part #	Color
65-70	White
65-70DB	Dark Bronze

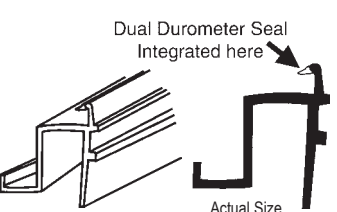

Part #	Color
900-20713W	White

Dual Durometer

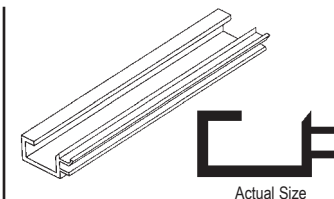

Part #	Color
900-14823	White
900-14823B	Black

HOWARD

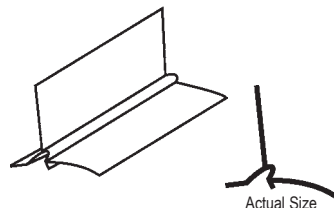

Part #	Color
900-20293	White

ROLLYSON

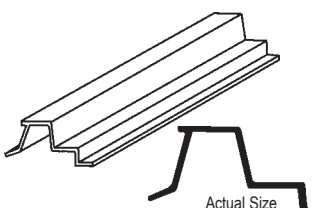

Part #	Color
65-55	White

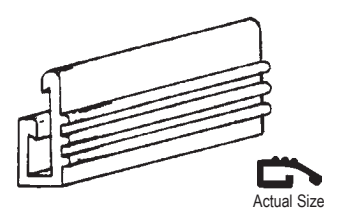

Part #	Color
65-31W	White
65-31	Dark Gray

CAPITOL

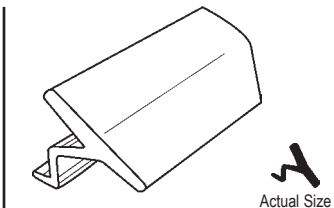

Part #	Color
900-21518	Black
900-21518G	Gray

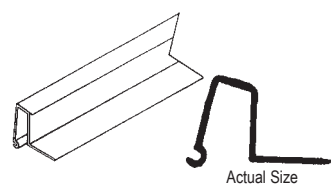

Part #	Color
900-16225	White
900-16225BZ	Bronze

Keller, Single Hung 76,
General Aluminum & Krestmark

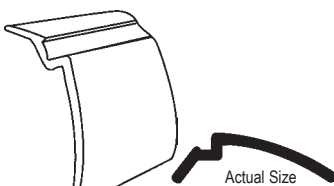

Part #	Color
65-213W	White

PHILIPS

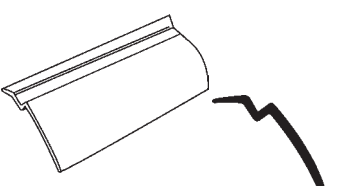

Part #	Color
65-456W	White
65-456TN	Tan
65-456BZ	Bronze

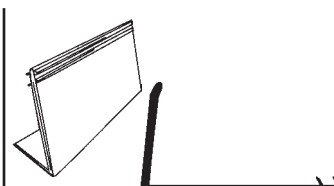

Part #	Color
65-183W	White

HURD/RIVCO

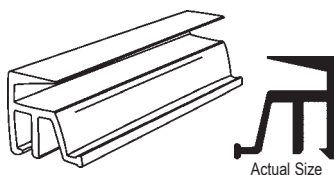

Part #	Color
65-112	Black

Sold by the foot in 8' Length.
120' minimum (15 lengths)

TRACO

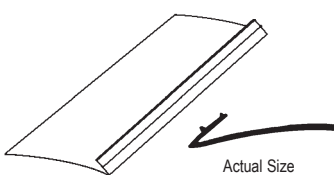

Part #	Color
900-16212	White
900-16212B	Black
900-16212BG	Beige

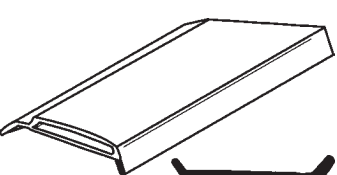

Part #	Color
65-514W	White

PGT

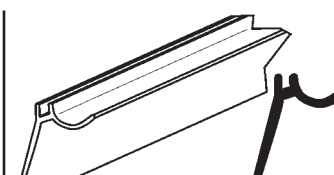

Part #	Color
900-18869	White

WINDOW/DOOR GLAZING & WEATHERSTRIPPING

SNAP-IN-VINYL GLAZING BEAD

Glazing bead is grouped by shape. Sold per foot - Available in 6ft. lengths unless otherwise specified, minimum 120'

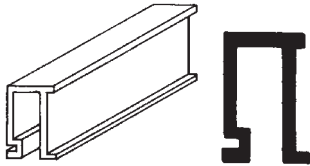

Actual Size

Part #	Color
900-9953NEW	Black
900-9953NW	White

New style
KELLER

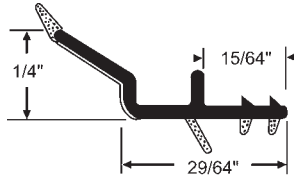

Part #	Color
900-14617	White
900-14617BG	Beige
900-14617BZ	Bronze

All 8' Lengths.
NORCO/VETTER/JELD-WEN

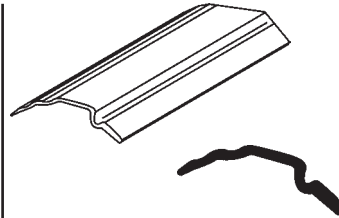

Actual Size

Part #	Color
65-515W	White

15' Lengths. Cut in Half for Shipping.
PGT

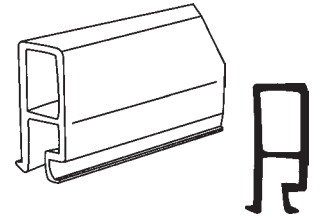

Actual Size

Part #	Color
65-235W	White

ACORN

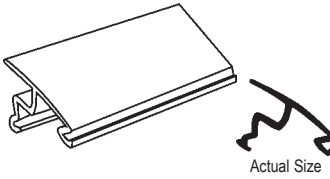

Actual Size

Part #	Color
65-241W	White

KINRO/ACORN

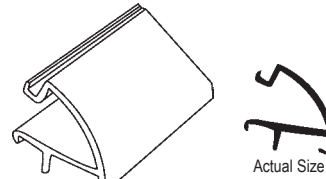

Actual Size

Part #	Color
65-95	White

PHILIPS

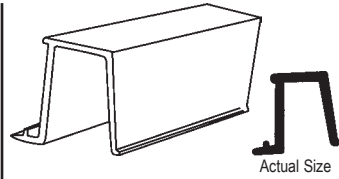

Actual Size

Part #	Color
900-18974BL	Black
900-18974BZ	Bronze
900-18974W	White

8 Foot Lengths

Part #	Color
65-318W	White
65-318TN	Tan

KINRO/ACORN

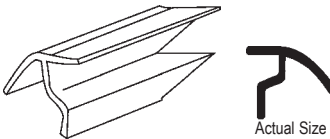

Actual Size

Part #	Color
65-73	White
65-73B	Black
65-73BZ	Bronze
65-73G	Gray

CROFT

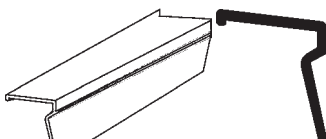

Actual Size

Part #	Color
900-19291WH	White

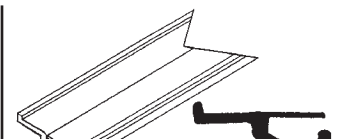

Actual Size

Part #	Color
900-20135	Brown
900-20135W	White



Actual Size

900-11139
Black 6' Lengths 120' Minimum
ACORN

TRACKS

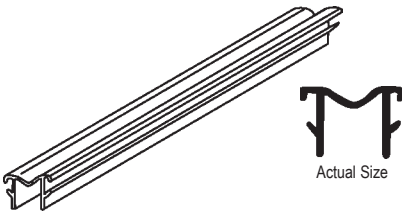

Actual Size

Part #	Color
65-65	Black

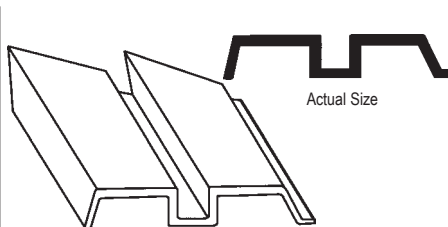

Actual Size

Part #	Color
65-68	Charcoal

CAPITOL

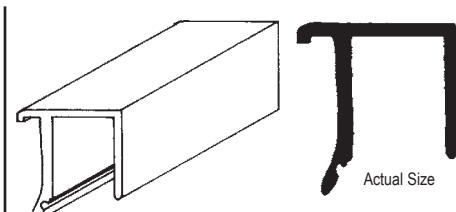

Actual Size

Part #	Color
65-81W	White

SEASONALL

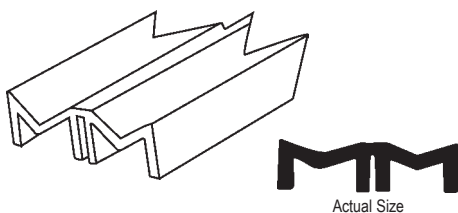

Actual Size

Part #	Color
65-9	White
65-10	Black

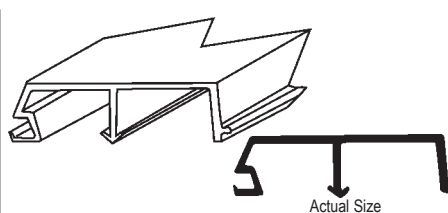

Actual Size

Part #	Color
65-63	Light Gray

CAPITOL

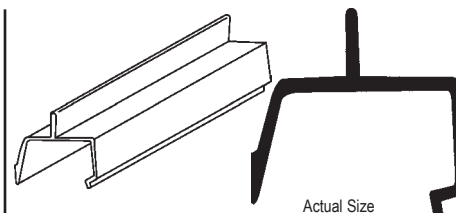

Actual Size

Part #	Color
65-56	Black

WINDOW/DOOR GLAZING & WEATHERSTRIPPING

MUNTIN BARS

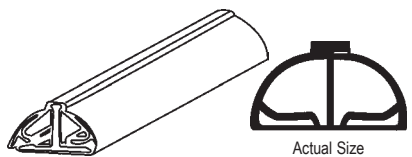

Part #	Color
65-36	White with White bead

Sold by the Foot.
120' Minimum

Note: All 6' Lengths
CAPITOL

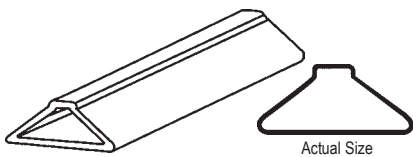

Part #	Color
65-37	White

Sold by the Foot.
120' Minimum

Aluminum. All 8' Lengths

PLUNGER

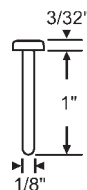

90-1024
Nylon

MUNTIN CLIPS

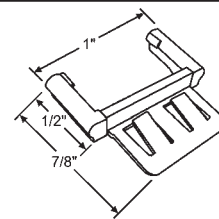

90-852

White
ALCAN/NORANDEX

MUNTIN CLIPS

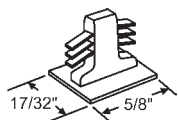

90-1022B
Black

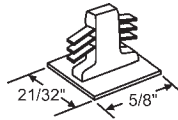

90-1023B
Black

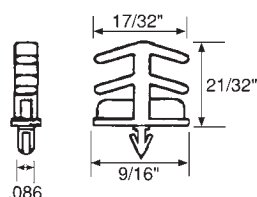

90-630
White Nylon

GRILLE PINS

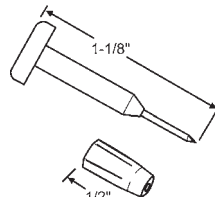

90-857
Clear Plastic w/ Steel Shaft

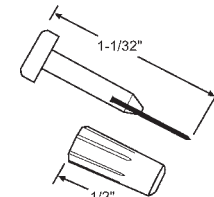

90-973
Clear Plastic w/ Steel Shaft

WINDOW GRILLE KIT

The window grille kit is simple to install and easy to remove for cleaning at a fraction of the typical cost. The kit contains enough material for a standard size window or door including: **12 pieces of 24" Profile, 8 "X" Connectors and 16 Fasteners.**

The Window Grille Kit can be used on wood, vinyl or aluminum materials. These attractive profiles are currently available in white only.

90-516

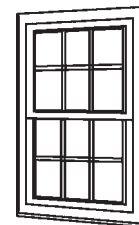
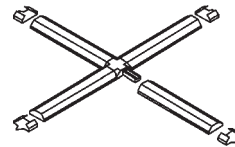
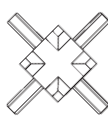
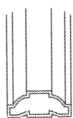

profile + connectors + fasteners + together =

METAL GLAZING BEAD

Sold by Length - 72" = 1 Length. Minimum 10 Lengths Unless Otherwise Specified

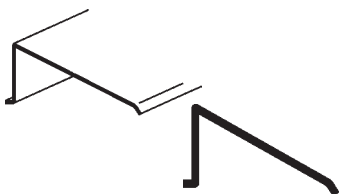

Actual Size

Part #	Color
65-516W	White

PGT

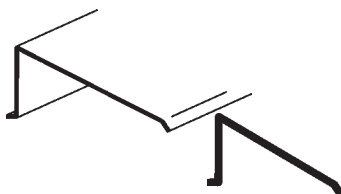

Actual Size

Part #	Color
65-517W	White

PGT

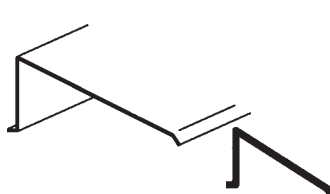

Actual Size

Part #	Color
65-518W	White

PGT



Actual Size

Part #	Color
65-158-6	Aluminum
65-159-6	Bronze
65-160	White
65-160B	Black

Single Hung
YALE

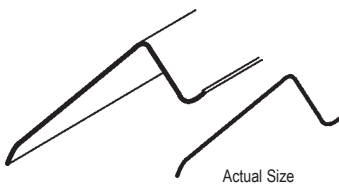

Actual Size

Part #	Color
65-161-6	Aluminum
65-161W-6	White

Awning Type Window
YALE

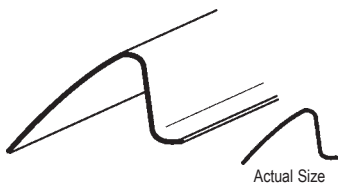

Actual Size

Part #	Color
65-154-6	Aluminum
65-155-6	White

Single Hung
HARCAR

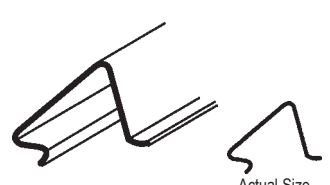

Actual Size

Part #	Color
65-163-6	Aluminum

Single Hung
ABC/CROWN/TUCKER

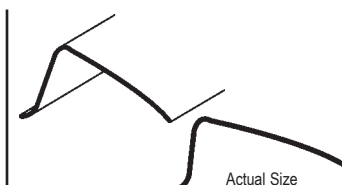

Actual Size

Part #	Color
65-164	Aluminum
65-164W	White

Single Hung
KINCO

WINDOW/DOOR GLAZING & WEATHERSTRIPPING

METAL GLAZING BEAD

Sold by Length - 72" = 1 Length. Minimum 10 Lengths Unless Otherwise Specified

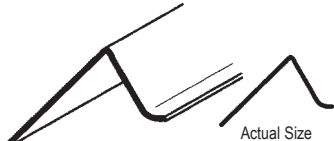

Actual Size

Part #	Color
65-143	Aluminum
65-144	White
65-145	Bronze

Single Hung
PAN AM

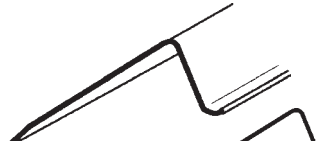

Actual Size

Part #	Color
65-146	Aluminum

Awning Type Window
PAN AM

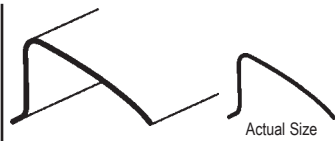

Actual Size

Part #	Color
65-156-6	Aluminum
65-157-6	White
65-156BZ-6	Bronze

Awning Type Window
HARCAR



Actual Size

Part #	Color
65-166-6	Aluminum
65-167-6	Bronze

Single Hung **SECURITY** Awning Type Window **SUPERIOR**



Actual Size

Part #	Color
65-117	Mill

6' Length
PAN AM

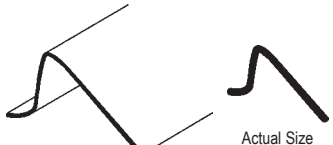

Actual Size

Part #	Color
65-460	Mill
65-461	Bronze
65-462	White

PAN AM

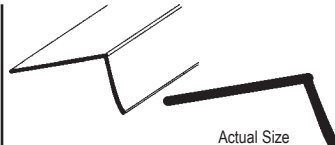

Actual Size

Part #	Color
65-479	Mill
65-479BZ	Bronze
65-479W	White

CROWN



Actual Size

Part #	Color
65-482	Mill
65-482BZ	Bronze
65-482WH	White

PAN AM

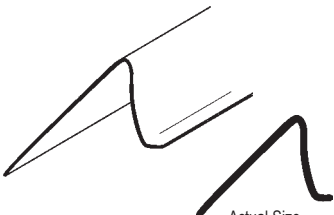

Actual Size

Part #	Color
65-483	Mill
65-483W	White

JACOBSON

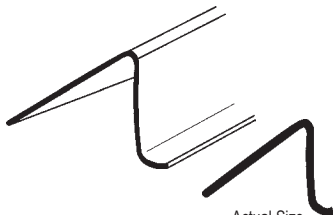

Actual Size

Part #	Color
65-480	Mill
65-480BZ	Bronze

HARCAR

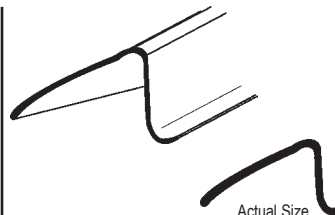

Actual Size

Part #	Color
65-113	Mill
65-113BZ	Bronze

VINYL TECH

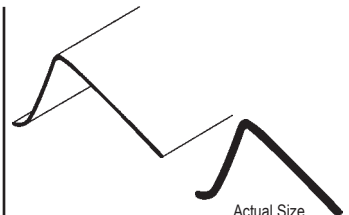

Actual Size

Part #	Color
65-481	Mill
65-481W	White

YALE

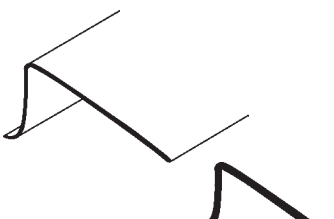

Actual Size

Part #	Color
65-463	White

PGT

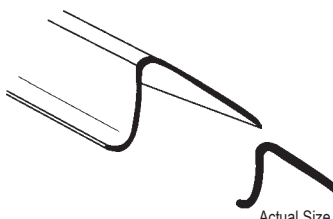

Actual Size

Part #	Color
65-477	Mill
65-477BZ	Bronze

TUCKER

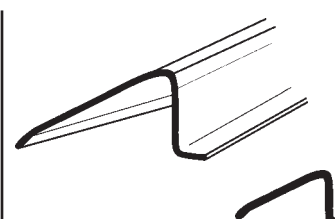

Actual Size

Part #	Color
65-478W	White

PAN AM

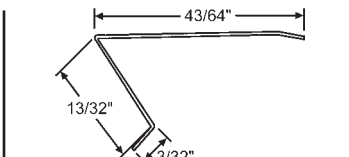

43/64"
13/32"
3/32"

Part #	Color
65-543	Mill
65-543BZ	Bronze
65-543WH	White

6' Length, 10 Length Minimum
AAA STAMPING

Sold by Length - 6' Length, Minimum 20 Lengths
Full Carton Also Available. Contact Account Manager for Details.

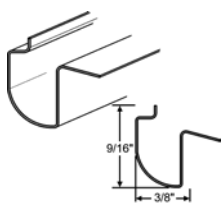

9/16"
3/8"

65-493W
White. 6' Length

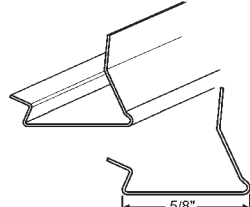

5/8"

65-494BZ
Bronze. 6' Length

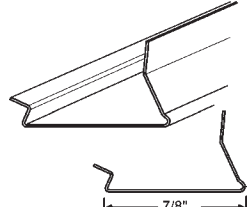

7/8"

65-499W
White. 6' Length

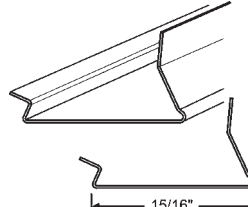

15/16"

65-497BZ
Bronze. 6' Length

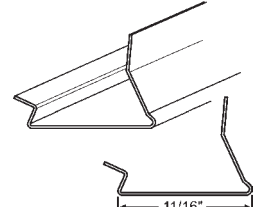

11/16"

65-498BZ
Bronze. 6' Length

WINDOW/DOOR GLAZING & WEATHERSTRIPPING

METAL GLAZING BEAD

Sold by Length - 6' Length, Minimum 20 Lengths
Full Carton Also Available. Contact Account Manager for Details.

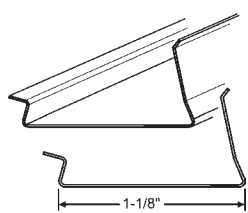

Part #	Color
65-492	Mill
65-492BZ	Bronze
65-492W	White
65-492B	Black

6' Length

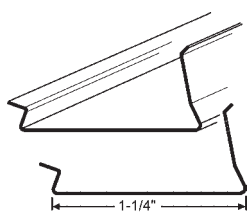

Part #	Color
65-491BZ	Bronze
65-491	Aluminum
65-491B	Black

6' Length

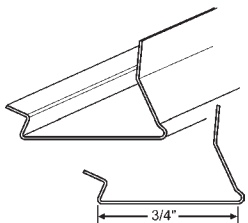

Part #	Color
65-496	Mill
65-496W	White
65-496B	Black
65-496BZ	Bronze

6' Length

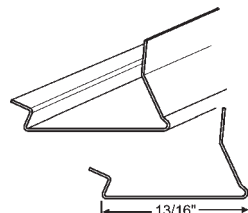

Part #	Color
65-507	Aluminum
65-507W	White
65-507BR	Brown

6' Length

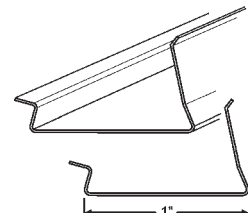

Part #	Color
65-495	Mill
65-495W	White

6' Length

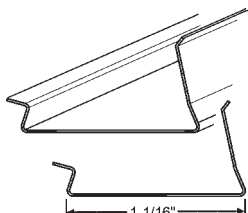

Part #	Color
65-500M	Mill
65-500W	White

White. 6' Length

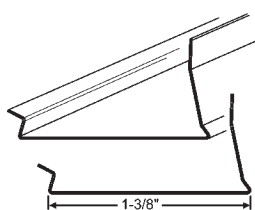

65-505DBR
Dark Brown. 6' Length

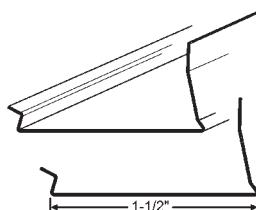

65-504DBR
Dark Brown. 6' Length

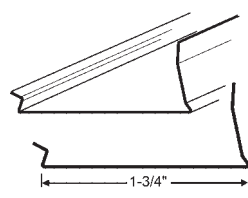

65-506DBR
Dark Brown. 6' Length

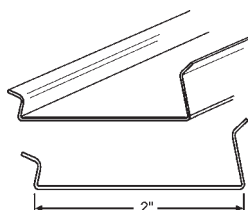

65-536W
White. 6' Length

VINYL GLAZING SPLINE

Fits 80-85% of all spline type aluminum windows. Fits all type glazing spline.

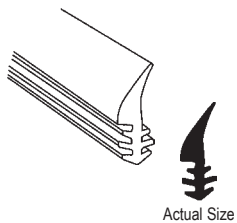

Part #	Length	Color
68-1	100 ft.	Gray
68-1M	1,000 ft.	Gray

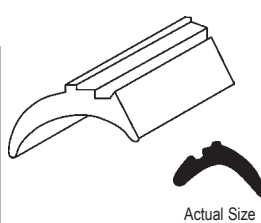

Part #	Length	Color
68-2	100 ft.	Gray
68-2M	1,000 ft.	Gray

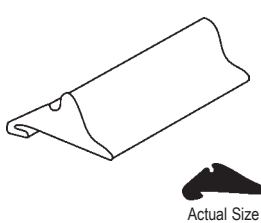

Part #	Length	Color
68-3	100 ft.	Gray
68-3M	1,000 ft.	Gray

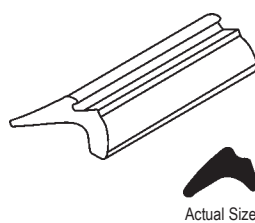

Part #	Length	Color
68-4	100 ft.	Gray
68-4M	1,000 ft.	Gray

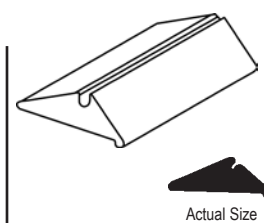

Part #	Length	Color
68-10	100 ft.	Gray
68-10M	1,000 ft.	Gray

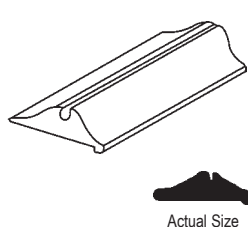

Part #	Length	Color
68-9	100 ft.	Gray
68-9M	1,000 ft.	Gray

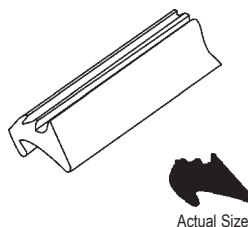

Part #	Length	Color
68-13	100 ft.	Gray
68-13M	1,000 ft.	Gray

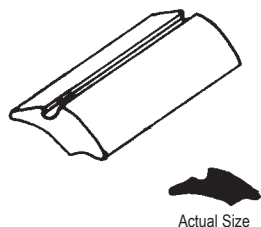

Part #	Length	Color
68-14	100 ft.	Gray
68-14M	1,000 ft.	Gray

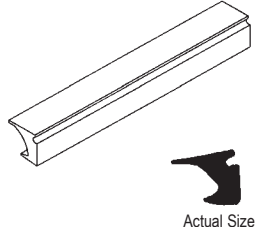

Part #	Length	Color
900-9465	100 ft.	Gray
900-9465B	100 ft.	Black

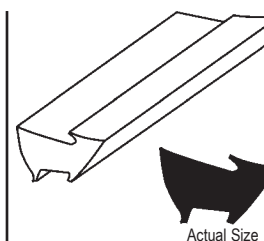

WDV 7 BK
Black. 500 Ft.

WINDOW/DOOR GLAZING & WEATHERSTRIPPING

GRAY VINYL GLAZING CHANNELS

Glazing Channel for Single Strength Glass 1/16" (1.6MM)

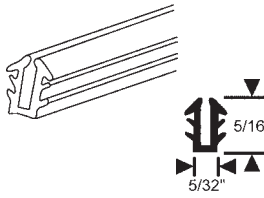

Part #	Length
67-5	100 ft.
67-5M	1,000 ft.

Channel Depth 17/64"
Metal Opening 3/16" to 9/32"

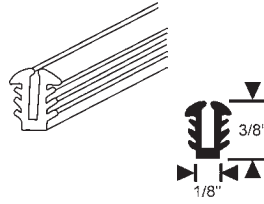

Part #	Length
67-7	100 ft.
67-7M	1,000 ft.

Channel Depth 11/32"
Metal Opening 9/32"

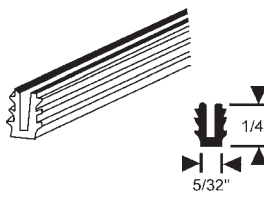

Part #	Length
67-2	100 ft.
67-2M	1,000 ft.

Channel Depth 13/64"
Metal Opening 9/64" to 11/64"

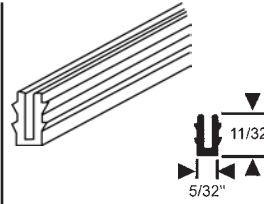

Part #	Length
67-6	100 ft.
67-6M	1,000 ft.

Channel Depth 9/32"
Metal Opening 5/32" to 3/16"

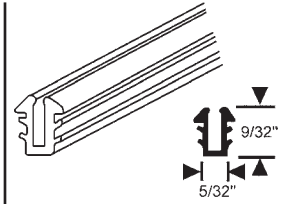

Part #	Length
67-1	100 ft.
67-1M	1,000 ft.

Channel Depth 15/64"
Metal Opening 5/32" to 1/4"

GRAY VINYL GLAZING CHANNELS

Glazing Channel for Double Strength Glass 1/8" (3.2MM) Minimal dimension changes may occur due to varying rubber components.

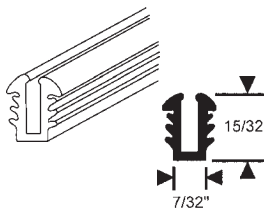

Part #	Length
67-9	100 ft.
67-9M	1,000 ft.

Channel Depth 9/32"
Metal Opening 1/4" to 19/64"

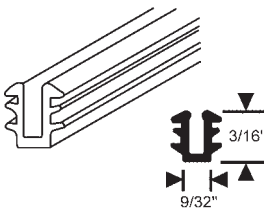

Part #	Length
67-10	100 ft.
67-10M	1,000 ft.

Channel Depth 15/64"
Metal Opening 7/32" to 15/64"

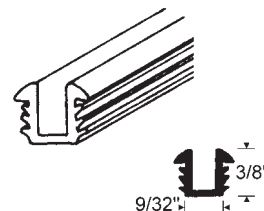

Part #	Length
67-14	100 ft.

BLACK VINYL GLAZING CHANNELS

Glazing Channel for 3/16" Glass

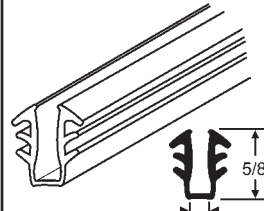

67-123B
Black
400' Roll

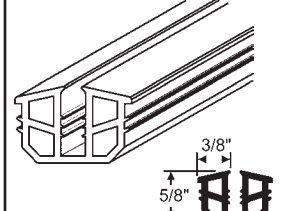

67-43
Black
200' Roll

BLACK VINYL GLAZING CHANNELS

Glazing Channel for 1/4" Glass

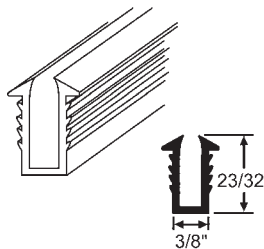

67-35
Black. Sold in 50' Rolls

Glazing Channel for 5/8" Glass

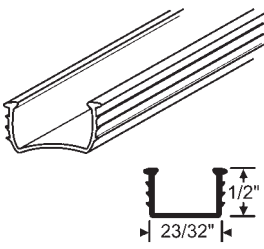

900-21729NS
Black. Sold in Multiples of 100'
ACORN 2300 SERIES

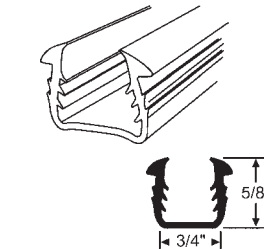

900-21986
Black. Sold in Multiples of 100'

U-CHANNEL

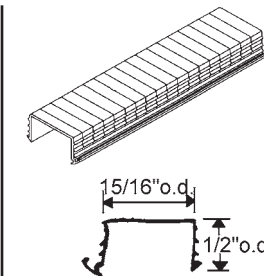

67-18
Black. Serrations spaced at 7/32" intervals. Sold in Multiples of 100'

PERIMETER SEALS

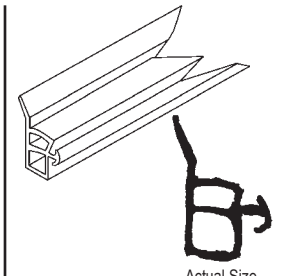

900-17896
Gray. Sold in Multiples of 100'

PERIMETER SEALS

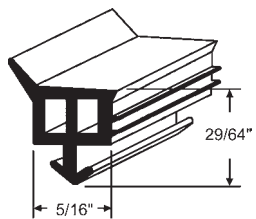

900-8718
Horizontal, Gray.
Sold in Multiples of 100'

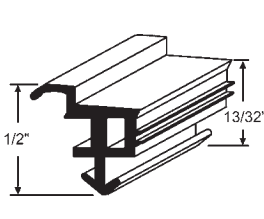

900-11245
Vertical, Gray.
Sold in Multiples of 100'

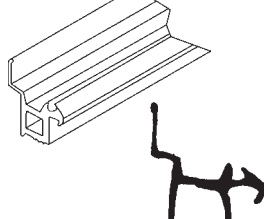

900-9970
Gray. Sold in Multiples of 100'

GLAZING SPLINE WITH FLEXIBLE FIN

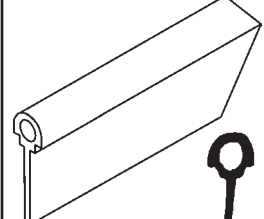

900-15846
Gray. Sold in Multiples of 100'

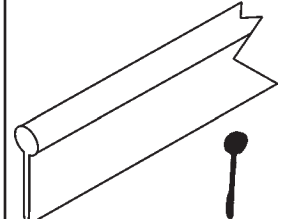

900-16077
Gray. Sold in Multiples of 100'

WINDOW/DOOR GLAZING & WEATHERSTRIPPING

LEAF WEATHERSEALS

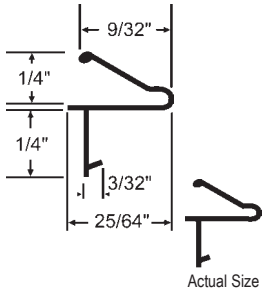

63-310W

White

7' Length - 20 Length Minimum

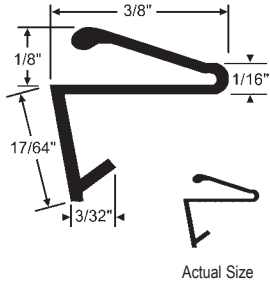

63-183-96W

White

8' Length - 10 Length Minimum

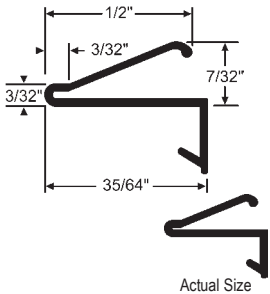

900-20766TN

Tan

7' Length - 20 Length Minimum

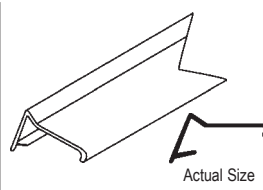

Actual Size

Part #	Color
65-75	Beige
65-75W	White

Used Primarily On Wood, Casement & Marvin Windows
6' Length - 120' Minimum

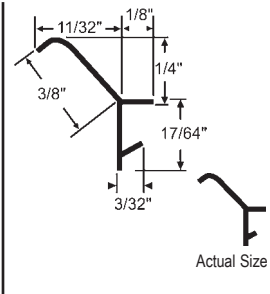

63-313TN

8' Length - 15 Length Minimum

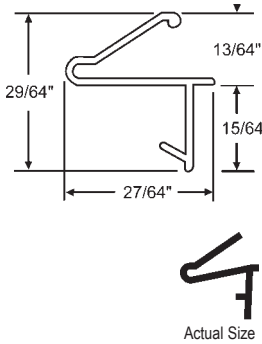

900-20755

7' Length - 20 Length Minimum

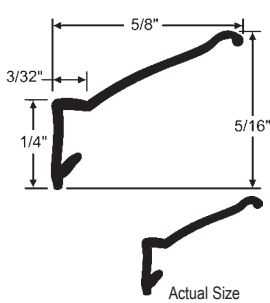

Part #	Color
900-20746TN	Tan
900-20746	White

8' Length - 15 Length Minimum
MALTA

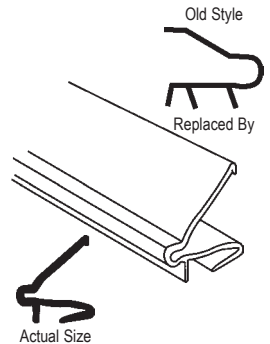

63-381B

Black. (6' Length) Order in Multiples of 6
PEACHTREE

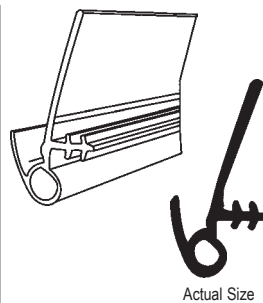

Actual Size

900-21613N
70". Black. Replaces Driftwood.
Sold in Multiples of 5 Lengths.
5 Length Minimum
PEACHTREE

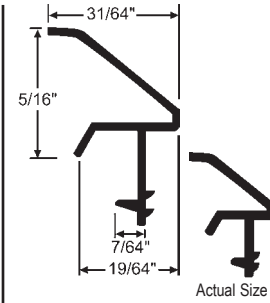

Part #	Color
63-327BZ	Bronze
63-327W	White

NORCO/JELD-WEN

FOAM "T" SLOT WEATHERSEAL

Superior operating ease. Outer cladding cuts friction in half. Superior resistance to compression set with one of a kind foam formula. Superior backing. Slips into a T-Slot and stays there. No stretching, no shrinkage.

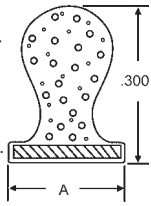

Part #	A
900-20383W	.190
900-20478W	.270

White. 100' Rolls

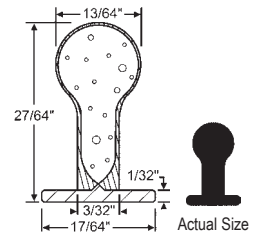

Part #	Color
63-469B	Black
63-469BG	Beige
63-469W	White

T-Slot Bulb Seal

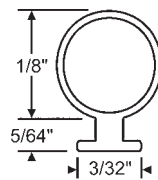

63-171

Black
Sold in Multiples of 100'

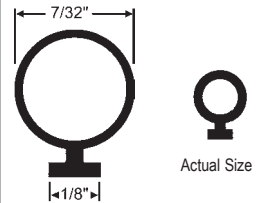

Actual Size

Part #	Color
63-247	Black

Vinyl. Sold in Multiples of 100'

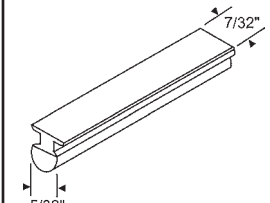

900-20207

Black Vinyl. Sold in Multiples of 100'

SEASONALL/SILVER LINE

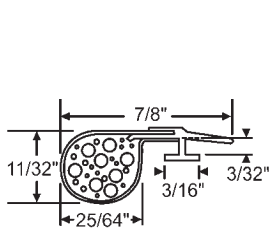

63-202W

White

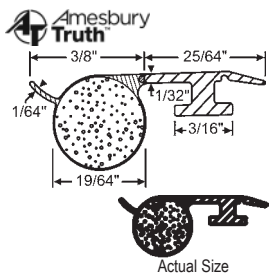

Part #	Color
63-465W	White
63-465B	Black

T-Slot Bulb Foam Offset.

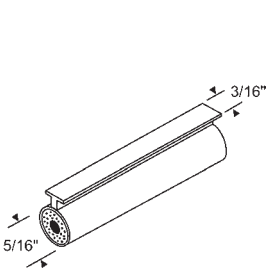

900-20230

Foam Filled White Vinyl Bubble Seal. Sold in Multiples of 100'
SEASONALL

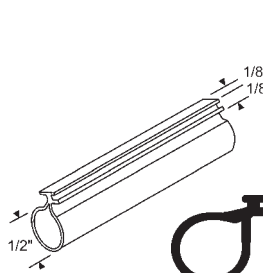

900-20281W

White. Sold in 8' Lengths. Minimum 15 Lengths
SEASONALL

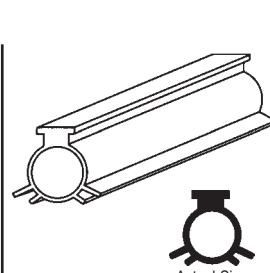

63-552W

Bulb Weather Strip. White
100' Rolls
PGT

WINDOW/DOOR GLAZING & WEATHERSTRIPPING

WEATHERSTRIP

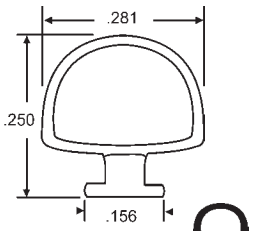

Actual Size

900-18224

"T" Slot Extruded Vinyl
Black. Sold in Multiples of 100'

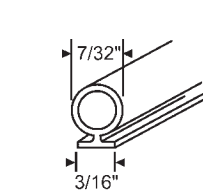

Part #	Color
63-429B	Black
63-429W	White

Vinyl. Sold in Multiples of 100'

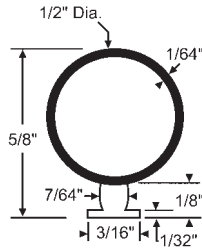

900-21430

White

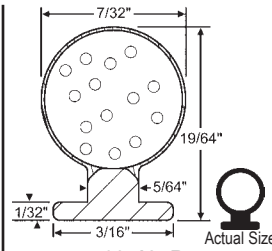

63-425B

.187 Backing X .300 Height.
Sold by ft. in multiples of 100'
Rolls. Black.

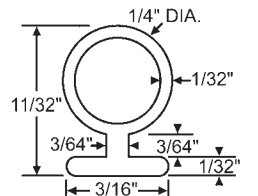

900-15702

Gray

PAN AM

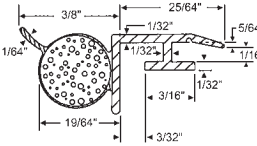

63-323W

Offset Foam Bulb T-Slot
Weatherseal. White

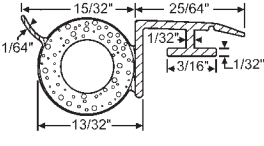

63-464W

Hollow Offset T-Slot
Weatherstrip. White

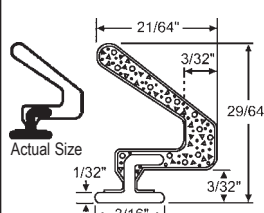

Part #	Color
63-379B	Black
63-379GY	Gray

Q-Lon Weatherseal
SCHLEGEL

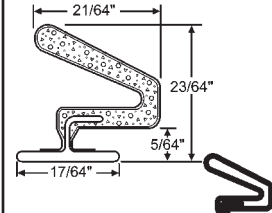

63-362B

Q-Lon Weatherseal. Black

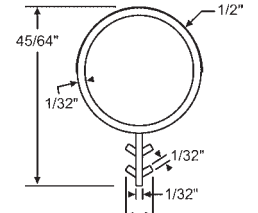

Part #	Color
63-288W	White
63-288BG	Beige

Sold in Multiples of 100'

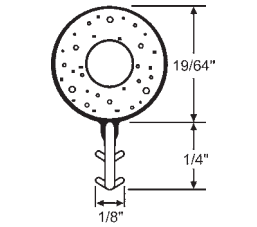

Part #	Color
63-513TN	Tan

Sold in Multiples of 100'

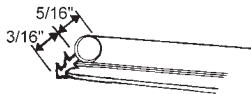

900-10041

Tan. Sold in 100' Rolls.

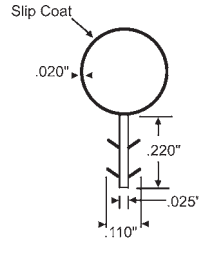

.300 Bulb Diameter

Part #	Color
63-150BG	Beige
63-150W	White
63-150BL	Black
63-150DB	Dark Brown

.250 Bulb Diameter

Part #	Color
63-164	Beige
63-164W	White
63-164B	Black

Sold in Multiples of 100'

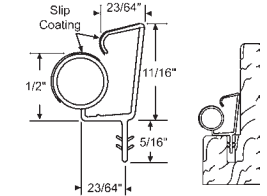

Part #	Color
63-208-82BZ	Bronze
63-208-82BG	Beige

Vinyl. 82" Long.
10 Length Minimum
PREMDOR/THERMA-TRU

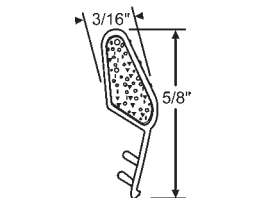

Part #	Color
63-703W	White
63-703BRN	Brown

Kerf Weatherseal. Sold by the
Foot in 100' Rolls

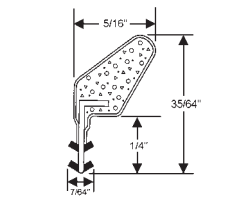

Part #	Color
63-215BZ	Bronze
63-215W	White

No Longer Available.
Use 63-703

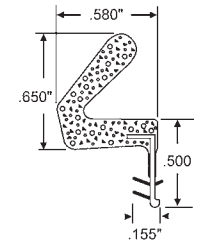

63-181BZ

No Longer Available.
Use 63-634BR

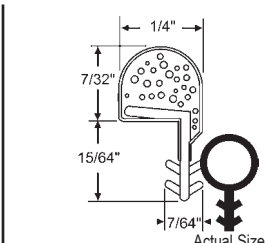

63-300W

White
SCHLEGEL

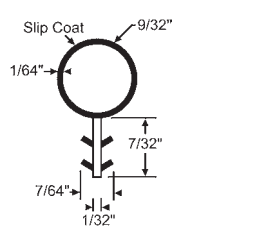

63-274W

White

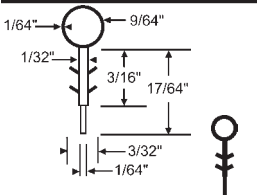

Part #	Color
63-193W	White
63-193	Beige

VEKA

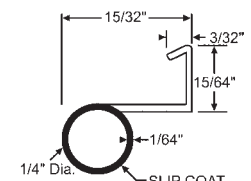

63-177BG

Beige. Rigid Kerf Leg.
Sold in Multiples of 100'

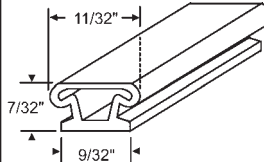

Part #	Color
63-360B	Black

Sold in Multiples of 100'
ACORN

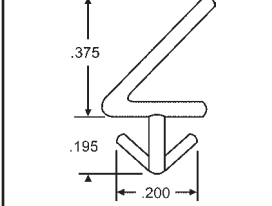

63-170

White. Extruded Vinyl.
Sold in Multiples of 100'

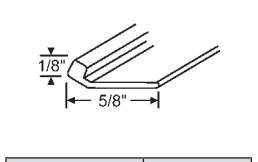

Part #	Color
63-502B-1	Black
63-502GY-1	Gray

Sold By 100' Roll
PAN AM

WINDOW/DOOR GLAZING & WEATHERSTRIPPING

WEATHERSTRIP

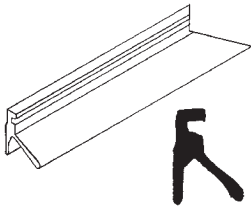

Actual Size

900-19465

Gray. Sold By 100' Roll

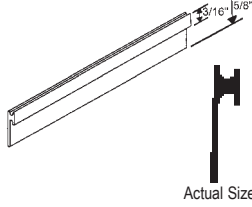

Actual Size

Part #	Color
900-21288	Black

Sold by the foot in 100' rolls

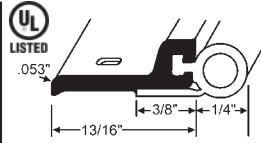

Part #	Finish
19-850-36	Mill
19-850BZ-36	Bronze Anodized

Set Contains 1 piece 36" Long and 2 pieces 84" Long. Includes Fasteners.

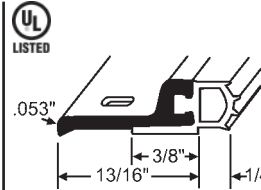

19-850-96F

96" Long. Mill. Includes Fasteners.



Part #	Finish
63-783B-17	Black
63-783W-17	White

Santoprene

17' Long. Adhesive Backed. For 6'8" Metal Door Jamb. Includes Installation Instructions and Alcohol Pads.

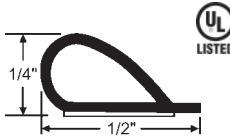

63-374DBR-20

Silicone

Brown. 20' Long. Adhesive Backed. For 8' Metal Door Jamb. Includes Installation Instructions and Alcohol Pads.

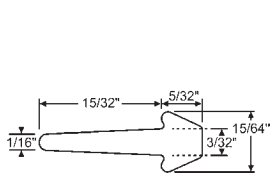

63-416B

Black EPDM Sponge
300' Minimum

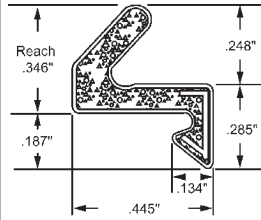

63-207

White
Sold in Multiples of 100'

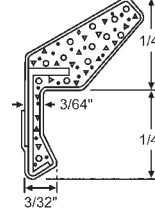

Part #	Color
63-221BZ	Bronze
63-221W	White

Sold in 150' Roll
SCHLEGEL

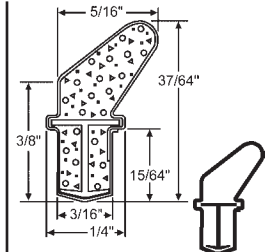

Actual Size

Part #	Color
63-385W	White
63-385BZ	Bronze
63-385BG	Beige

Sold in Multiples of 100'
SCHLEGEL

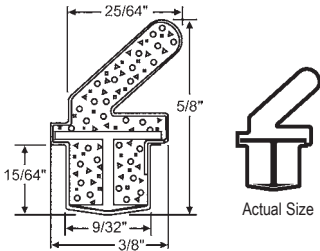

Actual Size

Part #	Color
63-391W	White
63-391BG	Beige

Q-LON Foam Seal Weatherstrip
Sold in Multiples of 200' Per Spool
CARADCO/POZZI SILVER LINE

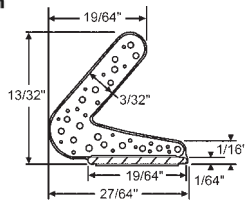

Part #	Color
63-700	Black
63-700BZ	Bronze
63-700W	White

81" Lengths. Sold in Multiples of 10
Lengths. Adhesive Backed

NAIL-UP FOAM DOOR SEAL

- Nail-up door seal set can be used for both wood and metal doors.
- Can also be used for leaking windows.
- Door seal comes in 7 ft. lengths and sold in multiples of 10 lengths.

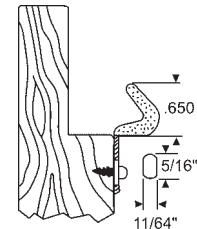
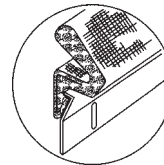

Part #	Color
900-18139BX	Brown
900-18139WX	White

DOOR SWEEP

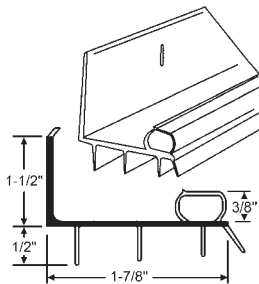

Part #	Color	Length
900-16933	Beige	35-11/16"
900-16933BZ	Bronze	35-11/16"
900-16933W	White	35-11/16"
900-16933W-32	White	31-11/16"

BENCHMARK/GENERAL PRODUCTS

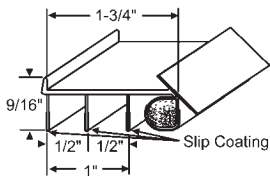

900-20750-36

Bronze Vinyl
36" Long

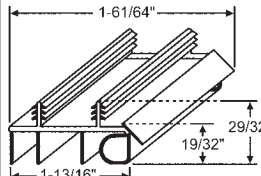

Part #	Color	Length
900-22371	Bronze	34-17/32"
19-342BG-36	Beige	36"
19-342BG-48	Beige	48"
19-342BZ-36	Bronze	36"
19-342BZ-48	Bronze	48"

MALTA

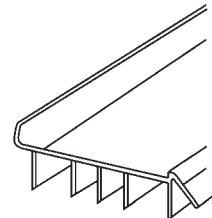

Part #	Color	Length
19-447-36	Brown	36"
19-447-48	Brown	48"

for 2-1/4" Doors

Field Performance

- Sure Seal (5) Fin Design
- Flexible to -25 Degrees F.
- Moisture Drip Fin
- Rigid PVC Base Retains Shape
- Extra Tough, Flexible PVC, Tear Resistant Fins

Installation Performance

- Universal Fit: Steel, Fiberglass & Wood Doors
- Staple Mount
- Split Resistant PVC Inside Door Mounting Lip

WINDOW/DOOR GLAZING & WEATHERSTRIPPING

DOOR SWEEP

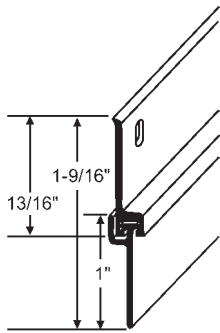

Part #	Finish
900-8179	White
900-8179BLK	Black
900-8179M	Mill

36" Long. Includes Fasteners.

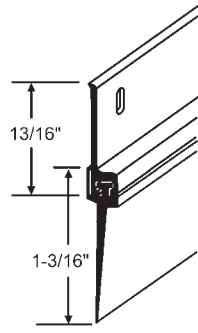

Part #	Finish
19-1032A	Mill
19-1032AZBZ	Bronze Anodized

36" Long. Includes Fasteners.

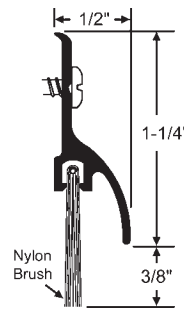

19-1046AZ-36

36" Long. Clear Anodized.
Includes Fasteners.
Adjustable Oblong Screw Holes.

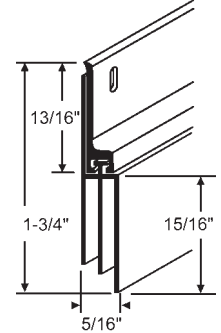

Part #	Finish
19-1031A	Mill
19-1031AZBZ	Bronze Anodized

36" Long. Triple Sweep.
Includes Fasteners.

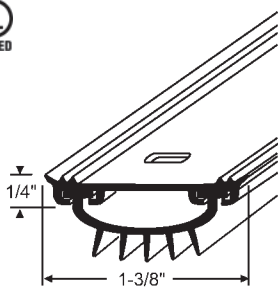

19-648

36" Long. Mill. Concealed Door Bottom.
1/2" Clearance. Includes Fasteners.

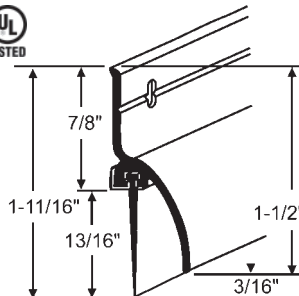

Part #	Finish
19-1030A	Mill
19-1030AZBZ	Bronze Anodized

36" Long. Includes Fasteners.

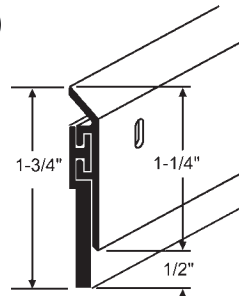

Part #	Finish
19-1033AZ-36	Clear Anodized
19-1033AZBZ	Bronze Anodized

36" Long. Includes Fasteners.
Heavy Duty

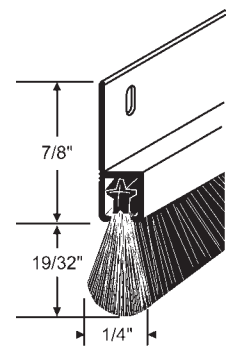

19-375A-36

36" Long. Mill. Includes Fasteners.

VINYL DOOR BOTTOM/SWEEPS

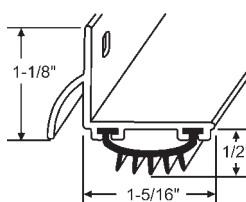

900-14246

36" Long. Mill. For 1-3/8" or 1-3/4" Doors.
Includes Fasteners.

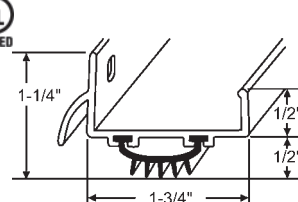

19-702A

Mill. 36" Long. Includes Fasteners.

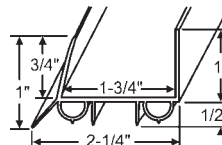

Part #	Finish
19-1045W-36	White
19-1045BR-36	Bronze

36" Long. Includes Fasteners and
Adjustable Oblong Screw Holes.

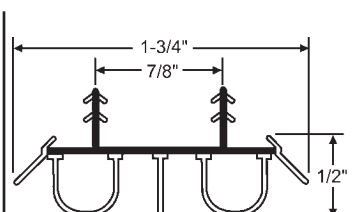

19-460

36" Long. Brown. Notched.

FOAM DOOR SEALS

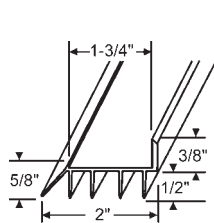

19-1053-37

37" Long. Brown. For 1-3/4" Wood Doors.

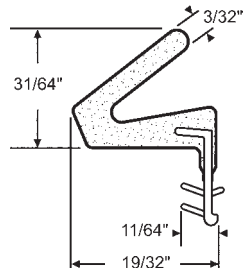

Part #	Color	Length
900-9176BZ	Bronze	82"
900-9176W	White	82"

Fire Rating: UL Rated for up to
180 Minutes. Sold in Multiples of
10 Lengths Min.

NEOPRENE SPONGE GASKET

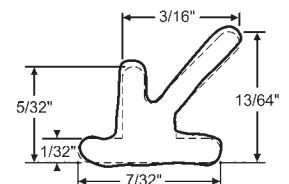

68-70B

Black. 1000' Per Box.
Sold in Multiples of 1000 ft.



New E-Lon Foam-Tite® Door Seals

- Direct drop-in replacement for our old 63-181 Q-Lon door seals •
- E-Lon is more flexible and water resistant •

Strybuc Industries is pleased to announce the availability of E-Lon door seals from Amesbury Truth™. It's the same high performing closed cell thermoplastic elastomer (TPE) found in other popular Foam-Tite® products. What makes E-Lon different and better than other door weather-strip products is its unique design combined with the superiority of the Foam-Tite® TPE material. You will note the hollows from the illustration on the right have been strategically placed into the profile to optimize the compression load deflection (CLD). The CLD is an industry metric used to measure the closing force of a door. E-Lon has been designed to mimic the closing force of other door weather-strip products, so your door feels the same when you close it and lock it.

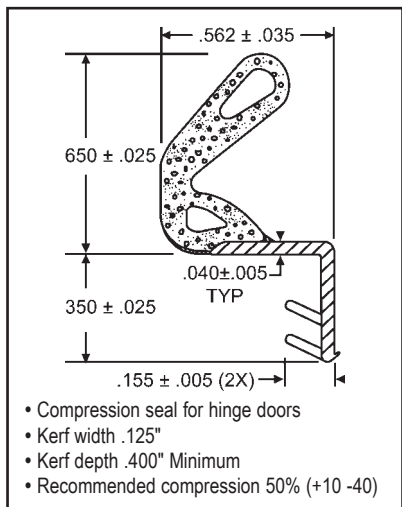
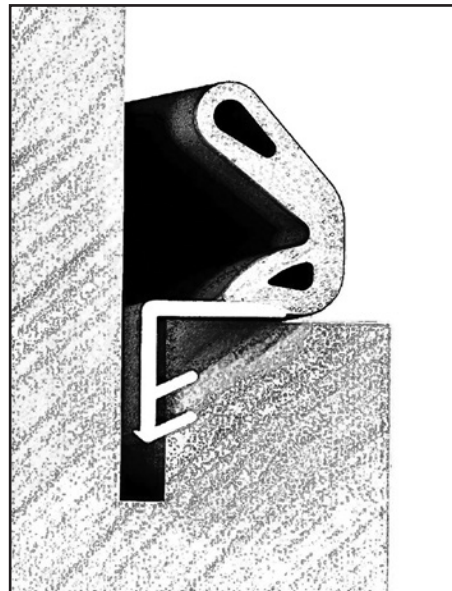

Reasons to want E-Lon Foam-Tite® Door Seals in your door:

- AAMA 702 Class A Performance Rating
- Low CLD
- Low H2O absorption
- Low shrinkage
- Low compression set
- Recyclable and sustainable
- Seamless skin
- Tear resistant skin
- Process friendly / Easy Installation

Sold in Multiples of 10 Lengths. 10 Length Minimum.

Part Number	Color	Length
63-634BR-38	Brown	38"
63-634BR-82	Brown	82"
63-634BR-97	Brown	97"
63-634TN-38	Tan (Beige)	38"
63-634TN-82	Tan (Beige)	82"
63-634TN-97	Tan (Beige)	97"
63-634W-38	White	38"
63-634W-82	White	82"
63-634W-97	White	97"

Sold by the Roll. 500' per Roll.

Part Number	Color
63-634BR	Brown
63-634TN	Tan (Beige)
63-634WH	White

WINDOW/DOOR GLAZING & WEATHERSTRIPPING

SKIRTING WEATHERSEAL

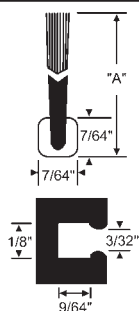

Part #	A	Finish
900-17451	.430	Gray
900-17452	.530	Gray
900-17453	.630	Gray

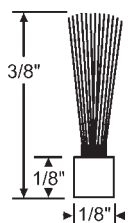

63-453
Gray. Sold in 100' Spools

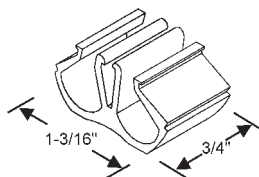

90-572
White Plastic
"Double"

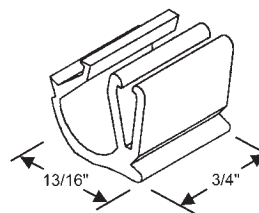

90-573
White Plastic
"Single"

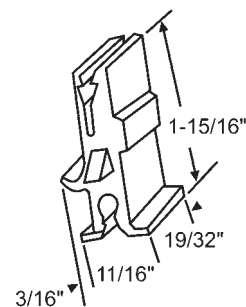

900-5371
Plastic
ALSCO ANACONDA

ADHESIVE FOAM WEATHERSTRIPPING TAPE

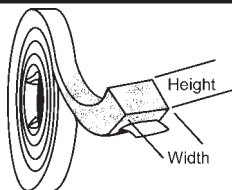

Part #	Size	Material	Color
63-151	3/8" Wide x 3/16" High x 17'	Vinyl, Closed Cell	Gray
63-152	1/2" Wide x 3/8" High x 10'	Vinyl, Closed Cell	Gray

FOAM CORNER SEALS

Q-Lon® Door Seal made of open-cell urethane foam core and clad in embossed polyethylene. Strike jamb and hinge jamb sill corners. One profile seals the strike side, hinge side and header while maintaining a tight seal.

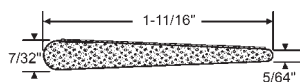
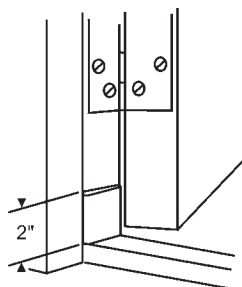

63-192BGU-2 Beige, 2" Lengths
63-192WU-2 White, 2" Lengths
63-192U-2 Bronze, 2" Lengths

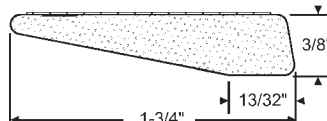

Part #	Color
63-296U-2	Bronze

2" Lengths

MAGNETIC WEATHERSTRIP REPLACEMENT FOR STEEL DOORS

Metal door replacement set consists of magnetic and compression pieces which fit into existing kerf around the door frame. Seals completely against drafts, dirt and moisture.

Packed 6 Per Carton

Set consists of:

- 1 pc. - 6' 8" Magnetic Weatherstrip
- 1 pc. - 3' Magnetic Weatherstrip
- 1 pc. - 6' 8" Compression Weatherstrip

Part #	Color
900-9000S	White
900-9000SBG	Beige
900-9000SBZ	Bronze

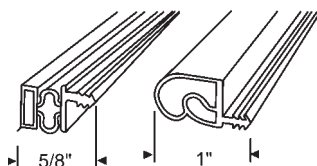

E.Z.D. GLAZING TOOL



Part #	Description
59-79	E.Z.D. Glazing Tool
59-79G	Hand Guard Replacement
59-79X	Blade Replacement

1. The Tool was designed to assist in the Deglazing of Glass from Residential Vinyl Windows. The most common glazing systems include foam tape, silicone, and butyl tape. It was not designed for some of the newer glazing compounds which are extremely hard and strong. It is not recommended for the deglazing of commercial units.
2. The Blade is designed to lay flat on the surface of the glass and slide into the glazing pocket. Tests have shown that a small amount of soapy water will facilitate this action. Once the tool is inserted into the glazing pocket, the wheel will roll through the glazing material much the same as a pizza cutter rolls through a pizza.
3. After the entire perimeter of the unit has been cut, the glass may be removed by applying gentle pressure to each corner with a putty knife or similar instrument. Do not use the tool in the corner because the torque applied will shorten the life of the tool substantially and may result in injury to the user.

Note: While the hand guard does provide some measure of protection from broken glass it is recommended the user always wear safety glasses and gloves when using the tool. The tool should be stored in its plastic bag when not in use.

WINDOW/DOOR GLAZING & WEATHERSTRIPPING

ENTRASEAL DOOR ASTRAGAL SEALS

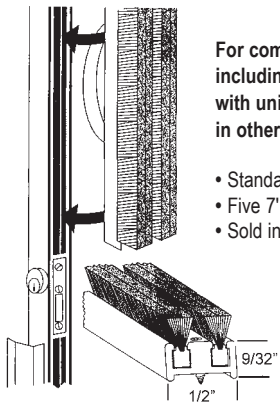

For commercial/entrance doors, including wood doors. Designed with unique features not available in other astragals.

- Standard pile height -.480"
- Five 7' lengths per tube.
- Sold in Multiples of 5.

63-500

Profile for Kawneer Door shown
Black

GRAY REPLACEMENT FIN WEATHERSTRIPPING

3/16" (.187) Backing Width

Pile Height	100 Ft.	500 Ft.	Misc.
.170 (11/64)	63-76	63-77	63-78-4.5 (4500')
.200 (13/64)	63-7	63-8	63-9R (4000')
.230 (15/64)	63-82	63-83	63-84-3.5 (3500')
.260 (17/64)	63-85	63-86	63-87-3 (3000')
.290 (19/64)	63-25	63-26	63-27R (3000')
.320 (21/64)	63-94	63-95	63-96R (2500')
.350 (23/64)	63-34	63-35	63-36R (2500')

17/64" (.270) Backing Width

Pile Height	100 Ft.	500 Ft.	Misc.
.170 (11/64)	63-40	63-41	63-42R (3500')
.200 (13/64)	63-46	63-47	63-48-3 (3000')
.230 (15/64)	63-52	63-53	63-54-2.5 (2500')
.260 (17/64)	63-112	63-113	63-114-2.5 (2500')
.290 (19/64)	63-61	63-62	63-63-2 (2000')
.320 (21/64)	63-121	63-122	63-123-2 (2000')
.350 (23/64)	63-70	63-71	63-72R (1500')

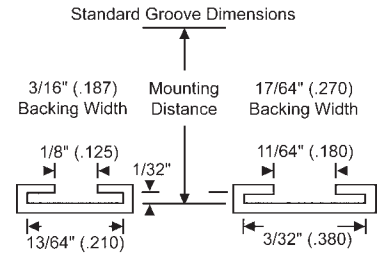
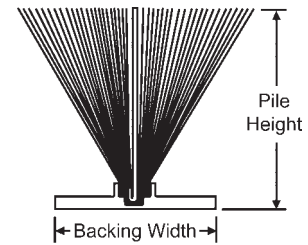

Additional backing sizes available: 23/64", 27/64", 1/2"

WEATHERSTRIPPING WITH ADHESIVE BACKING

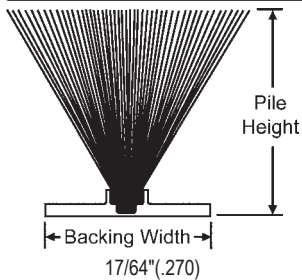

Part #	Length
63-49TP	100 ft. roll
63-51TP	1,000 ft. roll

7/32" (.220) Pile Height

Part #	Length
63-55TP	100 ft. roll
63-57TP	1,000 ft. roll

1/4" (.250) Pile Height

Other Sizes Available Upon Request With Minimum Orders

WOOLPILE WEATHERSTRIP

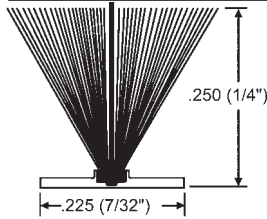

WDW 26

Gray. Sold by the Foot in 100' Rolls

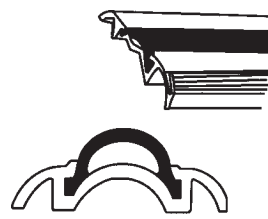

900-13005

36" Replacement Threshold Insert. Gray, Vinyl

MISC

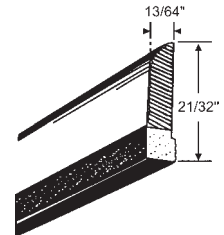

900-14942

Wood & Vinyl Foam Door Set
2 pc. 7' Long, 1 pc. 3' Long

QUANEX SUPER SPACER



New & Improved

Energy efficient Super Spacer® Premium Plus.

Super Spacer® Premium Plus is a flexible, silicone foam spacer product. Super Spacer® provides the maximum in perimeter insulation for sealed glazing units and prevents condensation. Desiccant-filled with pre-applied side adhesive, the structural foam spacer significantly simplifies insulating glass (IG) production.

Featuring a vapor barrier backing, the product must be used in combination with conventional IG sealants such as hot melt butyl, polyurethane and solvent-free polysulfide. Dual seal equivalent sealants may also be used.

Enhanced Features Include:

- Up to 30% lower thermal conductivity
- Superior long-term durability
- The warmest edge of glass temperature
- The highest NFRC Condensation Resistance rating

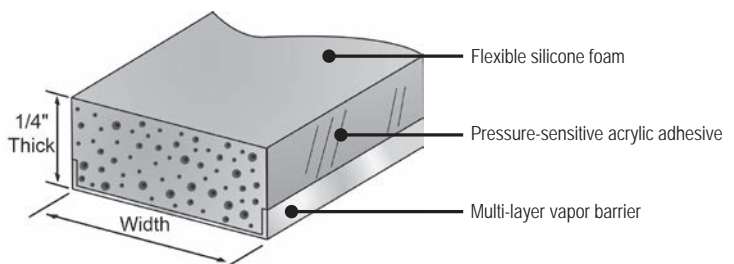
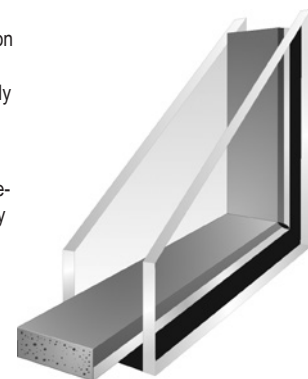

Gray	Black	Width	Reel Size
92-502		3/16"	66'
92-503	92-503B	1/4"	66'
92-503X	92-503XB	1/4"	1100'
92-504	92-504B	5/16"	66'
92-504X	92-504XB	5/16"	1100'
92-505	92-505B	3/8"	66'
92-505X	92-505XB	3/8"	900'
92-506	92-506B	7/16"	66'
92-507	92-507B	1/2"	66'
92-507X	-	1/2"	700'
92-508	92-508B	9/16"	66'
92-509	92-509B	5/8"	66'
92-509X	-	5/8"	575'
92-510	92-510B	11/16"	66'
92-511	92-511B	3/4"	66'
92-512	-	13/16"	66'
92-512X	-	13/16"	400'

ADHESIVE SEALANT



SOUDAL



Part #	Color	Size
59-137W	White	10.1 oz. Tube
59-137	Clear	10.1 oz. Tube
59-138W	White	20 oz. Sausage

Characteristics:

- Permanent color
- UV resistant
- Excellent moisture and mold resistance.
- Stays fully elastic after curing
- Good adhesion on many materials
- Easy application
- Medium modulus
- Movement up to +/- 25%

Applications:

- Building and construction joints
- Top sealing at glazing jobs
- Suitable as back bedding compound as well as weather sealant
- Joints with high movement between different building materials
- Sealing between treated wood, metal, PVC profiles and glass

Silirub N1 is a Premium Grade 100%, Neutral Cure Silicone

- Permanently flexible
- Easy to apply
- Excellent adhesion to glass, vinyl, wood, aluminum & many more
- Low odor
- UV resistant
- No shrinkage
- AAMA compliant

Surfaces:

- Type: all usual building surfaces
- State of surface: clean, dry, free of dust and grease
- Preparation: Prime porous surfaces with Primer, no primer required for non-porous surfaces.

We recommend a preliminary compatibility test, especially on PVD and powder coated materials.

Note: Custom Color Matching Available. Three Case Minimum (12 Per Case). Check with Your Account Manager for Available Colors and Lead Times.

PU FOAMS

CLEANERS



59-132
Gun Foam

Soudafoam Door & Window is a minimal expansion, one component, moisture curing PU foam

- 24 oz. Aerosol Can
- Minimal Expansion
- Easy Application
- Excellent Adhesion to Almost all Substrates
- Excellent Thermal and Acoustical Insulation
- No Shrinkage
- AAMA Compliant



59-134
Genius Gun

Soudafoam Door & Window is a minimal expansion, one component, moisture curing PU foam

- 20 oz. Aerosol Can
- Integrated Gun System
- Reusable
- Minimal Expansion
- Easy Application
- Excellent Adhesion to Almost all Substrates
- Excellent Thermal and Acoustical Insulation
- No Shrinkage



59-135
Cleaning Wipes

SwipeX are solvent based cleaning wipes for uncured sealants & adhesives.

- Non Woven Wipes
- Impregnated with a Mixture of Solvents, Biodegradable Non-Ionic Surfactants and Skin Emollients
- Suitable for all Non-Porous Surfaces
- For Hands and Tools
- Cleans Uncured Solvent
- Removes Oil, Adhesive, Etc.
- 100 Wipes



59-136
Gun & Foam Cleaner

Soudal Gun & Foam Cleaner Is a solvent cleaner

- specifically designed for cleaning of uncured PU foam
- 12 oz. aerosol can
 - For Hands and Tools
 - Cleans Uncured Solvent
 - Removes Oil, Adhesive, Etc.

WINDOW/DOOR GLAZING & WEATHERSTRIPPING

GLASS CUTTER



59-112

Metal Handle Glass Cutter. Tungsten Carbide Wheel

VINYL GLAZING BEAD IDENTIFICATION RING



500-98NEW

The #500-98NEW Contains 126 of the Most Popular Vinyl and Metal Glazing Bead Samples Organized by Shape and Color Approximately 1-1/2" Long on a Large Stainless Steel Ring with Locking Screw Threads.

- Take the ring of beads to your job repair site so you can identify broken beads in a minute.
- Avoid the clutter of keeping your samples in a bag or box, losing pieces, and save time with the ring program.
- Each ring keeps all your glazing bead samples together and organized so you are not losing samples, and can find them all right away to identify the bead you need.
- Each bead has a label with part number on it. You can add or remove beads as you need to or reorganize the beads the way you want them.

GLASS CLEANER

Spray X Glass Cleaner contains less water and more cleaning power. Our patent pending formulation allows us to meet the current VOC regulations and deliver maximum cleaning performance for our customers. Compare our alcohol content to other national brands and you'll notice our quality is significantly higher

Spray X Glass Cleaner uses SD-40B cosmetic grade alcohol that is 200 proof and 99.9% pure. This type of alcohol requires a registration with the US Department of Alcohol, Tobacco and Firearms, and each Spray-X Glass Cleaner can is marked with our registration number. Compare our registration to other brands and you'll quickly agree this product has been performance engineered to meet all your glass cleaning needs.

Spray X Glass Cleaner for cleaning and polishing glass, mirrors and other nonporous surfaces. This easy-to-use, fast-acting product uses clinging foam to break up soils and hold them - even on vertical surfaces. There's no dripping, no running and no streaking. With an exclusive industrial strength formulation, this product cleans thoroughly, dries quickly, requires no rinsing and leaves a pleasant, fresh aroma.

Spray-X Glass Cleaner utilizes a 360 degree valve for ease of use. This allows our product to be sprayed right side up or upside down. Other brands cannot spray upside down, but we have this solid valve feature, plus the anti-fatigue finger pad makes this packaging very attractive to all users.

Spray-X Glass Cleaner is alcohol based. It does not contain ammonia. When comparing our performance on tinted glass to ammoniated brands most professional installers praise the difference.

Spray-X Glass Cleaner is packaged in a two-piece steel can. No side seam means we use less energy and material and generate less waste. Our can weighs 10% less than the three-piece equivalent and is 100% recyclable. You will appreciate the new contemporary can design.



Foaming Glass Cleaner

59-101

19 oz. can
12 cans per case

- Industrial Strength
- The most versatile glass cleaner available
- Cleans glass, windows, mirrors, windshields, enamel surfaces, chrome, tile, porcelain and other hard surfaces.
- Sprays in any position
- Dissolves dirt, grease, grit and grime
- Heavy-Duty Foam clings to vertical surfaces
- Non-ammoniated
- Guaranteed to leave no film - "Streak Free"
- Safe on tinted glass, plastic and mirrors
- Contains cosmetic-grade alcohol for best performance
- Superior quality at competitive pricing
- Patent Pending Formulation

PRIVATE LABEL SPRAY-X FOAMING GLASS CLEANER

"Private Label Spray-X Foam Glass Cleaner as your own!!"



59-101P50

19 oz. can
600 Can Minimum
(50 Cases, 12 cans per case)

59-101P450

4 oz. can
600 Can Minimum
(50 Cases, 12 cans per case)

- Guaranteed to Leave No Film- "Streak Free"
- Industrial Strength
- Cleans Glass, Windows, Mirrors, Windshields, Enamel Surfaces, Chrome, Tile Porcelain and Other Hard Surfaces
- Sprays in Any Position
- Dissolves Dirt, Grease Grit and Grime
- Heavy-Duty Foam Clings to Vertical Surfaces
- Non-Ammoniated
- Contains Cosmetic-Grade Alcohol for Best Performance
- Superior Quality at Competitive Pricing
- Advanced Formulation
- Available in 19 oz. and 4 oz. Cans



SCREEN HARDWARE

CUSTOM MADE STANDARD ROLL FORM ALUMINUM WINDOW SCREEN CONFIGURATIONS

RFSH1

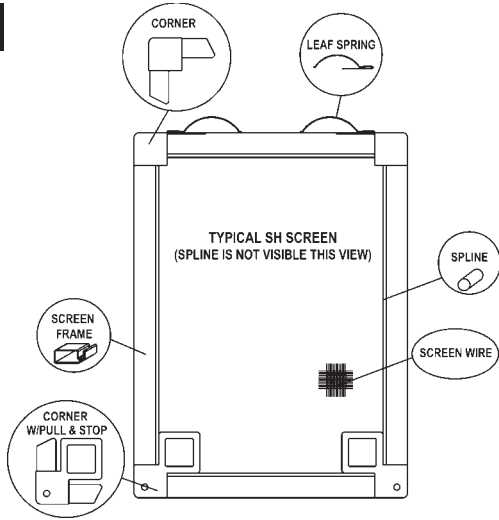

RFSH2

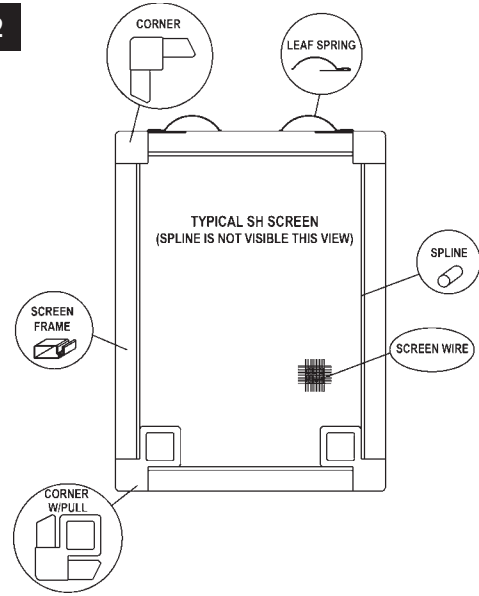

RFSH3

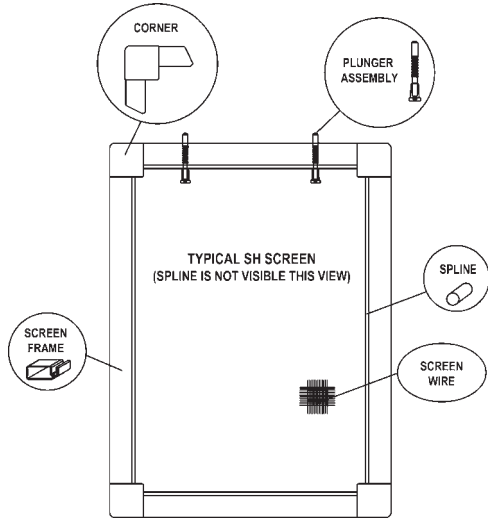

RFSH4

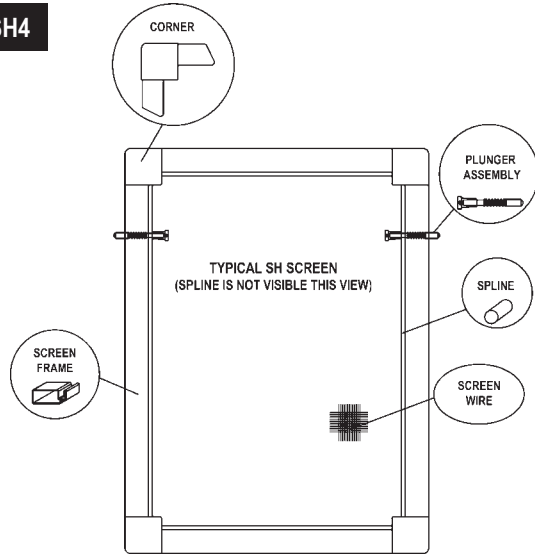

RFSH5

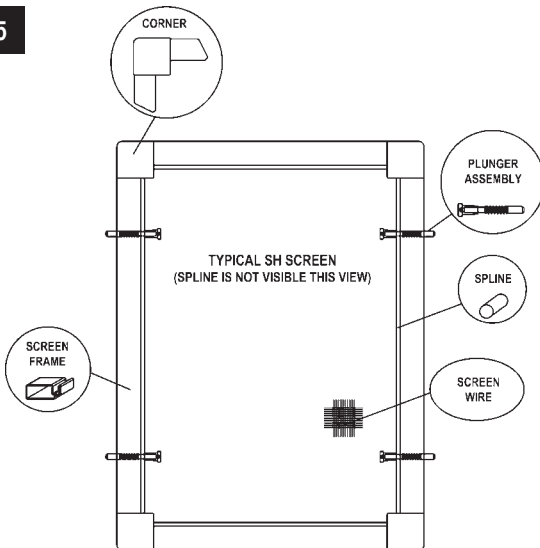

RFSH6

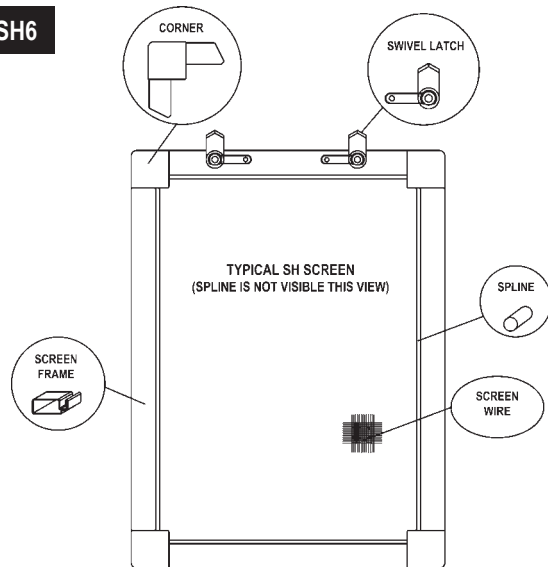

CUSTOM MADE STANDARD ROLL FORM ALUMINUM WINDOW SCREEN CONFIGURATIONS

RFSH7

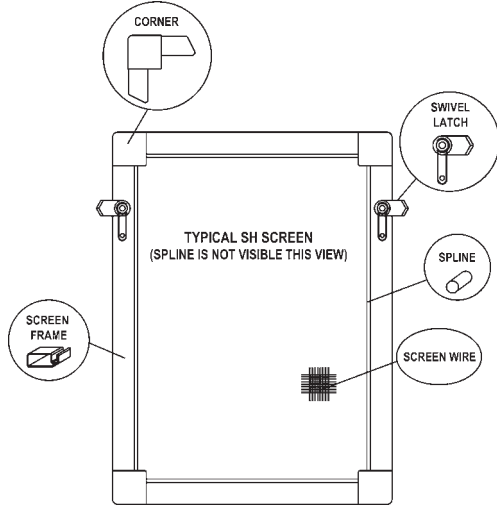

RFSH8

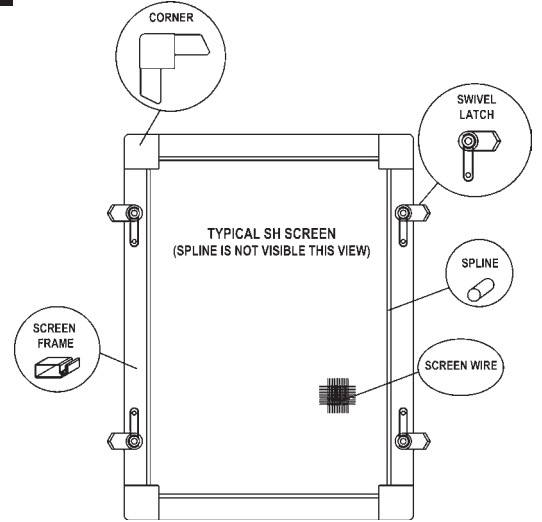

RFDH1

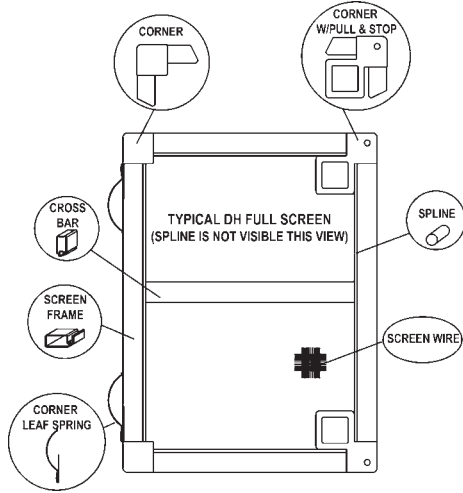

RFDH2

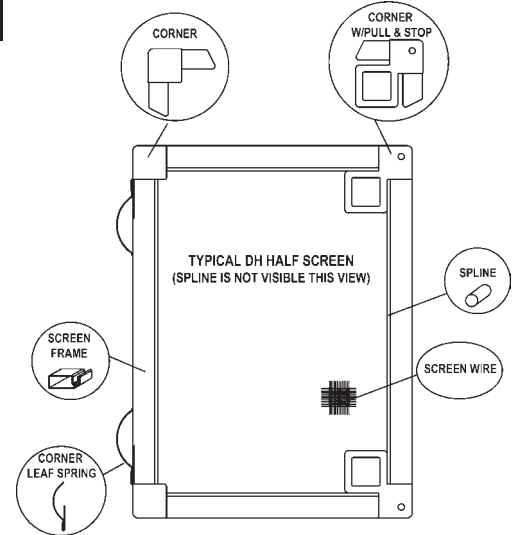

RFDH3

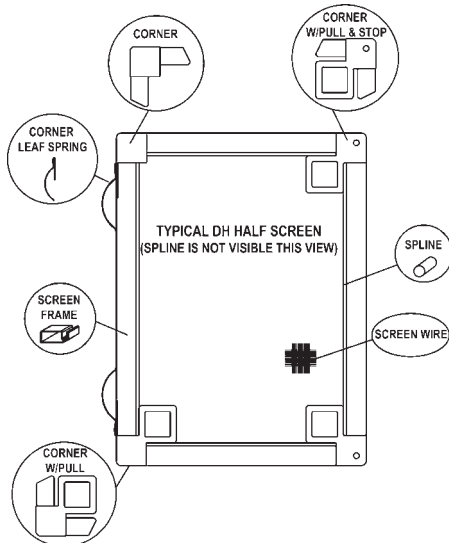

RFDH4

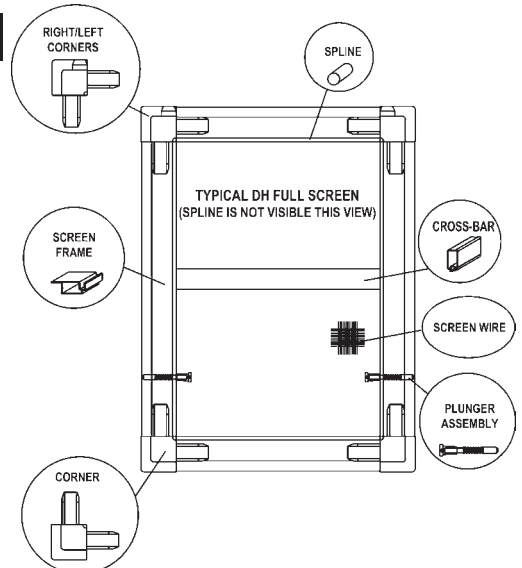

SCREEN HARDWARE

CUSTOM MADE STANDARD ROLL FORM ALUMINUM WINDOW SCREEN CONFIGURATIONS

RFDH5

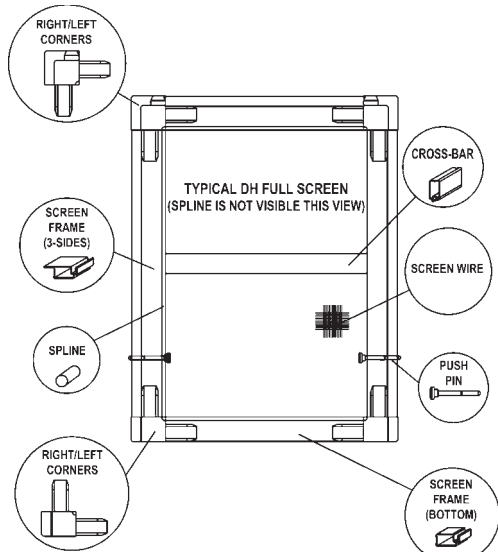

Note: RFDH5 uses two screen frames. One for the bottom and 3 flanged frames for the remaining sides.

RFSL1

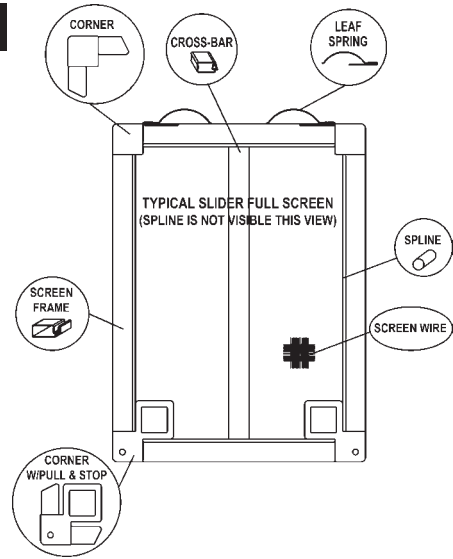

RFSL2

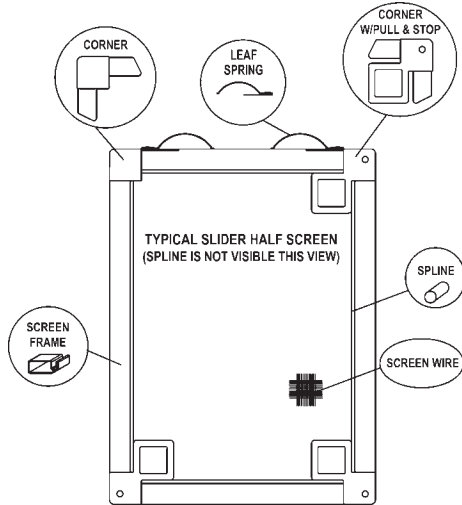

RFFS1

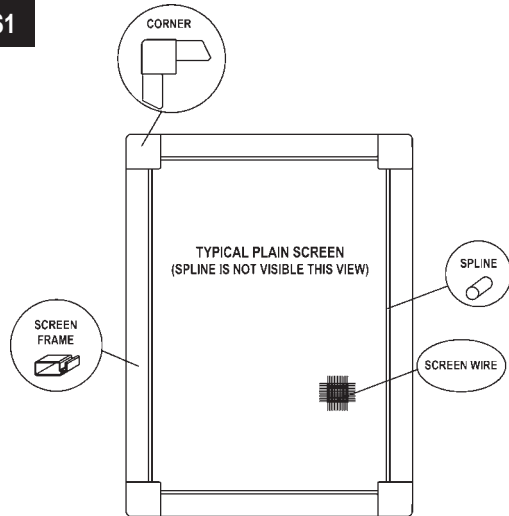

RFFS2

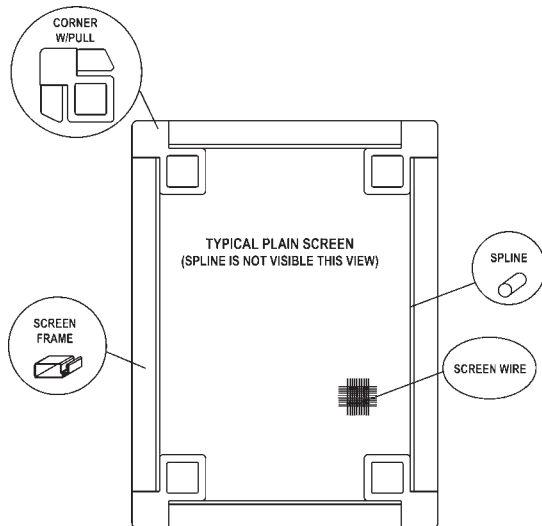

RFCA1 - with plungers (shown)

RFCA2 - no plungers

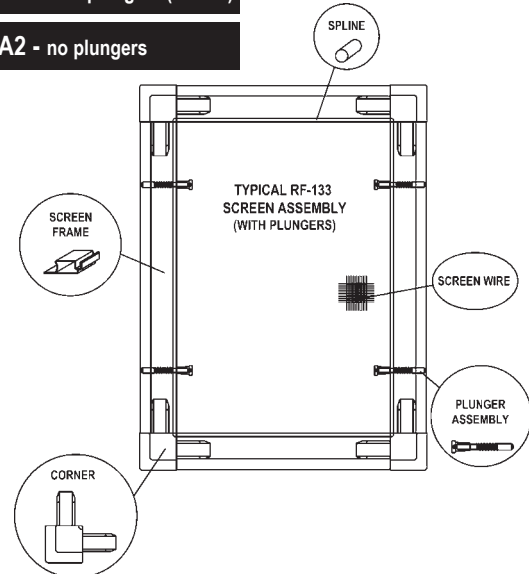

SCREEN FRAMES

.019 Gauge

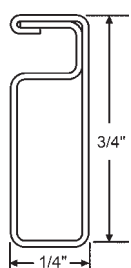

Part #	Length	Carton Qty	Wt	Color
90H-250	12' 5"	190 Igths	120.9 lbs.	Mill
90H-250AD	12' 5"	190 Igths	120.9 lbs.	Almond
90H-251	12' 5"	190 Igths	120.9 lbs.	White
90H-252	12' 5"	190 Igths	120.9 lbs.	Bronze
90H-253	8'	20 Igths	8.2 lbs.	Mill
90H-254	8'	20 Igths	8.2 lbs.	White
90H-255	8'	20 Igths	8.2 lbs.	Bronze

Screen frame uses .125-1/8" Spline.
Can use .120" Spline

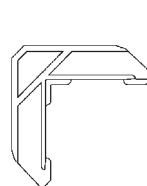

90H-352
Inside Corner Key
Metal

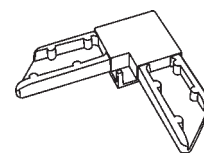

Part #	Color
90-451	Mill
90-452	White
90-453	Dark Bronze

Outside Corner Key
Plastic

.019 Gauge

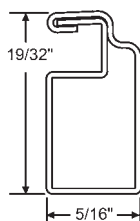

Part #	Length	Carton Qty	Wt	Color
90H-232	12' 5"	160 Igths	79.6 lbs.	Mill
90H-233	12' 5"	160 Igths	79.6 lbs.	White
90H-234	12' 5"	160 Igths	79.6 lbs.	Bronze
90H-235	8'	20 Igths	6.3 lbs.	Mill
90H-236	8'	20 Igths	6.3 lbs.	White
90H-237	8'	20 Igths	6.3 lbs.	Bronze

Screen frame uses .125-1/8" Spline.
Can use .120" Spline

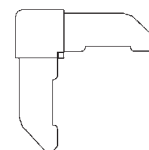

Part #	Color
90H-1257M	Mill
90H-1257W	White
90H-1257BZ	Dark Bronze

.019 Gauge

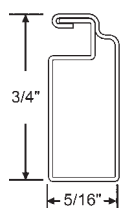

Part #	Length	Carton Qty	Wt	Color
90H-220	12' 6"	152 Igths	98 lbs.	Mill
90H-220AD	12' 6"	152 Igths	98 lbs.	Almond
90H-221	12' 6"	152 Igths	98 lbs.	White
90H-222	12' 6"	152 Igths	98 lbs.	Bronze
90H-223	8'	20 Igths	8.1 lbs.	Mill
90H-223AD	8'	20 Igths	8.1 lbs.	Almond
90H-224	8'	20 Igths	8.1 lbs.	White
90H-225	8'	20 Igths	8.1 lbs.	Bronze

Screen frame uses .140-9/64" spline.
Can use .145" Spline

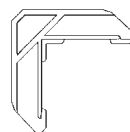

90H-106P
Inside Corner Key
Plastic

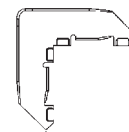

90H-106
Inside Corner Key
Metal

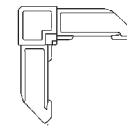

Part #	Color
90H-436	Mill
90H-436AD	Almond
90H-437	White
90H-438	Bronze

Outside Corner Key. Plastic

.019 Gauge

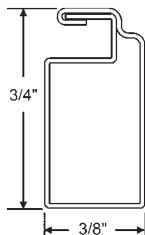

Part #	Length	Carton Qty	Wt	Color
90H-196	12' 6"	128 Igths	90 lbs.	Mill
90H-196AD	12' 6"	128 Igths	90 lbs.	Almond
90H-197	12' 6"	128 Igths	90 lbs.	White
90H-198	12' 6"	128 Igths	90 lbs.	Bronze
90H-199	8'	20 Igths	8.9 lbs.	Mill
90H-199AD	8'	20 Igths	8.9 lbs.	Almond
90H-200	8'	20 Igths	8.9 lbs.	White
90H-201	8'	20 Igths	8.9 lbs.	Bronze

Screen frame uses .125-1/8" Spline.
Can use .120" Spline

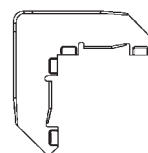

90H-125
Inside Corner Key
Metal

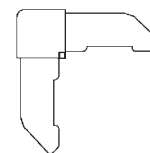

Part #	Color
90H-454	Mill
90H-454AD	Almond
90H-455	White
90H-456	Bronze

Outside Corner Key. Plastic

.019 Gauge

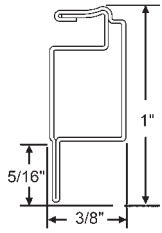

Part #	Length	Carton Qty	Wt	Color
90H-997	12' 6"	120 lgths	99.9 lbs.	Mill
90H-998	12' 6"	120 lgths	99.9 lbs.	White
90H-999	12' 6"	120 lgths	99.9 lbs.	Bronze
90H-1000	8'	15 lgths	7 lbs.	Mill
90H-1001	8'	15 lgths	7 lbs.	White
90H-1002	8'	15 lgths	7 lbs.	Bronze

Screen frame uses .125-1/8" Spline.
Can use .120" Spline

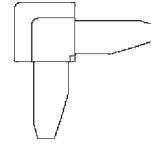

Part #	Color
90H-1003	Mill
90H-1004	White
90H-1005	Bronze

Outside Corner Key. Plastic

.019 Gauge

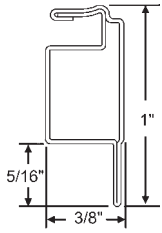

A Good Substitute For Bayform Series B38LI Frame

Part #	Length	Carton Qty	Wt	Color
90H-1117	8'	15 lgths	7 lbs.	Mill
90H-1118	8'	15 lgths	7 lbs.	White
90H-1119	8'	15 lgths	7 lbs.	Bronze

Screen frame uses .125-1/8" Spline.
Can use .120" Spline

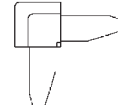

Part #	Color
90H-1120	Mill
90H-1121	White
90H-1122	Bronze

Outside Corner Key. Plastic

.019 Gauge

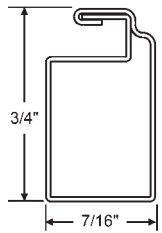

Part #	Length	Carton Qty	Wt	Color
90H-280	12' 5"	120 lgths	78.3 lbs.	Mill
90H-281	12' 5"	120 lgths	78.3 lbs.	White
90H-282	12' 5"	120 lgths	78.3 lbs.	Bronze
90H-283	8'	20 lgths	8.3 lbs.	Mill
90H-284	8'	20 lgths	8.3 lbs.	White
90H-285	8'	20 lgths	8.3 lbs.	Bronze

Screen frame uses .145-9/64" Spline.
Can use .140" Spline

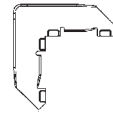

90H-463
Inside Corner Key
Metal

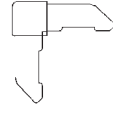

Part #	Color
90H-460	Mill
90H-461	White
90H-462	Bronze

Outside Corner Key. Plastic

.020 Gauge

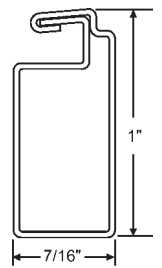

A Good Substitute to Fit Andersen Windows

When substituting for an Andersen screen, use the external plastic corner keys.

Part #	Length	Carton Qty	Wt	Color
90H-504M	12' 6"	70 lgths	63 lbs.	Mill
90H-504W	12' 6"	70 lgths	63 lbs.	White
90H-504BZ	12' 6"	70 lgths	63 lbs.	Bronze
90H-505M	8'	14 lgths	6.8 lbs.	Mill
90H-505W	8'	14 lgths	6.8 lbs.	White
90H-505BRZ	8'	14 lgths	6.8 lbs.	Bronze

Screen frame uses .125-1/8" Spline.
Can use .120" Spline

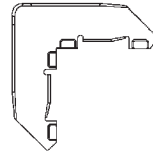

90H-1263
Internal Metal Corner

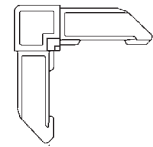

Part #	Color
90H-1263M	Mill
90H-1263W	White
90H-1263BZ	Bronze

External Plastic Corner Key
Hollow Back

.019 Gauge

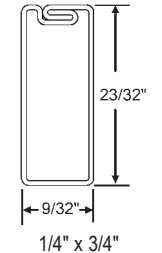

1/4" x 3/4"
Tubular Cross Brace

Part #	Length	Carton Qty	Wt	Color
90H-178	11' 6"	168 lgths	102.1 lbs.	Mill
90H-179	11' 6"	168 lgths	102.1 lbs.	White
90H-180	11' 6"	168 lgths	102.1 lbs.	Bronze
90H-181	8'	20 lgths	7.2 lbs.	Mill
90H-182	8'	20 lgths	7.2 lbs.	White
90H-183	8'	20 lgths	7.2 lbs.	Bronze

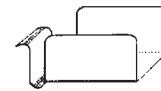

90H-313
Cross Brace Insert
Fits 1/4" x 3/4" Cross Brace

SCREEN WIRE & SCREEN CLOTH

Note for Screen Wire and Cloth:

When ordering over \$1000 of combined screen wire and cloth, with the exception of SuperScreen™, you will receive free freight dropped shipped from our vendor. Must be placed on a separate order.

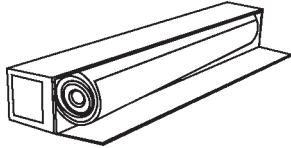

Fiberglass 18 x 16 Mesh

100 Foot Roll

Popular package for contractors and for hardware stores that repair screens.

- 011" Diameter
- Easy to Install
- Resilient, Long Lasting
- Fire and Corrosion Resistant
- Will Not Crease, Dent or Unravel
- Withstands All Climates, Salt Air and Industrial Fumes

Width	Charcoal Part #	Gray Part #
16"	69-1	69-2
18"	69-7	69-8
20"	69-13	69-14
22"	69-19	69-20
24"	69-25	69-26
26"	69-31	69-32
28"	69-37	69-38
30"	69-43	69-44
32"	69-49	69-50
34"	69-55	69-56
36"	69-61	69-62
42"	69-67	69-68
48"	69-73	69-74
60"	69-79	69-80
72"	69-85	69-86

Fiberglass 7' Roll

Popular item for home centers and hardware stores. A big do-it-yourself item. Enough to cover two average size windows or one screen door.

Width	Charcoal Part #
30"	69-43-7
36"	69-61-7
48"	69-73-7

Fiberglass 18 x 16 Mesh

600 Foot Roll

(Other Sizes Available)

Width	Charcoal Part #	Gray Part #
16"	69-3	69-4
18"	69-9	69-10
20"	69-15	69-16
22"	69-21	69-22
24"	69-27	69-28
26"	69-33	69-34
28"	69-39	69-40
30"	69-45	69-46
32"	69-51	69-52
34"	69-57	69-58
36"	69-63	69-64
42"	69-69	69-70
48"	69-75	69-76
60"	69-81	69-82
72"	69-87	69-88

Aluminum 18 x 16 Mesh

100 Foot Roll

Popular package for contractors and for hardware stores that repair screens.

- 011" Diameter
- Strong and Durable
- Resists Rust, Won't Sag
- Withstands all Climates
- Protective Finish Prevents Corrosion, Strengthens Weave, Enhances Appearance

Width	Bright Part #	Charcoal Part #	Black Part #
16"	69-5	69-6	69-6B
18"	69-11	69-12	69-12B
20"	69-17	69-18	69-18B
24"	69-29	69-30	69-30B
26"	69-35	69-36	69-36B
28"	69-41	69-42	69-42B
30"	69-47	69-48	69-48B
32"	69-53	69-54	69-54B
34"	69-59	69-60	69-60B
36"	69-65	69-66	69-66B
42"	69-71	69-72	69-72B
48"	69-77	69-78	69-78B
60"	69-83	69-84	69-84B
72"	69-89	69-90	69-90B

Solar Screen Cloth



Solar Screening is an inexpensive and easy to install alternative designed to provide an attractive outdoor appearance while maintaining good visibility from inside with no distortion. It filters sunlight, helps reduce air conditioning bills and lessens fading of carpet, upholstery and drapes. Superior heat resistance and color retention help keep it looking great for years.

Sun Guard 85

(54 x 18 mesh .011" Diameter)

Reflects and dissipates up to 85% of sun's rays entering the building.

Part #	Size	Color
69-S25	24" x 100'	Charcoal
69-S43	30" x 100'	Charcoal
69-S61	36" x 100'	Charcoal
69-S73	48" x 100'	Charcoal
69-S79	60" x 100'	Charcoal
69-S85	72" x 100'	Charcoal

Sun Guard 90

(40 x 40 mesh .011/0.13" Diameter)

Reflects and dissipates up to 90% of sun's rays entering the building.

Part #	Size	Color
69-187	36" x 100'	Charcoal
69-188	48" x 100'	Charcoal
69-189	60" x 100'	Charcoal
69-190	72" x 100'	Charcoal
69-191	96" x 100'	Charcoal

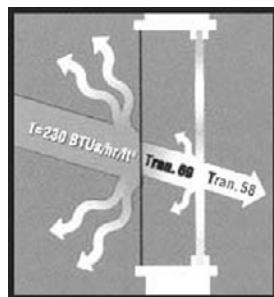

Energy-saving sun screening provides maximum solar control and visibility.



Pet Screen Cloth

(17 x 11 Mesh .025" Diameter)

Ultra strong screening resists tears and damage by dogs and cats yet still offers superb outward visibility. Ideal for areas where children or pets push against the screen.

Resistant to tears and damage caused by household pets.

Width	Charcoal Part #
36" x 100'	69-PP61
36" x 7'	69-PP61-7
48" x 100'	69-PP73
48" x 7'	69-PP73-7

SuperScreen™

The Newest Technology in Enclosure Screen!

The Newest Technology Available in Screen Protection for Pool, Porch and Patio Enclosures, SuperScreen™ is the Perfect Choice for Those Who Demand the Very Best in Safety, High Quality and Long Lasting Home Improvement Products.

- SuperScreen™ is so durable it has a **10 YEAR LIMITED WARRANTY** and is guaranteed to last.
- SuperScreen™ exceeds Florida's building code requirements of section 553.73 for pool fencing.
- SuperScreen™ is lightweight yet **pet resistant** and is tear and puncture proof.
- SuperScreen™ is a PVC coated polyester fabric that **defy's deterioration**.
- SuperScreen™ is compounded with a **biocide** that **resists bacteria**, fungus and mildew growth. This means that it will retain it's color, longevity and filtering characteristics
- SuperScreen™ is Available in Two Mesh Sizes
 1. The 17 x 14 mesh is the standard size for screens. It blocks out 30% of harmful UV rays of the sun.
 2. The 17 x 20 mesh blocks out 50% of the harmful UV rays of the sun.
- The fine smaller mesh size is superior in **protecting** against mosquitoes and small insects.
- SuperScreen™ is .022 gauge, has the **flexibility** of fiberglass screen fabric, yet the **durability** of the thickest pet screens on the market.
- SuperScreen™ is being used on homes adjacent to golf courses to **protect** from errant golf balls.

SuperScreen™ Comes in Two Mesh Sizes

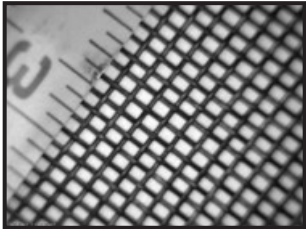

The 17 x 14 mesh size offers the clearest viewing when sitting on a porch or balcony and looking out at the landscape, while still protecting you from flies, mosquitoes and other small insects. The 17 x 14 mesh blocks out 30% of the harmful UV rays and lets the good rays in that lets your plants flourish.

Black 17 x 14 Mesh	
Size 100' Roll	Part #
36"	69-151
48"	69-152
60"	69-153
72"	69-154
84"	69-156
96"	69-157
108"	69-159
120"	69-160

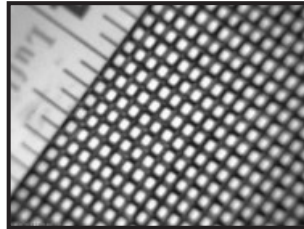

The 17 x 20 mesh is a little smaller so it keeps out some of the smaller insects. Yet, it allows you to view your landscape with little to no distortion. The 17 x 20 mesh blocks out 50% of the harmful UV rays and still lets in the good rays to help your plants grow.

Black 17 x 20 Mesh	
Size 100' Roll	Part #
36"	69-162
48"	69-163
60"	69-164
72"	69-165
84"	69-167
96"	69-168
108"	69-170
120"	69-171

Reduce your exposure to airborne allergens with Pollen Guard Screen Cloth.

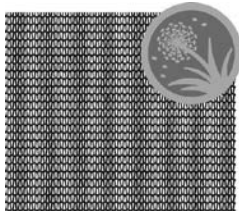

Charcoal Pollen Guard Screen Cloth

Pollen Guard screen is specially designed to block up to 50% more particles than standard fiberglass insect screen. Pollen Guard screen is a unique polyester knit fabric that creates a barrier for most pollen, dust, and other allergen particles making it ideal for allergy sufferers. The particles become trapped by the special knit design keeping your air inside clean.

Pollen Guard screen allows air to flow in while keeping dust and pollen particles out. No need to keep the windows closed during allergy season, now you can keep your windows open and enjoy the breeze!

Pollen Guard screen is easy to install and is available in 36" x 100' and 48" x 100' rolls. We recommend using .140" spline for the best fit in a standard frame channel.

Part #	Size
69-132	36" x 100'
69-133	48" x 100'

Bronze Screening

(18 x 14 Mesh .011" Diameter)

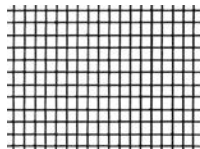

Bronze

Our heavy-duty solid bronze insect screening is designed for fabrication of high quality window screens and screen doors. It is woven of .011" solid bronze wire into an 18 X 14 mesh.

Width	Bright Bronze Part #
24" x 100'	69-29BR
30" x 100'	69-47BR
36" x 100'	69-65BR
48" x 100'	69-77BR

SCREEN WIRE & SCREEN CLOTH



Charcoal

Pool, Porch & Patio Fiberglass Screen Cloth

(18 x 14 Mesh .013" Diameter)

Pool, Porch & Patio Screening is for use in pool, patio and sun room enclosures. It offers superior strength and durability.

Part #	Size
69-P61	36" x 100'
69-P62	42" x 100'
69-P73	48" x 100'
69-P74	54" x 100'
69-P79	60" x 100'
69-P80	66" x 100'

Part #	Size
69-P85	72" x 100'
69-P86	78" x 100'
69-P92	84" x 100'
69-P93	90" x 100'
69-P96	96" x 100'
69-P97	102" x 100'
69-P108	108" x 100'



P3: POOL & PATIO PLUS

Increased strength & protection without compromising visibility. Backed by a 7 year warranty. Hybrid construction that is part polyester and part fiberglass. More openness than heavy duty polyester products, allowing more light, airflow, and reducing wind.

Combine Sizes for Quantity Discount.
(18 x 14 mesh)

Part #	Size	Color
69P3-36	36" x 100'	Charcoal
69P3-48	48" x 100'	Charcoal
69P3-60	60" x 100'	Charcoal
69P3-72	72" x 100'	Charcoal

Available in 100' contractor rolls up to 108".



P4: POOL & PATIO PREMIUM POLYESTER

For the strongest, most durable pool cage screen. Backed by a 10 year warranty. Heavy duty polyester construction provides durability and longevity. Primarily used in Florida pool enclosure market. Darker color adds to curb appeal. Produced in one piece. Consistent in quality with no defects.

Combine Sizes for Quantity Discount.
(17 x 14 mesh)

Part #	Size	Color
69P4-151	36" x 100'	Charcoal
69P4-152	48" x 100'	Charcoal
69P4-153	60" x 100'	Charcoal
69P4-154	72" x 100'	Charcoal
69P4-156	84" x 100'	Charcoal
69P4-159	96" x 100'	Charcoal
69P4-160	108" x 100'	Charcoal

(17 x 20 mesh)

Part #	Size	Color
69P4-162	36" x 100'	Charcoal
69P4-163	48" x 100'	Charcoal
69P4-164	60" x 100'	Charcoal
69P4-165	72" x 100'	Charcoal
69P4-167	84" x 100'	Charcoal
69P4-168	96" x 100'	Charcoal
69P4-170	108" x 100'	Charcoal
69P4-171	120" x 100'	Charcoal

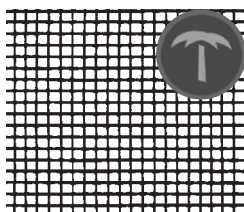

Features and Benefits

Laminated to keep out grass clippings and bugs
Provides increased privacy

Florida Glass Screen

(18 x 14 mesh .013" diameter)

Part #	Size	Color
69-P1	36" x 25'	Charcoal

Florida Screen is a fiberglass screen that is laminated for use on the bottom part of an enclosure. It is normally used from the chair rail to pool and patio deck.



Charcoal

Viper - Vision perfect

(18 x 18 mesh .009" diameter)

Viper Screen provides better visibility than our standard fiberglass screen by using an enhanced tighter weave and finer mesh woven from smaller refined yarns. Viper not only offers a maximized view, but also provides better airflow and more light.

Features and benefits of Viper include:

- 20% thinner yarn for enhanced visibility, greater light transmission and airflow
- Smaller opening than the standard screen provides better insect protection
- Smaller yarns increases appearance of screen and curb appeal

Part #	Size
69-V7	18" x 100'
69-V25	24" x 100'
69-V37	28" x 100'
69-V43	30" x 100'
69-V49	32" x 100'
69-V55	34" x 100'
69-V61	36" x 100'
69-V73	48" x 100'
69-V79	60" x 100'



Charcoal

No-See-Um Fiberglass Screen Cloth

(20 x 20 Mesh .013" Diameter)

Finer mesh screening to protect against no-see-ums, gnats, sand flies, and other tiny, irritating insects common in low marshy areas.

Width	Charcoal Part #
36" x 100'	69-61NSM
48" x 100'	69-73NSM
60" x 100'	69-79NSM

SCREEN SPLINE

Gray & Black Vinyl Hollow Ribbed Spline

Replacement spline for metal and fiberglass screening available in 100 ft., 250 ft., 500 ft. and 1,000 ft. spools.



Sold by Spools

250 Foot Spools

Part # Gray	Part # Black	Trade Size	Decimal Size
66-2	66-2B	1/8"	.120
66-6	66-6B	9/64"	.140
66-10	66-10B	11/64"	.165
66-14	66-14B	3/16"	.187
66-18	66-18B	15/64"	.230
66-22	66-22B	1/4"	.250



1/8" (.120)



9/64" (.140)



11/64" (.165)



3/16" (.187)



15/64" (.230)



1/4" (.250)

Gray & Black Vinyl Hollow Ribbed Spline (Continued)

500 Foot Spools

Part # Gray	Part # Black	Trade Size	Decimal Size
66-3	66-3B	1/8"	.120
66-7	66-7B	9/64"	.140
66-11	66-11B	11/64"	.165
66-15	66-15B	3/16"	.187
66-19	66-19B	15/64"	.230
66-23	66-23B	1/4"	.250

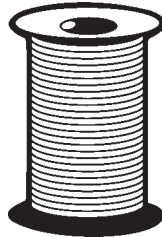

Sold by Spools

1000 Foot Spools

Part # Gray	Part # Black	Trade Size	Decimal Size
66-4	66-4B	1/8"	.120
66-8	66-8B	9/64"	.140
66-12	66-12B	11/64"	.165
66-16	66-16B	3/16"	.187
66-104	66-104B	7/32"	.220
66-20	66-20B	15/64"	.230



1/8" (.120)



9/64" (.140)



11/64" (.165)



3/16" (.187)



15/64" (.230)



1/4" (.250)

Gray & Black Vinyl Hollow Round Spline

Replacement spline for metal and fiberglass screening. Available in 200 ft., 750 ft., and 1,000 ft. spools.

200 Foot Spools

Part # Gray	Part # Black	Trade Size	Decimal Size
66-64	66-65	1/8"	.125
66-68	66-69	9/64"	.140
66-72	66-73	5/32"	.156
-	66-77	11/64"	.172
66-80	66-81	13/64"	.203

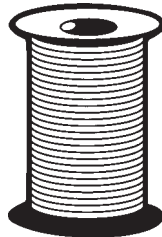

Sold by Spools

1000 Foot Spools

Part # Gray	Part # Black	Trade Size	Decimal Size
66-27	66-27B	7/32"	.220
66-62	66-63	1/8"	.125
66-66	66-67	9/64"	.140
66-70	66-71	5/32"	.156
-	66-75	11/64"	.172
-	66-79	13/64"	.203
-	66-87	1/4"	.250



1/8" (.125)



9/64" (.140)



5/32" (.156)



11/64" (.172)



13/64" (.203)



15/64" (.234)



1/4" (.250)

Solid Black Foam Spline

Replacement spline for metal and fiberglass screening. Available in 500 ft., 1,000 ft., 1,500 ft. and 3,000 ft. spools.

500 Foot Spools

Part # Black	Decimal Size
66-40	.135
66-42	.140
66-44	.150
66-46	.155
66-48	.170
66-50	.235
66-52	.250

1000 Foot Spools

Part # Black	Decimal Size
66-41	.135
66-43	.140
66-45	.150
66-47	.155
66-49	.170
66-51	.235
66-53	.250
66-60M	.270

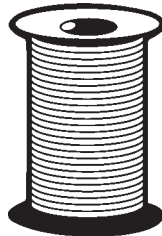

Sold by Spools

- Solid Black Foam Spline produced with only 100% virgin materials.
- User friendly - helps reduce operator fatigue.
- The softness of solid black foam spline allows it to be easily inserted in channels and allows easy cornering.
- Helps reduce customers' inventory.
- One size will work for several different screen channels.

1500 Foot Spools

Part # Black	Decimal Size
66-57	.235
66-34	.250

3000 Foot Spools

Part # Black	Decimal Size
66-54	.135
66-30	.140
66-55	.150
66-56	.155
66-31*	.170

(* 2700 Foot spools only)



.135



.140



.150



.155



.170



.235



.250



.270

SCREEN DOOR SPLINE

VINYL ASTRAGAL

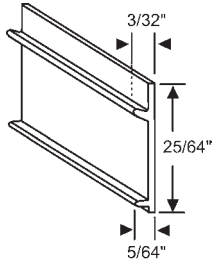

66-61X

Vinyl Screen Spline. Black
Sold in 100' Rolls
FOREVER DOOR

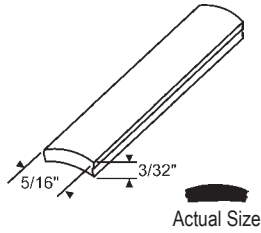

Actual Size

Part #	Length
16-240B	100 ft. Roll
16-240BM	1000 ft. Roll

Flat Spline. Black

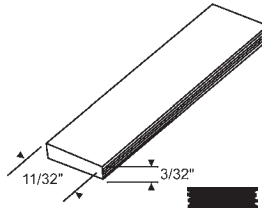

Actual Size

Part #	Length
16-239	100 ft. Roll
16-239X	750 ft. Roll

Flat Spline. Black
PEACHTREE

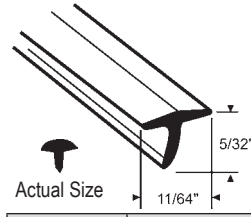

Actual Size

Part #	Length
16-241	100 ft. Roll
16-241M	1000 ft. Roll

Black Spline made of polyethylene.
Used with fiberglass cloth for patio
screen doors.

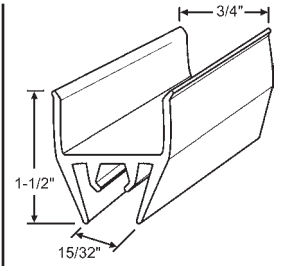

16-437-96

Black Vinyl
96" Lengths.
Minimum order 5" Lengths

TENSION SPRINGS

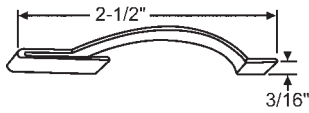

Part #	Description
900-17211	Steel
900-17211SS	Stainless Steel

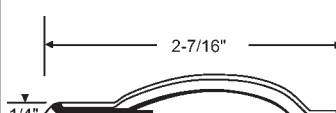

90-498



16-158

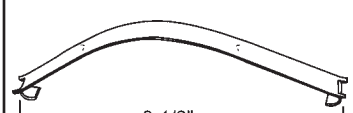

90-705RS

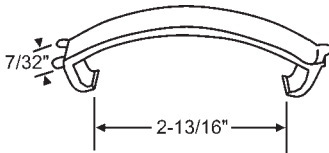

900-17011

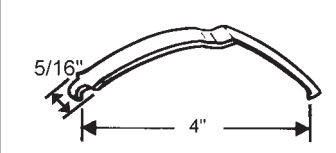

90-98

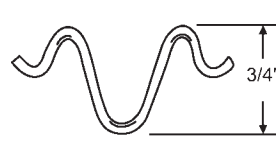

900-12221
Ram Horn Spring

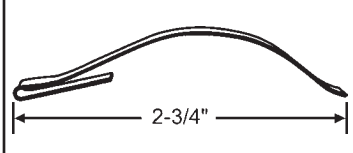

900-18037
3/16" Wide

WIRE LOOP LATCHES

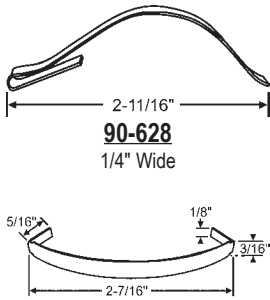

90-628
1/4" Wide

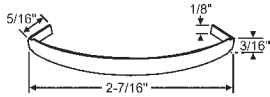

16-367

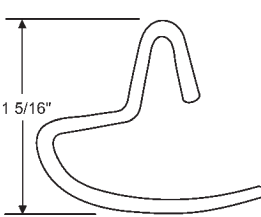

90-127

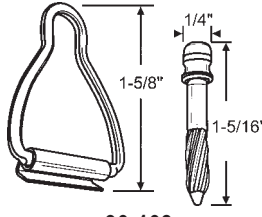

90-103

Wire Loop Latch Set
90-103X Loop Only
20-019 Screw Only

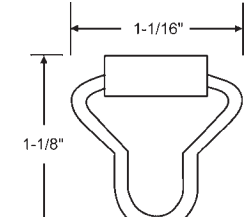

90-104

Small Loop Latch. Used with Ball
Head Screw 20-019

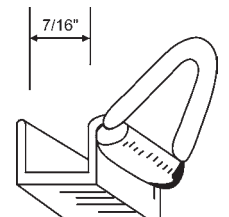

900-9851

Slip-On Type
Aluminum Finish

ALUMINUM STRETCH CLIPS

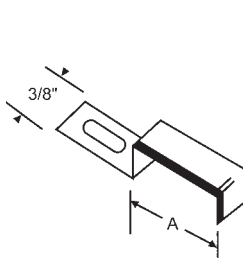

Part #	"A"	"B"	Part #	"A"	"B"
90-1096	5/8"	1/8"	90-58	3/4"	5/16"
90-60	5/8"	1/4"	90-58BZ	3/4"	5/16"
90-68	5/8"	5/16"	90-58W	3/4"	5/16"
90-65	11/16"	1/4"	90-59	3/4"	3/8"
90-1095	11/16"	5/16"	90-62	13/16"	9/32"
90-1097	11/16"	17/64"	90-55	7/8"	5/16"
90-72	11/16"	9/32"			
90-61	11/16"	3/8"			

Aluminum

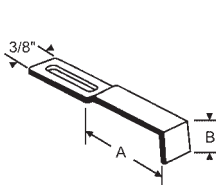

Part #	"A"	"B"
90-67	11/16"	11/32"
90-64	7/8"	5/16"

Aluminum

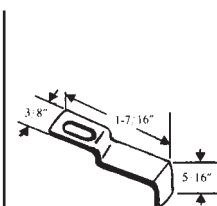

90-69
Aluminum

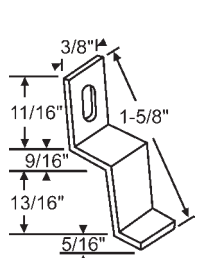

90-1068
Aluminum

SCREEN HARDWARE

ALUMINUM STRETCH CLIPS

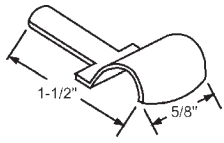

90-850
OLD MIAMI

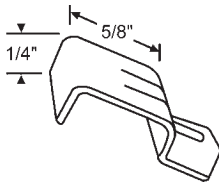

33-101N
Jalousie Screen Clip
KELLER

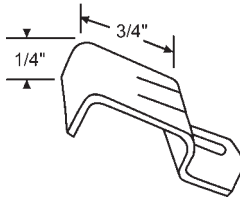

90-848
Screen Clip
AIR CONTROL

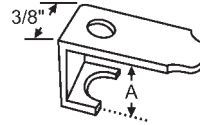

Part #	"A"
90-30	3/16"
90-31	1/4"
90-32	3/8"
90-33	7/16"
90-34	5/16"

Aluminum

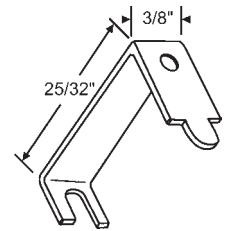

90-27SS
Stainless Steel

ZEE CLIPS

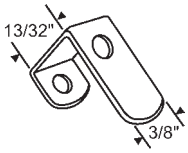

90-1098

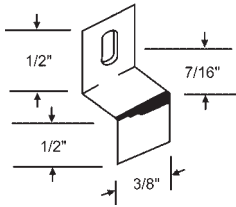

Part #	Description
90-52	Stainless Steel

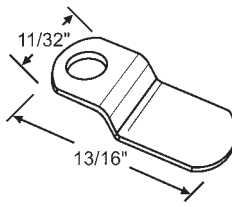

90-1009
1/8" Offset. Aluminum

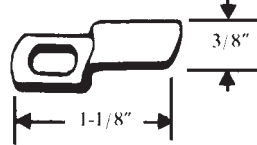

Part #	Offset
90-47	3/16"
90-49	5/16"
90-50	3/8"

Aluminum

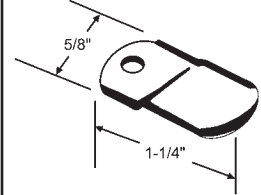

90-46
1/16" Offset
Aluminum

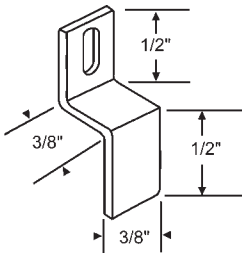

90-724
Stainless Steel

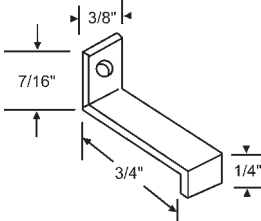

90-44
Aluminum

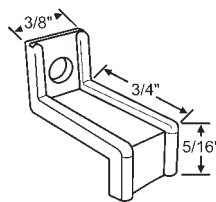

Part #	Color
90-907B	Black
90-907W	White

SECURITY

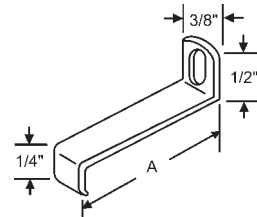

Part #	"A"
90-40	1"
90-41	1-1/8"
90-1209	1-1/4"
90-42	1-1/2"
90-43	1-5/8"
900-7017*	1-3/4"

Aluminum

*Large minimum required

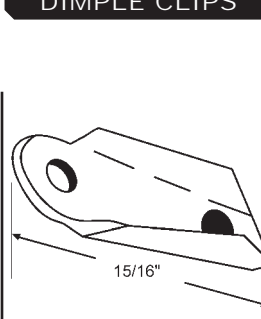

Part #	Hole Size	Dimple Size
90-73	3/16"	Small
90-80	5/32"	Small

Aluminum

WING CLIP

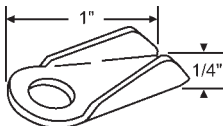

90-1094
9/32" Dia. Hole.
Aluminum

FLAT NYLON WING CLIPS

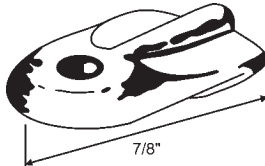

Part #	Color
90-77	White
90-77B	Black
90-77A	Almond
90-77C	Clear

Nylon - 1/8" Hole

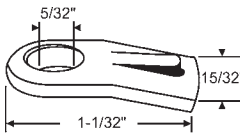

Part #	Color
90-552	Clear
90-552W	White

3/32" Offset

CLIP



90-847
YALE OGRON

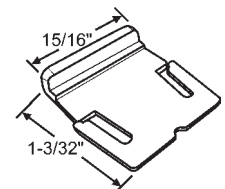

90-1157W
White Nylon
SILVER LINE

PLASTIC SWIVEL CLIPS

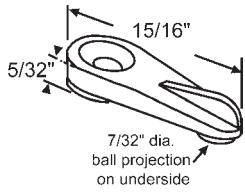

Part #	Color
900-1497	Natural

Screen Clip Flush

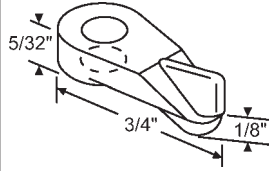

Part #	Color
900-1426	White
900-1426B	Black

5/32" Hole
SEASONALL

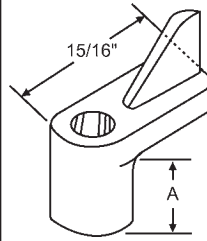

Part #	"A"	Hole Size	Color
90-834	Flush	3/16"	Natural
90-834BL	Flush	3/16"	Black
90-78	1/16"	3/16"	Natural
90-78B	1/16"	3/16"	Black
900-1457	1/16"	3/16"	Clear
90-381	3/16"	3/16"	White
90-381NAT	3/16"	3/16"	Natural
90-381GY	3/16"	3/16"	Grey
90-837	1/4"	3/16"	Natural
90-332	5/16"	3/16"	White
90-332B	5/16"	3/16"	Black
90-379	3/8"	3/16"	Natural
90-379BL	3/8"	3/16"	Black
90-379G	3/8"	3/16"	Gray
90-380	7/16"	3/16"	Natural
90-380WH	7/16"	3/16"	White

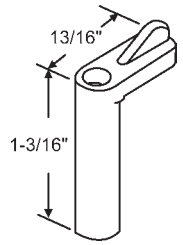

Part #	Color
90-727WX	White
90-727BX	Black

Casement Clip.
Uses Part #20-427 Screw.

DIE CAST CLIPS

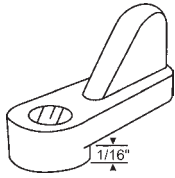

Part #	Color
90-78W-HT	White
90-78B-HT	Black

High Thumb Tab
SILVER LINE

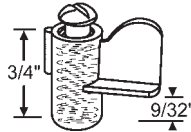

90-101P
Clip Assembly. Natural

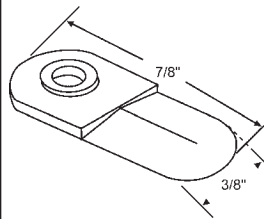

900-7113
1/32" Offset

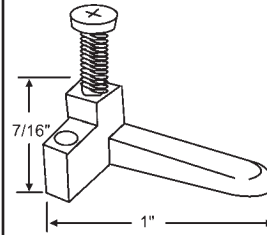

90-99
Washer & Screw Included

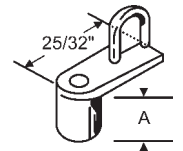

Part #	"A"	Hole Size
90-158	Flush	3/16"
90-81	3/16"	3/16"
90-82	1/4"	3/16"
90-83	5/16"	3/16"
90-84	3/8"	3/16"
90-85	7/16"	3/16"

MUNTIN CLIPS

SCREEN CLIPS

RETAINER CLIP

PIVOT POST

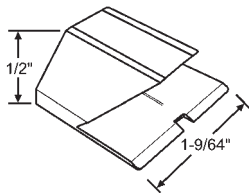

Part #	Color
90-995W	White
90-995BZ	Bronze

Nylon
NU-AIR

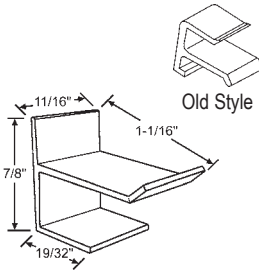

900-5687
Top Screen Clip, Black
BELKNAP

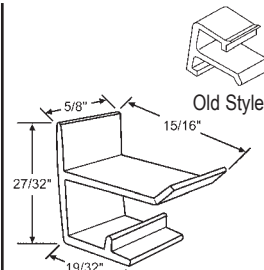

900-5688
Bottom Screen Clip, Black

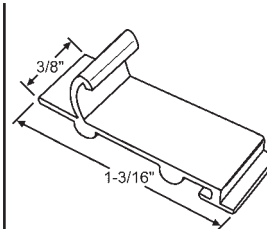

90-839
White Nylon
Screen Spring Retainer Clip
PATRIOT

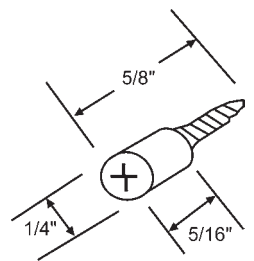

900-9351
ACORN

HANGER

POINTER LATCH

POP RIVET

LATCHES

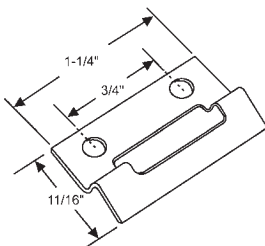

900-7098
Female Hanger
JIM WALTERS

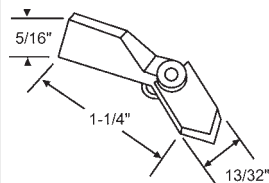

Part #	Color
90-124	White
90-124B	Black

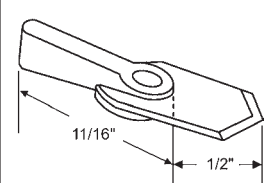

Part #	Color
900-9823	Black
900-9823W	White
900-9823N	Natural

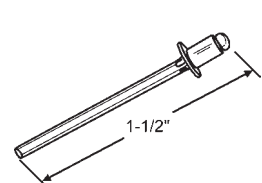

20-021

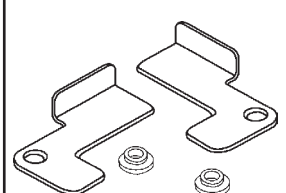

90-384A
Screen Latch Set
LH Only: 90-384. RH Only: 90-385
Bushing Only: 900-7231

SCREEN HARDWARE

LATCHES

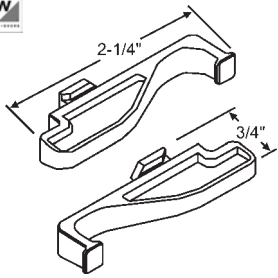

Part #	Color
750-0873293	Stone
750-0873292	White

Screen Latch Set

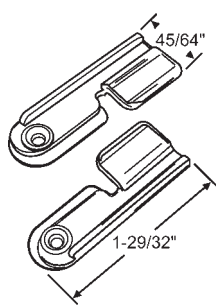

900-21432
Clear Plastic
PEACHTREE

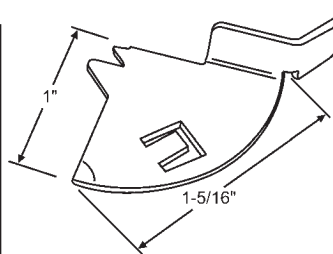

Part #	Hand
90-383	Shown
90-382	Opposite
90-382A	LH/RH Set

Knife Latch. Mill

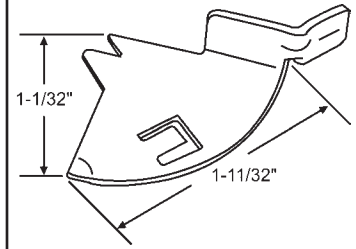

750-2962208
Pair

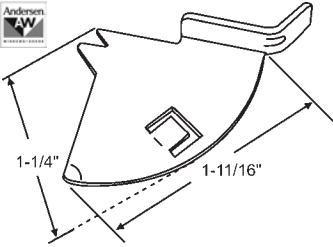

750-2962214
Pair

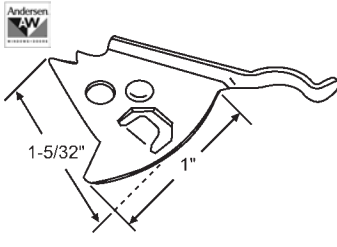

750-2962218
Pair

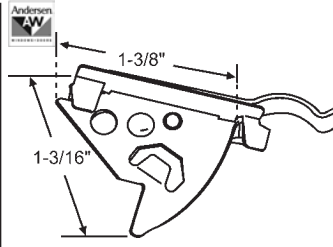

750-2962202
Pair. Stone Finish

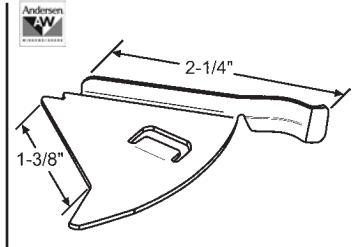

750-2962216
Pair

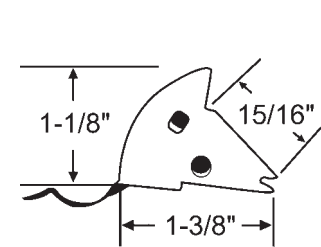

90-506
Pair

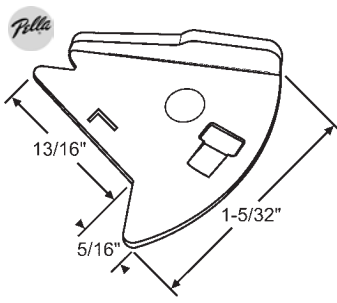

90-883A
Sold in Sets Only (LH Shown)

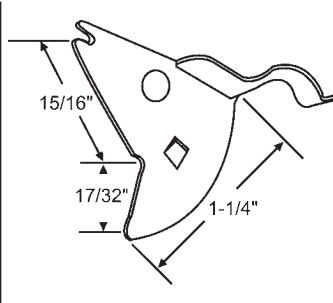

90-515
Pair (LH/RH)
Stainless Steel

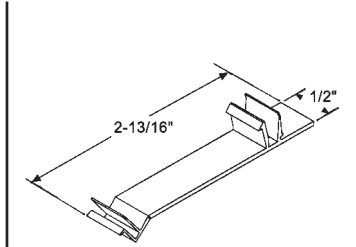

900-18585
Black Vinyl Screen Latch
MALTA

SLIDE LATCHES

CROSS BRACE INSERT

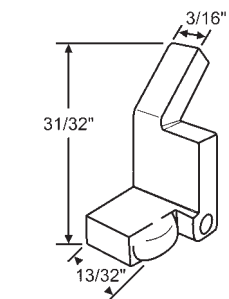

Part #	Color	Screw
900-9352	White	No
900-9352B	Black	No
900-9352A	White	Yes
900-9352BA	Black	Yes

Nylon Screen Latch
ACORN

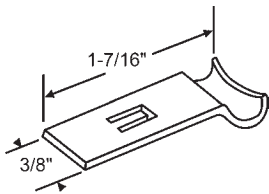

90-90
Aluminum

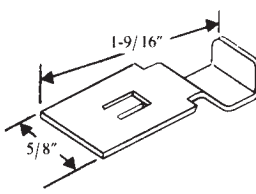

90-91
Aluminum

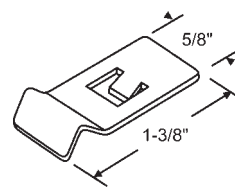

Part #	Color
90-715	Bronze
90-715W	White
90-715M	Mill

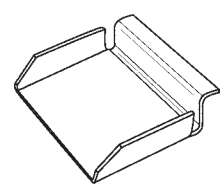

90-313
Fits 1/4" x 3/4" Cross Brace

FIXED PINS

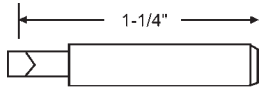

90-698
5/32" x 1-1/4"
Aluminum

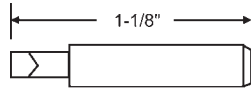

Part #	Description
900-21792	5/32" Plunger
900-21747	7/32" Plunger

SCREEN CORNERS

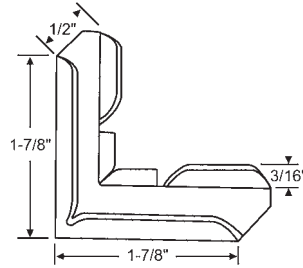

Part #	Color
90-125	Mill
90-125B	Black

Metal

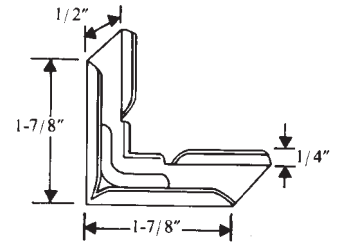

90-106
Metal

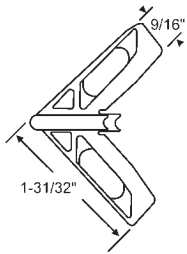

Part #	Color
90-865TN	Tan
90-865	White
90-865BZ	Bronze

Plastic

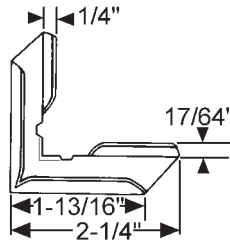

90-487
Metal

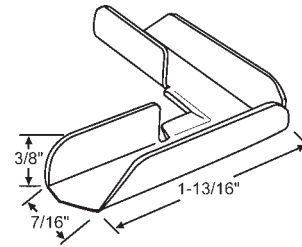

90-350
Beige. Aluminum

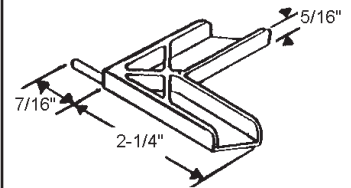

900-13515
Black
ACORN

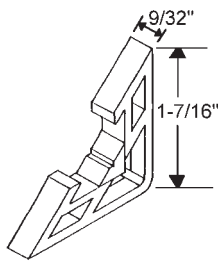

900-10679B
Black
SEASONALL

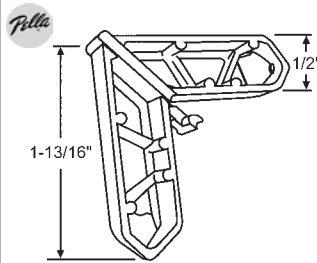

900-16634
Champagne

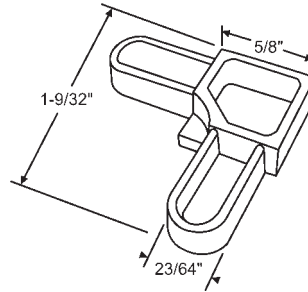

Part #	Color
900-21783W	White
900-21783GY	Gray
900-21783B	Black

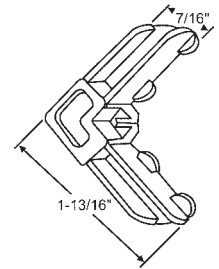

Part #	Color
90-347	Gray
90-348	White
90-349	Dark Bronze

Plastic
FLORIDA SCREEN

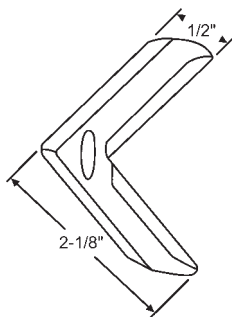

90-352
Metal

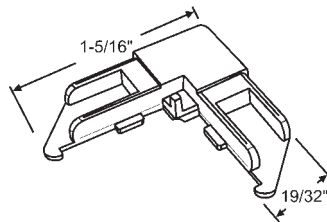

Part #	Color
90-436	Gray
90-436AD	Almond
90-437B	Black
90-437	White
90-438	Dark Bronze

Plastic

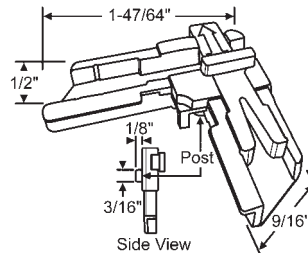

Part #	Color
90-437PS	White
90-437PSB	Black

Locking Screen Corner with Post.
Slider on both is Black

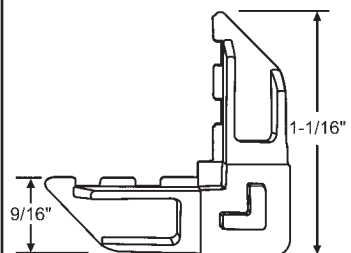

90-437S
With Stop Leg. White

SCREEN CORNERS

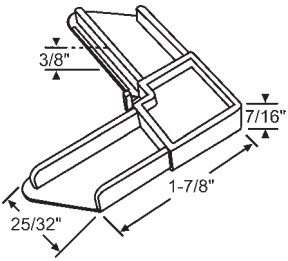

Part #	Color
900-19936	Beige
900-19936WH	White

Plastic. Fits Kolbe

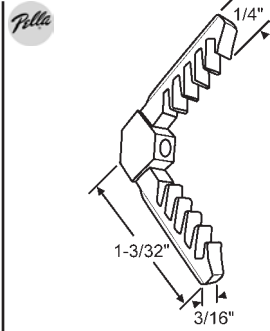

90-931W
White

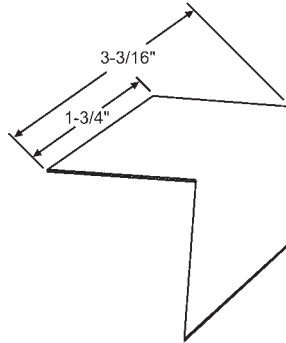

90-1080
1/16" Thick
TRACO

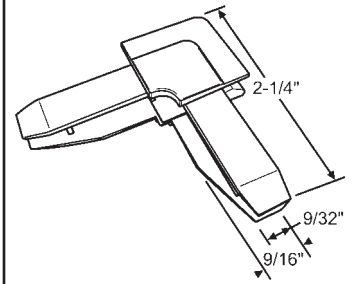

Part #	Color
90-884	White

Set (LH & RH)

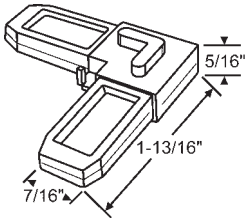

Part #	Color
90M-560	Gray
90M-560AD	Almond
90M-560BE	Beige
90M-560BZ	Bronze
90M-560W	White

Outside Plastic Corner with Offset

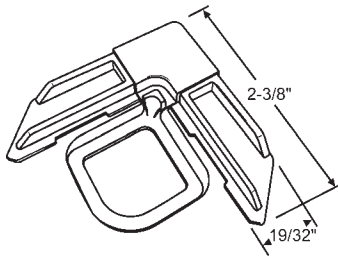

Part #	Color
90-955IV	Ivory
90-955SND	Sandstone

Corner with Pull Tab
BAYFORM

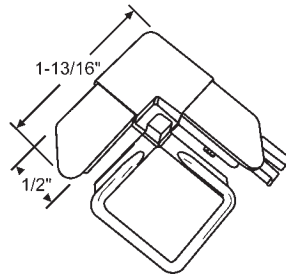

90-1114WA
Screen Corner with Slide and Lift Tab.
Reversible
SILVER LINE

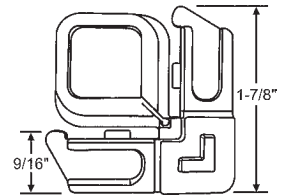

90-437LS
Pull Tab Outside Corner Key with Stop.
White

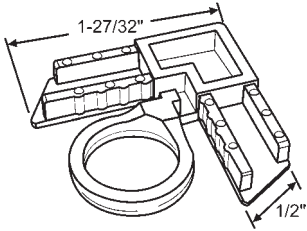

90-1167WL
White Screen Corner With Lift
PGT

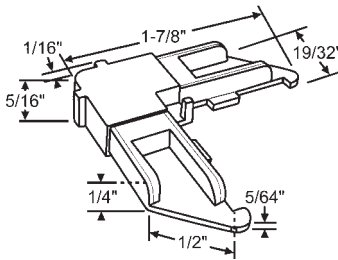

90-437D
Plastic Corner with Dimples

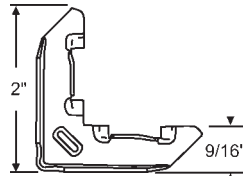

900-13137

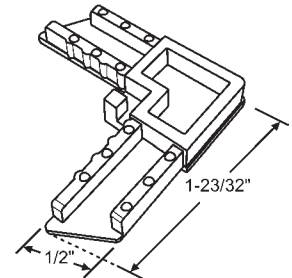

90-1167W
White
PGT

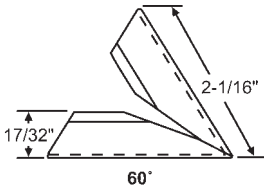

90-978
60° Aluminum Corner for 3/8" x 3/4" Screen Frame
BAYFORM

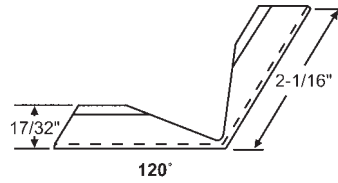

90-979
120° Aluminum Corner for 3/8" x 3/4" Screen Frame
BAYFORM

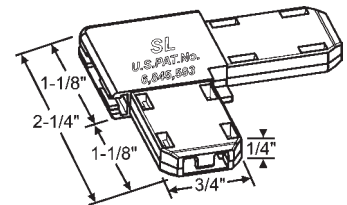

90-1128LHW
Plastic Screen Corner Without Stop. White
SILVER LINE

SCREEN CORNERS

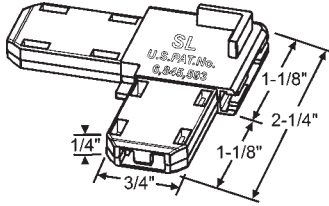

90-1128RHW
Plastic Screen Corner With Stop. White
SILVER LINE

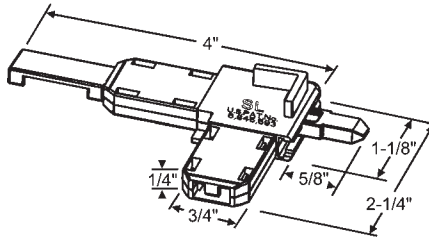

90-1067RHW
Plastic Screen Corner with Stop & Latch. White
SILVER LINE

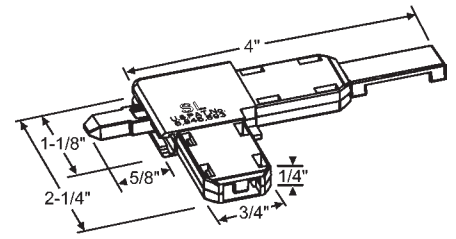

90-1067LHW
Plastic Screen Corner without Stop & Latch. White
SILVER LINE

GRILLE FASTENER

LIFTS & PULL TABS

Lifts Packaged 25 Per Bag

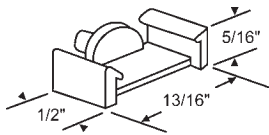

900-1451C
Clear

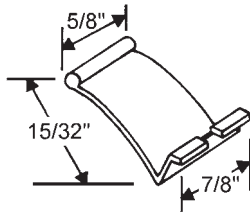

Part #	Color
90-116	Natural
90-116B	Black

Vinyl

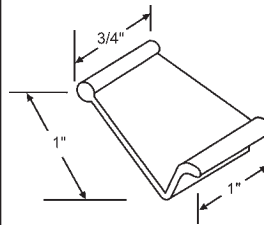

Part #	Color
90-117	Natural
90-117B	Black

Nylon

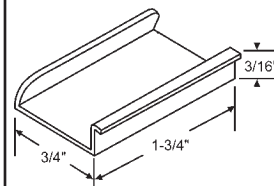

Part #	Color
90-118	Mill
90-118WH	White
90-118BZ	Bronze

Aluminum

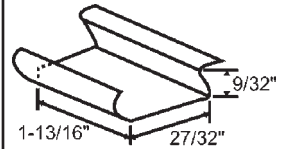

Part #	Color
90-378	Mill

Aluminum

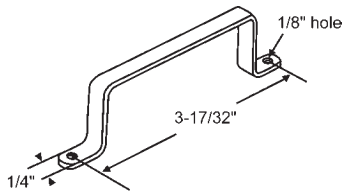

900-390
Flat Aluminum Handle, Mill

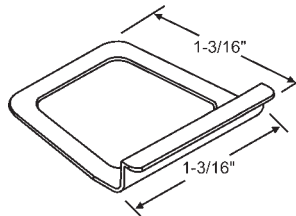

Part #	Color
900-14950	Natural
900-14950B	Black
900-14950W	White

Nylon

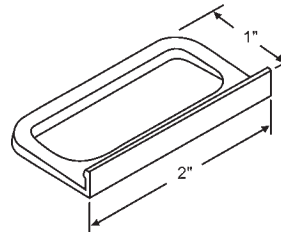

Part #	Color
900-12883	Natural
900-12883B	Black

Nylon

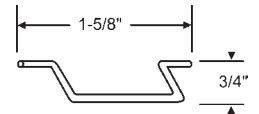

900-377
Wire Lift

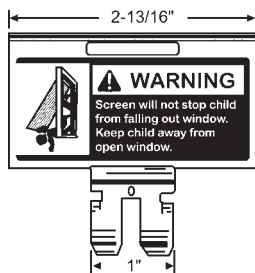

750-163110
Screen Finger Pull

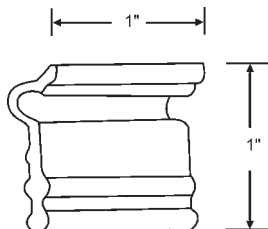

Part #	Color
90-633	Black rubber flexible
90-634	Black vinyl rigid
90-634G	Gray vinyl rigid

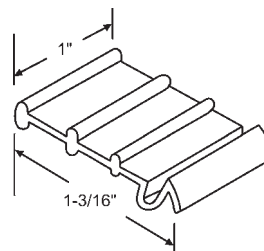

900-129
Plastic, Black

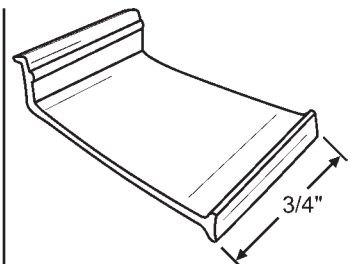

Part #	Color
90-785	White
90-376	Black

Vinyl

SPRING PLUNGERS

In Order by Tip Outside Diameter

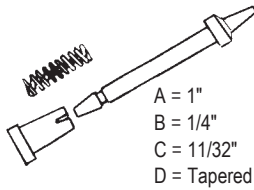
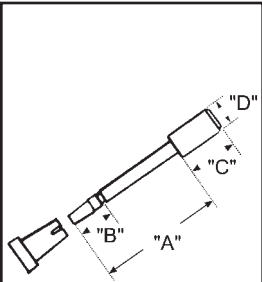

90-15
Snap-On Plastic Knob, White

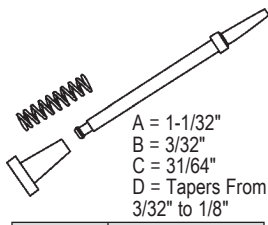

Part #	Knob
90-532	White
90-532B	Black

Blunt Tip Plunger Assembly
Plastic Knob, Black

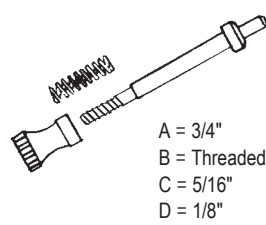

90-22
Metal Screw-On Knob

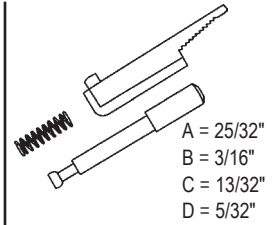

Part #	Knob	Hand
90-635FT	White	RH
90-635FTL	White	LH

Flip Type

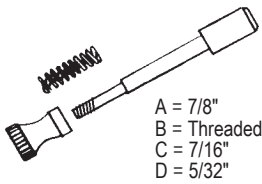

Part #	Spring Length
90-21	1/2"
90-21MOD	7/8"
90-21MOD-SS	7/8" Stainless Steel

Screw-On Metal Knob
Metal Plunger
PGT

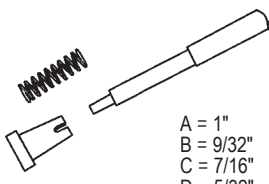

Part #	Knob
90-136	White
90-136B	Black

Snap-On Plastic Knob,
Metal Plunger

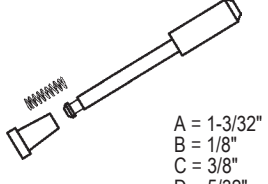

Part #	Knob
90-635	White
90-635B	Black

Metal Plunger

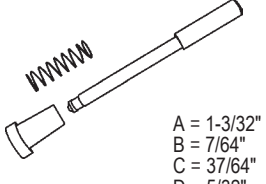

Part #	Knob
90-513	White
90-513B	Black

For Use with 1" Frame

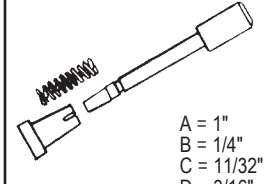

90-23
Snap-On Knob, White Plastic
Metal Plunger

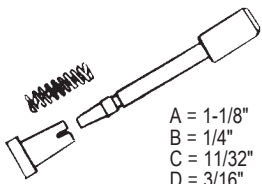

90-20
Snap-On Knob, White Plastic
Metal Plunger

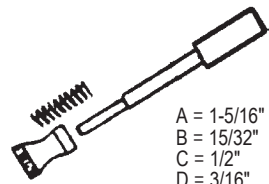

900-7070
Stake-On Knob
Metal Knob and Plunger

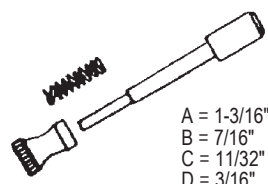

90-322
Stake-On Knob
Metal Knob and Plunger

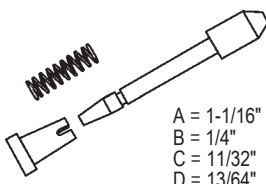

90-12
Snap-On Knob, White
Plastic

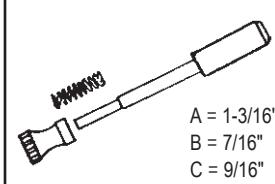

90-327
Stake-On Knob
Metal Knob and Plunger

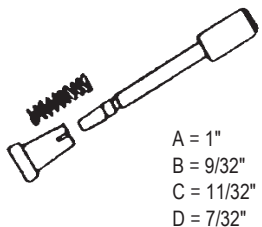

90-312
Snap-On Knob, White Plastic
Metal Plunger

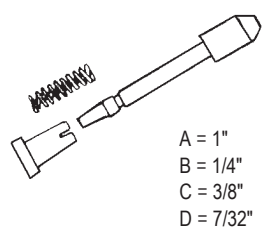

90-14
Snap-On Plastic Knob, White

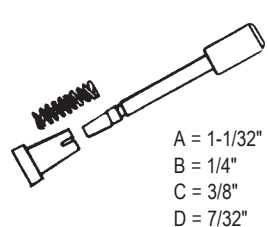

90-11
Snap-On Plastic Knob, Black

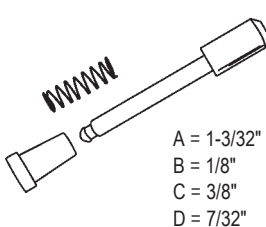

Part #	Knob
900-9850	White
900-9850B	Black

Snap-On Plastic Knob, Metal
Plunger

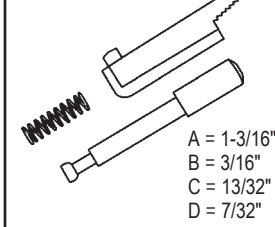

Part #	Knob	Hand
900-9850FT	White	RH
900-9850FTL	White	LH

Flip Type

SPRING PLUNGERS

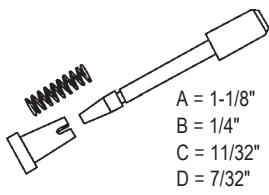

Part #	Knob
90-24	White
90-24B	Black

Snap-On Plastic Knob, Metal Plunger

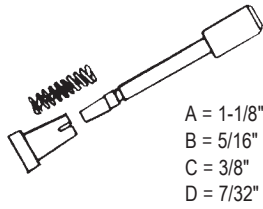

90-13
Snap-On Plastic Knob, White Plastic Plunger

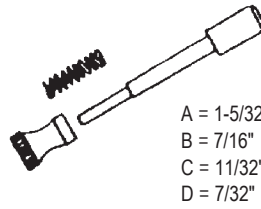

90-375
Stake-On Metal Knob Metal Plunger

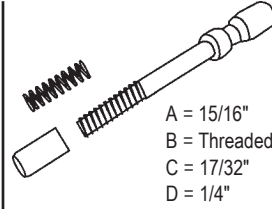

90-371
Metal Screw-On Knob Metal Plunger

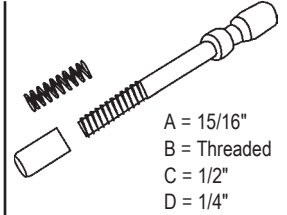

90-370
Metal Screw-On Knob Metal Plunger

FRICTION HANGERS

LATCH SET

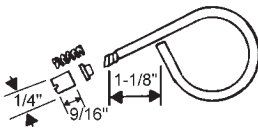

90-514
P-Type Plunger Assembly for 1" Frame

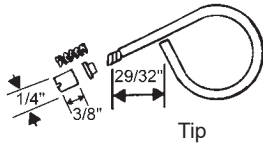

90-25



Part #	Frame Thickness	Color
90-120	3/8"	Aluminum
90-389	7/16"	Aluminum
90-389W	7/16"	White
90-389BZ	7/16"	Bronze

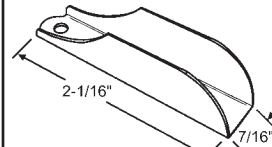

90-611
White

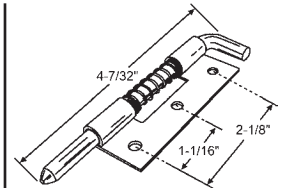

90-736
Low Profile Latch Set Sold in Sets Only.

SCREEN LATCH HANDLE & FINGER

GUIDE INSERT

WARNING LABEL

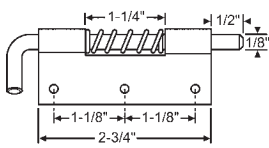

90-1108
Sold in Sets Only. RH Shown

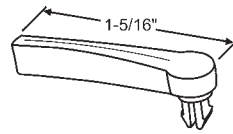

90-889W
Latch Handle, White
SILVER LINE

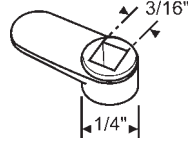

90-888W
Latch Finger, White
SILVER LINE

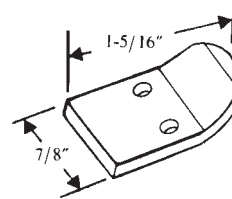

90-96
Nylon

WARNING
DO NOT USE SCREENS FOR SECURITY OR TO RESTRICT EXITING FROM BUILDINGS. KEEP CHILDREN AWAY FROM OPEN SCREENS.
Screen hardware is intended for decorative purposes only and is not intended to provide security or provide for the retention of objects or persons within the structure. This screen was not used in a way that led to the situation.

500-287
1000 Per Roll. 1/2" x 2-3/4"

PET SCREEN DOOR

SCREEN SHIELD

AUTOMATIC SCREEN DOOR CLOSER

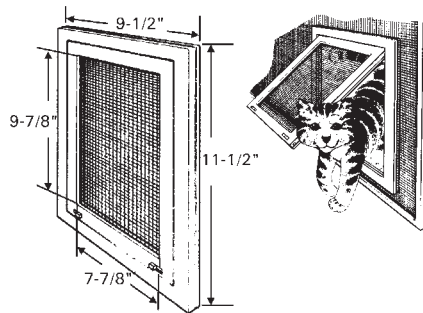

990-2
Pet Screen
Bronze

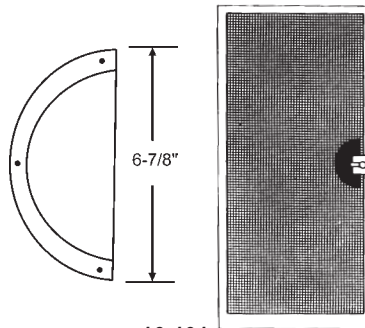

16-191
Screen Shield. Protects Screening Around Door Handle. Snaps Together. Durable Plastic

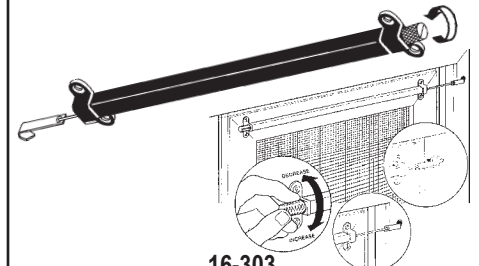

16-303
Screen Door Closer with Screws. Black. Fits Patio Screen Doors 36" and Larger. Simple Installation Takes Only Minutes. Block And Tackle Design Provides Smooth Operation.

SCREEN HARDWARE

CUSTOM MADE EXTRUDED ALUMINUM WICKET & HOPPER SCREENS ORDER FORM

Customer Name: _____ Account Number _____

Contact: _____ Phone Number _____

Part#	Quantity	Cost
990W-999		

Signature _____ Date _____

For Commercial & Institutional Application

1. Select Frame Color

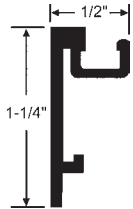

- Mill
- Bronze
- White

90-509M

Frame: .050
Gauge, 6063 T5
Aluminum Alloy

2. Select Screen Wire

- Bright Aluminum
- Charcoal Aluminum
- Gray Fiberglass
- Charcoal Fiberglass

3. Select Type



Single Wicket Screen

Hinged Sliding

Wicket Size _____ W x _____ H

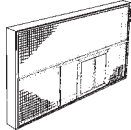

Center slide wickets should be no more than 1/3 width of screen



Hopper Screen

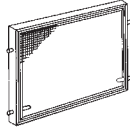

Double Wicket Screen

Hinged Sliding

Wicket Size _____ W x _____ H

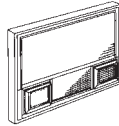

Double side wickets should be no more than 1/4 width of screen



Full Height Hinged Wicket Screen

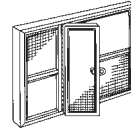

Other

(Specify)

4. Screen Size: _____ W x _____ H

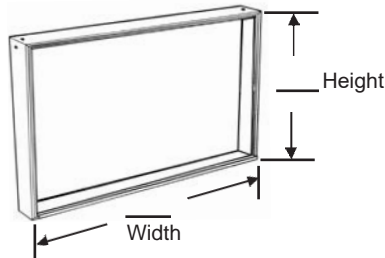

5. Quantity _____

6. Measuring Instructions:

For Hardware to be Installed

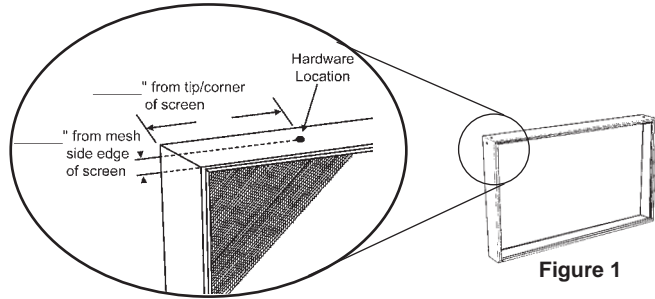

7. Hardware & Hardware Location:

- Hardware to be installed on _____ rail (See Figure 2). Part No. _____
Location: _____ " from tip/corner of screen (See Figure 1)
_____ " in from mesh side edge of screen (See Figure 1)
- Hardware to be installed on _____ rail (See Figure 2). Part No. _____
Location: _____ " from tip/corner of screen (See Figure 1)
_____ " in from mesh side edge of screen (See Figure 1)
- Hardware to be installed on _____ rail (See Figure 2). Part No. _____
Location: _____ " from tip/corner of screen (See Figure 1)
_____ " in from mesh side edge of screen (See Figure 1)
- Hardware to be installed on _____ rail (See Figure 2). Part No. _____
Location: _____ " from tip/corner of screen (See Figure 1)
_____ " in from mesh side edge of screen (See Figure 1)

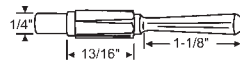

90-100NS

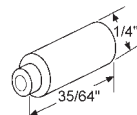

90-551

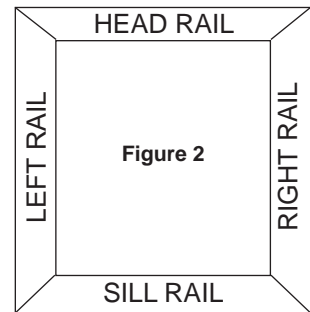

IMPORTANT: Hardware must be located by position. In the spaces above please indicate both height & width AND depth of frame.

Please Call for Pricing and Delivery

CUSTOM MADE EXTRUDED ALUMINUM WICKET SCREENS WITH PLASTIC WICKET ORDER FORM

Customer Name: _____ Account Number _____

Contact: _____ Phone Number _____

Part#	Quantity	Screen Size	Cost
990W-999		" width X " height	

Signature _____ Date _____

EXTRUDED ALUMINUM WICKET SCREENS WITH PLASTIC WICKETS

.050 Gauge

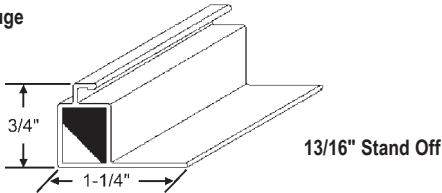

90-1047
(7/16" x 13/16" x 3/4") Offset

Description
with Fiberglass Mesh
with Aluminum Mesh

1. Select Frame Color: Mill Bronze White Beige
2. Select Wicket Color: Black White Gray Dark Bronze (Brown)
3. Select Screen Wire: Bright Aluminum Charcoal Aluminum Gray Fiberglass Charcoal Fiberglass

4. Select Wicket Type: NOTE: Minimum 50 Total Screens

- Single Hinged Wicket Screen Double Hinged Wicket Screen Hopper Screen

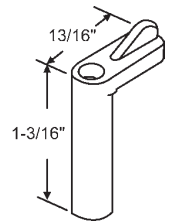
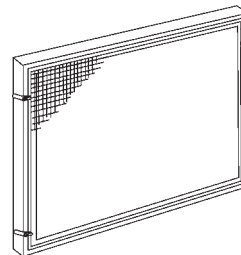
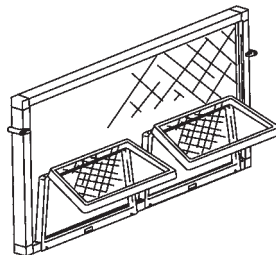
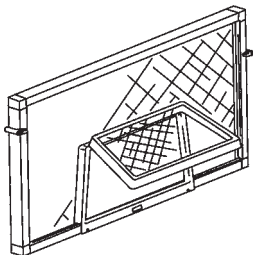

- Notes:
1. Plastic Hinged Wicket is 10-1/8" Wide x 6-1/8" High
 2. All Wicket Screens come Standard with 90-727 Swivel Clips.

Please call for pricing and delivery. A packaging charge will be assessed for each change in screen size.
An additional charge will be assessed for each wicket attached to screen

PLASTIC HINGED WICKETS ONLY

For Casement or Awning Type Window Screens

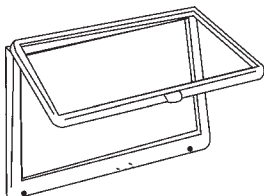

Part #	Color
900-15154	Gray
900-15154W	White
900-15154B	Black
900-15154DB	Dark Bronze (Brown)

- Snap-Type Latch for Sure Closure
- Allows Easy Access to Operator
- Install Your Own Matching Wire
- Pop Rivet to Screen Frame
- Size: 10-1/8" x 6-1/8"
- Very Economical
- Hinges Full 180°

Account# _____ Salesman _____ Page# _____ of _____

Sold To: _____ Ship To: _____

Purchase Order# _____ Date _____ Quoted By _____

STEP 1 Determine style and material of door

- Custom Roll Form Steel
- Multi-Fit Roll Form Aluminum
- Custom Extruded Aluminum

STEP 2 Determine finish

- Clay
- Black
- White
- Bronze
- Almond

STEP 4 Select Screen Wire or Cloth

- Charcoal Fiberglass
- Aluminum
- Pet Screen
- Other _____

STEP 4 Select type of wheel

- Nylon
- Steel
- Stainless Steel

STEP 5 Select Part Number, Quantity & Size

- 991M-999 ENTERPRISE Custom Roll Form Steel - Assembled (121S)
- 998M-999 TITAN Contemporary Custom Extruded Aluminum - Assembled (144EXT)
- 996-999 MOOSE Custom Extruded Aluminum - Assembled (MOOSE)
- 999M-999 GEMINI Custom Extruded Aluminum - Assembled (199EXT)

STEP 6 Measuring Instructions for Custom Screens

Width: Measure from inside the jamb to the center of the first rail of the fixed door.

Height: See Illustration:

STEP 8 Height Measurements

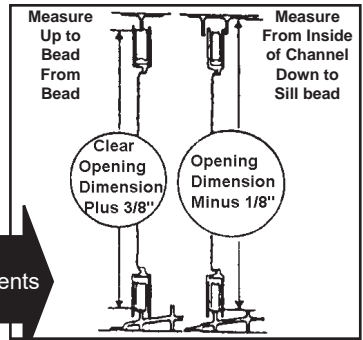

STEEL CUSTOM PATIO SCREEN DOORS

ENTERPRISE (121S)

991M-999

Made of .019 Gauge Roll form Steel
Colors Available: White, Clay, Almond, Bronze

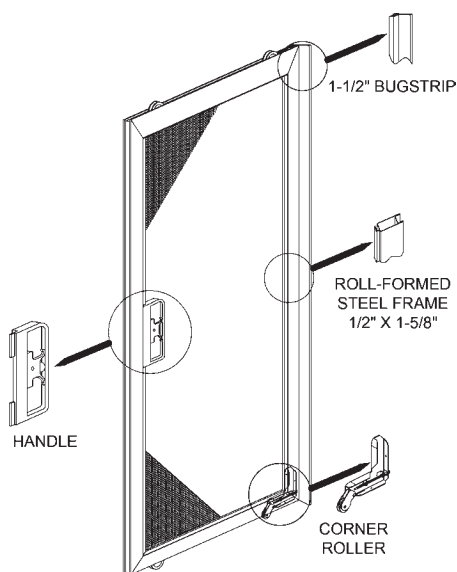

- Vinyl Bug Flap (Standard)
- Reversible for right or left hand doors
- Available in Gray or Charcoal Fiberglass Cloth (Standard)
- Replaces Patio Screen Doors with 1/16" to 3/16" sill/track bead height
- Each door includes: latch, keeper, rollers, bug seal and instructions
- Spring loaded latch will not break when door is slammed
- Custom made to fit width and height openings
- Frame size is 1/2" thick x 1-5/8" wide
- Additional charges apply for steel rollers.
- Additional charges apply for stainless steel rollers & coastal hardware.
- Additional charges apply for aluminum wire.
- Additional charges apply for woolpile.
- Freight: FOB Shipping Point

**Top Hung System
Now Available for Top
Rolling Application!**

Includes top hung adapter & track. Additional charges apply.

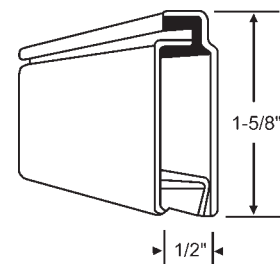
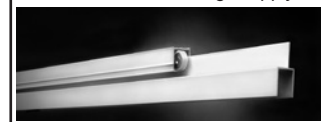

NOTE: Minimum 10 assembled screens per order.

Steel Custom Made Patio Screen Doors are not Available with Deephead and Deepsill.

EXTRUDED ALUMINUM CUSTOM MADE PATIO DOOR SCREENS

GEMINI (199EXT)

Custom Extruded

999M-999

Colors Available: White, Clay, Almond, Black & Bronze

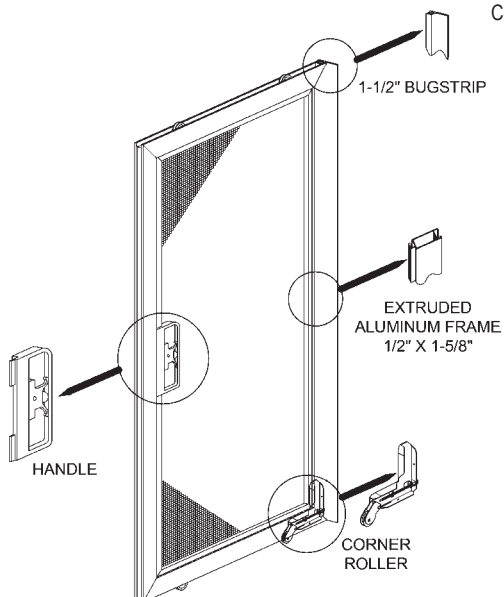

- Vinyl Bug Flap (Standard)
- Reversible for right or left hand doors
- Available in Gray or Charcoal Fiberglass Cloth (Standard)
- Replaces Patio Screen Doors with 1/16" to 3/16" sill/track bead height
- Each door includes: latch, keeper, rollers, bug seal and instructions
- Spring loaded latch will not break when door is slammed
- Custom made to fit width and height openings
- Prices are for Standard Patio Screen Doors
- Frame size is 1/2" thick x 1-5/8" wide
- Additional charges apply for steel rollers.
- Additional charges apply for stainless steel rollers & coastal hardware.
- Additional charges apply for aluminum wire.
- Additional charges apply for woolpile.
- Freight: FOB Shipping Point

**Top Hung System
Now Available for Top
Rolling Application!**

Includes top hung adapter & track. Additional charges apply.

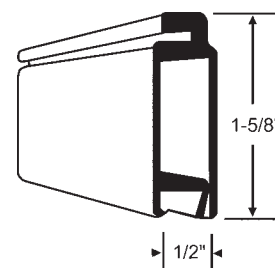
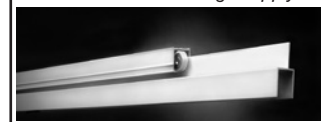

NOTE: Minimum 10 assembled screens per order.

CARRIER CHARGES CONTINUE TO FLUCTUATE. PLEASE CALL FOR DELIVERY CHARGES

TITAN (144 EXT)

Custom Extruded

998M-999 - Contemporary

Colors Available: White, Clay, Almond, Black & Bronze

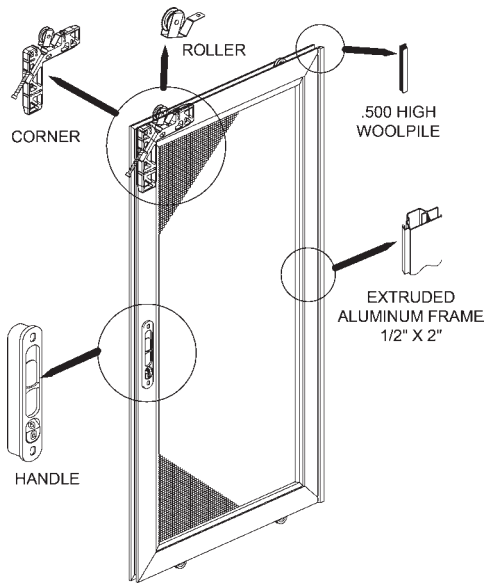

- Frame size 1/2" x 2" wide
- Reversible for right or left hand doors
- Custom made to fit width and height openings
- Made of heavy duty .040 gauge extruded aluminum
- Available In two designs: classic and contemporary
- Comes standard with top adjusting nylon roller, upgraded handle system, and vinyl bug flap
- Each door includes: latch, keeper, and instructions
- Affordable upgrade from a roll formed door
- Additional charges apply for steel rollers.
- Additional charges apply for stainless steel rollers.
- Additional charges apply for aluminum wire.
- Freight: FOB Shipping Point

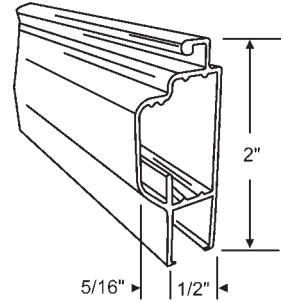

NOTE: Minimum 10 assembled screens per order.



(MOOSE)

Custom Extruded

996-999

A Good Substitute to Replace Andersen Screen Door

Colors Available: White, Clay, Almond, Black & Bronze

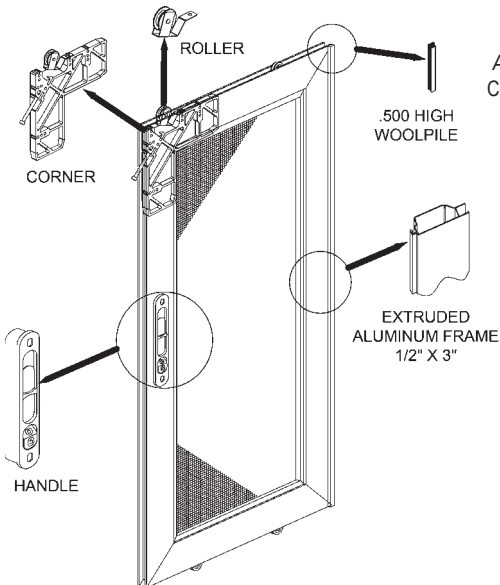

- Features our own premium locking handle and strike
- Offer your customers the ultimate upgrade in a rolling patio door screen
- Especially well designed to match the profiles of the best wood patio doors
- Rolls quietly and effortlessly on steel ball bearing wheels that can easily adjusted to fit your opening
- Enhance your product image with our heavy duty frame design, with walls a full .050" thick
- Additional charges apply for steel rollers.
- Additional charges apply for stainless steel rollers.
- Additional charges apply for aluminum wire.
- Freight: FOB shipping point

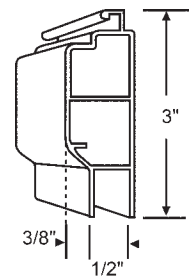

NOTE: Minimum 10 assembled screens per order.

CARRIER CHARGES CONTINUE TO FLUCTUATE. PLEASE CALL FOR DELIVERY CHARGES

STEEL MULTI-FIT PATIO SCREEN DOORS

ENTERPRISE (121SMFIT)

Colors Available: White, Grey, Bronze

COMBINE SIZES TO GET QUANTITY DISCOUNTS

Note: This is a painted galvanized steel product. No warranty is given, written, or inferred against rusting, corrosion or reactions against dissimilar metals.

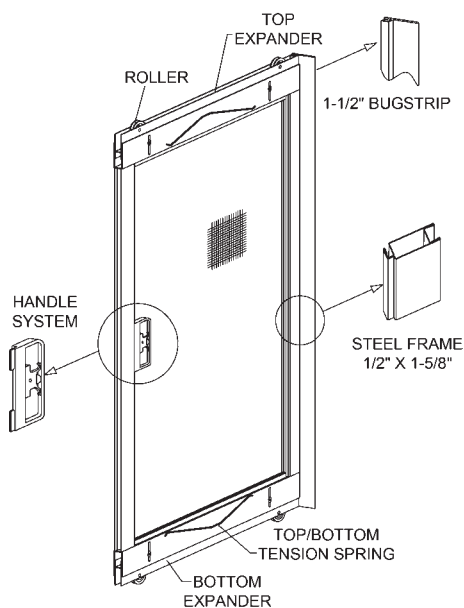

- Made of .019 gauge rollform steel
- Reversible for right or left hand doors
- Replaces 90% of existing patio screen doors
- Steel wheels available, add \$2.25 to cost of screen (Standard on Heavy Duty Door)
- Available in gray or charcoal fiberglass cloth -standard
- Bright and charcoal aluminum wire available add 35% to cost of screen
- Complete with latch, door pull, keeper, non-adjusting nylon rollers, bug strip and instructions
- Comes with heavy duty top & bottom expanders allowing the doors to adjust from 78" to 80" for a custom fit
- Tear away vinyl bug flap is designed for hand peeling to custom fit your door
- Easy access field adjustments for quick installation
- Patio doors are 1/2" thick x 1-5/8" wide
- Freight: FOB shipping point

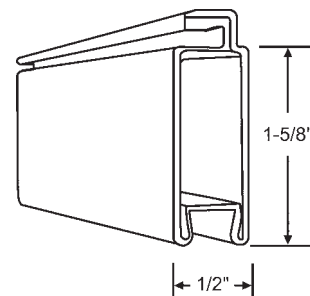

STANDARD PRE-ASSEMBLED*

Part #	Size	Color
93-1	30"	Gray
93-2	36"	Gray
93-3	48"	Gray
93-5	30"	Bronze
93-6	36"	Bronze
93-7	48"	Bronze
93-9	30"	White
93-10	36"	White
93-11	48"	White

BOSS (140SMFIT)

Colors Available: White, Mill, Bronze

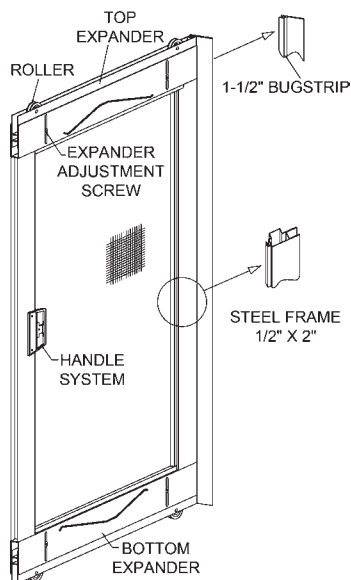

- Made of .019 gauge rollform steel
- Reversible for right or left hand doors
- Replaces 90% of existing patio screen doors
- Steel wheels Standard on Heavy Duty Door
- Available in gray or charcoal fiberglass cloth -standard
- Bright and charcoal aluminum wire available add 35% to cost of screen
- Complete with latch, door pull, keeper, non-adjusting nylon rollers, bug strip and instructions
- Comes with heavy duty top & bottom expanders allowing the doors to adjust from 78" to 80" for a custom fit
- Tear away vinyl bug flap is designed for hand peeling to custom fit your door
- Easy access field adjustments for quick installation
- Patio doors are 3/4" thick x 2" wide
- Freight: FOB shipping point

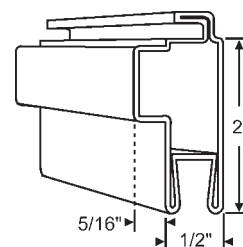

HEAVY DUTY PRE-ASSEMBLED*

Part #	Size	Color
997-1	30"	Gray
997-2	36"	Gray
997-3	48"	Gray
997-5	30"	Bronze
997-6	36"	Bronze
997-7	48"	Bronze
997-9	30"	White
997-10	36"	White
997-11	48"	White

Heavy Duty

(Includes 2 Removable Push Bars, Steel Rollers and HD Latching Handle)

STEEL MULTI-FIT PATIO SCREEN DOORS

MOOSE (MOOSEFIT)

Colors Available: White, Mill & Bronze

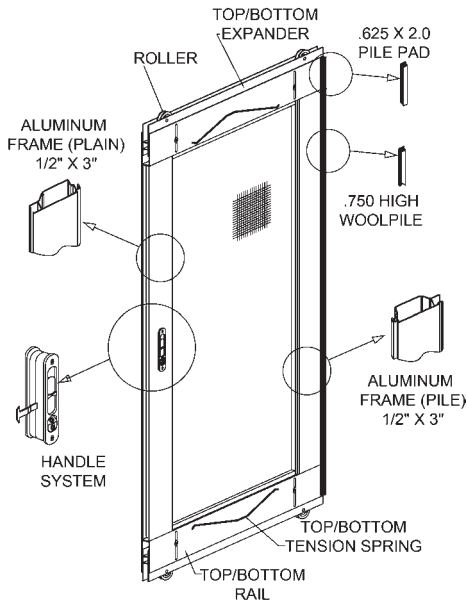

STANDARD PRE-ASSEMBLED*

Part #	Size	Color
994-1	30"	Mill
994-2	30"	White
994-3	30"	Bronze
994-4	36"	Mill
994-5	36"	White
994-6	36"	Bronze
994-7	48"	Mill
994-8	48"	White
994-9	48"	Bronze

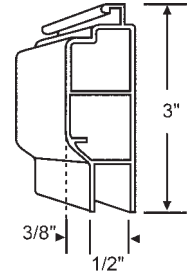

KNOCK-DOWN PATIO SCREEN DOORS

995H - Superior Quality Extruded Patio Screen Doors

COMBINE SIZES TO GET QUANTITY DISCOUNTS

Part #	Size	Color
995H-1KD	30" x 80"	Mill
995H-2KD	30" x 80"	White
995H-3KD	30" x 80"	Bronze
995H-19KD	30" x 96"	Mill
995H-20KD	30" x 96"	White
995H-21KD	30" x 96"	Bronze
995H-7KD	36" x 80"	Mill
995H-8KD	36" x 80"	White
995H-9KD	36" x 80"	Bronze
995H-22KD	36" x 96"	Mill
995H-23KD	36" x 96"	White
995H-24KD	36" x 96"	Bronze
995H-13KD	48" x 80"	Mill
995H-14KD	48" x 80"	White
995H-15KD	48" x 80"	Bronze
995H-25KD	48" x 96"	Mill
995H-26KD	48" x 96"	White
995H-27KD	48" x 96"	Bronze

- Premium Extruded Frame
- Precision, Mitered Corner Design
- Zinc Die Cast Corners with Integrated Nylon Side Adjustable Rollers
- High Quality Molded Handle Set with Lock Tab
- Wool Pile Standard
- All Components Available Separately
- Currently Available Colors Include: Mill, White, and Bronze
- Charcoal Fiberglass Screen Mesh and .135 Spline Included

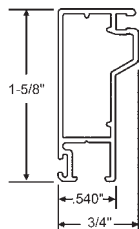

Top and Side Rail

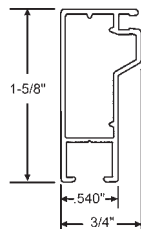

Bottom Rail Bug Flap Profile (Insect Barrier)

Custom sizes available including other screen mesh options and nylon, steel, or stainless steel rollers. Contact your account manager for details. (Part# 995H-999KD)

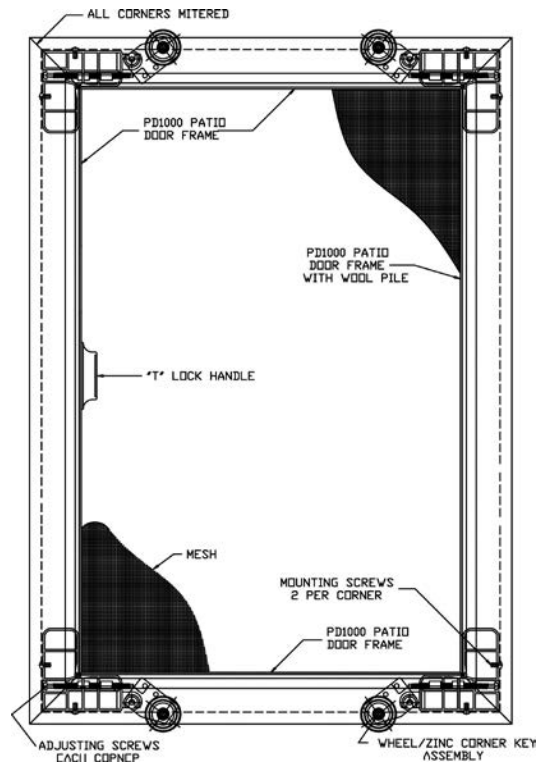

CARRIER CHARGES CONTINUE TO FLUCTUATE. PLEASE CALL FOR DELIVERY CHARGES.

TOP HUNG SYSTEM FOR TOP ROLLING APPLICATION

This system is used with our Titan and Moose Patio Door Screens.

EXPLODED PARTS VIEW



Top Hung Track

Top Hung Adapter

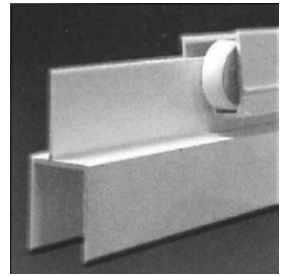

CLOSE-UP ROLLER VIEW

Top Hung Adapters

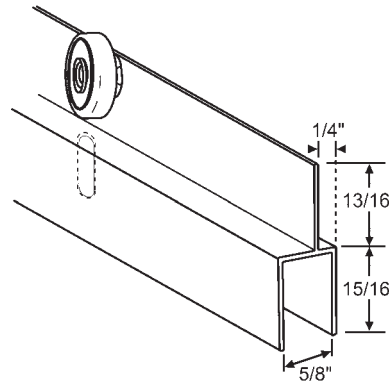

90M-637, 638 and 639
Available in Bronze and White Only

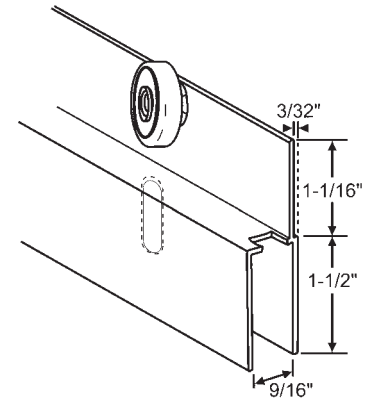

90M-641, 642 and 643
Available in Bronze and White Only

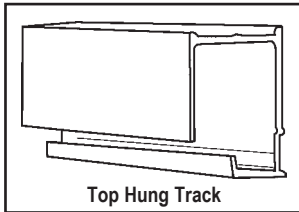

Top Hung Track

8 Ft. Top Hung Track	Colors	30" Top Hung Adapter	36" Top Hung Adapter	48" Top Hung Adapter
90M-640BZ	Bronze	90M-637BZ	90M-638BZ	90M-639BZ
		90M-641BZ	90M-642BZ	90M-643BZ
90M-640W	White	90M-637W	90M-638W	-
		90M-641W	90M-642W	90M-643W

SCREEN TOOLS

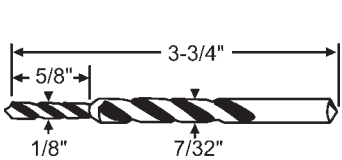

59-51

Step Drill. For plunger with 7/32" tip. High speed hardened steel step drill makes two diameter holes in one pass for a precise screen plunger fit.



59-44

Concave Roller/Cutter
Steel Wheel

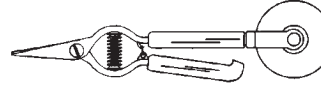

59-45

Cloth Cutter with Steel Wheel



Part #	Description
59-10	5/32" Wheel
59-10SP	1/16" Wheel

Plastic Roller and Housing

Screen Spline and Screen Wire Installation Tool

A professional tool with wood handle and steel enclosed ball bearing rollers. Use convex roller of installation tool to roll screen wire into slot of screen frame; use concave roller to roll spline into slot over screen wire to hold it tightly in place.

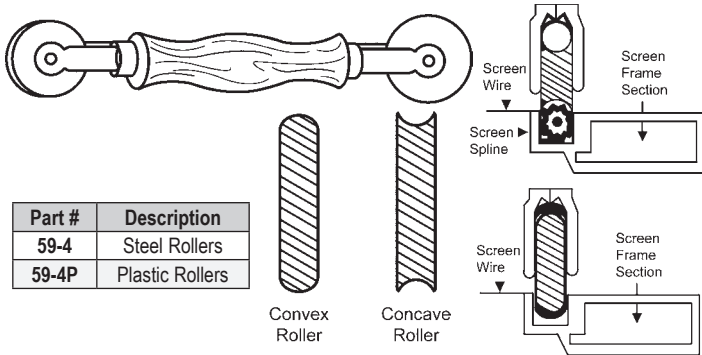

Part #	Description
59-4	Steel Rollers
59-4P	Plastic Rollers

Convex Roller
Concave Roller

Screen Frame Notching Jig Easy to Use! A Real Time Saver!

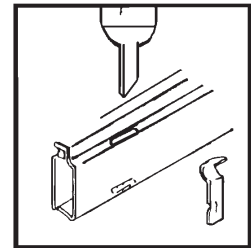
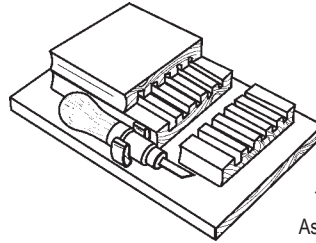

900-15853

The Screen Frame Notching Jig and Tool Assembly installs tension springs, slide locks, swivel and knife latches in aluminum window screen metal. The grooved wooden jig holds 5/16", 3/8" and 7/16" screen frame securely while you notch the metal with the notching tool.

<p>900-15852 Notching Tool</p>	<p>59-15 One-Way Screw Remover</p>	<p>59-7 Long Reach Needle Pliers Set • 2 piece 11" 20° offset & 45° angle • Reach areas too tight for standard pliers • Made from drop-forged, heat-treated steel</p>	<p>59-14 Utility Knife • Professional Quality. • Button Projects and Retracts Blade • Sturdy Handle Provides Storage</p>	<p>59-112 Metal Handle Glass Cutter. Tungsten Carbide Wheel</p>
---	---	--	---	--

Any Binding Surfaces Under High Pressure Need a Slider Slicking!



59-91

Sliding glass door track lubricant.
4" x 5/8" Diameter Stick

Slider-Slicker is a solid stick lubricant in a handy large crayon type package. Uses range from glass and screen door tracks to zippers and sticky doors. Handy to keep in the kitchen drawer, toolbox, car or camper. A dry, stick lubricant, specifically formulated for lubricating sliding track surfaces on old binding or worn Sliding Glass Doors, Screens & Windows.

Phillips® #2 1/4" Nut Driver Phillips® #1 Slotted 9/32" 5/16" Nut Driver Slotted 3/16"

59-23
6-in-1 Screwdriver. Bits and tube are made of hardened steel. Lifetime Guarantee.

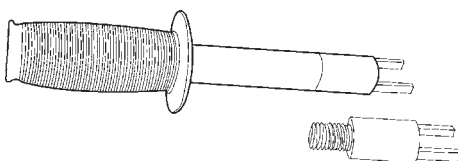

Part #	Fits	Tip Only
59-47	52-614 Roller Assy.	59-47T
59-47-1	52-613 and 52-675 Roller Assy.	59-47-1T
59-47-2	900-1285 Roller Assy.	59-47-2T

Roller Assembly Inserting Tool. Includes Tip.



Part #	Description
59-5	9.4 oz. Can
59-5-1	15 oz. Can

Alum-A-Lub Cleaner is the "All Purpose" lubricating cleaner that can be used on all products that stick or squeak. Alum-A-Lub assures ease of operation and a "Like New" appearance for metal windows, doors, locks, hinges, cabinets and more. Simply spray and wipe away dirt, grime and gummy residue left by other lubricants. A must for your shop, workroom, home, maintenance department or garage.

Sold individually and in cases of 12.



Part #	Description
59-50	11 oz. Can
59-50-1	1 gal. Can

"L.C. Wax" Alumalub Aluminum Lubricant & Liquid Masking cleans and lubricates aluminum better than anything. Quick penetration/release and long lasting lubrication. Cleans corrosion and tarnish; protects from salt corrosion; reduces wear; stops squeaks, bumps, klunks, clicks.

Sold individually and in cases of 12.

Sliding Door Roller Assembly Identification Selector

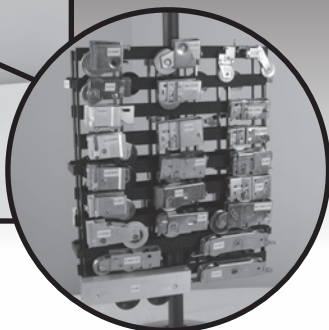

Countertop Model (1 Panel):
45 of the most popular roller assemblies along with 5 variations of wheels available.

500-444-T1: one-panel/2-sides with 45 patio door rollers

Reverse Side

Save space using the fully loaded floor display!

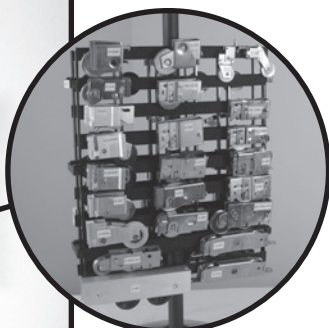
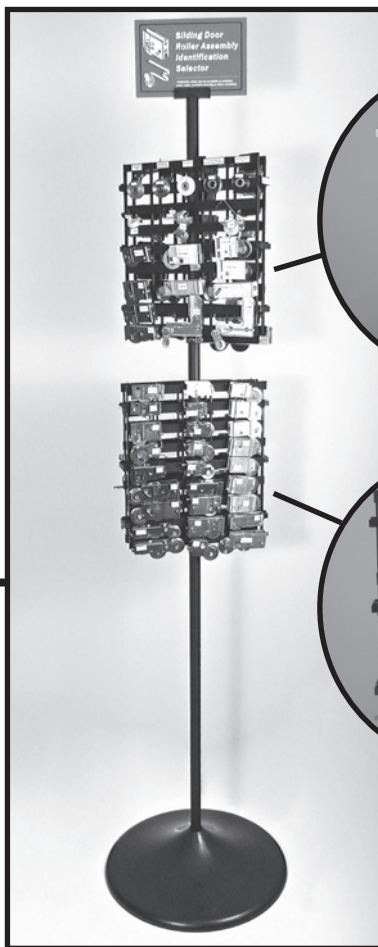

Reverse Side

Floor Model (2 Panel):
90 of the most popular roller assemblies along with 5 variations of wheels available.

500-444-T2: two-panel/4-sides with 90 items

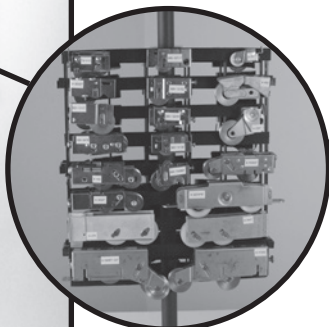

Reverse Side

Both models come complete with assembly instructions, sign and spinning display. Each roller assembly is individually labeled with our part number for easy ordering.

PATIO DOOR HARDWARE

PRECISION BEARING ROLLER ASSEMBLY FOR PATIO SLIDING GLASS DOOR

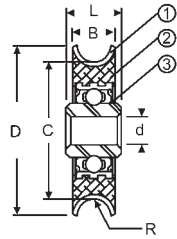

1. Outer Ring - Stainless Steel
2. Reinforced Nylon
3. Precision Bearing

Part #	D	C	d	B	R	L	Load Capacity
11-212	1-1/2"	1-1/4"	1/4"	5/16"	1/8"	3/8"	100 lbs.
11-214	1-1/4"	1"	1/4"	5/16"	1/8"	3/8"	80 lbs.

ABB Series Precision Bearing Stainless Steel Wheels

Completely new design that establishes a new level of quality for Patio Door Rollers. Design Highlights:

- Extremely smooth rolling
- Less operating force (motion to open/close)
- Less noise and vibrations
- Better corrosion resistance
- The Precision Bearing is factory greased and completely sealed
- The outer ring, that is the rolling surface of the wheel, is made of Stainless Steel to avoid any rust formation between the wheel and the track
- Using composite nylon, the Precision Bearing is assembled with the outer ring by an injection molding process

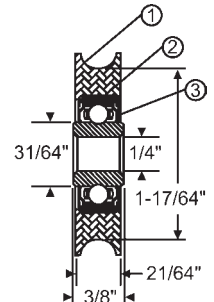

1. Outer Ring - Nylon
2. Reinforced Nylon
3. Precision Bearing

Part #	Wheel	Load Capacity
11-227	1-1/2"	70 lbs.
11-237	1-1/4"	65 lbs.
11-237A*	1-1/4"	65 lbs.

*includes stud

MBB Series Precision Bearing Nylon Wheels

This is an upgraded Nylon wheel that is assembled with a precision bearing as in the ABB Series. The Nylon tire is injected with fiber glass reinforced Nylon. The competitive advantages of this wheel are similar to those for the ABB Series.

- Extremely smooth rolling
- Less operating force (motion to open/close)
- Less noise and vibrations
- Higher Load capacity of 65 Lbs. per wheel (compared to 45 Lbs. per wheel on a regular 1-1/4" Nylon wheel)
- The Precision Bearing is factory greased and completely sealed

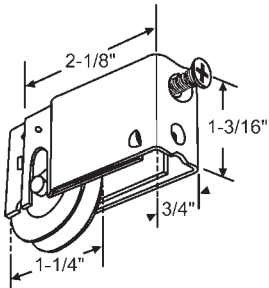

Part #	Wheel Type
900-10106NPB	Nylon
900-10106SPB	Stainless Steel

NU-AIR

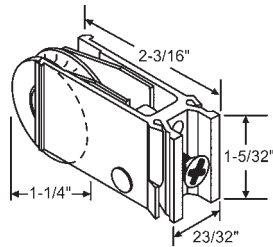

Part #	Size	Outer Ring
9-252SPB	1-1/4"	Stainless Steel
9-252NPB	1-1/4"	Nylon

MILLER

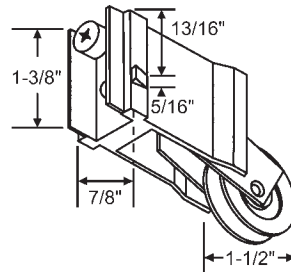

Part #	Size	Outer Ring
9-257SPB	1-1/2"	Stainless Steel
9-257NPB	1-1/2"	Nylon

PAN AM

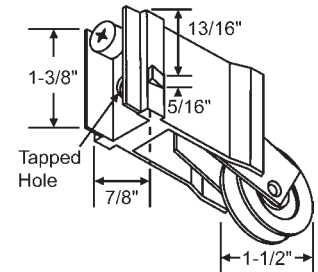

Part #	Size	Outer Ring
9-457SPB	1-1/2"	Stainless Steel
9-457NPB	1-1/2"	Nylon

PAN AM/AAA

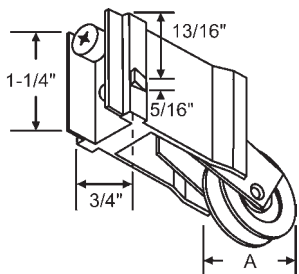

Part #	A	Outer Ring
9-247-1.25SPB	1-1/4"	Stainless Steel
9-247SPB	1-1/2"	Stainless Steel
9-247NPB	1-1/2"	Nylon

YALE OGRON

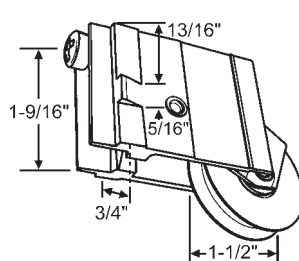

Part #	Size	Outer Ring
9-249SPB	1-1/2"	Stainless Steel
9-249NPB	1-1/2"	Nylon

WEATHERTITE/LAWSON

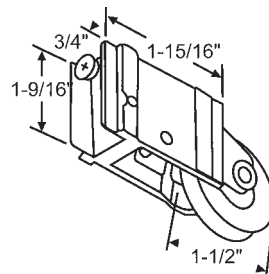

Part #	Size	Outer Ring
9-406SPB	1-1/2"	Stainless Steel
9-406NPB	1-1/2"	Nylon

PGT

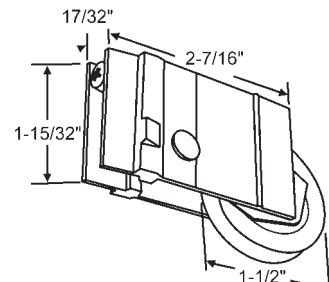

Part #	Size	Outer Ring
9-364SPB	1-1/2"	Stainless Steel
9-364NPB	1-1/2"	Nylon

Max. Width at Locking Tangs 31/32"

LAWSON/WALLACE

PRECISION BEARING ROLLER ASSEMBLY FOR PATIO SLIDING GLASS DOOR

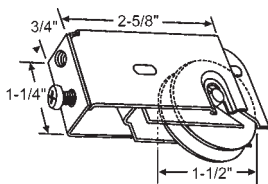

Part #	Size	Outer Ring
9-392SPB	1-1/2"	Stainless Steel

Max. Housing Thickness 3/4"
CROFT

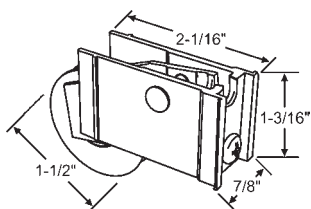

Part #	Size	Outer Ring
9-330SPB	1-1/2"	Stainless Steel

SECURITY

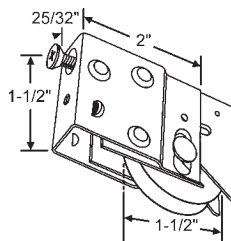

Part #	Size	Outer Ring
9-366SPB	1-1/2"	Stainless Steel

Max. Dimple Width 29/32"
Max. Width at Locking Tangs 1"
BINNINGS/PAN AM

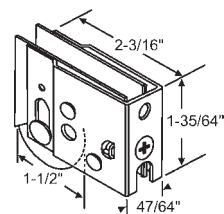

Part #	Size	Outer Ring
9-338SPB	1-1/2"	Stainless Steel

Maximum Width at Locking Tangs 7/8"
HARCAR/KELLER/PAN AM

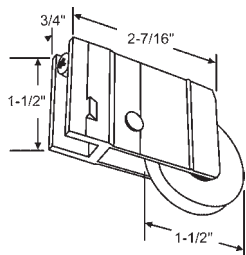

Part #	A	Outer Ring
9-453SPB	1-1/2"	Stainless Steel
9-453NPB	1-1/2"	Nylon

LAWSON

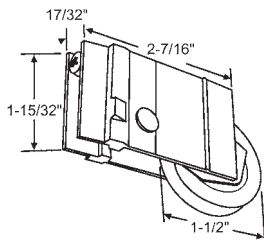

Part #	Size	Outer Ring
9-364SS-SPB	1-1/2"	Stainless Steel
9-364SS-NPB	1-1/2"	Nylon

LAWSON/WALLACE

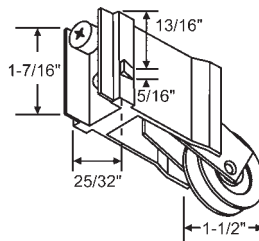

Part #	Size	Outer Ring
9-237SPB	1-1/2"	Stainless Steel
9-237NPB	1-1/2"	Nylon

WALLACE

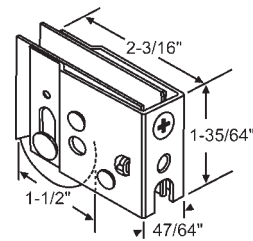

Part #	Size	Outer Ring
900-11287SPB	1-1/2"	Stainless Steel
900-11287NPB	1-1/2"	Nylon

CROWN/LAWSON

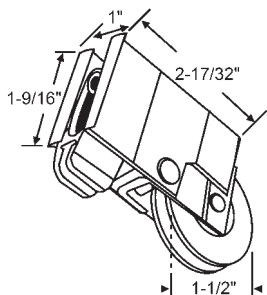

Part #	Size	Outer Ring
900-22583-NPB	1-1/2"	Nylon

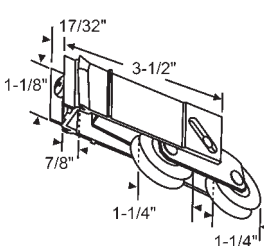

Part #	Size	Outer Ring
9-368SS-SPB	1-1/4"	Stainless Steel
9-368SS-NPB	1-1/4"	Nylon

THERMALUME

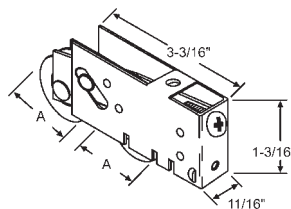

Part #	A	Outer Ring
9-443-1.25SPB	1-1/4"	Stainless Steel
9-443SS-1.25SPB*	1-1/4"	Stainless Steel
9-443SPB	1-1/2"	Stainless Steel
9-443NPB	1-1/2"	Nylon

NU-AIR

*All Stainless Steel

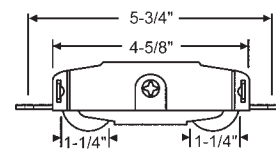

Part #	Wheel Type
9-312SPB	Stainless Steel
9-312NPB	Nylon

Stainless Steel Housing

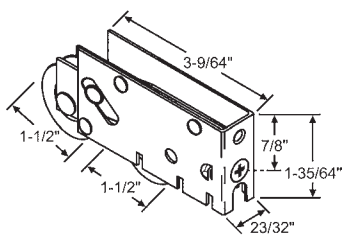

Part #	Size	Outer Ring
900-22693-SPB	1-1/2"	Stainless Steel
900-22693-NPB	1-1/2"	Nylon

PGT/KINCO

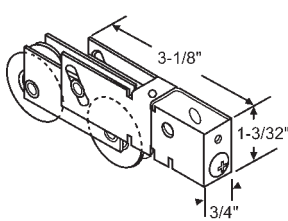

Part #	Wheel Type	Wheel Size
9-403SPB	Stainless Steel	1-1/2"
9-403NPB	Nylon	1-1/2"

Maximum Housing Width 3/4"

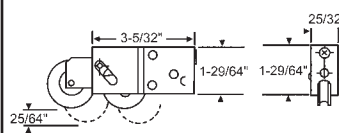

Part #	Size	Outer Ring
9-309SPB	1-1/2"	Stainless Steel
9-309NPB	1-1/2"	Nylon

PAN AM

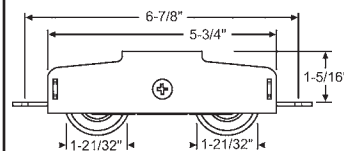

Part #	Size	Outer Ring
9-502SPB	1-21/32"	Stainless Steel
9-502NPB	1-21/32"	Nylon

Your Roller Assembly Not Listed?

Call your sales representative and find out if we can furnish your particular patio door roller assembly with our Precision Bearing Roller. We have machine shop capabilities where we can supply many patio door roller assemblies equipped with our new Precision Bearing Roller.

PATIO DOOR HARDWARE

STAMPED GLASS DOOR ROLLER ASSEMBLIES

In Order by Wheel Diameter

27/32"

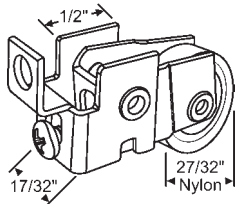

Part #	Wheel Type
9-291	Concave
9-291F	Flat

USED BY TRACO

7/8"

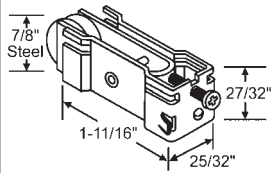

9-295
Flat Wheel
ACORN

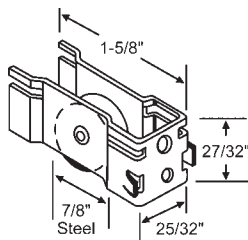

9-296
Flat Wheel
ACORN

1"

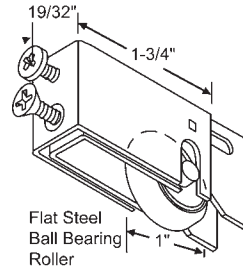

900-9469
CAPITOL/REMINGTON

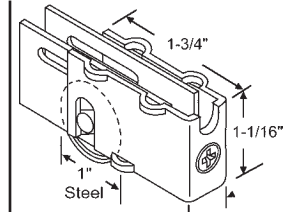

Part #	Wheel Type
9-305	Flat w/Tapered Edges
9-305SP	Concave

CAPITOL

1-1/16"

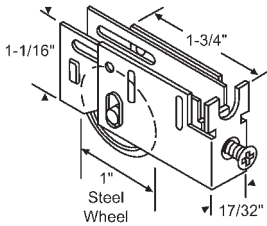

Part #	Wheel Type
900-10138	Flat
9-333	Concave

CAPITOL/REMINGTON

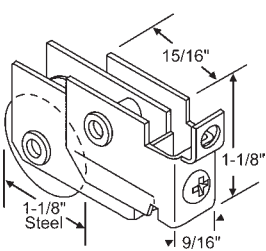

9-306
CAPITOL/REMINGTON

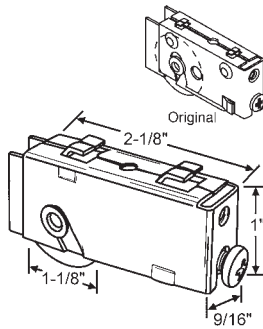

9-218
Max. Dimple Width 3/4"

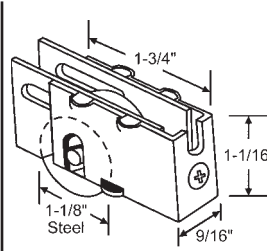

9-273
REMINGTON

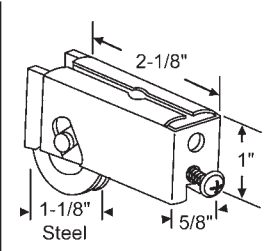

900-16318
CAPITOL

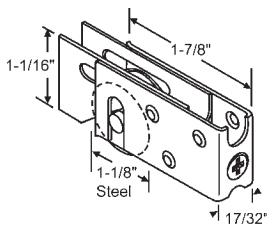

9-325
No Longer Available.
Use 900-14295C

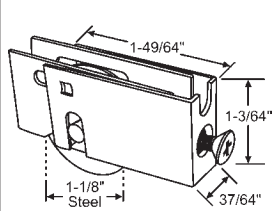

900-14295C

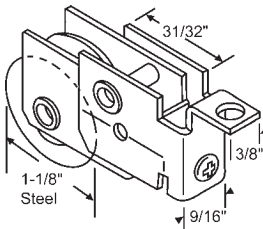

900-16155
SUGAR CREEK

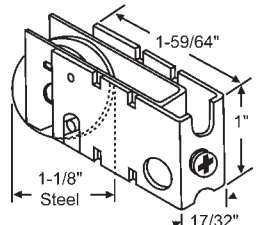

900-16711

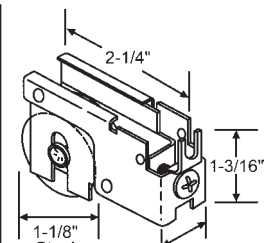

9-289

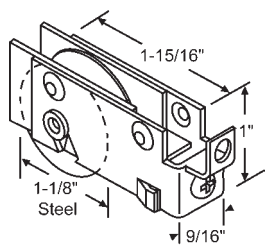

9-324
No Longer Available.
Use 9-293

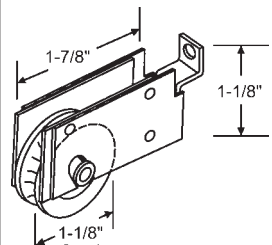

9-293

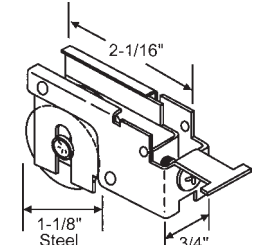

9-292

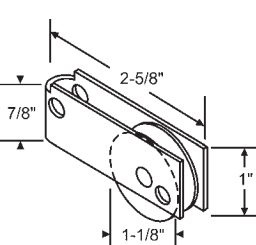

9-279
Top Hole
CAPITOL

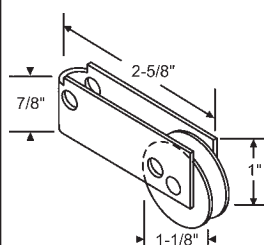

9-279-1
Bottom Hole
CAPITOL

STAMPED GLASS DOOR ROLLER ASSEMBLIES

In Order by Wheel Diameter

1-1/4"

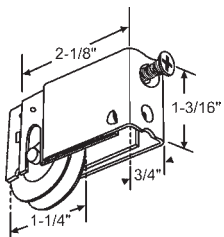

Part #	Wheel Type
900-10106	Steel
900-10106N	Nylon
900-10106SS	Stainless Steel

NU-AIR

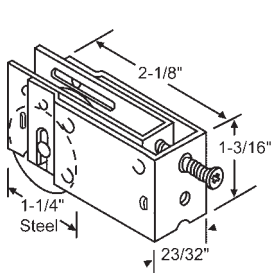

900-15153

Dimple Width 3/4"
Tang Width 7/8"

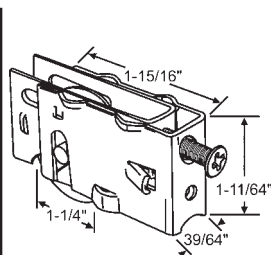

900-10095

Max. Dimple Width 13/16"
BETTER-BILT

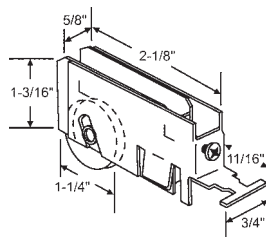

Part #	Wheel Type
9-230	Steel

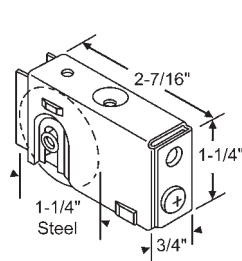

900-18187
BLOMBERG

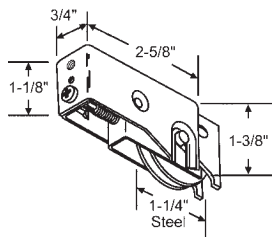

9-238

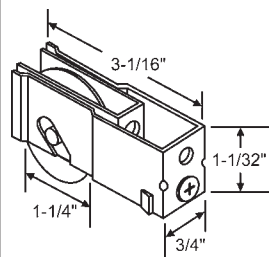

Part #	Wheel Type
9-258	Steel
9-258N	Nylon

DARYL

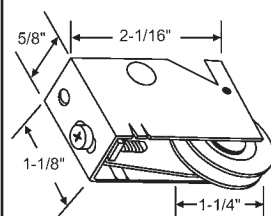

Part #	Wheel Type
9-245	Steel
9-245N	Nylon
9-245SS	Stainless Steel

CROSSLY

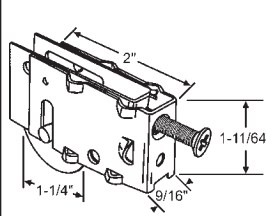

900-7662

Steel. Max. Dimple Width 3/4"
ACORN/ARUNDEL

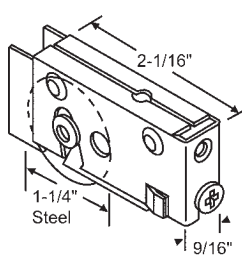

900-13579

Max. Dimple Width 23/32"
ARUNDEL

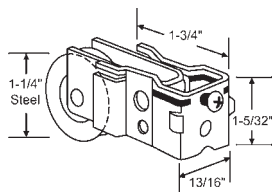

9-215

ACORN

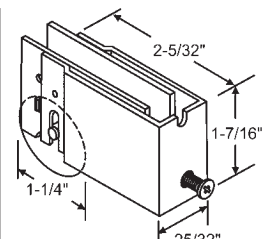

Part #	Wheel Type
9-331	Steel
9-331SS	Stainless Steel

PENNCO

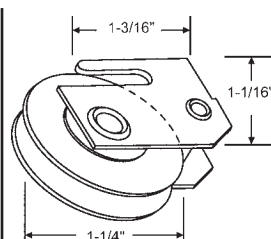

9-209

ADOR HI-LITE

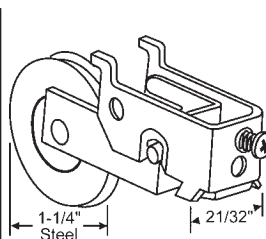

9-209A

ADOR HI-LITE

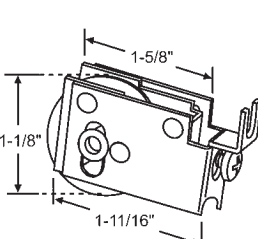

Part #	Wheel Type
900-13138	Steel

LOOK

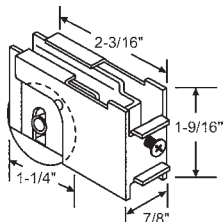

Part #	Wheel Type
9-266	Steel
9-266SS	Stainless Steel

PEACHTREE

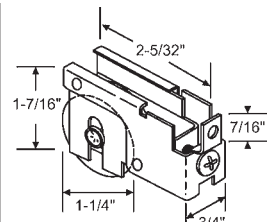

Part #	Wheel Type
9-200	Steel
9-200N	Nylon

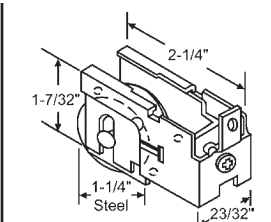

9-299

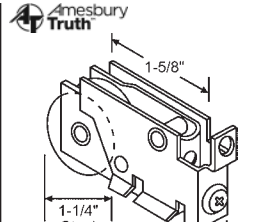

9-286

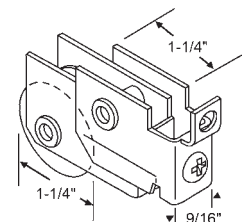

Part #	Wheel Type
9-216	Steel
9-216P	Nylon

PATIO DOOR HARDWARE

STAMPED GLASS DOOR ROLLER ASSEMBLIES

In Order by Wheel Diameter

1-1/4"

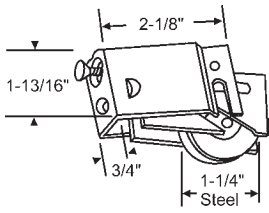

900-13399

Roller Mark II. Max. Dimple Width 7/8". Steel Ball Bearing Roller
NORANDEX

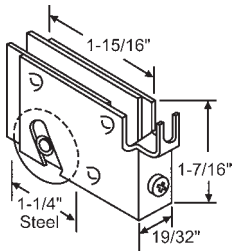

900-10098A

Part #	Wheel Type
9-294	Steel
9-294N	Nylon

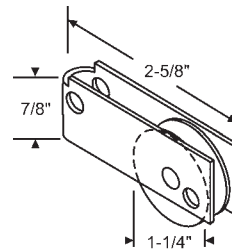
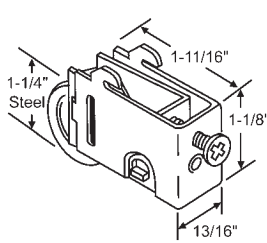

Part #	Wheel Type
9-262M	Steel
9-262	Nylon

Top Hole

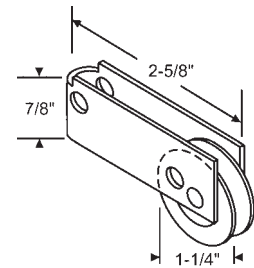

Part #	Wheel Type
9-263M	Steel
9-263	Nylon

Bottom Hole

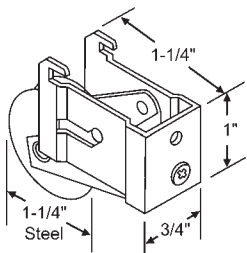

900-9498

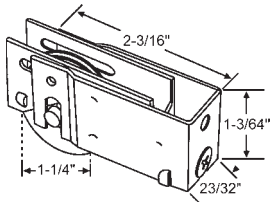

Part #	Wheel Type
900-18649	Steel
900-18649N	Nylon

Steel Body. 7/8" Tab Width

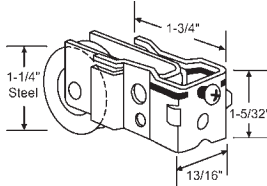

900-215D
ACORN

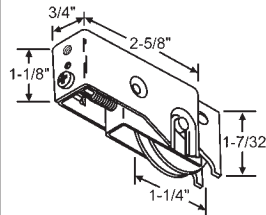

900-318A
JONES/DARYL

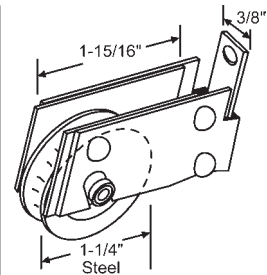

900-219
JONES/DARYL

1-1/2"

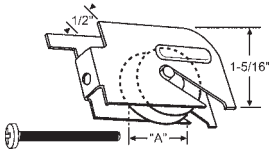

Part #	A
900-18770	1-1/4"
900-18770-1.5	1-1/2"

Supplied With Screw

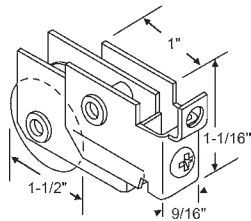

Part #	Wheel Type
9-217M	Steel
9-217P	Nylon

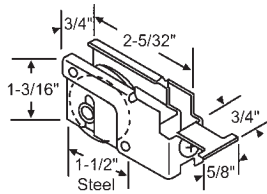

900-225
MARSHALL

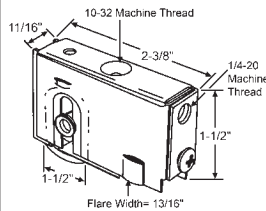

Part #	Wheel Type
9-350	Steel

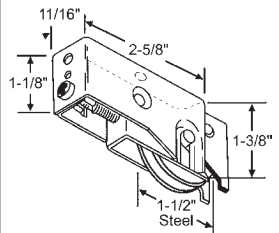

900-341
LENAHAN/DARYL

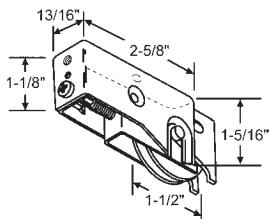

Part #	Wheel Type
9-260M	Steel
9-260	Nylon

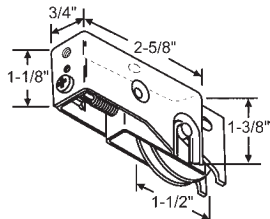

Part #	Wheel Type
9-261	Steel
9-261N	Nylon
9-261SS	Stainless Steel

AIR CONTROL/KELLER

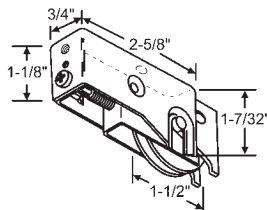

900-318

JONES

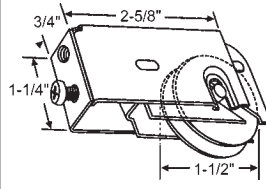

Part #	Wheel Type
9-392	Steel
9-392SS	Stainless Steel

Max. Housing Thickness 3/4"

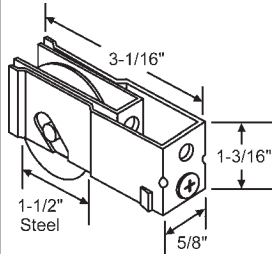

900-250

PATIO DOOR HARDWARE

STAMPED GLASS DOOR ROLLER ASSEMBLIES

In Order by Wheel Diameter

1-1/2"

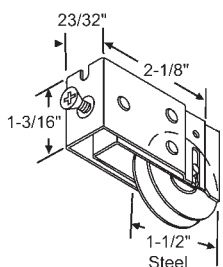

Part #	Wheel Type
900-10116	Steel
900-10116SS	Stainless Steel

BINNINGS

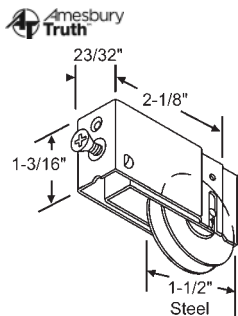

900-10107

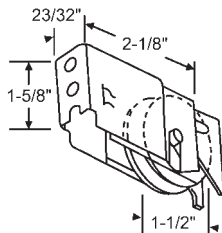

Part #	Wheel Type
9-304	Steel

Maximum Width at Locking Tangs 5/8"

KINCO/HARCAR

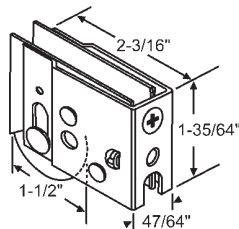

Part #	Wheel Type
900-11287	Steel
900-11287N	Nylon
900-11287SS	Stainless Steel

Maximum Width at Locking Tangs 7/8"

CROWN/LAWSON

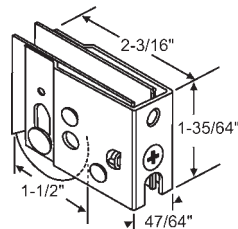

Part #	Wheel Type
9-338N	Nylon
9-338	Steel
9-338SS	Stainless Steel

Maximum Width at Locking Tangs 7/8"

HARCAR

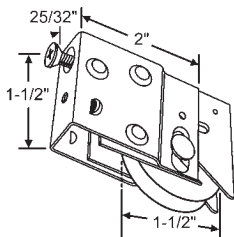

Part #	Wheel Type
9-366	Steel
9-366N	Nylon
9-366SS	Stainless Steel

Max. Dimple Width 29/32"
Max. Width at Locking Tangs 1"

BINNINGS/PAN AM

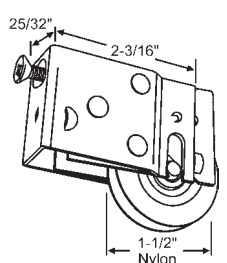

Part #	Wheel Type
9-327	Nylon
9-327S	Steel

Max. Dimple Width 27/32". Max. Width at Locking Tangs 59/64"

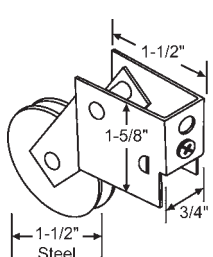

9-235
KELLER

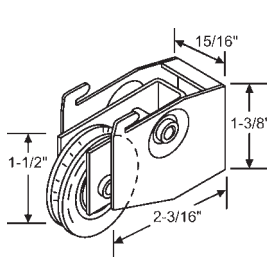

Part #	Wheel Type
9-220	Nylon
9-229	Steel

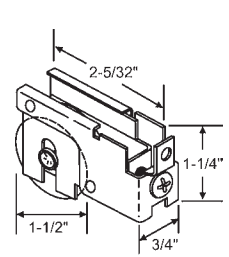

Part #	Wheel Type
9-201	Steel

Dimple Width 25/32"

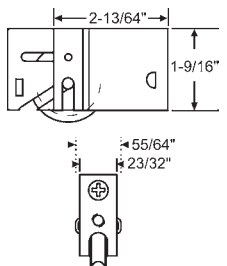

9-512

Steel Outer & Inner Housing with 1-1/2" Steel Wheel

PGT

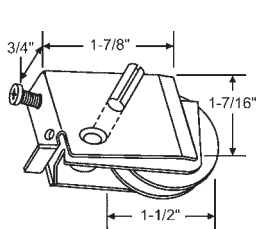

Part #	Wheel Type
9-255	Nylon
9-255M	Steel

LUMIDOR

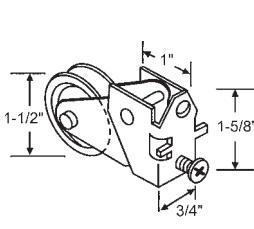

Part #	Wheel Type
9-233	Steel
9-233N	Nylon

STANLEY

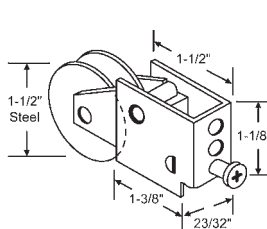

9-211
HARCAR

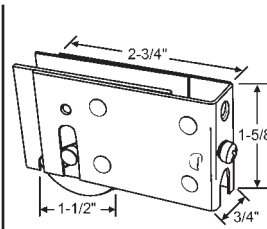

9-377

Dimple Width 7/8"
CROWN INDUSTRIES

1-11/16"

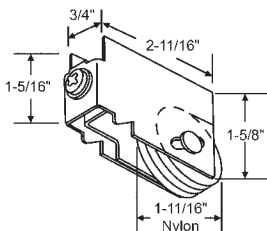

9-207N

Wheel Width 3/8"

ARCADIA

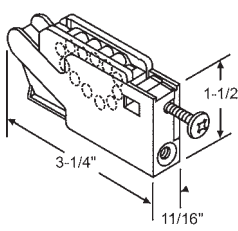

9-335

Nylon Caterpillar Rollers
GREAT LAKES

5/8"

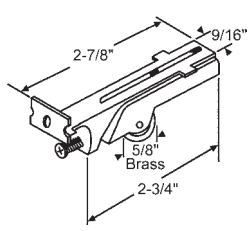

9-202M

Brass Flat Roller

7/8"

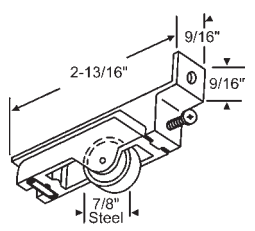

9-277

ATLAS/PORTALUME

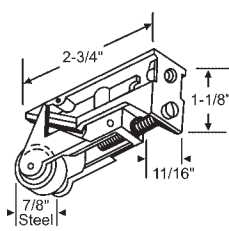

9-303

Flat Roller

DIE CAST ROLLER ASSEMBLIES

PATIO DOOR HARDWARE

DIE CAST ROLLER ASSEMBLIES

In Order by Wheel Diameter

7/8"

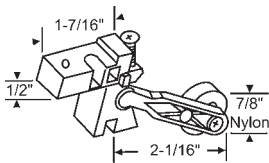

Part #	Hand
9-241RH	Shown
9-241LH	Opposite

MILLER

1-1/4"

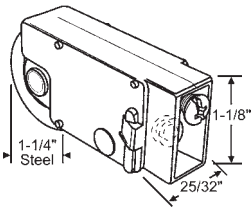

9-214
BINNINGS

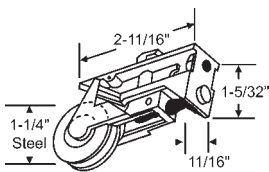

9-276

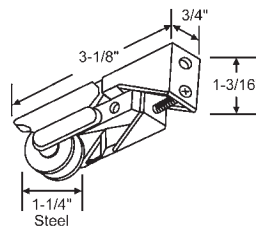

Part #	Wheel Type
9-248	Steel
9-248SS	Stainless Steel

9-275

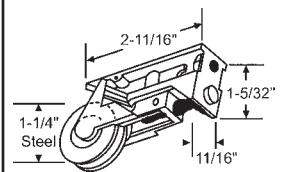

EXTRUDED GLASS DOOR ROLLER ASSEMBLIES

In Order by Wheel Diameter

1-1/2"

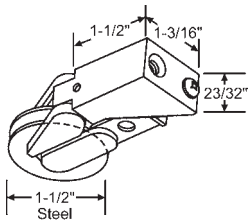

9-268

KELLER/AIR CONTROL

1-1/8"

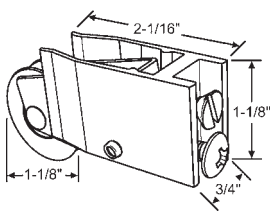

900-11663A

with Corner Housing and Screw
SILVER LINE

1-1/4"

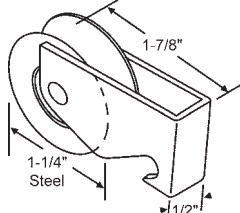

900-11663

SILVER LINE

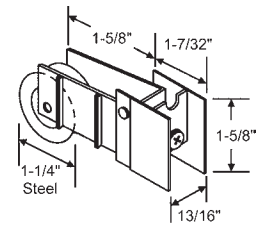

9-231

PEACHTREE

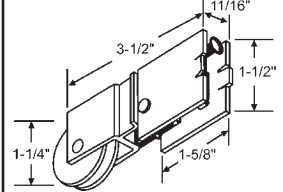

Part #	Wheel Type
9-205	Steel
9-205P	Nylon

PEACHTREE

1-5/16"

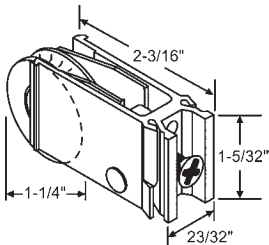

Part #	Wheel Type
9-252	Steel
9-252N	Nylon
9-252SS	Stainless Steel

MILLER

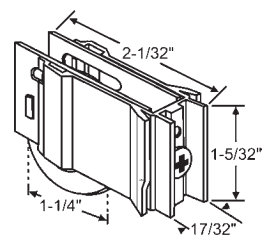

Part #	Wheel Type
9-371	Steel
9-371N	Nylon
9-371SS	Stainless Steel

THERMALUME

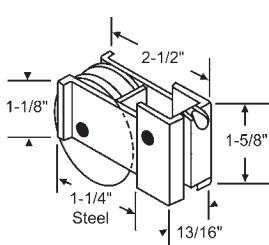

9-236

PEACHTREE

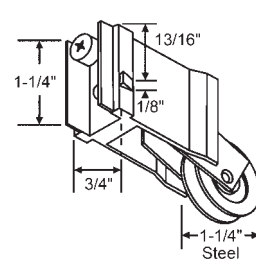

9-247-1.25S

YALE

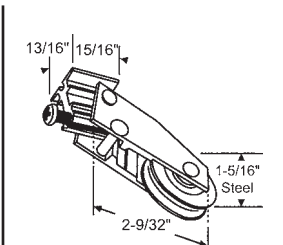

900-9582

CROSSLY

1-1/2"

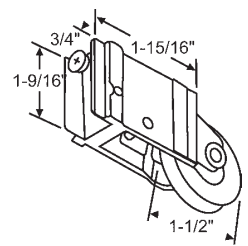

Part #	Wheel Type
9-406	Steel
9-406N	Nylon
9-406SS	Stainless Steel

PGT

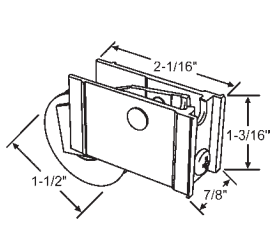

Part #	Wheel Type
9-330	Steel
9-330N	Nylon
9-330SS	Stainless Steel

9-336
1-1/2" Steel Wheel
PGT/ONECO

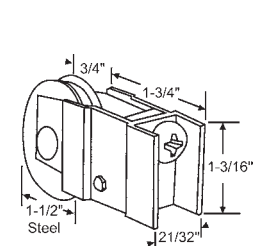
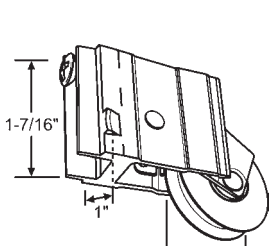

9-361

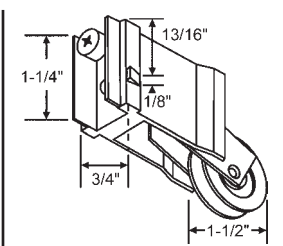

Part #	Wheel Type
9-247	Steel
9-247N	Nylon
9-247SS	Stainless Steel

YALE

PATIO DOOR HARDWARE

EXTRUDED GLASS DOOR ROLLER ASSEMBLIES

In Order by Wheel Diameter

1-1/2"

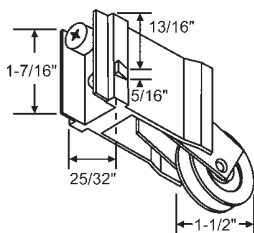

Part #	Wheel Type
9-237	Nylon
9-237S	Steel

WALLACE

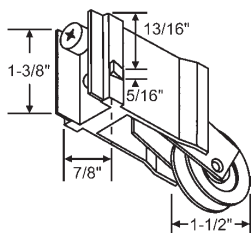

Part #	Wheel Type
9-257	Steel
9-257N	Nylon
9-257SS	Stainless Steel

PAN AM

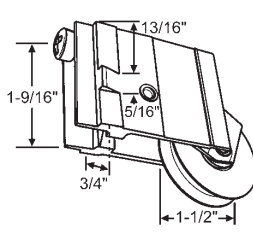

Part #	Wheel Type
9-249	Steel
9-249SS	Stainless Steel

LAWSON

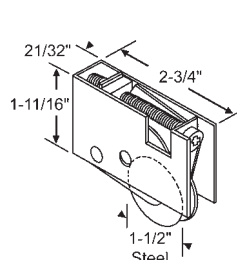

900-22072-OS
Old Style, Pre 1992. Fits Pella

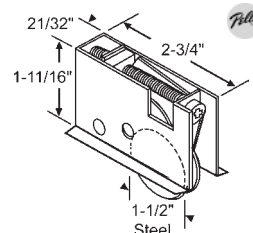

Part #	Wheel Type
900-22072-NS	Steel
900-22072NSSS	Stainless Steel

New Style

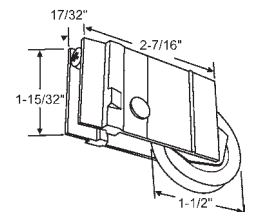

Part #	Wheel Type
9-364	Nylon
9-364S	Steel
9-364SS	Stainless Steel

Max. Width at Locking Tangs 31/32"
LAWSON

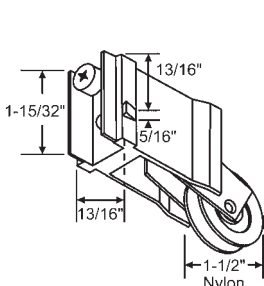

9-240
PLAMETRON

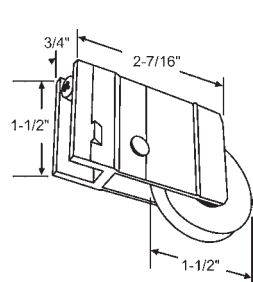

Part #	Wheel Type
9-453	Steel
9-453SS	Stainless Steel

9-370
WALLACE/LAWSON

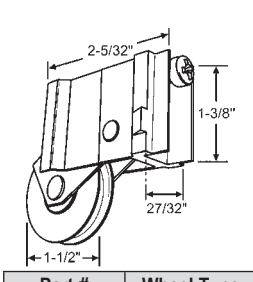
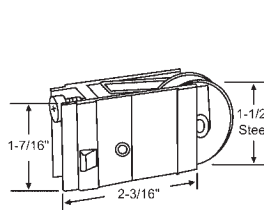

Part #	Wheel Type
9-457	Steel
9-457N	Nylon

Tab to Tab 1-1/2"

TANDEM ROLLERS

In Order by Wheel Diameter

1-21/32"

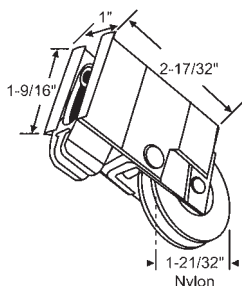

900-22583
ALCAN/NORANDEX

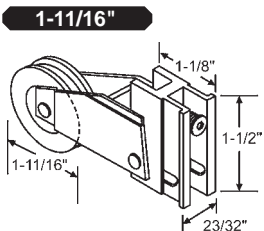

Part #	Wheel Type
9-254SS	Nylon Wheel with Stainless Steel Inner Race
9-254SS-M	Stainless Steel Ball Bearing Wheel

DARYL/PLAZA

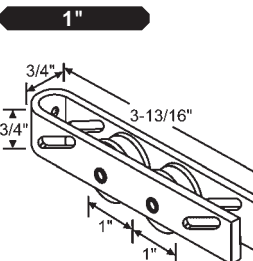

Part #	Wheel Type
9-267	Nylon
9-267S	Steel

1-1/8"

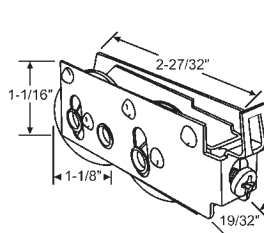

900-9978
Steel Wheel. Dimple Width 3/4"
LOOK/RUSCO

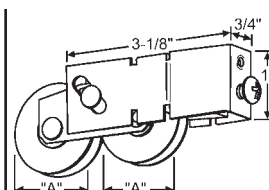

Part #	Wheel Type	A
9-405A	Steel	1-1/8"
9-405SS	Stainless Steel (Housing, Wheels & Screw)	1-1/8"
9-405	Steel	1"

ACORN

1-1/4"

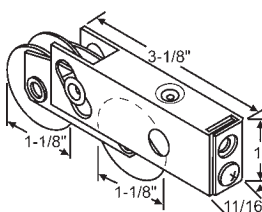

900-19383SS-1 1/8
Stainless Steel 1-1/8" Wheels

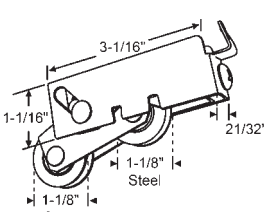

900-12579
Maximum Width at Tangs is .795
ELCO

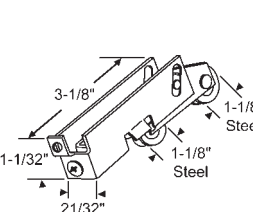

900-20897
D=1-1/8" Steel Rollers
Max Width at Tangs .810
FLEETWOOD

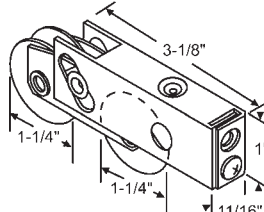

Part #	Wheel Type
900-19383	Steel
900-19383N	Nylon
900-19383SS	Stainless Steel

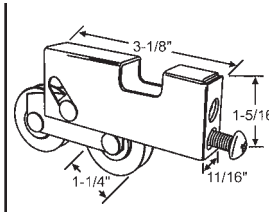

Part #	Wheel Type
9-417	Nylon

PATIO DOOR HARDWARE

TANDEM ROLLERS

In Order by Wheel Diameter

1-1/4"

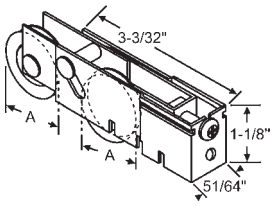

Part #	A	Wheel Type
900-19536	1-1/4"	Steel
900-19536A	1-1/8"	Steel
900-19536SS	1-1/4"	Stainless Steel

WELLS 2000

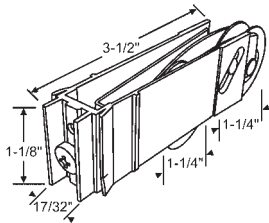

Part #	Wheel Type
9-368S	Steel
9-368SS	Stainless Steel

Max. Housing Width at Locking Tangs = 7/8". Inner Housing Stainless Steel
THERMALUME

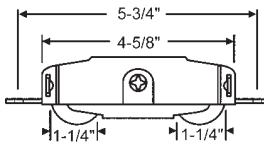

Part #	Wheel Type
9-239	Steel
9-312	Stainless Steel (Housing and Wheels)
9-317	"Flat" Nylon Rollers

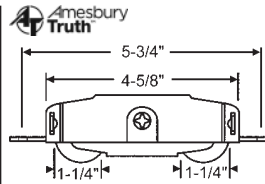

Part #	Wheel Type
9-239T	Steel
9-310T	Nylon
9-312T	Stainless Steel

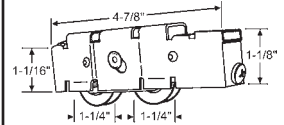

9-449
Steel Housing with Nylon Ball Bearing Wheel
PH TECH/AMERIMAX

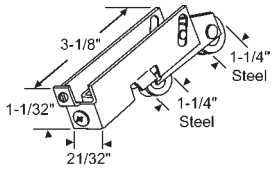

900-20799
D=1-1/4" Steel Rollers
Max Width at Tangs .710
PLY-GEM

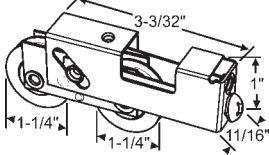

9-362X
Without White Nylon Spacer

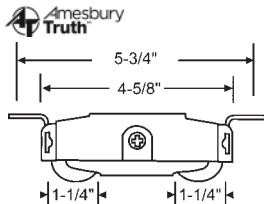

Part #	Wheel Type	Housing Type
9-313T	Steel	Steel
9-316T	Stainless Steel	Steel
9-316	Stainless Steel	Stainless Steel
9-346T	Nylon	Steel

Stainless Steel Housing

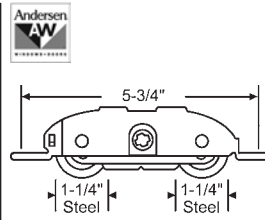

750-1273704
No Longer Available.
Use: 9-239T

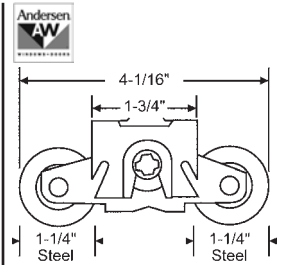

750-1997061

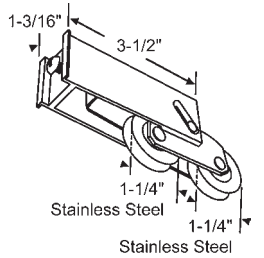

9-367
Maximum housing width at flares 1-3/16"

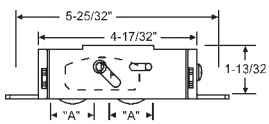

Part #	Wheel Type	A
9-397N	Nylon	1-1/4"
9-397	Steel	1-1/4"
9-397SS	Stainless Steel	1-1/4"
9-441	Steel	1-1/2"

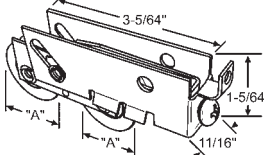

Part #	Type	A
9-455	Domestic	1-1/4"
9-455C	Imported	1-1/4"
9-455A	Imported	1-1/8"

Wheel Type Steel

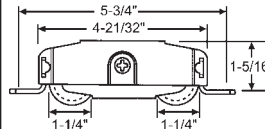

9-355

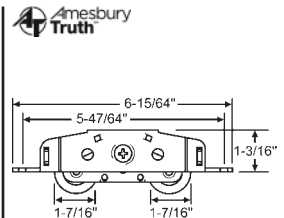

9-274SS
Stainless Steel Housing with (2) 1-7/16" Stainless Steel Wheels

1-1/2"

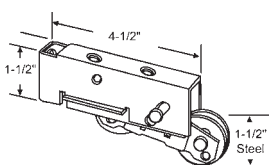

900-20545
1-1/2" Metal Wheel

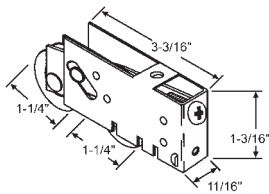

Part #	Wheel Type
9-443	Steel
9-443SS	Stainless Steel

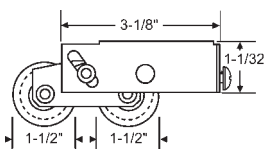

Part #	Wheel Type
900-22358	Steel
900-22358SS	Stainless Steel

Top Hole Mounting

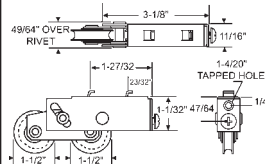

Part #	Wheel Type
900-22357	Steel

Hook Mounting

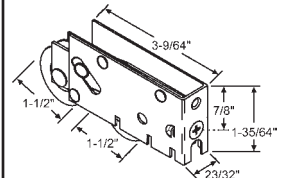

Part #	Wheel Type
900-22693	Steel
900-22693N	Nylon
900-22693SS	Stainless Steel

PATIO DOOR HARDWARE

TANDEM ROLLERS

In Order by Wheel Diameter

1-1/2"

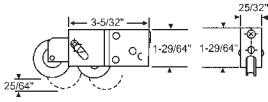

Part #	Wheel Type
9-309	Steel
9-309SS	Stainless Steel

1-1/2" Wheel

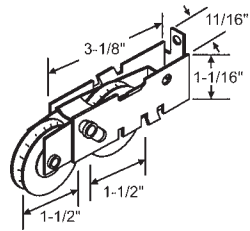

Part #	Wheel Type
9-234	Steel

FLEETWOOD

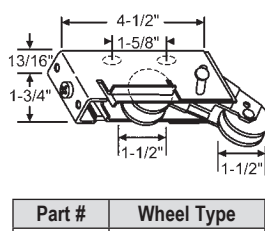

Part #	Wheel Type
9-280	Steel
9-280SS	Stainless Steel

Max. Housing Width 1-7/32"
ARCADIA/KAWNEER

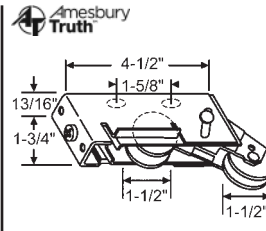

Part #	Wheel Type
9-280D	Steel

Max. Housing Width 1-7/32"
Domestic Version

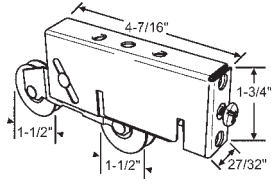

9-473SS
Stainless Steel Wheels
PGT

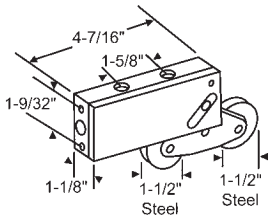

900-12198
KAWNEER

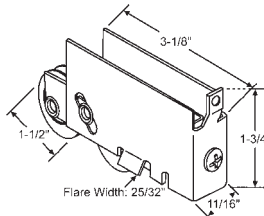

9-507SS
Stainless Steel
FLEETWOOD

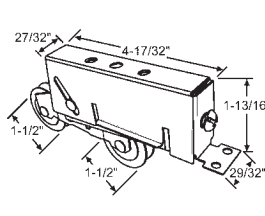

9-280MT-SS
Stainless Steel
ARCADIA

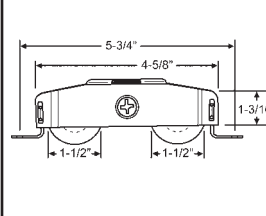

Part #	Wheel Type
9-448	Steel
9-448SS	Stainless Steel

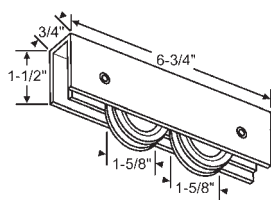

Part #	Wheel Type
9-456	Black Nylon
9-456NB	Nylon Ball Bearing

TM PRODUCTS

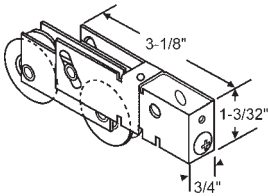

Part #	Wheel Type	Wheel Size
9-403A	Steel	1-1/8"
9-403B	Steel	1-1/4"
9-403	Steel	1-1/2"
9-403BN	Nylon	1-1/4"
9-403A-SS	Stainless Steel	1-1/8"
9-403BSS	Stainless Steel	1-1/4"
9-403SS	Stainless Steel	1-1/2"

Maximum Housing Width 3/4"
PGT/SILVER LINE/ATRIUM

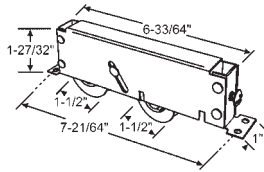

9-474SS
Stainless Steel
PGT / KAWNEER

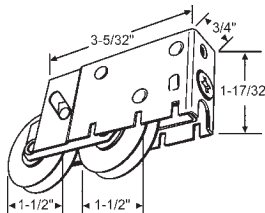

Part #	Wheel Type
9-375	Steel
9-375SS	Stainless Steel

**GUARANTEED PRODUCTS/
JORDAN COMPANY**

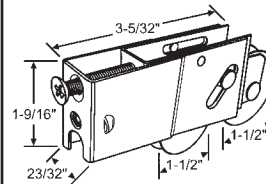

Part #	Wheel Type
9-454	Steel
9-454SS	Stainless Steel

Housing Matches Wheel
PGT

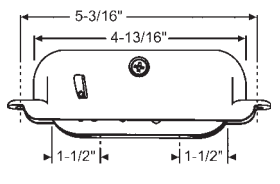

Part #	Wheel Type
9-432	Composite
9-432SS	Stainless Steel

MILGARD/RC ALUMINUM

1-5/8"

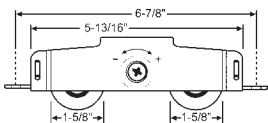

PDR238-DD

Stainless Steel Housing w/ 1-5/8" Precision Bearing Nylon Wheels
KELEGENT

1-11/16"

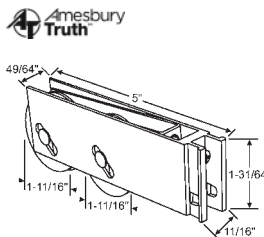

9-254T

1-11/16" Nylon Wheels
Aluminum Housing w/Stainless Steel Inner

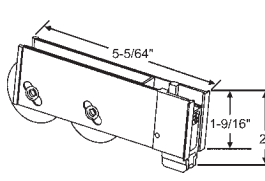

9-378

1-11/16" Nylon Wheels w/ Stainless Steel Ball Bearings. 1" Width Aluminum Outer Housing
Stainless Steel Inner Housing
ALCAN/ NORANDEX

1-13/16"

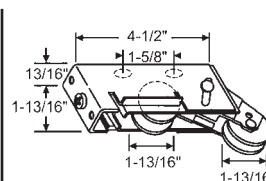

Part #	Wheel Type
9-412	Steel
9-412SS	Stainless Steel

Maximum Housing with 1-3/16"
FLEETWOOD

SCREEN DOOR ROLLER ASSEMBLIES

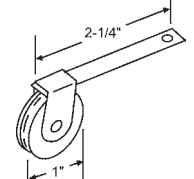

Part #	Wheel Type
10-356	Nylon
10-392	Steel

PATIO DOOR HARDWARE

SCREEN DOOR ROLLER ASSEMBLIES

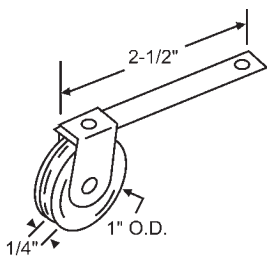

10-436
Nylon Wheel

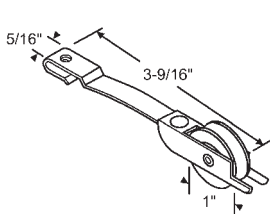

Part #	Wheel Type
10-407	Nylon
10-407M	Steel

COLUMBIA

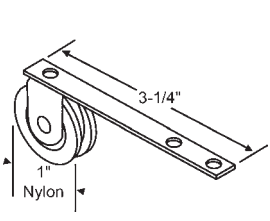

Part #	Wheel Type
10-323	Nylon
10-323M	Steel

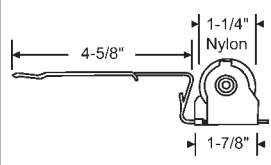

750-1997063
Upper

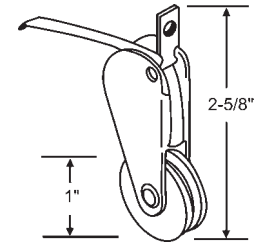

Part #	Wheel Type
10-312	Nylon
10-372	Steel

METAL INDUSTRIES

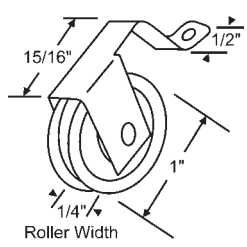

Part #	Wheel Type
10-396	Nylon
10-396M	Steel

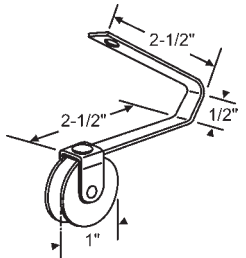

10-388
Nylon

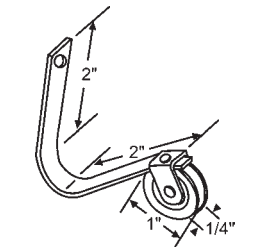

Part #	Wheel Type
10-359	Nylon
10-359M	Steel

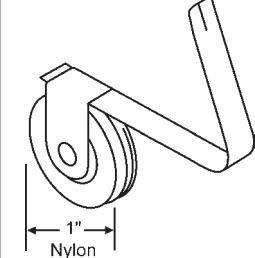

10-308

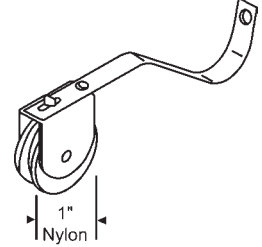

10-341

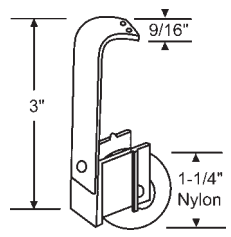

10-353
PEACHTREE

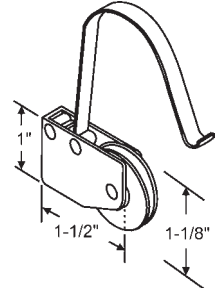

10-414
1-1/8" Dia. Steel Ball Bearing Wheel. Used with Corner 16-301

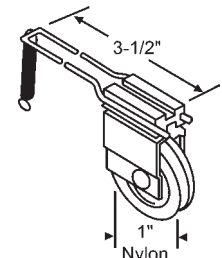

10-315
DARYL

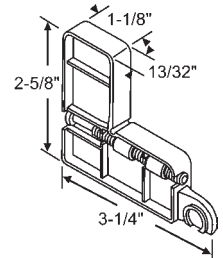

16-301
Corner for 10-414

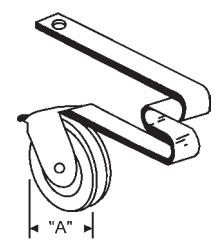

Part #	"A"	Wheel Type
10-358	7/8"	Nylon
10-371	1"	Steel

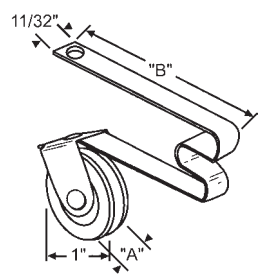

Part #	"A"	"B"	Wheel Groove
10-314	17/64"	2-1/2"	
10-314R	15/64"	2-5/16"	

Nylon Wheel

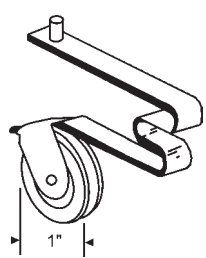

Part #	Wheel Type
10-306	Nylon
10-306M	Steel

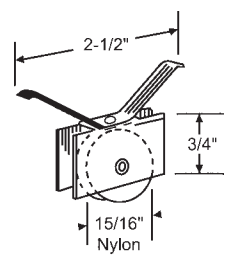

10-300
KELLER

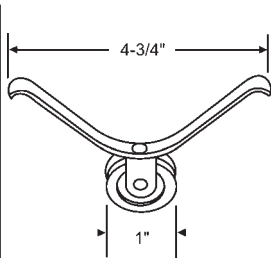

10-391
Nylon Wheel

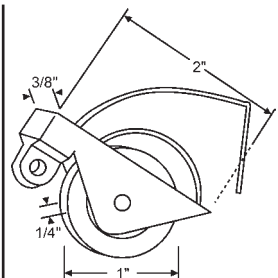

Part #	Wheel Type
10-348	Nylon
10-348M	Steel

SCREEN DOOR ROLLER ASSEMBLIES

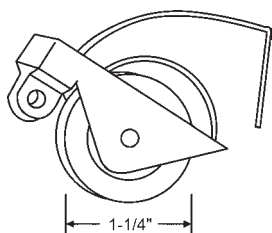

Part #	Wheel Type	Wheel Width
10-360	Nylon	1/4"
10-360M	Steel	3/16"

10-368

ACORN

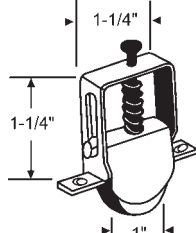
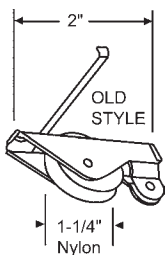

Part #	Wheel Type
10-343	Nylon
10-343M	Steel

Mounting Holes 1-11/16"

COLUMBIA

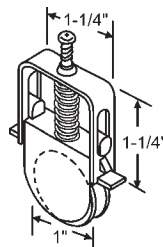

Part #	Wheel Type
10-403	Nylon
10-403M	Steel

COLUMBIA

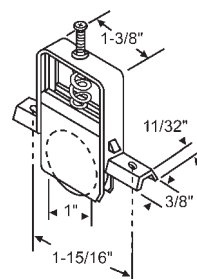

10-404

Nylon
COLUMBIA

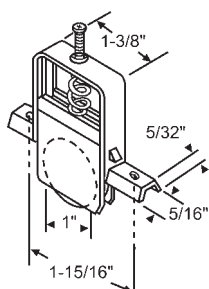

Part #	Wheel Type
10-406	Nylon
10-406M	Steel

COLUMBIA

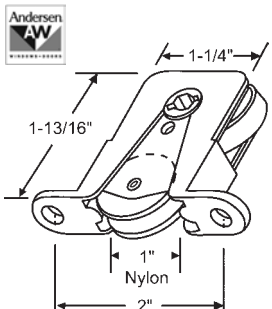

750-1274104

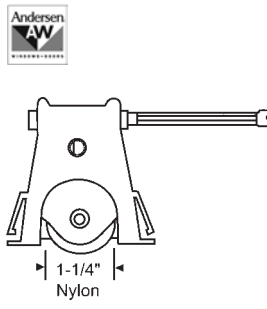

750-1997310

Lower

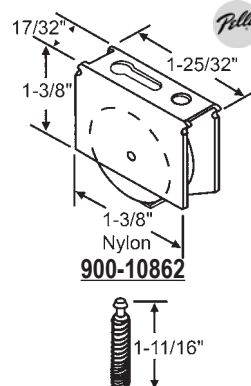

900-10862

Nylon Screw Sold Separately.
Part# 900-10862S

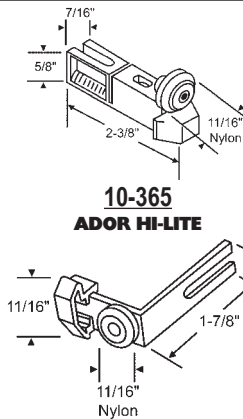

10-365

ADOR HI-LITE

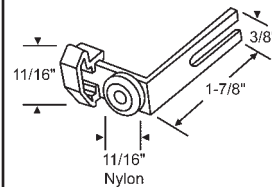

10-387

ADOR HI-LITE

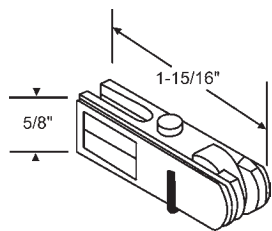

10-326

ADOR HI-LITE

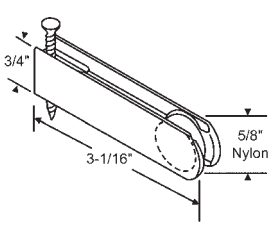

10-401

WEATHER SHIELD

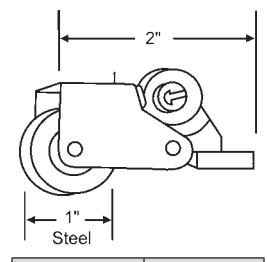

Part #	Hand
900-12879LH	LH (shown)
900-12879RH	RH

Adjustable Roller
RITESCREEN

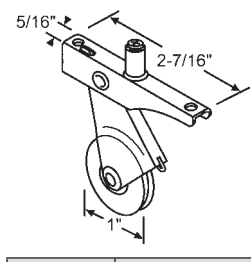

Part #	Wheel Type
10-410	Steel
10-410P	Nylon
10-410SS	Stainless Steel

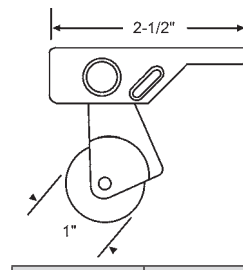

Part #	Wheel Type
900-20072	Nylon
900-20072S	Steel

RITESCREEN/METAL INDUSTRIES

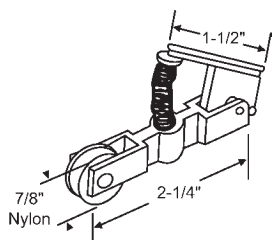

10-302

CHRYSLER

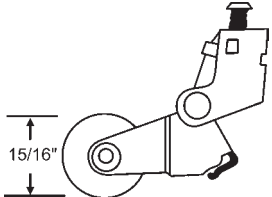

Part #	Wheel Type
10-367	Nylon
10-367M	Steel

JIM WALTERS

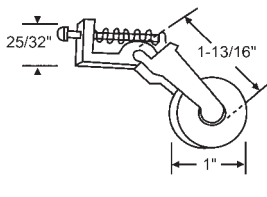

Part #	Wheel Type
900-9705	Nylon
900-9705SS	Stainless Steel

YALE-OGRON

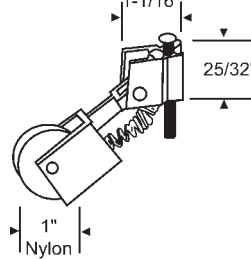

10-313

MILLER

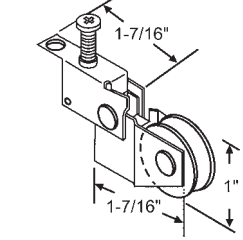

Part #	Wheel Type
900-19216	Nylon
900-19216M	Steel

MOSS

PATIO DOOR HARDWARE

SCREEN DOOR ROLLER ASSEMBLIES

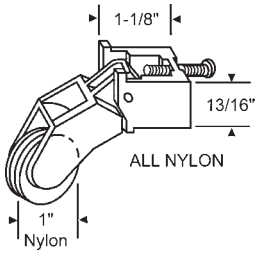

10-394

PEACHTREE

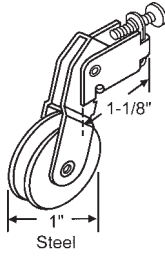

10-394M

PEACHTREE

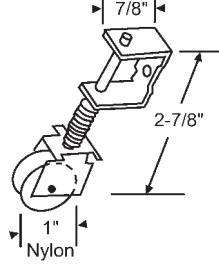

**10-351
CROSSLY**

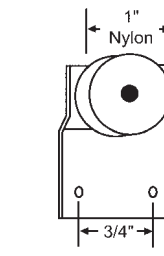

900-14766

Top Hung. Use with 10-395
WEATHER-BARR

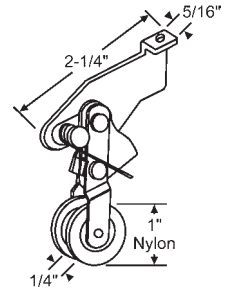

10-395

Use with 900-14766
WEATHER-BARR



900-17614

Adjustment Sleeve for 10-395

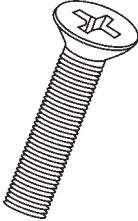

900-17615

Adjustment Screw for 10-395

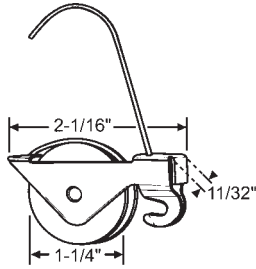

Part #	Wheel Type
10-469M	Steel
10-469N	Nylon
10-469SS	Stainless Steel

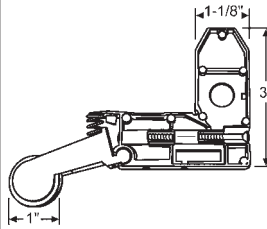

Part #	Wheel Type
10-457	Nylon
10-457SS	Stainless Steel

FLORIDA SCREEN

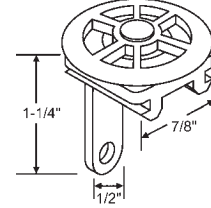

**900-9068
PEACHTREE**

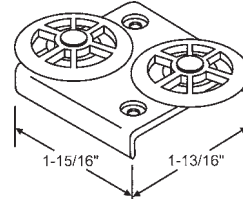

**900-14226
PEACHTREE**

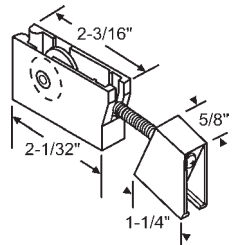

10-417

Old Style
BALTIMORE THERMAL

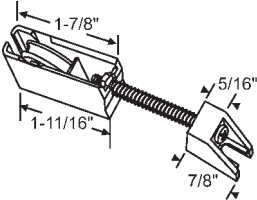

10-417NS

BALTIMORE THERMAL

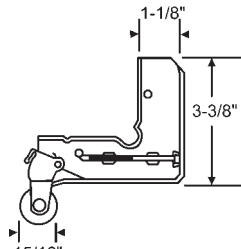

Part #	Wheel Type
10-373	Nylon
10-373M	Steel

Maximum Corner Thickness 7/16"
JIM WALTERS

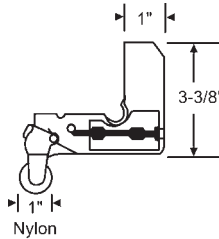

10-399

Maximum Corner Thickness
13/32"
ACORN

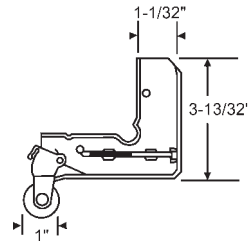

Part #	Wheel Type
10-398A	Nylon
10-398AS	Steel

For 7/16" Aluminum Doors
RITESCREEN

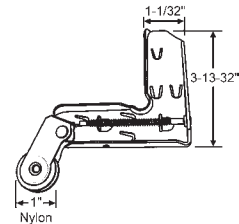

10-398NS

Fits Both Steel and Aluminum
Doors
RITESCREEN

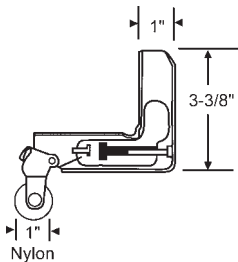

10-355

Maximum Corner Thickness
11/32"
JIM WALTERS

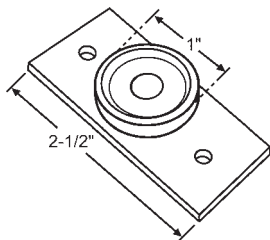

10-460

Top Roller. 1" Nylon Wheel
TM PRODUCTS

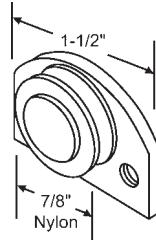

10-301

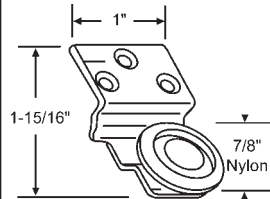

10-344

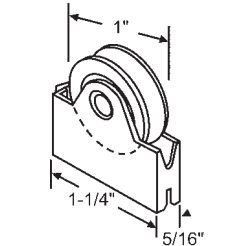

Part #	Wheel Type
10-408	Nylon
10-408M	Steel

Part of 10-402LH/RH
COLUMBIA

SCREEN DOOR ROLLER ASSEMBLIES

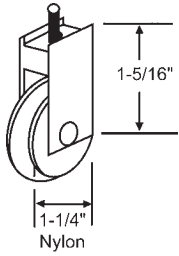

10-317
DARYL

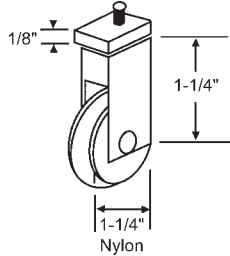

10-318
Nylon

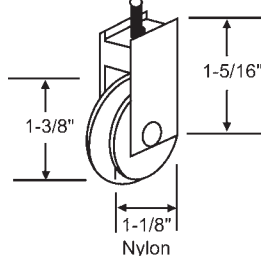

10-316
MILLER

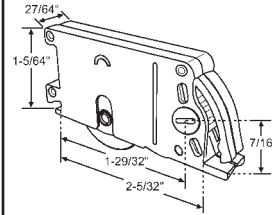

10-443
1" Metal Wheel. Adjustable
Vertical Roller 15/64" thru 7/8"
Highest Position
NORCO

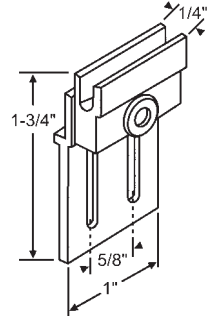

10-455
Aluminum Bracket w/Nylon Guide
CROFT

TRACK AND ROLLER ASSEMBLY

NYLON WHEELS

In Order by Wheel Diameter

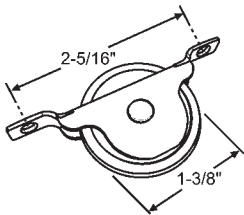

10-466
Garage Door Screen Roller
1-3/8" Rubber Wheel
PGT

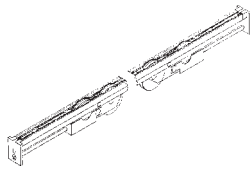

Part #	Description
900-15116	for 34" Glass 38-1/2"
900-15117	for 46" Glass 50"

Assembly has Four 1-1/8" Steel Adjustable Rollers

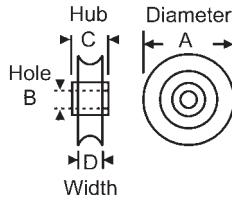

Groove



Part #	A	B	C	D
11-129	5/8"	5/32"	3/16"	3/16"

Nylon with Axle



Part #	A	B	C	D
11-115	5/8"	3/16"	1/4"	3/16"

Nylon

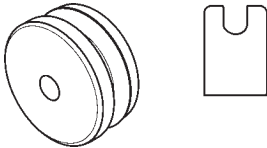

Part #	A	B	C	D
900-10761	1"	7/32"	N/A	7/16"

White Nylon

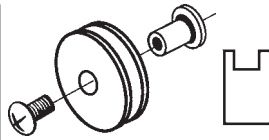

Part #	A	B	C	D
11-112	1-5/64"	1/4"	1/4"	1/4"

Nylon with Post and Screw
AIR CONTROL



Part #	A	B	C	D
11-120	1-1/4"	1/4"	11/32"	5/16"

Nylon with Ball Bearing Steel Hub

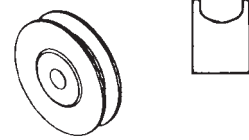

Part #	A	B	C	D
11-122	1-31/64"	1/4"	11/32"	19/64"

Nylon with Ball Bearing Steel Hub



Part #	A	B	C	D
11-110	1-11/16"	1/4"	29/64"	13/32"

Nylon with Steel Ball Bearing Hub

STEEL WHEELS

In Order by Wheel Diameter

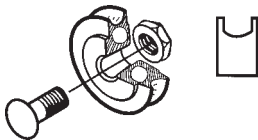

Part #	A	B	C	D
11-130	1"	1/4"	3/8"	5/16"

Steel with Steel Ball Bearing Hub,
Nut & Bolt.

11-130X for Roller Only

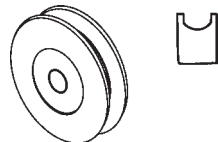

Part #	A	B	C	D
900-9576	1-1/8"	1/4"	3/8"	5/16"

Steel with Ball Bearing Hub

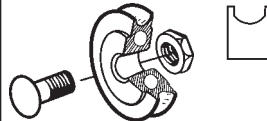

Part #	A	B	C	D
11-116	1-1/4"	1/4"	11/32"	5/16"

Steel with Steel Ball Bearing Hub
Nut & Bolt.

11-116X for Roller Only

Part #	A	B	C	D
11-116SS	1-1/4"	1/4"	11/32"	5/16"

Stainless Steel Roller Only.



Part #	A	B	C	D
11-139	1-1/4"	1/4"	51/64"	5/16"

Steel with Steel Ball Bearing Hub

ACORN



Part #	A	B	C	D
11-111	1-15/32"	1/4"	11/32"	5/16"

Steel with Steel Ball Bearing Hub

Part #	A	B	C	D
11-111SS	1-15/32"	1/4"	11/32"	5/16"

All Stainless Steel

PATIO DOOR HARDWARE

SLIDING GLASS & SCREEN DOOR KEEPERS

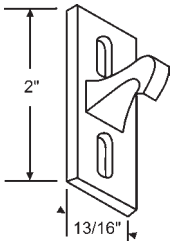

12-251
Chrome Plated
MILLER

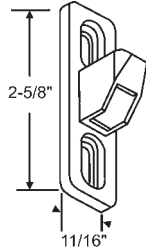

Part #	Finish
12-214	Chrome
12-214B	Black

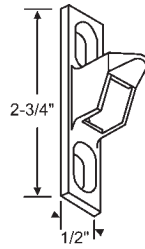

12-211
Chrome Plated
Narrow

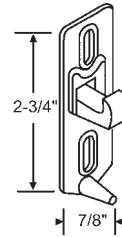

12-205
Chrome Plated
CROSSLY

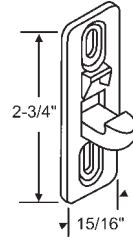

12-216

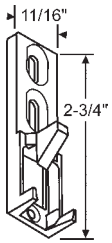

900-9332
QUAKER

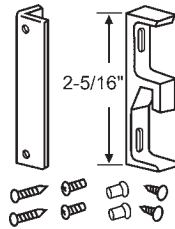

Part #	Finish
12-237	Aluminum
12-237B	Black

Universal Strike Kit

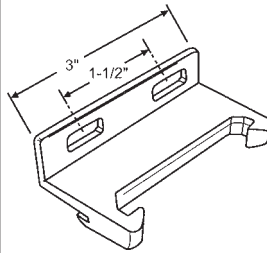

900-69
Mill Finish
YALE-OGRON

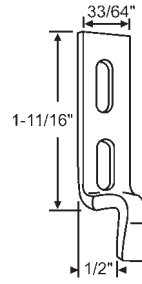

12-304
Metal
WRIGHT PRODUCTS

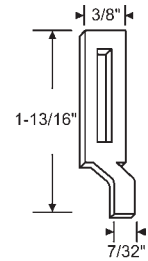

12-206
Metal
RITE SCREEN

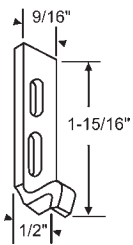

12-248
Metal
ACORN

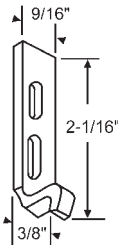

12-240
Steel
WRIGHT PRODUCTS

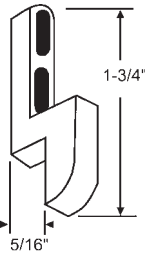

12-212
Mill Finish
RITE SCREEN

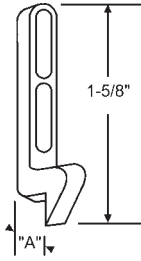

Part #	"A"
12-207	11/16"
12-226	3/16"
12-255	5/16"
12-230	15/32"

Mill Finish

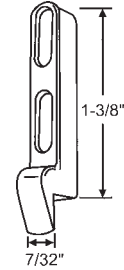

12-256

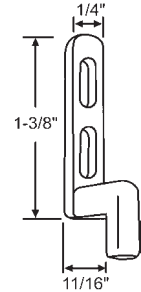

12-287

BAYFORM

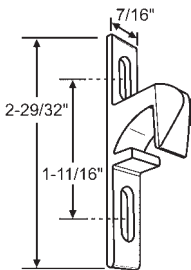

12-306
Aluminum
TM

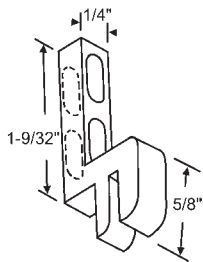

12-268
White Nylon
PGT/LAWSON

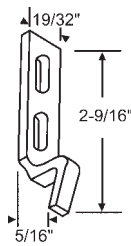

12-250
Metal

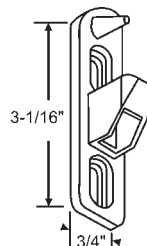

12-249
Chrome Plated

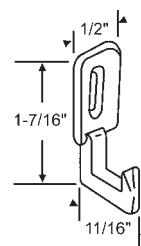

12-232
Metal

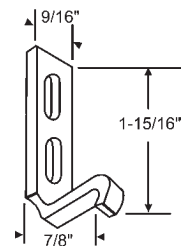

12-247
Metal

FLUSH MOUNT HANDLES FOR PATIO DOORS

In Order by Hole Spacing

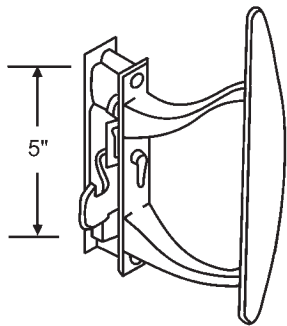

Part #	Hand	Finish
13-171	Shown	Aluminum
13-172	Opposite	Aluminum

TUCKER

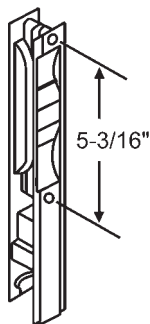

**13-177
DARYL**

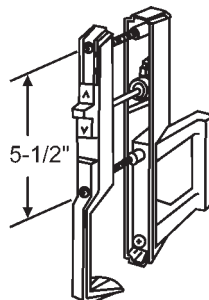

Part #	Finish
13-275	Black
13-275W	White
13-275AB	Antique Brass

ARIEL/PEACHTREE

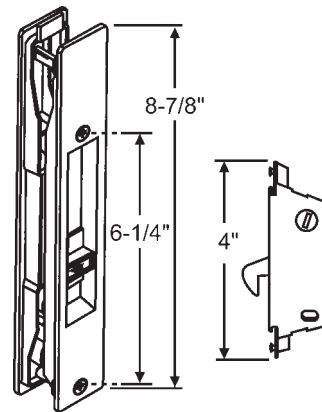

**13-391
Black**

ADAMS RITE

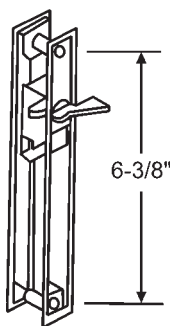

**13-175
Less Key Lock
MILLER**

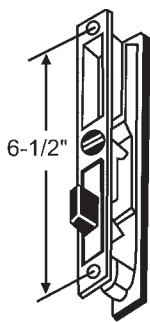

**13-100
Handle Set Less Key Lock
Chrome Plated
For Optional Pull Handle Use 13-108
CROSSLY**

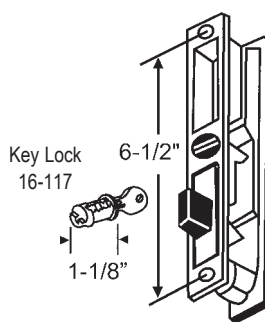

**13-107
Handle Set with Key Lock
Chrome Plated
For Optional Pull Handle Use 13-108
CROSSLY**

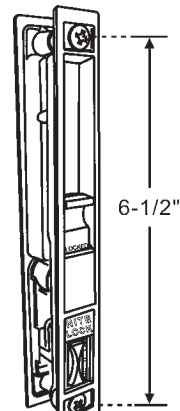

**900-7559
Black
No Longer Available.
Use: 13-140B or 13-192B**

FLUSH MOUNT HANDLES FOR PATIO DOORS

In Order by Hole Spacing

Fit-All Flush Mount Handle Set with Nite Lock

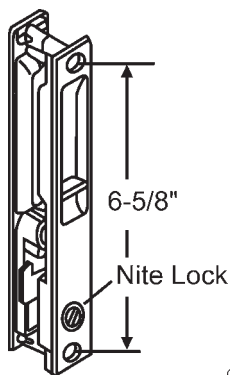

Both Handle Sets Include: Each of 5 Cam Sizes (S,C,P,X,K), 2 Screws and Keeper

Handle Set without Key Cylinder

Part #	Finish
13-140	Chrome
13-140B	Black
13-140W	White
13-140BZ	Bronze

Handle Set with Key Cylinder

Part #	Finish
13-140K	Chrome
13-140BK	Black
13-140WK	White

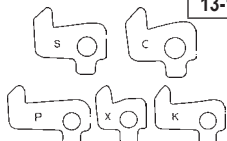

Fit-All Flush Mount Handle Set without Nite Lock

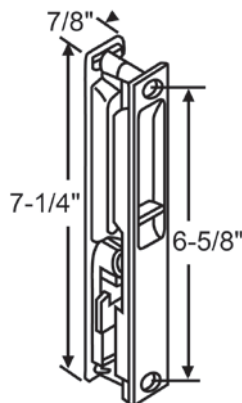

Both Handle Sets Include: Each of 5 Cam Sizes (S,C,P,X,K), 2 Screws and Keeper

Handle Set without Key Cylinder

Part #	Finish
13-192	Chrome
13-192B	Black
13-192W	White

Handle Set with Key Cylinder

Part #	Finish
13-192K	Chrome
13-192BK	Black
13-192WK	White

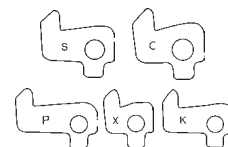

PATIO DOOR HARDWARE

FLUSH MOUNT HANDLES FOR PATIO DOORS

In Order by Hole Spacing

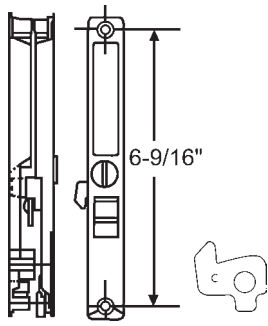

Part #	Finish
13-292	Chrome Plated
13-292W	White
13-292B	Black

With Nite Lock, "C" Cam and Keeper
PAN AM/NU AIRE

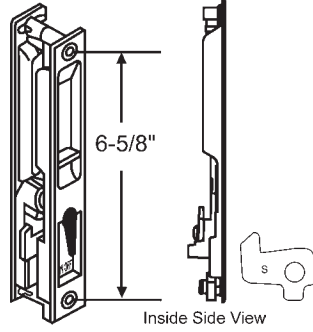

Part #	Finish
900-21019	Black
900-21019C	Chrome
900-21019W	White

With Nite Lock, "S" Cam and Keeper

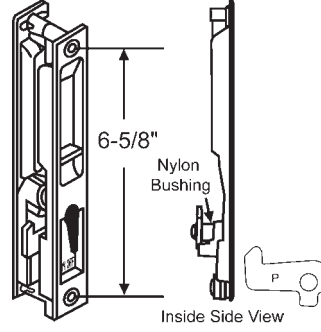

Part #	Finish
13-433B	Black
13-433W	White

With Nite Lock, "P" Cam & Keeper
PGT 2500 SERIES

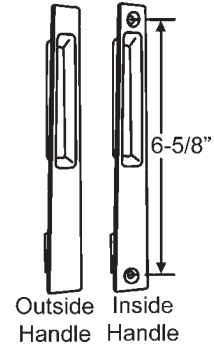

Part #	Finish
13-311	Chrome
13-311W	White
13-311B	Black

Flush mount dummy set

HANDLES FOR PATIO DOORS

In Order by Hole Spacing

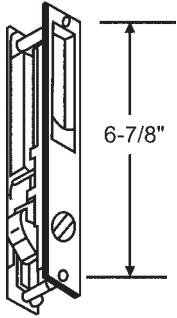

Part #	Description
13-178X	No Key Lock

DARYL

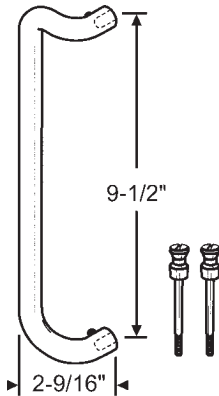

13-531W

White. 1" Offset. Handle for #900-17543W
TM PRODUCTS

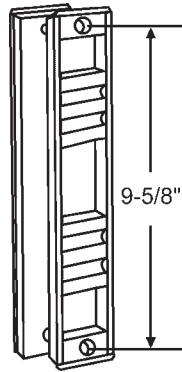

Part #	Finish
900-17543	Black
900-17543W	White

TM PRODUCTS

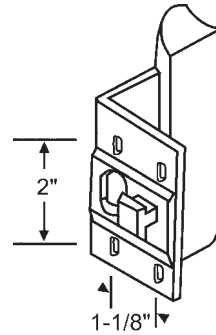

13-191

Black. Used with Lock Bar 16-188 and 16-230
CAPITOL

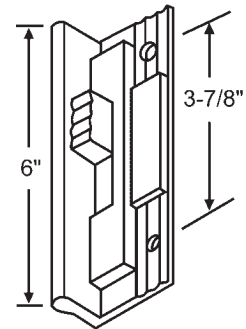

900-49

Interior Handle
Aluminum Finish

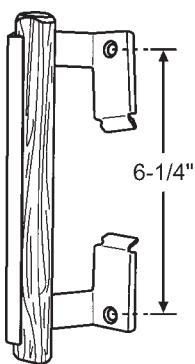

Part #	Finish
13-558	Black
13-558W	White

ADAMS RITE

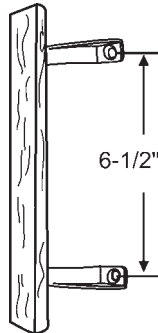

Part #	Finish
13-259	Chrome with Wood Handle
13-259B	Black with Wood Handle

Solid One Piece Bracket

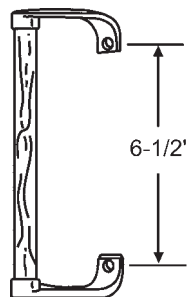

13-108B

Wood with Black Brackets
CROSSLY

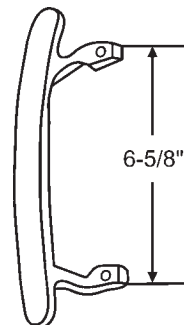

Part #	Finish
13-105	Chrome
13-105B	Black
13-105W	White

Die Cast

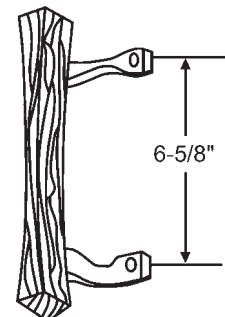

Part #	Finish
13-109	Chrome with Wood Handle
13-109B	Black with Wood Handle
13-109W	White with Wood Handle

HANDLES FOR PATIO DOORS

In Order by Hole Spacing

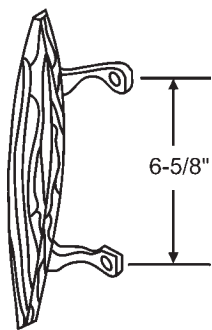

Part #	Finish
13-115	Chrome with Wood Handle
13-115B	Black with Wood Handle

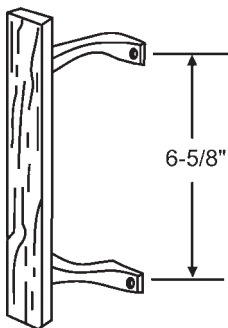

Part #	Finish
13-232	Chrome with Wood Handle
13-232B	Black with Wood Handle

Heavy Duty Brackets
CAPITOL

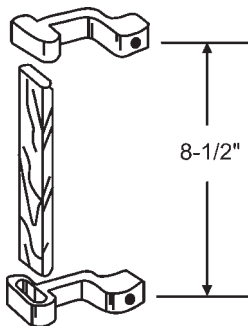

13-190B
Wood with Black Brackets
Use with 13-100 and 13-107
CAPITOL

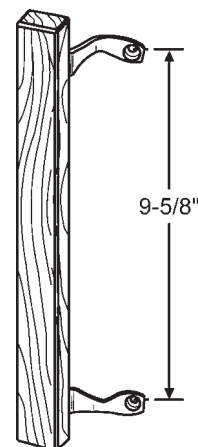

900-17542
Wood Handle w/ Chrome Bracket
2 Screws Included
TM PRODUCTS

HANDLE BRACKETS

HANDLE SCREWS

HANDLE SETS FOR PATIO DOORS

In Order by Style and Hole Spacing

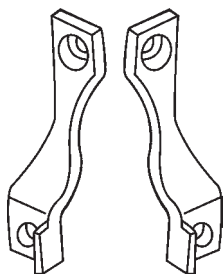

Part #	Finish
16-125	Black
16-123	Chrome

Handle Brackets Sold in Pairs
Used with 13-109, 13-115



Part #	Length	Finish
20-005	7/8"	Chrome
20-006	1"	Chrome
20-006B	1"	Black
20-006W	1"	White
20-007	1-1/8"	Chrome

10-32 Chrome Plated
Oval Head Screw

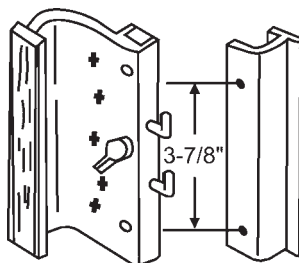

Part #	Finish
13-153	Aluminum
13-153B	Black

ADOR HI-LITE

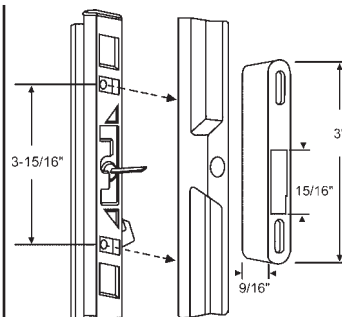

900-13021
Handle Assembly with Keeper
Uses 900-9169 Mortise Lock
PENNCO

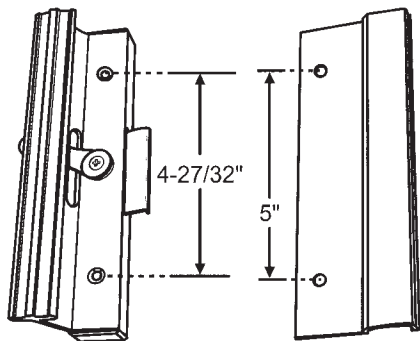

Part #	Finish
13-622AL	Aluminum
13-622B	Black

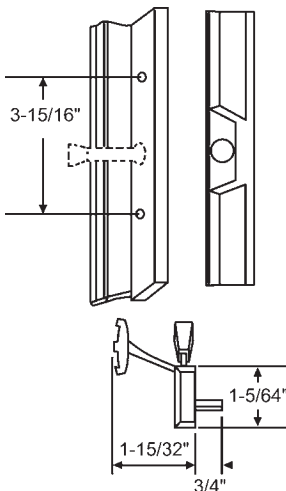

Part #	Description	Finish
900-21409W	No Key	White
900-21409B	No Key	Black
900-21409WK	With Key	White

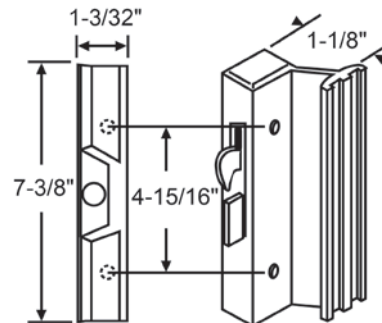

Part #	Finish
13-152	Aluminum
13-152B	Black
13-152W	White

Includes Fit-All Keeper Assy., Screws and
Black Outside Pull

PATIO DOOR HARDWARE

HANDLE SETS FOR PATIO DOORS

In Order by Style and Hole Spacing

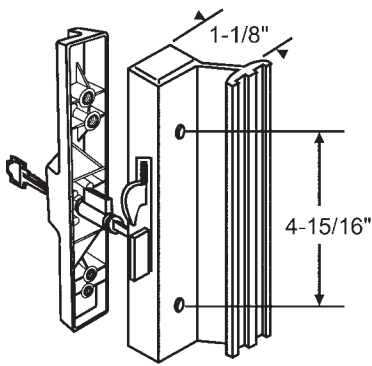

Part #	Finish
13-152K	Aluminum
13-152BK	Black

Includes Fit-All Keeper Assy., Screws and Black Outside Pull with Key Cylinder

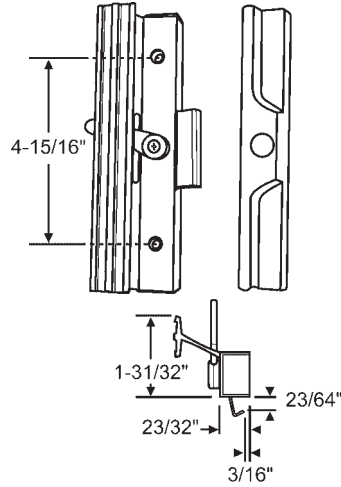

Part #	Finish
13-271	Black
13-271WH	White

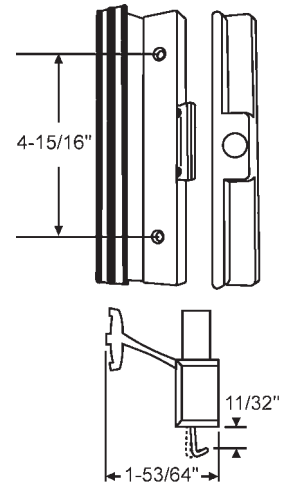

13-195W
White
No Longer Available.
Use: 13-271WH

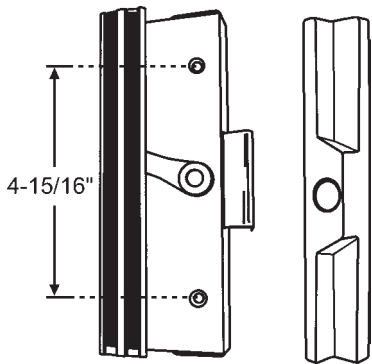

13-250B
Black. Surface Mount, Clamp Style

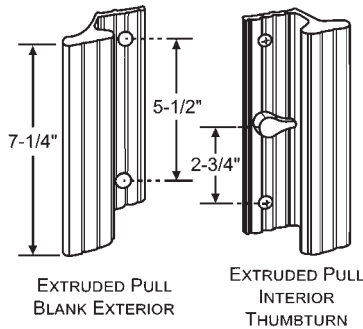

Part #	Finish
13-541	Aluminum Anodized
13-541BZ	Bronze Anodized

Extruded
KAWNEER

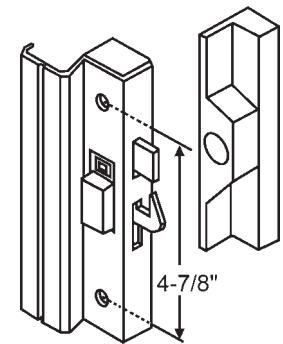

13-255
Black
PEACHTREE/CITATION

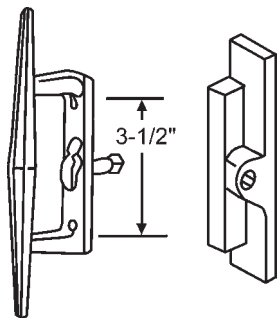

13-106
Original Acorn Metal Handle Set
Base Plate Only: 900-8200
ACORN

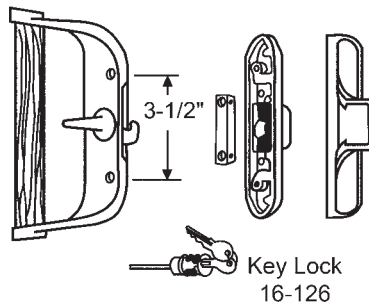

Part #	Description
13-188K	w/Key Lock
13-188	No Key Lock

Gray

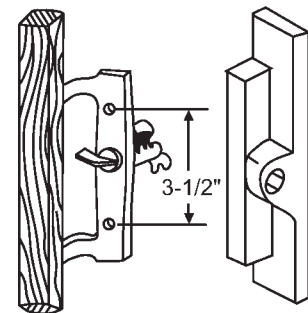

Handle Set without Key Cylinder

Part #	Finish
13-106X	Black
13-106WX	White

Handle Set with Key Cylinder

Part #	Finish
13-106KX	Black
13-106WK	White

Both Sets Include Keeper and Two Sets of Screws

ACORN REPLACEMENT

HANDLE SETS FOR PATIO DOORS

In Order by Style and Hole Spacing

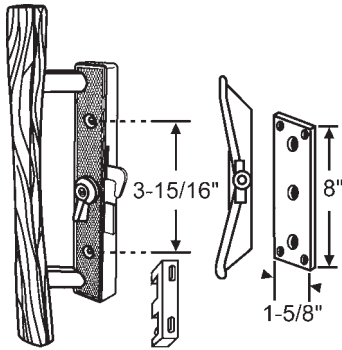

Handle Set with Plate

Part #	Finish
13-112	Aluminum with Wood Handle

Handle Set without Plate

Part #	Finish
13-112X	Aluminum with Wood Handle

Handle Set with Plate and 16-126 Key

Part #	Finish
13-113	Aluminum with Wood Handle

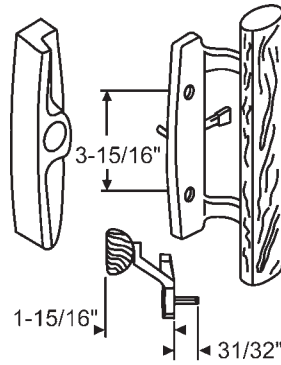

Handle Set without Key Cylinder

Part #	Finish
13-154	Black
13-154W	White
13-154-8	Chestnut Bronze
13-154A	Almond

Handle Set with Key Cylinder

Part #	Finish
13-154K	Black
13-154WK	White

Metal with Wood Handle
SASH CONTROLS

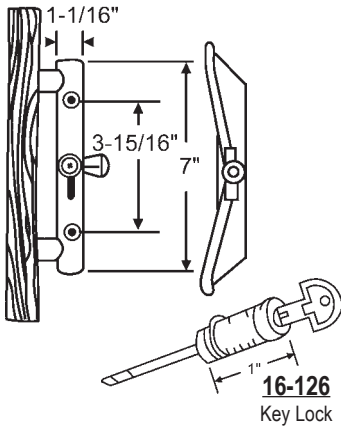

Handle Set with Key Lock

Part #	Finish
13-101	Aluminum w/Brown Handle

Handle Set without Key Lock

Part #	Finish
13-114	Aluminum w/Brown Handle

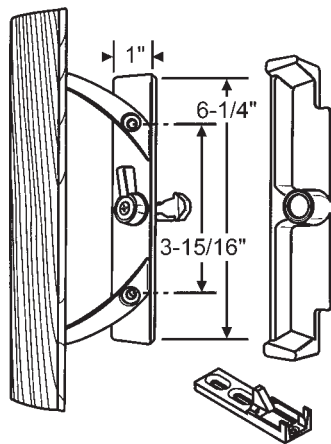

13-452B

Black. Set Includes Short Latch Bolt,
900-9332 Keeper & Screws. Long Latch Bolt Sold
Separately: #16-890
WELLS

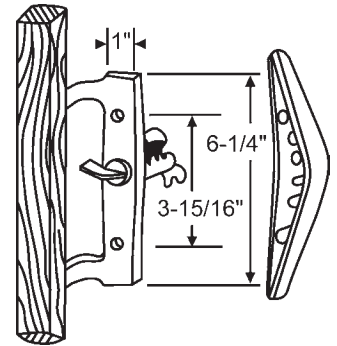

Part #	Finish	Description
13-104	Aluminum	No Key
13-104K	Aluminum	w/Key
13-141	Black	No Key

with 12-240 Keeper

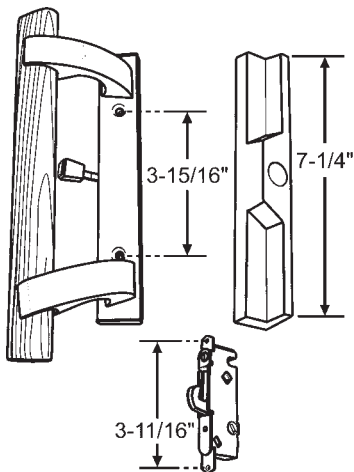

Part #	Description
13-261WH	Without Mortise Lock
13-261WHA	With Mortise Lock

White

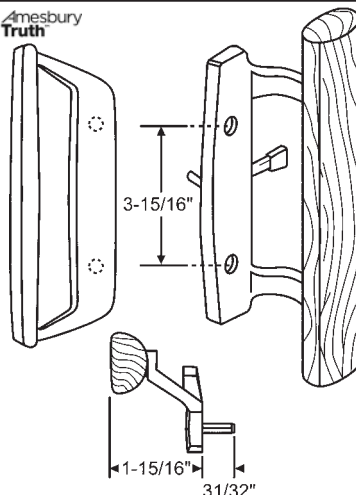

Part #	Finish
13-265BL	Black
13-265	White

No Key
SILVER LINE/JORDON

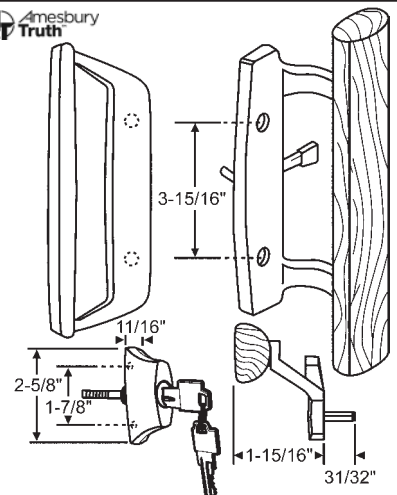

Part #	Finish
13-265BLK	Black
13-265K	White

With Key

PATIO DOOR HARDWARE

HANDLE SETS FOR PATIO DOORS

In Order by Style and Hole Spacing

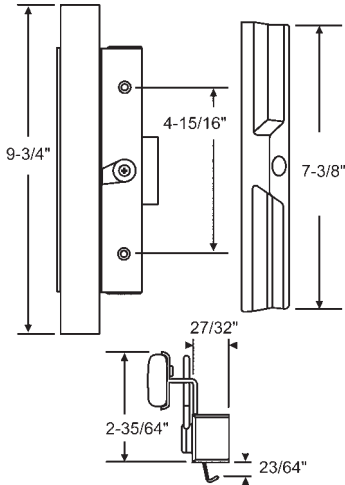

13-258

Black Finish. All Metal with Wood Handle
ROLLYSON

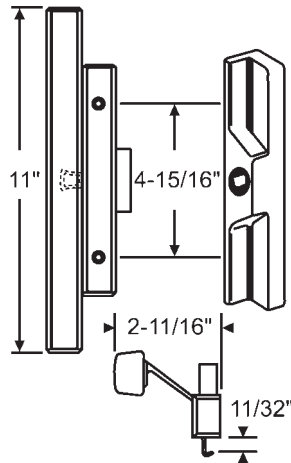

900-11414

Black with Wood Handle. Black Outside Pull
TRACO

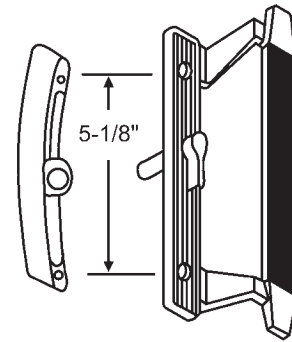

13-173

Gray Finish. 13-194 Outside Pull Only
HOWARD

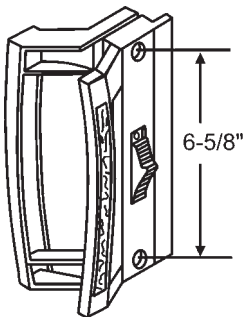

900-16317

Black. Includes Keeper and Screws
NORANDEX

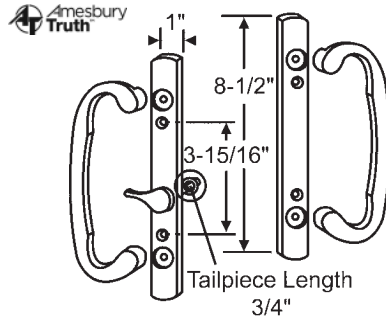

Part #	Finish
13-245AD	Almond
13-245BP	Brass Plated
13-245BC	Brushed Chrome
13-245W	White
13-245B	Black
13-245BZ	Bronze
13-245AB	Antique Brass

Offset Latch. 2265 Stamped on Back of Plate. Mortise Lock Sold Separately
SASH CONTROLS

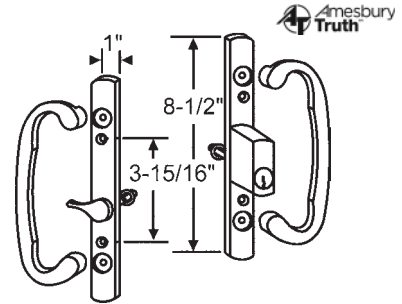

Part #	Finish
13-245ADK	Almond
13-245BPK	Brass Plated
13-245BCK	Brushed Chrome
13-245WK	White
13-245BK	Black
13-245BZK	Bronze
13-245ABK	Antique Brass

Offset Latch. 2265 Stamped on Back of Plate. Mortise Lock Sold Separately
SASH CONTROLS

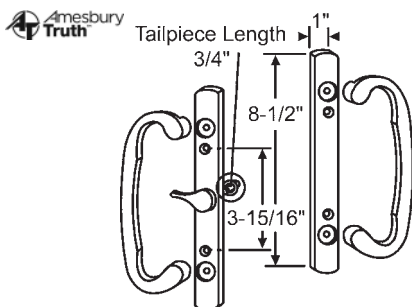

Part #	Finish
13-291	White
13-291B	Black

White. No Key. Center Latch. 2265 Stamped on Back of Plate. Mortise Lock Sold Separately
SASH CONTROLS

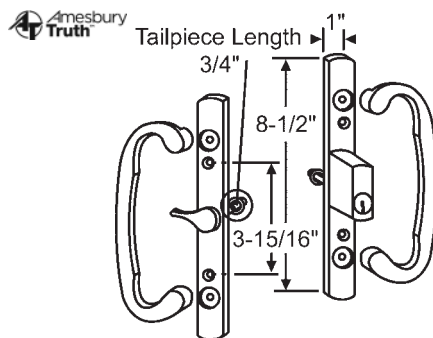

13-291K

White. With Key. Center Latch
2265 Stamped on Back of Plate
Mortise Lock Sold Separately
SASH CONTROLS

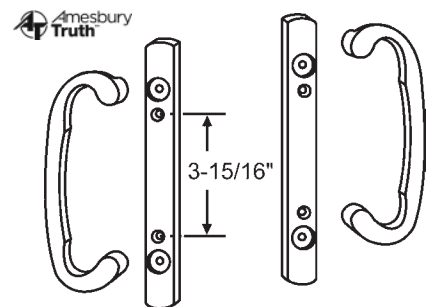

Part #	Finish
13-284DAB	Zinc-Antique Brass
13-284DBC	Zinc-Brushed Chrome
13-284DW	Zinc White

Dummy Set. Mortise Lock Sold Separately
SASH CONTROLS

HANDLE SETS FOR PATIO DOORS

In Order by Style and Hole Spacing

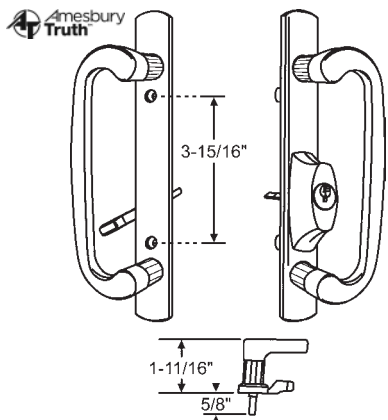

Part #	Description
13-295-10K	Offset Latch w/Key Lock

Black

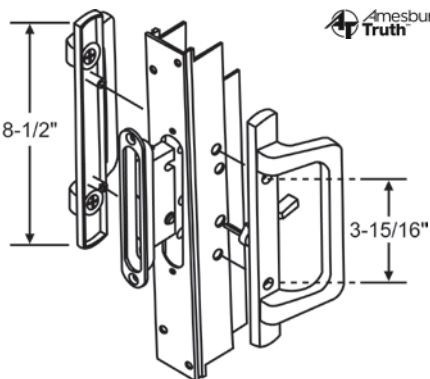

Part #	Finish
13-423-3	White
13-423-8	Bronze

For Active Door

PGT

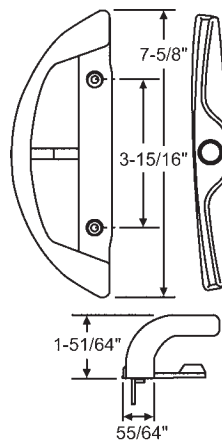

13-485SHW

Shield White. Center or Offset Latch
(Alternate Lever Location)

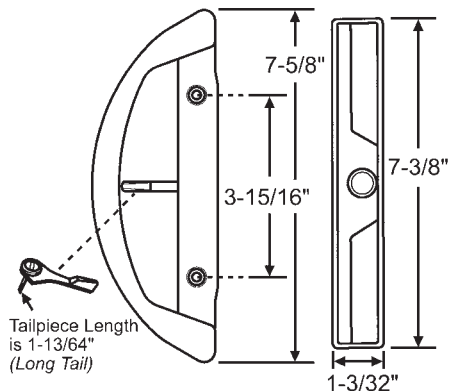

13-518W

White. No Key. Pack with Assorted Screws to Fit Doors
1-1/2" to 2" Thick

OMEGA

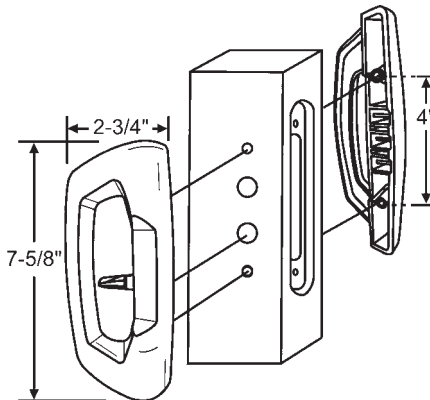

13-278X

White
Molded Polymer

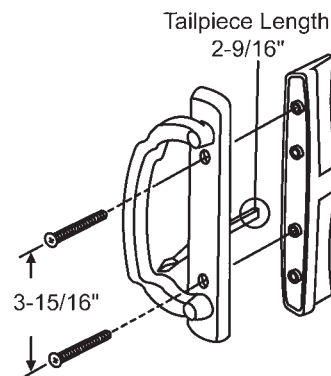

13-280

White
ACORN

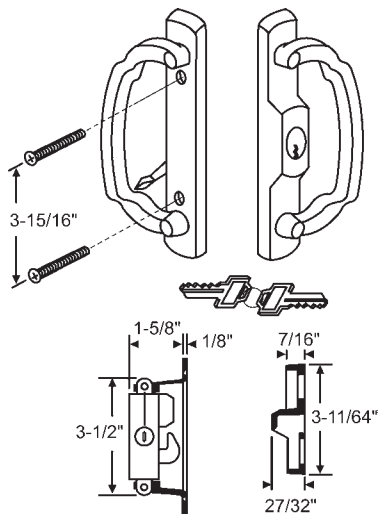

13-296PBKA

Solid brass in a polished lacquered finish with key combination mortise lock, keeper and all necessary screws.

PEACHTREE/PRADO

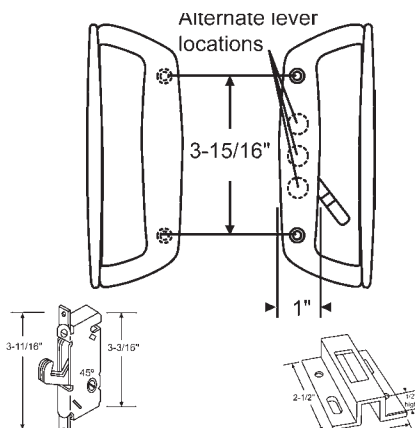

16-175

Mortise Lock

12-299W

Keeper

Part #	Finish
900-21630	White
900-21630B	Black

AMERICAN WEATHERSEAL

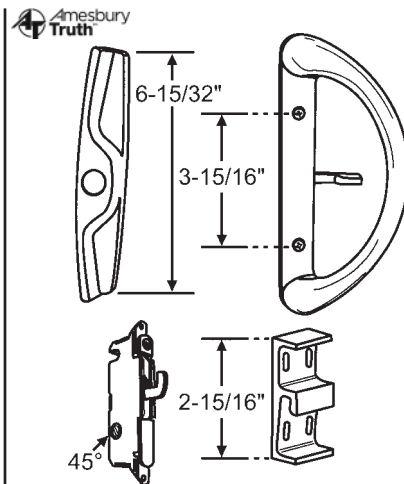

13-328-46

.750 Lever. Appliance White. Complete with Mortise Lock & Keeper, Lever and Screws. For Handle Only 13-328-46X

PATIO DOOR HARDWARE

HANDLE SETS FOR PATIO DOORS

In Order by Style and Hole Spacing

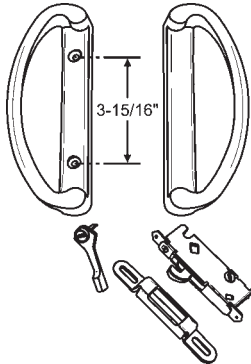

Part #	Finish
13-533B	Black
13-533W	White

LAWSON

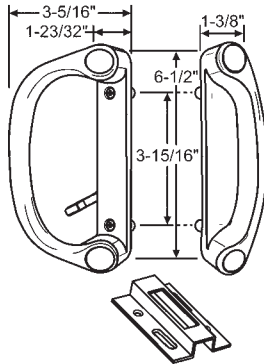

13-508W
White
SILVER LINE

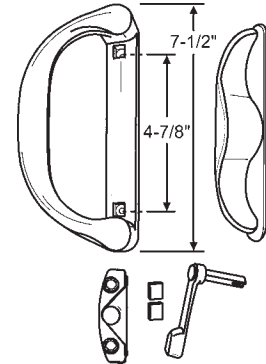

Part #	Finish
13-555W	White
13-555BZ	Bronze
13-555SV	Silver

White. Non-Locking Handle Kit
RC ALUMINUM

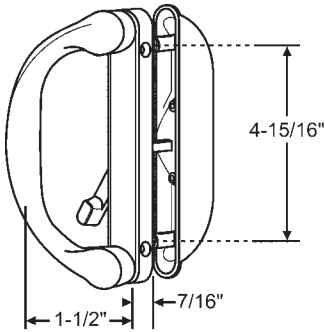

Handle Set without Key Cylinder

Part #	Finish
13-473W	White (Shown)
13-473BZ	Bronze
13-473B	Black
13-473SV	Silver

Handle Set with Key Cylinder

Part #	Finish
13-473WK	White
13-473BZK	Bronze
13-473BK	Black
13-473SVK	Silver

ESW/GENERAL IMPACT/MILGARD

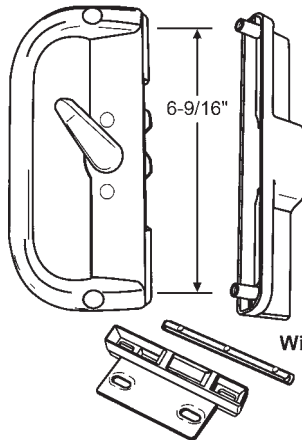

With Key

Part #	Finish
13-384BK	Black
13-384WK	White

With Keeper and Key, Double Cam
TRACO/THREE RIVERS

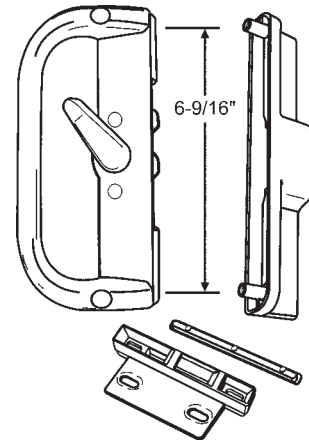

Part #	Finish
13-384B	Black
13-384W	White

With Keeper, No Key, Double Cam
TRACO/THREE RIVERS

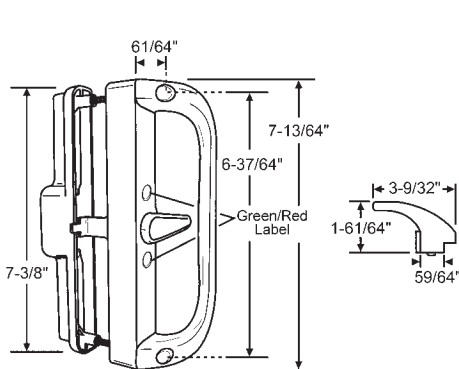

13-526W

White
ROYAL DIVA

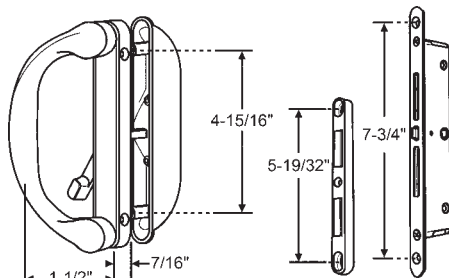

Handle Set without Key Cylinder

Part #	Finish
13-393W	White

Handle Set with Key Cylinder

Part #	Finish
13-393WK	White

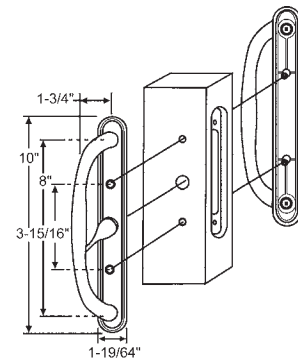

Part #	Finish
13-430W	White
13-430B	Black

Center Latch. No Key

HANDLE SETS FOR PATIO DOORS

In Order by Style and Hole Spacing

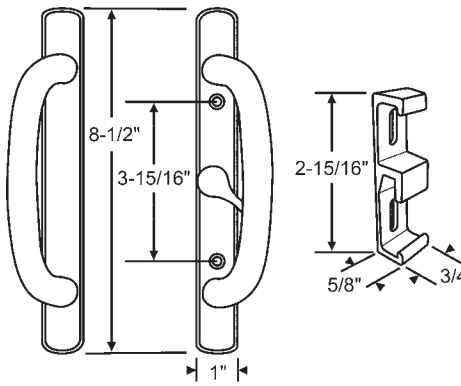

13-598W
Center Latch, White
with Keeper

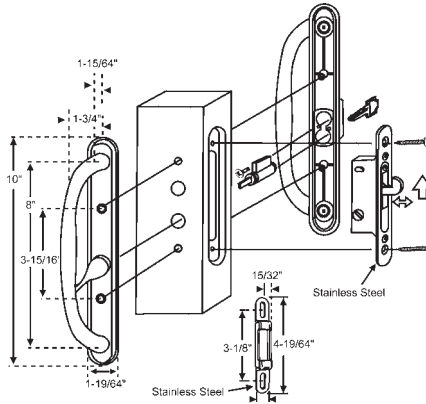

Part #	Finish
13-341BKA	Black
13-341WKA	White

w/Key, Mortise Lock & Keeper
Offset Latch

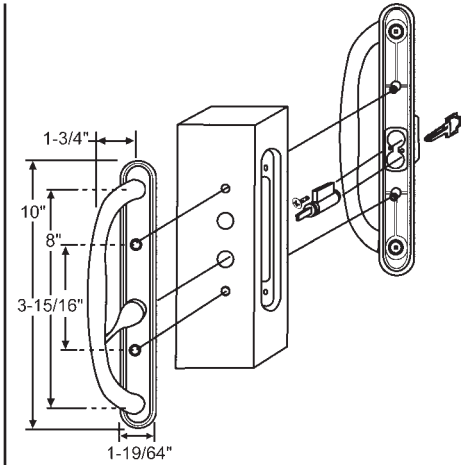

Part #	Finish
13-341WK	White

w/Key, No Mortise Lock & Keeper
Offset Latch

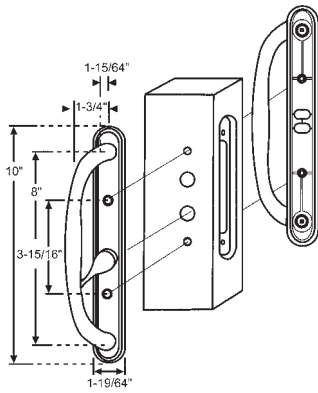

Part #	Finish
13-341W	White
13-341B	Black
13-341BC	Brushed Chrome

No Key, No Mortise Lock & Keeper.
Offset Latch

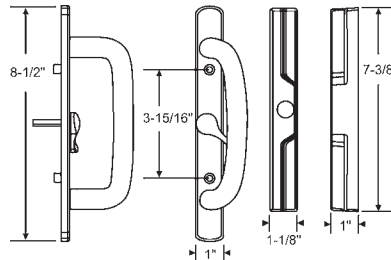

Part #	Description
13-499WA	Includes Mortise Lock
13-499W	No Mortise Lock

Center Latch, White. 1" Inside Plate Width

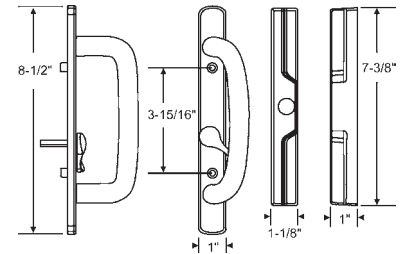

Part #	Description	Hand
13-441RHWA	Includes Mortise Lock	RH (shown)
13-441RHW	No Mortise Lock	RH (shown)
13-441LHWA	Includes Mortise Lock	LH
13-441LHW	No Mortise Lock	LH

Offset Latch, White. 1" Inside Plate Width.

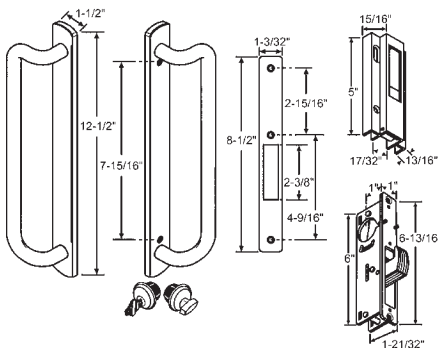

Part #	Finish
13-489WKA	White
13-489MADKA	Almond

Keyed Handle Set
PGT 5400 SERIES

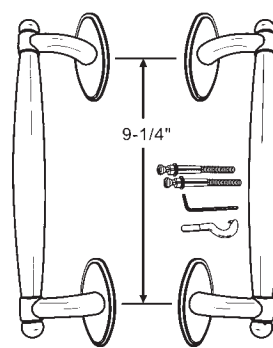

Part Number	Finish
13-646BZ	Bronze
13-646CC	Cream
13-646W	White

WINDOOR

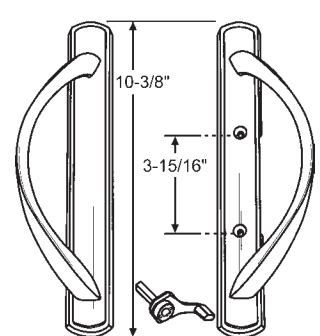

Part #	Finish
13-645B	Bronze
13-645CC	Cream
13-645W	White

WINDOOR

PATIO DOOR HARDWARE

HANDLE SETS FOR PATIO DOORS

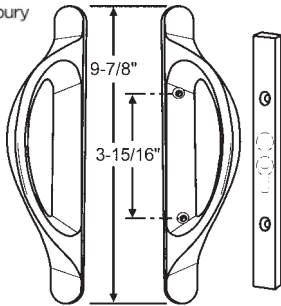

13-372-3
White

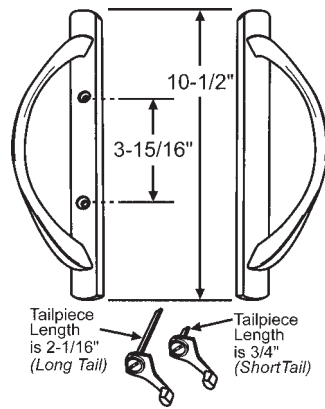

Handle Set with Key Lock

Part #	Finish
13-588WK	White

Handle Set without Key Lock

Part #	Finish
13-588W	White

Other Finishes Available. Contact Account Manager for Details.

SLIDING DOOR INNER GEAR



850-8785527

Inner Gear for Old Style FUHR Sliding Door.
See Page 369 for Old FUHR Handle Set

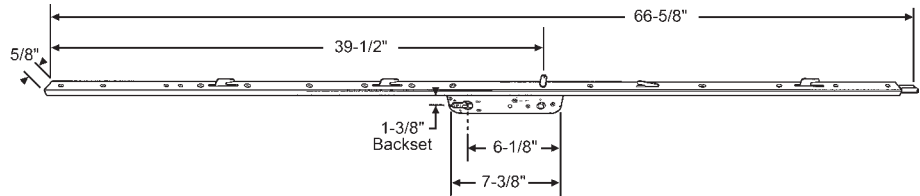

SLIDING DOOR TRIM SETS

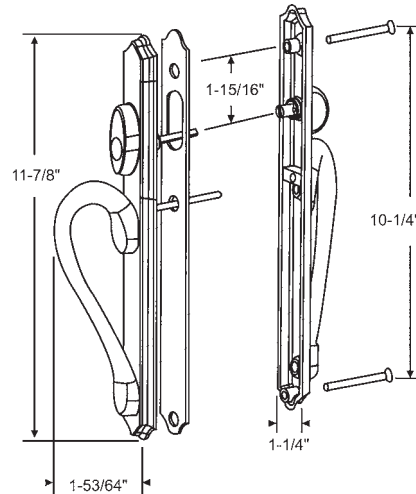

*Used by Marvin Integrity,
Comfort Line, Therma Tru,
Kolbe & Kolbe*

Solid Brass Sliding Door Trim Sets

Active - Thumb Turn w/Key

For 1.7" Door	
Part #	Finish
13-342AB	Antique Brass
13-342BC	Brushed Chrome
13-342BRS	PVD Brass
13-342CH	Chrome

For 2.0" Door	
Part #	Finish
13-345AB	Antique Brass
13-345B	Black
13-345BC	Brushed Chrome
13-345BRS	PVD Brass
13-345CH	Chrome
13-345ORBZ	Oil Rubbed Bronze
13-345P	Pewter
13-345PB	Polished Brass
13-345SCH	Satin Chrome
13-345SNK	PVD Satin Nickel

Active - Thumb Turn No Key

For 1.7" Door	
Part #	Finish
13-343AB	Antique Brass
13-343PB	Polished Brass
13-343ORBZ	Oil Rubbed Bronze
13-343CH	Chrome
13-343BC	Brushed Chrome
13-343SCH	Satin Chrome
13-343P	Pewter
13-343B	Black
13-343BRS	PVD Brass
13-343SNK	PVD Satin Nickel

Passive - No Thumb Turn, No Key

For 1.7" Door	
Part #	Finish
13-344PB	Polished Brass
13-344ORBZ	Oil Rubbed Bronze
13-344CH	Chrome
13-344BC	Brushed Chrome
13-344SCH	Satin Chrome
13-344P	Pewter
13-344AB	Antique Brass
13-344AD	Almond
13-344B	Black
13-344W	White
13-344BRS	PVD Brass
13-344SNK	PVD Satin Nickel

Zinc Die Cast Sliding Door Trim Sets

Active - Thumb Turn w/Key

For 1.7" Door	
Part #	Finish
13-346B	Black
13-346W	White

Active (Shown) - Thumb Turn No Key

For 1.7" Door	
Part #	Finish
13-347B	Black
13-347W	White

Passive - No Thumb Turn, No Key

For 1.7" Door	
Part #	Finish
13-348B	Black
13-348W	White

OLD STYLE FUHR SLIDING DOOR QUESTIONNAIRE

This form is for an Old FUHR **Sliding** Door Multi-Point System.

NOTE: There are only a few systems available to replace the old FUHR Sliding Door Multi-Point Locks. Please fill out the questionnaire and a sales representative will contact you with part numbers and availability.

Customer Name: _____ Account Number _____

Contact: _____ Phone Number _____

- BACKSET:** What is the distance from the edge of the door back to the center of the keyway or thumbturn?
 1-1/8" (28mm) 1-3/8" (35mm)
- HANDLE HEIGHT FROM CENTER OF HANDLE SHAFT TO BOTTOM EDGE OF DOOR:** (36" Standard) _____
- FACE PLATE WIDTH (runs down edge of door):** 5/8" (16mm - Flat Rail System) 1-1/64" (26mm - U-Rail System)
- DOOR PANEL HEIGHT:** _____
- IS YOUR DOOR MANUAL OR AUTOMATIC:** Manual Automatic

Based on the above information, please review the following : _____

Sliding Door Handle Sets Fit FUHR Gear System for 1-3/4" Door Thickness.



392 Back Plate with 574 Handle
Right Hand Shown

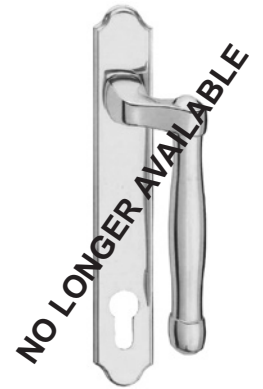
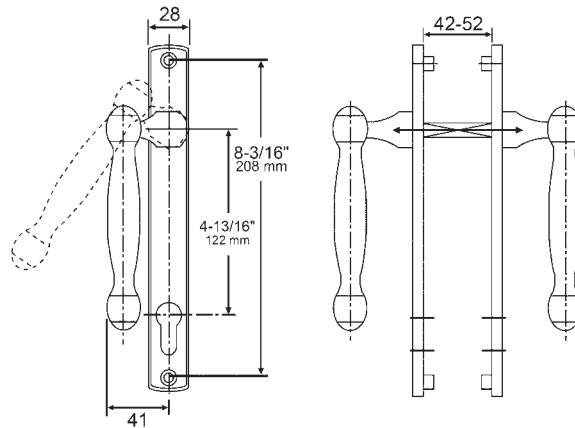

*374 Back Plate with 574 Handle
Right Hand Shown

Active with Cylinder			
	F71 Polished Brass	F41 Brushed Chrome	F79 Oil Rub Brass
392/574	850-8763255	850-8763287	850-8763303
Inactive with Thumb-turn			
392/574	850-8763259	850-8763291	850-8763299
Dummy Sets			
392/574	850-8764451	850-8773199	850-8764483

FAX THIS QUESTIONNAIRE TO: 610-534-3202 or 305-557-5239 (Florida)

NEW STYLE HOPPE HLS9000 SLIDING DOOR HARDWARE

NOTE: The New Style Hoppe Sliding Door Handle Sets take an American Pizette with a key cylinder and tailpiece.

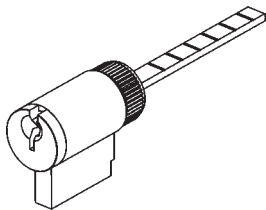

Part Number	Finish
850-2045860	Chrome Plated

Key Cylinder

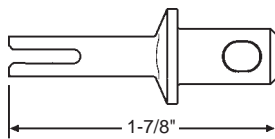

850-2061421

Thumbturn Shaft Coupling

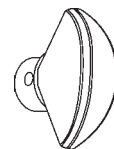

Crescent Knob



850-8779431

Cylinder Knob Set Screw

Part Number	Finish
850-2739116	F77-R Resista Brass
850-8780983	F73 Antique Brass
850-8780963	F41-R Brushed Chrome
850-2739183	F49-R Polished Chrome
850-8780991	F9010 White
850-2739108	F9714 Matte Black
850-2739175	F44-R Antique Nickel
850-8780951	F01 Silver
850-2739204	F8709 Rustic Umber

Individual cylinder knobs do not come with cylinder set screw.

PATIO DOOR HARDWARE

FLUSH SLIDING DOOR TRIM

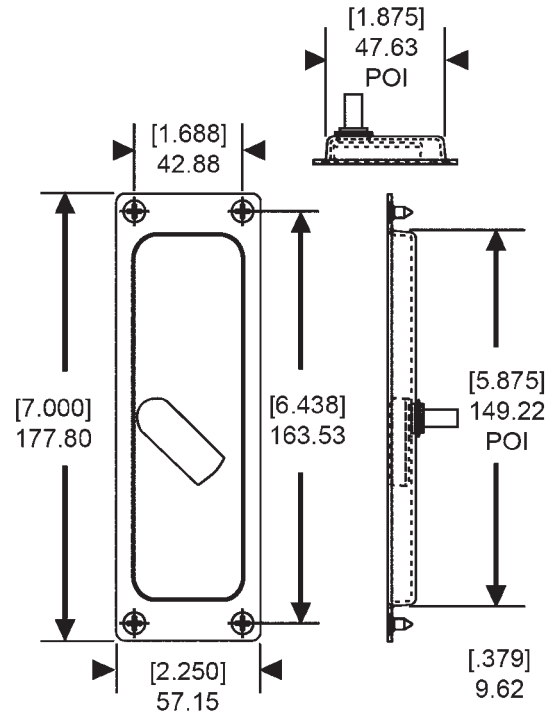
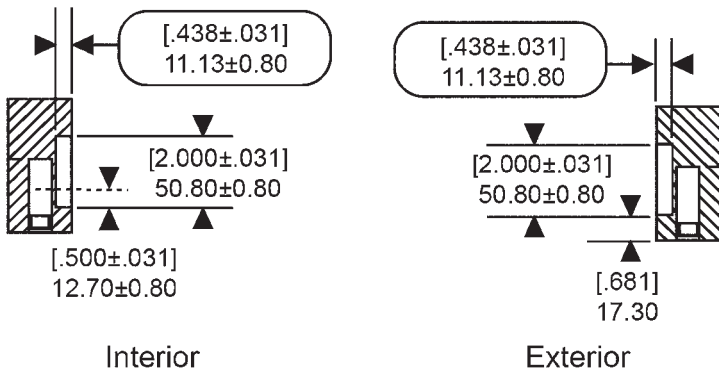
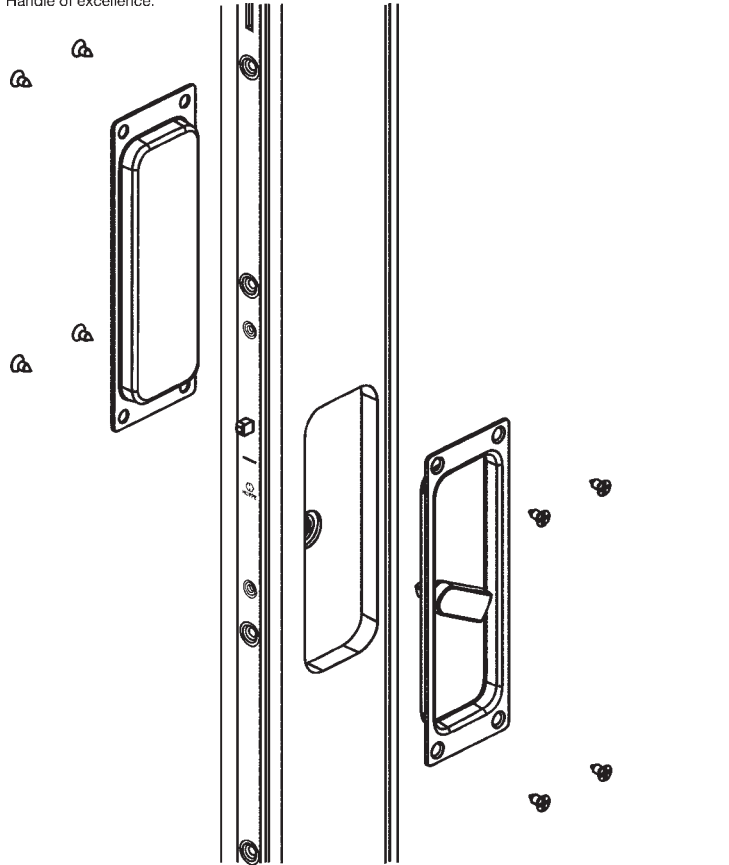

Features and Benefits

- Flush design is ideal for exterior multi-panel bypassing sliding doors and pocketing doors
- High quality bronze base material
- Ergonomic design
- Available in ORB Lacquer and Satin Nickel finishes
- Available as full or half sets
- Designed for HLS9000 Multipoint Sliding Door Lock
- For 1-3/4" doors and 2-1/4" doors

Description	ORB Lacquer	Satin Nickel
Full Trim for 1 3/4" thick door	850-3971769	850-3971806
Full Trim for 2 1/4" thick door	850-3971777	850-3971814
Interior Half Trim for 1 3/4" thick door	850-3971785	850-3971822
Interior Half Trim for 2 1/4" thick door	850-3971793	850-3971831
Exterior Half Trim	850-3972825	850-3972817



HOPPE® 

Handle of excellence.



Unlocked



Locked

HLS 9000 Features & Benefits

- Stainless Steel is highly corrosion resistant.
- Retractable hooks create a clean look on the door and jamb when open.
- Two point locking system allows for optimum locking point contact with the jamb to assure passing the most stringent forced entry testing.
- Mishandling device prevents retractable hooks from accidentally firing and potentially damaging the hardware, door or frame.
- Manual lock operation eliminates inadvertent locking of the door.
- Limited Lifetime Mechanical Warranty.
- Available in 30 mm & 35 mm backset.
- Full-length faceplate available to cover continuous.
- Faceplate with radius at top and bottom available for simplified door edge preparation on tall doors.
- Easily adjustable strikes help solve the problem of door panel movement or settling of the house.
- Exceeds the current 100,000 operational cycle testing requirements.



**3,000 hours Salt Spray Test
Stainless Steel**

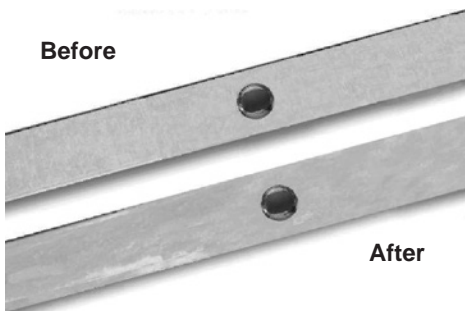

Sliding Door Trim Features & Benefits

- Solid brass forged handles and backplates.
- Single design theme means corresponding finishes and styles for both sliding and hinged doors.
- Spring assist for easy locking of the system.
- Locked or unlocked status of the door can be easily seen from a distance due to 90 degree cylinder operation.
- Matching dummy trim available for passive panel door.
- Resista® finishes have a Limited Lifetime Finish Warranty.

Gear

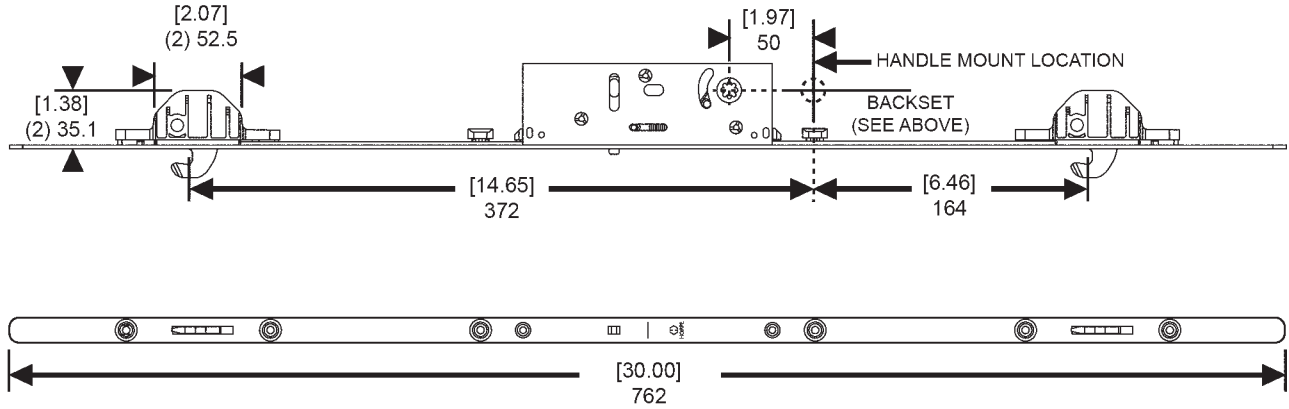

16mm Faceplate Gear

Description	Part Number
30mm backset gear	850-2082775
35mm backset gear	850-2082783

20mm Faceplate Gear

Description	Part Number
30mm backset gear	850-2184018
35mm backset gear	850-2184000

Strike

Strike Plate
850-2050440

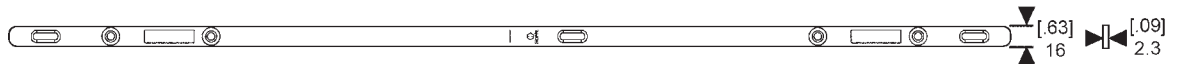

Strike Plate
850-2322724

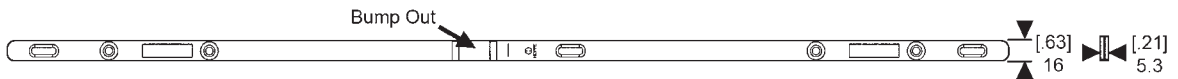

Strike Plate
850-2469662

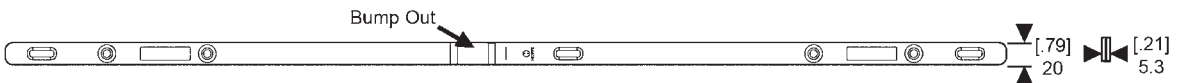

Strike Plate
850-2290401

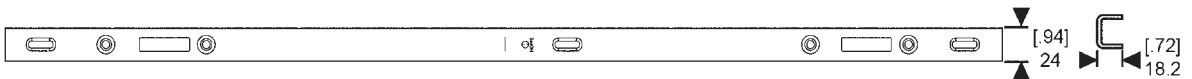

16mm Strike

Description	Part Number
Strike 16mm	850-2050440
Strike 16mm	850-2322724

20mm Strike

Description	Part Number
Strike 20mm	850-2469662
U-Rail Strike	850-2290401

SLIDING DOOR HANDLES



Handle of excellence.

M151VK/2165N

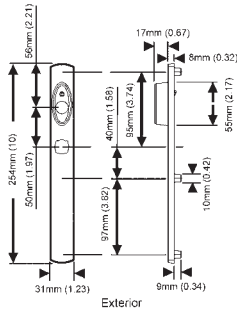
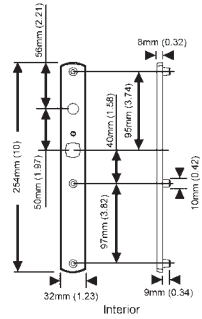
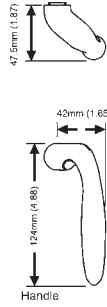
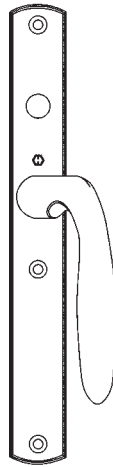

M151VK/M2165N	Resista® Brass	Antique Brass	Brushed Chrome	Polished Chrome	White	Matte Black	Satin Nickel	Antique Nickel	Oil Rubbed Brass	Rustic Umber
Active with Cylinder	850-2081959	850-2081967	850-2081975	850-2081983	850-2081991	850-2082003	850-2082011	850-2082020	850-2082038	850-2083743
Active without Cylinder	850-2082492	850-2082505	850-2082513	850-2082521	850-2082530	850-2082548	850-2082556	850-2082564	850-2082572	850-2083807
Dummy Pair	850-2082927	850-2082935	850-2082943	850-2082951	850-2082960	850-2082978	850-2082986	850-2082994	850-2083006	850-2165757



Handle of excellence.

M151VK/M2170

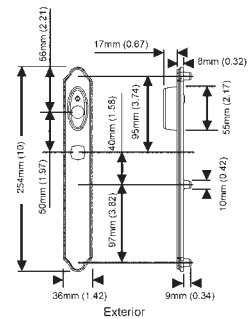
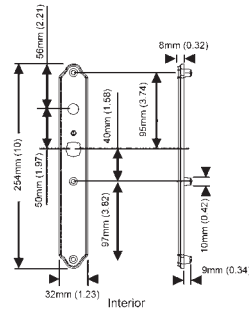
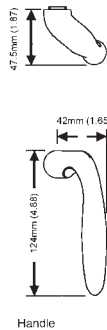
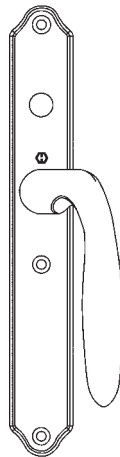

M151VK/M2170N	Resista® Brass	Antique Brass	Brushed Chrome	Polished Chrome	White	Matte Black	Satin Nickel	Antique Nickel	Oil Rubbed Brass	Rustic Umber
Active with Cylinder	850-2081684	850-2081692	850-2081705	850-2081713	850-2081721	850-2081730	850-2081748	850-2081756	850-2081764	850-2083735
Active without Cylinder	850-2082222	850-2082231	850-2082249	850-2082257	850-2082265	850-2082273	850-2082281	850-2082290	850-2082302	850-2083794
Dummy Pair	850-2082839	850-2082847	850-2082855	850-2082863	850-2082871	850-2082880	850-2082898	850-2082901	850-2082919	850-2165749

PATIO DOOR HARDWARE

SLIDING DOOR HANDLES



Handle of excellence.

M574/2165N

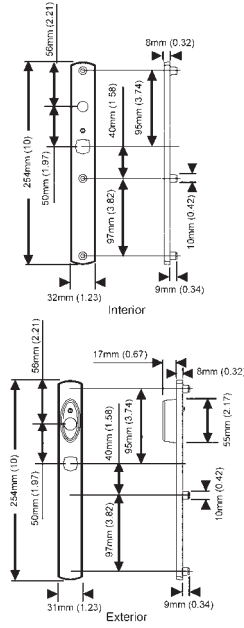
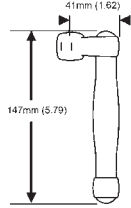
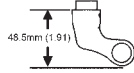
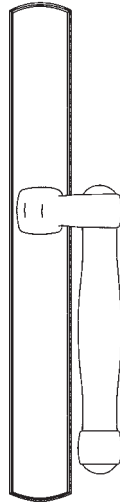

M574/M2165N	Resista® Brass	Antique Brass	Brushed Chrome	Polished Chrome	White	Matte Black	Satin Nickel	Antique Nickel	Oil Rubbed Brass	Rustic UMBER
Active with Cylinder	850-2082134	850-2082142	850-2082151	850-2082169	850-2082177	850-2082185	850-2082193	850-2082206	850-2082214	850-2083786
Active without Cylinder	850-2082679	850-2082687	850-2082695	850-2082708	850-2082716	850-2082724	850-2082732	850-2082741	850-2082759	850-2165731
Dummy Pair	850-2083284	850-2083292	850-2083305	850-2083313	850-2083321	850-2083330	850-2083348	850-2083356	850-2083364	850-2165790



Handle of excellence.

M574/M2170

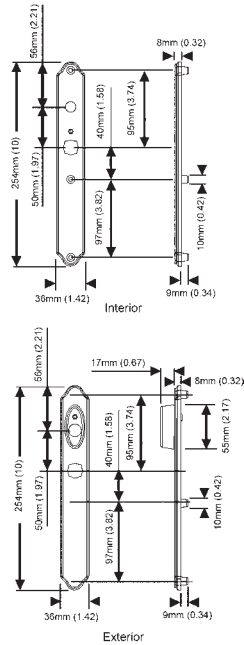
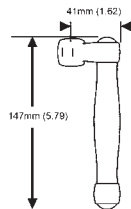
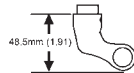
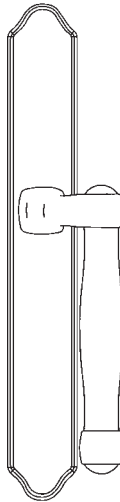

M574/M2165N	Resista® Brass	Antique Brass	Brushed Chrome	Polished Chrome	White	Matte Black	Satin Nickel	Antique Nickel	Oil Rubbed Brass	Rustic UMBER
Active with Cylinder	850-2081861	850-2081879	850-2081887	850-2081895	850-2081908	850-2081916	850-2081924	850-2081932	850-2081941	850-2083778
Active without Cylinder	850-2082409	850-2082417	850-2082425	850-2082433	850-2082441	850-2082450	850-2082468	850-2082476	850-2082484	850-2083831
Dummy Pair	850-2083196	850-2083209	850-2083217	850-2083225	850-2083233	850-2083241	850-2083250	850-2083268	850-2083276	850-2165781



DALLAS SERIES SLIDING DOOR HANDLE

FOR USE WITH HLS9000 MULTIPOINT LOCKING SYSTEM



Our new multipoint Dallas Series Sliding Door Handle features straight, modern lines providing the contemporary aesthetic you have been looking for.

Available in:

- Rustic Umber**
- Alpine Frost**
- Matte Black**



Alpine Frost Finish Shown

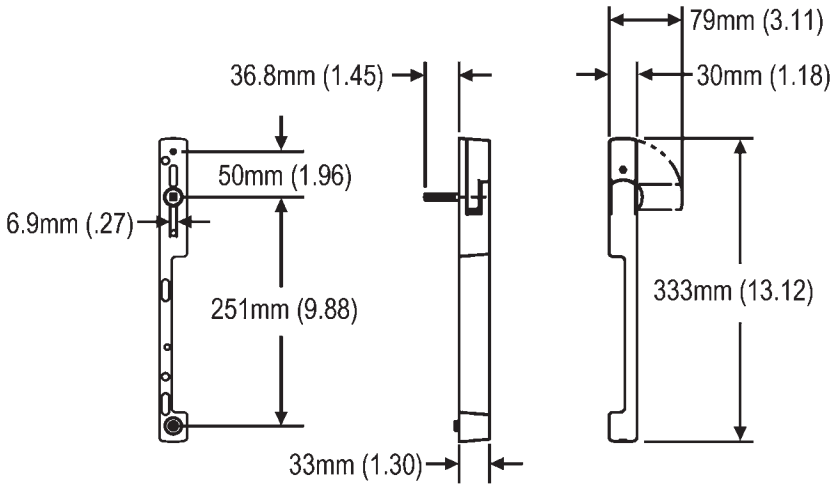

Door handing is determined when viewing from the exterior.
 LH/XO = sliding panel (X) left, fixed panel (O) right
 RH/OX = sliding panel (X) right, fixed panel (O) left

Handle Sets for 1-3/4" thick doors*	Alpine Frost	Rustic Umber	Matte Black
Non-Keyed LH/XO	850-11591754	850-11591766	850-11591778
Non-Keyed RH/OX	850-11591729	850-11591730	850-11591742
Keyed LH/XO	850-11591699	850-11591705	850-11591717
Keyed RH/OX	850-11591663	850-11591675	850-11591687
Dummy LH/XO	850-11591815	850-11591821	850-11591833
Dummy RH/OX	850-11591785	850-11591791	850-11591808

*Please contact your sales representative if your panels are thicker than 1-3/4"

PATIO DOOR HARDWARE

OUTSIDE HANDLE PULLS FOR PATIO DOORS

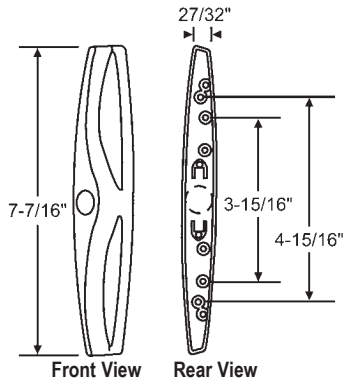

Part #	Finish
13-427B	Black
13-427W	White

Die Cast. No Cylinder Hole

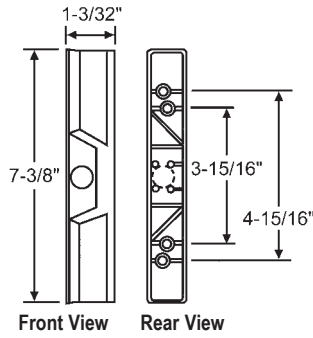

Part #	Description
900-8281	Black Plastic
900-8281M	Black Metal
900-8281MW	White Metal

Without Cylinder hole

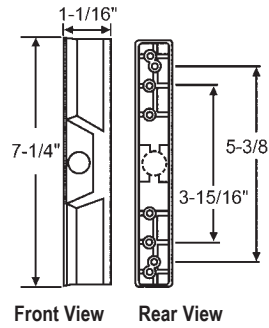

900-17370
Black
Without Cylinder Hole

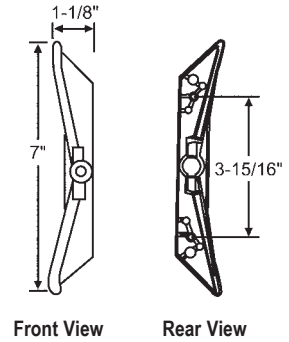

900-48
Aluminum
Die Cast

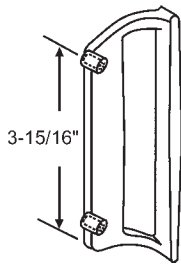

Part #	Finish
13-147	Aluminum
13-147W	White

Flush Mount Pull

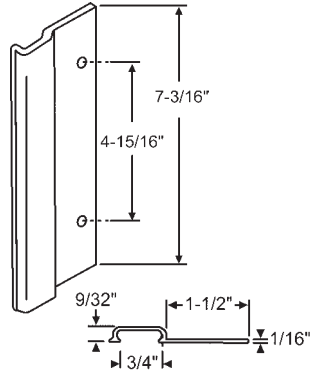

Part #	Finish
16-198	Aluminum

Outside Pull

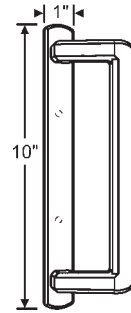

Part #	Finish
13-530B-E	Black
13-530W-E	White

Exterior Handle.

PGT

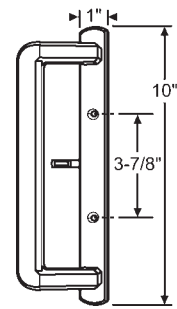

Part #	Finish
13-530B-I	Black
13-530W-I	White

Dummy Interior Handle.
Includes Actuator.

PGT

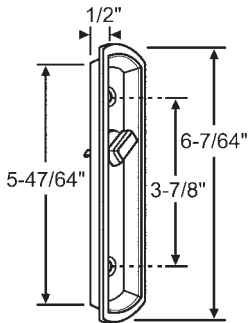

Part #	Finish
16-712BZ	Bronze
16-712SN	Satin Nickel
16-712W	White

Interior Recessed Handle with Thumbturn.

PGT

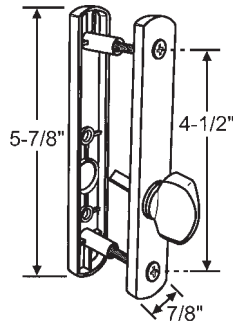

Part #	Finish
16-618BZ	Bronze
16-618SV	Silver
16-618W	White

Latch Assembly

PGT

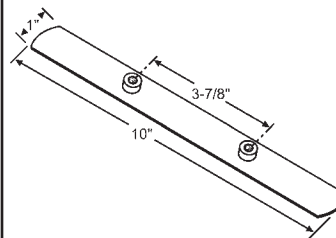

Part #	Finish
16-714BZ	Bronze
16-714B	Black
16-714W	White

Exterior Flush Plate Handle.

PGT

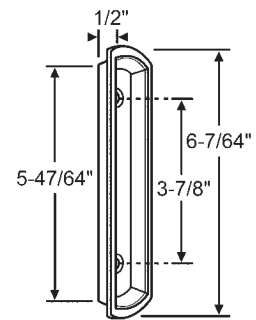

Part #	Finish
16-713BZ	Bronze
16-713SN	Satin Nickel
16-713W	White

Interior Recessed Handle Dummy.

PGT

HANDLES FOR PATIO SCREEN DOORS

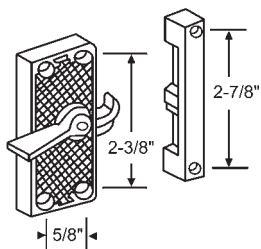

14-60

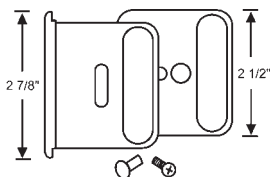

14-134
Black
PAN AM

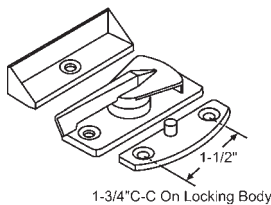

14-97
HOWARD

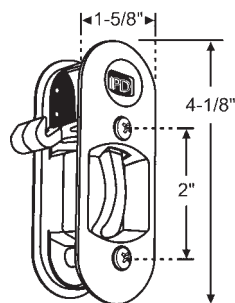

14-116
Almond
PEACHTREE

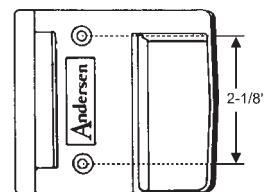

Part #	Finish
750-1997194	Stone
750-1997306	White

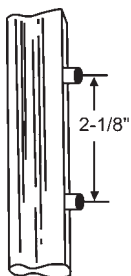

Part #	Finish
750-1997195	Stone
750-1997307	White

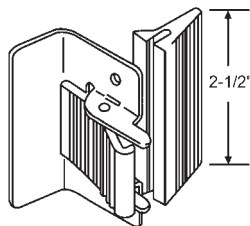

14-72

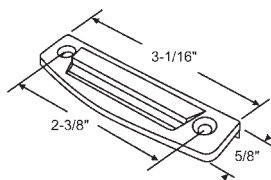

Part #	Finish
16-485B	Black
16-485W	White

Nylon Keeper

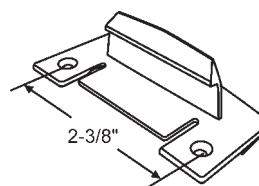

Part #	Finish
16-484B	Black
16-484W	White

Nylon Outside Handle

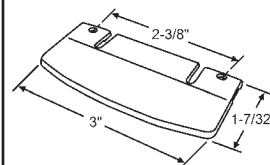

Part #	Finish
16-486B	Black
16-486W	White

Nylon Inside Handle

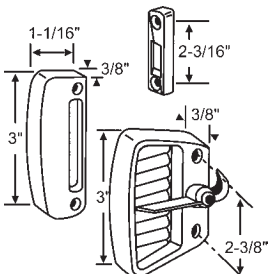

14-75B
Handle Assembly (3 pieces)
Black
TRACO

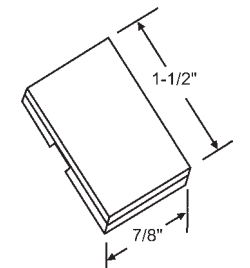

Part #	Finish
16-145	Clear
16-145B	Black

Nylon Latch Handles

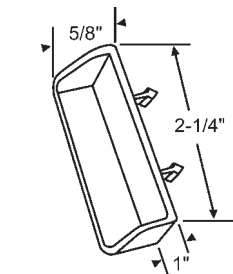

14-133
Black Screen Latch Handle
AMACOR

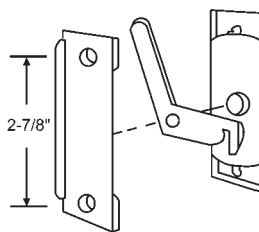

14-61
Handle Assembly with Latch
WALTERS

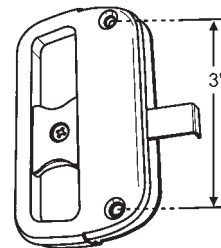

14-167B
Black

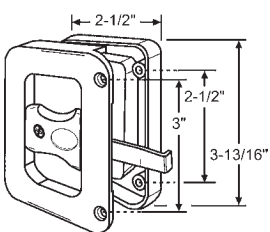

Part #	Finish
14-161	Black
14-161W	White

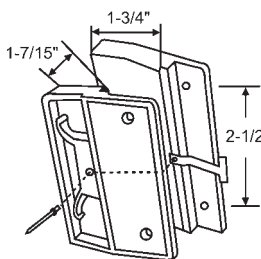

900-17710
Spring Loaded Black Plastic
RITE SCREEN/METAL INDUSTRIES

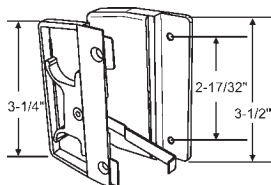

14-52
Black With Keeper and Screws
RITE SCREEN

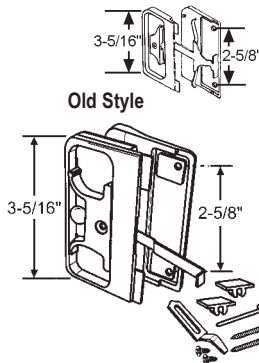

14-64
Black
METAL INDUSTRIES

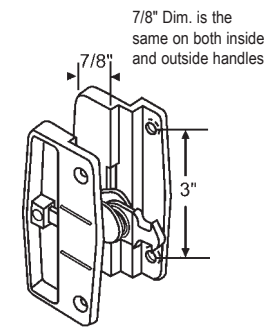

14-95
Handle Assembly
COLUMBIA

PATIO DOOR HARDWARE

HANDLES FOR PATIO SCREEN DOORS

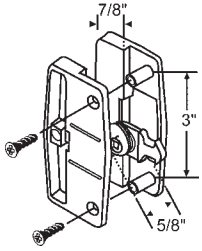

14-94
Black Nylon

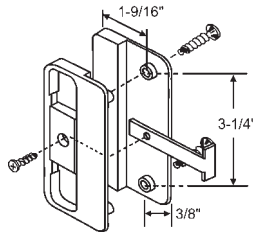

14-96
Handle Set. Black
JIM WALTERS

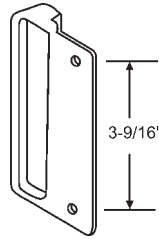

16-148
Black Plastic. Inside

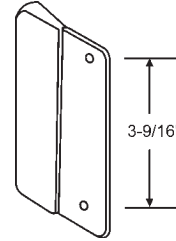

16-149
Black Plastic. Outside

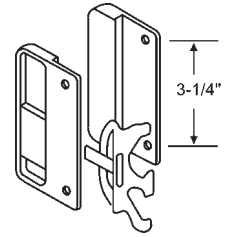

14-63
Handle Assembly
JIM WALTERS

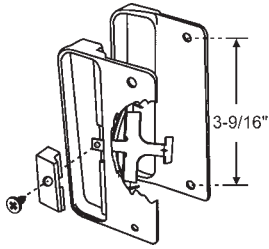

14-62
ACORN

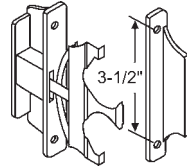

14-103
Black

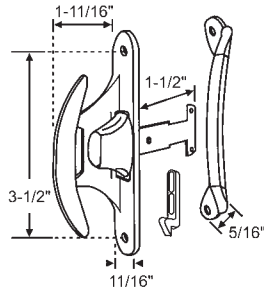

14-155A
Includes Keeper
BAYFORM

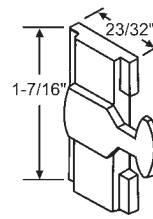

900-10783
Black
CROSSLY

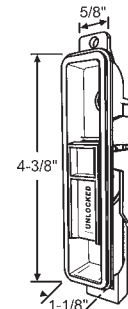

14-127
Plastic Flip Bolt Lever. Beige
PEACHTREE

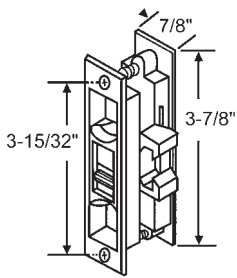

900-11214
Patio Screen Latch Assembly
Includes 12-308 Keeper
PEACHTREE

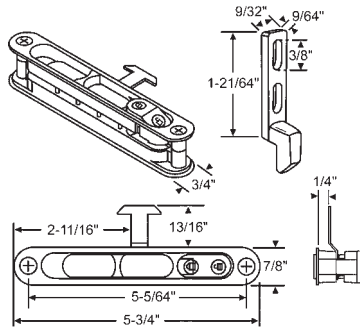

14-138
Screen Door Lock with Keeper. Black
RITE SCREEN

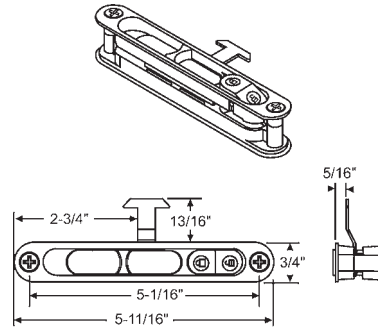

14-170B
Recessed Patio Door Screen Handle. Black
FLORIDA SCREEN REGAL SERIES

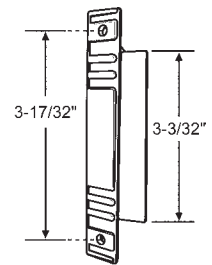

Part #	Finish
14-147W	White
14-147DT	Desert Tan

Inside Screen Pull Handle

LATCH ASSEMBLY

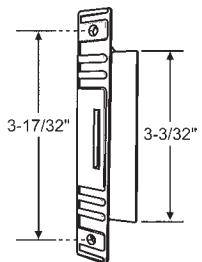

Part #	Finish
14-151BR	Brown
14-151B	Black

Inside Screen Pull Handle. Brown

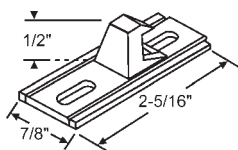

12-308
Black Plastic
PEACHTREE

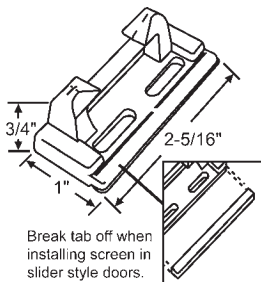

900-21646
Beige
PEACHTREE

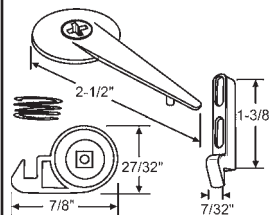

Part #	Description
14-54S	Latch Assembly w/ Spring & 12-256 Keeper
14-54	Latch Assembly Only

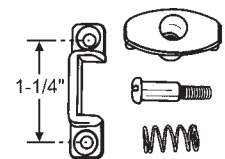

14-51
Latch Assembly
ACORN

LATCH ASSEMBLY

PATIO DOOR SCREW HOLE COVERS

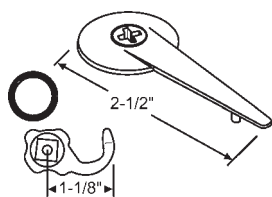

14-55
Latch Assembly

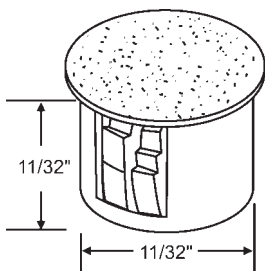

16-335
Large Cover
Black

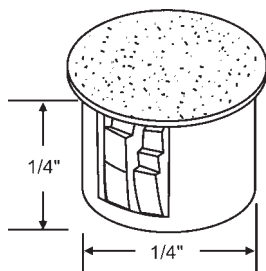

16-336
Small Cover
Black

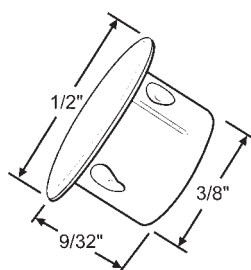

Part #	Finish
16-826BZ	Bronze
16-826W	White

PGT

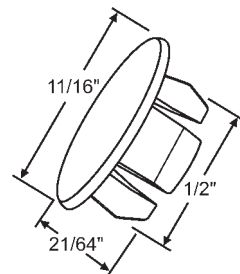

Part #	Finish
16-825BZ	Bronze
16-825W	White
16-825TN	Tan

PGT

SCREEN DOOR GUIDES

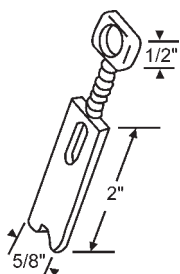

15-50
TUCKER

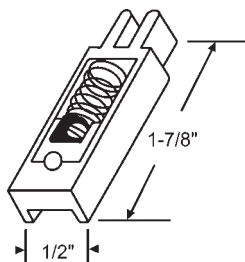

15-58
Nylon
DARYL

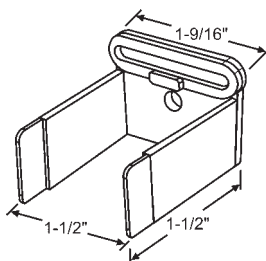

16-61
Black
ANDERSON

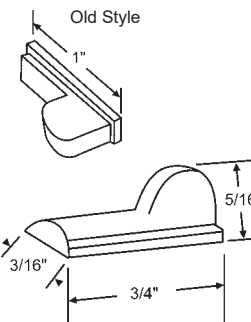

900-6902
CROSSLY/LUMIDOR

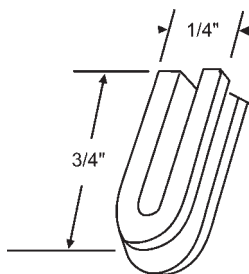

15-94
DARYL

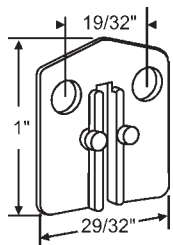

900-10073
Nylon
LAWSON/CROWN

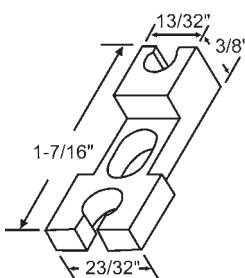

15-62
MILLER

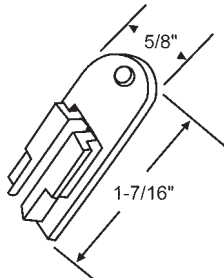

15-63

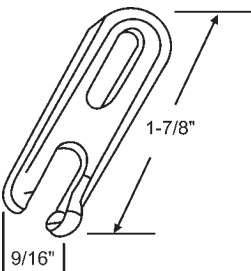

15-55
Screen Guide
CROSSLY

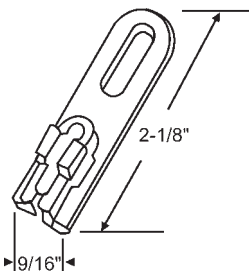

15-54

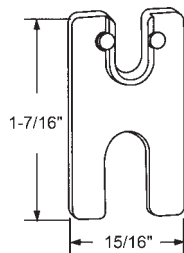

900-10074
Nylon
LAWSON/CROWN

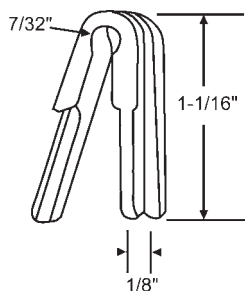

900-71
MILLER

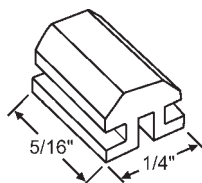

52-846
White
PAN AM/BINNINGS

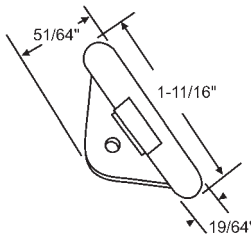

15-66
Nylon
ALCAN

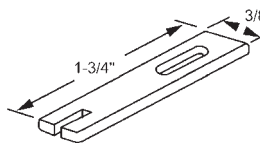

15-65
Nylon
BELLVIEW

PATIO DOOR HARDWARE

SCREEN DOOR GUIDES

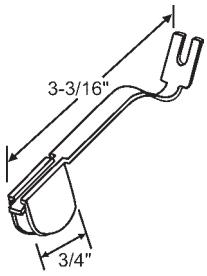

15-57
Nylon
ACORN



900-15649
TM PRODUCTS

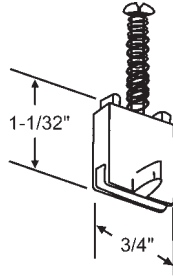

900-84
Bottom Guide
TUCKER

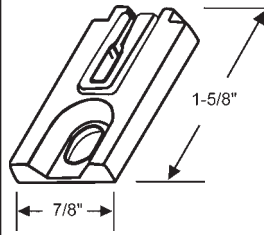

15-52
Top Guide
DARYL

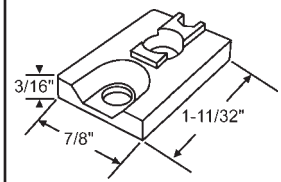

900-78
Bottom Guide
TUCKER

ROLLER ASSEMBLY

HEAD SPACER

BUG FLAPS

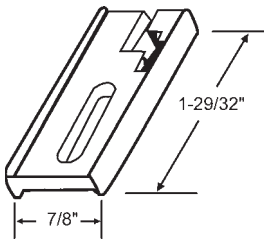

15-51
Bottom Guide
CROSSLY

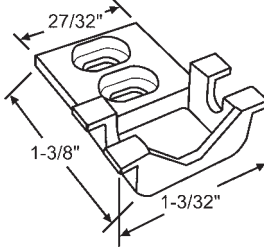

900-5987
Nylon Sliding Roller Housing.
Used with 900-10015 Roller

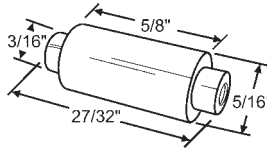

900-10015
Nylon Roller. Used with 900-5987
Housing

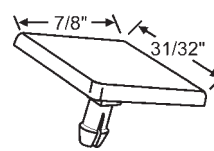

900-7236
Screen Head Spacer. Nylon

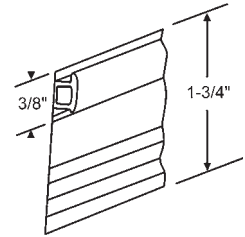

Part #	Length
16-243	50 ft.
16-243M	250 ft.

Can Be Torn Away in 3/16"
Increments. Black

FIXED PANEL BRACKET

FIXED PATIO DOOR CLIP

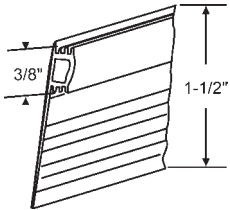

Part #	Length
16-244	50 ft.
16-244M	250 ft.

Can Be Torn Away in
1/8" Increments

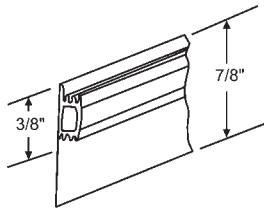

Part #	Length
16-245	50 ft.

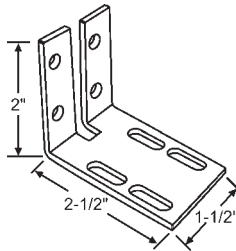

16-621
PGT

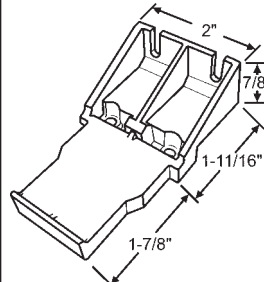

16-594LW
White Nylon Long Type
SILVER LINE

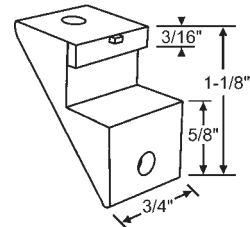

Part #	Finish
PDB 33 BR	Brown
PDB 33 WH	White

PATIO DOOR BUMPER

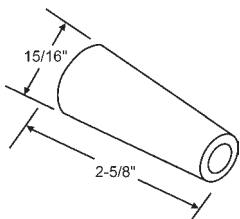

Part #	Finish
16-227B	Black
16-227W	White

Rubber

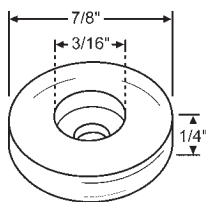

900-19153
Clear Plastic

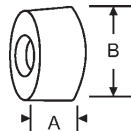

Part #	A	B	Finish
16-105	3/8"	15/16"	Gray
16-107	7/32"	3/4"	White

Rubber

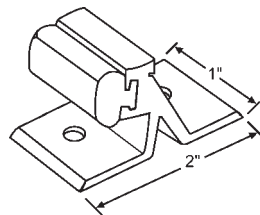

16-579
Aluminum
MILLER

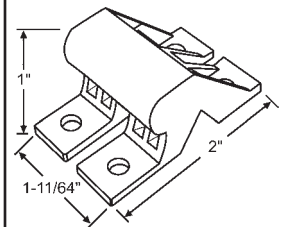

16-620W
White
PGT

PATIO DOOR BUMPER

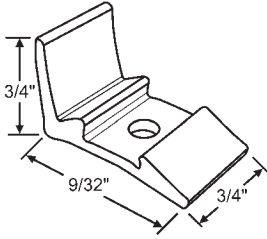

16-372B

Pocket Wedge Bumper. Black Vinyl

ANTI-LIFT

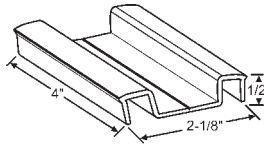

16-715TN

Tan PGT

ANTI-RATTLE GUIDES

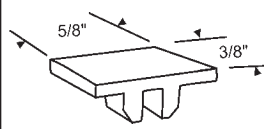

Part #	Finish	Description
15-88	Black	for Steel Doors
15-89	White	for Aluminum Doors

Anti-Rattle Guides

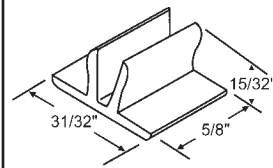

900-7228

Nylon

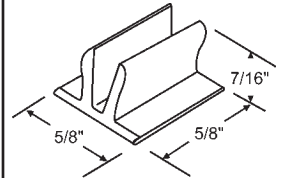

900-7225

Nylon

SECURITY LOCK

Security Lock

for both sliding glass doors and windows

MADE OF UNBREAKABLE LEXAN

Super Holding Power

Installs Without Tools

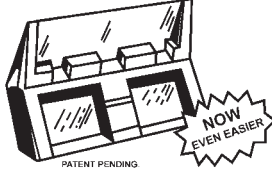

- Installs quickly without special tools.
- 3-M special adhesive bonds to glass like a weld
- Provides positive locking protection.
- Secures both sections firmly.
- Unbreakable GE Lexan.
- Crystal-clear transparency.

16-192

Sold in Pairs

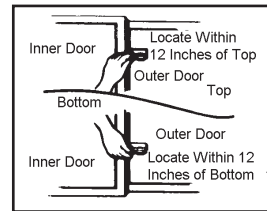

Glass Door Installation:
Position both Security Locks within 12 inches of top and bottom on outer door flush against inner frame.

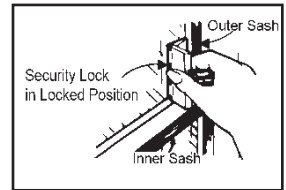

Sash Window Installation:
Position one Security Lock flush in lower corner of top window.

SECURITY LATCH

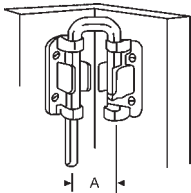

NARROW FOR EXTRA TIGHT CORNERS

Where moldings and jams are narrow and mounting space is limited; 3/4" shackle width.

Part #	Finish	"A"
16-185	Nickel	1-1/8"
16-185B	Black	1-1/8"
16-185BR	Brass	1-1/8"
16-185W	White	1-1/8"

STANDARD FOR MOST CORNER APPLICATIONS

Where ample mounting space is provided; 1-1/4" shackle width.

Part #	Finish	"A"
16-186	Nickel	1-7/16"
16-186B	Black	1-7/16"
16-186BR	Brass	1-7/16"
16-186W	White	1-7/16"

WIDE FOR OFFSET MOUNTING

Where reaches require wider shackle to bridge wide gaps between jams and moldings to wall; 2" shackle width.

Part #	Finish	"A"
16-187	Nickel	2-1/8"
16-187B	Black	2-1/8"
16-187BR	Brass	2-1/8"
16-187W	White	2-1/8"

"A" Dimension equals exact center to center measurement

- Simple to install
- Very easy to use
- Attractive finishes
- Prevents accidental locking

- Can be used on windows too
- Assures snug closure of door
- All mounting hardware included
- Reversible (Works left to right or right to left)
- Latch serves as convenient handle for door

- Makes handy latch for all regular swinging doors
- Mounts anywhere along frame for easy accessibility
- Presently being used by the hospitality industry nationwide
- Sturdily constructed (Handle made from 9/32" steel rod stock)

SECURITY HARDWARE & PATIO DOOR LOCKS

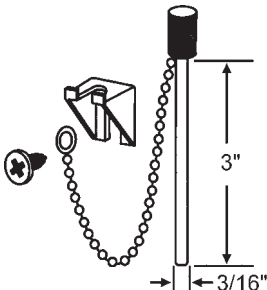

16-104

Burglar Pin/Nite Lock

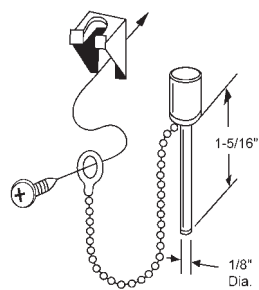

16-431

Burglar Pin/Nite Lock Aluminum Finish

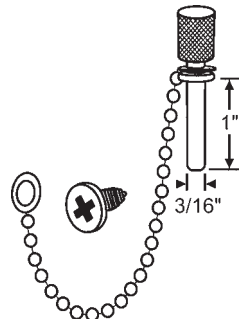

900-1099

Travel Lock

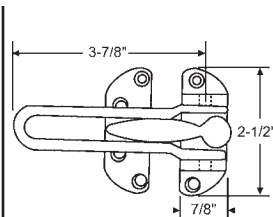

Part #	Finish
16-225C	Chrome
16-225PB	Brass

Door Guard

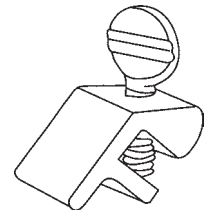

Part #	Finish
50-682	Mill
50-682BL	Black

PATIO DOOR HARDWARE

SECURITY HARDWARE & PATIO DOOR LOCKS

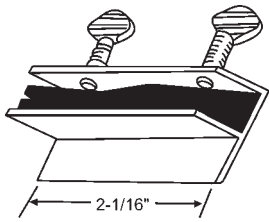

50-636

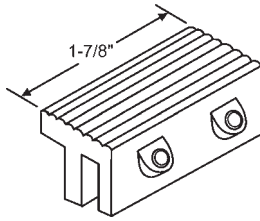

Part #	Finish
900-17508	Black
900-17508A	Aluminum

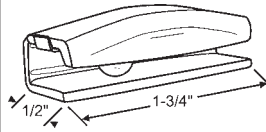

900-10574
Snap-on Vent Lock

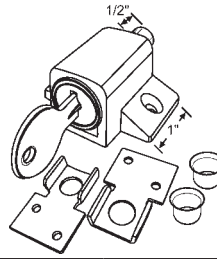

Part #	Finish
900-9718W	White
900-9718	Black

Heavy Duty Die Cast.
1-1/4" Hole Center. Includes
2 Keeper, 2 Ferrules and
Installation Screws

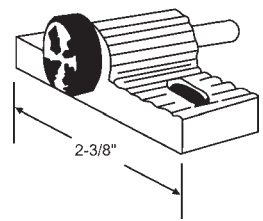

Part #	Finish
16-177	Aluminum
16-177B	Black

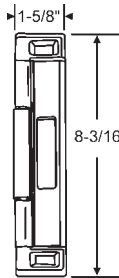
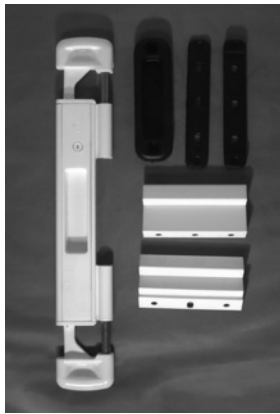

Part #	Finish
16-747	White
16-747B	Black

Double Bolt Security Lock

The CAL Double-Bolt Lock works by securing the door to the frame at 2 security points and preventing any movement of the door. With its double locking action the CAL Double-Bolt Lock makes it virtually impossible to remove the door by lifting it off its track.

The CAL double bolt lock can be used as a secondary or primary locking system on glass sliding doors. The lock can be mounted above the OEM lock to be out of children's reach or below the OEM lock to be within children's reach. The lock can also replace the OEM lock with the addition of the OEM Replacement cavity.

CAL SECURITY ENTERPRISES

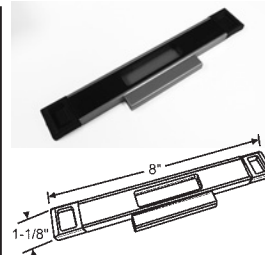

Part Number	Finish
16-753	White
16-753B	Black
16-753SV	Silver

Interlocking Latch
CAL SECURITY ENTERPRISES

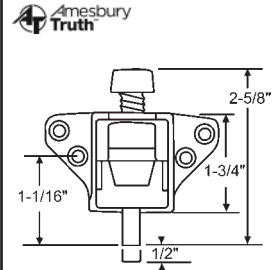

Part #	Finish
16-209-1	Bronze
16-209-3	White

Secondary Patio Lock
Screws Sold Separately

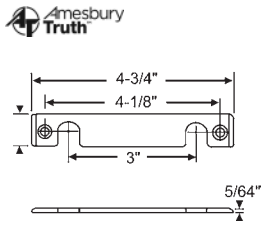

Part #	Finish
12-264-1	Bronze
12-264-3	White

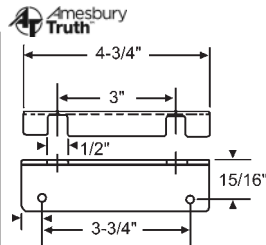

Part #	Finish
12-266-1	Bronze
12-266-3	White
12-266-9	Beige

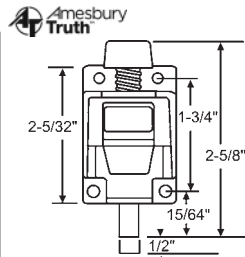

Part #	Finish
16-211-1	Bronze
16-211-3	White

Wingless Patio Lock
Screws Sold Separately

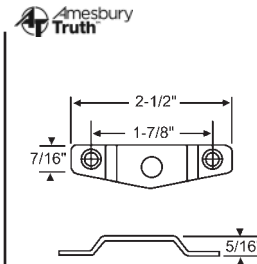

Part #	Finish
12-265-1	Bronze
12-265-3	White

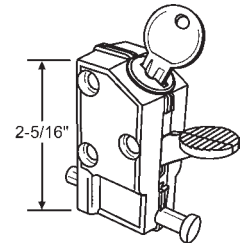

16-682
Mill Finish w/2 Keys
Pin Length 3/4"

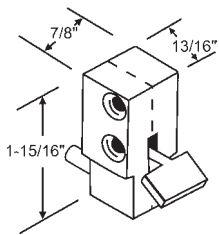

Part #	Finish
900-8734B	Black
900-8734	Aluminum

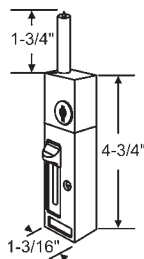

16-687
Security Lock. Aluminum

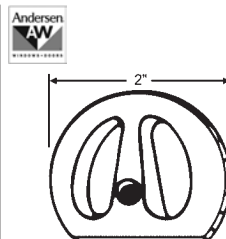

750-1997192
Two Panel Screen Door Lock
Stone

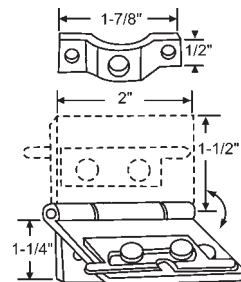

16-406
Aluminum Flip Lock

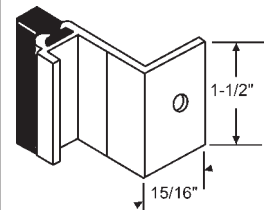

16-183
Fixed Panel Clip

PATIO DOOR HARDWARE

CAM LOCK

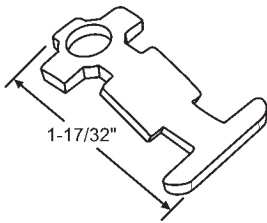

16-432
Offset Steel Cam Lock

PATIO DOOR BOLT

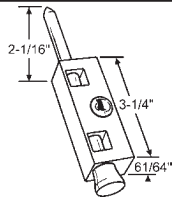

Part #	Finish
16-695W	White
16-695B	Black

Patio Door Bolts with Key

Part #	Finish
16-696W	White
16-696BZ	Bronze

Patio Door Bolts No Key
TRACO/EMTEK

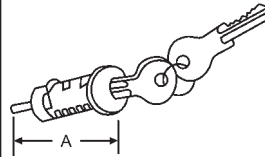

Part #	A
16-100	for 1" Door
900-21366	for 1-1/4" Door

Key Cylinder Lock

KEY CYLINDERS

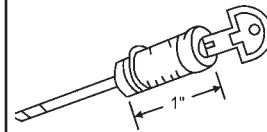

16-126
Key Cylinder

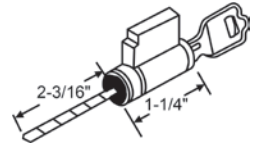

16-133
Key Cylinder Lock

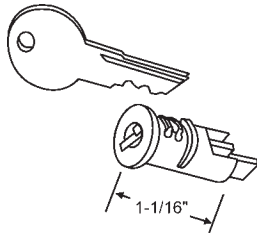

16-103
Key Cylinder for 1-1/8" Door

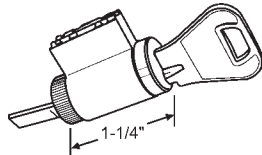

900-11179
Key Cam
PEACHTREE

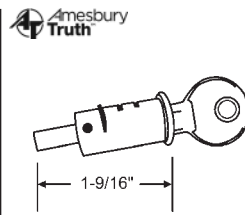

16-324

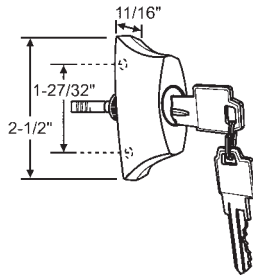

Part #	Finish
16-617SV	Silver
16-617BZ	Bronze

Lock Housing and Key
PGT

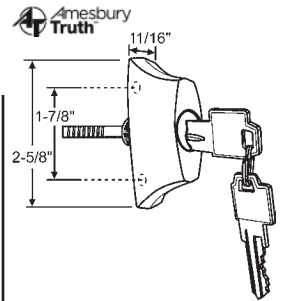

Part #	Finish
16-323	Aluminum
16-323BL	Black
16-323BP	Brass Plated
16-323BR	Brown
16-323W	White

Lock Housing and Key

MORTISE LOCKS

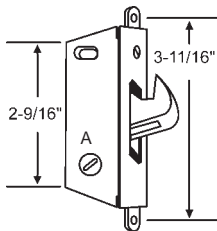

Part #	A
16-170	45°
16-170-90	90°

Square Face

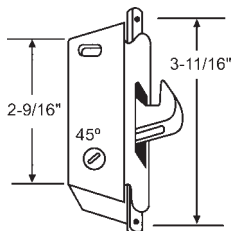

Part #	Description
16-171	Steel
16-171SS	Stainless Steel

Round Face

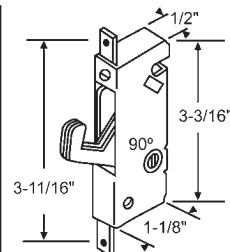

16-173
Square Face

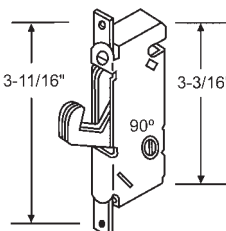

16-174
Round Face

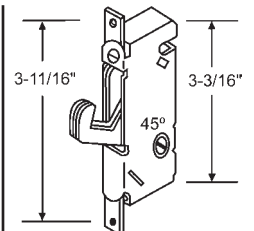

Part #	Description
16-175	Steel
16-175SS	Stainless Steel

Round Face

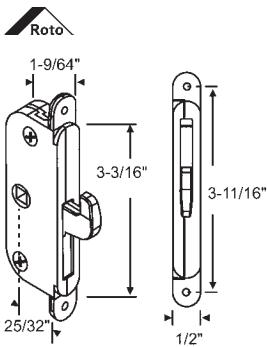

16-490
Single Point Slider Lock

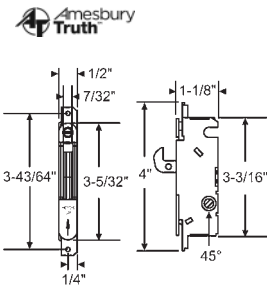

Part #	Description
16-397SS	Stainless Steel
16-397	Clear Chromate

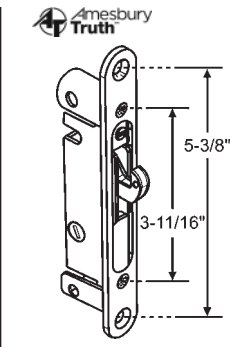

16-404A
Bracket Trim Plate and Lock. 45°

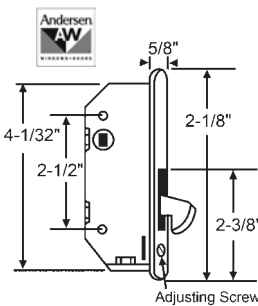

750-1997156

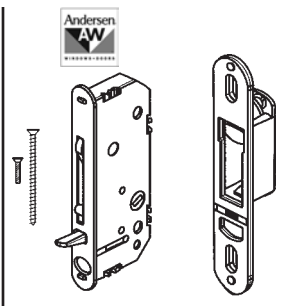

750-2562123
Mortise Lock and Receiver

PATIO DOOR HARDWARE

MORTISE LOCKS

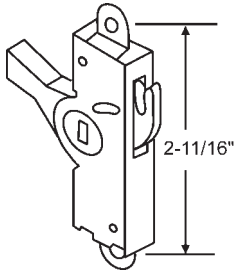

16-142

Used for Surface Mounted
Patio Door Handle

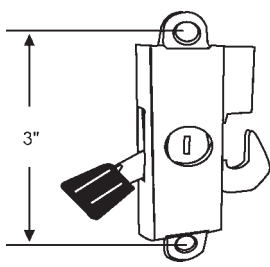

900-7305

Flush Button. Front Surface
Mounted Steel Hook
PEACHTREE

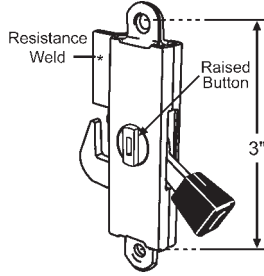

16-673

Raised Button. Front Surface
Mounted Steel Hook
PEACHTREE

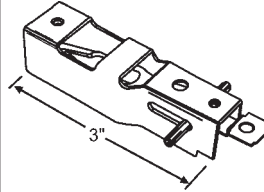

16-705

MORTISE LOCK 9/16in WIDE
GUARANTEED

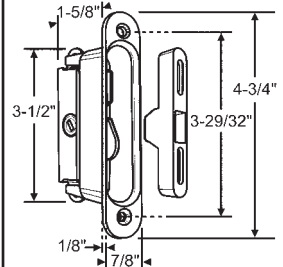

900-18867

Diagonal Hub. Aluminum Finish
Use: 900-14560 for Keeper
TRACO

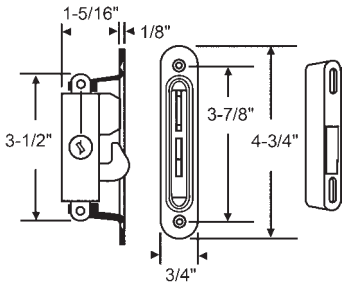

900-9169A

Includes Keeper
PENNCO

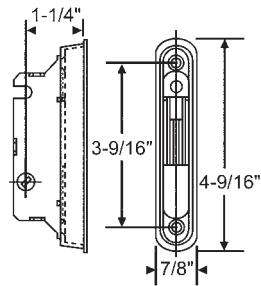

16-443

Mortise Lock and Plate

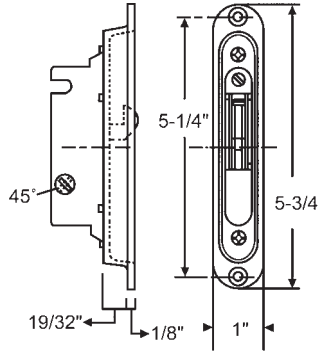

16-441-45

Pocket Trim Plate with 16-175. Brass
Plated

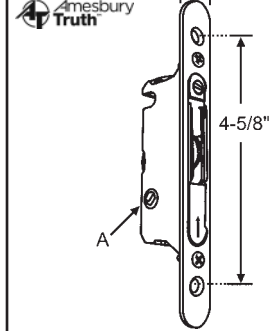

Part #	Finish	A
16-363-45	Brass Plated	45°
16-363-45SS	Stainless Steel	45°
16-363	Zinc Plated	90°

With Faceplate and 16-175

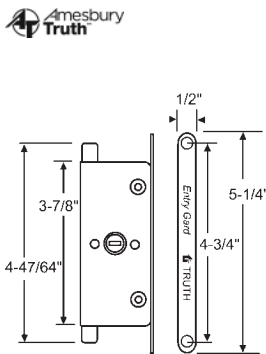

16-685

Multipoint Mortise Lock

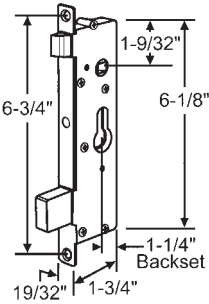

16-395

Heavy Duty Die Cast
Non- Handed, Reversible For Left
or Right Hand Application

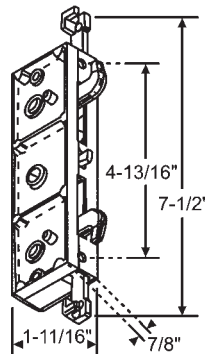

16-542

No Longer Available.
Use 16-542NS

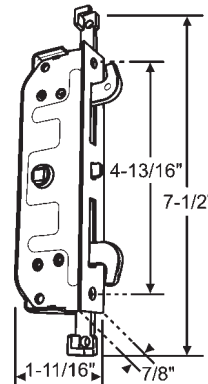

16-542NS

Two Point Mortise Lock
Milgard Classic Series

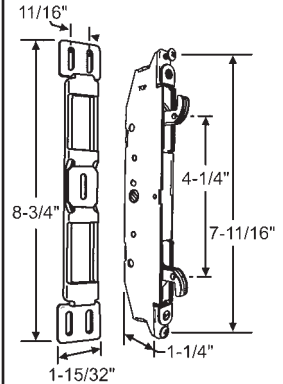

16-544W

Two Point Mortise Lock & Strike.
White
VANGUARD

MORTISE LOCKS

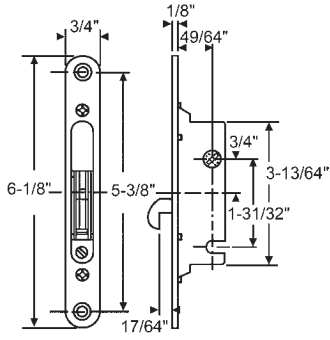

16-333
PEACHTREE

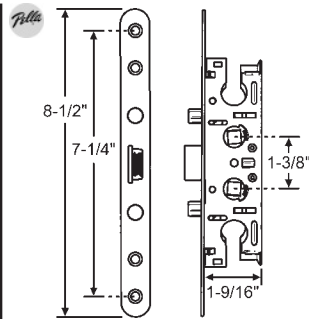

Part #	Finish
19-504B	Black
19-504G	Green
19-504PY	Putty
19-504TN	Tan
19-504W	White

Storm Door Mortise Lock

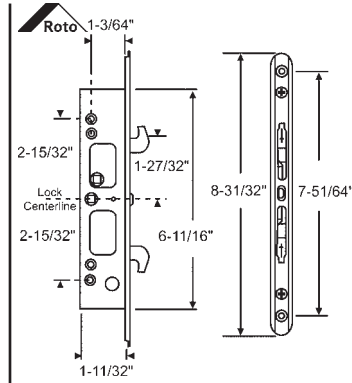

Part #	Finish
16-460	Steel Hooks
16-460SS	Stainless Steel Hooks

Two Point Patio Door Lock

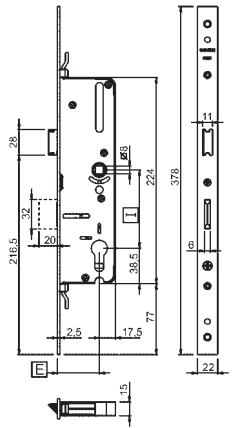

856-10021
MORTISE LOCK 35MM
GIESSE

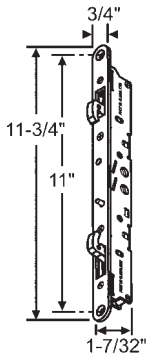

Part #	Finish
16-452	Steel
16-452SS	Stainless Steel

Two Point Lock with Faceplate
GEMINI/ PGT

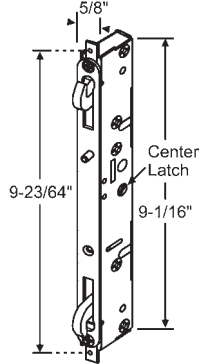

Part #	Finish
16-453	Steel
16-453SS	Stainless Steel

Two Point Mortise Lock w/
Short Face Plate. Center Latch
Thumbturn

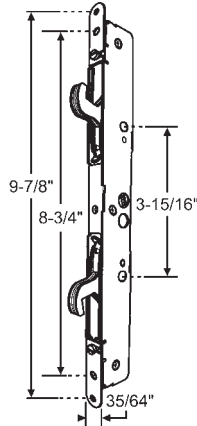

Part #	Finish
16-574	Steel
16-574SS	Stainless Steel

Dual Hook Mortise Lock

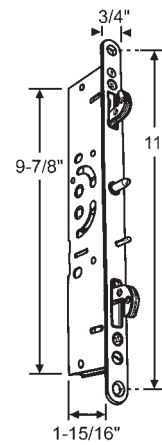

16-800
Dual Point Mortise Lock With
Square Drive
WINDOOR

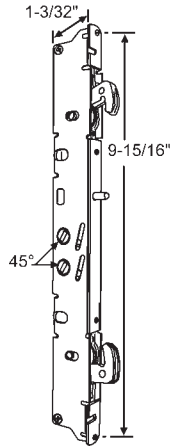

Part #	Finish
16-680	Steel
16-680SS	Stainless Steel

No Trim plate
GEMINI I & II

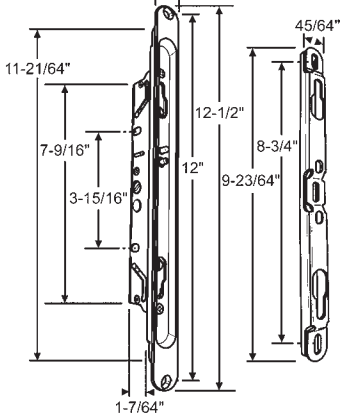

Part #	Finish
16-775B	Black
16-775W	White

Multipoint Mortise Lock With
Keeper & Screws

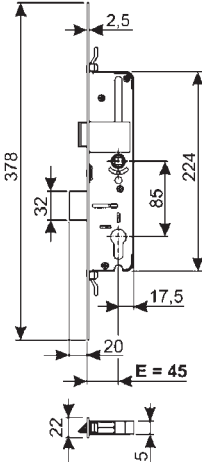

16-863-45
Lock For Balcony Door With 45mm
Backset

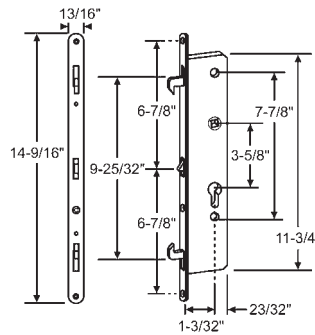

853-2896437
2PT Slider Door Lock SST 28MM

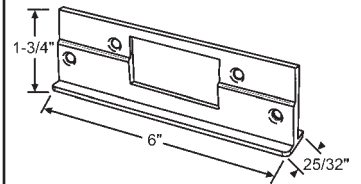

Part #	Finish
900-20972A	Aluminum
900-20972A-BR	Brass

Door Lock Guard. Angled Back With
Screws

PATIO DOOR HARDWARE

KEEPERS

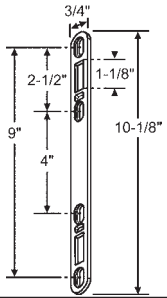

Part #	Finish
16-680FK	Steel
16-680FKSS	Stainless Steel

Flat Keeper
GEMINI I & II

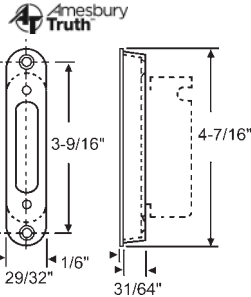

16-444
Trim plate

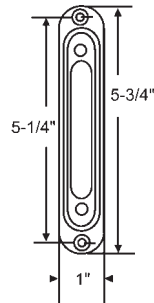

900-17354P
Pocket Trim plate. Zinc Dichromate

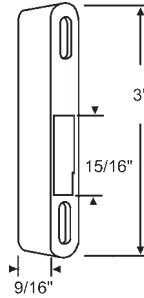

900-8856
Die Cast Keeper for 900-9169

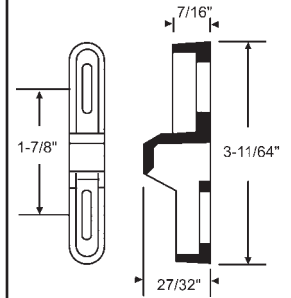

900-14560
TRACO

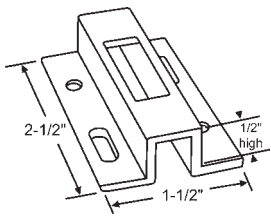

12-299W
White

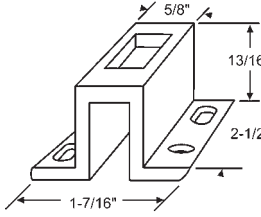

Part #	Finish
12-290W	White
12-290AD	Almond

900-69
Die Cast
YALE OGRON

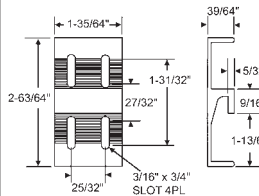
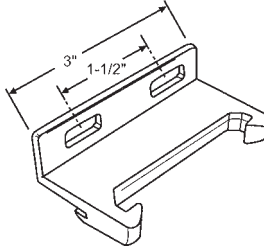

12-286W
White, Four Slot

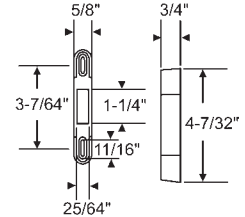

12-294
Yellow Chromate Plated

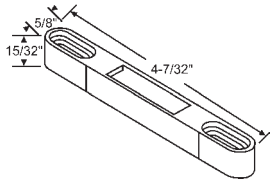

900-17355
Die Cast
PEACHTREE

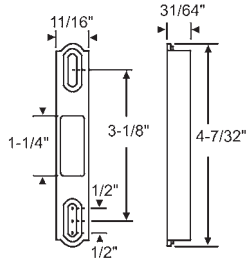

12-271

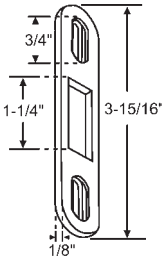

Part #	Finish
12-272	Steel
12-272SS	Stainless Steel

Flat. For 13-247 & 13-248 Patio Door Handles

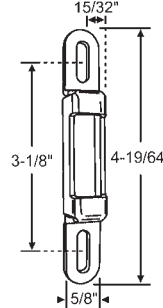

Part #	Finish
12-319	Dichromate
12-319SS	Stainless

13/64" x 11/16" Elongated Holes

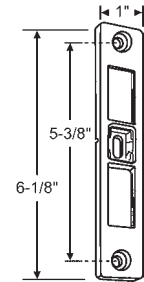

Part #	Finish
12-329STW	Satin White
12-329TN	Tan

Strike Plate. Used with 16-542
MILGARD

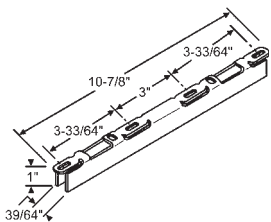

12-417
Dual Point Door Keeper

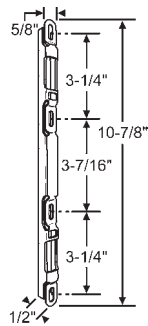

900-22553SS
Surface Keeper.
Stainless Steel

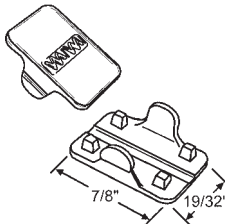

12-330
Strike Plate Screen Cover.
Plated. Used with 16-542
MILGARD

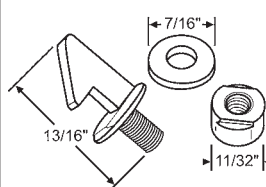

900-61
w/ Nut & Nylon Washer
Patio Door Keeper
DARYL

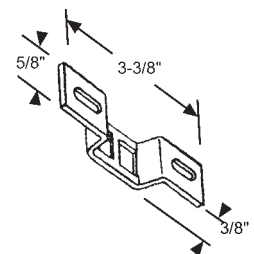

900-10458K
ACORN

LATCHES

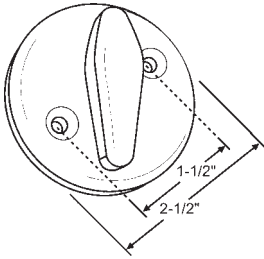

Part #	Finish
16-619BR	Bronze
16-619W	White

Door Turn for French Doors.
PGT

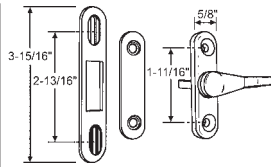

Part #	Finish
16-702B	Black
16-702BZ	Bronze
16-702SV	Silver
16-702W	White

Thumbturn Kit
PGT

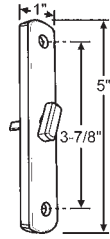

16-623BZ
Secondary Thumb Latch. Bronze
PGT

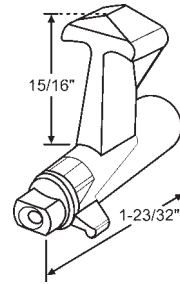

16-373
Patio Door Latch. Die Cast
ACORN

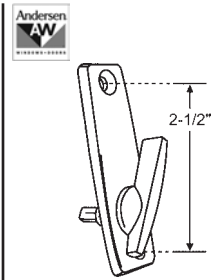

750-1278303
Stone

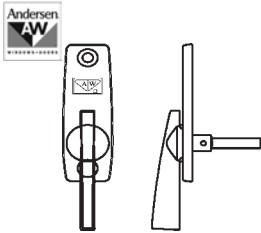

No Longer Available.
Use: 750-2573611

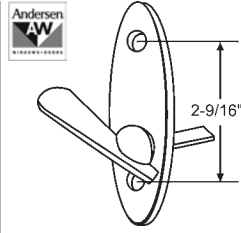

Part #	Finish
750-2573611	Stone
750-2573609	White

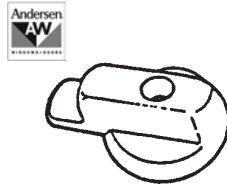

Part #	Finish
750-0924602	Stone
750-2579551	White

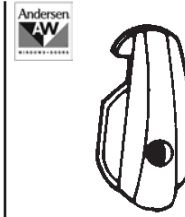

750-1997305
Stone

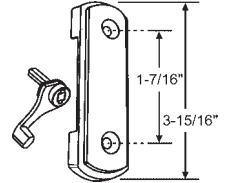

Part Number	Finish
16-798BZ	Bronze
16-798CC	Cream
16-798W	White

Secondary Thumb Turn
WINDOOR

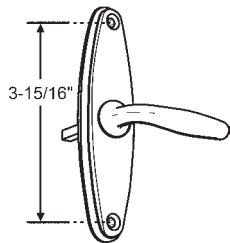

Part Number	Finish
16-799BZ	Bronze
16-799CC	Cream
16-799W	White

Thumb Turn
WINDOOR

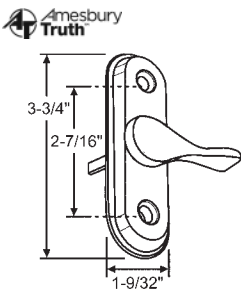

Part #	Finish
16-635AB	Antique Brass
16-635AD	Almond
16-635B	Black
16-635CH	Chrome
16-635W	White

Interior Thumb Turn

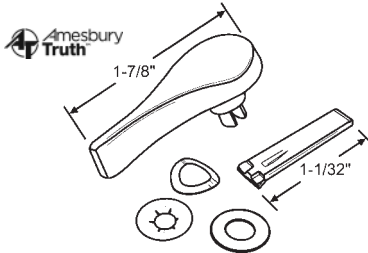

Part Number	Finish
13-245AD-TTKIT	Almond
13-245AB-TTKIT	Antique Brass
13-245B-TTKIT	Black
13-245BP-TTKIT	Brass Plated
13-245BC-TTKIT	Brushed Chrome
13-245-8TTKIT	Chestnut Bronze
13-245DOBZ-TTKIT	Dark Oil Rubbed Bronze
13-245SNK-TTKIT	Satin Nickel
13-245W-TTKIT	White

Fits Both 13-245 and 13-291 Handle Sets

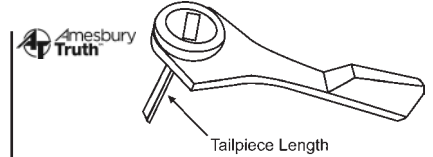

Part #	Finish	Tailpiece Length
900-11040	Black	.810
900-11040W	White	.810
900-11040-8	Chestnut Bronze	.810
900-11040SV	Silver	.810
900-11040A	Black	.530
900-11040WA	White	.530
900-11040B	Black	.660
900-11040WB	White	.660
900-11040C	Black	.960
900-11040WC	White	.960
900-11040D	Black	1.02
900-11040WD	White	1.02

Turn Lever with Tailpiece

CORNER BRACKETS

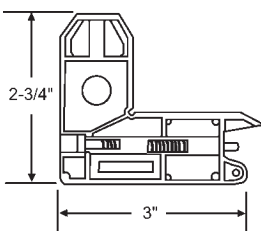

16-116-2

Screen Corner Bracket Assembly
with Screw. 2 per Pack

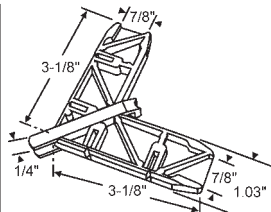

Part #	Finish
16-361PW	White
16-361PBZ	Bronze

Nylon Miter Corner. Use on Door
991M-999

LOCK BARS

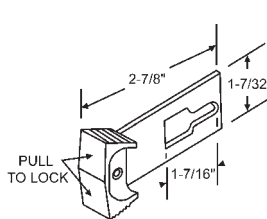

16-188

Lock Bar Without Key
CAPITOL

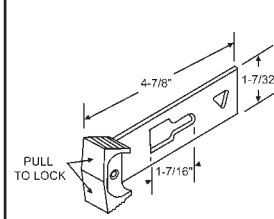

16-230

4-7/8" Lock Bar
CAPITOL

PINION GEAR

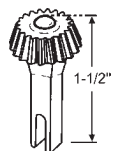

16-793

Standard Pinion Gear

PATIO DOOR HARDWARE

REPAIR TRACKS

.035 Gauge
Stainless Steel

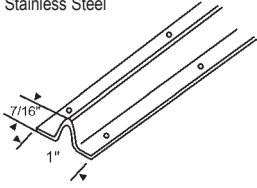

16-251

Replacement Track Cover. 8' Lengths. Sold in multiples of 5 only. Heavy duty. Recommended for tracks that are too corroded to use 16-115. Repairman's "first choice" in door replacement track.

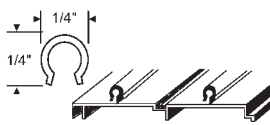

Part #	Length	Minimum Order
16-115	8ft.	(10 8ft. Lengths)
16-115-6	6ft.	(10 6ft. Lengths)
16-115-12*	12ft.	Any Quantity

Replace bent or broken door tracks with stainless steel replacement tracks. Easy to use. Snaps into place over old broken track. *Only Available for Pickup & Company Truck Delivery in our Florida Warehouse.

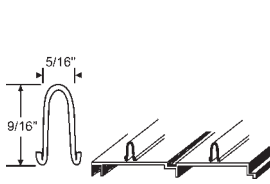

Part #	Length	Minimum Order
16-115BS	8ft.	(5 8ft. Lengths)

Replace bent or broken door tracks with stainless steel replacement tracks. Easy to use. Snaps into place over old broken track.

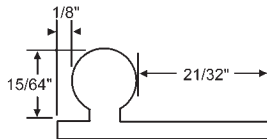

Part #	Length	Finish
16-217-6	6ft.	Anodized
16-217-8	8ft.	Anodized

Glass Door Track Extrusions
1/16" Thick x 15/16" Wide

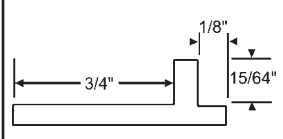

Part #	Length	Finish
16-219-6	6ft.	Anodized
16-219-8	8ft.	Anodized

Screen Door Track Extrusions
1/16" Thick x 15/16" Wide.

FASTENERS

CHARLEY-BAR SLIDING GLASS DOOR LOCK

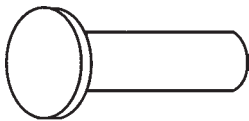

Part #	Finish
FAS 27 BR	Bronze
FAS 27 WH	White

10-32 Binder Post

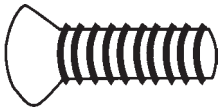

Part #	Size
FAT 181	10-32 x 3/4"
FAS 107L	10-32 x 1-1/8"
FAT 168	10-32 x 1-1/4"
FAT 180	10-32 x 1-1/2"
FAS 106	10-32 x 2-1/2"
FAT 171	10-32 x 3"

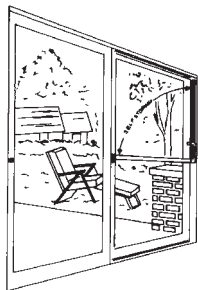

Charley-BAR

Safety Lock

NEW STEEL
SAFETY KEY
LOCK



16-108H

Charley Bar Hardware Pack includes plastic saddle, rubber cap, four #8 1/2" sheet metal screws and metal angle bracket

- Key hangs neatly out of your way when not in use
- Comes with all necessary hardware and instructions
- Available in three finishes
Anodized Aluminum construction allows it to be cut to fit any size door
New security feature: Improved black plastic saddle now takes a key so that the bar cannot be raised from the outside by wires or other devices
- New saddle keeps small children from opening the door from the inside

Mailing TUBE - 50 per carton
sold in carton qty only

Part #	Size	Finish
16-108T	48"	Mill
16-108TB	48"	Bronze
16-108TW	48"	White

Carded - 10 per carton sold
in carton qty only

Part #	Size	Finish
16-108C	48"	Mill
16-108CB	48"	Bronze
16-108CW	48"	White

Sold Individually

Part #	Size	Finish
16-108	48"	Mill
16-108B	48"	Bronze
16-108W	48"	White
16-108-60	60"	Mill

CHARLEY BAR SPINNING DISPLAY RACK

AUTOMATIC SCREEN DOOR CLOSER



500-334

This NEW Charley Bar Safety Lock Display, part number #500-334, contains 30 assorted Charley Bar Safety Locks in Mill, White and Bronze finishes on a spinning floor rack display with a merchandising sign. The display comes complete with peg hooks and there is minor assembly required. The display can be placed in a hardware aisle, near registers, and/or in the patio door aisle for cross selling. They can be cut to fit any patio door 48" or less. The retail package includes easy installation instructions on the back.

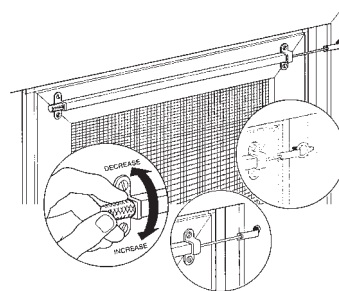

16-303

Screen Door Closer with Screws. Black. Fits Patio Screen Doors 36" and Larger. Simple Installation Takes Only Minutes. Block And Tackle Design Provides Smooth Operation.

WINDOW/DOOR GLAZING & WEATHERSTRIPPING

CAULKING APPLICATORS

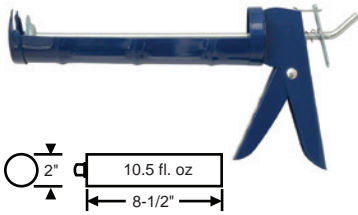

59-102

Half Pipe Caulking Applicator HS65

- Hardened push rod
- Hardened ratchet teeth push rod
- For cartridges 310ml/10.5 fl oz
- Color: Blue

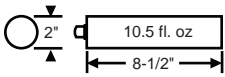

59-113

Half Pipe Caulking Applicator HPS44

- Low weight synthetic tool
- Metal thrust block
- Rotary carriage
- Comfort grip handle
- For cartridges 310ml/10.5 fl oz
- Color: Red/Black

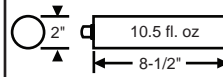

59-104

Half Pipe Caulking Applicator HPS56

- Rotary carriage
- Ladder hook
- Anatomically shaped trigger
- For cartridges 310ml/10.5 fl oz
- Color: Red/Black

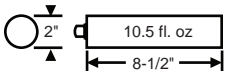

59-155

Caulking Applicator

- Rotary carriage and ladder hook
- High density sintered thrust block 10mm
- Heat treated (hardened) pushing rod
- Black aluminum handle + aluminum trigger
- Maximum pushing power: 4,000N
- For high viscosity dispensing material
- 900ml cartridge/28 fl oz
- Trigger ratio: 18:1

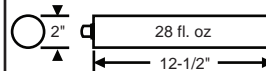

HPS SERIES BARREL APPLICATORS AND ACCESSORIES

XP - DELTA



59-159

Aluminium Barrel Applicator HPS400-A

- Rotary barrel
- Strong catch plate
- Stable aluminium screw caps
- Anatomically shaped trigger
- For cartridges 310ml/10.5 fl oz,
- Sausages 400ml/11.6 fl oz
- Color: Silver/Black

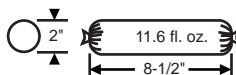
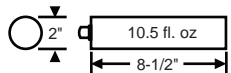

59-108

Aluminium Barrel Applicator HPS600-A

- Rotary barrel
- Strong catch plate
- Stable aluminium screw caps
- Anatomically shaped trigger
- For cartridges 310ml/10.5 fl oz,
- Sausages 400ml/11.6 fl oz, 600ml/20.2 fl oz
- Color: Silver/Black

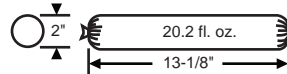
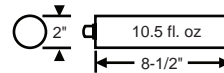

59-176

XP-DELTA

- Extremely Durable.
- Rotary Carriage and Ladder Hook.
- Rubber-Coated Handle and Trigger.
- Activated NON-DRIP function.
- NEW Switchable Trigger Ratios 25:1 and 12:1.
- Delta Catch Plate.

EXCEPT-310 CAULKING APPLICATOR



59-145

Aluminum Barrel Cap

- Sturdy screw caps made of aluminium
- For 59-159 & 59-108
- Color: Black



59-127

Tube Nozzle

- Solid nozzle for application of sausage material
- For 59-159 & 59-108
- Color: White



59-142

Push Plate Regular

- Push plate made of plastic
- For 59-159 & 59-108
- Color: White



59-163

Caulking Applicator

- For heavy-duty applications
- Rotary carriage and ladder hook
- Rubber-coated handle and trigger
- Anti-corrosive performance
- Integrated tip-cutter
- Activated drippless function
- Trigger ratio 19:1
- 310ml cartridge/10.5 fl oz

WINDOW/DOOR GLAZING & WEATHERSTRIPPING

X7 & FX7 SERIES APPLICATORS AND ACCESSORIES



59-152

Skeleton Caulking Applicator X7

- Hexagonal push rod
- Dripless function
- Ladder hook
- Built-in puncture tool
- Trigger ratio 7:1
- For cartridges 310ml/10.5 fl oz
- Color: Black

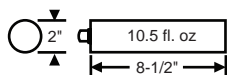

59-105

Half Pipe Caulking Applicator FX7-90

- Rotary carriage and ladder hook
- Rubber-coated handle and trigger
- Multiple-strength thrust block (resistance 6000N)
- Double slide bearings for smooth-running function
- For high viscosity dispensing material
- Trigger ratio 17:1
- For cartridges 310ml/10.5 fl oz
- Color: Black/Turquoise

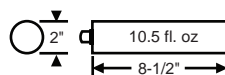

59-110

Aluminium Barrel Applicator FX7-40

- Rotary barrel and ladder hook
- Rubber-coated handle and trigger
- Multiple-strength thrust block (resistance 6000N)
- Double slide bearings for smooth-running function
- Push plate optimized for complete emptying
- For high viscosity dispensing material
- Trigger ratio 17:1
- For cartridges 310ml/10.5 fl oz,
- Sausages 400ml/11.6 fl oz
- Color: Silver/Black/Turquoise

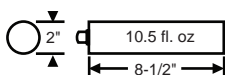

59-106

Aluminium Barrel Applicator FX7-60

- Rotary barrel and ladder hook
- Rubber-coated handle and trigger
- Multiple-strength thrust block (resistance 6000N)
- Double slide bearings for smooth-running function
- Push plate optimized for complete emptying
- For high viscosity dispensing material
- Trigger ratio 17:1
- For cartridges 310ml/10.5 fl oz,
- Sausages 400ml/11.6 fl oz, 600ml/20.2 fl oz
- Color: Silver/Black/Turquoise

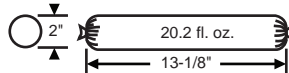
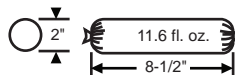
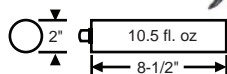

59-150

Side-By-Side Applicator FX7-34S

- Very sturdy tool with special hardened catch plate
- Double slide bearings for smooth-running function
- For high viscosity dispensing material
- Rubber-coated handle
- Trigger ratio 19:1
- For SBS-Dual component cartridges up to 345ml/11.6 fl oz and single 310ml/10.5 fl oz
- Color: Black



59-153

Coaxial Applicator FX7-38

- Heavy duty construction
- Strong catch plate
- Rubber-coated handle
- Trigger ratio 22:1
- For coaxial cartridges up to 380ml/12.8 fl oz
- Color: Black

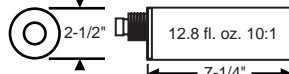

59-151

Dual Component Applicator FX7-21DP

- Very sturdy construction
- Strong non-slipping catch plate
- Rubber-coated handle
- Trigger ratio 17:1
- For double cartridges 2 x 110ml/2 x 3.7 fl oz
- Color: Black

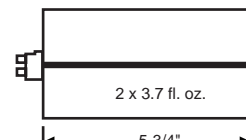
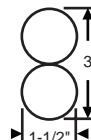

59-144

Screw Cap Pro Front

- Screw cap made of Aluminium
- Coarse thread (front)
- For 59-110 & 59-106
- Color: Black



59-146

Screw Cap Pro Back

- Screw cap made of Aluminium/Synthetic
- Fine thread (back)
- For 59-110 & 59-106
- Color: Black/Silver



59-126

Tube Nozzle Pro

- Nozzle with wide margin
- Tight fixing in cap
- For improved sausage performance
- For 59-110 & 59-106
- Color: White



59-143

Push Plate Pro

- Two-piece synthetic push plate with piston
- For complete emptying of sausages
- For 59-110 & 59-106
- Color: Black

WINDOW/DOOR GLAZING & WEATHERSTRIPPING

FOAM GUNS AND ACCESSORIES



59-107
ERGO

- Light-weight synthetic/aluminium foam gun
- Metal tube and trigger
- Big adjusting screw for excellent grip
- Ergonomical, rubberized handle
- Color: Red/Black



59-109
Metal Lite-Plus

- Solid Pro metal foam gun
- PTFE coated needle and can adaptor
- Large brass adjusting screw
- Tapered extrusion tube for high stability
- Rubberized handle for superior grip
- Color: Black/Red/Silver



59-156
Guardia X7

- Complete stick resistant PTFE coating
- Optimized, stronger can adaptor
- Very good foam flow
- Precise foam adjusting with endstop function
- Rubber coated handle and trigger
- Daming sticker (great for private label)
- Color: Black/Red



59-181
Scuro Evo5

- Solid Metal Foam Gun
- Special PTFE Coating
- Tapered Tube for Improved Stability
- PTFE Coated Needle and Can Adapter
- Strengthened Universal Adapter
- Large Adjusting Screw



59-157
Extreme X7

- Flexible foam gun tube with joint
- For special duty on hard-to-reach places
- Optimized, stronger can adaptor
- Precise dosage of foam flow
- Rubberized handle
- Daming sticker (great for private label)
- Color: Black/Red/Silver



59-158
Metal Lite XL

- Sturdy metal foam gun
- 60cm/1.97 ft tapered tube
- Rubber coated handle
- Non-slip brass adjusting knob
- Effortless working in confined spaces
- Foaming without a ladder
- Color: Grey/Black/Silver



59-149
Tube

- Plastic tubes for extension



59-147
Nozzle

- Plastic nozzles for foam guns



59-148
Fine Nozzle

- Nozzle attachment for special duty
- Color: Red

LITHIUM-ION BATTERY CAULKING GUN

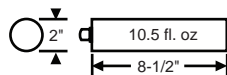

59-120
Powerjet-Li 310, 7.4V

- Automatic dripless function
- Stepless adjustable forward speed
- Rotary carriage
- Rubber-coated grip and trigger
- Built-in LED auxiliary light
- For cartridges 310ml/10.5 fl oz
- Color: Black/Red

MORTAR CAULKING APPLICATOR



59-154
Mortar Caulking Applicator X7-1000

- Heavy construction tool
- Wide catch plate
- Metal screw connection with handle
- Rubber coated handle and trigger
- Ladder hook
- Retaining clip secures tube
- Volume approx. 1000ml/33.8 fl oz
- Mortar Caulking Applicator X7-1000 is developed for clean and easy processing of mortar or joint sealer
- High stability and durability are guaranteed due to perfect fillings
- Precise application avoids dirty edges
- Possible usage at dry/ building construction, fire protection, etc.

SEALANT FINISHER



59-169
Sealant Finisher

- Made of elastic plastic
- For several different joint sizes
- For inclined or round joints
- Easy to handle
- Four pieces in a box



59-179
Joint Finisher Saddle.
Used on 59-105, 59-106 & 59-110 Guns

Finishes



Back Plates, Handles, Cylinders, etc. are available separately.

All HOPPE® Swing Door Handles are available in Active, Inactive and Dummy sets.

Multipoint/Single Point Locking Systems sold separately. Contact your Account Manager for pricing.

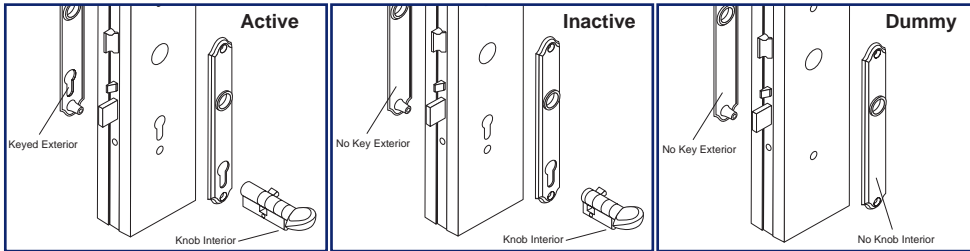

Part #	Description
850-2604801	Handle Set No Key
850-2605353	Handle Set with Construction Key

Temporary Construction Handle Set.
Black Plastic Body with Metal Die Cast Handle

München Series M112PL/216N

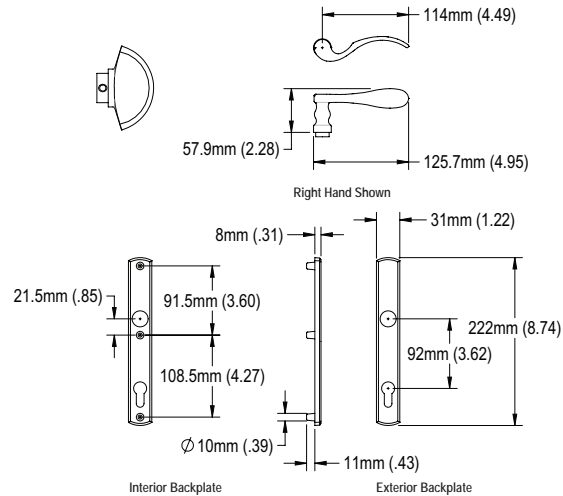

Type	Material	Brass Resista®	Antique Brass	Brushed Chrome Resista®	Oil Rubbed Brass	Matte Black	Satin Nickel	Rustic Umber
Active Door Set - 90° Cylinder	Solid Brass	850-2131135	850-2131143	850-2131160	850-2131581	850-2131178	850-2106263	850-2205739
Active Door Set - Cylinder Not Included	Solid Brass	850-2106474	850-8762947	850-8765471	850-8765603	850-8771091	850-2105113	850-2205704
Inactive Door Set - 90° Thumb Turn Insert	Solid Brass	850-2131590	850-2131602	850-2131629	850-2131670	850-2131637	850-2106301	850-2205747
Inactive Door Set - Thumb Turn Insert Not Included	Solid Brass	850-2106491	850-8765347	850-8765475	850-8765607	850-8771095	850-2105156	850-2205721
Pair Fixed Dummy	Solid Brass	850-2119187	850-8787963	850-8787975	850-8788031	850-8788019	850-2087891	850-2199519

All handle sets are for 1-3/4" thick doors.
Fixed dummy sets do not operate.

München Series M112PL/374N

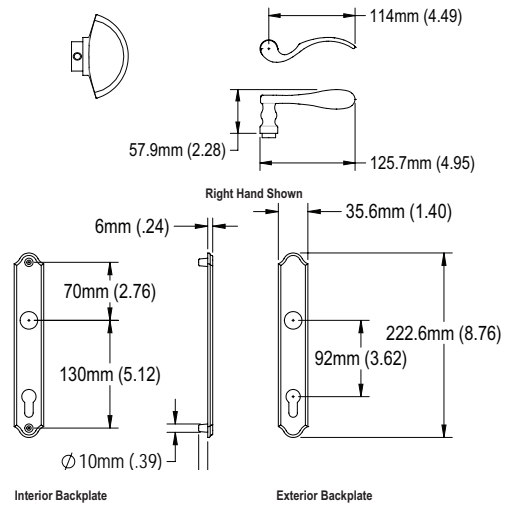

Type	Material	Brass Resista®	Antique Brass	Brushed Chrome Resista®	Polished Chrome Resista®	Oil Rubbed Brass	Pure White	Matte Black	Satin Nickel	Rustic Umber	Dark Bronze Metallic
Active Door Set - 90° Cylinder	Solid Brass	850-2116331	850-8763123	850-8763167	850-8763135	850-8773267	850-8763187	850-8773711	850-2094813	850-2214651	850-3366366
Active Door Set - Cylinder Not Included	Solid Brass	850-2106765	850-8764955	850-8764979	850-8765007	850-8765035	850-8765059	850-8771139	850-2105666	850-2214571	850-3880648
Inactive Door Set - 90° Thumb Turn Insert	Solid Brass	850-2133579	850-8763127	850-8766019	850-8763147	850-8766015	850-8763191	850-8773715	850-2106280	850-2214660	850-3366374
Inactive Door Set - Thumb Turn Insert Not Included	Solid Brass	850-2106781	850-8764963	850-8764983	850-8765001	850-8765039	850-8765063	850-8771143	850-2105703	850-2214598	850-3880656
Pair Fixed Dummy	Solid Brass	850-2076682	850-8788051	850-8788059	850-8788067	850-8788091	850-8788075	850-8788083	850-2088149	850-2214601	850-3366382

All handle sets are for 1-3/4" thick doors. Fixed dummy sets do not operate.

München Series M112PL/3965N

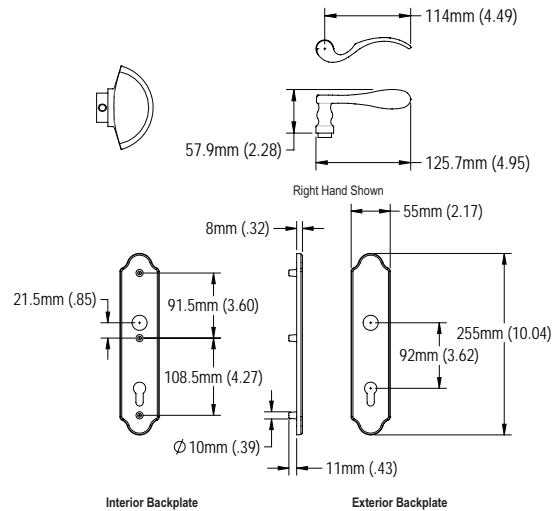

Type	Material	Brass Resista®	Antique Brass	Brushed Chrome Resista®	Matte Black	Satin Nickel	Rustic Umber
Active Door Set - 90° Cylinder	Solid Brass	850-2422063	850-2421976	850-2421992	850-2422039	850-2422047	850-2422071
Active Door Set - Cylinder Not Included	Solid Brass	850-2422194	850-2422098	850-2422119	850-2422160	850-2422178	850-2422207
Inactive Door Set - 90° Thumb Turn Insert	Solid Brass	850-2422338	850-2422215	850-2422223	850-2422282	850-2422303	850-2422354
Inactive Door Set - Thumb Turn Insert Not Included	Solid Brass	850-2422477	850-2422371	850-2422389	850-2422426	850-2422434	850-2422485
Pair Fixed Dummy	Solid Brass	850-2422725	850-2422645	850-2422653	850-2422696	850-2422709	850-2422733

All handle sets are for 1-3/4" thick doors. Fixed dummy sets do not operate.

Verona Series M151/216N

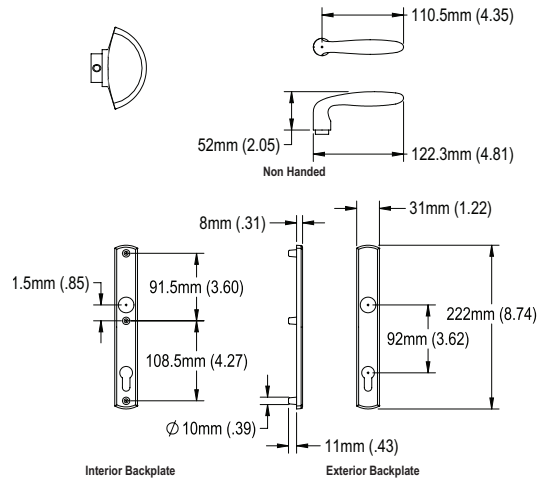

Type	Material	Brass Resista®	Antique Brass	Brushed Chrome Resista®	Polished Chrome Resista®	Oil Rubbed Brass	Pure White	Matte Black	Satin Nickel	Rustic Umber	Dark Bronze Metallic
Active Door Set - 90° Cylinder	Solid Brass	850-2131021	850-2131039	850-2131055	850-2131047	850-2131080	850-2131071	850-2131063	850-2094805	850-2207558	850-3873376
Active Door Set - Cylinder Not Included	Solid Brass	850-2093482	850-8773331	850-8773339	850-8773335	850-8773351	850-8773347	850-8773343	850-2087074	850-2207531	850-3880701
Inactive Door Set - 90° Thumb Turn Insert	Solid Brass	850-2131098	850-2131101	850-2039726	850-2131119	850-2203477	850-2131127	850-2039742	850-2095752	850-2207566	850-3873384
Inactive Door Set - Thumb Turn Insert Not Included	Solid Brass	850-2093503	850-8773359	850-8773367	850-873363	850-8773379	850-8773375	850-8773371	850-2087111	850-2209254	850-3880710
Pair Fixed Dummy	Solid Brass	850-2093511	850-8787971	850-8787983	850-8787999	850-8788039	850-8788015	850-8788027	850-2087138	850-2153211	850-3845720

All handle sets are for 1-3/4" thick doors. Fixed dummy sets do not operate.

Verona Series M151/3955N

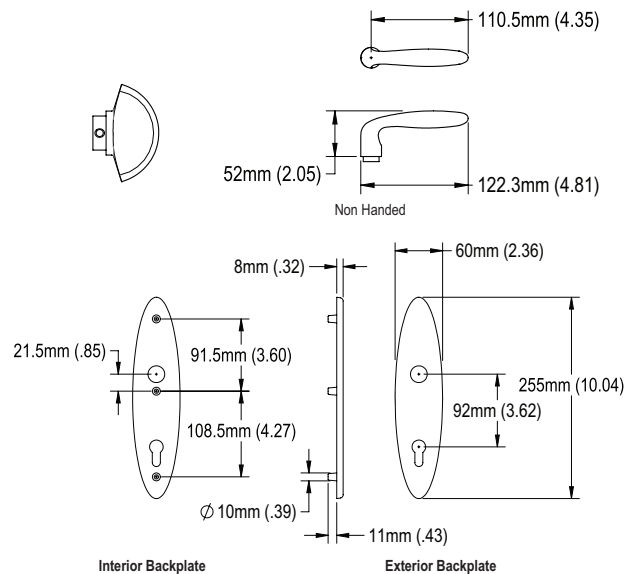

Type	Material	Brushed Chrome Resista®	Rustic Umber
Active Door Set - 90° Cylinder	Solid Brass	850-2414418	850-2414493
Active Door Set - Cylinder Not Included	Solid Brass	850-2414514	850-2414590
Inactive Door Set - 90° Thumb Turn Insert	Solid Brass	850-2414611	850-2414696
Inactive Door Set - Thumb Turn Insert Not Included	Solid Brass	850-2414717	850-2414792
Pair Fixed Dummy	Solid Brass	850-2414813	850-2414899

All handle sets are for 1-3/4" thick doors. Fixed dummy sets do not operate.

Verona Series E1800/353

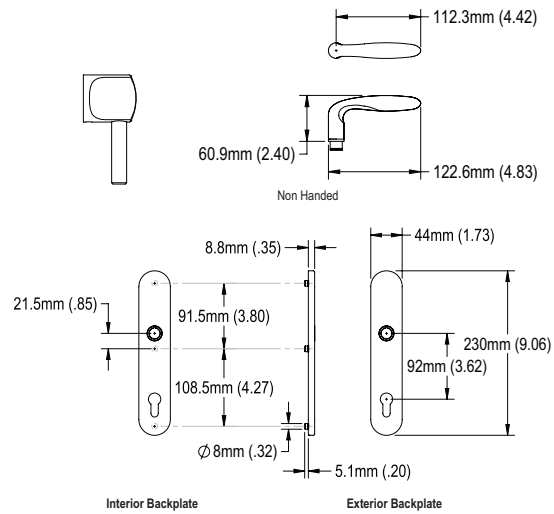

Type	Material	Brushed Stainless Steel
Active Door Set - 90° Cylinder	Solid Brass	850-3953835
Active Door Set - Cylinder Not Included	Solid Brass	850-8773459
Inactive Door Set - 90° Thumb Turn Insert	Solid Brass	850-3954301
Inactive Door Set - Thumb Turn Insert Not Included	Solid Brass	850-8773455

All handle sets are for 1-3/4" thick doors.

New Orleans Series M1610/216N

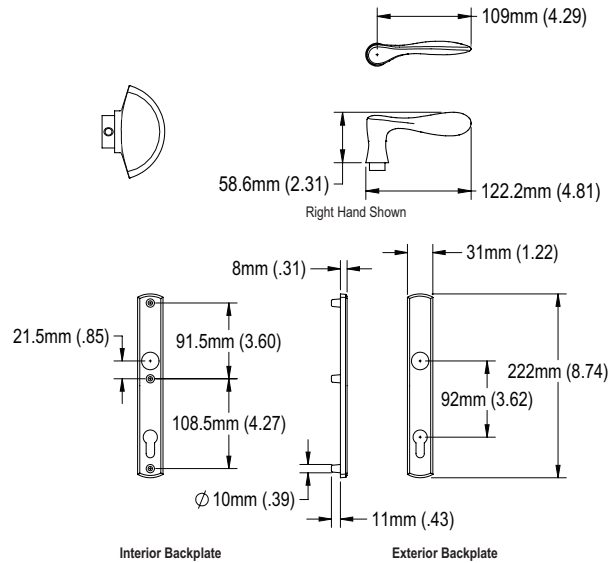

Type	Material	Brushed Chrome Resista®	Oil Rubbed Brass	Matte Black	Satin Nickel	Rustic Umber
Active Door Set - 90° Cylinder	Solid Brass	850-2131952	850-2132007	850-2131987	850-2131961	850-2207507
Active Door Set - Cylinder Not Included	Solid Brass	850-2110748	850-2110781	850-2110801	850-2110756	850-2207478
Inactive Door Set - 90° Thumb Turn Insert	Solid Brass	850-2132373	850-2132429	850-2132402	850-2132381	850-2207515
Inactive Door Set - Thumb Turn Insert Not Included	Solid Brass	850-2111345	850-2111388	850-2111409	850-2111353	850-2207494
Pair Fixed Dummy	Solid Brass	850-2098742	850-2109122	850-2098793	850-2098751	850-2201885

All handle sets are for 1-3/4" thick doors. Fixed dummy sets do not operate.

New Orleans Series M1610/374N

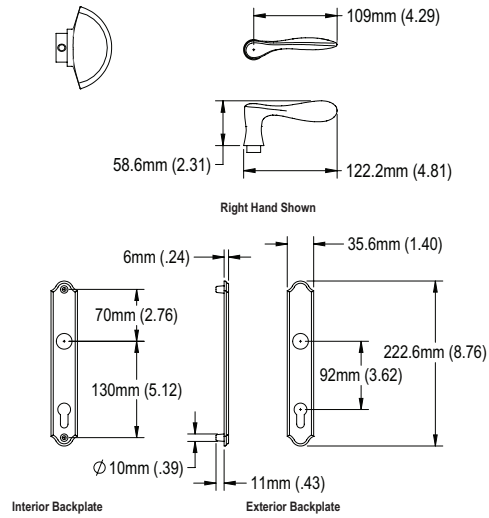

Type	Material	Brass Resista®	Brushed Chrome Resista®	Matte Black	Satin Nickel	Rustic Umber
Active Door Set - 90° Cylinder	Solid Brass	850-2338232	850-2338267	850-2338275	850-2338304	850-2217342
Active Door Set - Cylinder Not Included	Solid Brass	850-2112461	850-2112487	850-2112874	850-2112495	850-2217262
Inactive Door Set - 90° Thumb Turn Insert	Solid Brass	850-2338321	850-2338355	850-2338363	850-2338793	850-2217351
Inactive Door Set - Thumb Turn Insert Not Included	Solid Brass	850-2113068	850-2113092	850-2113156	850-2113105	850-2217289
Pair Fixed Dummy	Solid Brass	850-2113869	850-2103661	850-2103716	850-2103679	850-2217297

All handle sets are for 1-3/4" thick doors. Fixed dummy sets do not operate.

New Orleans Series M1610/3965N

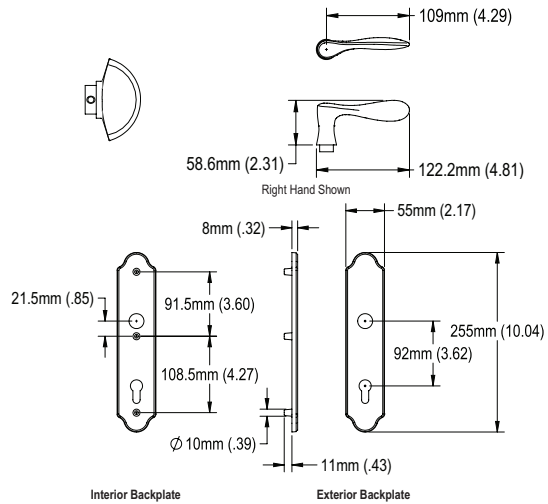

Type	Material	Oil Rubbed Brass	Matte Black	Satin Nickel	Rustic Umber
Active Door Set - 90° Cylinder	Solid Brass	850-2431736	850-2431752	850-2431779	850-2431795
Active Door Set - Cylinder Not Included	Solid Brass	850-2431832	850-2431859	850-2431875	850-2431891
Inactive Door Set - 90° Thumb Turn Insert	Solid Brass	850-2431939	850-2431955	850-2431971	850-2432000
Inactive Door Set - Thumb Turn Insert Not Included	Solid Brass	850-2432042	850-2432069	850-2432085	850-2432106
Pair Fixed Dummy	Solid Brass	850-2432149	850-2432165	850-2432181	850-2432202

All handle sets are for 1-3/4" thick doors. Fixed dummy sets do not operate.

Ròdos Series M1603/216N

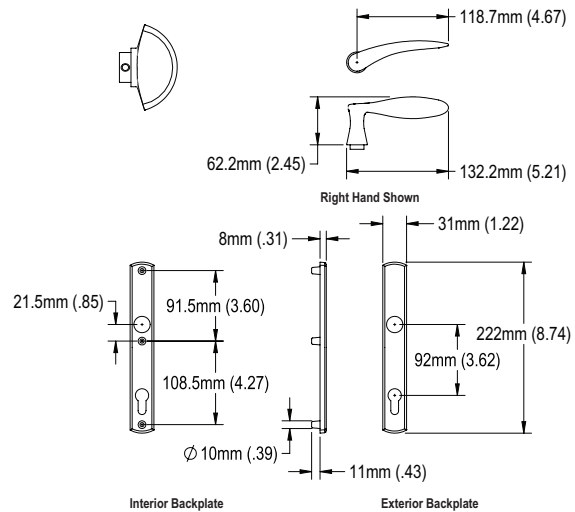

Type	Material	Antique Brass	Brushed Chrome Resista®	Oil Rubbed Brass	Pure White	Matte Black	Satin Nickel	Rustic Umber
Active Door Set - 90° Cylinder	Solid Brass	850-2131725	850-2111118	850-2131813	850-2131792	850-2111126	850-2131750	850-2207443
Active Door Set - Cylinder Not Included	Solid Brass	850-2115750	850-2115768	850-2116015	850-2115805	850-2115813	850-2115776	850-2207419
Inactive Door Set - 90° Thumb Turn Insert	Solid Brass	850-2131848	850-2111185	850-2131910	850-2131901	850-2111193	850-2131872	850-2207451
Inactive Door Set - Thumb Turn Insert Not Included	Solid Brass	850-2116251	850-2116269	850-2116306	850-2116314	850-2116322	850-2116277	850-2207435
Pair Fixed Dummy	Solid Brass	850-2117181	850-2117190	850-2117237	850-2117245	850-2117253	850-2117202	850-2201834

All handle sets are for 1-3/4" thick doors. Fixed dummy sets do not operate.

Toronto Series M1020/374N

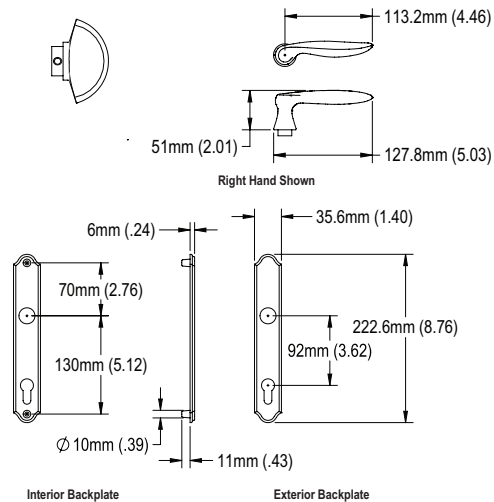

Type	Material	Brass Resista®	Brushed Chrome Resista®	Oil Rubbed Brass	Matte Black	Satin Nickel	Antique Nickel	Rustic Umber	Dark Bronze Metallic
Active Door Set - 90° Cylinder	Solid Brass	850-2133641	850-2134192	850-2134301	850-2134328	850-2134205	850-2134213	850-2214504	850-3873341
Active Door Set - Cylinder Not Included	Solid Brass	850-8789339	850-8788447	850-8788463	850-8788479	850-2074290	850-2074556	850-2214416	850-3880664
Inactive Door Set - 90° Thumb Turn Insert	Solid Brass	850-2134336	850-2134352	850-2134395	850-2134416	850-2134361	850-2134379	850-2214555	850-3873350
Inactive Door Set - Thumb Turn Insert Not Included	Solid Brass	850-8789347	850-8788495	850-8788511	850-8788527	850-2074329	850-2074732	850-2214432	850-3880672
Pair Fixed Dummy	Solid Brass	850-2081545	850-2081561	850-2088739	850-2081617	850-2081570	850-2081588	850-2214441	850-3722113

All handle sets are for 1-3/4" thick doors. Fixed dummy sets do not operate.

Toronto Series M1020/3965N

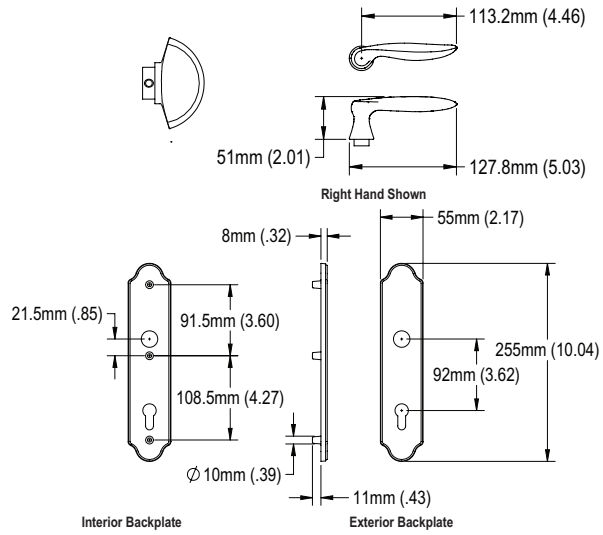

Type	Material	Brushed Chrome Resista®	Rustic Umber
Active Door Set - 90° Cylinder	Solid Brass	850-2427235	850-2427340
Active Door Set - Cylinder Not Included	Solid Brass	850-2427382	850-2427489
Inactive Door Set - 90° Thumb Turn Insert	Solid Brass	850-2427500	850-2427585
Inactive Door Set - Thumb Turn Insert Not Included	Solid Brass	850-2427614	850-2427729
Pair Fixed Dummy	Solid Brass	850-2427745	850-2427825

All handle sets are for 1-3/4" thick doors. Fixed dummy sets do not operate.

Atlanta Series M1530/216N

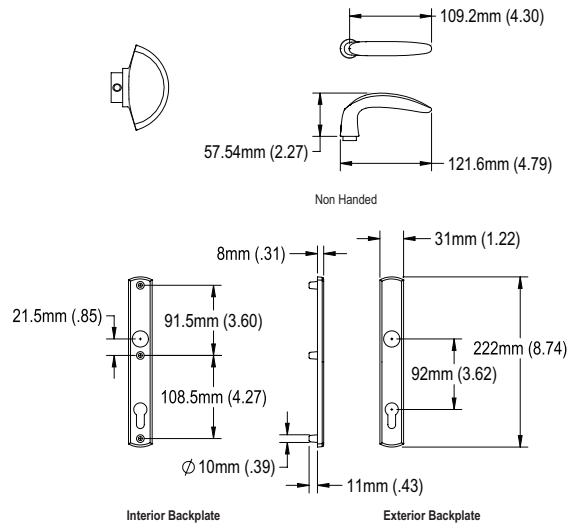

Type	Material	Brass Resista®	Brushed Chrome Resista®	Matte Black	Satin Nickel	Dark Bronze Metallic
Active Door Set - 90° Cylinder	Solid Brass					850-3873448
Active Door Set - Cylinder Not Included	Solid Brass	850-3144131	850-3560388	850-3983381	850-3144149	850-3144157
Inactive Door Set - 90° Thumb Turn Insert	Solid Brass					850-3873456
Inactive Door Set - Thumb Turn Insert Not Included	Solid Brass	850-3144190	850-3560396	850-3983399	850-3144202	850-3144211

All handle sets are for 1-3/4" thick doors.

Dallas Series M1643/2161N

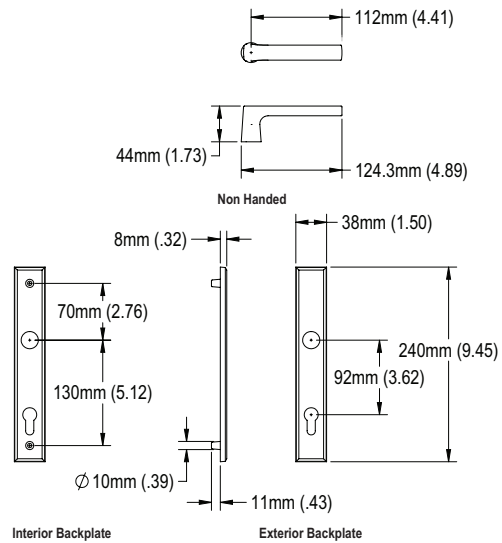

Type	Material	Brass Resista®	Matte Black	Satin Nickel	Rustic Umber	Dark Bronze Metallic
Active Door Set - 90° Cylinder	Solid Brass	850-3870415	850-3870407	850-3870394	850-11503208	850-3870386
Inactive Door Set - 90° Thumb Turn Insert	Solid Brass	850-3870378	850-3870360	850-3870351	850-11503215	850-3870343
Pair Fixed Dummy	Solid Brass	850-3755661	850-3764866	850-3745163	850-11501996	850-3745155

All handle sets are for 1-3/4" thick doors. Fixed dummy sets do not operate.

London Series 113L/2246

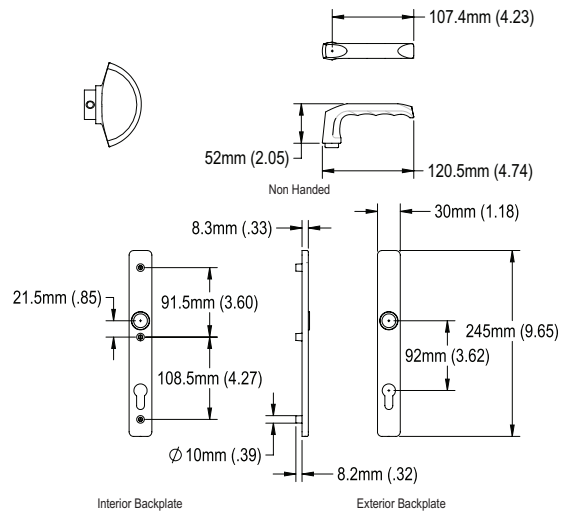

Type	Material	Silver
Active Door Set - 90° Cylinder	Aluminum	850-2445839
Inactive Door Set - 90° Thumb Turn Insert	Aluminum	850-2445847
Pair Fixed Dummy	Aluminum	850-3908313

All handle sets are for 1-3/4" thick doors. Fixed dummy sets do not operate.

Frankfurt Series 117L/2246

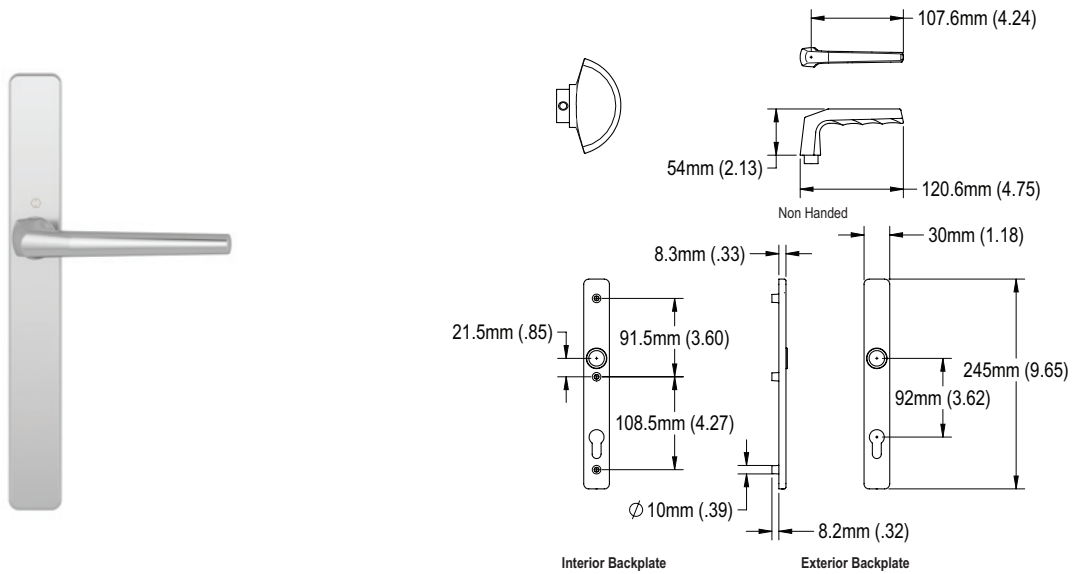

Type	Material	Silver	Chestnut	Pure White
Active Door Set - 90° Cylinder	Aluminum	850-2439164	850-2437652	850-2437791
Inactive Door Set - 90° Thumb Turn Insert	Aluminum	850-2439199	850-2437767	850-2437839
Pair Fixed Dummy	Aluminum	850-3671361	850-3743571	850-3646181

All handle sets are for 1-3/4" thick doors. Fixed dummy sets do not operate.

Missoula Series B1023/B2161

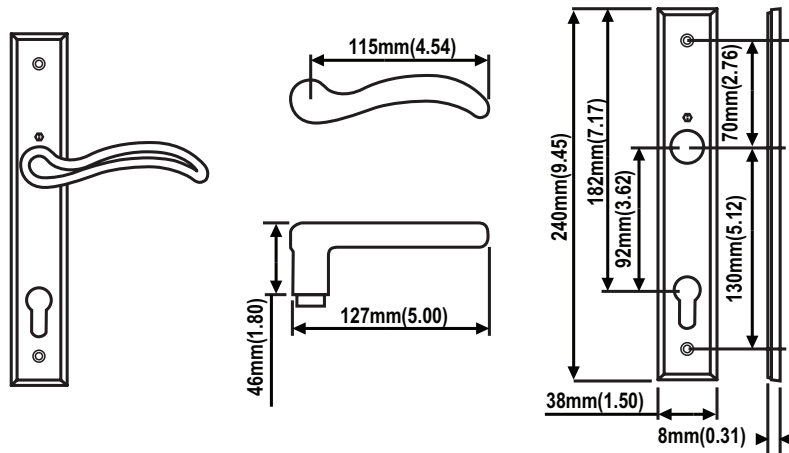

Type	Door Thickness	Material	Antique Bronze	Dark Bronze
Active Door Set - 90° Cylinder	1-3/4"	Solid Bronze	850-2923298	850-2923301
	2-1/4"	Solid Bronze	850-2923378	850-2923394
Inactive Door Set - 90° Thumb Turn Insert	1-3/4"	Solid Bronze	850-2923319	850-29233327
	2-1/4"	Solid Bronze	850-2923407	850-2923415
Pair Fixed Dummy	1-3/4"	Solid Bronze	850-2923466	850-2923474
	2-1/4"	Solid Bronze	850-2939521	850-2939548

Inactive Door Sets have only the thumbturn on the interior plate. Pair Fixed Dummy Sets do not operate.

Missoula Series B1023/B3741

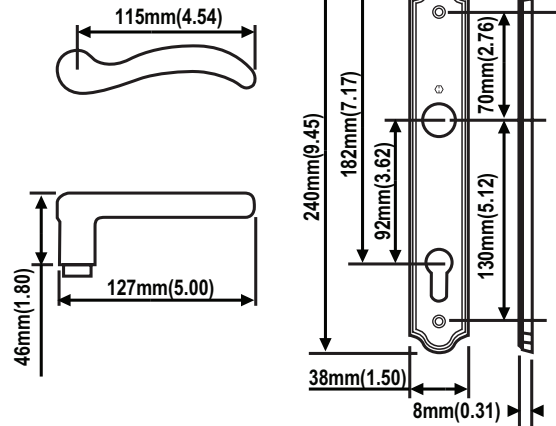

Type	Door Thickness	Material	Antique Bronze	Dark Bronze
Active Door Set - 90° Cylinder	1-3/4"	Solid Bronze	850-2923132	850-2923141
	2-1/4"	Solid Bronze	850-2923212	850-2923221
Inactive Door Set - 90° Thumb Turn Insert	1-3/4"	Solid Bronze	850-2923159	850-2923167
	2-1/4"	Solid Bronze	850-2923239	850-2923247
Pair Fixed Dummy	1-3/4"	Solid Bronze	850-2923271	850-2923280
	2-1/4"	Solid Bronze	850-2939505	850-2939513

Inactive Door Sets have only the thumbturn on the interior plate. Pair Fixed Dummy Sets do not operate.

Handle Extension for Active and Inactive Sets

Gold Handle Bushing

Handle Set Screw



20mm (.79) 22.9mm (.90)

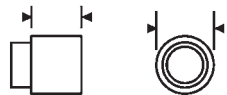

Part #	Finish
850-2076412	Brass Resista®
850-550593	Antique Brass
850-1704528	Brushed Chrome Resista®
850-606344	Polished Chrome Resista®
850-8777939	Oil Rubbed Brass
850-638185	Pure White
850-1704536	Matte Black
850-2903991	Satin Nickel Resista®
850-2904071	Antique Nickel Resista®
850-2190258	Rustic Umber
850-3885561	Dark Bronze Metallic



850-2294874
Stainless Steel

850-386060

Cylinder Screw



Description	Size	Part #
35mm & 45mm Backset	M5 x 50	850-7500282
60mm & 70mm Backset	M5 x 75	850-2406936

Stainless Steel

Screw Packs for Backplates

Size	Brass	Antique Brass	Brushed Chrome	Polished Chrome	Oil Rubbed Brass	Pure White	Matte Black	Satin Nickel	Antique Nickel	Rustic Umber	Dark Bronze Metallic
M5 x 50mm	850-2204867	850-8751919	850-2109827	850-8751907	850-8751927	850-8751903	850-8752183	850-2109827	850-2109691	850-8751927	850-2109691
M5 x 55mm	850-2231443	850-8751943	850-2231460	850-8751931	850-8751959	850-8751947	850-8752187	850-2231460	850-2231451	850-8751959	850-2231451
M5 x 60mm	850-2303208	850-8752167	850-2109763	850-8752171	850-8752175	850-8752179	850-8752191	850-2109763	850-2445919	850-8752175	850-2445919
M5 x 65mm	850-2253511	850-8751967	850-2253503		850-8751983	850-8751971	850-2253600	850-2253503	850-2260640	850-8751983	850-2260640
M5 x 70mm	850-2445871		850-2445898	850-8751999	850-8752007	850-8751995	850-8752003	850-2445898	850-2445927	850-8752007	850-2445927
M5 x 75mm	850-3377786	850-3377794	850-3377807	850-3377815	850-3377840	850-3377823	850-3377831	850-3377807	850-3648603	850-3377840	850-3648603
M5 x 80mm		850-8752563	850-8752567	850-2445901	850-8752579	850-8752575	850-8752571	850-8752567		850-8752579	

3 Screws per Pack

Profile Cylinder Accessories Rekeying Instructions

- Rekeying should be done by a qualified locksmith.
- Cylinder designs vary. HOPPE supplies CES brand cylinders and non-logo cylinders.
- Cylinders feature Schlage® SC1 keyways and may be rekeyed using Schlage® rekey kits.
- Cylinders should be rekeyed to an existing Schlage® key whenever possible.
- The HOPPE key gauge measures key cuts 1 through 9 the same as a Schlage® key gauge.

- When rekeying a CES cylinder using CES pins, use the CES pin number that corresponds with the measured key cut.
- When rekeying a CES cylinder using Schlage® pins, use the Schlage® pin number that is one less than the measured key cut. A key cut measuring 4 uses a #3 Schlage® pin.
- When rekeying a non-logo cylinder using CES pins, use the CES pin number that is one higher than the measured key cut. A key cut measuring 4 uses a #5 CES pin.
- When rekeying a non-logo cylinder using Schlage® pins, use the Schlage® pin number that corresponds with the measured key cut.



850-8785231
Key Blanks - Schlage® 5-Pin

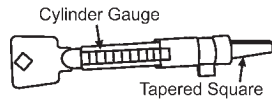

850-8750635
Construction Key with Cylinder Gauge.
Long Version (Blue)

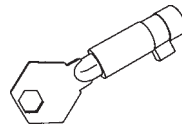

850-2667482
Construction Key
Short Version (Black)



850-2426890
8mm Square Construction Key

Steps to Rekey CES Cylinder with Plastic Insert

1.

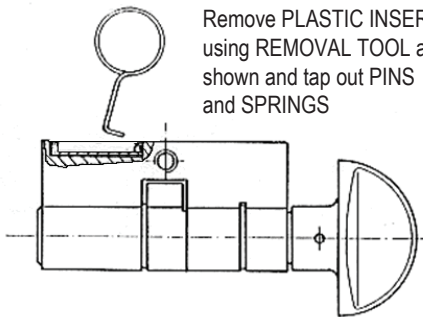

Remove PLASTIC INSERT using REMOVAL TOOL as shown and tap out PINS and SPRINGS

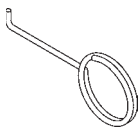

850-2000899
Removal Tool

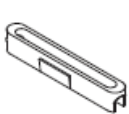

850-8771719
Plastic Insert



Part #	Description
850-8785239	Standard - 100 cylinder capacity Contains CES Pins

Steps to Rekey HOPPE Cylinder with Set Screws

1.

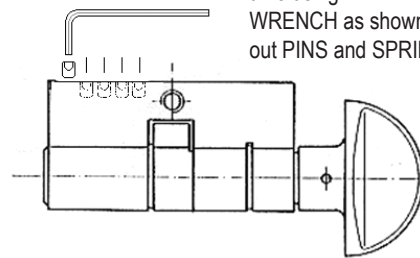

Remove one SET SCREW at a time using 2 mm HEX WRENCH as shown and tap out PINS and SPRINGS



850-3475773
Set Screw



850-8762427
2mm Hex Wrench



850-3459001
30 cylinder capacity Key Kit
Contains Schlage® Pins

2.

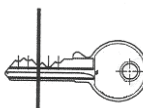
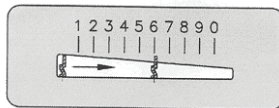

Determine CORE PIN size with KEYING GAUGE

3.

1. Insert desired CORE PIN into the appropriate cylinder pin hole.
Note: For cylinder designs featuring six pin holes, the innermost hole (furthest from the key face) is left blank.
2. Insert HOUSING PIN
3. Insert SPRING
4. Repeat until all PINS have been replaced and install PLASTIC INSERT OR install SET SCREW and repeat until all PINS have been replaced.

PLASTIC PLUG

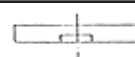

SET SCREWS

SPRINGS

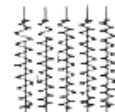
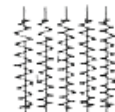

SPRINGS

OR

HOUSING (TOP) PINS



HOUSING (TOP) PINS

CORE (BOTTOM) PINS



CORE (BOTTOM) PINS

PROFILE CYLINDERS - FULL CYLINDER

For instructions on converting cylinders from 90° to 360° see page 404.



90° Full Cylinder with Crescent Knob

CYLINDER SIZING

Select cylinder size by "Inside Distance A" and "Outside Distance B" according to door thickness, Eurogroove location and the style of backplate used.

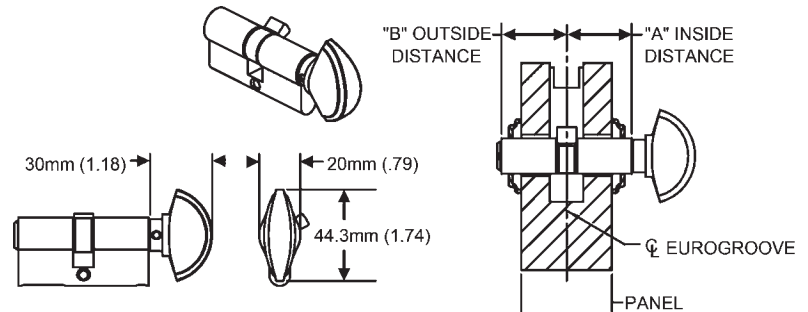

Backplate	Thickness
216N	8mm
374N	6mm
3955N	8mm
3965N	8mm
2161N	8mm

For 1-3/4" Doors or 2-1/2" Thick Doors

Inside Distance A	Outside Distance B	Typical Panel Thickness (Inches)	Antique Brass	White	Matte Black	Rustic Umber	Oil Rubbed Brass	Brass Resista®	Polished Chrome Resista®	Brushed Chrome Resista®	Satin Nickel Resista®	Antique Nickel Resista®
31.5	31.5	1-3/4"	850-3141933	850-3141976	850-3141984	850-3141968	850-3141941	850-3142637	850-3141925	850-3141909	850-3141917	850-3142629
40.5	40.5	2-1/4"	850-3745956	850-3745948	850-3738545	850-3637154	850-3637138	850-3637120	N/A	850-3637111	850-3637146	N/A

For 2-1/8" to 3" Doors

Inside Distance A	Outside Distance B	Typical Panel Thickness (Inches)	Brass Resista®	Brushed Chrome Resista®	Satin Nickel Resista®	Rustic Umber	Oil Rubbed Brass
35.5	35.5	2-1/8"	850-3636979	850-3636961	850-3636995	850-3637007	850-3636987
31.5	45.5	2-1/4"	850-3636928	850-3967719	850-3636944	850-3636952	850-3636936
45.5	31.5	2-1/4"	850-3637162	850-3967727	850-3637189	850-3637197	850-3637171
35.5	45.5	2-1/2"	850-3637023	850-3637015	850-3637040	850-3637058	850-3637031
40.5	40.5	2-1/2"	850-3637120	850-3637111	850-3637146	850-3637154	850-3637138
45.5	35.5	2-1/2"	850-3637200	N/A	850-3637226	850-3637234	850-3637218
31.5	60.5	3"	850-3442357	850-3651319	850-3442402	850-3584072	850-3442411
35.5	55.5	3"	850-3637074	850-3637066	850-3637091	850-3637103	850-3637082
45.5	45.5	3"	850-3637242	N/A	850-3637269	850-3637277	850-3637251
60.5	31.5	3"	850-3442429	850-3651301	850-3442470	850-3570367	850-3442488

PROFILE CYLINDERS THUMBTURN CYLINDER

For instructions on converting cylinders from 90° to 360° see bottom of page.

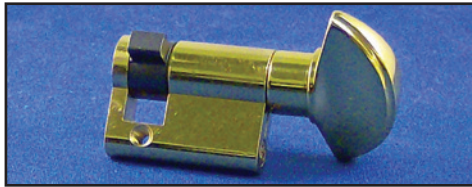

90° Thumbturn Insert Cylinder w/Crescent Knob

CYLINDER SIZING

Select cylinder size by "Inside Distance A" and "Outside Distance B" according to door thickness, Eurogroove location and the style of backplate used.

Backplate	Thickness
216N	8mm
374N	6mm
3955N	8mm
3965N	8mm
2161N	8mm

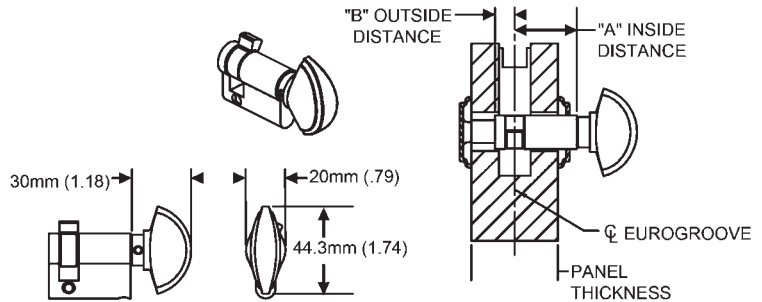

For 1-3/4" Doors or 2-1/2" Thick Doors

Inside Distance A	Outside Distance B	Typical Panel Thickness (Inches)	Antique Brass	White	Matte Black	Rustic Umber	Oil Rubbed Brass	Brass Resista®	Polished Chrome Resista®	Brushed Chrome Resista®	Satin Nickel Resista®	Antique Nickel Resista®
31.5	10	1-3/4"	850-3141853	850-3141888	850-3141896	850-3141870	850-3141861	850-3142611	850-3141845	850-3141829	850-3141837	850-3142565
40.5	10	2-1/4"	850-3745972	850-3745964	850-3738553	850-3637373	850-3637357	850-3637349	N/A	850-3637331	850-3637365	N/A

For 2-1/8" or Thicker Doors

Inside Distance A	Outside Distance B	Typical Panel Thickness (Inches)	Brass Resista®	Brushed Chrome Resista®	Satin Nickel Resista®	Rustic Umber	Oil Rubbed Brass
35.5	10	2-1/8"	850-3637293	850-3637285	850-3637314	850-3637322	850-3637306
40.5	10	2-1/2"	850-3637349	850-3637331	850-3637365	850-3637373	850-3637357
45.5	10	3"	850-3637381	N/A	850-3637402	850-3637411	850-3637390
60.5	10	3"	850-3442496	850-3651298	850-3442541	850-3650551	850-3442550

Profile Cylinder 90° to 360° Conversion Instructions*

Recommended Tools and Accessories

* For the new non-logo cylinders. Does not work on CES cylinders.

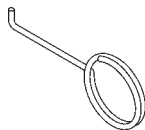

90° Release Tool (provided)



2 mm or 1/4" Hex Wrench (provided)

1. Remove the set screw as shown using the hex wrench
2. Dump out the spring and pin after removing the set screw
3. Use the 90 degree release tool if the pin does not fall freely from the cylinder body in step 2 as shown.
4. Recycle the set screw, spring, pin and 90 degree release tool.

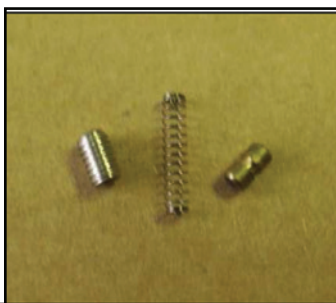

HTL ULTIMATE 2-D HINGE

Steel Reinforcements - Makes this new hinge the "Ultimate" with door systems.

- Corrosion Resistant - Specially coated components for improved durability and strength.
- Easy Adjustment - Set hinge has a vertical adjustment feature (+/- 2.5mm) Guide hinge has a horizontal adjustment feature (+/- 2mm).
- Maintenance Free Bearings - No oiling required.
- Security - Non-removable pin (NRP) available for increased security.

• Simple Door Preparation - Quick and easy one pass routing.

- Variety of Finishes - Available in finishes to match your HOPPE® handle sets.
- Designed to carry up to 165 lbs. per door.
- Not to be used in commercial applications, especially not in conjunction with a door closer.

Set Hinge

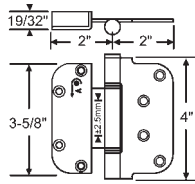

Steel Set Hinges with Non-Removable Pin

Part #	Finish
850-8762439	Polished Brass
850-8762455	Polished Chrome
850-8762703	Brushed Chrome
850-8762439	KTL Brass Alternative
850-2307831	Rustic Umber
850-8762535	Matte Black

Brass Set Hinges with Non-Removable Pin

Part #	Finish
850-8762655	Polished Brass
850-8762671	Antique Brass

Stainless Steel Set Hinges with Non-Removable Pin

Part #
850-8762567

Guide Hinge

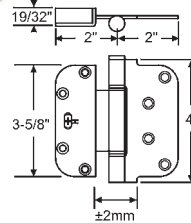

Steel Guide Hinges with Removable Pin

Part #	Finish
850-8762435	Polished Brass
850-8762451	Polished Chrome
850-8762699	Brushed Chrome
850-8762435	KTL Brass Alternative
850-2307823	Rustic Umber
850-8762531	Matte Black

Brass Guide Hinges with Removable Pin

Part #	Finish
850-8762651	Polished Brass
850-8762667	Antique Brass

Stainless Steel Guide Hinges with Removable Pin

Part #
850-8762563

COLUMBUS 2-D HINGE FOR WOOD AND VINYL PRODUCTS

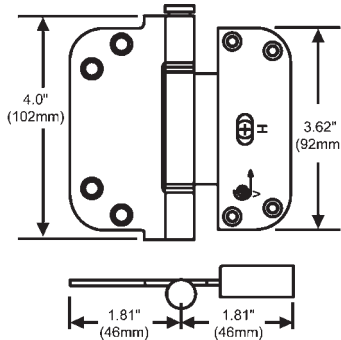
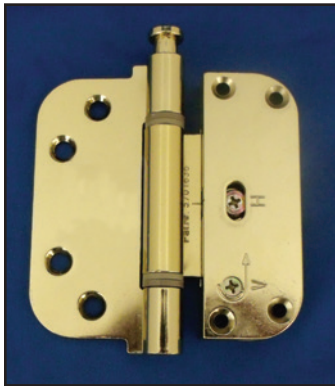

850-8755047

Set Hinge
No Longer Available.
Use 56-224PB. See Page 437

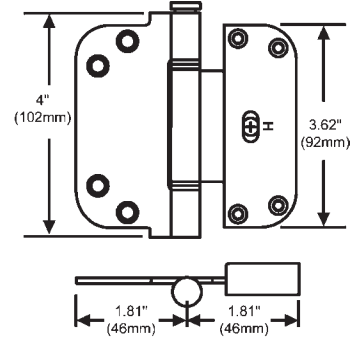
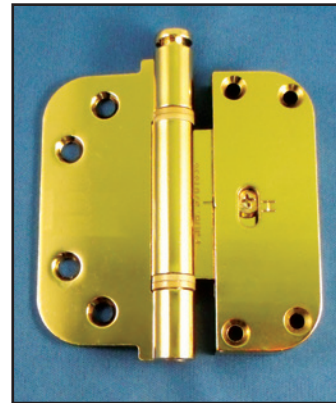

850-8755099

Guide Hinge
No Longer Available.
Use 56-223PB. See Page 437

For Additional Finishes, See Part Numbers 56-224 and 56-223 on Page 437.

Settling of walls and floors can make door panels hard to open and close. The 2-D Adjustable Hinge allows easy adjustment of the door both horizontally (+/-2 mm) and vertically (+/-3 mm) with just the turn of a screw. Each hinge is reversible and has maintenance free bearings.

There are two types of adjustable hinges for each door panel.

- Set Hinge: One per panel. This has vertical adjustment (± 3 mm).
- Guide Hinge: Minimum of two per panel. These hinges only have the horizontal adjustment (± 2 mm).

The guide hinges float up and down with the adjustment of the set hinge to prevent hinge binding.

Normal hinge replacement has the set hinge. Using a Phillips screwdriver, first adjust the panel up or down by turning the screw marked "V" on the set hinge. When turning the screw in the direction of the arrow (counter clockwise) the other leaf will be pushed in the direction of the arrow. Automatic screwdrivers are not recommended. The speed of the gun may strip the heads if the screws are over adjusted.

When the vertical adjustment is turned clockwise, the non-adjustable leaf will move in the direction of the arrow. The vertical adjustment has 32 turns from its extremes, and the horizontal has 7 turns.

Adjust the horizontal by turning clockwise to increase the margins. Turn counter clockwise to decrease the margins.

HLS 9000 MULTIPOINT HARDWARE SWING DOOR QUESTIONNAIRE

This form is for a HOPPE or FUHR **Swing** Door Multipoint System with the key cylinder **below** the lever handle.

The **HLS9000 Stainless Steel Multipoint Locking System** provides more than safety and security. It prevents the unwelcome intrusion of rust and corrosion. It can also keep your reputation from being tarnished by eliminating expensive service calls and any resulting loss of revenue.

Corrosion occurs for a variety of reasons. With other materials or finishes, such as yellow zinc dichromate, it can result from pollution in the air, a scratched surface or from the presence of moisture or salt -particularly in coastal regions. **Stainless Steel provides excellent corrosion resistance from these in natural atmospheric conditions.** It also provides an extra measure of protection from pitting and staining in more demanding locations such as industrial sites, areas of urban pollution and coastal regions. To protect the quality of your product as well as your image, insist upon HLS9000.



Manual Tongue/
bolt Version

Automatic Four
Roller Version



SWING
HOOK



SHOOTBOLT
VERSION



ROLLER
VERSION



TONGUE
VERSION



ROUNDBOLT
VERSION

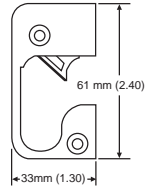
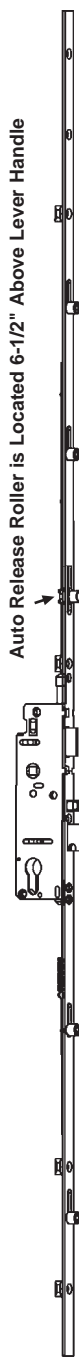
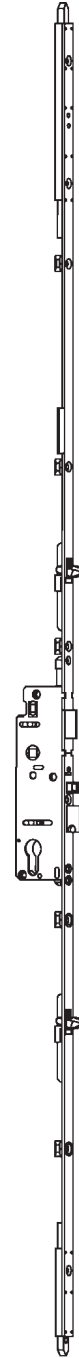

Auto Release Strike

Auto Release Roller is Located 6-1/2" Above Lever Handle

Screws for Wood Profiles

Part #	Length
850-8785687	25/32"
850-8785691	1-5/32"
850-8785695	1-3/8"
850-8785699	1-3/4"
850-8785703	2-3/8"

Screws for Vinyl Profiles

Part #	Length
850-8785667	19mm
850-8785671	22mm
850-8785675	25mm

All Screws are Stainless Steel. 25 per Bag

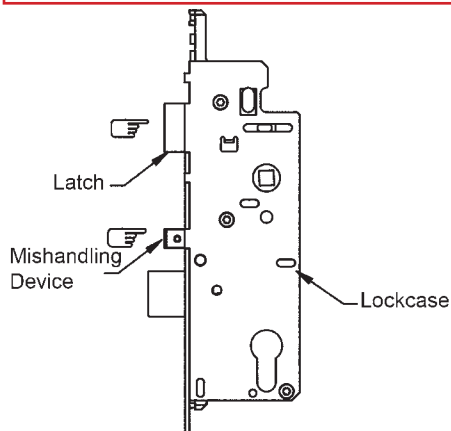

Reversing Latch and Mishandling Device

1. Pull and rotate Latch 180° with hand and release back into lockcase.
2. Pull and rotate Mishandling device 180° with handle and release back into lockcase.

1. The HOPPE® Multipoint Locking Systems are in **most cases** a direct replacement for FUHR Multipoint Systems.
2. There are various sizes and combinations of these Multipoint locking systems. Please fill out the questionnaire and fax it to our sales office to obtain part numbers, pricing and availability.

General Information

- A) If you have a HOPPE or FUHR **Sliding** Door Multipoint System, fill out the **Old FUHR Sliding Door Multipoint Questionnaire** (see page 368).
- B) If you have a HOPPE **Swing** Door Multipoint System with the key cylinder **above** the lever handle, fill out form for the **HLS 7 Series** (see page 412).
- C) If you have a HOPPE or FUHR **Swing** Door Multipoint System with the key cylinder **below** the lever handle, fill out the form for the **HLS 9000 Series** (see page 407).

Swing Hook - 16mm Faceplate

While offering security in the locked position, the HLS9000® swing hook retracts when opened, giving a smooth clean appearance.

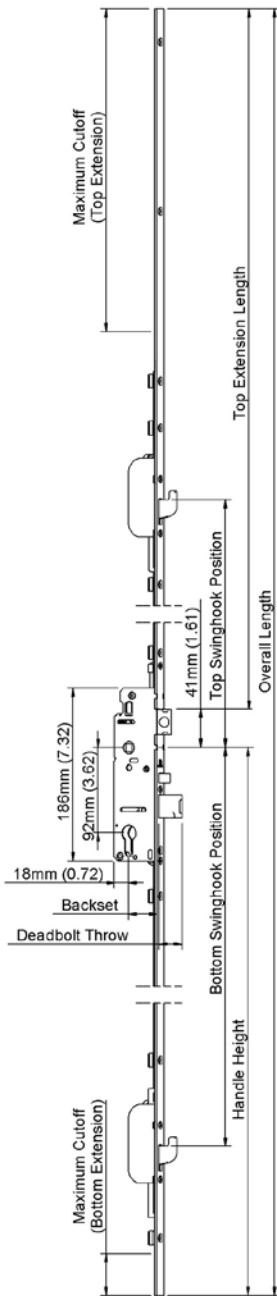
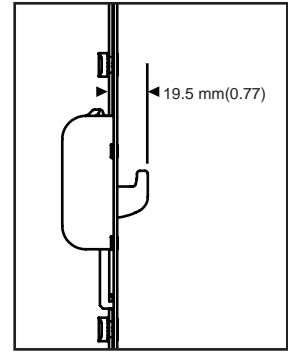
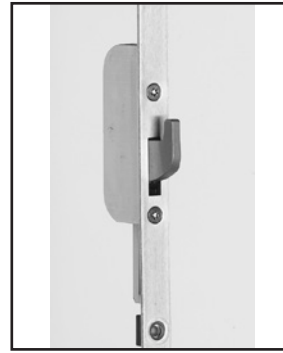

Part Number	Description	Overall Length (with 914mm 36" Handle Height)	Extension Length	Handle to Top of Door	1st Top Swinghook Position	2nd Top Swinghook Position	Maximum Cutoff	Number of Screws
850-3868770	M 1058 SW1 500 16-SC 418	1595mm-2013mm (62.80-79.25)	1058mm (41.65)	1099mm (43.27)	500mm (19.69)	n/a	418mm (16.46)	6
850-3868796	M 1058 SW1 900 16-SC 18	1995mm-2013mm (78.54-79.25)	1058mm (41.65)	1099mm (43.27)	900mm (35.43)	n/a	18mm (0.71)	6
850-3868809	M 1388 SW1 900 16-SC 348	1995mm-2343mm (78.54-92.24)	1388mm (54.65)	1429mm (56.26)	900mm (35.43)	n/a	348mm (13.70)	8
850-3868817	M 1388 SW2 500/900 16-SC 348	1995mm-2343mm (78.54-92.24)	1388mm (54.65)	1429mm (56.26)	500mm (19.69)	900mm (35.43)	348mm (13.70)	8
850-3868825	M 1745 SW2 600/1193 16-SC 412	2288mm-2700mm (90.08-106.30)	1745mm (68.70)	1786mm (70.31)	600mm (23.62)	1193mm (46.97)	412mm (16.22)	10
850-3868833	M 2270 SW2 600/1500 16-SC 630	2595mm-3225mm (102.17-126.97)	2270mm (89.37)	2311mm (90.98)	600mm (23.62)	1500mm (59.05)	630mm (24.80)	12

Part Number	Description	Backset	Deadbolt Throw	Handle Height	Bottom Swing Hook Position	Maximum Cutoff	Number of Screws
850-3868868	M/35/25 914 SW1 753 16S 30	35mm (1.38)	25.4mm (1.00)	914mm (36.00)	753mm (29.65)	30mm (1.18)	5
850-3868876	M/45/25 914 SW1 753 16S 30	45mm (1.77)	25.4mm (1.00)	914mm (36.00)	753mm (29.65)	30mm (1.18)	5

60mm Backset Gear / Bottom Extension

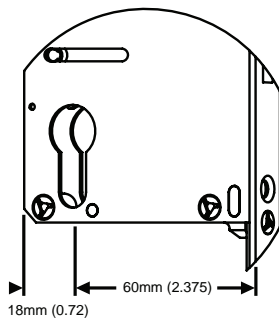

Part Number	Description	Backset	Deadbolt Throw	Handle Height	Bottom Swing Hook Position	Maximum Cutoff	Number of Screws
850-3868884	M/60/25 914 SW1 753 16S 30	60mm (2.375)	25.4mm (1.00)	914mm (36.00)	753mm (29.65)	30mm (1.18)	5

70mm Backset Gear / Bottom Extension

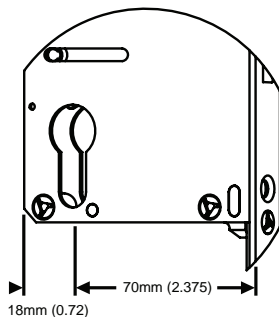

Part Number	Description	Backset	Deadbolt Throw	Handle Height	Bottom Swing Hook Position	Maximum Cutoff	Number of Screws
850-3868892	M/70/25 914 SW1 753 16S 30	70mm (2.75)	25.4mm (1.00)	914mm (36.00)	753mm (29.65)	30mm (1.18)	5

Swing Hook/Shootbolt - 16mm Faceplate

The HLS®9000 Swing Hook/shootbolt offers the added security of both horizontal and vertical strength for increased wind-load protection.

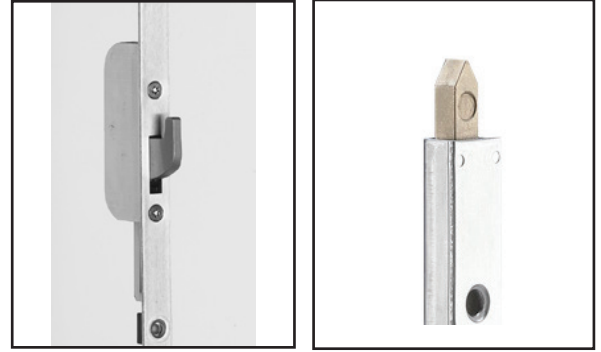

See corresponding colors in chart when referencing top extension length with middle extension chart

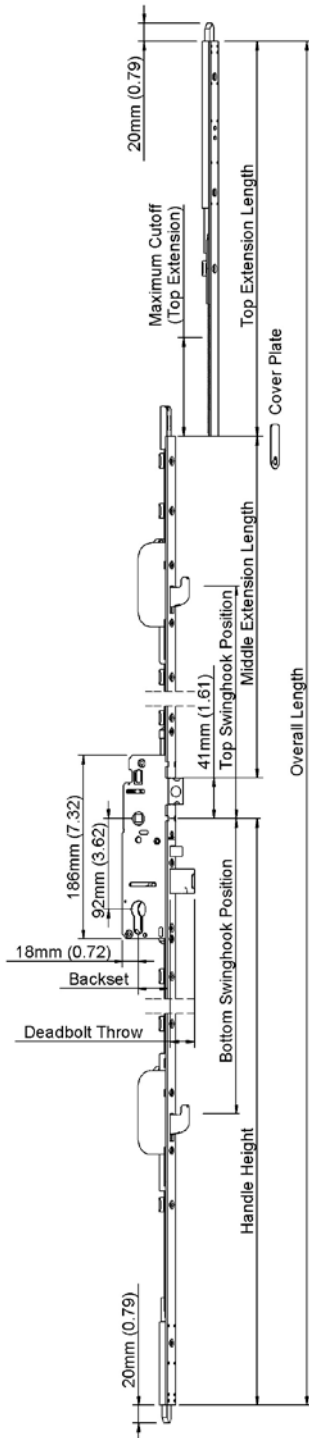

Part Number	Description	Top Extension Length	Maximum Cutoff	Number of Screws	Overall Length Combined with M 612 SW 500 (with 914mm/36" Handle Height)	Overall Length Combined with M 1012 SW 900 (with 914mm/36" Handle Height)
850-8778611	M 400 SB1 16S 20 100	400mm (15.75)	100mm (3.94)	3	1867mm - 1967mm (73.50 - 77.44)	2267mm - 2367mm (89.25 - 93.19)
850-8778615	M 475 SB1 16S 20 100	475mm (18.70)	100mm (3.94)	3	1942mm - 2042mm (76.46 - 80.39)	2342mm - 2442mm (92.20 - 96.14)
850-8778619	M 550 SB1 16S 20 100	550mm (21.65)	100mm (3.94)	4	2017mm - 2117mm (79.41 - 83.35)	2417mm - 2517mm (95.16 - 99.09)
850-8778623	M 625 SB1 16S 20 100	625mm (24.61)	100mm (3.94)	4	2092mm - 2192mm (82.36 - 86.30)	2492mm - 2592mm (98.11 - 102.05)
850-8778627	M 700 SB1 16S 20 100	700mm (27.56)	100mm (3.94)	4	2167mm - 2267mm (85.31 89.25)	2567mm - 2667mm (101.06 - 105.00)
850-8778631	M 775 SB1 16S 20 100	775mm (30.51)	100mm (3.94)	4	2242mm - 2342mm (88.27 - 92.20)	2642mm - 2742mm (104.02 - 107.95)
850-3389488	M 850 SB1 16S 20 100	850mm (33.46)	100mm (3.94)	5	2317mm - 2417mm (91.22 - 95.16)	2717mm - 2817mm (106.97 - 110.91)
850-3389517	M 925 SB1 16S 20 100	925mm (36.42)	100mm (3.94)	5	2392mm - 2492mm (94.17 - 98.11)	2792mm - 2892mm (109.92 - 113.86)

Part Number	Description	Top Extension Length	Maximum Cutoff	Number of Screws	Overall Length Combined with M 1012 SW2 500/900 (with 914mm/36" Handle Height)	Overall Length Combined with M 1305 SW2 600/1193 (with 914mm/36" Handle Height)	Overall Length Combined with M 1612 SW2 600/1500 (with 914mm/36" Handle Height)
8778611	M 400 SB1 16S 20 100	400mm (15.75)	100mm (3.94)	3	2267mm - 2367mm (89.25 - 93.19)	2560mm - 2660mm (100.79 - 104.72)	2867mm - 2967mm (112.87 - 116.81)
8778615	M 475 SB1 16S 20 100	475mm (18.70)	100mm (3.94)	3	2342mm - 2442mm (92.20 - 96.14)	2635mm - 2735mm (103.74 - 107.68)	2942mm - 3042mm (115.83 - 119.76)
8778619	M 550 SB1 16S 20 100	550mm (21.65)	100mm (3.94)	4	2417mm - 2517mm (95.16 - 99.09)	2710mm - 2810mm (106.69 - 110.63)	3017mm - 3117mm (118.78 - 122.72)
8778623	M 625 SB1 16S 20 100	625mm (24.61)	100mm (3.94)	4	2492mm - 2592mm (98.11 - 102.05)	2785mm - 2885mm (109.65 - 113.58)	3092mm - 3192mm (121.73 - 126.67)
8778627	M 700 SB1 16S 20 100	700mm (27.56)	100mm (3.94)	4	2567mm - 2667mm (101.06 - 105.00)	2860mm - 2960mm (112.60 - 116.54)	3167mm - 3267mm (124.69 - 128.62)
8778631	M 775 SB1 16S 20 100	775mm (30.51)	100mm (3.94)	4	2642mm - 2742mm (104.02 - 107.95)	2935mm - 3035mm (115.55 - 119.49)	3242mm - 3342mm (127.64 - 131.67)
3389488	M 850 SB1 16S 20 100	850mm (33.46)	100mm (3.94)	5	2717mm - 2817mm (106.97 - 110.91)	3010mm - 3110mm (118.50 - 122.44)	3317mm - 3417mm (130.59 - 134.53)
3389517	M 925 SB1 16S 20 100	925mm (36.42)	100mm (3.94)	5	2792mm - 2892mm (109.92 - 113.86)	3085mm - 3185mm (121.46 - 125.39)	3392mm - 3492mm (133.54 - 137.48)

Swing Hook/Shootbolt - 16mm Faceplate

Middle Extensions with 1 and 2 Swing Hooks

Middle Extension with 1 Swing Hook

Part Number	Description	Middle Extension	Top Swing Hook Position	Second Swing Hook Position	Maximum Cutoff	Number of Screws
850-3622868	M 612 SW1 500 16S	612mm (24.09)	500mm (19.69)	N/A	N/A	4
850-3644160	M 1012 SW1 900 16S	1012mm (39.84)	900mm (35.43)	N/A	N/A	6

Middle Extension with 2 Swing Hooks

Part Number	Description	Middle Extension	Top Swing Hook Position	Second Swing Hook Position	Maximum Cutoff	Number of Screws
850-3644178	M 1012 SW2 500/900 16S	1012mm (39.84)	500mm (19.69)	900mm (35.43)	N/A	6
850-3644186	M 1305 SW2 600/1193 16S	1305mm (51.38)	600mm (23.62)	1193mm (46.97)	N/A	8
850-3644194	M 1612 SW2 600/1500 16S	1612mm (63.46)	600mm (23.62)	1500mm (59.06)	N/A	9

35/45mm Backset Gear / Bottom Extension

Gear

Part Number	Description	Backset	Deadbolt Throw	Handle Height	Bottom Swing Hook Position	Maximum Cutoff	Number of Screws
850-3814747	M/35/25 914 SW1SB1 620 16S 20	35mm (1.38)	25mm (1.00)	914mm (36.00)	620mm (24.41)	N/A	4
850-3622876	M/45/25 914 SW1SB1 620 16S 20	45mm (1.77)	25mm (1.00)	914mm (36.00)	620mm (24.41)	N/A	4
850-2875118	Cover Plate	-	-	-	-	-	-

60mm Backset Gear / Bottom Extension

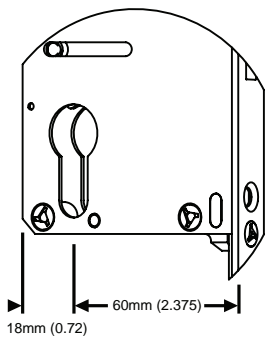

Gear - 60mm Backset

Part Number	Description	Backset	Deadbolt Throw	Handle Height	Bottom Swing Hook Position	Number of Screws
850-3660426	M/60/25 914 SW1SB1 620 16S 20	60mm (2.375)	25.4mm (1.00)	914mm (36.00)	620mm (24.41)	4

70mm Backset Gear / Bottom Extension

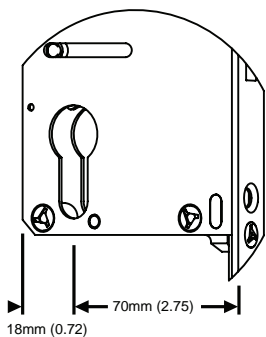

Gear - 70mm Backset

Part Number	Description	Backset	Deadbolt Throw	Handle Height	Bottom Swing Hook Position	Number of Screws
850-3868761	M/70/25 914 SW1SB1 620 16S 20	70mm (2.75)	25.4mm (1.00)	914mm (36.00)	620mm (24.41)	4

#8 Mounting Screws 2 Per Pack



3/4" Long	1-1/2" Long	Finish
850-2100785	850-2104381	Polished Brass/ Brushed Brass
850-2100793	850-2104399	Antique Brass
850-2100831	850-2104436	Brushed Chrome/ Satin Nickel

3/4" Long	1-1/2" Long	Finish
850-2100814	850-2104410	Polished Chrome/ Brushed Stainless Steel
850-2100822	850-2104428	Oil Rubbed Brass/ Matte Black
850-2100849	850-2104444	Antique Nickel

HLS 9000 Single Point Locks

Latch & Deadbolt Strike

Dust Cap

Top Seller

Part #	Backset	Deadbolt Throw
850-11517463	1-3/8"	1/2"
850-11517487	1-3/4"	1/2"
850-11517475	1-3/8"	1"
850-11517499	1-3/4"	1"
850-11517505	2-3/8"	1"
850-11517517	2-3/4"	1"

With Lockout Feature Stainless Steel

For 1-3/4" Door

Part #	Finish
850-8787715	Polished Brass
850-8787719	Antique Brass
850-8787735	Matte Black
850-8787723	Polished Chrome
850-8787727	Brushed Chrome
850-8787731	Oil Rubbed Brass
850-8787739	White Powder Coat
850-8787747	Stainless Steel
850-2127443	Satin Nickel
850-2127427	Antique Nickel

Curved Lip with Cylinder Hole and Non-Handed
Other Configurations Available

For 2-1/4" Door

Part #	Finish
850-2014019	Polished Brass
850-2014027	Stainless Brass
850-2014334	Oil Rubbed Brass
850-2014799	White Powder Coat
850-2014801	Matte Black Powder Coat
850-3772612	Rustic Umber

Curved Lip with Cylinder Hole and Non-Handed
Other Configurations Available

Part #	Finish
850-8786547	Black

For Latch and Deadbolt Strike and Tongue Strike

Roller Strike Plate

Part #	Finish
850-8785003	Brass
850-8784999	Chrome
850-8784991	Oil Rubbed Brass
850-8784995	Raw, Unplated

Tongue Strikes

Socket Strikes

Part #	Finish
850-8784675	Brass
850-1964522	Stainless Steel
850-2121244	Oil Rubbed Brass

Curved Lip

Part #	Finish
850-2025181	Brass
850-2025199	Stainless Steel
850-2025842	Oil Rubbed Brass

Radius Lip

Part #	Finish
850-8784699	Brass
850-8784707	Stainless Steel
850-8786551	Antique Brass
850-8786559	Brushed Chrome
850-8784703	Oil Rubbed Brass
850-8786575	Matte Black
850-2127486	Satin Nickel

Flat

Part #	Finish
850-8784663	Brass
850-8784667	Oil Rubbed Brass

3/4" Throw

Part #	Finish
850-2024962	Brass

1" Throw

Shootbolt Strikes

Auto-Release Strike & Plates for Automatic Systems

Part #	Finish
850-2098945	Stainless Steel

Double Door

Part #	Hand	Finish
850-8784091	LH	Stainless Steel
850-2117325	LH	Oil Rubbed Brass
850-8784067	RH	Brass
850-8783923	RH	Stainless Steel
850-2117261	RH	Oil Rubbed Brass

LH Shown. Curved Lip Single Door

Part #	Finish
850-8784047	Stainless Steel

Part #	Finish
850-2135259	Brass
850-2098911	Stainless Steel

Single Door

Strike Part #	Underplate Part #	Finish
850-8783867	850-8784775	Brass
850-8783871	850-8784783	Stainless
850-8783875	850-8784779	Oil Rub

HLS 7 SERIES MULTIPOINT HARDWARE SWING DOOR QUESTIONNAIRE

This form is for a HOPPE **Swing** Door Multipoint System with the key cylinder **above** the lever handle.

Customer Name: _____ Account Number _____

Contact: _____ Phone Number _____

- HOPPE will be stamped below the latch on the thin metal faceplate that runs along the edge of the door
- Do you know who manufactured the door? How about the windows in your home? If so, please list the company: _____
- Is this for a single door or a pair of doors (french doors)? _____
If pair of doors, what is the thickness of the astragal on the inactive door? Flush 19/32" to 3/4" 3/4" to 29/32" 29/32" to 1" 1" to 1-9/64"
- What is the door thickness: 1-3/4" (45mm) 2-1/4" (57.15mm) Other: _____
- Based on the pictures shown below, please put an "X" by your HLS7 Manual Multipoint System

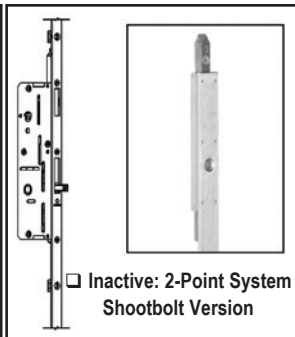
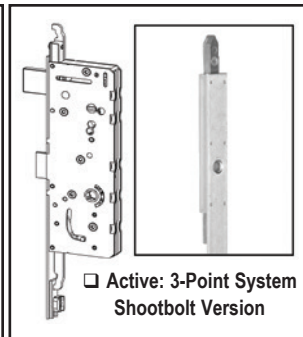
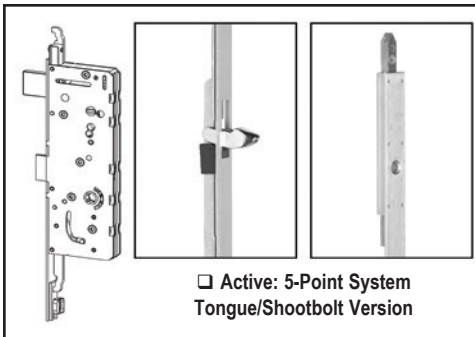
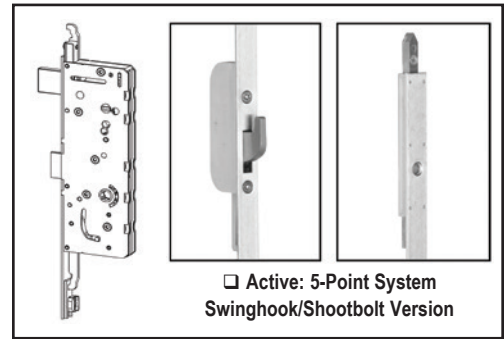
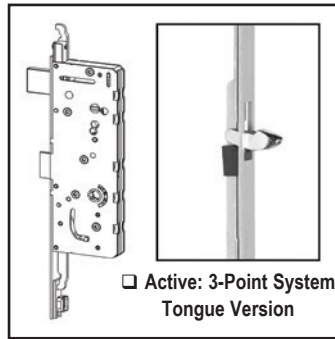
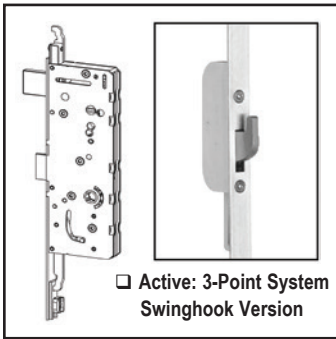

- The metal face plate for all HLS 7 Systems is 5/8" (16mm) wide and is made of stainless steel.
- The shootbolt throw for all HLS 7 Systems is 1" (25mm).
- What is the total height of the door panel?: _____
- Is your door right hand or left hand? RH LH
NOTE: Door handing is determined from the exterior. When hinges are on the left, the door is LH. When hinges are on the right, the door is RH. (Inswing or Outswing does not determine handing)
- If you have a tongue or swinghook version, what is the distance from the center of the handle up to the top tongue or swinghook position?
 15-3/4" (400mm) 23-5/8" (600mm) 29-1/4" (743mm) 37-13/64" (945mm) 40-7/16" (1026.8mm) 46-31/32" (1193mm) 59" (1500mm)
- The handle height for all HLS 7 Systems is 36".
- The distance from the center of the handle to the center of the thumbturn piece for all HOPPE systems is 3-5/8" (92mm).
- Backset for all HLS 7 Systems is 1-3/4" (45mm).
- The deadbolt throw for all HLS 7 Systems is 1" (25mm).
- If you have a tongue or swinghook version, what is the distance from the center of the handle down to the bottom tongue or swinghook position?
 24-13/32" (620mm) 29-21/32" (753mm)

HLS7 SERIES REPLACEMENT PARTS

BACKPLATE GASKETS

QUICK-FIT CONNECTION™ HANDLE TOOL

SPRING CARTRIDGE



Part #
850-2737559
For M2167N Backplate



Part #
850-2737567
For M2172N Backplate



Part #
850-7190528
For Removal of Handle

CYLINDER SCREWS

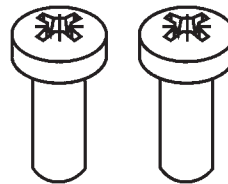

Part #
850-2753946
2 Per Cylinder

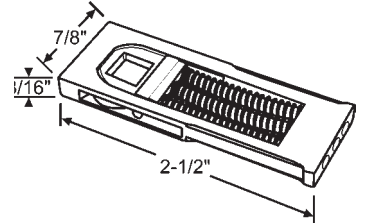

Part #
850-2702170
1 Per Backplate

BACKPLATE BUSHINGS

Resista® Brass	Antique Brass	Brushed Chrome	Polished Chrome	Oil-Rubbed Brass	Pure White	Matte Black	Satin Nickel	Antique Nickel	Rustic Umber
850-387340	850-387340	850-1975598	850-1975598	850-1975619	850-387340	850-1975619	850-1975580	850-1975619	850-387340

PARTS PACK FOR ACTIVE HANDLE SET

Part #
850-2753954

2 Each: C-Washers, Spring Cartridges, Cylinder Screws & Handle Spindles
1 Each: Handle Release Tool and Black Plastic Insert

PARTS PACK FOR INACTIVE HANDLE SET

Part #
850-2753920

2 Each: C-Washers, Spring Cartridges, Cylinder Screws & Handle Spindles
1 Each: Handle Release Tool, Black Plastic Insert and 76mm Tailpiece to Insert in Plastic Insert

PARTS PACK FOR HANDLE SET - 2 BACKPLATE SCREWS

Resista® Brass	Antique Brass	Brushed Chrome	Polished Chrome	Oil-Rubbed Brass	Pure White	Matte Black	Satin Nickel	Antique Nickel	Rustic Umber
850-2699880	850-2781744	850-2725291	850-2781761	850-2781779	850-2781787	850-2781795	850-2725291	850-2781808	850-2781779

SWING DOOR HANDLES

Solid Brass Trim Sets



Allegro Handle
30mm Shown



Capri Handle
45mm Shown



Torino Handle
45mm Shown

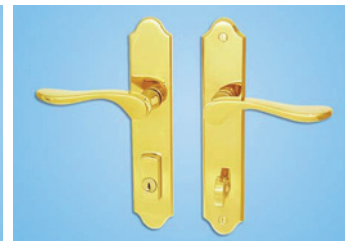

Venice Handle
45mm Shown

Handle Above Style

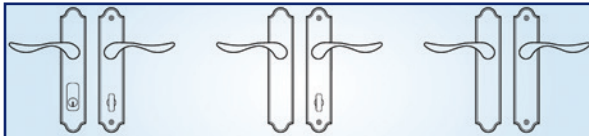

Active
(Keyed)

Semi-Active
(Non-Keyed)

Fixed
(Dummy)

Handle Below Style

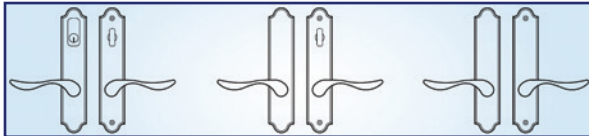

Active
(Keyed)

Semi-Active
(Non-Keyed)

Fixed
(Dummy)

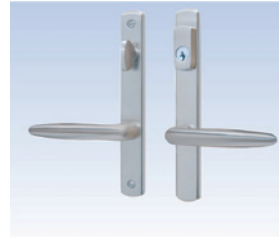

Torino Handle
30mm Shown



Venice Handle
30mm Shown



Black Powder Coat

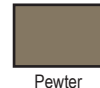

Pewter



Satin Chrome



Polished Brass



Antique Brass



Oil Rubbed Bronze



Satin Nickel



Dark Bronze

- Solid brass trim sets
- Stainless Steel set screw on levers to secure spindle
- US cylinder with standard Schlage "C" keyway
- 90° locking with thumb-turn
- Unassembled kit for 1 3/4" and 2 1/4" thick doors
- Self-centering spindle
- Use with mortise lock, SECURITY S2, SH2 and SECURITY Automatic door gears
- Patented handle clipping system
- Available in both 30mm & 45mm plate. See chart below.

SOLID BRASS TRIM SETS (PART NUMBERS)

Style	Plate Size	Handle Position	Function	Satin Chrome	Polished Brass	Antique Brass	Oil Rubbed Bronze	Satin Nickel	Dark Bronze	Pewter	Black Powder Coat
Allegro	30mm	Above Cylinder	Active	854-15704	854-15854	854-15855	854-15856	854-15857	854-15858	854-15859	
Allegro	30mm	Below Cylinder	Active	854-15860	854-15861	854-15862	854-15863	854-15864	854-15865	854-15866	
Allegro	30mm	Above or Below	Semi-Active	854-15741	854-15849	854-15850	854-15851	854-15833	854-15852	854-15853	
Allegro	30mm	Above or Below	Fixed	854-15705	854-15844	854-15845	854-15846	854-15592	854-15847	854-15848	
Torino	30mm	Above Cylinder	Active	854-15878	854-15879	854-15880		854-15881	854-15882	854-15883	
Torino	30mm	Below Cylinder	Active	854-15884	854-15885	854-15886		854-15887	854-15888	854-15889	
Torino	30mm	Above or Below	Semi-Active	854-15873	854-15874	854-15875		854-15678	854-15876	854-15877	
Torino	30mm	Above or Below	Fixed	854-15867	854-15868	854-15869		854-15870	854-15871	854-15872	
Venice	30mm	Above Cylinder	Active	854-15901	854-15902	854-15903	854-16153	854-15809	854-15597	854-15904	
Venice	30mm	Below Cylinder	Active	854-15905	854-15814	854-15906		854-15907	854-15908	854-15909	
Venice	30mm	Above or Below	Semi-Active	854-15896	854-15897	854-15898		854-15899	854-15598	854-15900	
Venice	30mm	Above or Below	Fixed	854-15890	854-15891	854-15892		854-15893	854-15894	854-15895	
Torino	45mm	Above Cylinder	Active	854-16035	854-16036	854-16037	854-16038	854-16039	854-16040	854-16041	854-16042
Torino	45mm	Below Cylinder	Active	854-16043	854-16044	854-16045	854-16046	854-16047	854-16048	854-16049	
Torino	45mm	Above or Below	Semi-Active	854-16028	854-16029	854-16030	854-16031	854-15706	854-16032	854-16033	854-16034
Torino	45mm	Above or Below	Fixed	854-16020	854-16021	854-16022	854-16023	854-16024	854-16025	854-16026	854-16027
Venice	45mm	Above Cylinder	Active	854-16067	854-15535	854-16068	854-16069	854-16070	854-15594	854-16071	854-16073
Venice	45mm	Below Cylinder	Active	854-16074	854-16076	854-16077	854-16078	854-16079	854-16080	854-16081	
Venice	45mm	Above or Below	Semi-Active	854-16059	854-15536	854-16061	854-16062	854-15677	854-16063	854-16064	854-16066
Venice	45mm	Above or Below	Fixed	854-15827	854-16051	854-16052	854-16053	854-16054	854-16055	854-16056	854-16058
Capri	45mm	Above Cylinder	Active	854-15763	854-15554	854-16011	854-15596	854-15764	854-15737	854-16012	854-15734
Capri	45mm	Below Cylinder	Active	854-16014	854-15708	854-16015	854-15788	854-16016	854-16017	854-16018	
Capri	45mm	Above or Below	Semi-Active	854-16005	854-15556	854-16007	854-15580	854-15826	854-15606	854-16008	854-15843
Capri	45mm	Above or Below	Fixed	854-15998	854-16000	854-16001	854-16002	854-15825	854-15815	854-16003	854-15735

SWING DOOR HANDLES

Zamac Trim Sets



Allegro Handle
30mm Shown

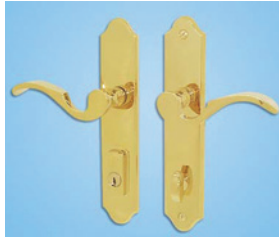

Capri Handle
45mm Shown



Torino Handle
45mm Shown



Venice Handle
45mm Shown

Handle Above Style

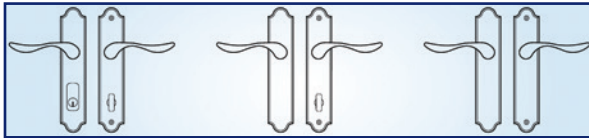

Active
(Keyed)

Semi-Active
(Non-Keyed)

Fixed
(Dummy)

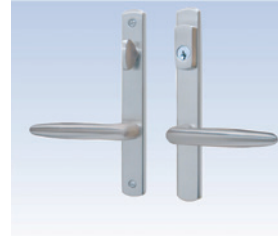

Torino Handle
30mm Shown



Venice Handle
30mm Shown

Handle Below Style

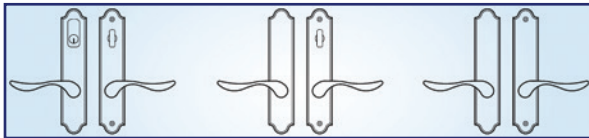

Active
(Keyed)

Semi-Active
(Non-Keyed)

Fixed
(Dummy)



Dark
Bronze



White Powder
Coat



Satin
Chrome



Polished
Brass



Antique
Brass



Dark Bronze
Powder Coat



Black Powder
Coat



Pewter

- Zamac trim sets
- Stainless Steel set screw on levers to secure spindle
- US cylinder with standard Schlage "C" keyway
- 90° locking with thumb-turn
- Unassembled kit for 1 3/4" and 2 1/4" thick doors
- Self-centering spindle
- Use with mortise lock, SECURITY S2, SH2 and SECURITY Automatic door gears
- Patented handle clipping system
- Available in both 30mm & 45mm plate. See chart below.

ZAMAC TRIM SETS (PART NUMBERS)

Style	Plate Size	Handle Position	Function	Satin Chrome	Polished Brass	Antique Brass	Dark Bronze Powder Coat	Black Powder Coat	Pewter	White Powder Coat	Dark Bronze
Allegro	30mm	Above Cylinder	Active	854-15924		854-15925	854-15927	854-15928	854-15926	854-15929	
Allegro	30mm	Below Cylinder	Active	854-15930	854-15748	854-15932	854-15934	854-15935	854-15933	854-15936	
Allegro	30mm	Above or Below	Semi-Active	854-15917	854-15918	854-15919	854-15921	854-15922	854-15920	854-15923	
Allegro	30mm	Above or Below	Fixed	854-15910	854-15911	854-15912	854-15914	854-15915	854-15913	854-15916	
Torino	30mm	Above Cylinder	Active	854-15954	854-15955	854-15956	854-15958	854-15959	854-15957	854-15960	
Torino	30mm	Below Cylinder	Active	854-15961	854-15962	854-15963	854-15965	854-15966	854-15964	854-15967	
Torino	30mm	Above or Below	Semi-Active	854-15947	854-15948	854-15949	854-15951	854-15952	854-15950	854-15953	
Torino	30mm	Above or Below	Fixed	854-15940	854-15941	854-15942	854-15944	854-15945	854-15943	854-15946	
Venice	30mm	Above Cylinder	Active	854-15982	854-15983	854-15984	854-15987	854-15988	854-15986	854-15989	
Venice	30mm	Below Cylinder	Active	854-15990	854-15991	854-15992	854-15994	854-15995	854-15993	854-15996	
Venice	30mm	Above or Below	Semi-Active	854-15975	854-15976	854-15977	854-15979	854-15980	854-15978	854-15981	
Venice	30mm	Above or Below	Fixed	854-15968	854-15969	854-15970	854-15972	854-15973	854-15971	854-15974	
Torino	45mm	Above Cylinder	Active	854-15758			854-16107	854-16108	854-16106	854-16109	
Torino	45mm	Below Cylinder	Active	854-16110	854-15747	854-16111	854-16113	854-16114	854-16112	854-16115	
Torino	45mm	Above or Below	Semi-Active	854-16099	854-16100	854-16101	854-16103	854-16104	854-16102	854-16105	
Torino	45mm	Above or Below	Fixed	854-15759	854-16093	854-16094	854-16096	854-16097	854-16095	854-16098	
Venice	45mm	Above Cylinder	Active		854-15757		854-15721	854-16131	854-16130	854-16132	854-15571
Venice	45mm	Below Cylinder	Active	854-16133	854-15755	854-16134	854-16136	854-16137	854-16135	854-16138	
Venice	45mm	Above or Below	Semi-Active	854-16123	854-16124	854-16125	854-16127	854-16128	854-16126	854-16129	
Venice	45mm	Above or Below	Fixed	854-16116	854-16117	854-16118	854-16120	854-16121	854-16119	854-16122	
Capri	45mm	Above Cylinder	Active				854-15824	854-16089		854-15586	
Capri	45mm	Below Cylinder	Active				854-16090	854-16091		854-16092	
Capri	45mm	Above or Below	Semi-Active				854-16086	854-16087		854-16088	
Capri	45mm	Above or Below	Fixed				854-16083	854-16084		854-16085	

MULTIPOINT HARDWARE SWING DOOR QUESTIONNAIRE

Acct. #: _____

Date: _____

Customer Name: _____

Phone: _____

Address: _____

Fax: _____

Email: _____

1. Is the faceplate stamped with G-U or Ferco? G-U Ferco Other: _____
2. Is this for a single door or a pair of doors (French doors)? _____
3. What is the door thickness? 3/4" (45mm) 2-1/4" (57mm) Other: _____
4. Do you know who manufactured your door? _____ Do you know the age of your door? _____
5. What is the finish/color of your Multipoint system?
 - Painted Silver (Ferguard) Stainless Steel Yellow Dichromate (Brass looking)
 - Black Matte White
6. What is the distance from the center of the handle to the center of the key cylinder?
 - 2-7/32" (56mm) 2-3/4"(70mm) 3-5/8" (92mm, Standard) Other: _____
7. What is the door panel height (the door panel is the part that opens and closes)? _____
8. Is this a "Manual" (locks are engaged by lifting lever upwards) or "Automatic" (locks engage automatically when you close the door) system? Manual. Automatic.
9. What is the width across of this metal faceplate? 5/8" (16mm) 25/32" (20mm) Other _____
10. Are the faceplate ends: Square or Radius/Round?
11. Is the key cylinder located above (American version) or below (European version) the handle? _____
12. Does the teardrop on your mortise gear box take a full cylinder or is there an insert in the round part of the teardrop that accepts a tailpiece to engage the deadbolt?
 - Full Cylinder Insert Accepts Tailpiece (see picture of single point locks on following page)
13. Backset: What is the horizontal distance from the center of the handle to the door edge (edge with the latch and deadbolt on it)?
 - 1-3/16" (30mm) 1-3/8" (35mm) 1-9/16" (40mm) 1-3/4" (45mm)
 - 2" (50mm) 2-3/16" (55mm) 2-3/8" (60mm) 2.55"(65mm)
14. Based on the locking options on the following page, please put an "X" by the name of your G-U Multipoint System:

American Version (Key Above Handle)

- | | |
|--|---|
| <ul style="list-style-type: none"> <input type="checkbox"/> Wolverine: Manual 3-point locking system (Active Door)
Top & Bottom Shootbolt and Deadbolt <input type="checkbox"/> Wolverine: Manual 2-point locking system (Inactive Door)
Top & Bottom Shootbolt <input type="checkbox"/> Eagle: Automatic 3-point locking system (Security US)
2 Additional Latches and Deadbolt | <ul style="list-style-type: none"> <input type="checkbox"/> Hawk: Semi-Automatic 3-point locking system
2 Additional Latches and Deadbolt <input type="checkbox"/> SH2 (Rhino): Swing Hook System Other: _____ |
|--|---|

European Version (Key Below Handle)

- | | |
|--|--|
| <ul style="list-style-type: none"> <input type="checkbox"/> Cremona: Manual 3-point locking system (Active Door)
Top & Bottom Shootbolt with Latch and Deadbolt <input type="checkbox"/> Cremona/Europa: Manual 2-point locking system (Inactive Door)
Top & Bottom Shootbolt without Latch and Deadbolt <input type="checkbox"/> Rhino: Manual 3-point locking system
2 Horn Type Bolts and Deadbolt <input type="checkbox"/> Rhino: Manual 5-point locking system
2 Horn Type Bolts, Top & Bottom Shootbolt and Deadbolt | <ul style="list-style-type: none"> <input type="checkbox"/> Tripact: Manual 3-point locking system
2 Hook/Tongue Bolts and Deadbolt <input type="checkbox"/> Tripact/Cremona: Manual 5-point locking system
2 Hook/Tongue Bolts, Top & Bottom Shootbolt and Deadbolt <input type="checkbox"/> Europa R2: Manual 5-point locking system
2 Rollers, Top & Bottom Shootbolt and Deadbolt <input type="checkbox"/> Security Euro: Automatic 3-point locking system.
2 Additional Latches and a Deadbolt. |
|--|--|

REFER TO MEASURING GUIDELINES ON FOLLOWING PAGE TO ANSWER QUESTIONS BELOW

15. DEADBOLT THROW: Is the throw on the deadbolt 1"(25.4mm) or 3/4" (19.05mm)
16. HANDLE HEIGHT: The distance from the center of the door handle to the bottom edge of the door is: 35"(889mm) 36"(914.4mm) Other: _____
17. BOTTOM LOCK POSITION "A": What is the distance from the center of the handle to the center of the bottom locking point? _____ (See image 1. on next page)
18. TOP LOCK POSITION "B": What is the distance from the center of the handle to the center of the top locking point? _____ (See image 1. on next page)
(Your actual lock may look different).

LOCKING OPTIONS FOR MULTIPOINT QUESTIONNAIRE

Locking Options

Measuring Guidelines

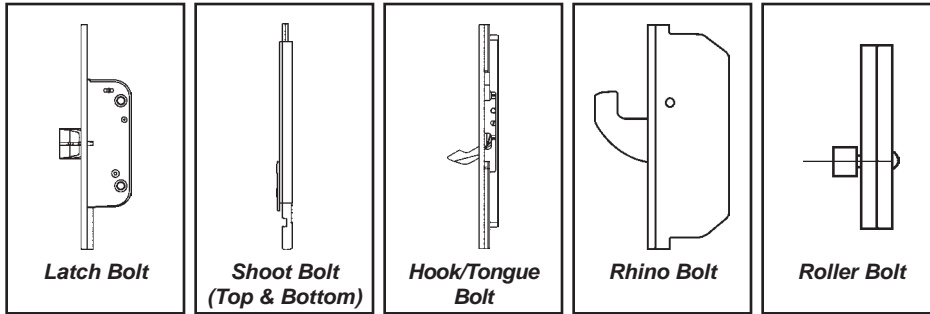
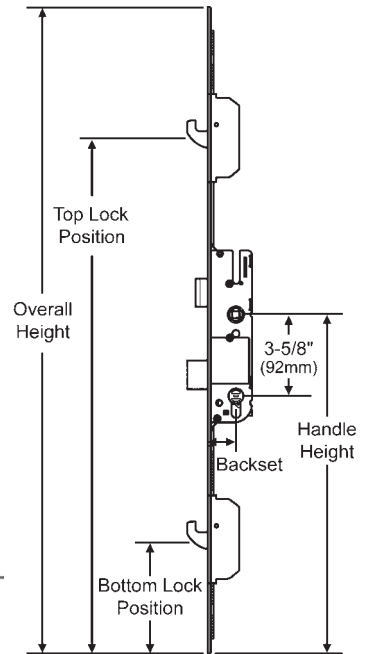
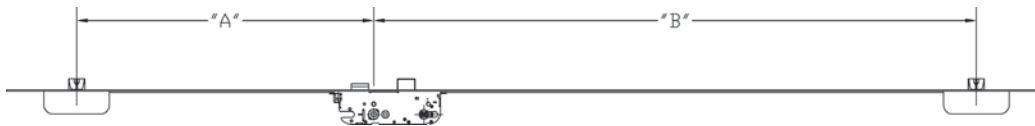
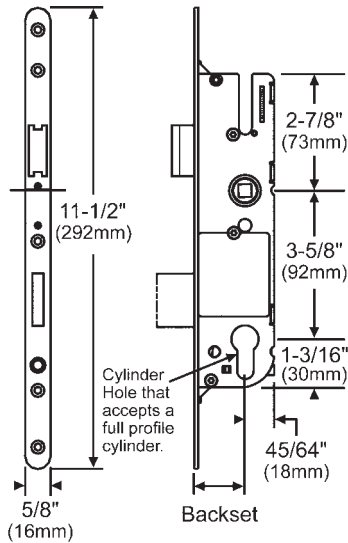

Image 1.



SINGLE POINT MORTISE LOCKS

Key Cylinder Below Handle



Part Number	Backset
854-15559	30mm
854-15492	35mm
854-15560	40mm
854-15561	45mm
854-15488	50mm
854-15552	55mm

Stainless Steel

Key Cylinder Below Handle

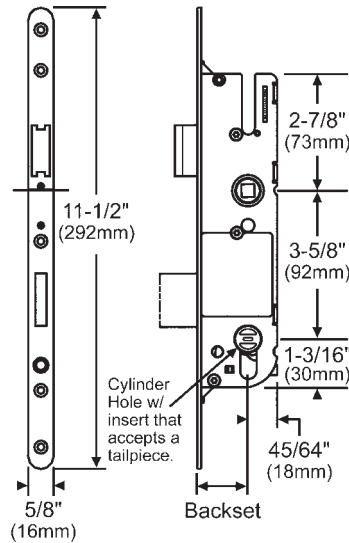

Part Number	Backset
854-15562	30mm
854-11113	35mm
854-15284	40mm
854-15563	45mm
854-15489	50mm
854-15551	55mm

Stainless Steel

Key Cylinder Above Handle

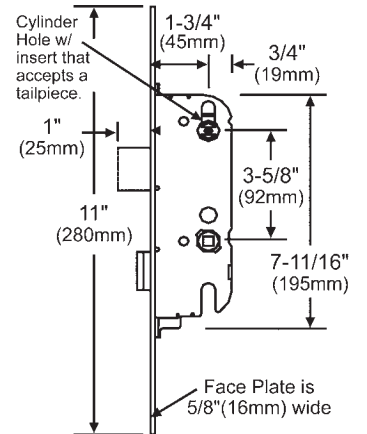

Part Number	Backset
854-10549	45mm

Stainless Steel

SWING DOOR ACCESSORIES

Plastic Cup



Part Number	Color
854-15515	Black

Plastic Cup. Use for Latch and 2 Automatic Latches (Optional).



Part Number	Color
854-15595	Black

Plastic Cup. Use for Latch and 2 Automatic Latches (Optional).

Screws



Part Number	Color
854-15711	Polished Brass
854-15712	Antique Brass
854-15579	Dark Bronze PC
854-15716	Black
854-15713	Stainless Steel
854-15714	Pewter

Bag of 6 Screws for Keepers
8 x 5/8" Flat Head, Philips.

Keepers



Part Number	Color
854-15787	Antique Brass
854-15709	Stainless Steel

Top and Bottom Keeper. Reversible. 2 #8 x 5/8" Flat Head, Philips Screws Included.



Part Number	Color
854-15725	Antique Brass
854-15599	Dark Bronze PC
854-16173	Polished Brass

Top and Bottom Keeper for 45 mm (1-3/4") Thick Doors. Non Handed. Clear Protective Film. Available in Handle Matching Finishes. 2 #8 x 5/8" Flat Head, Philips Screws Included.



Part Number	Color
854-15745	Dark Bronze PC

Top and Bottom Keeper for 57 mm (2-1/4") Thick Doors. Non Handed. Clear Protective Film. Available in Handle Matching Finishes. 2 #8 x 5/8" Flat Head, Philips Screws Included.



Part Number	Color
854-15524	Polished Brass
854-15841	Dark Bronze PC
854-15549	Stainless Steel

Middle Keeper for 45 mm (1-3/4") Thick Doors. Non Handed. Clear Protective Film. #8 x 5/8" Flat Head, Philips Screws Included.



Part Number	Color
854-15771	Polished Brass
854-15585	Dark Bronze PC
854-15553	Black PC
854-15544	Stainless Steel

Middle Keeper for 57 mm (2-1/4") Thick Doors. Non Handed. Clear Protective Film. #8 x 5/8" Flat Head, Philips Screws Included.



Part Number	Color
854-15694	Polished Brass
854-15695	Antique Brass
854-15578	Dark Bronze PC
854-15696	Black PC
854-15697	Stainless Steel
854-15798	Pewter

For 45 mm (1-3/4") Thick Doors. For Use with SECURY S2 and SH2 Door Lock. Bag of 1 Middle Keeper, 2 Top & Bottom Keepers & 6 Screws. Non Handed with Clear Protective Film



Part Number	Color
854-15699	Polished Brass
854-15700	Antique Brass
854-15701	Dark Bronze PC
854-15702	Black PC
854-15538	Stainless Steel
854-15703	Pewter

For 57 mm (2-1/4") Thick Doors. For Use with SECURY S2 and SH2 Door Lock. Bag of 1 Middle Keeper, 2 Top & Bottom Keepers & 6 Screws. Non Handed with Clear Protective Film



Part Number	Color
854-15683	Polished Brass
854-15684	Antique Brass
854-15532	Dark Bronze PC
854-15685	Black PC
854-15686	Stainless Steel
854-15687	Pewter

For 45 mm (1-3/4") Thick Doors. For Use with SECURY Automatic Door Lock. Bag of 1 Middle Keeper, 2 Top & Bottom Keepers & 6 Screws. Non Handed with Clear Protective Film



Part Number	Color
854-15689	Polished Brass
854-15690	Antique Brass
854-15688	Dark Bronze PC
854-15691	Black PC
854-15692	Stainless Steel
854-15693	Pewter

For 57 mm (2-1/4") Thick Doors. For Use with SECURY Automatic Door Lock. Bag of 1 Middle Keeper, 2 Top & Bottom Keepers & 6 Screws. Non Handed with Clear Protective Film

SWING DOOR ACCESSORIES

Construction Handle

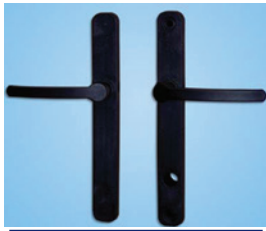

Part Number	Color
854-15531	Black

- Reinforced nylon temporary door trim sets
- 8 x 8 x 90mm square spindle included
- 4, 2 x 50mm screws included
- For 1 3/4" thick doors
- Locking/Unlocking from inside only

Construction Key



Part Number	Color
854-13109	Black

The construction key is available for those who prefer to install the decorative hardware trim and lever sets on doors after the construction has been completed. Installing the escutcheon plates and levers in the final stage of construction prevents the decorative trim from becoming scratched or damaged. The construction key has been designed to accommodate multipoint door hardware (8mm square), tilt-turn hardware (7mm square) and lift-slide hardware (10mm square).

Handle Extenders



Part Number	Color
854-15736	Polished Brass
854-15817	Satin Nickel
854-16140	Oil Rubbed Bronze

- Made of solid brass
- Use with our solid brass handle sets

Shoot Bolt Sleeve



Part Number	Color	A	B
854-12933	Brass	11/16"	7/8"
854-12798	Brass	5/8"	7/8"

Strikers



Part Number	Color
854-16175	Black

Plastic striker



Part Number	Color
854-16176	Black

Short striker cup. 22.6 mm for shoot bolts



Part Number	Color
854-16177	Black

Long striker cup. 30 mm for shoot bolts

Screws for Lever Handle Sets



M5 X 55mm		M5 X 65mm		M5 X 70mm		M5 X 80mm	
Part Number	Finish	Part Number	Finish	Part Number	Finish	Part Number	Finish
854-13710	Satin Chrome	854-13726	Satin Chrome	854-13739	Satin Chrome	854-13750	Satin Chrome
854-13711	Polished Brass	854-13728	Polished Brass	854-13741	Polished Brass	854-13752	Polished Brass
854-13713	Antique Brass	854-13729	Antique Brass	854-13742	Antique Brass	854-13753	Antique Brass
854-13714	Oil Rubbed Bronze	854-13730	Oil Rubbed Bronze	854-13743	Oil Rubbed Bronze	854-13754	Oil Rubbed Bronze
854-13721	Dark Bronze	854-13735	Dark Bronze	854-13747	Dark Bronze	854-13758	Dark Bronze
854-13722	Pewter	854-13736	Pewter	854-13748	Pewter	854-13759	Pewter

Set Screw



Part Number	Color
854-14048	Zinc

M5 x 6 Set Screw

Spindle

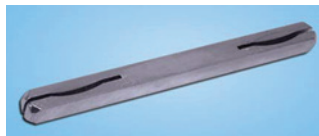

Part Number	Color
854-14112	Zinc

8 x 8 x 130 mm Spindle

Cylinders



Part Number	Color
854-15765	Zinc
854-15766	Brass
854-15767	Dark Bronze

Cylinder with 52 mm tail



Part Number	Color
854-15768	Zinc
854-15769	Brass
854-15770	Dark Bronze

Cylinder with 64 mm tail

AMESBURY MULTIPOINT HARDWARE SWING DOOR QUESTIONNAIRE

Acct. #: _____ Date: _____
 Customer Name: _____ Phone: _____
 Address: _____ Fax: _____
 _____ E-mail: _____

1. Door Type: Wood PVC Fiberglass Aluminum
2. Door Style: Single Double/ French* (Fill out separate form for each door)
 *If door has Astragal, what is the thickness? _____
3. Door Thickness: _____
4. Hole spacing between handle and key cylinder: 3-5/8" (92mm) Standard Other
5. The mortise gear box has an insert to accept a tailpiece.
6. **HANDLE HEIGHT:** What is the distance from the center of the handle down to the horizontal edge of the door (36" Standard)? _____
7. **BACKSET:** What is the distance from the **center** of the handle to the door **edge** (edge with the latch and deadbolt on it)?
 1-3/8" (35mm) 1-3/4" (45mm) 2-3/8" (60mm)
8. Faceplate Width: 5/8" (16mm) 25/32" (20mm)
9. Door Panel Height: _____
10. Based on the pictures shown below, please put an "X" by your Amesbury Multipoint System:

Premier 3000 (Key Above Handle)

Premier 2000 (Key Below Handle)

Premier 1000 (Key Below Handle)

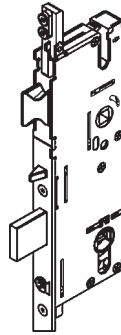

Active:
3-point
Shootbolt
Version

Active:
3-point
Tongue
Version

Active:
3-point
Rhino
Version

Active:
4-point Rhino/
Shootbolt
Version

Active:
5-point Tongue
/Shootbolt
Version

Active:
5-point Rhino/
Shootbolt
Version

Inactive:
2-point
Shootbolt
Version

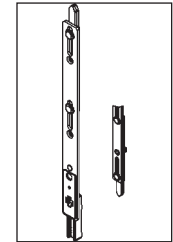
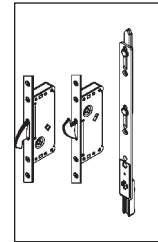
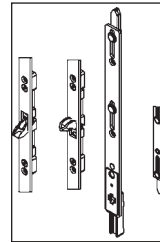
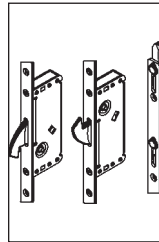
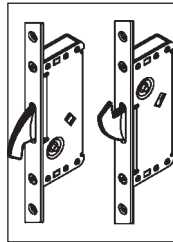
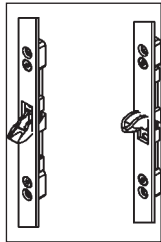
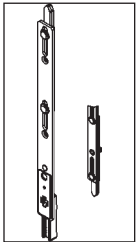

(1) Deadbolt (1" Throw)
(2) Shootbolts (20mm Throw)

(1) Deadbolt (1" Throw)
(2) Tongues

(1) Deadbolt (1" Throw)
(2) Rhino Hooks

(1) Deadbolt (1" Throw)
(1) Shootbolts (20mm Throw)
(2) Rhino Hooks

(1) Deadbolt (1" Throw)
(2) Shootbolts (20mm Throw)
(2) Tongues

(1) Deadbolt (1" Throw)
(2) Shootbolts (20mm Throw)
(2) Rhino Hooks

(2) Shootbolts (20mm Throw)

11. Top Tongue Position (measured from the center of the handle to the center of the top tongue):
 18-59/64" (480.5mm) 26-25/64" (670.4mm) 32-57/64" (835.55mm)
12. Bottom Tongue Position (measured from the center of the handle to the center of the bottom tongue):
 26-27/64" (671mm)
13. Top Rhino Hook Position (measured from the center of the handle to the center of the top hook):
 14-15/32" (367.5mm) 27-15/32" (697.7mm) 40-15/32" (1028mm)
14. Bottom Rhino Hook Position (measured from the center of the handle to the center of the bottom hook):
 24-7/8" (631.7mm)

SINGLE POINT MORTISE GEAR BOX AND ACCESSORIES

Latch & Deadbolt Strikes

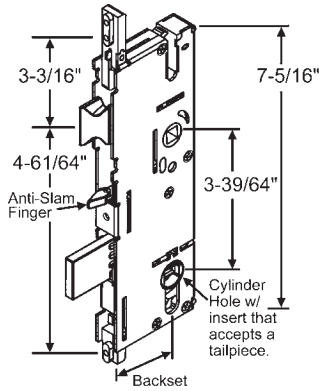

Part Number	Backset
56-243	35mm
56-207	45mm

5/8" Case Width & 1" Deadbolt Throw

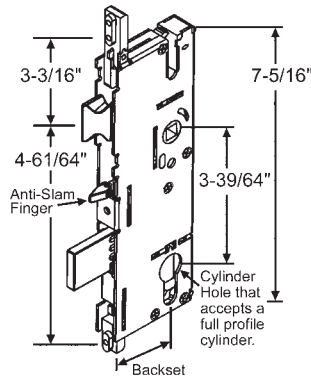

Part Number	Backset
56-244	35mm
56-245	45mm

5/8" Case Width & 1" Deadbolt Throw

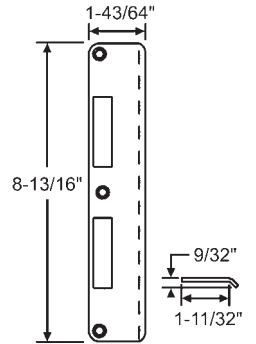

56-232SS

Brushed Stainless Steel

Shootbolt Strikes

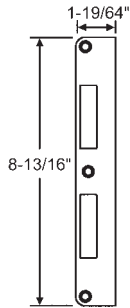

56-233SS

Brushed Stainless Steel

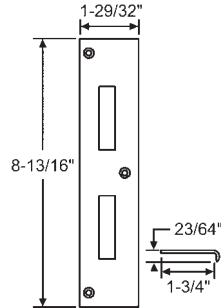

56-234SS

Brushed Stainless Steel

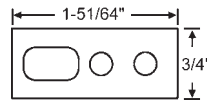

56-235SS

Single Shootbolt. Stainless Steel

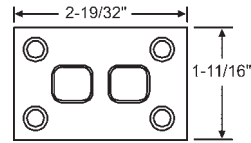

56-236SS

Double Shootbolt. Stainless Steel

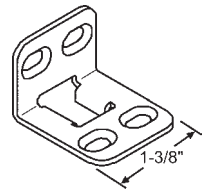

56-237SS

Corner Shootbolt. Brushed Stainless Steel

Tongue Strike

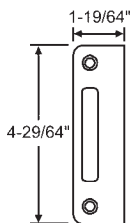

56-238SS

Brushed Stainless Steel

Adjustable Strikes

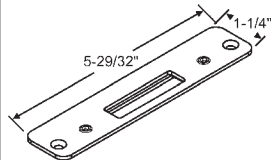

56-241SS

Flat Style. Stainless Steel

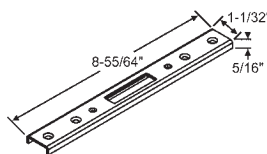

56-242SS

Formed Style. Stainless Steel

Dust Cap

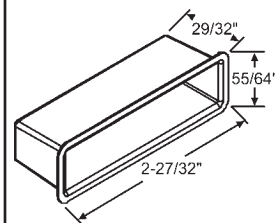

56-240

Spring Cassette

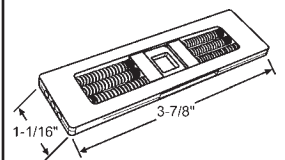

56-221

Stainless Steel

HINGES

FEATURES AND BENEFITS

- Non-Handed Design Reduces Inventory
- Both Vertically and Horizontally Adjustable
 - Horizontal Adjustment $\pm .156$
 - Vertical Adjustment $\pm .200$
- Vertical Adjustment in Each Hinge Allows for Heavier Panels
- Adjusts with a Standard #2 Square Drive.
- Square Drive Prevents Stripping Over Phillips or Slotted
- Secure Out-Swing Non-Removable Pin Hinges Available
- Fits Common Fabrication within the Industry
- Screws Sold Separately (#20-801-Color)

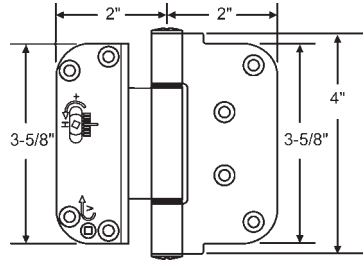

Screws Only

Screw Size	Finish	Part Number
#8-32 x 3/4"	Antique Brass	20-801-75AB
#8-32 x 3/4"	Stainless Steel	20-801-75SS
#8-32 x 3/4"	Wet White	20-801-75WW
#8-32 x 3/4"	Black	20-801-75BLK
#8-32 x 3/4"	Vision Tan	20-801-75VT
#8-32 x 3/4"	Satin White	20-801-75SW
#8-32 x 3/4"	Craftsman Bronze	20-801-75ORB
#8-32 x 2"	Wet White	20-801-200WW
#8-32 x 2"	Black	20-801-200BLK
#8-32 x 2"	Craftsman Bronze	20-801-200ORB
#8-32 x 2"	Antique Brass	20-801-200AB
#8-32 x 3"	Solid Brass PVD	20-801-300PB
#8-32 x 3"	Antique Brass	20-801-300AB
#8-32 x 3"	Stainless Steel	20-801-300SS
#8-32 x 3"	Wet White	20-801-300WW
#8-32 x 3"	Black	20-801-300BLK

Part Number	Finish	Material	Pin
56-155B	Black	Steel	Removable
56-155CRBZ	Craftsman Bronze	Steel	Removable
56-155DOBZ	Dark Oil Rubbed Bronze	Steel	Removable
56-155SNK	Satin Nickel PVD	Steel	Removable
56-440SNK	Satin Nickel PVD	Brass	Removable
56-440PB	Solid Brass PVD	Brass	Removable
56-156B	Black	Steel	Non-Removable
56-156CRBZ	Craftsman Bronze	Steel	Non-Removable
56-156DOBZ	Dark Oil Rubbed Bronze	Steel	Non-Removable
56-440PB-NRP	Solid Brass PVD	Brass	Non-Removable

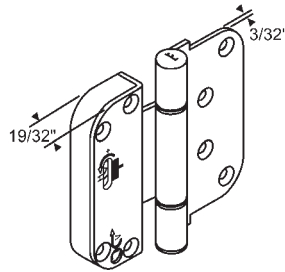

Phillips Flat Head

Simple affordable, adjustable hinge for swing patio doors. With a twist of a screwdriver, they're realigned for a perfect fit. All without removing the door.

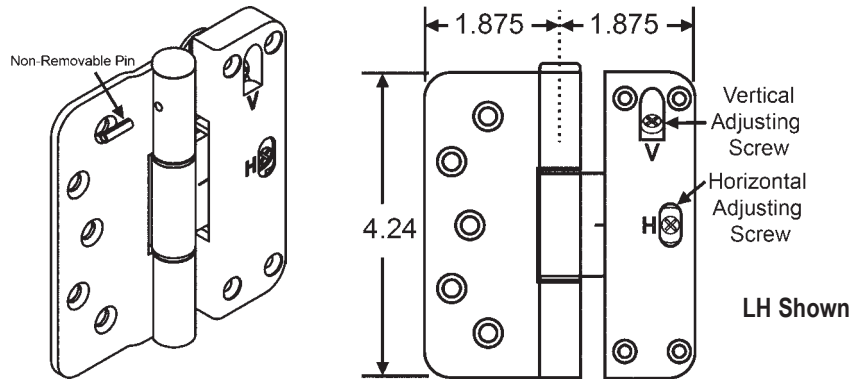

Part Number	Finish	Hand	Pin
56-147ABLH	Antique Brass	LH	Removable
56-147ABRH	Antique Brass	RH	Removable
56-147ANLH	Antique Nickel	LH	Removable
56-147ANRH	Antique Nickel	RH	Removable
56-147BOLH	Black	LH	Removable
56-147BORH	Black	RH	Removable
56-147CHLH	Chrome	LH	Removable
56-147CHRH	Chrome	RH	Removable
56-147ORBZLH	Oil Rubbed Bronze	LH	Removable
56-147ORBZRH	Oil Rubbed Bronze	RH	Removable
56-147SCLH	Seacoast	LH	Removable
56-147SCRH	Seacoast	RH	Removable
56-147WLH	White	LH	Removable
56-147WRH	White	RH	Removable

Part Number	Finish	Hand	Pin
56-147ANLH-NRP	Antique Nickel	LH	Non-Removable
56-147ANRH-NRP	Antique Nickel	RH	Non-Removable
56-147BOLH-NRP	Black	LH	Non-Removable
56-147BORH-NRP	Black	RH	Non-Removable
56-147CHLH-NRP	Chrome	LH	Non-Removable
56-147CHRH-NRP	Chrome	RH	Non-Removable
56-147GLH-NRP	Gold	LH	Non-Removable
56-147GRH-NRP	Gold	RH	Non-Removable
56-147ORBLH-NRP	Oil Rubbed Bronze	LH	Non-Removable
56-147ORBRH-NRP	Oil Rubbed Bronze	RH	Non-Removable
56-147PBLH-NRP	Polished Brass	LH	Non-Removable
56-147PBRH-NRP	Polished Brass	RH	Non-Removable
56-147SCLH-NRP	Seacoast	LH	Non-Removable
56-147SCRH-NRP	Seacoast	RH	Non-Removable
56-147WLH-NRP	White	LH	Non-Removable
56-147WRH-NRP	White	RH	Non-Removable

MULTIPOINT LOCK

TRU-LOCK Multipoint LOCK SOLUTION FOR ENTRY DOORS

Convert Your Single Point Dead Bolt into a Multipoint Locking System



56-161

Multipoint Lock Conversion Kit
Includes 2 Stainless Steel Strikes,
Screws & Instructions

- Excellent Retro Fit for Schlage, Kwikset, Wiser
- Increased Home Security - Capable of Grade 40 per ASTM F476
- Compatible with top brand handle hardware allowing consumer wide selection of decorative handle choices
- Very intuitive function for homeowner - operates the same as standard deadbolts today
- Constructed from stainless steel and composite materials
- Works on steel, fiberglass, aluminum and wood doors
- Works with both standard 2-3/8" and 2-3/4" double bore backsets
- Easy installation, instructions included

Kit Plate Cover

Kit Plate Cover Comes with 2 Strikes, Multipoint Plate and all necessary Screws

Part #	Finish
56-162	Brass
56-163	Oil Rubbed Bronze

TRU - LOCK FABRICATION TEMPLATE



56-153

Tools provided in Amesbury installation kit:

- (A) Door router fixture #56-153-1, (B) Door frame router fixture #56-153-2, (C) 1/2" Router bit with top guide bearing, (D) 1/4" Router bit, (E) Centering clamp, (F) 1/4" X 2-1/2" Flathead bolt and 1/4" Wing Nut, (G) Assorted deadbolt strike plugs, (H) Door stops, (I) # 6 x 1-1/4" Flathead screws, (J) # 8 x 1-5/8" Sheetrock screws (K) Wood cover plates

TRUTH'S SENTRY™ MULTIPOINT HANDLE SETS FOR 1-3/4" - 2-1/4" THICK DOORS

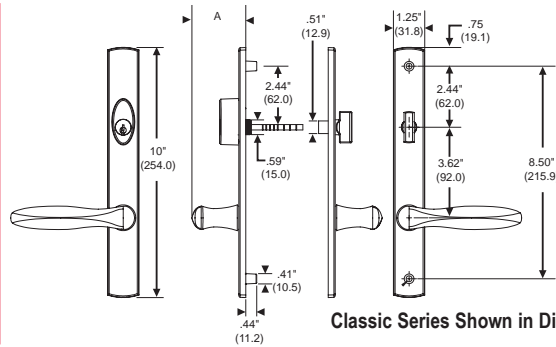

Handle Type	A
Transitional	2.26"
Traditional	2.45"
Contemporary	2.05"
Modern	2.33"
Classic	2.16"

Finishes



Handle Styles

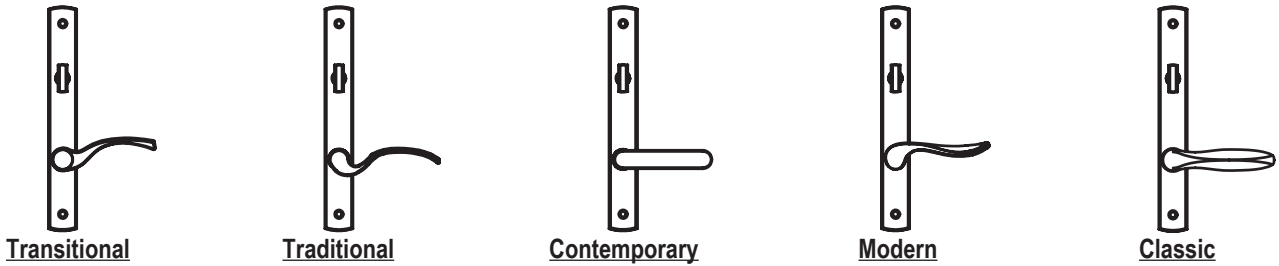

Style	Function	Antique Brass	PVD Brushed Chrome	PVD Chrome	PVD Brass	PVD Bronze	PVD Nickel	Faux Bronze	Black	White	Beige
Transitional	Active	857-10183	857-10213	857-10207	857-10204	857-10210	857-10192	857-10201	857-10198	857-10189	857-10186
	Inactive	857-10182	857-10212	857-10206	857-10203	857-10209	857-10191	857-10200	857-10197	857-10188	857-10185
	Dummy	857-10184	857-10214	857-10208	857-10205	857-10211	857-10193	857-10202	857-10199	857-10190	857-10187
Traditional	Active	857-10216	857-10249	857-10243	857-10240	857-10246	857-10225	857-10235	857-10231	857-10222	857-10219
	Inactive	857-10215	857-10248	857-10242	857-10239	857-10245	857-10224	857-10233	857-10230	857-10221	857-10218
	Dummy	857-10217	857-10250	857-10244	857-10241	857-10247	857-10226	857-10237	857-10232	857-10223	857-10220
Contemporary	Active	857-10252	857-10279	857-10273	857-10270	857-10276	857-10259	857-10016	857-10265	857-10018	857-10255
	Inactive	857-10251	857-10278	857-10272	857-10269	857-10275	857-10258	857-10015	857-10264	857-10017	857-10254
	Dummy	857-10253	857-10280	857-10274	857-10271	857-10277	857-10260	857-10268	857-10266	857-10257	857-10256
Classic	Active	857-10282	857-10314	857-10308	857-10305	857-10311	857-10291	857-10298	857-10020	857-10288	857-10285
	Inactive	857-10281	857-10313	857-10307	857-10304	857-10310	857-10290	857-10296	857-10021	857-10287	857-10284
	Dummy	857-10283	857-10315	857-10309	857-10306	857-10312	857-10292	857-10301	857-10019	857-10289	857-10286
Modern	Active	857-10317	857-10350	857-10344	857-10341	857-10347	857-10326	857-10336	857-10332	857-10323	857-10320
	Inactive	857-10316	857-10349	857-10343	857-10340	857-10346	857-10325	857-10334	857-10331	857-10322	857-10319
	Dummy	857-10318	857-10351	857-10345	857-10342	857-10348	857-10327	857-10339	857-10333	857-10324	857-10321

TRUTH'S SENTRY™ MULTIPOINT HANDLE SETS ACCESSORIES

Conversion Kit

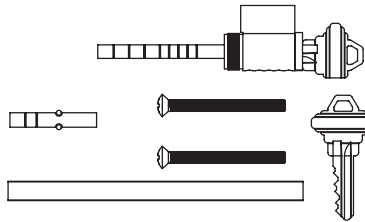

Part Number	Finish
857-10145	Antique Brass
857-10146	Beige
857-10147	White
857-10148	PVD Nickel
857-10150	Black
857-10151	Faux Bronze
857-10152	PVD Brass
857-10153	PVD Chrome
857-10154	PVD Bronze
857-10155	PVD Brushed Chrome

2-1/4" Door Conversion Kit

Door Handle Extension Kit



For 1-3/4" Door Thickness

Part Number	Finish
857-10123	Antique Brass
857-10124	Beige
857-10125	White
857-10126	PVD Nickel
857-10128	Black
857-10129	Faux Bronze
857-10130	PVD Brass
857-10131	PVD Chrome
857-10132	PVD Bronze
857-10133	PVD Brushed Chrome

For 2-1/4" Door Thickness

Part Number	Finish
857-10134	Antique Brass
857-10135	Beige
857-10136	White
857-10137	PVD Nickel
857-10139	Black
857-10140	Faux Bronze
857-10141	PVD Brass
857-10142	PVD Chrome
857-10143	PVD Bronze
857-10144	PVD Brushed Chrome

TRUTH'S SENTRY™ ADJUSTABLE HINGES



Engineered for maximum strength and security, Sentry Hinges exceed ANSI grade 3 requirements for doors weighing up to 220 lbs. Sentry Hinges exceed ANSI grade 1 impact specifications. Sentry Hinges are made of extruded brass and extruded aluminum that provides superior strength and corrosion resistance. Sentry Hinges provided with non-removable pins for maximum security.

- Robust, Reliable and Attractive
- Industry standard 4" x 4" with 5/8" radius corner
- Both Guide and Set Hinges take a 5/32" hex wrench
- Guide Hinge has a 11/64" adjustment and Set Hinge has a 1/4" adjustment
- Extruded brass hinges are provided in decorative finishes including PVD
- Extruded aluminum hinges are available in powder coated painted finishes
- Composite bushings provide noise-free operation

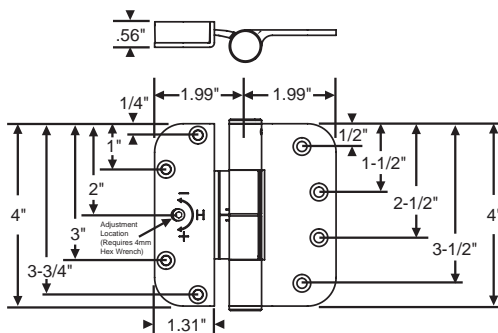

LEFT HAND SHOWN



Extruded Brass Guide Hinges - Plated

Hand	Antique Brass	PVD Brushed Chrome	PVD Chrome	PVD Brass	PVD Bronze	PVD Nickel
LH	857-10352	857-10390	857-10382	857-10378	857-10386	857-10364
RH	857-10353	857-10391	857-10384	857-10379	857-10387	857-10365

Extruded Aluminum Guide Hinges - Painted

Hand	White	Snow White	Beige	Faux Bronze	Black
LH	857-10360	857-10368	857-10356	857-10002	857-10372
RH	857-10361	857-10369	857-10357	857-10001	857-10373

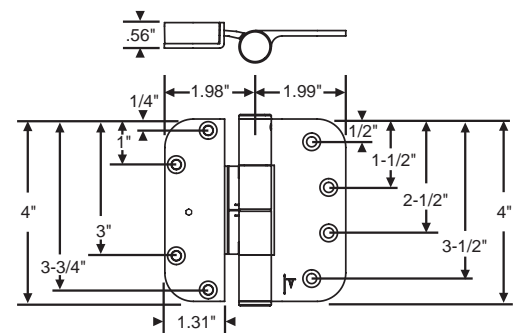

LEFT HAND SHOWN

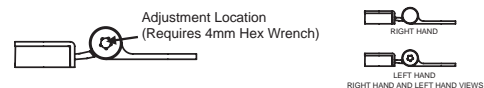

Extruded Brass Set Hinges - Plated

Hand	Antique Brass	PVD Brushed Chrome	PVD Chrome	PVD Brass	PVD Bronze	PVD Nickel
LH	857-10394	857-10432	857-10424	857-10420	857-10428	857-10406
RH	857-10395	857-10433	857-10425	857-10421	857-10429	857-10407

Extruded Aluminum Set Hinges - Painted

Hand	White	Snow White	Beige	Faux Bronze	Black
LH	857-10402	857-10410	857-10398	857-10004	857-10414
RH	857-10403	857-10411	857-10399	857-10003	857-10415

TRUTH'S SENTRY™ MULTIPOINT SWING DOOR SYSTEM QUESTIONNAIRE

Acct. #: _____ Date: _____
 Customer Name: _____ Phone: _____
 Address: _____ Fax: _____
 Contact: _____ E-mail: _____

1. Choose Between 5 Active and 2 Inactive Multipoint Systems

3 Point Tongue

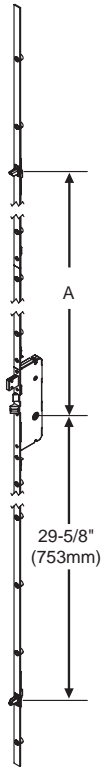

Door	A
71"-81"	29-7/32" (742mm)
81"-89"	39-7/32" (996mm)
89"-97"	47-7/32" (1199mm)
97"-105"	53-7/32" (1352mm)
105"-113"	63-7/32" (1606mm)
113"-121"	71-7/32" (1809mm)

A= Top Tongue Position

3 Point Hook

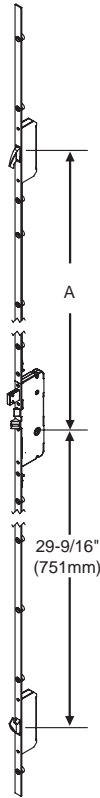

Door	A
71"-81"	29-5/32" (740mm)
81"-89"	39-5/32" (994mm)
89"-97"	47-5/32" (1198mm)
97"-105"	53-5/32" (1350mm)
105"-113"	63-5/32" (1604mm)
113"-121"	71" (1807mm)

A= Upper Hook Position

3 Point Shootbolt



5 Point Tongue/ Shootbolt

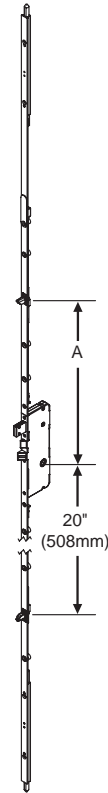

Door	A
71"-81"	16-1/2" (343mm)
81"-97"	24-1/2" (546mm)
97"-113"	40-1/4" (1022mm)
113"-121"	48-1/4" (1225mm)

A= Top Tongue Position

5 Point Hook/ Shootbolt

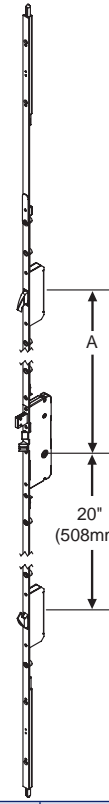

Door	A
71"-81"	16-5/32" (410mm)
81"-97"	24-5/32" (614mm)
97"-113"	40-5/32" (1020mm)
113"-121"	48-5/32" (1223mm)

A= Top Hook Position

2 Point Shootbolt



All of the above locking systems have the following features:

- 36" Handle Height
- 92mm Spacing
- Latch bolts are reversible by pulling out and rotating 180°
- 1" Deadbolt & Shootbolt throw
- Thumbturn above the lever - North American design
- Independent dead bolt - secure door without engaging other locking points
- Anti slam device preventing damage to door
- Available with 16mm or 20mm face plate
- Multipoint systems are made of 300 series stainless steel

2. **FACE PLATE WIDTH:** The metal plate that runs the length of the door: 5/8" (16mm) 25/32" (20mm)
3. **BACKSET:** 1-3/8" (35mm) 1-3/4" (45mm) 2-3/8" (60mm)
4. **DOOR PANEL HEIGHT:** (Do not include sweeps): _____
5. **DOOR THICKNESS:** _____

2 Point Lever Activated Flush bolt

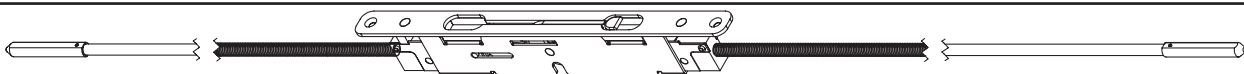

Choose Backset: 24mm 26mm 30mm

Handle Height (50" is standard): _____

Finish: Stainless Steel Faux Bronze

Overall Door Height: _____

TRUTH'S SENTRY™ MULTIPOINT STRIKES

Latch/Deadbolt Strikes

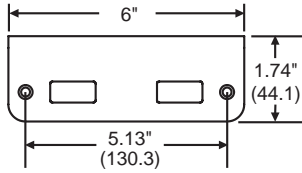

Part #	Material	Finish
857-10116	Stainless Steel	Brushed
857-10173	Stainless Steel	Black
857-10175	Stainless Steel	Faux Bronze
857-10171	Stainless Steel	Beige
857-10172	Stainless Steel	White
857-10117	Solid Brass	Antique Brass
857-10177	Solid Brass	PVD Brass
857-10179	Solid Brass	PVD Bronze

For 1-3/4" Doors

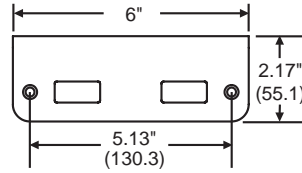

Part #	Material	Finish
857-10107	Stainless Steel	Brushed
857-10156	Solid Brass	Antique Brass
857-10158	Solid Brass	PVD Brass

For 2-1/4" Doors

Tongue Strikes

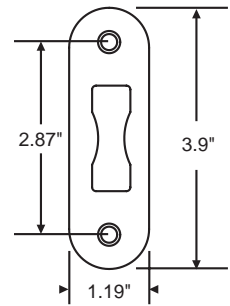

Part #	Material	Finish
857-10111	Stainless Steel	Brushed
857-10165	Stainless Steel	Black
857-10167	Stainless Steel	Faux Bronze
857-10113	Stainless Steel	Beige
857-10114	Stainless Steel	White
857-10112	Solid Brass	Antique Brass
857-10169	Solid Brass	PVD Brass
857-10170	Solid Brass	PVD Bronze

Hookbolt Strikes

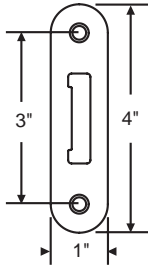

Part #	Material	Finish
857-10118	Stainless Steel	Brushed
857-10119	Solid Brass	Antique Brass
857-10180	Solid Brass	PVD Brass
857-10181	Solid Brass	PVD Bronze

Shootbolt Cover Plate

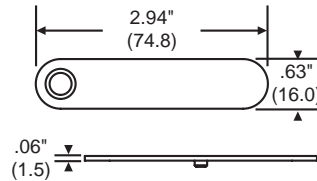

Part #	Material	Finish
857-10005	Stainless Steel	Brushed

Shootbolt Strikes

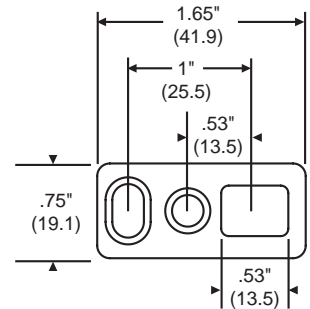

Part #	Material	Finish
857-10110	Stainless Steel	Brushed
857-10163	Stainless Steel	Faux Bronze

Shootbolt Strikes

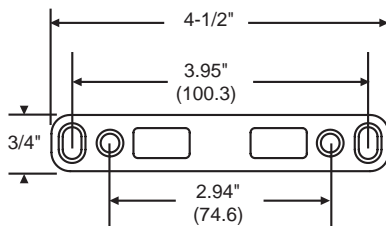

Part #	Material	Finish
857-10000	Stainless Steel	Brushed
857-10161	Stainless Steel	Faux Bronze

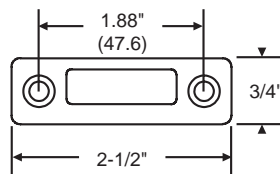

Part #	Material	Finish
857-10109	Stainless Steel	Brushed
857-10159	Stainless Steel	Faux Bronze

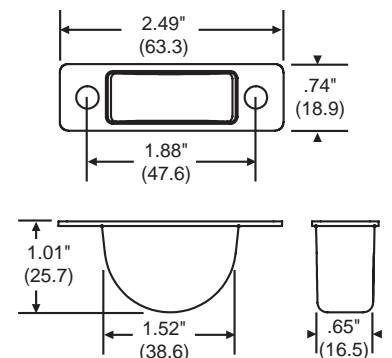

Part #	Material	Finish
857-10115	Stainless Steel	Brushed

FRENCHWOOD HINGED DOORS (1988 TO PRESENT) - 2 PANEL, 3 PANEL AND STATIONARY

Multipoint Locking Mechanisms / Current

Note: Lock mechanisms for custom sized doors are made to order. Product ID label is located on top edge of operating panel. To order, state: Description of part (Lock Mechanism, Active or Passive), Quantity and Product ID

Hook Bolt Lock Mechanism - 3-Point / Stainless Steel / Active (March 2003 to Present)

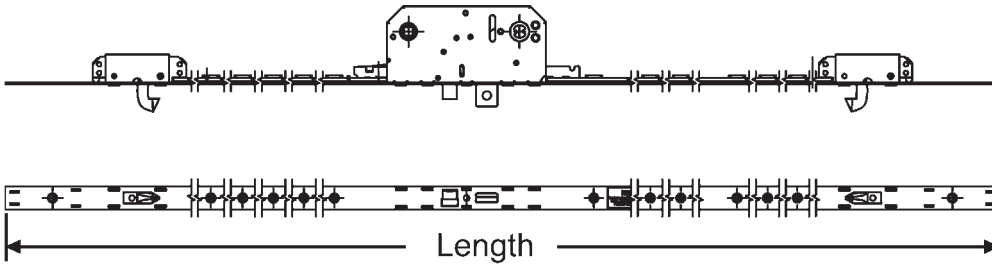

Note: Stainless steel active lock mechanism replaces all previous vintage active lock mechanisms.

Part Number	Length	Door Size
56-351	76-13/32"	6' 8"
56-352	79-9/32"	6' 11"
56-363	86-13/32"	7' 6"
56-353	92-13/32"	8'

Flush Bolt Locking Mechanism - 2-Point / Stainless Steel / Passive (March 2003 to Present)

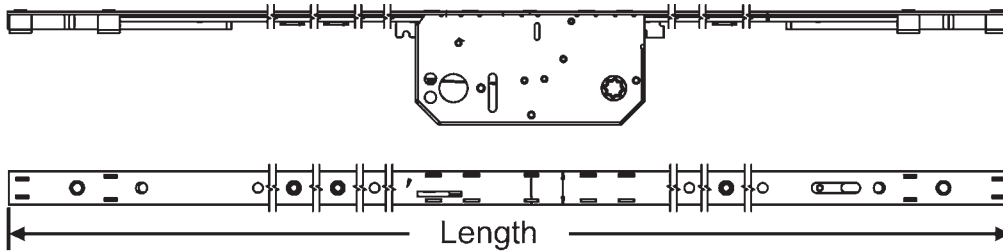

Note: Replace a stainless steel passive lock with a stainless steel passive replacement lock. This replaces all previous vintage stainless steel passive locks. Zinc dichromate lock no longer available; use stainless steel lock kit as replacement (see below).

Part Number	Length	Door Size
56-354	76-7/16"	6' 8"
56-355	79-11/32"	6' 11"
56-364	86-7/16"	7' 6"
56-356	92-7/16"	8'

Replacement Stainless Steel Lock Kit for Passive/Zinc Dichromate Lock Mechanism (1993 to March 2003)

Note: The zinc dichromate (gold finish appearance) passive lock is no longer available. Replace with stainless steel lock kit.

Kit Includes: (1) Instruction Guide, (1) Stainless Steel Passive Lock Mechanism, (2) Hook Bolt Receivers, (2) Flush Bolt Receivers, (1) Latch Receiver Blocker

Part Number	Length	Door Size
56-360	76-7/16"	6' 8"
56-361	79-11/32"	6' 11"
56-362	86-7/16"	8'

Lock Mechanism - 5-Point / Stainless Steel (Impact Resistant) / Active

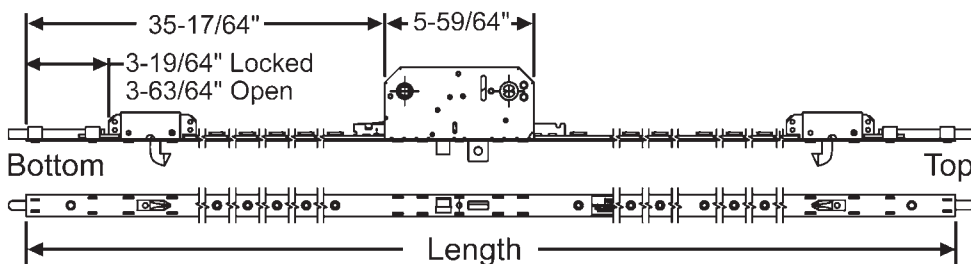

The 5-point active lock mechanism is used on double active Stormwatch™ (AP/PA) units.

Part Number	Length
56-491	76-27/64"
56-492	79-19/64"
56-493	92-27/64"

HOOK BOLT PARTS

Hook Bolt Receiver with Screws

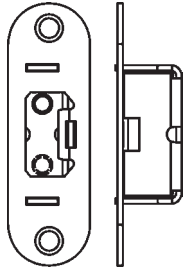

56-365
March 2003 to Present
Single SA/AS. 3-Panel

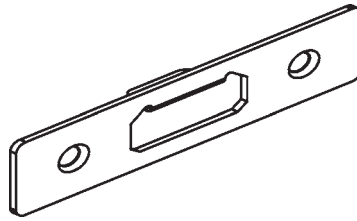

56-366
March 2003 to Present
AP/PA

Hook Bolt Blocker

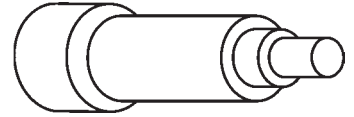

56-367
March 2003 to Present
Use with Stainless Steel Lock Mechanism

FLUSH BOLT PARTS

Flush Bolt Receiver

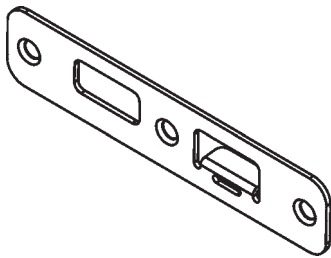

56-368
March 2003 to Present. Use with Stainless Steel Lock Mechanism. Head PA/Sill AP

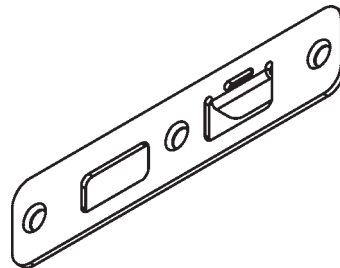

56-369
March 2003 to Present. Use with Stainless Steel Lock Mechanism. Head AP/Sill PA

Flush Bolt Screw



56-370
March 2003 to Present. Use with Stainless Steel Lock Mechanism. #10-12 x 3" Type 17

LATCH BOLT PARTS

Latch Bolt Receiver



56-371
March 1990 to Present. Replaces All Previous Vintage Latch Receivers. Used on Patio Doors without a Passive Panel: AL, AR, SAR, SAL, SASL, SASR

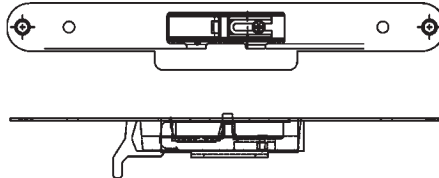

56-372
March 2003 to Present. Replaces All Previous Vintage AP/PA Latch Receivers. Use 2003 to Present on Patio Doors with a Passive Panel: PALR, APLR.

Latch Bolt Blocker

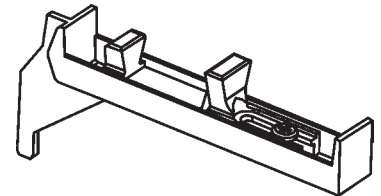

56-373
March 2003 to Present. Replaces All Previous Vintage AP/PA Latch Receivers. Use 2003 to Present on Patio Doors with Stainless Steel Lock Mechanism. Used on AP/PA Latch Bolt Receiver.

LATCH BOLT PARTS

U Clip

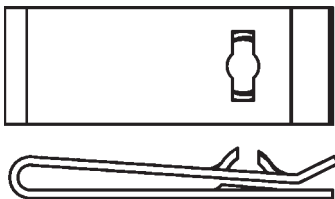

56-374
March 2003 to Present. Use with Stainless Steel Lock Mechanism. Used on AP/PA Latch Bolt Receiver.

Lock Limiting Plate with Tab

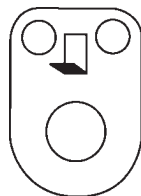

56-358

HARDWARE

Lock Actuator

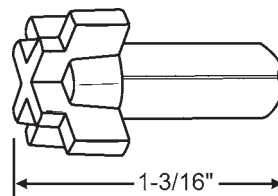

56-359

Lock Mechanism Screw



56-375
8-18 x 2" Type AB. Stainless Steel

COLOR SUFFIX GUIDE

Oil Rubbed Bronze	ORBZ	Antique Brass	AB
Polished Chrome	PC	Polished Brass	PB
Bright Chrome	BCH	PVD Brass	BRS
Pewter	P	PVD Satin Nickel	SNK
Dark Bronze	DBZ	Distressed Satin Nickel	DSNK
Black	B	Distressed ORB	DORBZ
White	W	Antique Nickel	AN

FUNCTION GUIDE

Keyed: Door sets have a cylinder on the outside backplate and a thumbturn on the interior backplate.
Non-Keyed: Door sets have only the thumbturn on the interior plate.
Passive: Door sets do not operate.

ORDERING INSTRUCTIONS: Select the proper part number from the charts below. Use the chart to the left to select your desired finish. Add the suffix at the end of the part number.
EXAMPLE: Part number 55-185 in a polished chrome finish, use part number 55-185PC

EXPRESSIONS SERIES

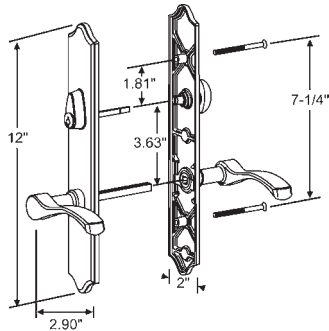

Expressions series trim sets are available in Oil Rubbed Bronze, Polished Chrome, Black, Antique Brass, PVD Brass, PVD Satin Nickel

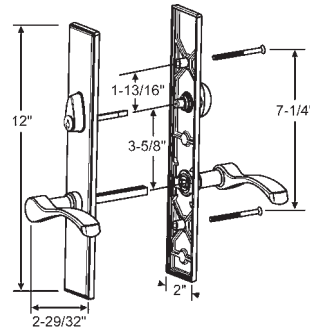

Part #	Function	Trim Set Series	Plate Size & Style	Door Size
55-185	Keyed	Expressions	12" Arch	1-3/4" - 2/14"
55-186	Passive	Expressions	12" Arch	1-3/4" - 2/14"

Part #	Function	Trim Set Series	Plate Size & Style	Door Size
55-147	Keyed	Expressions	12" Square	1-3/4" - 2/14"
55-142	Passive	Expressions	12" Square	1-3/4" - 2/14"

TRUE ELEGANCE SERIES

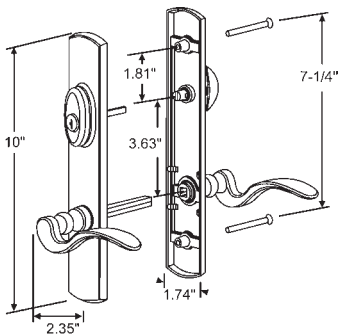

True Elegance series trim sets are available in Oil Rubbed Bronze, Polished Chrome, Bright Chrome, Pewter, Dark Bronze, Black, White, Antique Brass, Polished Brass, PVD Brass, PVD Satin Nickel, Antique Nickel

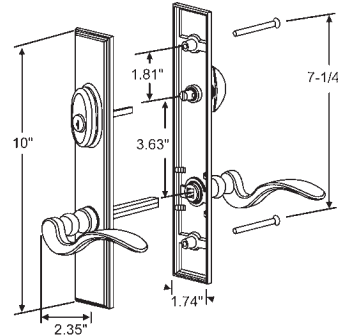

Part #	Function	Trim Set Series	Plate Size & Style	Door Size
55-203	Keyed	True Elegance	10" Half Round	1-3/4"
55-204	Passive	True Elegance	10" Half Round	1-3/4"

Part #	Function	Trim Set Series	Plate Size & Style	Door Size
55-149	Keyed	True Elegance	10" Square	1-3/4"
55-150	Passive	True Elegance	10" Square	1-3/4"

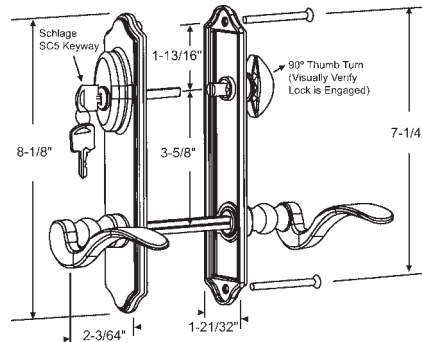
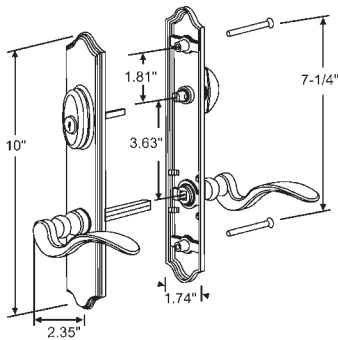

Part #	Function	Trim Set Series	Plate Size & Style	Door Size
55-211	Keyed	True Elegance	10" Arch	1-3/4"
55-212	Passive	True Elegance	10" Arch	1-3/4"
55-213	Non-Keyed	True Elegance	10" Arch	2"

Part #	Function	Trim Set Series	Plate Size & Style	Door Size
55-101	Keyed	True Elegance	8" Arch	1-3/4"
55-160	Non-Keyed	True Elegance	8" Arch	1-3/4"
55-102	Passive	True Elegance	8" Arch	1-3/4"
55-159	Keyed	True Elegance	8" Arch	2"
55-197	Passive	True Elegance	8" Arch	2"

SWING DOOR HANDLE SETS

FORGINGS SERIES

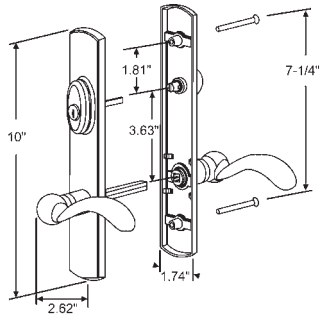

Forgings series trim sets are available in Oil Rubbed Bronze, Distressed Satin Nickel, Distressed Oil Rubbed Bronze, Antique Nickel

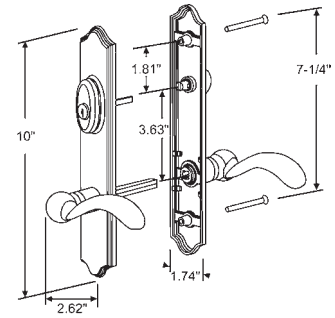

Part #	Function	Trim Set Series	Plate Size & Style	Door Size
55-201	Keyed	Forgings	10" Half Round	1-3/4"
55-202	Passive	Forgings	10" Half Round	1-3/4"

Part #	Function	Trim Set Series	Plate Size & Style	Door Size
55-209	Keyed	Forgings	10" Arch	1-3/4"
55-210	Passive	Forgings	10" Arch	1-3/4"

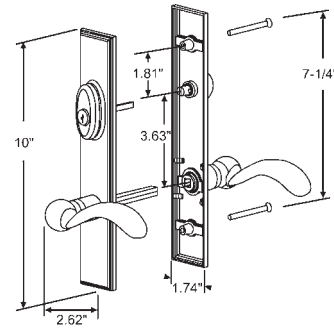
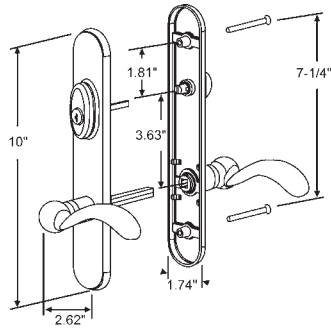

Part #	Function	Trim Set Series	Plate Size & Style	Door Size
55-207	Keyed	Forgings	10" Round	2"
55-208	Passive	Forgings	10" Round	2"
55-205	Keyed	Forgings	10" Round	1-3/4"
55-206	Non-Keyed	Forgings	10" Round	1-3/4"
55-187	Passive	Forgings	10" Round	1-3/4"

Part #	Function	Trim Set Series	Plate Size & Style	Door Size
55-214	Keyed	Forgings	10" Square	2"
55-215	Passive	Forgings	10" Square	2"
55-216	Keyed	Forgings	10" Square	1-3/4"
55-217	Passive	Forgings	10" Square	1-3/4"

EVOLUTIONS SERIES

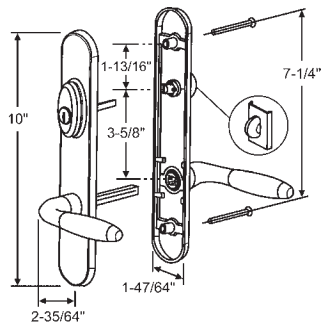

Evolutions series trim sets are available in Polished Chrome, Bright Chrome, Pewter, Black, White

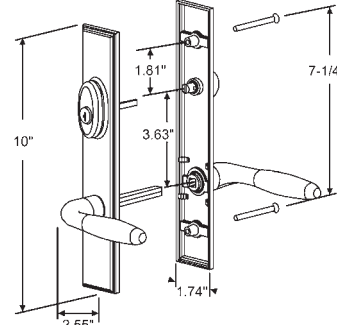

Part #	Function	Trim Set Series	Plate Size & Style	Door Size
55-189	Keyed	Evolutions	10" Round	1-3/4"
55-190	Passive	Evolutions	10" Round	1-3/4"

Part #	Function	Trim Set Series	Plate Size & Style	Door Size
55-154	Keyed	Evolutions	10" Square	1-3/4"
55-155	Passive	Evolutions	10" Square	1-3/4"

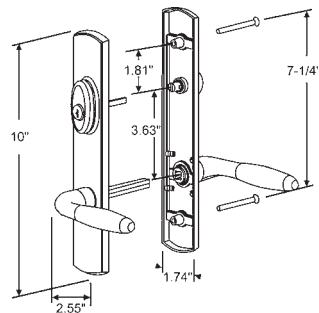

Part #	Function	Trim Set Series	Plate Size & Style	Door Size
55-198	Keyed	Evolutions	10" Half Round	2"
55-199	Passive	Evolutions	10" Half Round	2"
55-122	Keyed	Evolutions	10" Half Round	1-3/4"
55-200	Non-Keyed	Evolutions	10" Half Round	1-3/4"
55-123	Passive	Evolutions	10" Half Round	1-3/4"

PIVOT TRUE V200 TWO WAY ADJUSTABLE DOOR HINGES



RH Shown

KEY FEATURES

- All hinges adjust both horizontally and vertically
- A solid brass extruded jamb wing allows for higher hinge carry capacity
- Hex head adjustment screws, not Phillips or Slotted, to provide secure tool engagement and prevent stripping during adjustment
- Stainless steel adjustment screws provide superior corrosion resistance
- An integrated hinge pin to provide security for outswinging and inswinging doors, and will not lift up during normal door operation

PERFORMANCE AND OPERATION

- Horizontally adjusts 1/16" further than most hinges on the market. Hinge system adjusts 1/4" vertically and horizontally
- Extremely low adjustment force by vertically adjusting the door from below, not laterally like other hinge designs
- Provides an easy-to-see indicator line for accurate vertical adjustment
- A "maintenance and noise-free" operation, even after a million cycles, by incorporating an internal polymer bushing to eliminate any metal to metal contact
- Exceeds BHMA-Grade 3 standards for wood, vinyl, aluminum and steel doors

Part Number	Hand	Finish
56-114LH	LH	Gold Powder Painted
56-114RH	RH	Gold Powder Painted
56-114LORB	LH	Oil Rubbed Bronze
56-114RORB	RH	Oil Rubbed Bronze
56-114LPB	LH	Polished Brass
56-114RPB	RH	Polished Brass
56-114LSCH	LH	Satin Chrome
56-114RSCH	RH	Satin Chrome
56-114LAB	LH	Antique Brass
56-114RAB	RH	Antique Brass
56-114LFORBZ	LH	Faux Oil Rubbed Bronze
56-114RFORBZ	RH	Faux Oil Rubbed Bronze
56-114LSNK	LH	Satin Nickel
56-114RSNK	RH	Satin Nickel

PIVOT TRUE V400 4" ADJUSTABLE DOOR HINGES



Set Hinge

KEY FEATURES

- Seamlessly retrofits a 4" X 4" one-step pocket route with 5/8" corner radius
- Hex head adjustment screws, not Phillips or Slotted, to provide secure tool engagement and prevent stripping during adjustment
- Screw hole locations optimized away from panel edge to prevent accidental wood splitting
- Panel leaf incorporates a unique shield to keep out debris and provide a premium appearance in the closed position
- Incorporates Teflon filled bushings for increased wear resistance
- Non-removable pin (NRP) option available for secure out-swing applications

PERFORMANCE AND OPERATION

- Adjusts 1/4" vertically and 3/16" horizontally
- Easily reversible for either left or right-hand hinge applications
- Innovative, patent-pending adjustment mechanism achieves extremely low adjustment torque with a standard 3/32" hex wrench
- Exceeds BHMA - grade 3 standards for wood, vinyl, aluminum and steel doors.



Guide Hinge

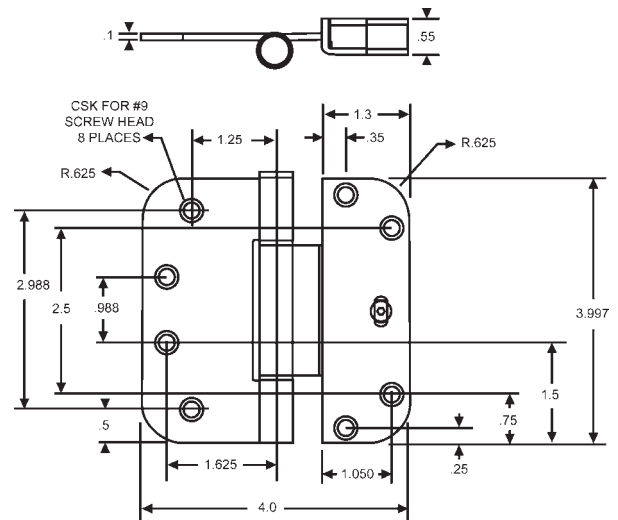
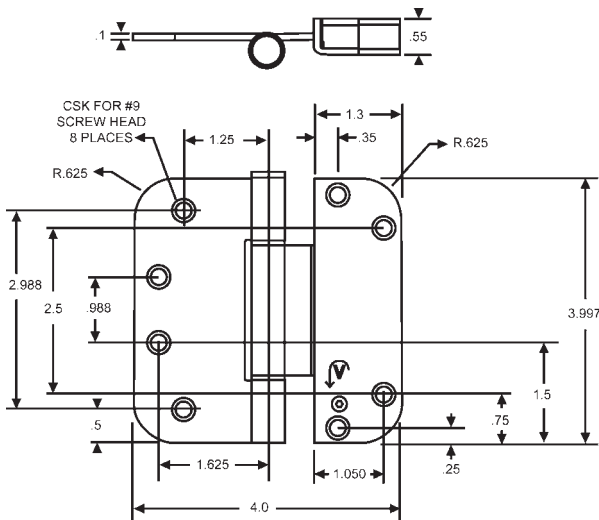

Part Number	Hinge Type	Material	Finish
56-125PB	Guide (Horizontal)	Brass	Bright Brass
56-125P	Guide (Horizontal)	Brass	Pewter
56-125ORBZ	Guide (Horizontal)	Brass	Oil Rubbed Bronze
56-125SCH	Guide (Horizontal)	Brass	Brushed Chrome
56-126PB	Set (Vertical)	Brass	Bright Brass
56-126P	Set (Vertical)	Brass	Pewter
56-126ORBZ	Set (Vertical)	Brass	Oil Rubbed Bronze
56-126SCH	Set (Vertical)	Brass	Brushed Chrome
56-125SS	Guide (Horizontal)	Stainless Steel	Stainless Steel
56-126SS	Set (Vertical)	Stainless Steel	Stainless Steel

SENTINEL MULTIPOINT SWING DOOR LOCK SYSTEM

Facemount Active Lock Versions

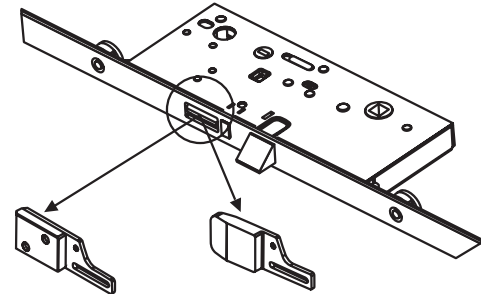

56-100
Welded Steel
Deadbolt

56-185
Powdered Metal
Deadbolt

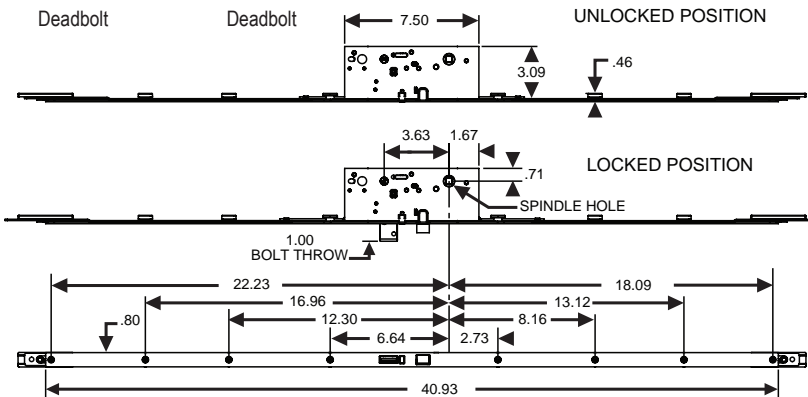

KEY FEATURES

- Made from the finest 300 series stainless steel for superior corrosion resistance
- Incorporates the "Baby-Sitter Effect" that allows the consumer to operate the dead bolt and extension bolts independently of each other, eliminating the necessity for the consumer to lift the lever handle and engage the shoot bolts before activating the dead bolt
- Incorporates an "Anti-Slam" device that prevents the lock bolts from extending until the door is in the closed position, eliminating the potential for door frame damage by the consumer
- The shoot and dead bolts extend a full one-inch to meet the highest levels of structural testing, and meets most local building codes

PERFORMANCE AND SECURITY

- Mechanism has anti-backdrive provisions on the deadbolt and shoot bolts to help prevent tampering
- The extension bolt incorporates the necessary lead-in to provide significant pull-in of the door (Concealed Lock has .290" of pull-in/ Face mounted has .136" of pull-in)
- More consumer friendly to lock the shoot bolts and open the door, requiring only 35° of handle rotation
- Robust and durable handle return spring design to prevent handle sag over time
- The handle is locked out when multipoint is in its locked position
- Withstands abusive torques of over 500 lbs
- Lab tested to over 50,000 cycles

MANUFACTURING FLEXIBILITY AND EASE

- The lock unit is one of the easiest and quickest to reverse the direction of the latch
- The very modular design gives flexibility to accommodate a variety of door sizes and options
- Lock has 2-3/8" backset
- Spacer standoffs are utilized to prevent the lock system from binding when mounting screws are accidentally over tightened
- A simple one step route profile for easier fabrication
- Easy peg-hole connection for quick installation

Facemount Passive Locks

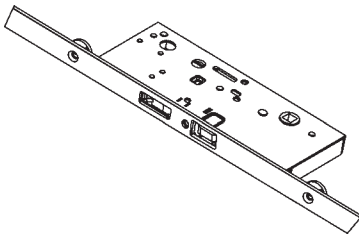

56-100P

- Mortise type (no astragal)
- Has deadbolt communication with the active panel lock
When shoot bolts are extended and the active deadbolt is fully extended, the passive lock shoot bolts cannot be retracted. This prevents the homeowner from opening the passive panel with active deadbolt extended, which might damage the panel. Prevents active lock deadbolt from extending unless the passive shoot bolts are extended. Tells the homeowner to lock the passive panel first.
- Has latch communication with the active panel lock
If the active deadbolt has not been engaged, when passive lock shoot bolts are extended and the active lock latch is fully extended, the passive lock shoot bolts cannot be retracted. This prevents the homeowner from opening the passive panel first, which might damage the panel.
Blocks active lock latch from full engagement into passive lock unless the passive shoot bolts are extended. Prevents damage to panels should passive panel be opened first and tells the homeowner to lock the passive panel first.

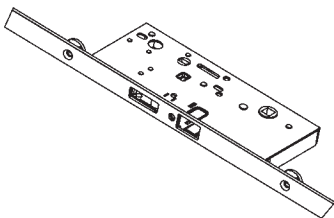

56-480

- After shoot bolt extension, it has a thumb turn mechanism to manually lock the passive shoot bolts in the extended position.
- Requires a passive trimset that has a thumb turn.
- Has deadbolt communication like above if the astragal is thin enough to allow the deadbolt to engage the blocker. However, this is typically used for thicker astragal applications with no communication with the active lock.

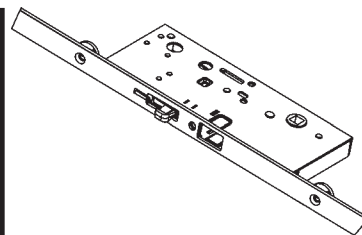

56-481

- Communication with active lock deadbolt through a 5/8" thick astragal.
- No latch communication.

SENTINEL MULTIPOINT SWING DOOR LOCK SYSTEM

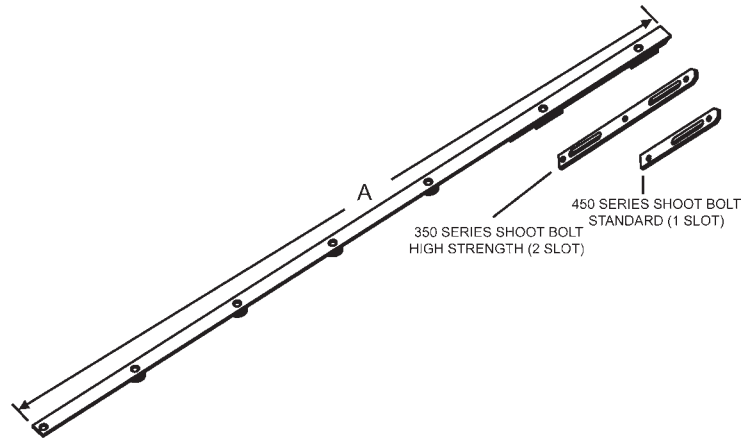

Item Number	Series	Description	A
56-103-2	350/450	Lower Extension for Handle at 36"	17.595"
56-485-2B	350	Upper Extension	18.393"
56-485-2D	350	Upper Extension	18.674"
56-485-2F	350	Upper Extension	19.786"
56-485-2G	350	Upper Extension	20.454"
56-485-2K	350	Upper Extension	24.767"
56-485-2O	350	Upper Extension	34.392"
56-485-2R	350	Upper Extension	36.767"
56-485-2C	350	Upper Extension	18.455"
56-485-2I	350	Upper Extension	21.455"
56-485-2P	350	Upper Extension	34.454"
56-485-2A	350	Upper Extension	17.768"
56-485-2N	350	Upper Extension	33.768"
56-485-2H	350	Upper Extension	21.390"
56-485-2L	350	Upper Extension	25.390"
56-485-2S	350	Upper Extension	37.390"
56-485-2	350	Upper Extension	17.039"
56-485-2E	350	Upper Extension	19.039"
56-485-2J	350	Upper Extension	23.038"
56-485-2M	350	Upper Extension	33.042"
56-485-2Q	350	Upper Extension	35.041"
56-485-1B	450	Upper Extension	18.393"
56-485-1D	450	Upper Extension	18.674"
56-485-1F	450	Upper Extension	19.786"
56-485-1G	450	Upper Extension	20.454"
56-485-1K	450	Upper Extension	24.767"
56-485-1O	450	Upper Extension	34.392"
56-485-1R	450	Upper Extension	36.767"
56-485-1C	450	Upper Extension	18.455"
56-485-1I	450	Upper Extension	21.455"
56-485-1P	450	Upper Extension	34.454"
56-485-1A	450	Upper Extension	17.768"
56-485-1N	450	Upper Extension	33.768"
56-485-1H	450	Upper Extension	21.390"
56-485-1L	450	Upper Extension	25.39"
56-485-1S	450	Upper Extension	37.39"
56-485-1	450	Upper Extension	17.039"
56-485-1E	450	Upper Extension	19.039"
56-485-1J	450	Upper Extension	23.038"
56-485-1M	450	Upper Extension	33.042"
56-485-1Q	450	Upper Extension	35.041"

60MM CONCEALED MULTIPOINT SWING DOOR LOCK SYSTEM

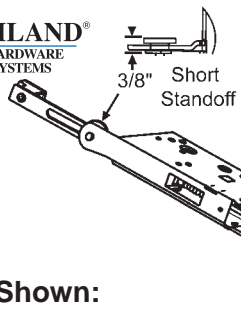

**Shown:
56-170
Passive**

THREADED ROD COUPLING

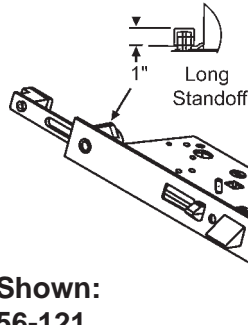

**Shown:
56-121
Active**

THREADED ROD COUPLING

Part #	Version	Backset	Coupling Thread	Standoff	Faceplate Attached
56-121	Active	60mm	1/4-20	Long	Yes
56-151	Active	60mm	1/4-20	Short	No
56-175*	Active	60mm	5/16-18	Short	No
56-170	Passive	60mm	1/4-20	Short	No
56-122	Passive	60mm	1/4-20	Long	Yes

* Used Exclusively by PGT

CONCEALED MULTIPOINT SWING DOOR LOCK SYSTEM WITH FACEPLATE

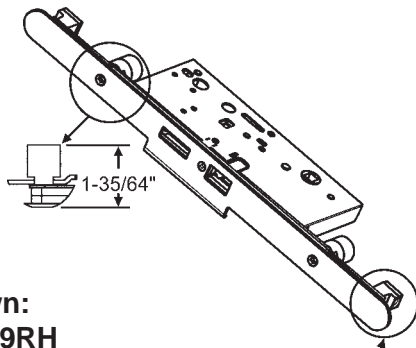

**Shown:
56-479RH
Passive**

THREADED ROD COUPLING

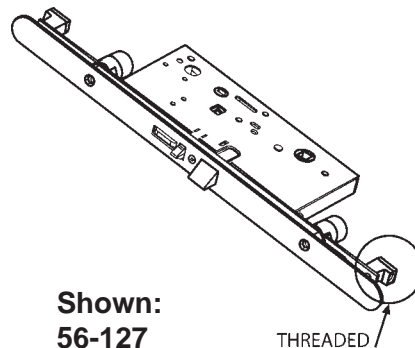

**Shown:
56-127
Active**

THREADED ROD COUPLING

Part Number	Version	Backset	Coupling Thread	Faceplate Attached
56-127	Active	70mm	1/4-20	Yes
56-479RH	Passive, RH	70mm	1/4-20	Yes
56-479LH	Passive, LH	70mm	1/4-20	Yes

SHOOT BOLT GUIDE

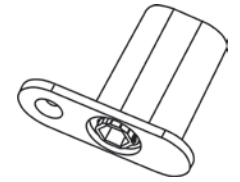

**56-602
Shoot Bolt Guide**

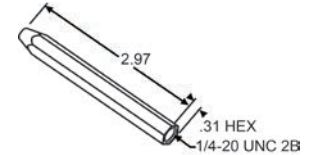

**56-601
Shoot Bolt**

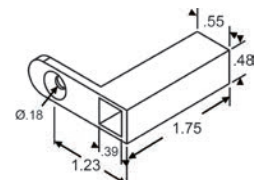

**56-249
Shoot Bolt Guide**

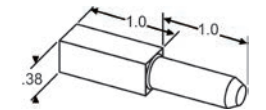

**56-496
Shoot Bolt**

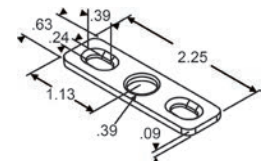

**56-472
Head Strike**

LOCK OPTIONS FOR FACE MOUNT AND CONCEALED MULTIPOINT LOCKS

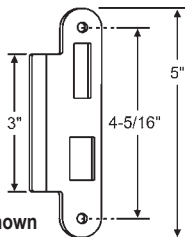

LH Shown

Part #	Finish	Hand
56-116	Stainless Steel	LH
56-117	Stainless Steel	RH
56-116PB	Polished Brass	LH
56-117PB	Polished Brass	RH
56-116ORB	Oil Rubbed Bronze	LH

Strike

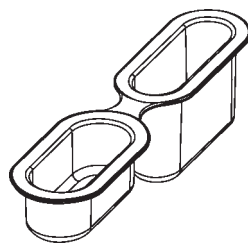

**56-138
Jamb Basket**

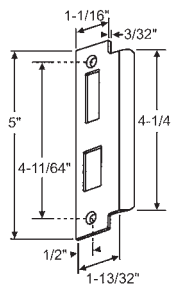

Part #	Hand
56-192RH	RH (shown)
56-192LH	LH

Strike

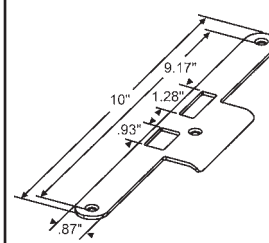

Part #	Hand
56-450SS-RH	RH (shown)
56-450SS-LH	LH

Strike

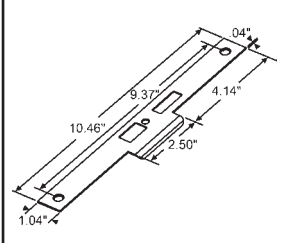

Part #	Hand
56-451SS-RH	RH (shown)
56-451SS-LH	LH

Strike

SWING DOOR HARDWARE

SINGLE & MULTIPOINT MORTISE LOCKS

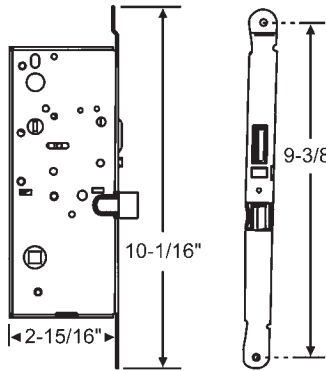

Part #	Description
56-109	For Single Point - No Rod Coupling (Shown)

Mortise Locks for 59-110 Face Plate

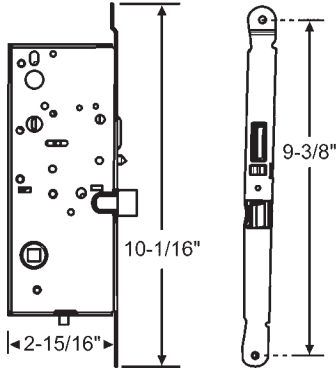

Part #	Description
56-377	For Multipoint with Rod Coupling

Mortise Locks for 59-110 Face Plate

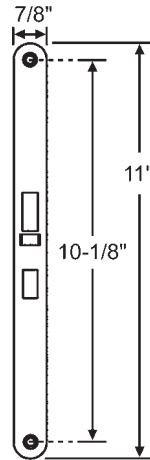

56-110

Face Plate for 56-109 & 56-377 Mortise Locks

SWING DOOR HANDLE

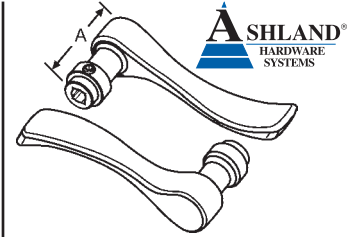

Part #	Description	"A" Dim
56-197S-ORBZ	Short ORB	1-63/64"
56-197S-B	Short Black	1-63/64"
56-197S-AB	Short Antique	1-63/64"
56-197S-BRS	Short PVD Brass	1-63/64"
56-197S-SNK	Short PVD Satin Nickel	1-63/64"
56-197T-B	Tall Black	2-33/64"

SWING DOOR HANDLE SETS

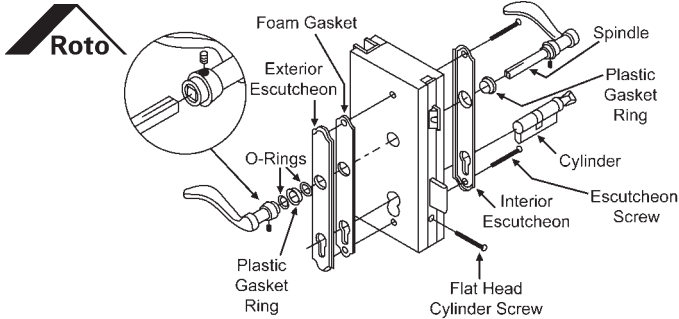

Active Lever Handle Set (Shown)
Thumb Turn w/Key

Part #	Finish
55-111BC	Brushed Chrome
55-111CP	Chrome Plated
55-111W	White

Dummy Lever Handle Set
No Thumb Turn, No Key

Part #	Finish
55-157AB	Antique Brass
55-157BC	Brushed Chrome
55-157CP	Chrome Plated
55-157W	White

MILLTON 2-POINT LOCKSETS

1-1/2" Min / 1-49/64" Max

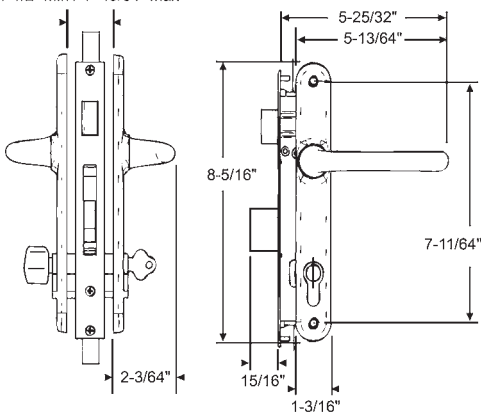

Through innovative design, combined with rigorous testing, comes the comprehensive range of Interlock Millton narrow stile, mortise lever locks. Attractive, durable, easy to install and operate, Millton fits a wide range of applications, and is the perfect complement to today's architecture.

Features:

- Standard 2-Point
- Complete lockset without striker, and 30mm backset
- Stylish Verona handle
- C4 keyway (standard 5-pin)
- Concealed fixing on external escutcheon plate.
- Latch is deadlocked by key

Part #	Description
55-100W	White (Inside & Out)
55-100SCH	Satin Chrome (Inside & Out)

EUROGROOVE STEPPED ROUTER BITS

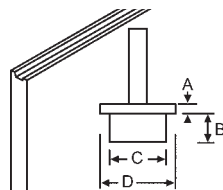

SBI #	MFG.	A	B	C	D
59-69S	Schlegel	1/8"	1/4"	3/4"	1"
59-69T	Truth	1/8"	13/32"	9/16"	51/64"
59-69GU	GU	3/32"	3/8"	31/64"	21/32"
59-69R	Roto-Frank	3/32"	23/64"	31/64"	5/8"
59-69	Hoppe (16mm)	1/8"	23/64"	1/2"	5/8"
59-69W	Winkhaus/Hoppe (20mm)	3/32"	23/64"	31/64"	25/32"
59-69W-1	Winkhaus	3/32"	23/64"	31/64"	41/64"

STEEL PLAIN BEARING BUTT HINGES WITH NON-RISING REMOVABLE PIN

Steel Plain Bearing Butt Hinges with Removable Pin (Non-Rising).

These hinges are packed and **sold by the pairs**. All hinges supplied with flat head phillips screws.

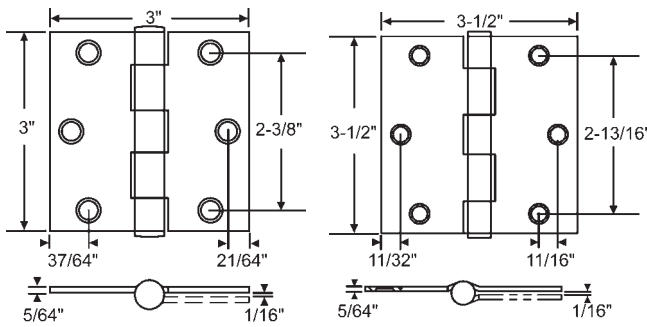

Part Number	Finish	Thickness
56-260SBRS	Satin Brass	2.0 mm

Square Corner. 3" x 3"

Part Number	Finish	Thickness
56-263SBRS	Satin Brass	2.2 mm
56-263SNK	Satin Nickel	2.2 mm

Square Corner. 3-1/2" x 3-1/2"

Steel Plain Bearing Butt Hinges with Non-Removable Pin (Riveted)

This hinge is packed and **sold by the pairs**. All hinges are supplied with flat head phillips wood screws.

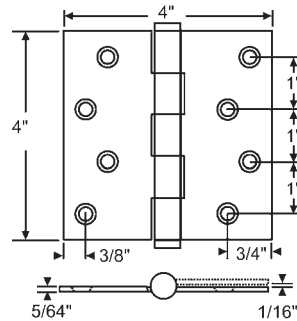

Part Number	Finish	Thickness
56-441	Zinc Plated US2	2.2 mm

Square Corner. 4" x 4"

Steel Plain Bearing Butt Hinges with Non-Removable Pin

These hinges are packed and **sold in sets of three**. All hinges are supplied with flat head phillips wood screws.

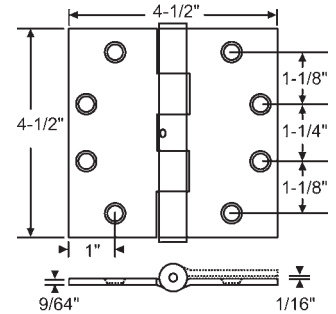

Part Number	Finish	Thickness
56-402SCH	Satin Chrome	3.4 mm
56-402USP	Gray Prime Coat	3.4 mm

Square Corner. 4-1/2" x 4-1/2"

Steel Spring Hinges Single Action, UL Listed

These spring hinges are packed and **sold individually**. All spring hinges supplied with flat head phillips wood and machine screws, hex wrench and instructions.

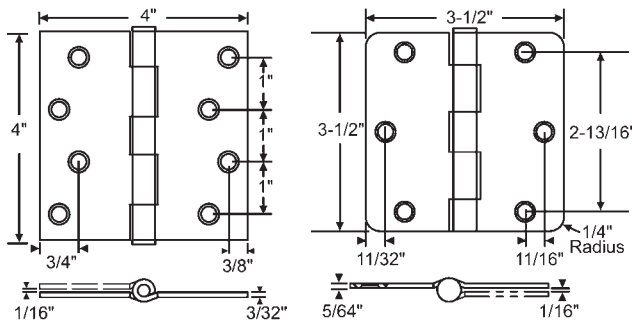

Part Number	Finish	Thickness
56-264SBRS	Satin Brass	2.5 mm
56-264SNK	Satin Nickel	2.5 mm

Square Corner. 4" x 4"

Part Number	Finish	Thickness
56-261SBRS	Satin Brass	2.2 mm

1/4" Radius. 3-1/2" x 3-1/2"

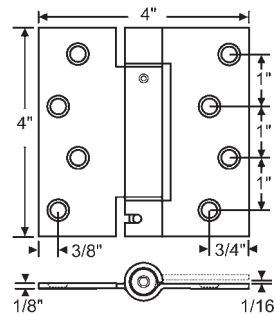

Part Number	Finish	Thickness
56-403SNK	Satin Nickel	3.3 mm

Square Corner. 4" x 4"

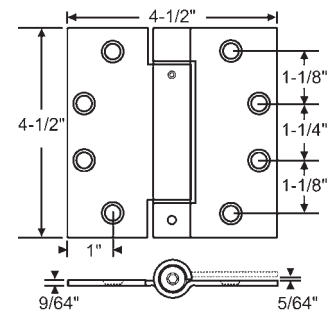

Part Number	Finish	Thickness
56-316SBRS	Satin Brass	3.4 mm
56-316SCH	Satin Chrome	3.4 mm
56-316USP	Gray Prime Coat	3.4 mm

Square Corner. 4-1/2" x 4-1/2"

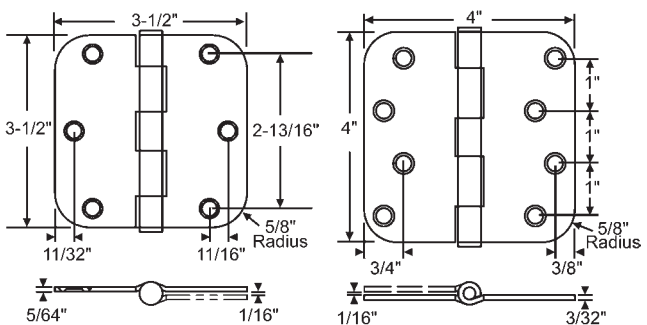

Part Number	Finish	Thickness
56-262SBRS	Satin Brass	2.2 mm
56-262SNK	Satin Nickel	2.2 mm
56-262SCH	Satin Chrome	2.2 mm

5/8" Radius. 3-1/2" x 3-1/2"

Part Number	Finish	Thickness
56-179SBRS	Satin Brass	2.5 mm
56-179SNK	Satin Nickel	2.5 mm
56-179SCH	Satin Chrome	2.5 mm

5/8" Radius. 4" x 4"

Steel 2 Ball Bearing Butt Hinges

These ball bearing hinges are packed and **sold in sets of three**. All hinges are supplied with flat head phillips wood and machine screws.

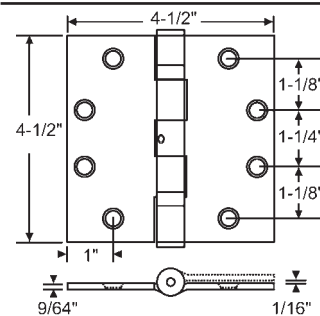

Part Number	Finish	Thickness
56-321SCH	Satin Chrome	3.4 mm

Square Corner. 4-1/2" x 4-1/2"
Non-Removable Pin

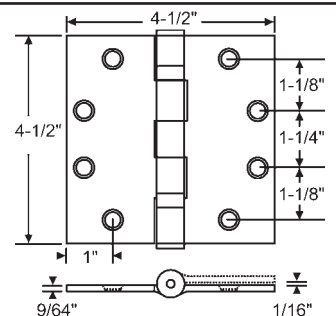

Part Number	Finish	Thickness
56-413SCH	Satin Chrome	3.4 mm

Square Corner. 4-1/2" x 4-1/2"
Removable Pin (Non-Rising)

SWING DOOR HARDWARE

HINGES

Most doors use two guide hinges with one set hinge. Some large doors may use three guide hinges and one set hinge. These are also replacement hinges so best to replace all hinges on the door.

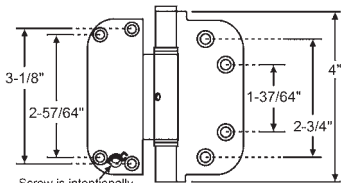

When adjusting the hinge, simply insert a Phillips head screwdriver and manually adjust the hinge. Never use a drill on this hinge.

Adjustable Set Hinge With Non-Removable Pin

Part #	Finish
56-224AB	Antique Brass
56-224BC	Brushed Chrome
56-224ORBZ	Oil Rubbed Bronze
56-224PB	Polished Brass
56-224PC	Polished Chrome
56-224TN	Tan
56-224W	White

Steel. Includes Screws

WINDSOR/ SUPERIOR

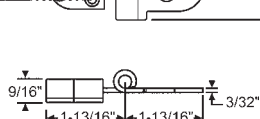
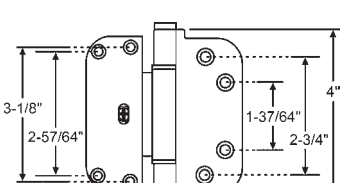

Adjustable Guide Hinge

Part #	Finish
56-223AB	Antique Brass
56-223BC	Brushed Chrome
56-223ORBZ	Oil Rubbed Bronze
56-223PB	Polished Brass
56-223PC	Polished Chrome
56-223TN	Tan
56-223W	White

Steel. Includes Screws

WINDSOR/ SUPERIOR

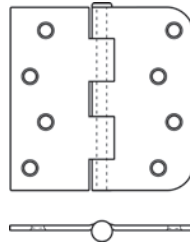

Residential Door Hinge

Part #	Description
56-272SNK	With Removable Pin
56-273SNK	With Non-Removable Pin

- Steel Base Metal
- Square corner x 5/8" radius
- Plain bearing, five knuckle
- 4.0" material gauge= .099" (2.5mm)
- 4" X 4" Square Corner x 5/8" Radius
- Satin Nickel

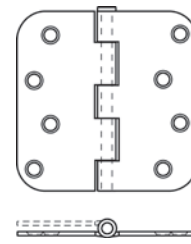

Residential Door Hinge

Part #	Description
56-270SSS	With Removable Pin
56-271SSS	With Non-Removable Pin

- Stainless Steel Base Metal
- 5/8" Radius corner on all corners
- Plain bearing, five knuckle
- 4.0" material gauge= .099" (2.5mm)
- 4" X 4" Square Corner x 5/8" Radius
- Brushed Stainless Steel

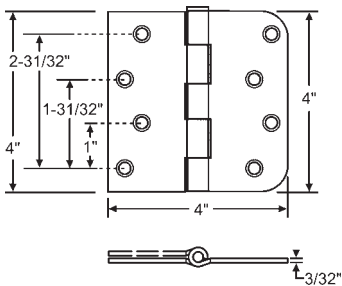

4" Square & Radius Corner Hinges

Part #	Hand
56-330RPB	RH Shown
56-330LPB	LH Opposite

Polished Brass Finish

Sold in Pairs

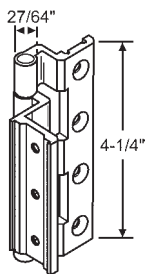

56-325

Converted Chromate
Five Knuckle Butt Hinge
Ready For Paint

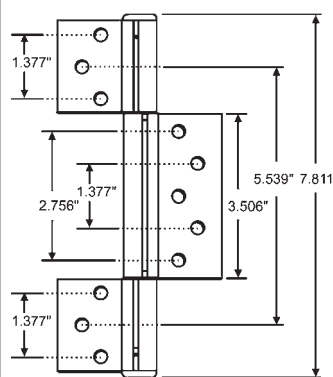

19-1042W

Storm Door Gravity Hinge. White

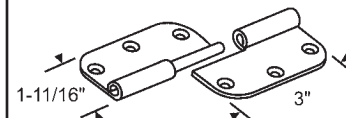

Part #	Description
56-791RHSS	RH
56-791LHSS	LH

Butt Hinge. Stainless Steel

MORTISE LOCKS

INTERLOCK

ASSA ABLOY

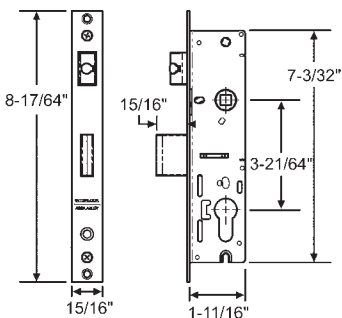

56-169

30mm Lock Body 2pt. Stainless Steel

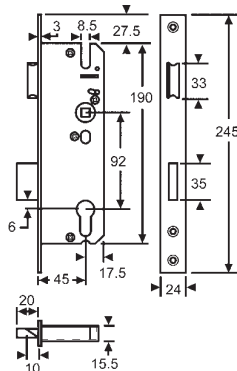

56-329SS

Stainless Steel

KFV

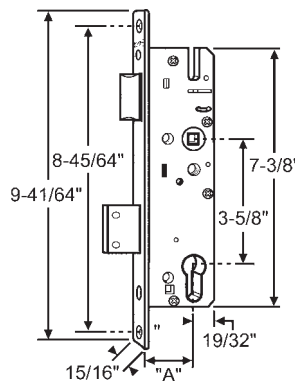

Part #	"A" Backset
56-180	30mm
56-276	35mm
56-277	40mm
56-278	45mm

Non-handed due to reversible latch, ball lock with lubricant, bright nickel-plated and deadbolt, deadbolt secured against sawing through inserted steel pins, deadbolt throw 25mm, zinc-plated casing.

Stainless Steel Face Plate

KFV/ INTERLOCK

MORTISE LOCKS

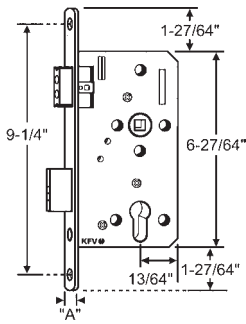

Part #	"A"	Faceplate
56-254	25/32"	20mm
56-255	45/64"	18mm

Non- Handed Magnetic Mortise Lock
KFV

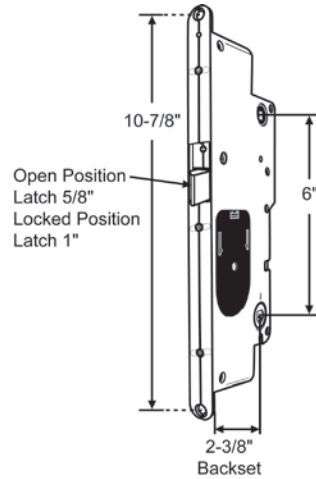

56-101
Reversible
PEACHTREE IPD/CITADEL

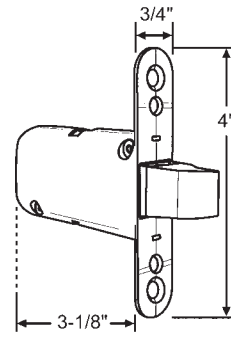

Part #	Finish
56-102LH	Shown

Reversible
PEACHTREE

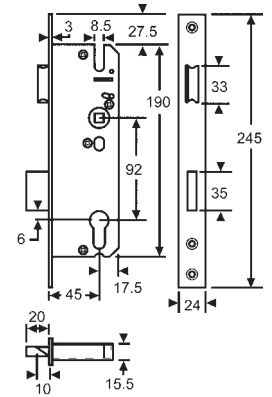

56-329SS
Stainless Steel

MISCELLANEOUS SWING DOOR LOCKSETS

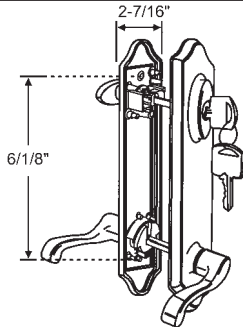

- Fits 2-1/8" Cross Bore on 6-3/32" Centers.
- Fits All Peachtree Prado Patio Doors
- Fits Right or Left Hand Doors

Part #	Finish
55-146PB	Polished Brass

This lockset also can be used on older Prado doors with a 1-3/4" cross bore.

PEACHTREE/PRADO

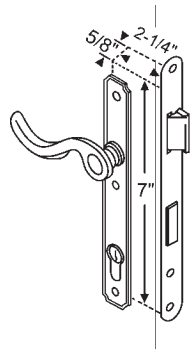

Part #	Finish
55-126PB	Polished Brass
55-126PC	Polished Chrome
55-126SNK	Satin Nickel

An Exact Replacement For Atrium Door

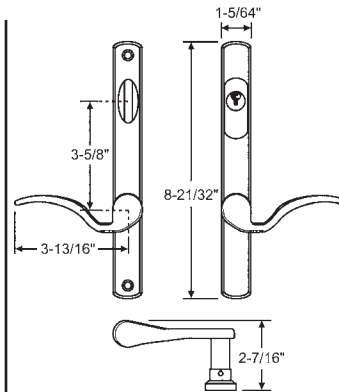

Part #	Description
55-196ABK	Active- With key (Shown)
55-196AB	Privacy- No key

Privacy Handle Set . Antique Brass Finish
Solid Brass Handle

CONSTRUCTION HANDLE

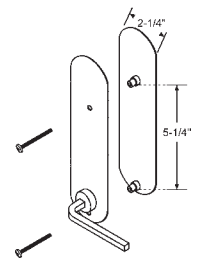

This Construction Hardware is designed specifically to be used with the W & F Trilegium™ multipoint locking system. It saves the finish handle sets from damage and acts as a paint shield during the construction phrase. Although not intended as a security device, the Construction Hardware prevents direct access to the locking mechanism from the exterior. It's sturdy all metal construction also makes it reusable for multiple phases or different job sites.

55-117
W&F TRILEGIUM

MISCELLANEOUS SWING DOOR HARDWARE

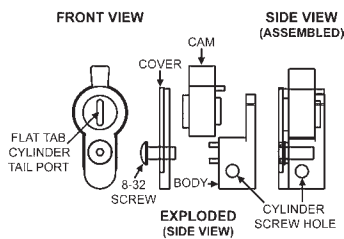

56-344

Euro to American Profile Cylinder.
Adapter Converts Euro Profile Cylinder Mechanisms to Accept American Type Key Cylinders Having Flat Tab Cylinder Tails

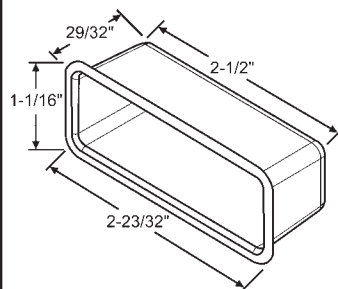

56-269
Tru-Lock Dust Cap. Black PVC
AMESBURY

STORM DOOR HANDLE SET

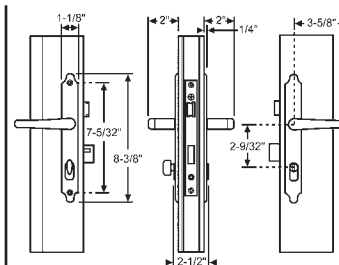

Part #	Finish
19-466	Polished Brass
19-466B	Black
19-466SNK	Satin Nickel
19-466W	White

Complete Handle Set
w/ Mortise Lock, Single Deadbolt & Strike

ZINC BUSHING REPLACEMENT KIT

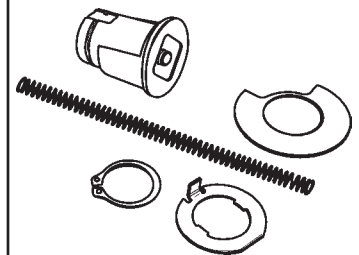

56-115B

Black. For Eclipse, French, Single Island and Double Island Handle. See Page 440.

SWING DOOR HARDWARE

MISCELLANEOUS HANDLE SETS

Eclipse Series Handle Set- Keyed

Eclipse Series Handle Set- Keyless

French Series Handle Set- Keyed

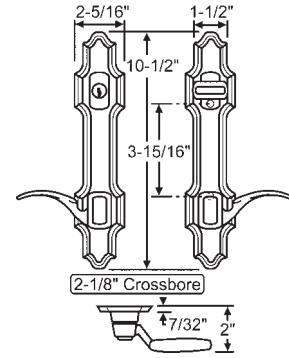
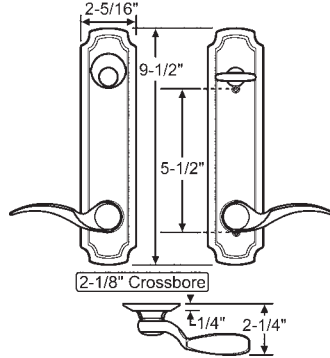
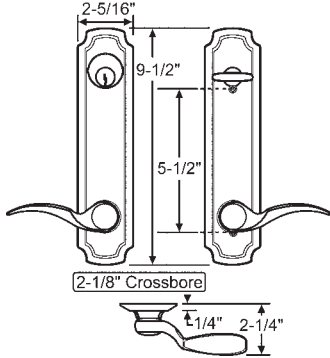
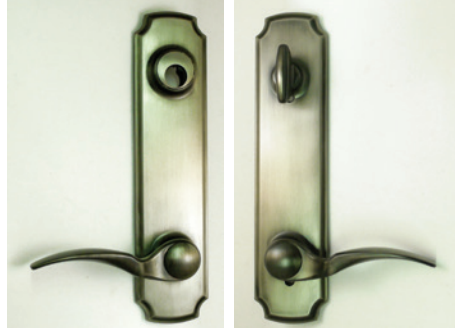

Part #	Finish
55-220BRS	Brass Plated
55-220SNK	Satin Nickel (Shown)

Part #	Finish
55-236ANK-X	Antique Nickel (Shown)
55-236VBZ-X	Victorian Bronze

Part #	Finish
55-226AB	Antique Brass

Includes: Key Cylinder (Weiser keyway), Latch & Deadbolt set with 2-3/8" Backset, Radius Strike Plates, Spindle 9/32" SQ X 1-1/2", Mounting Screws 10-32 TH X 2-1/8"

Note: Does Not Include Anything Else (NO HARDWARE, SCREWS, NOTHING)

Includes: Key Cylinder (Weiser keyway), Latch & Deadbolt set with 2-3/8" Backset, Radius Strike Plates, Spindle 9/32" SQ X 2-9/16", Mounting Screws 10-32 TH X 2-7/16"

Single Island Escutcheons/ Versailles Handles (Patio Door Trimset w/ Key)

Double Island Escutcheons/ Versailles Handles Patio Door Trimset

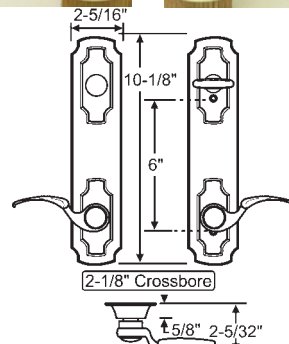
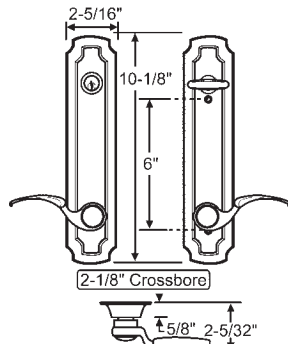
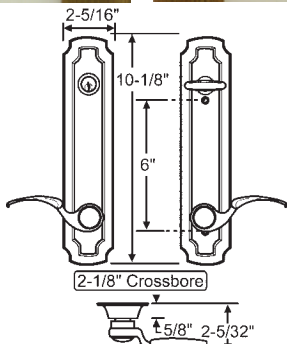
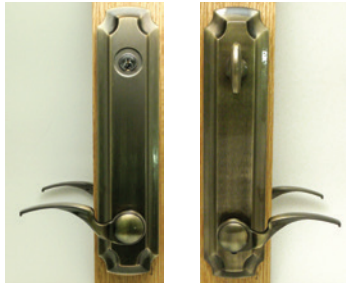

Part #	Finish
55-234PB	Polished Brass

Part #	Finish
55-233AB	Antique Brass

Part #	Description
13-283BBK-1	With Key
13-283BB-1	No Key

Includes: Key Cylinder (Weiser keyway), Latch & Deadbolt set with 2" Backset, Radius Strike Plates and 1/4" x 1-1/2" Spindle

Includes: Key Cylinder (Weiser keyway), Latch & Deadbolt set with 2-3/8" Backset and Radius Strike Plates

Bright Brass

BI-FOLD CLOSET DOOR PIN ASSEMBLIES

In Order by Pin Diameter & Height

1/4" DIAMETER

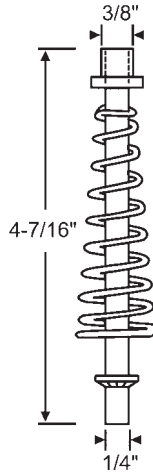
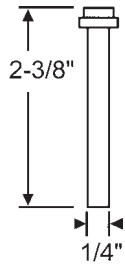

Assembly # 1-250	
Pin w/Cap	1-243
Cap	4-119
Spring	5-51
Push Nut	6-122

FENESTRA

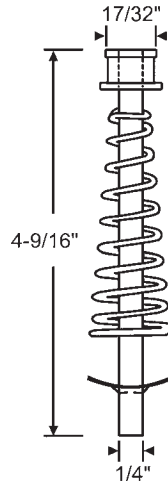

Assembly # 1-161	
Pin w/Cap	1-160
Cap	4-105
Spring	5-51
Tinnerman Clip	6-143

NATIONAL

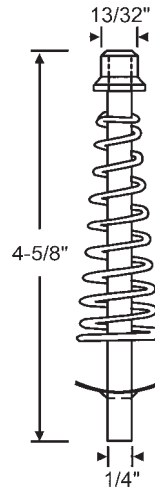

Assembly # 1-159	
Pin w/Cap	1-158
Cap	4-115
Spring	5-51
Tinnerman Clip	6-143

PEACHTREE

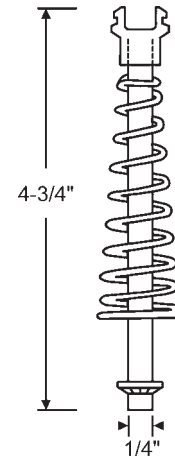

Assembly # 1-131	
Pin w/Cap	1-130
Cap	4-108
Spring	5-51
Push Nut	6-122

NATIONAL

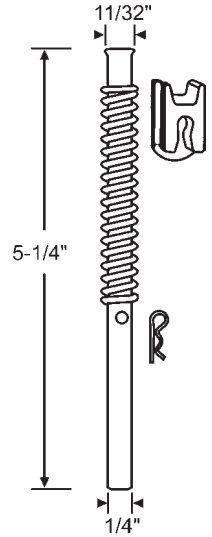

Assembly # 1-145	
Guide Cap	4-111
Spring	5-50
Hairpin Clip	6-136

LEIGH/MONARCH

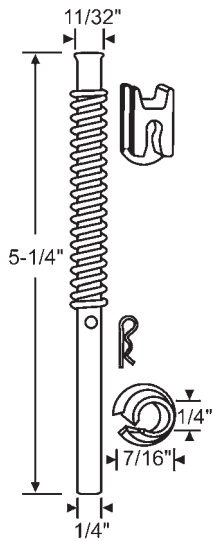

Assembly # 1-145A	
Guide Cap	4-111
Spring	5-50
Hairpin Clip	6-136
Grommet (2x)	8-259

LEIGH/MONARCH

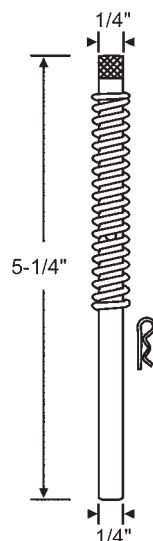

Assembly # 1-153	
Spring	5-50
Hairpin Clip	6-136

LEIGH/MONARCH

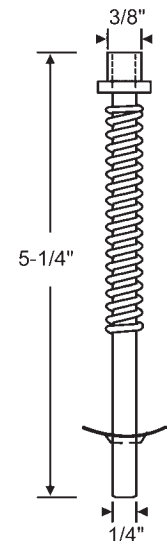

Assembly # 1-236	
Pin w/Cap	1-238
Cap	4-119
Spring	5-50
Tinnerman Clip	6-143

FENESTRA

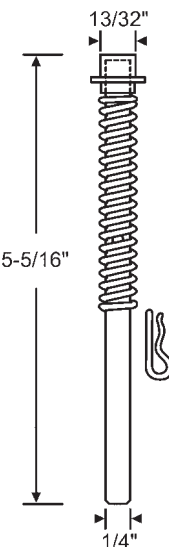

Assembly # 1-163	
Pin w/Cap	1-162
Cap	4-104
Spring	5-50
Hairpin Clip	6-136

LEIGH/MONARCH

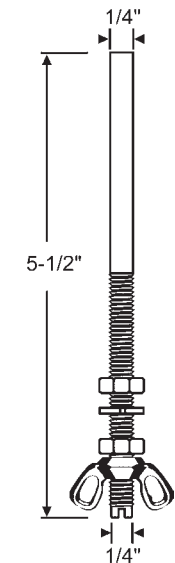

Assembly # 1-147	
Hex nut	6-129
Lock Washer	6-123
Wing Nut	6-132

LEIGH/MONARCH

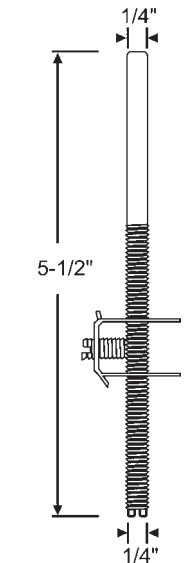

Assembly # 1-165	
Clevis w/Screw	6-134

LEIGH/MONARCH

CLOSET DOOR HARDWARE

BI-FOLD CLOSET DOOR PIN ASSEMBLIES

1/4" DIAMETER

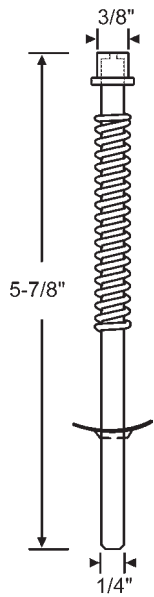

Assembly # 1-170	
Pin w/Cap	1-169
Cap	4-114
Spring	5-50
Tinnerman Clip	6-143

BENCHMARK

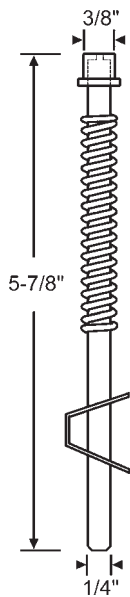

Assembly # 1-237	
Pin w/Cap	1-169
Cap	4-114
Spring	5-50
Compression Retainer	6-101

BENCHMARK

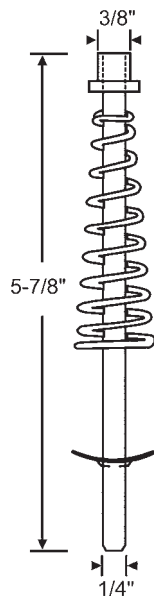

Assembly # 1-259	
Pin w/Cap	1-156K
Cap	4-119
Spring	5-51
Tinnerman Clip	6-143

FENESTRA

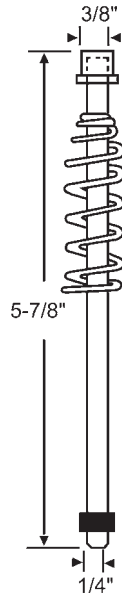

Assembly # 1-235	
Pin w/Cap	1-156
Cap	4-114
Spring	5-59
Stop Bushing	6-107

FENESTRA

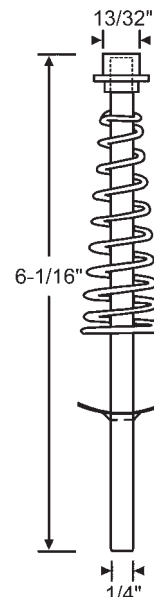

Assembly # 1-172	
Pin w/Cap	1-171
Cap	4-104
Spring	5-51
Tinnerman Clip	6-143

LEIGH/MONARCH

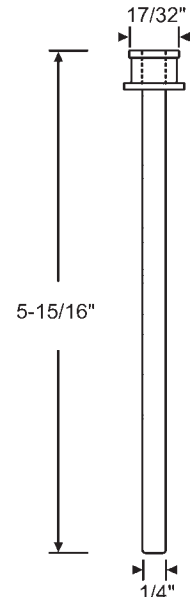

Assembly # 1-258	
Cap	4-105

NATIONAL

5/16" DIAMETER

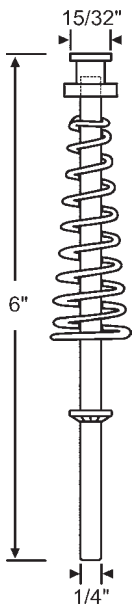

Assembly # 1-157	
Pin w/Cap	1-156
Cap	4-107
Spring	5-51
Push Nut	6-122

NATIONAL

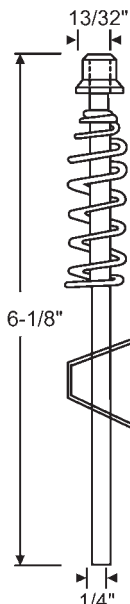

Assembly # 1-224	
Pin w/Cap	1-223
Cap	4-115
Spring	5-59
Compression Retainer	6-143

PEACHTREE

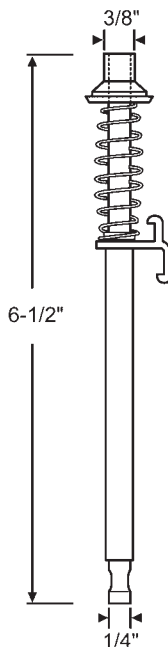

Assembly # 1-102	
Cap	4-120

With Plastic Sleeve

SLIMFOLD

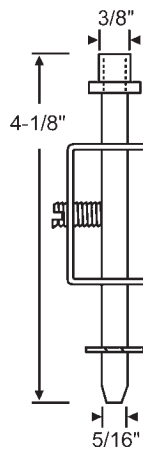

Assembly # 1-137	
Pin w/Cap	1-136
Cap	4-119
Clevis w/Screw	6-102
E-Ring	6-109

FENESTRA

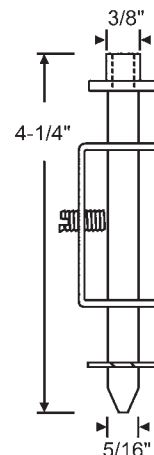

Assembly # 1-241	
Pin w/Cap	1-239
Cap	4-128
Clevis w/Screw	6-105
E-Ring	6-109

FENESTRA

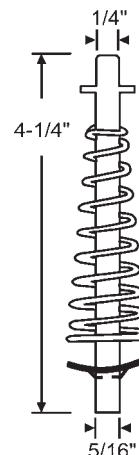

Assembly # 1-190	
Spring	5-51
Tinnerman Clip	6-141
E-Ring	6-109

Used with 1-186

NATIONAL

BI-FOLD CLOSET DOOR PIN ASSEMBLIES

5/16" DIAMETER

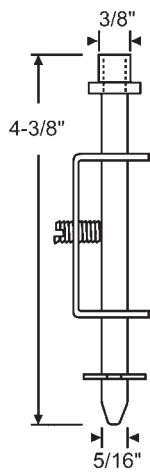

Assembly # 1-201	
Pin w/Cap	1-200
Cap	4-119
Clevis w/Screw	6-105
E-Ring	6-110

FENESTRA

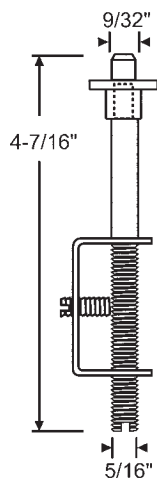

Assembly # 1-180	
Pin w/Cap	1-179
Cap	4-118
Clevis w/Screw	6-103

FENESTRA

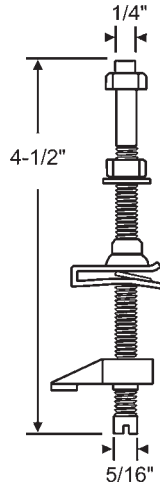

Assembly # 1-186	
Lock Washer	6-115
Hex Nut	6-128
Bushing	6-139
Nut	6-140

NATIONAL

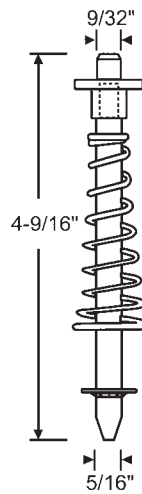

Assembly # 1-251	
Pin w/Cap	1-202
Cap	4-118
Spring	5-62
Push Nut	6-111

FENESTRA

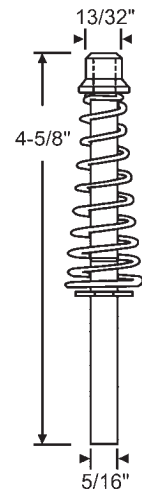

Assembly # 1-133	
Pin w/Cap	1-132
Cap	4-115
Spring	5-51
E-Ring	6-112

PEACHTREE

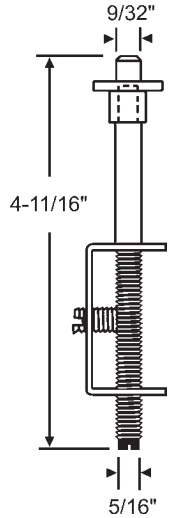

Assembly # 1-220	
Cap	4-118
Clevis	6-103

FENESTRA

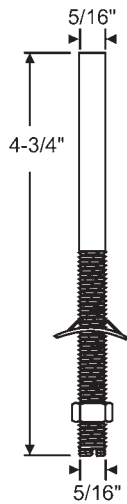

Assembly # 1-209	
Threaded Tinnerman	6-125
Hex Nut	6-128

KELLER

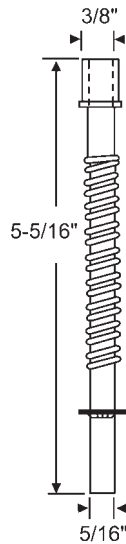

Assembly # 1-184	
Cap	4-103
Spring	5-50
Push Nut	6-111

SLIMFOLD

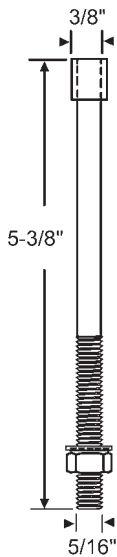

Assembly # 1-127	
Cap	4-110
Lock Washer	6-118
Hex Nut	6-128

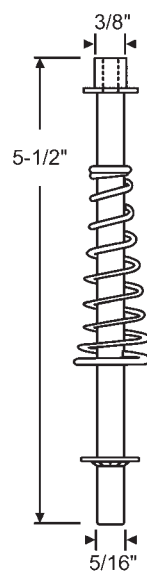

Assembly # 1-252	
Pin w/Cap	1-261
Spring	5-62
Push Nut	6-111

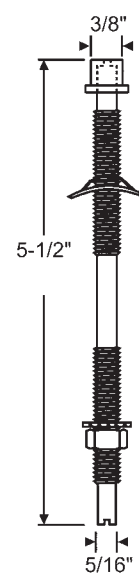

Assembly # 1-123	
Cap	4-114
Tooth Lock Washer	6-118
Threaded Tinnerman	6-125
Hex Nut	6-128

BENCHMARK

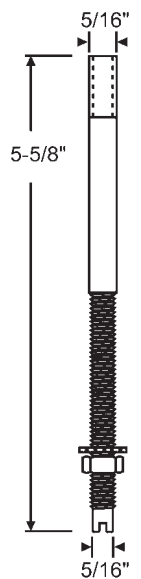

Assembly # 1-195	
Pin w/Cap	1-194
Cap	4-126
Hex Nut	6-128
Tooth Lock Washer	6-118

FLOATAWAY

CLOSET DOOR HARDWARE

BI-FOLD CLOSET DOOR PIN ASSEMBLIES

5/16" DIAMETER

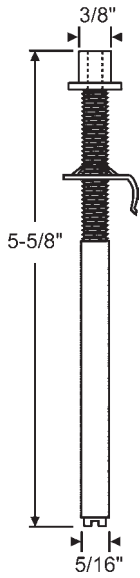

Assembly # 1-174	
Cap	4-117
Threaded Tinnerman	6-145

SLIMFOLD

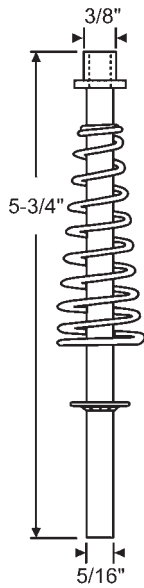

Assembly # 1-176	
Pin w/Cap	1-175
Cap	4-119
Spring	5-51
Push Nut	6-111

FENESTRA

3/8" DIAMETER

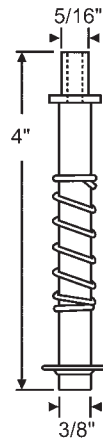

Assembly # 1-257	
Cap	4-130
Spring	5-60
Push Nut	6-100

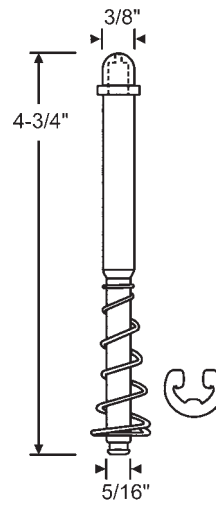

Assembly # 1-129	
Pin w/Cap	1-128
Cap	4-116
Spring	5-58
E-Ring	6-112

FLOATAWAY

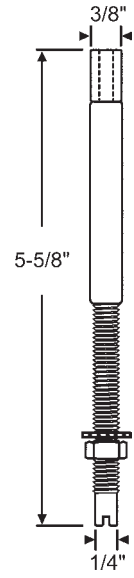

Assembly # 1-101	
Pin w/Cap	1-100
Cap	4-101
Hex Nut	6-128
Tooth Lock Washer	6-118

FLOATAWAY

PEACHTREE/FLOATAWAY

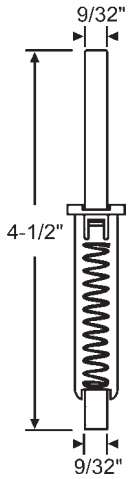

Assembly # 1-107

**PEACHTREE
FLOATAWAY**

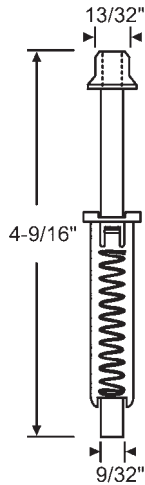

Assembly # 1-108	
Cap	4-127

**PEACHTREE
FLOATAWAY**

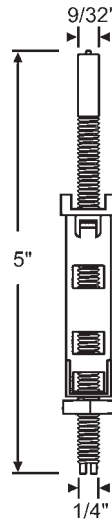

Assembly # 1-106	
Hex Nut	6-128
Pin Sleeve	8-308

**PEACHTREE
FLOATAWAY**

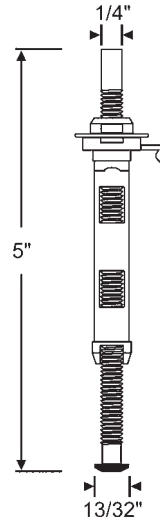

Assembly # 1-103	
Square Nut	6-157
Speed Nut	6-161
Pin Sleeve	900-6656

FLOATAWAY

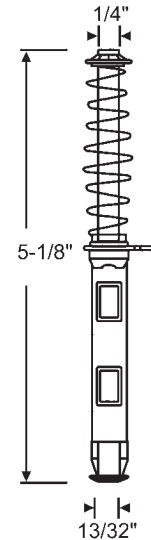

Assembly # 1-104	
Spring	5-59
Push Nut	6-122

FLOATAWAY

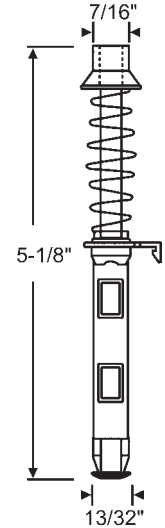

Assembly # 1-105	
Cap	4-106
Spring	5-59

FLOATAWAY

BI-FOLD CLOSET DOOR CAPS

Caps Shown Actual Size

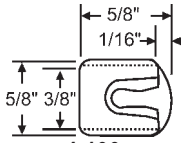

4-100
5/16" Thick
Fits Pin 1-151
LEIGH/MONARCH

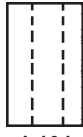

4-101
Fits Pins 1-100, 1-149, 1-101,
1-232, 1-148
FLOATAWAY

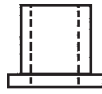

4-103
Fits Pins 1-183, 1-184
SLIMFOLD

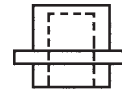

4-104
Fits Pins 1-162, 1-171, 1-163,
1-172, 1-172K
LEIGH/MONARCH

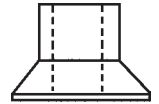

4-106
Fits Pins 1-105, 900-9422
FLOATAWAY

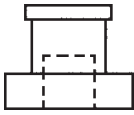

4-107
Fits Pins 1-156, 1-157
NATIONAL

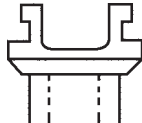

4-108
Fits Pins 1-130, 1-131
NATIONAL



4-111
Fits Pins 1-145, 1-188,
1-226, 1-144A, 1-145A
LEIGH/MONARCH

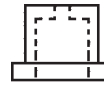

4-114
Fits Pins 1-170, 1-123,
1-235, 1-169, 1-237
BENCHMARK

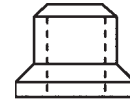

4-115
Fits Pins 1-132, 1-159,
1-133, 900-14476, 900-
17552, 1-223, 1-158,
1-224, 1-262, 900-8841A
PEACHTREE

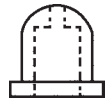

4-116
Fits Pins 1-128, 1-228,
1-129, 1-229
FLOATAWAY

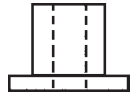

4-117
Fits Pins 1-174, 1-197,
1-232, 1-261
SLIMFOLD

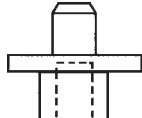

4-118
Fits Pins 1-140, 1-202,
1-207, 1-141, 1-203, 1-219,
1-179, 1-206, 1-220, 1-180
FENESTRA

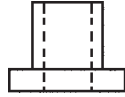

4-119
Fits Pins 1-136, 1-175,
1-204, 1-230, 1-137, 1-176,
1-205, 1-236, 1-200, 1-217,
1-238, 1-143, 1-201, 1-218,
1-260, 1-269, 1-273, 1-243,
1-244, 1-250, 1-259
FENESTRA

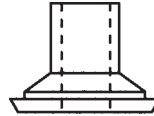

4-120
Fits Pin 1-102
SLIMFOLD

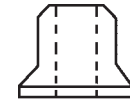

4-127
Fits Pins 1-108
PEACHTREE

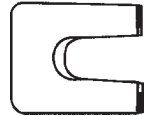

4-129
Fits Pin 1-246
LEIGH/MONARCH

BI-FOLD CLOSET DOOR SPRINGS

In Order by Height

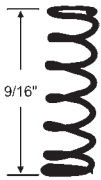

5-73
BAYFORM

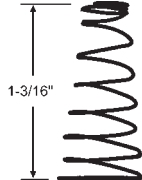

900-9421S

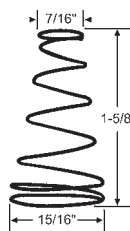

5-62
SLIMFOLD

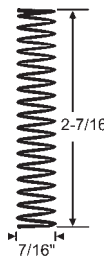

5-50
BENCHMARK

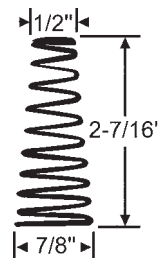

5-51

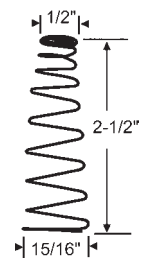

5-63

BI-FOLD CLOSET DOOR ACCESSORIES

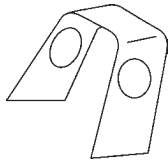

6-101
Compression Retainer for
1/4" Pins. Used with 1-224,
1-237, 1-269, 1-273
BENCHMARK



6-136
Hairpin Clip. Used with
1-144A, 1-145, 1-145A,
1-153, 1-153A, 1-163

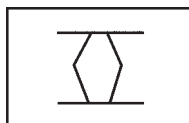

6-143
1/4" Tinnerman Clip

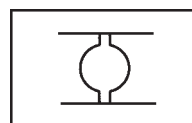

6-125
5/16" Threaded Tinnerman



Part #	Size
6-112	1/4"
6-110	5/16"
6-109	3/8"

E-Ring

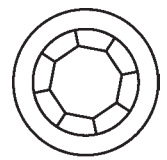

Part #	Size
6-122	1/4"
6-111	5/16"

Push Nut

CLOSET DOOR HARDWARE

METAL CLOSET DOOR PIVOT BRACKETS

In Order by Length

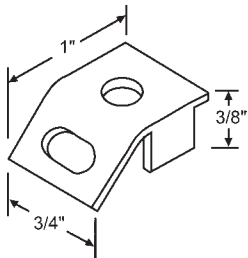

7-240
Metal
LEIGH/MONARCH

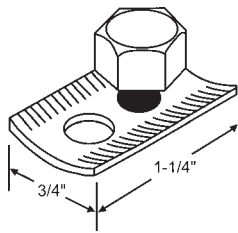

7-234
Metal
LEIGH/MONARCH

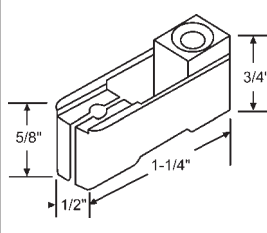

7-225
Nylon
PEACHTREE

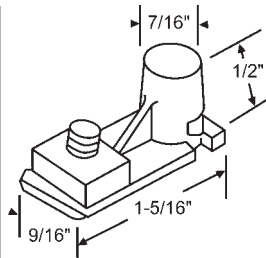

7-246
Nylon
PEACHTREE

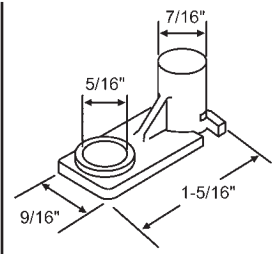

7-227
Nylon

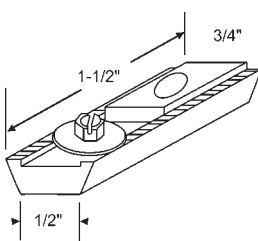

7-210A
Nylon
NATIONAL

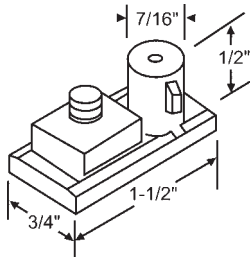

7-230
Nylon
PEACHTREE

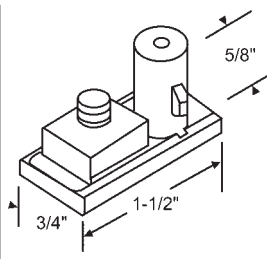

7-247
Nylon
BENCHMARK

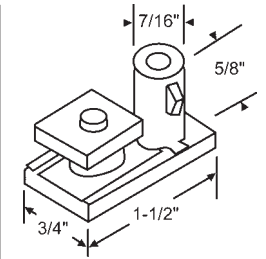

7-229
Nylon
PEACHTREE

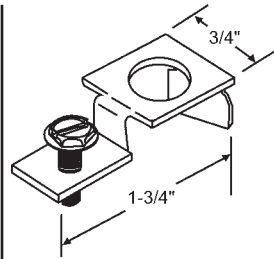

7-226
Metal
BENCHMARK

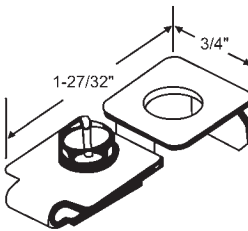

7-200
Metal
SLIMFOLD

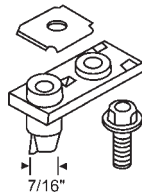

7-223
Nylon
FLOATAWAY

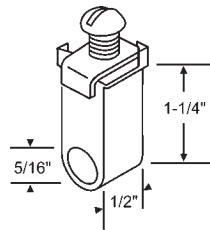

7-224
Nylon

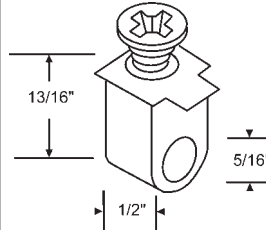

7-231
Nylon
New Style
SLIMFOLD

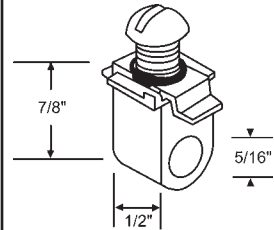

7-231OS
Nylon
Old Style
SLIMFOLD

METAL CLOSET DOOR NYLON GROMMETS/BUSHINGS/BUMPERS

In Order by Height

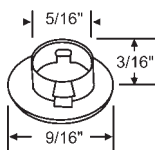

8-255
NATIONAL

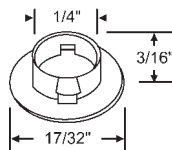

8-254
NATIONAL

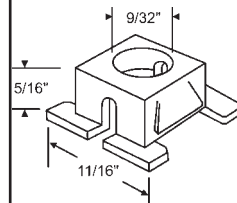

8-262
PEACHTREE

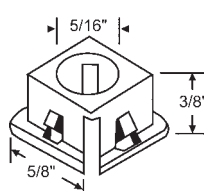

8-268
PEACHTREE

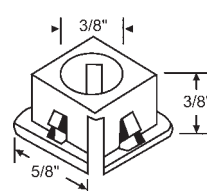

8-269
PEACHTREE

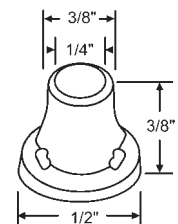

8-261
Blue
BENCHMARK

METAL CLOSET DOOR NYLON GROMMETS/BUSHINGS/BUMPERS

In Order by Height

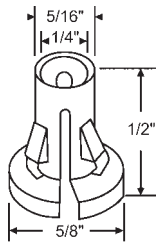

8-264

FLOATAWAY

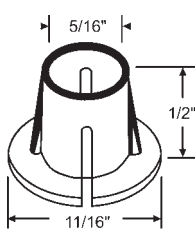

8-267

FLOATAWAY

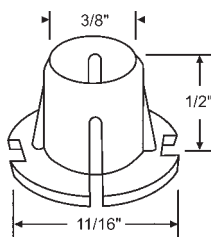

8-280

FLOATAWAY



8-259

LEIGH/MONARCH

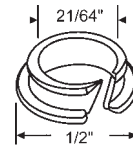

8-260

LEIGH/MONARCH

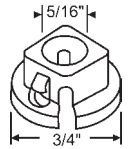

8-266

FLOATAWAY

In Order by Length

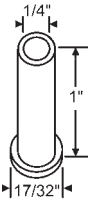

8-359

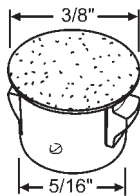

900-21195

White Plastic Bushing Cap

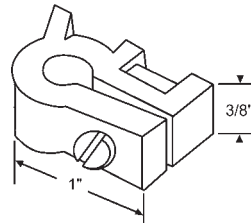

8-309

Pivot Rod Lock Pin

BENCHMARK

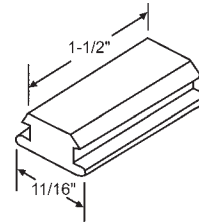

8-271

Gray

NATIONAL

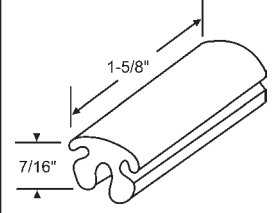

8-304

White

FLOATAWAY

METAL CLOSET DOOR PLATES & PULLS

In Order by Diameter & Height

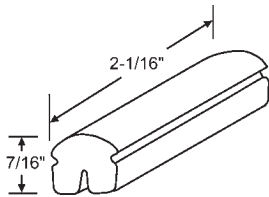

8-279

Gray Bi-fold Track Bumper

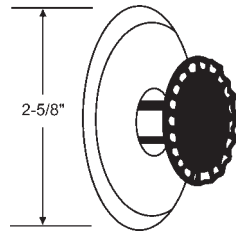

Part #	Finish
8-228B	Bronze
8-228A	Polished Aluminum

FLOATAWAY

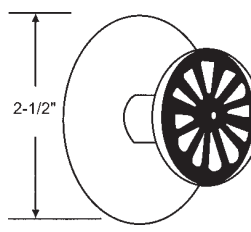

8-258

Brass with Screw
8-327 Knob, 8-321 Back Plate

SLIMFOLD

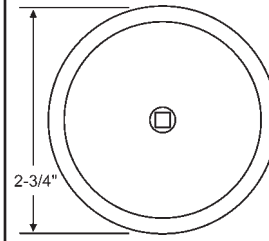

Part #	Finish
900-10221C	Chrome
900-10221	Polished Brass
900-10221SNK	Satin Nickel

Back Plate

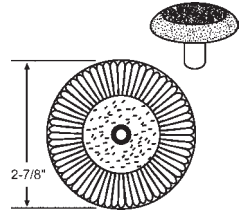

8-289

Antique Brass
Adhesive Pad Only: 900-13008

BENCHMARK

BI-FOLD DOOR HINGE

CLOSET DOOR TRACK

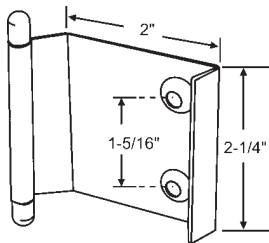

8-278

Door Pull Set
SLIMFOLD

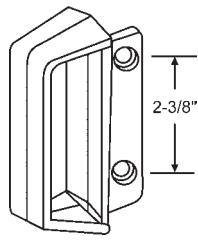

8-305

White
PEACHTREE FLOATAWAY

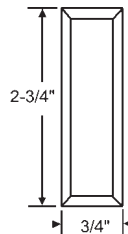

900-16101-1

Gray Mirror Pull
Self Adhesive

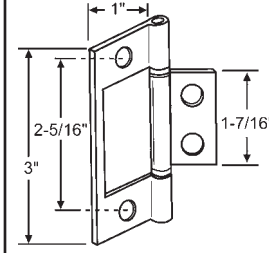

900-820

Brass Plated Steel

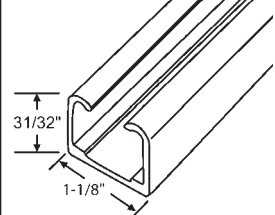

Part #	Size
8-467-3	3'
8-467-4	4'
8-467-6	6'

KENNAFRAME

CLOSET DOOR HARDWARE

WOOD CLOSET DOOR PLUNGER PINS, BRACKETS, PLATES & CAPS

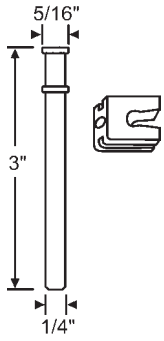

Assembly # 1-246
Guide Cap 4-129

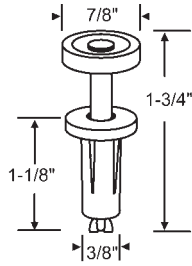

2-104
Top Rolling Guide
Spring Loaded
ACME

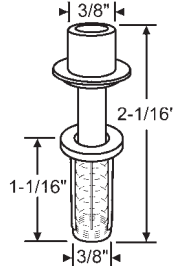

2-122

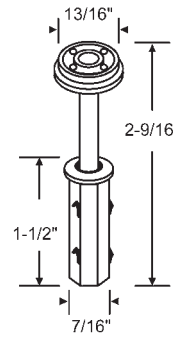

2-109
OLD STANLEY

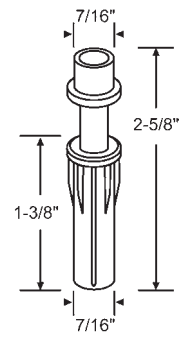

2-76
4-125 Cap Only

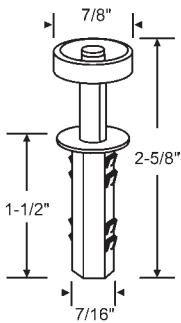

2-58
ACME

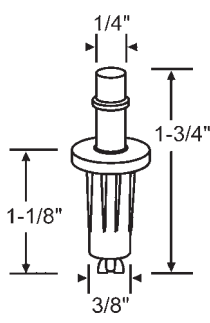

2-113
ACME

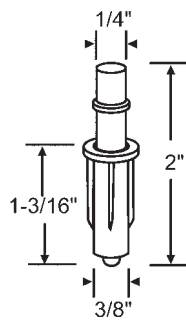

2-105

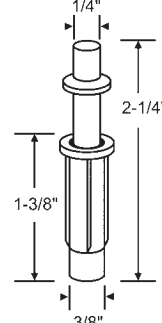

2-110
ALLIANCE

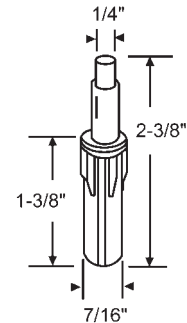

2-77

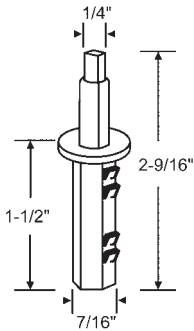

2-60
Use with 2-92
ACME

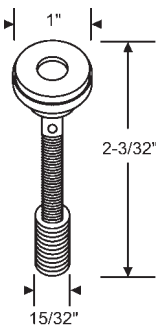

2-112
8-281 Bushing Only
2-111 Pin Only

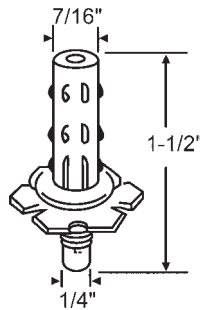

2-78

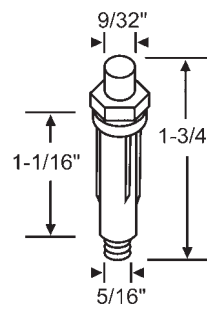

2-106

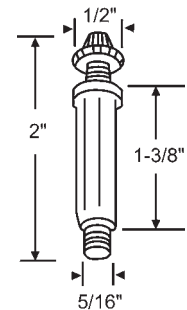

2-121

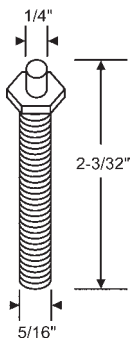

2-116

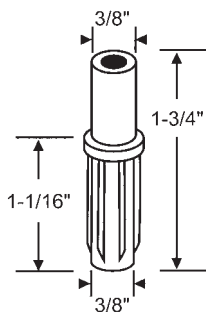

2-62
ACME

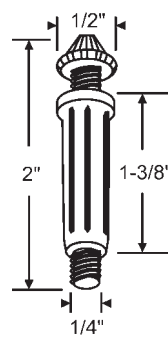

2-63
ACME

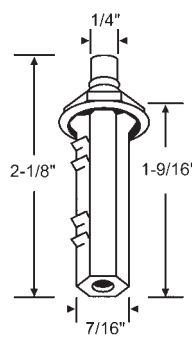

2-59
ACME

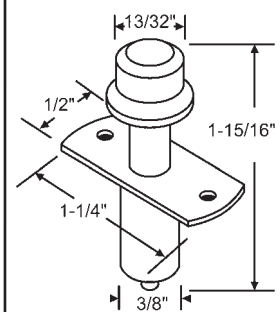

2-95
HARVEY

CLOSET DOOR HARDWARE

WOOD CLOSET DOOR PLUNGER PINS, BRACKETS, PLATES & CAPS

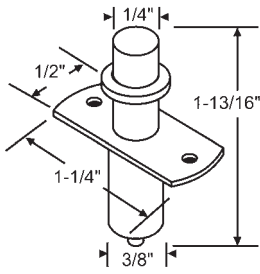

2-85

HARVEY

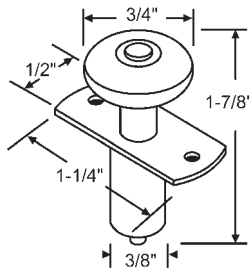

2-52

HARVEY

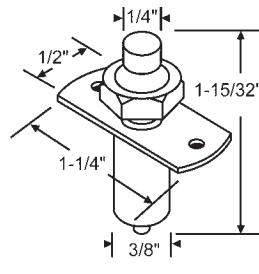

2-97

HARVEY

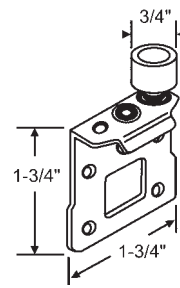

Part #	Hand
2-66	Shown
2-65	Opposite

PANIFLEX

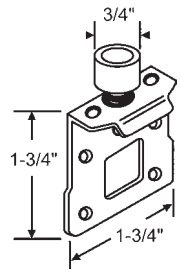

2-67

PANIFLEX

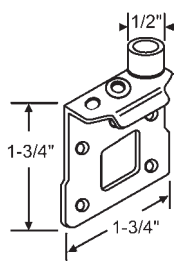

Part #	Hand
2-71	Shown
2-70	Opposite

PANIFLEX

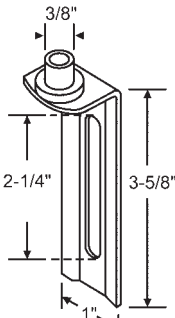

2-94

Includes Attaching
Screws 1/4" - 20" x 1/2"

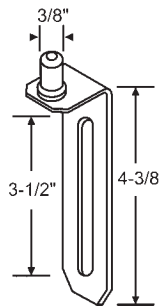

2-118

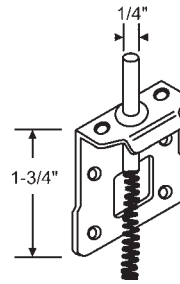

2-68
PANIFLEX

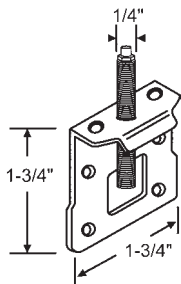

2-69
PANIFLEX

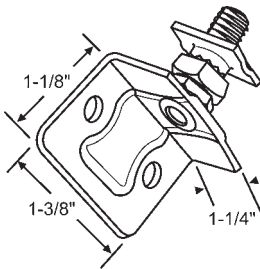

900-808-OS

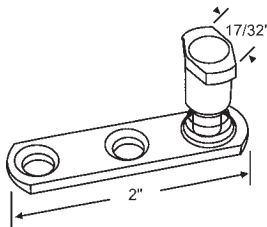

2-108
STANLEY

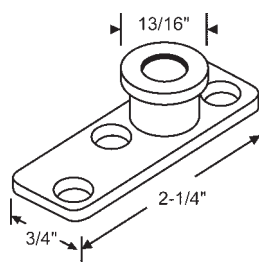

2-50

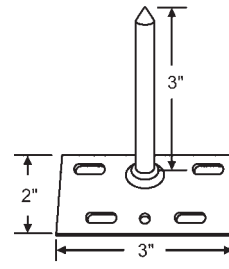

2-120
Top Plate. Use with 8-338

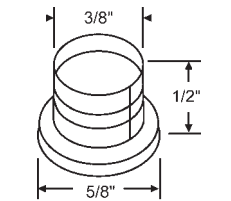

8-338

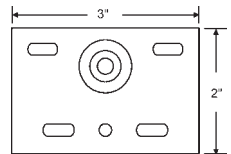

7-253
Bottom Plate

CLOSET DOOR ROLLERS

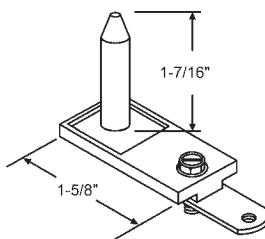

900-10518

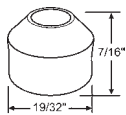

4-121

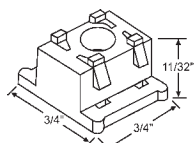

4-124
ALLIANCE

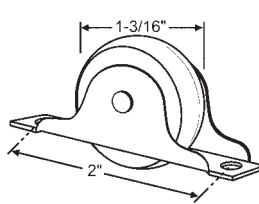

3-351
Nylon Wheel

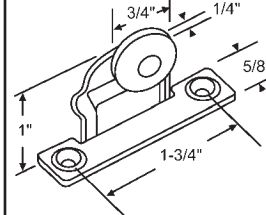

3-219
Nylon Wheel
HARVEY

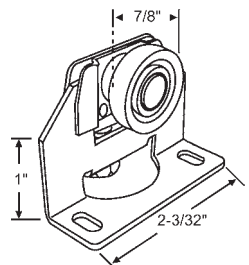

3-151

CLOSET DOOR HARDWARE

WOOD CLOSET DOOR BY-PASS HANGERS

In Order by Roller Diameter

3/4" Roller

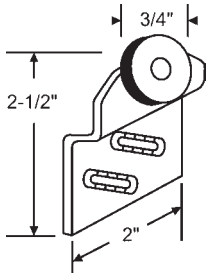

3-165
1/4" Offset
E-Z ROLL

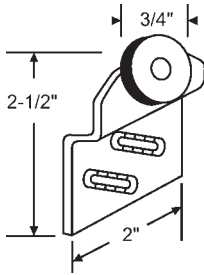

3-164
1/2" Offset
E-Z ROLL

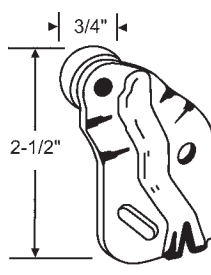

3-190
1/4" Offset
E-Z ROLL

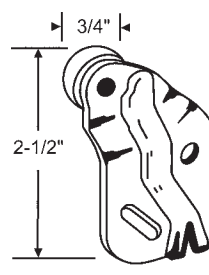

3-191
1/2" Offset
E-Z ROLL

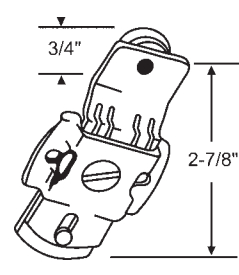

3-170
1/4" Offset

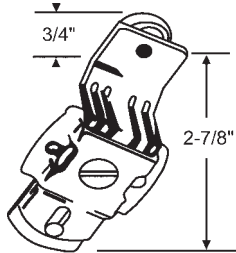

3-171
1/2" Offset

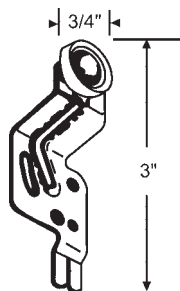

3-203
3/4" Offset
w/ Screws

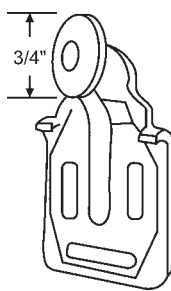

900-21054
1/2" Offset
Includes Screws

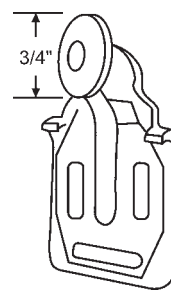

900-7798
3/16" Offset
Includes Screws

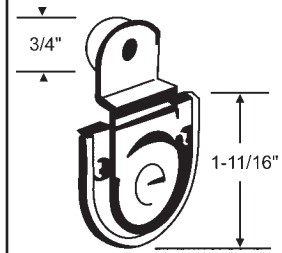

3-206
1/8" Offset
LAWRENCE

27/32" Roller

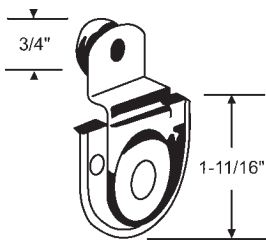

3-185
1/2" Offset
LAWRENCE

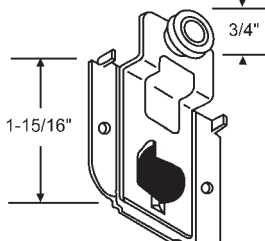

3-172
1/4" Offset
GRANT

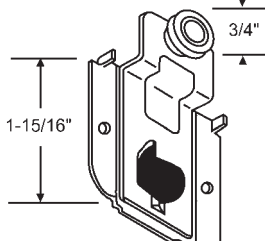

3-173
1/2" Offset
GRANT

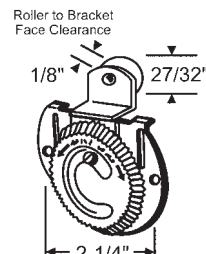

3-199
1/16" Offset
OLD STANLEY

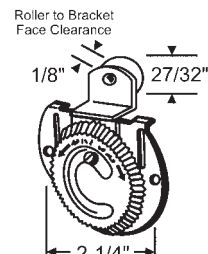

3-198
3/8" Offset
OLD STANLEY

7/8" Roller

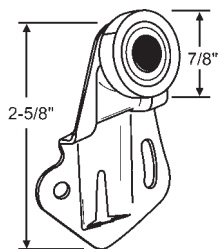

3-339
3/8" Offset Universal Hanger

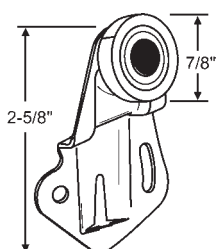

3-340
1/16" Offset Universal Hanger

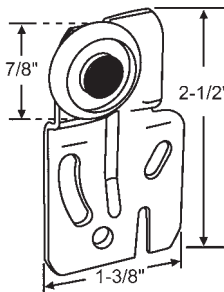

3-152
1/4" Offset
ACME

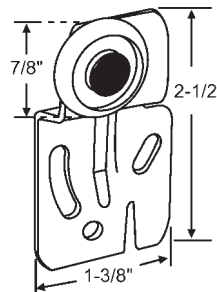

3-153
1/2" Offset
ACME

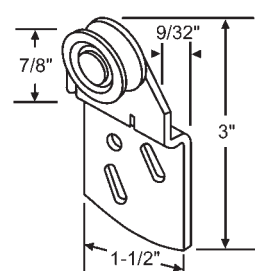

3-107
9/32" Offset
3-107S for Hanger with Screws

WOOD CLOSET DOOR BY-PASS HANGERS

7/8" Roller

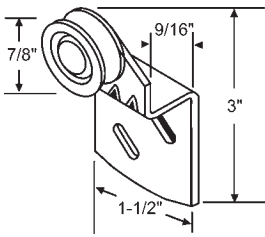

3-108

9/16" Offset

3-108S for Hanger with Screws

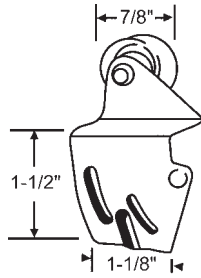

3-147

3/8" Offset

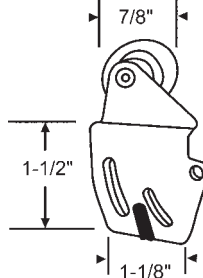

3-146

1/16" Offset

Roller to Bracket
Face Clearance

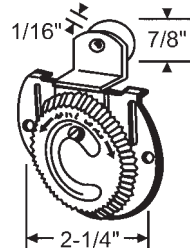

3-207

1/8" Offset

Roller to Bracket
Face Clearance

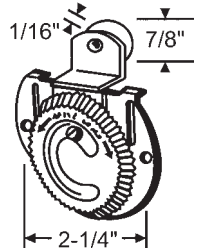

3-208

7/16" Offset

31/32" Roller

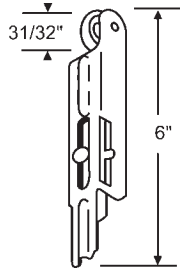

Part #	Hand
3-202	Shown
3-201	Opposite

1" Roller

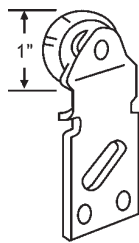

900-1304

Front Hanger w/Ball Bearing
Wheel, 1/16" Offset

E-Z ROLL

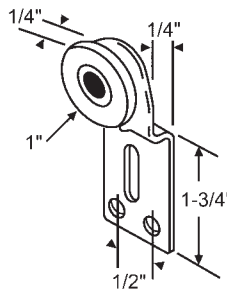

3-212

Front Hanger

COX

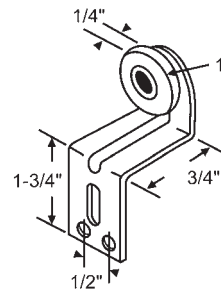

3-211

Rear Hanger

COX

1-3/16" Roller

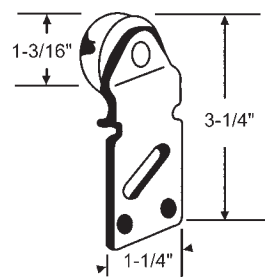

3-193

1/16" Offset

WOOD CLOSET DOOR BY-PASS HANGERS - 2-WHEEL

1-3/8" Roller

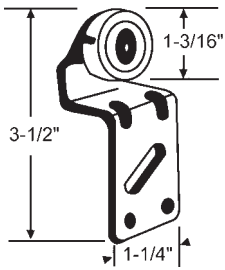

3-195

1-3/8" Offset

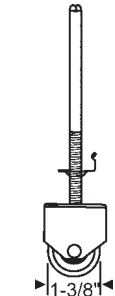

900-12272N

New Style

13/16" Rollers

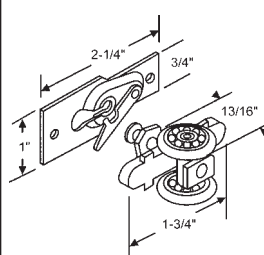

900-10534

Ball Bearing Wheels

7/8" Rollers

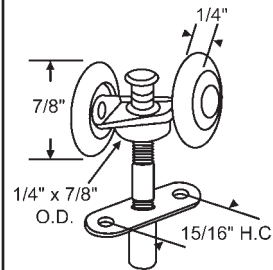

3-223

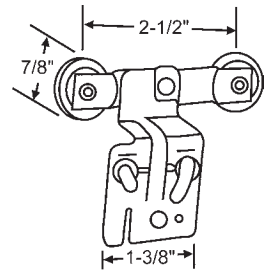

3-113

w/ Screws. 1/4" Offset

ACME

WOOD CLOSET DOOR BY-PASS HANGERS - 3-WHEEL

3/4" Rollers

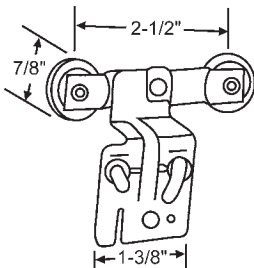

3-112

w/ Screws. 1/2" Offset

ACME

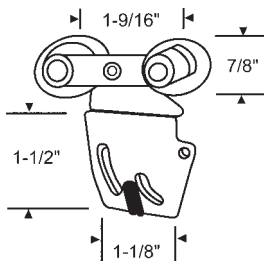

3-143

3/8" Offset

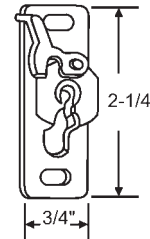
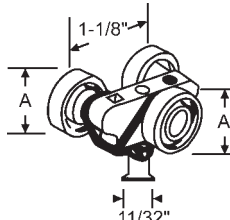

Part #	Wheel Type	A
3-141	Nylon	3/4"
3-141BB	Ball Bearing Nylon	3/4"
3-140	Nylon	1"
3-140BB	Ball Bearing Nylon	1"

Comes with 8-226 Bracket

CLOSET DOOR HARDWARE

WOOD CLOSET DOOR BY-PASS HANGERS - 4-WHEEL

PLUNGER PLATE

23/32" Rollers

3/4" Rollers

13/16" Rollers

7/8" Rollers

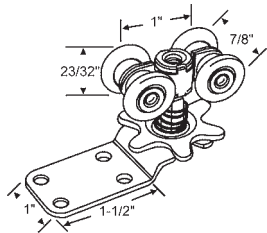

3-126

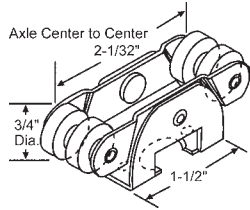

900-569

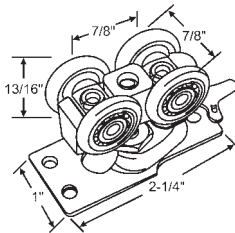

900-9746A

Includes Hardware Kit

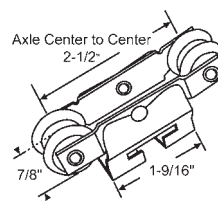

900-803-OS

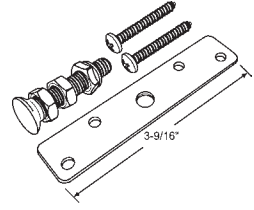

900-586

Top Plate With Pendant Bolt

WOOD CLOSET DOOR PANEL JACKET HANGERS

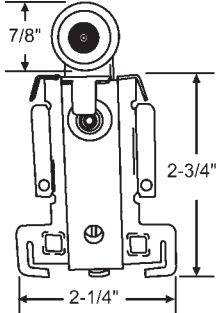

3-120

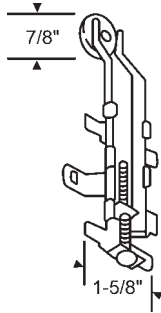

3-133

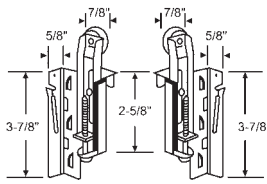

3-122A

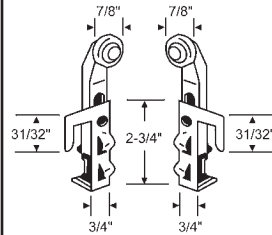

3-116A

ACME

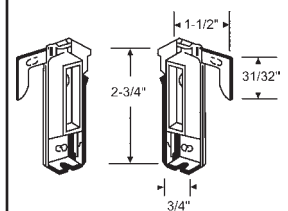

3-118A

ACME

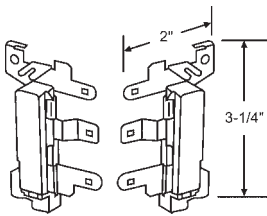

3-156A

COX

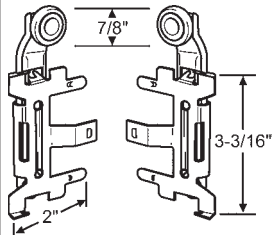

3-158A

Corner Connector Hanger Set

COX

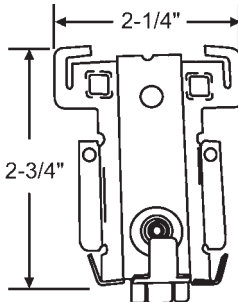

3-121

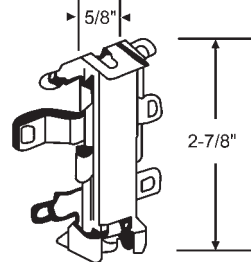

3-132

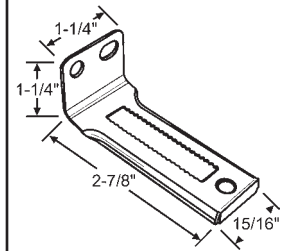

7-221

Metal

ACME

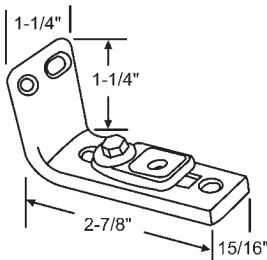

7-222

Metal with Nylon Insert

7-222-2 For 2 Brackets w/Screws

ACME

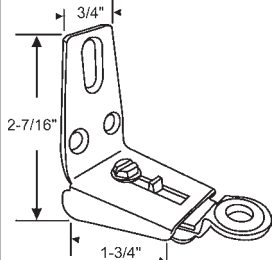

7-205

Metal

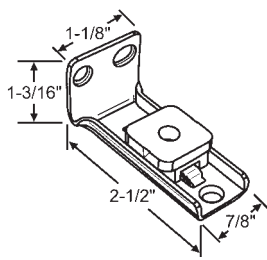

7-241

Metal with Nylon Insert

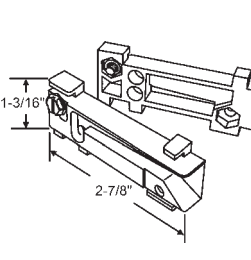

7-235A

Sold as Set (1 Left Hand, 1 Right Hand). Nylon

PANIFLEX

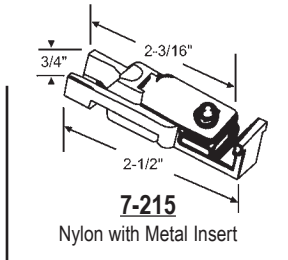

7-215

Nylon with Metal Insert

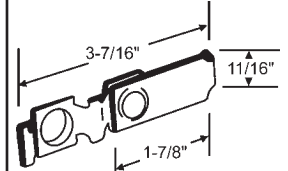

7-216

Metal

CLOSET DOOR HARDWARE

WOOD CLOSET DOOR PIVOT/JAMB BRACKETS

WOOD CLOSET DOOR PULLS & KNOBS

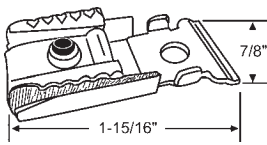

7-237
Metal
ACME

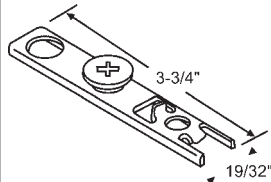

7-220N
Metal (New Style)
ACME

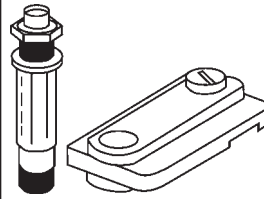

7-254A
Bracket with Plunger Pin
7-254
Bracket Only

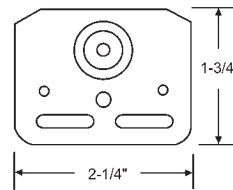

7-201
Metal
PANIFLEX

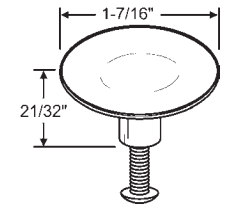

Part #	Finish
8-300	Brass Plated
8-300C	Chrome Plated
8-300SNK	Satin Nickel

Die Cast

WOOD CLOSET DOOR PULLS & KNOBS

In Order by Type, then Outside Diameter

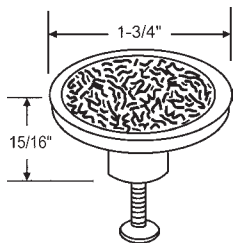

8-298
Plastic, Brown

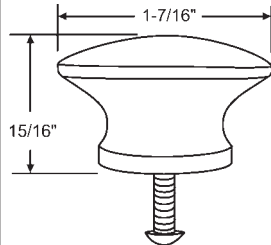

8-235
Wood, Unfinished

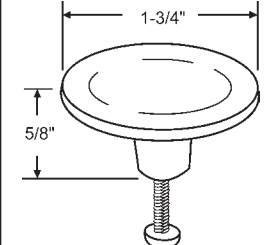

Part #	Finish
8-301	Brass Plated
8-301C	Chrome Plated
8-301SNK	Satin Nickel

Die Cast

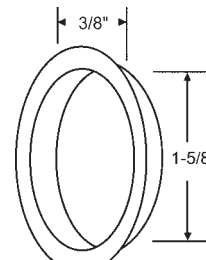

900-793
Nylon, Tan
Flush

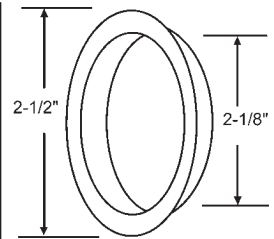

Part #	Finish
8-202	Brass Plated
8-202AB	Antique Brass Plated
8-202C	Chrome Plated

Die Cast
E-Z ROLL

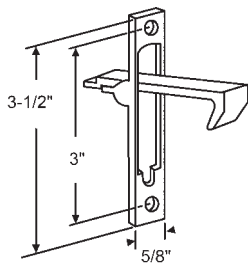

900-790
Metal, Bright Brass Finish
Flush Mount Edge Pull

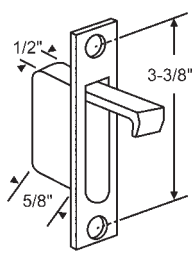

900-43
Metal, Aluminum Finish

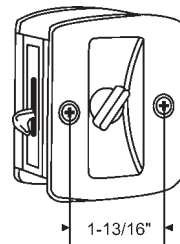

900-14604
Stamped Steel Combination Door
Pull and Privacy Lock Adjuster for
1-3/8" to 1-3/4" Doors.
Polished Brass Finish
Includes Keeper.

WOOD CLOSET DOOR FLOOR GUIDES/PLATES

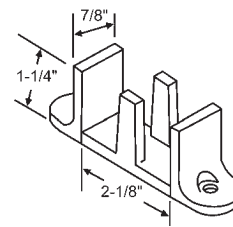

8-245
Adjusts for Doors 7/8" - 1-7/8"
Nylon

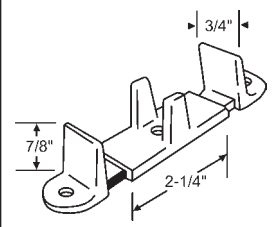

8-294
Adjusts for Doors 3/4" - 1-3/4"
Nylon, Tan - Includes Screws

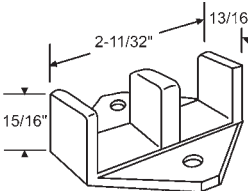

8-314
Nylon, 1 Piece. Fits 3/4" Doors
E-Z ROLL

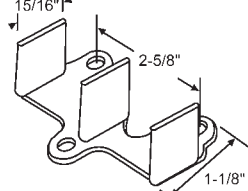

900-8114
Nylon
1 Piece. Fits 1-3/8" Doors

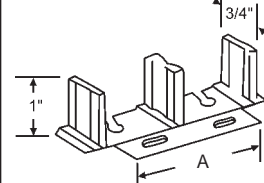

Part #	A	Adjusts for Doors
8-231	2-3/4"	3/4" - 1-3/8"
8-232	3-1/2"	1/8" - 1-3/4"

Metal w/Nylon Post. Wood Tone.

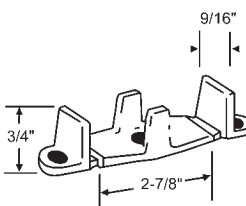

8-240
Nylon, White. Adjusts for Doors
3/4" - 1-3/4"
E-Z ROLL

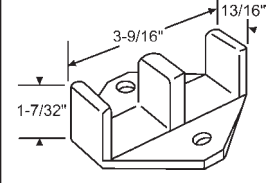

8-291
1 Piece. Floor Guide to Fit 1-3/8"
Double Doors 1-1/4"
High from Floor
E-Z ROLL

CLOSET DOOR HARDWARE

WOOD CLOSET DOOR FLOOR GUIDES/PLATES

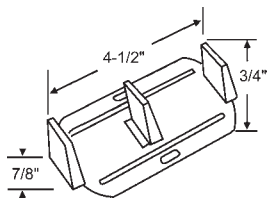

8-315

Metal with Nylon Posts
For 1-3/4" Doors

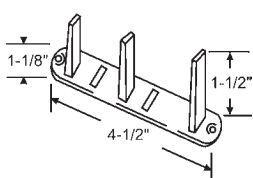

8-330

Metal with Nylon Posts
Adjusts for Doors 3/4" - 1-3/8"

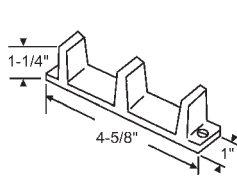

8-208

One Piece Nylon with Fixed
Guides for 1-3/8"
By-Passing Doors
ACME

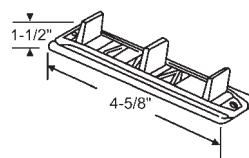

8-209-4

Metal with Nylon Posts.
Adjustable for 3/4", 1", 1-1/8" and
1-3/8" By-Passing Doors
4 per pack with Screws.
ACME

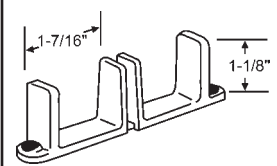

8-316

Nylon
Adjustable For 1-3/8" By-Passing
Doors 2 pieces
E-Z ROLL

PIVOT GUIDE

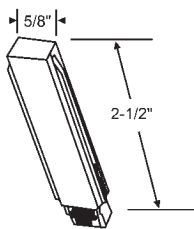

8-296

Nylon Insert Guide

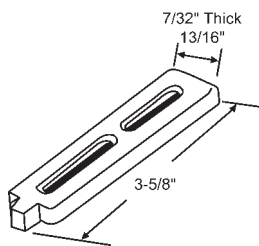

8-295

Guide Stem
PANIFLEX

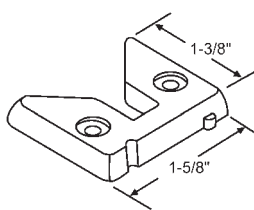

900-849

Nylon. Floor Plate (Single)
PANIFLEX

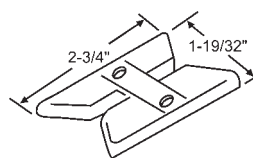

900-848

Nylon. Floor Plate (Double)
PANIFLEX

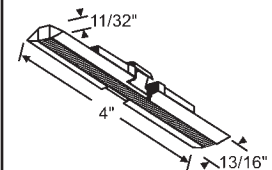

2-92

Pivot Guide
ACME

WOOD CLOSET DOOR SNUGGERS

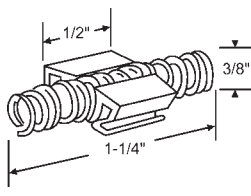

8-213

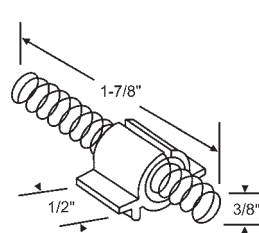

8-203

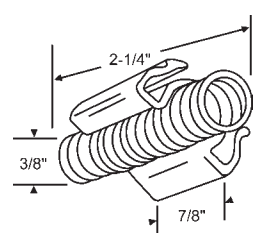

8-217

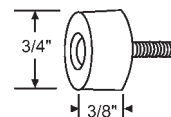

8-246

White Rubber Door Bumper
with Screw

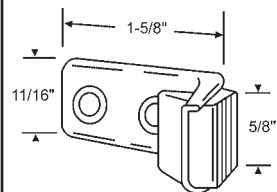

8-224

Metal Angle Stop
w/Rubber Bumper
STANLEY

BUMPERS

CLOSET POLE SOCKET

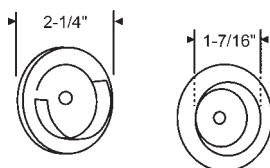

900-15321WH

White

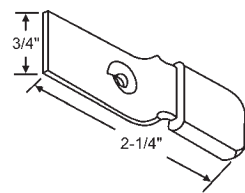

8-204

Closet Door Guide
Metal with Rubber Sleeve

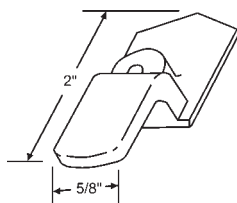

8-319

White Nylon Door Guide

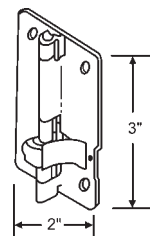

8-230

Door Hinge
PANIFLEX

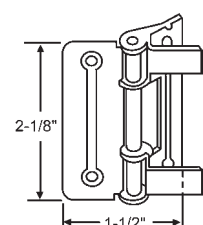

8-236

Door Hinge

CLOSET DOOR MISCELLANEOUS ACCESSORIES

CLOSET DOOR MISCELLANEOUS ACCESSORIES

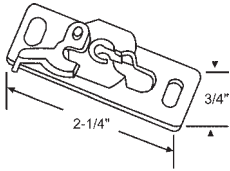

8-226
Mounting Brackets
for 3-141 Rollers

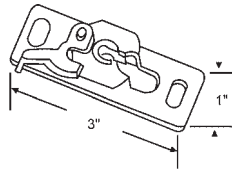

8-227
Mounting Brackets for 3-139 and 3-140
Rollers

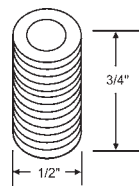

8-281
Threaded Bushing
Use with 2-112 Plunger Pin

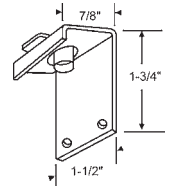

8-326
Adapter Plate

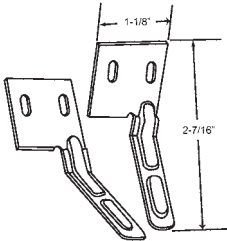

900-15909
Door Aligner

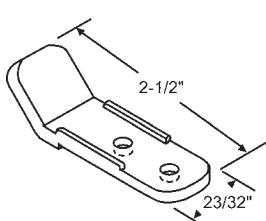

900-847
Aligner
PANIFLEX

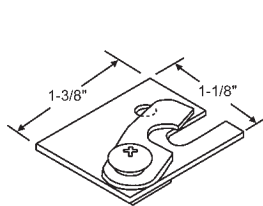

900-8986
Cam Lock Assembly

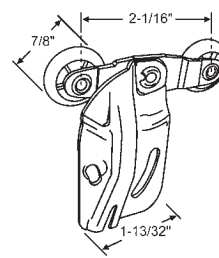

900-656
Front Dual Wheel Hanger

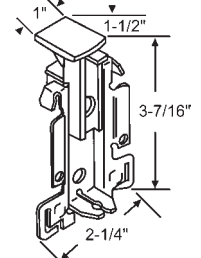

900-12459
Top Guide

BI-FOLD DOOR REPAIR BRACKET

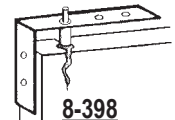

8-398
Repair split bifold door. Repair loose pivot pins. Fits all bifold doors. No drilling required attaches in minutes. Heavy metal bracket pulls a split bifold door together. Loose pivot pins welded permanently in place. Repair bracket lasts for years and years. Simply screw bracket onto the edge of split door. Not visible when installed.

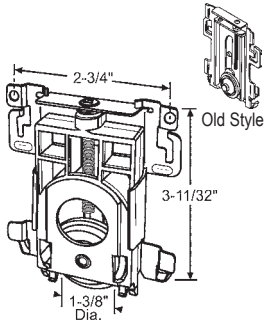

900-11827
Bottom Roller

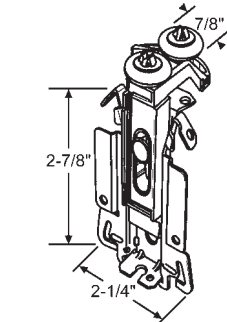

3-386
Mirror Door Top Guide. 2 Rubber
Wheels

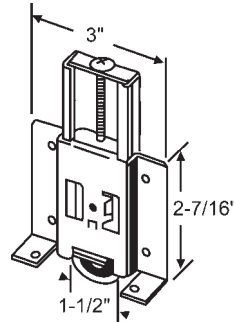

3-227
1-1/2" All Nylon Roller

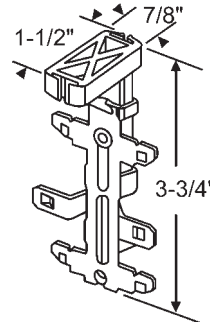

3-228
Guide Bracket

CLOSET DOOR SAVERS

A way to repair bifold doors in minutes. Anyone who has wooden bifold doors knows the difficulty involved in repairing broken or cracked pin holes. The Closet Door Saver will quickly and economically repair a broken corner and make it sturdier than the original door. The beauty of the Closet Door Saver is the ease of installation. Simply drill a 7/8" hole over the original pin hole. Slide the Closet Door Saver over the broken corner and insert the door pin. Fasten by screws or construction adhesive. Your Door is Now Permanently required! Closet Door Savers are constructed of durable plastic.

Closet Door Saver

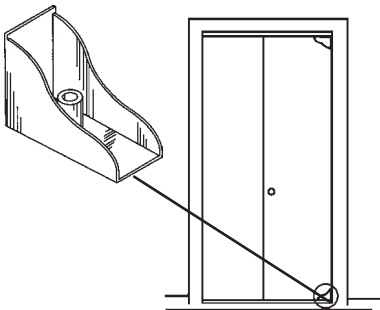

Part #	Finish
900-19405	Light Oak
900-19405D	Dark Oak
900-19405W	White

Single Sided Closet Door Saver

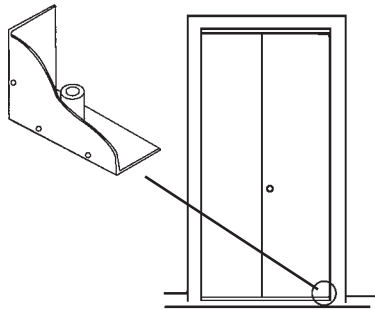

Part #	Finish
8-404	Light Oak
8-404D	Dark Oak
8-404W	White

Bi-Fold Door Saver Bracket

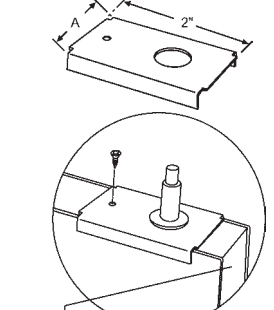

Fits 1-3/8" Doors

Part #	A
2-138	1-1/16"
2-139	1-1/8"
2-140	1-1/2"

Steel

CLOSET DOOR HARDWARE

BI-FOLD DOOR TRACK SETS

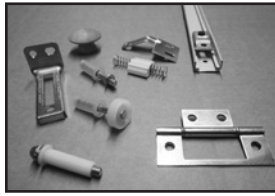

Includes the Following:

1. Roll form steel painted white top track.
2. Hardware bag includes 3/8" top and bottom pivots, top and bottom brackets, hinges, aligners, wood knobs, snugger and screws.
3. Instruction sheet.

Sold by the set in multiples of 5.

For use with 1" to 1-3/8" solid wood doors weighing up to 30lbs. each

Part Number	Length	Doors
8-562-4	4'	4
8-562-5	5'	4
8-562-6	6'	4

CW MIRROR BY-PASS DOOR HARDWARE

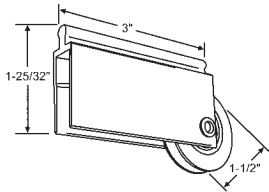

900-8319

Round-top Mirror Door Roller.
Nylon Wheel
MONARCH

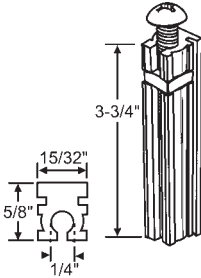

900-10252

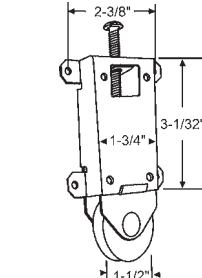

3-348

Wardrobe Door Bottom Roller with Angled Tang. Nylon Wheel

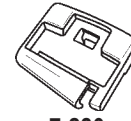

7-280

Plastic Top Guide



7-281

Metal Top Guide Bracket

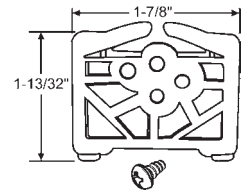

900-21382

Nylon Mirror Door Guide with Screw

CW MIRROR BI-FOLD DOOR HARDWARE

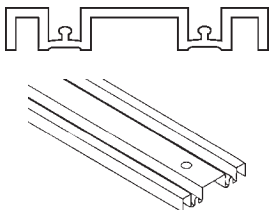

Part #	Length
8-636-5	5ft
8-636-6	6ft
8-636-8	8ft

Ultra Glide Track, 3" Wide Steel w/ Aztec Gold Finish.

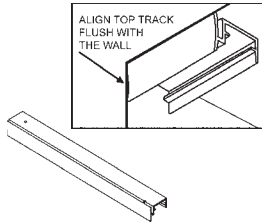

Part #	Length
8-635-5	5'
8-635-6	6'
8-635-8	8'

Top and Bottom Steel Track. 3" Wide

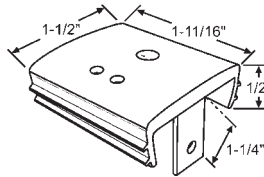

8-645

Mirror Door Guide & Bracket. Flexible Plastic Top Guide w/ Steel Mounting Bracket
MONARCH

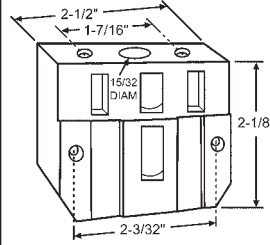

8-647

Corner Connector for Mirror Door

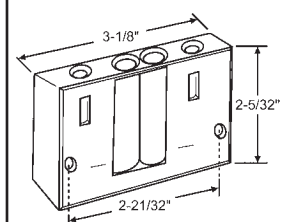

8-324

Corner Connector for Mirror Door

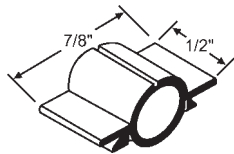

8-634

Tension Clip

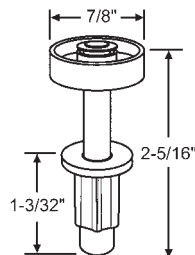

2-142

Guide Pin

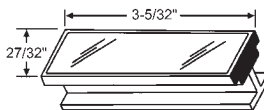

8-633

Mirror Handle

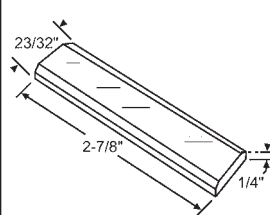

8-473

Stick on Mirror Pull.

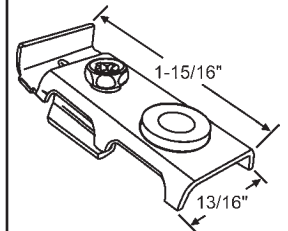

7-279

Pivot Block Clamp

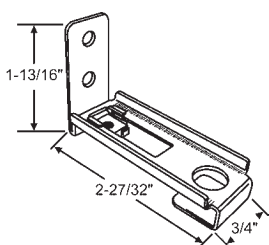

7-278

Pivot L-Bracket

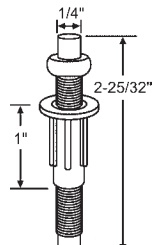

2-143

5/32" Female Hex Threaded Pivot

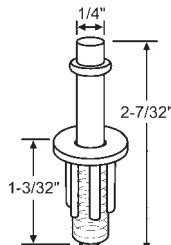

2-144

Top Spring Pivot Pin

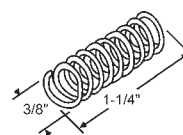

5-120

Small Spring

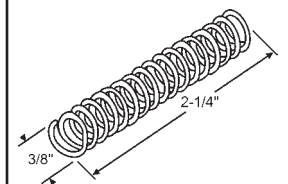

5-121

Large Spring

E-Z ROLL SLIDING DOOR TRACK SETS

7000 Series Sliding Door Track Set for 3/4" and 1-3/8" by-passing doors up to 50 lbs. each

- Track Made of Extruded Aluminum
- Nylon Wheels for Smoother and Quieter Operation
- Simple Adjustment with Screwdriver
- Complete with All Necessary Hardware and Instruction Sheet
- Packed 3 Sets to a Master Carton

Part #	Description
7048HU	46-1/2" for 4' Opening
7060HU	58-1/2" for 5' Opening
7072HU	70-1/2" for 6' Opening

Aluminum Track Sets
Packed and Sold Three Sets per Tube.
Each Set Includes all Necessary Hardware.

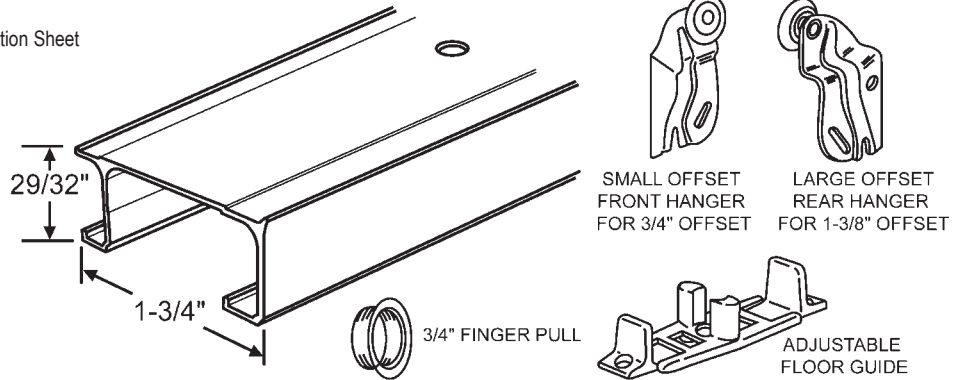

E-Z ROLL UNIVERSAL HANGERS FOR SLIDING DOOR TRACK SETS

<p>3-193 Front Hanger w/Nylon Wheel, 1/16" Offset</p>	<p>3-194 Rear Hanger w/Nylon Wheel, 5/8" Offset</p>	<p>3-195 Rear Hanger w/Nylon Wheel, 1-3/8" Offset</p>	<p>900-1304 Front Hanger w/Ball Bearing Wheel, 1/16" Offset</p>	<p>900-1305 Rear Hanger w/Ball Bearing Wheel, 1-1/2" Offset</p>	<p>900-1308 Front Hanger w/Nylon Wheel, 1/16" Offset</p>
<p>900-1305N Rear Hanger w/Nylon Wheel, 1-1/2" Offset</p>	<p>900-1306 Top Mounting Hanger for Single Pocket Door w/Ball Bearing Wheel</p>	<p>900-1307 Top Mounting Hanger for Single Pocket Door w/Nylon Wheel</p>	<p>900-1314 Screen & Patio Door Hanger w/Nylon Wheel, 3/8" Offset</p>	<p>3-382 Front Hanger for Wardrobe w/Nylon Wheel, 1/8" Offset</p>	<p>3-381 Rear Hanger for Wardrobe w/Nylon Wheel, 3/8" Offset</p>
<p>3-165 Front Hanger w/Nylon Wheel, 1/4" Offset</p>	<p>3-164 Rear Hanger w/Nylon Wheel, 1/2" Offset</p>	<p>3-190 Front Hanger w/Nylon Wheel, 1/4" Offset</p>	<p>3-191 Rear Hanger w/Nylon Wheel, 1/2" Offset</p>	<p>900-1301 Front Hanger Twin Wheels, 1/4" Offset</p>	<p>900-1300 Rear Hanger Twin Wheels, 1/2" Offset</p>

CLOSET DOOR HARDWARE

E-Z ROLL UNIVERSAL HANGERS FOR SLIDING DOOR TRACK SETS

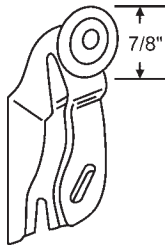

900-1318
Front Hanger w/Nylon
Wheel, 3/16" Offset

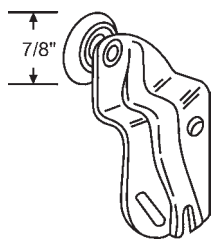

900-1317
Rear Hanger w/Nylon
Wheel, 1/2" Offset

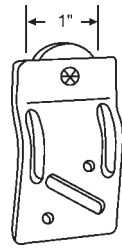

900-1312
Front Hanger
3/16" Offset

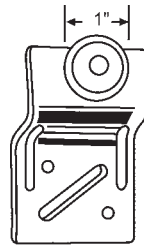

900-1313
Rear Hanger
1/2" Offset

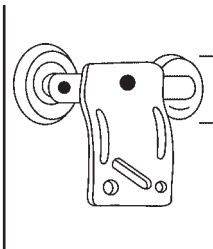

900-1298
Front Hanger Twin Wheel
3/16" Offset

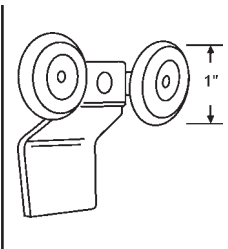

900-1299
Rear Hanger Twin Wheel
1/2" Offset

E-Z ROLL REPLACEMENT HARDWARE FOR FOLDING BI-FOLD DOORS

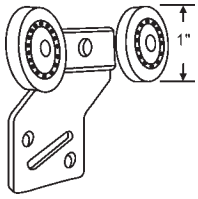

900-1302
H.D. Front Hanger Twin
Wheel w/Ball Bearing
Wheel, 3/16" Offset

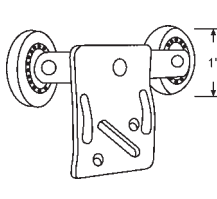

900-1303
H.D. Rear Hanger Twin
Wheel w/Ball Bearing
Wheel, 1/2" Offset

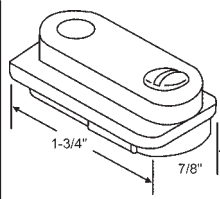

7-251
Top Bracket

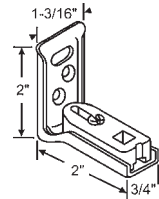

7-250
Bottom Bracket

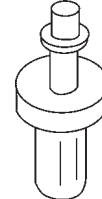

900-1325
Top Pivot Spring Loaded

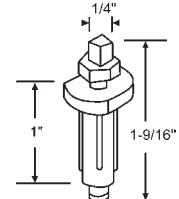

2-114
Bottom Pivot

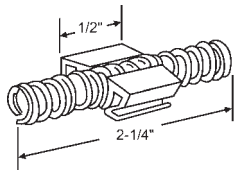

8-491
Snugger for 4 Doors

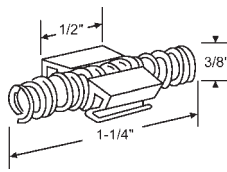

8-213
Snugger for 2 Doors

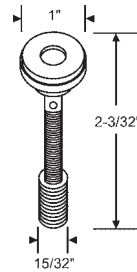

2-112
Top Rolling Guide (For replacing
older hardware) 8-281 Bushing
Only. 2-111 Pin Only

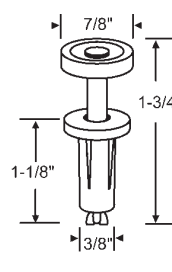

2-104
Top Rolling Guide Spring Loaded
ACME

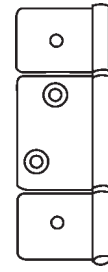

8-356
3 Wing Non Mortise Hinges

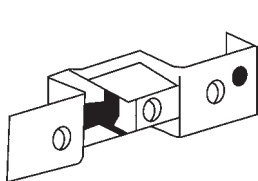

900-16386
Top Bracket

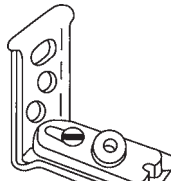

900-16387
Bottom Bracket

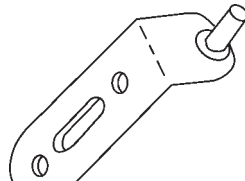

900-16388
Top Pivot

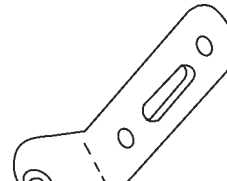

900-16389
Bottom Pivot

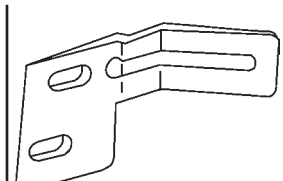

8-490
Door Aligner for 4 Doors

E-Z ROLL UNIVERSAL FLOOR GUIDES

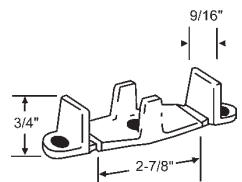

8-240
3 Piece. Floor Guide, Adjustable
to Fit 3/4" or 1-3/8" Thick Doors

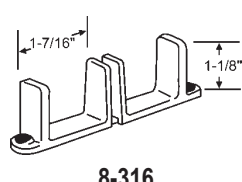

8-316
2 Piece. Floor Guide, Adjustable
to Fit 1-3/8" Thick Doors, 1-1/4"
High from Floor.

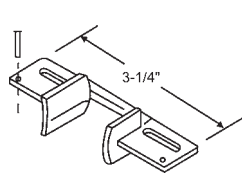

8-313
1 Piece. Nylon Guide for
Single Pocket Door

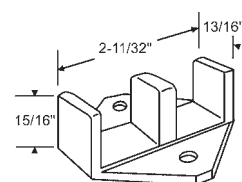

8-314
1 Piece. Floor Guide to Fit 3/4"
Doors

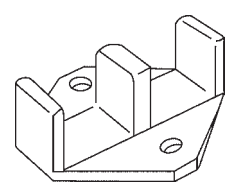

8-288
1 Piece. Floor Guide to Fit
1-1/8" Doors

CLOSET DOOR HARDWARE

E-Z ROLL UNIVERSAL FLOOR GUIDES

E-Z ROLL UNIVERSAL DOOR FINGER PULLS

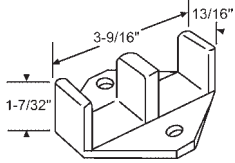

8-291

1 Piece. Floor Guide to Fit 1-3/8" Double Doors 1-1/4" High from Floor

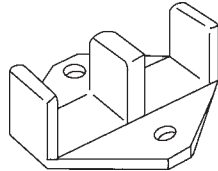

8-421

1 Piece. Floor Guide to Fit 1-3/4" Doors

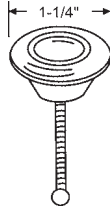

8-489

1-1/4" Nylon Plastic Pull Knob

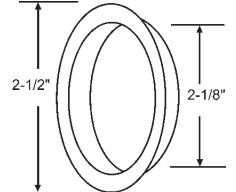
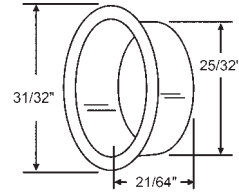

8-202

Brass Plated

Part #	Hand
900-616	Brass Plated
900-616SN	Satin Nickel

PANIFLEX CLOSET DOOR HARDWARE

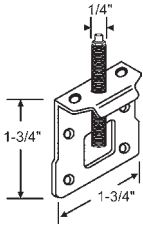

2-69

Bottom Pivot

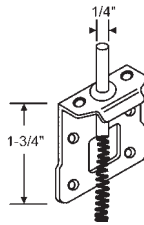

2-68

Top Pivot

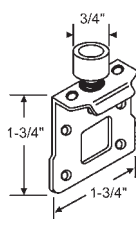

2-67

Roller Bracket

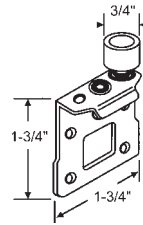

Part #	Hand
2-66	Shown
2-65	Opposite

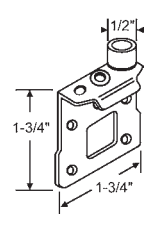

Part #	Hand
2-71	Shown
2-70	Opposite



5-54

Top Pivot Spring

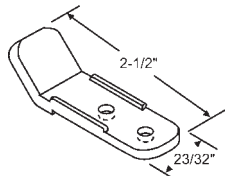

900-847

Door Aligner

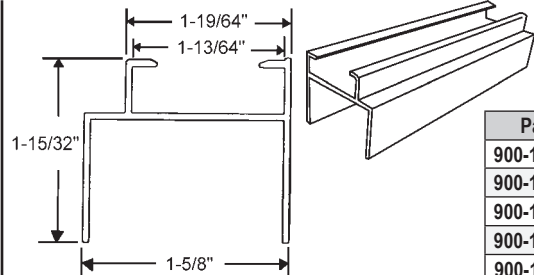

Part #	Size
900-16703-A	4 ft.
900-16703-B	6 ft.
900-16703-C	8 ft.
900-16703-D	10 ft.
900-16703-E	12 ft.

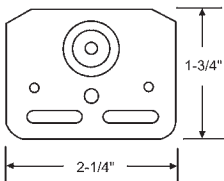

7-201

Metal Floor Plate

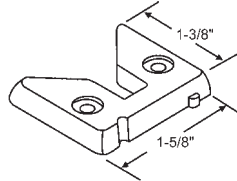

900-849

Nylon Floor Plate (Single)

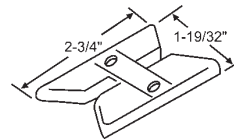

900-848

Nylon Floor Plate (Double)

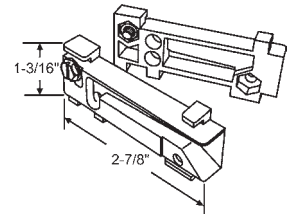

7-235A

Sold as Set (1 LH, 1 RH). Nylon

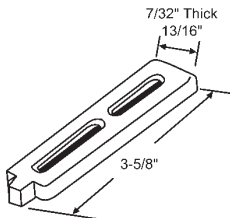

8-295

Guide System

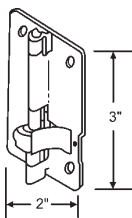

8-230

Cam Hinge

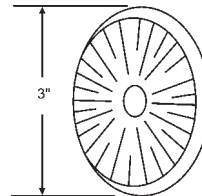

8-332

Brass Back Plate

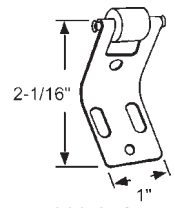

900-851

Pivot Aligner. 31/64" Dia. x 1/2" Width
Nylon Roller

CLOSET DOOR HARDWARE

FLOATAWAY CLOSET DOOR HARDWARE

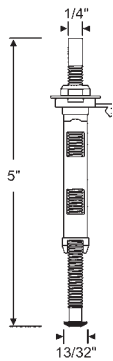

Assembly # 1-103	
Square Nut	6-157
Speed Nut	6-161
Pin Sleeve	900-6656

Pin Assembly with Plastic Sleeve

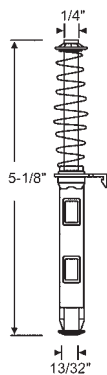

Assembly # 1-104	
Spring	5-59
Push Nut	6-122

Pin Assembly with Plastic Sleeve

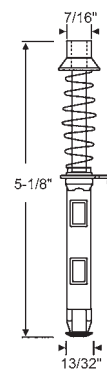

Assembly # 1-105	
Cap	4-106
Spring	5-59

Pin Assembly with Plastic Sleeve

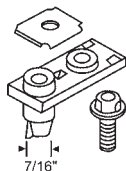

7-223
Nylon

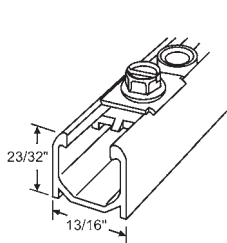

Part #	Size
8-350-3	3 ft.
8-350-4	4 ft.
8-350-6	6 ft.
8-350-8	8 ft.

Pivot Bracket Not Included

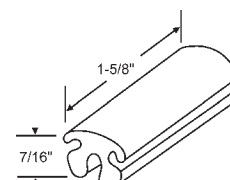

8-304
White

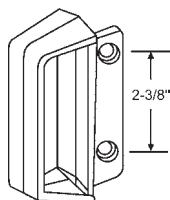

8-305
White

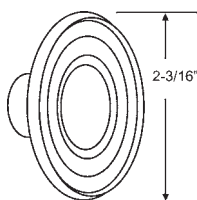

8-349
Plastic Door Knob
White

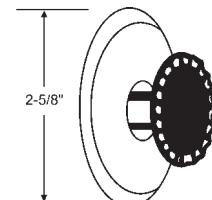

Part #	Finish
8-228B	Bronze
8-228A	Polished Aluminum

SLIMFOLD CLOSET DOOR HARDWARE

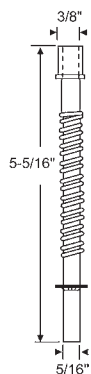

Assembly # 1-184	
Cap	4-103
Spring	5-50
Push Nut	6-111

Bi-fold Pin Assembly

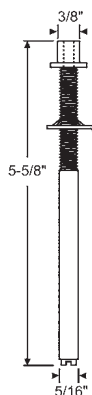

Assembly # 1-174	
Cap	4-117
Threaded Tinnerman	6-145

Bi-fold Bottom Pivot Rod Assembly

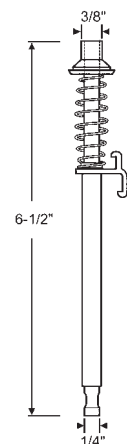

Assembly # 1-102	
Cap	4-120

Bi-fold Spring Loaded Guide Rod Assembly

CLOSET DOOR HARDWARE

SLIMFOLD CLOSET DOOR HARDWARE

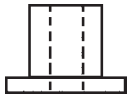

4-117
Fits Pins 1-174, 1-197,
1-232, 1-261

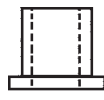

4-103
Fits Pins 1-183, 1-184

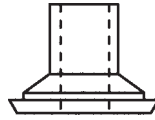

4-120
Fits Pin 1-102

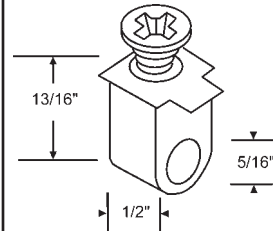

7-231
Nylon
New Style

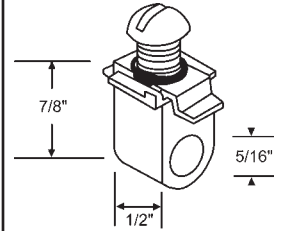

7-231OS
Nylon
Old Style

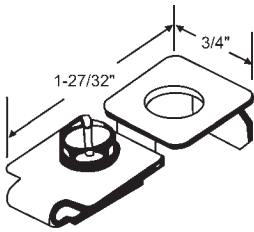

7-200
Pivot Bracket
Metal

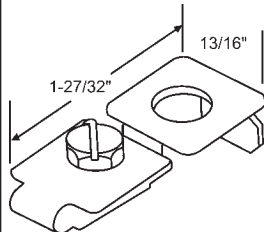

7-272
Bi-fold Track Socket with Screw
Metal

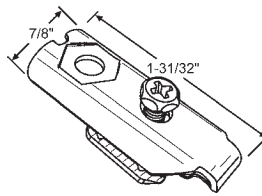

7-273
Pivot Bracket

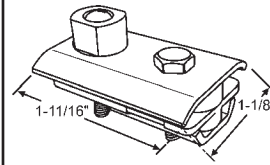

7-256
Top Pivot Retainer. Includes One
#10-32 x 3/4" Hex Screw.

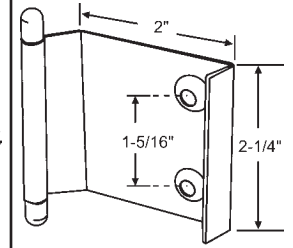

8-278
Door Pull Set. Chrome

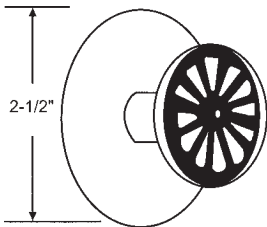

8-258
Brass
8-327 Knob, 8-321 Back Plate

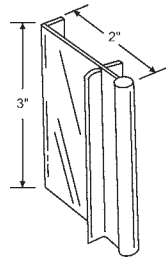

Part #	Finish
8-414	Bright Gold
8-414W	Bright White

Self-Adhesive

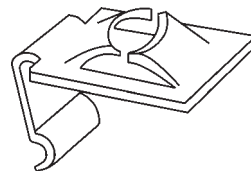

6-145
Retainer Clip
5/16" - 18 Threaded
Used with 1-138A, 1-155, 1-174,

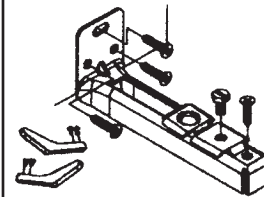

7-277
Bottomless Track Bracket

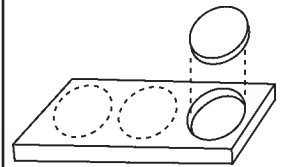

900-7429
Bi-fold Plastic Silencer
Clear - 3 Per Pad

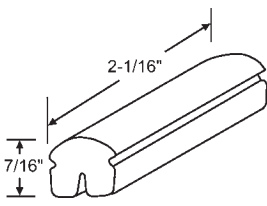

8-279
Gray Bi-fold Track Bumper

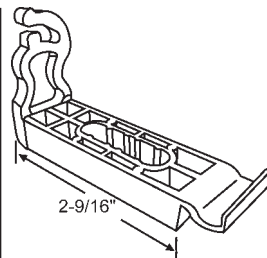

8-409
Bypass Top Guide

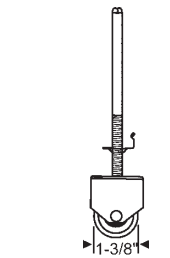

900-12272N
New Style

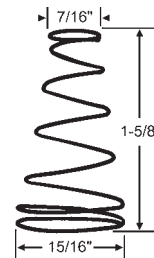

5-62
Spring

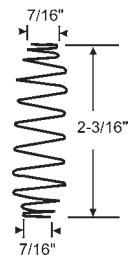

5-69
Spring



900-7431
#10 - 3/4" Pan Head Bottom
Track Screws



900-7430
#10 - 1-3/4" Pan Head Top
Track Screws

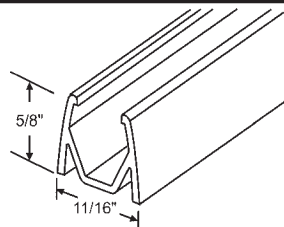

Part #	Size
900-8395	59-1/2"
900-8395-2	23-1/2"
900-8395-3	35-1/2"
900-8395-6	71-1/2"

Two-Panel Aluminum Track
Mill

SHOWER DOOR HARDWARE

SHOWER DOOR ROLLERS

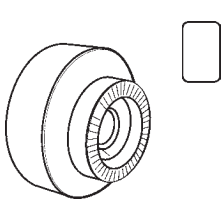

Part #	Dia.	Wide	Hub
900-18675	5/8"	1/4"	13/32"

Steel Hub, Hex End, Flat Plastic Wheel

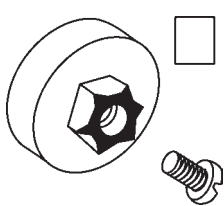

Part #	Dia.	Wide	Hub
21-50-2	3/4"	1/4"	3/8"

Nylon
Pack of two with screws

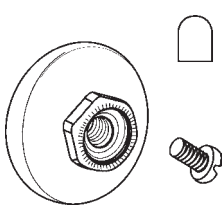

Part #	Dia.	Wide	Hub
21-51-2	3/4"	1/4"	3/8"

Nylon
Pack of two with screws

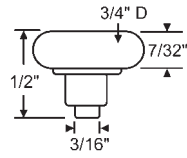

1081P

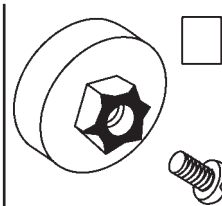

Part #	Dia.	Wide	Hub
21-66-2	7/8"	1/4"	3/8"

Nylon
Pack of two with screws

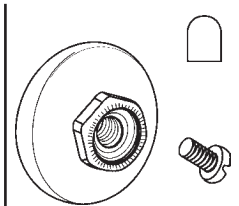

Part #	Dia.	Wide	Hub
21-52-2	7/8"	5/16"	3/8"

Nylon
Pack of two with screws

ROLLER ASSEMBLIES

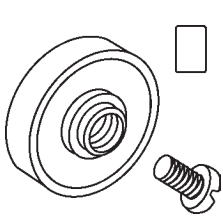

Part #	Dia.	Wide	Hub
21-53	1-1/16"	7/32"	9/32"

Nylon
21-53S for Screw Only.

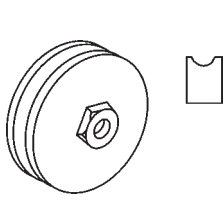

Part #	Dia.	Wide	Hub
21-69BR	1"	1/4"	3/8"

Celcon
8-32 Thread

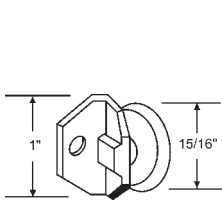

21-63
Nylon
TUBMASTER

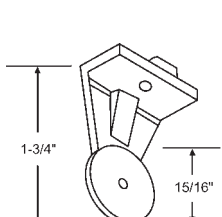

21-64
Shower Door Roller with Bracket Nylon
TUBMASTER

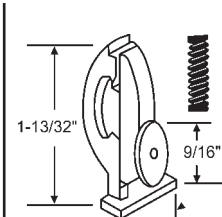

21-60
Shower Roller. 1 Wheel Nylon

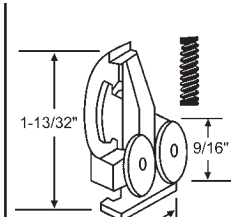

21-59
Shower Door Roller Nylon

ADJUSTING ROLLER ASSEMBLIES

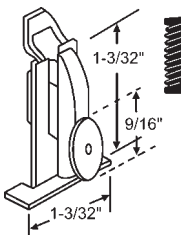

21-62
Shower Door Roller Nylon w/Aluminum Bracket

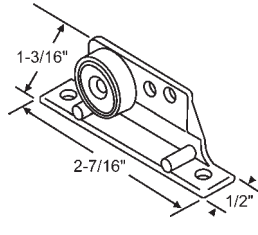

Part #	Roller	Handed
21-57	21-50	Shown

No Longer Available
Use: 21-57NS and 21-58NS

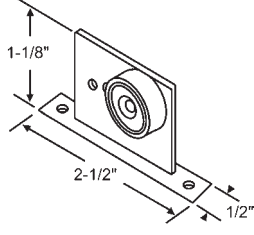

Part #	Roller
21-57NS	21-50
21-58NS	21-51

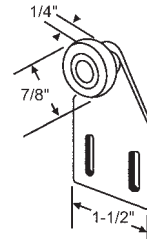

21-54
Door Roller with Bracket

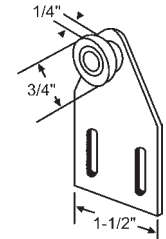

21-56
Door Roller with Bracket Roller Only 21-50

LATCH

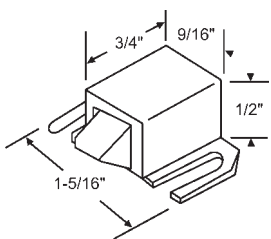

22-54
Stainless Steel Housing

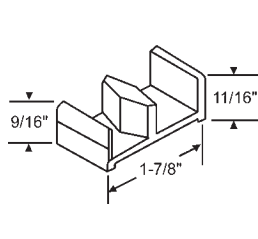

22-50
Nylon

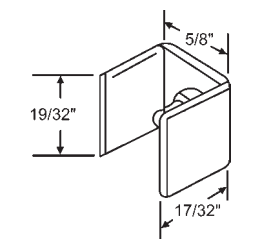

22-51
Nylon

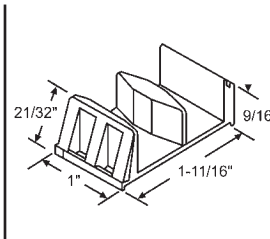

900-6426
Open Track Guide

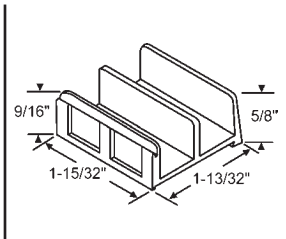

900-17327

SHOWER DOOR GUIDES

SHOWER DOOR GUIDES

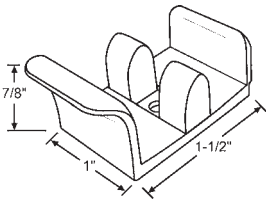
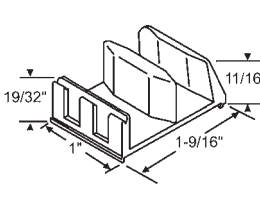
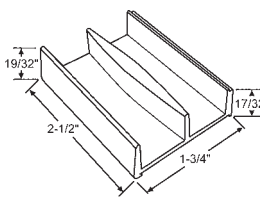
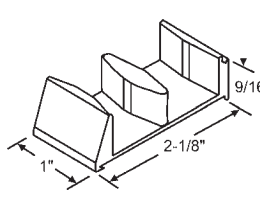
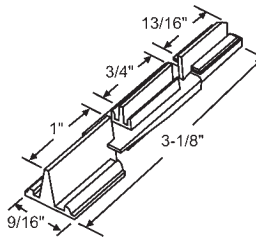
 <p>22-113 White Nylon KELLER</p>	 <p>900-17497</p>	 <p>22-141 White Nylon PETERSON</p>	 <p>900-10563</p>	 <p>22-203 Bottom Guide Nylon</p>
--	---	--	--	---

BUMPERS

SHOWER DOOR HANDLES

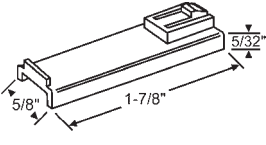
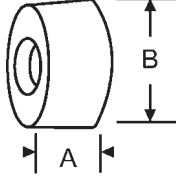
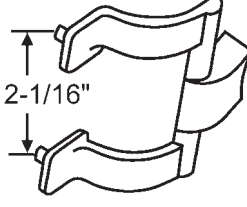
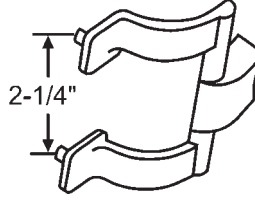
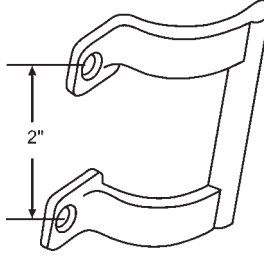
 <p>900-6779 White. Nylon</p>	 <table border="1" data-bbox="432 895 687 1011"> <thead> <tr> <th>Part #</th> <th>A</th> <th>B</th> <th>Finish</th> </tr> </thead> <tbody> <tr> <td>16-105</td> <td>3/8"</td> <td>15/16"</td> <td>Gray</td> </tr> <tr> <td>16-107</td> <td>7/32"</td> <td>3/4"</td> <td>White</td> </tr> <tr> <td>22-65</td> <td>1/4"</td> <td>3/4"</td> <td>Clear</td> </tr> </tbody> </table>	Part #	A	B	Finish	16-105	3/8"	15/16"	Gray	16-107	7/32"	3/4"	White	22-65	1/4"	3/4"	Clear	 <p>22-83 Chrome Handle with Towel Bar Insert</p>	 <p>900-10709 Chrome</p>	 <p>22-67 Chrome No Longer Available. Use: 22-67PA</p>
Part #	A	B	Finish																	
16-105	3/8"	15/16"	Gray																	
16-107	7/32"	3/4"	White																	
22-65	1/4"	3/4"	Clear																	

SHOWER DOOR ACCESSORIES

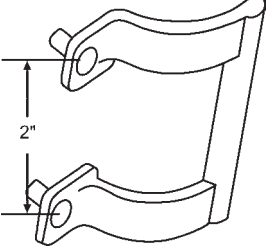
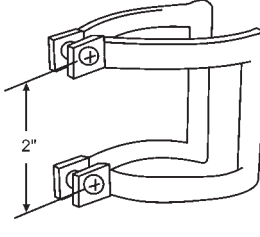
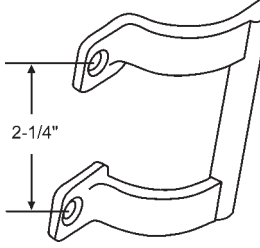
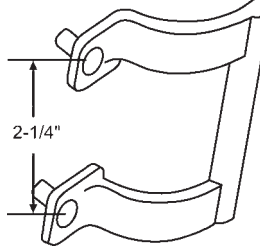
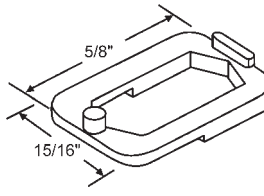
 <p>22-67P Chrome</p>	 <p>22-67PA Shower Door Handle Set Chrome Plated with Screws. Complete Bracket Assembly</p>	 <p>900-9079 Chrome</p>	 <p>900-10496 Chrome</p>	 <p>900-6060 Adjusting Bracket</p>
---	---	---	---	--

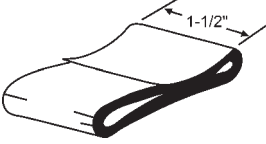
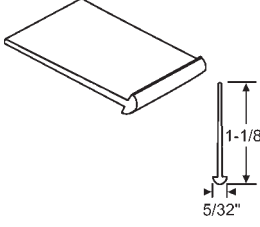
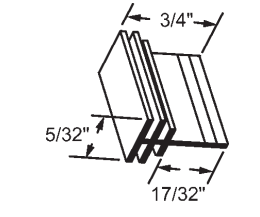
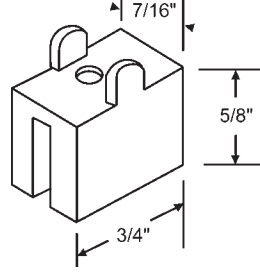
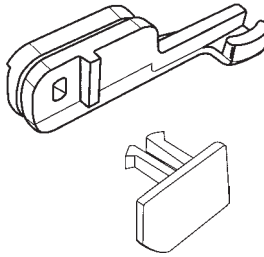
 <p>22-52 Shower Door Seal Gray. 36" Long</p>	 <p>22-103 1-1/8" Shower Door Sweep Sold by the Foot in 6' Lengths.</p>	 <p>900-15993 36" Shower Door Sweep Used on Hinged Shower Doors Gray Vinyl</p>	 <p>22-60 Hinge Guide</p>	 <p>22-71A Slide Guide with Pin</p>
---	---	--	--	---

SHOWER DOOR HINGES

Standard Duty & Solid Brass

Square Edge

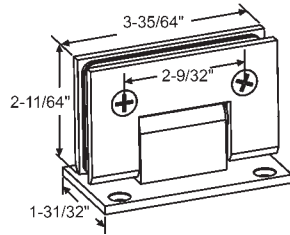

Solid brass shower hinge with stainless steel fasteners and backing plate. Standard full back plate, clear PVC gasket. Includes Philips screws, allen screws and allen key.
Wall to glass 90°
Suitable for glass 8 - 12 mm

Part #	Finish
22-244BCH	Bright Chrome
22-244BNK	Brushed Nickel

Square Edge

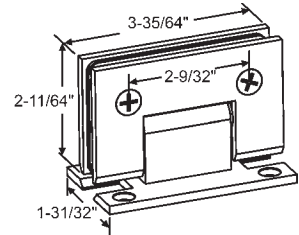

Solid brass shower hinge with stainless steel fasteners and backing plate. H back plate, clear PVC gasket. Includes Philips screws, allen screws and allen key.
Wall to glass 90°
Suitable for glass 8 - 12 mm

Part #	Finish
22-244BCH-H	Bright Chrome
22-244BNK-H	Brushed Nickel

Square Edge

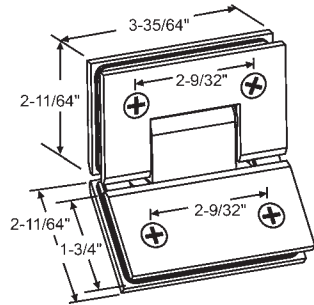

Solid stainless steel shower hinge, stainless steel, clear PVC gasket. Includes Philips screws, allen screws and allen key.
Glass to glass 135°
Suitable for glass 8 - 12 mm

Part #	Finish
22-249BCH	Bright Chrome
22-249BNK	Brushed Nickel

Square Edge

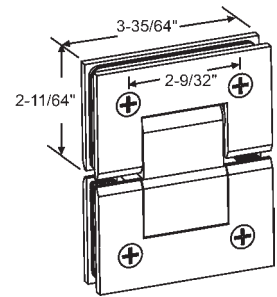

Solid Brass Shower hinge, stainless steel, clear PVC gasket. Includes Philips screws, allen screws and allen key.
Glass to glass 180°
Suitable for glass 8 - 12 mm

Part #	Finish
22-245BCH	Bright Chrome
22-245BNK	Brushed Nickel

Beveled Edge

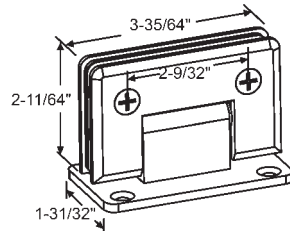

Standard duty brass shower hinge, with stainless steel fasteners and back plate. Full back plate, clear PVC gasket. Includes Philips screws, allen screws and allen key.
Wall to glass 90°
Suitable for glass 8 - 12 mm

Part #	Finish
22-272BCH	Bright Chrome
22-272BNK	Brushed Nickel

Beveled Edge

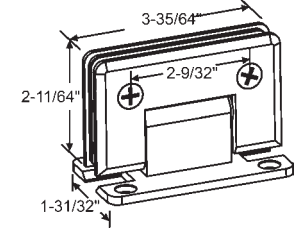

Standard duty brass shower hinge, with stainless steel fasteners and back plate. H back plate, clear PVC gasket. Includes Philips screws, allen screws and allen key.
Wall to glass 90°
Suitable for glass 8 - 12 mm

Part #	Finish
22-273BCH	Bright Chrome
22-273BNK	Brushed Nickel

Beveled Edge

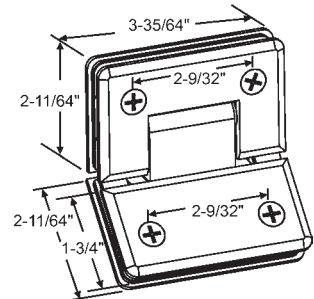

Standard duty brass shower hinge, stainless steel, clear PVC gasket. Includes Philips screws, allen screws and allen key.
Glass to glass 135°
Suitable for glass 8 - 12 mm

Part #	Finish
22-260BCH	Bright Chrome
22-260BNK	Brushed Nickel

Beveled Edge

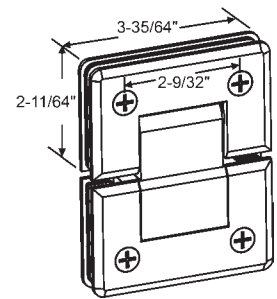

Standard duty brass shower hinge, stainless steel, clear PVC gasket. Includes Philips screws, allen screws and allen key.
Glass to glass 180°
Suitable for glass 8 - 12 mm

Part #	Finish
22-261BCH	Bright Chrome
22-261BNK	Brushed Nickel

SHOWER DOOR HINGES

Heavy Duty & Solid Brass

Beveled Edge

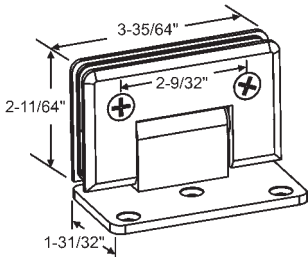

Standard duty brass shower hinge, offset back plate, clear PVC gasket. Includes Philips screws, allen screws and allen key. Wall to Glass 90° Suitable for glass 8 - 12 mm

Part #	Finish
22-259BCH	Bright Chrome
22-259BNK	Brushed Nickel

Square Edge

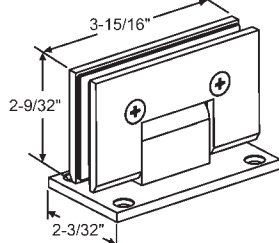

Solid brass shower hinge with stainless steel fasteners and back plate. Heavy duty, standard full back plate, clear PVC gasket. Includes Philips screws, allen screws and allen key. Wall to glass 90° Suitable for glass 10 - 12 mm

Part #	Finish
22-246BCH	Bright Chrome
22-246BNK	Brushed Nickel

Square Edge

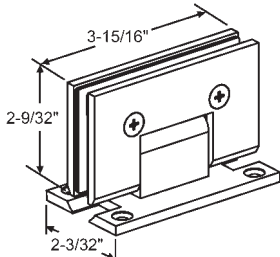

Solid brass shower hinge with stainless steel fasteners and back plate. Heavy duty, H back plate, clear PVC gasket. Includes Philips screws, allen screws and allen key. Wall to glass 90° Suitable for glass 10 - 12 mm

Part #	Finish
22-246BCH-H	Bright Chrome
22-246BNK-H	Brushed Nickel

Square Edge

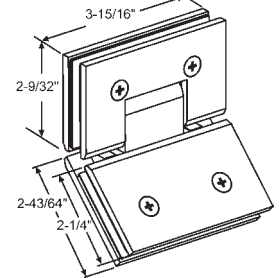

Heavy duty brass shower hinge, clear PVC gasket. Includes Philips screws, allen screws and allen key. 135° Glass to Glass Suitable for 10 - 12 mm glass

Part #	Finish
22-247BCH	Bright Chrome
22-247BNK	Brushed Nickel

Square Edge

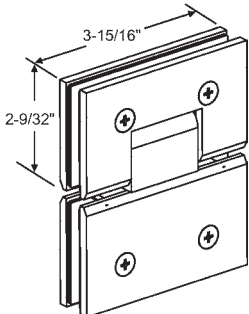

Heavy duty brass shower hinge, clear PVC gasket. Includes Philips screws, allen screws and allen key. 180° Glass to Glass Suitable for 10 - 12 mm glass

Part #	Finish
22-248BCH	Bright Chrome
22-248BNK	Brushed Nickel

Beveled Edge

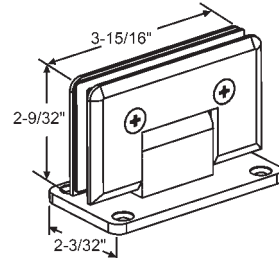

Solid brass shower hinge, heavy duty, full back plate, clear PVC gasket. Includes Philips screws, allen screws and allen key. Wall to glass 90° Suitable for glass 10 - 12 mm

Part #	Finish
22-269BCH	Bright Chrome
22-269BNK	Brushed Nickel

Beveled Edge

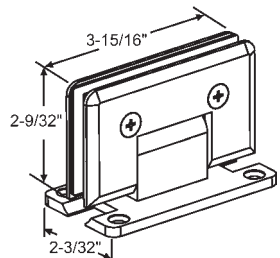

Solid brass shower hinge, heavy duty, H back plate, clear PVC gasket. Includes Philips screws, allen screws and allen key. Wall to glass 90° Suitable for glass 10 - 12 mm

Part #	Finish
22-271BCH	Bright Chrome
22-271BNK	Brushed Nickel

Beveled Edge

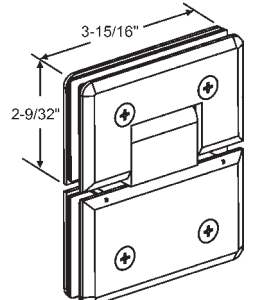

Solid brass shower hinge, heavy duty, clear PVC gasket. Includes Philips screws, allen screws and allen key. 180° Glass to Glass Suitable for 10 - 12 mm glass

Part #	Finish
22-270BCH	Bright Chrome
22-270BNK	Brushed Nickel

SHOWER DOOR HARDWARE

SHOWER DOOR GLASS CLAMPS

Rounded Edge

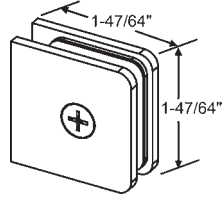

Part #	Finish
22-262BCH	Bright Chrome
22-262BNK	Brushed Nickel

Brass shower glass clamp, clear PVC gasket
Includes Philips screws, allen screws and allen key.
Wall to glass, hole-in-glass style
Suitable for glass 8 - 12 mm

Square Edge

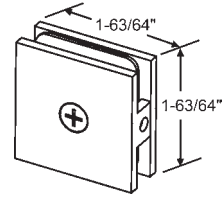

Part #	Finish
22-257BCH	Bright Chrome
22-257BNK	Brushed Nickel

Solid brass shower glass clamp, clear PVC gasket
Includes Philips screws, allen screws and allen key.
Wall to glass, hole-in glass style
Suitable for glass 8 - 12 mm

Square Edge

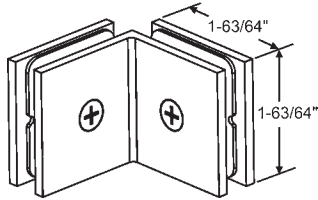

Part #	Finish
22-258BCH	Bright Chrome
22-258BNK	Brushed Nickel

Solid brass shower glass clamp, clear PVC gasket
Includes Philips screws, allen screws and allen key. Glass to glass 90°
Suitable for glass 8 - 12 mm

Square Edge

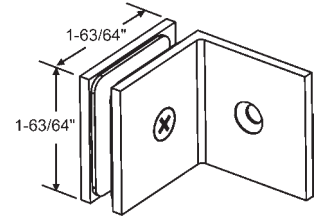

Part #	Finish
22-263BCH	Bright Chrome
22-263BNK	Brushed Nickel

Brass shower glass clamp, clear PVC gasket
Includes Philips screws, allen screws and allen key.
Wall to glass 90°, with large leg
Suitable for glass 8 - 12 mm

Square Edge

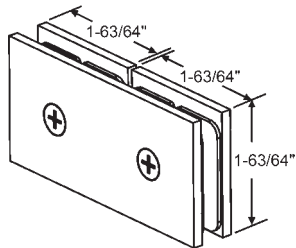

Part #	Finish
22-264BCH	Bright Chrome
22-264BNK	Brushed Nickel

Brass shower glass clamp, clear PVC gasket
Includes Philips screws, allen screws and allen key.
Glass to glass 180°
Suitable for glass 8 - 12 mm

Beveled Edge

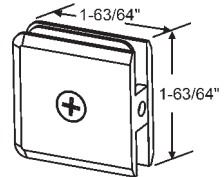
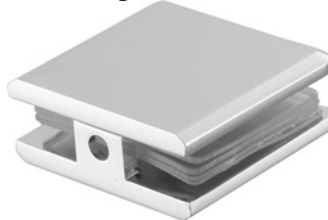

Part #	Finish
22-256BCH	Bright Chrome
22-256BNK	Brushed Nickel

Solid brass shower glass clamp, clear PVC gasket
Includes Philips screws, allen screws and allen key.
Wall to glass, hole-in glass style
Suitable for glass 8 - 12 mm

SHOWER DOOR GLASS SLEEVE OVER GLASS CLAMPS

LH Shown



RH Shown

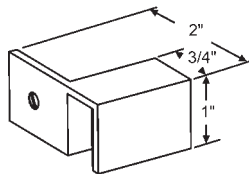

Part #	Finish	Hand
22-265LBCH	Bright Chrome	LH
22-265RBCH	Bright Chrome	RH
22-265LBNK	Brushed Nickel	LH
22-265RBNK	Brushed Nickel	RH

Sold brass shower sleeve over wall mount glass clamp
Suitable for glass 8 - 12 mm

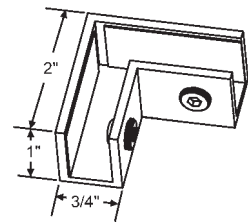

Part #	Finish
22-267BCH	Bright Chrome
22-267BNK	Brushed Nickel

Solid brass shower sleeve over glass clamp
Glass to glass 90 degree
Suitable for glass 8 - 12 mm

SHOWER DOOR HARDWARE

SHOWER DOOR GLASS SEALING STRIPS

Sold by Length - 96" Length, Minimum 12 Lengths

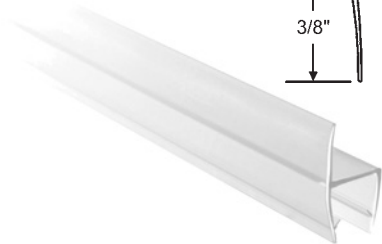
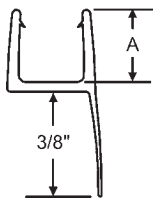

Part #	Glass Thickness	A
22-280	10 mm	3/8"
22-281	12 mm	1/2"

PVC seal strip, glass to glass,
Size: 96"

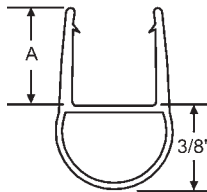

Part #	Glass Thickness	A
22-282	10 mm	3/8"
22-283	12 mm	1/2"

PVC seal strip, glass to glass,
Size: 96"

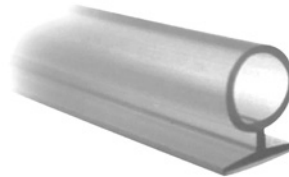
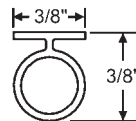

Part #	Glass Thickness
22-277	10 mm

PVC bulb seal strip
for 3/8" (10 mm) Glass. Size: 96"



Part #	Glass Thickness
22-278	10 mm

PVC bulb seal strip
for 3/8" (10 mm) Glass. Size: 96"

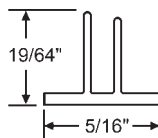

Part #	Glass Thickness
22-279	8 mm

PVC double fin seal
for 5/16" (8 mm) glass. Size: 96"

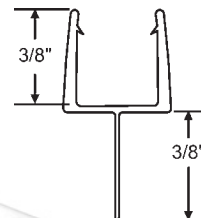

Part #	Glass Thickness
22-276	10 mm

PVC bottom seal strip,
for 3/8" (10mm) glass. Size: 96"

SHOWER DOOR HANDLES AND PULL KNOBS

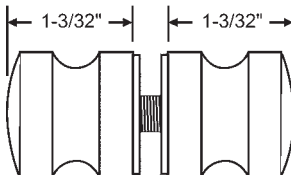

Part #	Finish
22-254BCH	Bright Chrome
22-254BNK	Brushed Nickel

Solid brass shower door pull set.

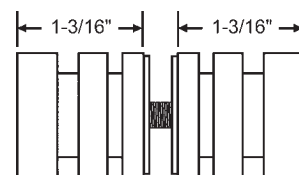

Part #	Finish
22-255BCH	Bright Chrome
22-255BNK	Brushed Nickel

Solid brass shower door pull set.

SHOWER DOOR HARDWARE

SHOWER DOOR HANDLES AND PULL KNOBS

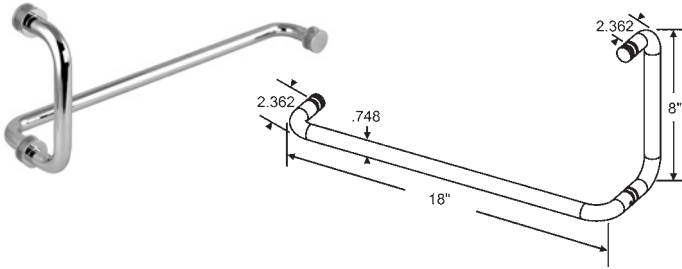

Part #	Finish
22-253BCH-8X18	Bright Chrome
22-253BNK-8X18	Brushed Nickel

Stainless steel shower door combo pull handles, without stainless steel washers
Size: 19 mm x 8" x 18"(203 x 457 mm)
with PVC washer

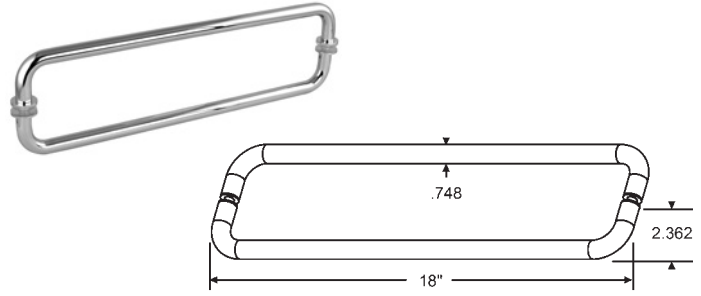

Part #	Finish
22-250BCH-18	Brushed Chrome
22-250BNK-18	Brushed Nickel

Stainless steel back to back fixing towel bar without metal washers
Size: Dia. 3/4" x 18"(C-C)
Back to Back fixing, sold in set.

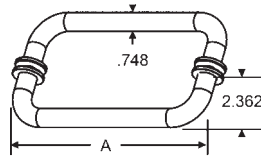

Part #	Finish	A
22-250BCH-6	Bright Chrome	6"
22-250BNK-6	Brushed Nickel	6"
22-250BCH-8	Bright Chrome	8"
22-250BNK-8	Brushed Nickel	8"

Stainless steel shower pull handles, with metal washers
Size: Dia. 3/4" x 6"(C-C)
Back to Back fixing, sold in set.

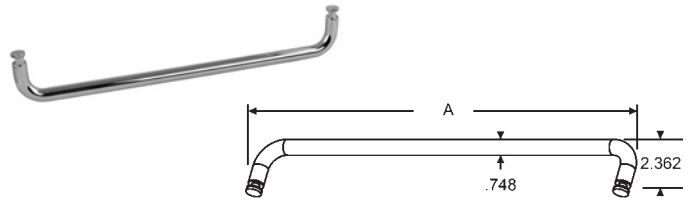

Part #	Finish	A
22-252BCH-18	Bright Chrome	18"
22-252BNK-18	Brushed Nickel	18"
22-252BCH-24	Bright Chrome	24"
22-252BNK-24	Brushed Nickel	24"

Stainless steel single side towel bar, without metal washers

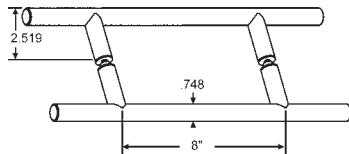
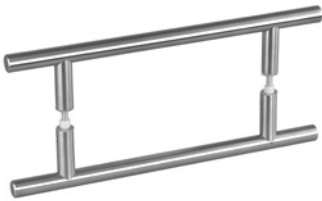

Part #	Finish
22-251BCH-8	Bright Chrome
22-251BNK-8	Brushed Nickel

Stainless steel shower pull handles
Size: Dia 3/4" x 8" (C-C) x 12" (total length)
Back to Back fixing, sold in set.

WASHER SET

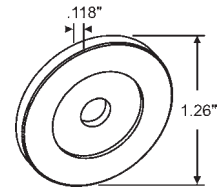
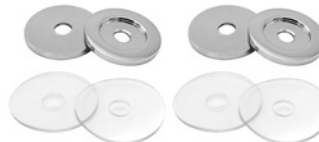

Part #	Finish
22-266BCH	Bright Chrome
22-266BNK	Brushed Nickel

Solid brass metal washer kit for 19 mm tube. 4 piece metal washer and 4 piece PVC washer

MILDEW RESISTANT SILICONE SEALANT



- 100% RTV Silicone
- Mildew Resistant
- General Purpose
- Permanently Elastic
- Watertight & Airtight
- Excellent Adhesion to Glass, Ceramic, Porcelain, Metals, Wood & Many More
- Easy to Apply & Easy Clean-up
- UV Resistant
- VOC Compliant
- Cartridge Colors: Clear, White
- Meets ASTM C-920, Type S, Grade NS, Class 25

Part #	Finish
59-172	White
59-173	Clear

Packed 12 Tubes per Case.

See our
**Professional Caulk
Guns on Page 389**

SWEEP\$AVER™ GLAZIER TOOL

Created out of a need from a glass company that specializes in high-end complex shower door installations. The SWEEP\$AVER™ is designed to take a forty-minute job and cut it down to mere seconds, saving you time and money. The tool is created to efficiently cut vinyl soft-leg water diverters and sweeps precisely to your desired height, thus creating the finishing touch to a custom shower door.

- (6) Different cutting adjustment positions in 1/16" increments
- Designed for both right and left hand users
- Lifetime Warranty
- Made in the USA



59-187

Dims: 12-5/8" x 7/16" x 1-15/16"
Weight: 3.5 oz. Material: ABS Polymer

GLIDING SHOWER DOOR SYSTEM

The Gliding Shower Door System uses top quality stainless steel ball bearing wheels that glide quietly and effortlessly across the sturdy rectangular header. It provides a stylish yet affordable option when installing a sliding shower door.

The minimalistic hardware and sleek design creates a frameless look that is much more aesthetically pleasing than traditional framed sliders.

The Gliding Shower Door System is designed to work with 5/16" to 3/8" thick tempered glass.



Product Features:

- Durable Stainless Steel Construction
- 4 Ball Bearing Wheels Provide Security and Smooth, Quiet Operation
- Minimalistic Styling
- Fixed and Gliding Panel are Reversible for Installation
- Available in Polished or Brushed Finish
- Accommodates Glass Thickness from 5/16" to 3/8"
- Maximum Door Size of 30"
- Maximum Door Weight of 88 lbs.
- Compatible with Glass Return Panel
- All Installation Hardware Included Except Clamps or Channel for Fixed Panel
- Comprehensive Instructions Including Glass Fabrication Cut-Out Available
- Design Assistance Available

Part #	Finish
22-268BCH	Bright Chrome
22-268BNK	Brushed Nickel

Kit Includes:

- Rollers x 2
- Stopper x 1
- L-Seal x 1
- Wall Mount x 2
- Header Tube x 1
- Door Pull x 1
- Adjustable Header Mount x 2
- Fixed Panel Mount x 2
- Door Guide x 1
- Installation Hardware x 1

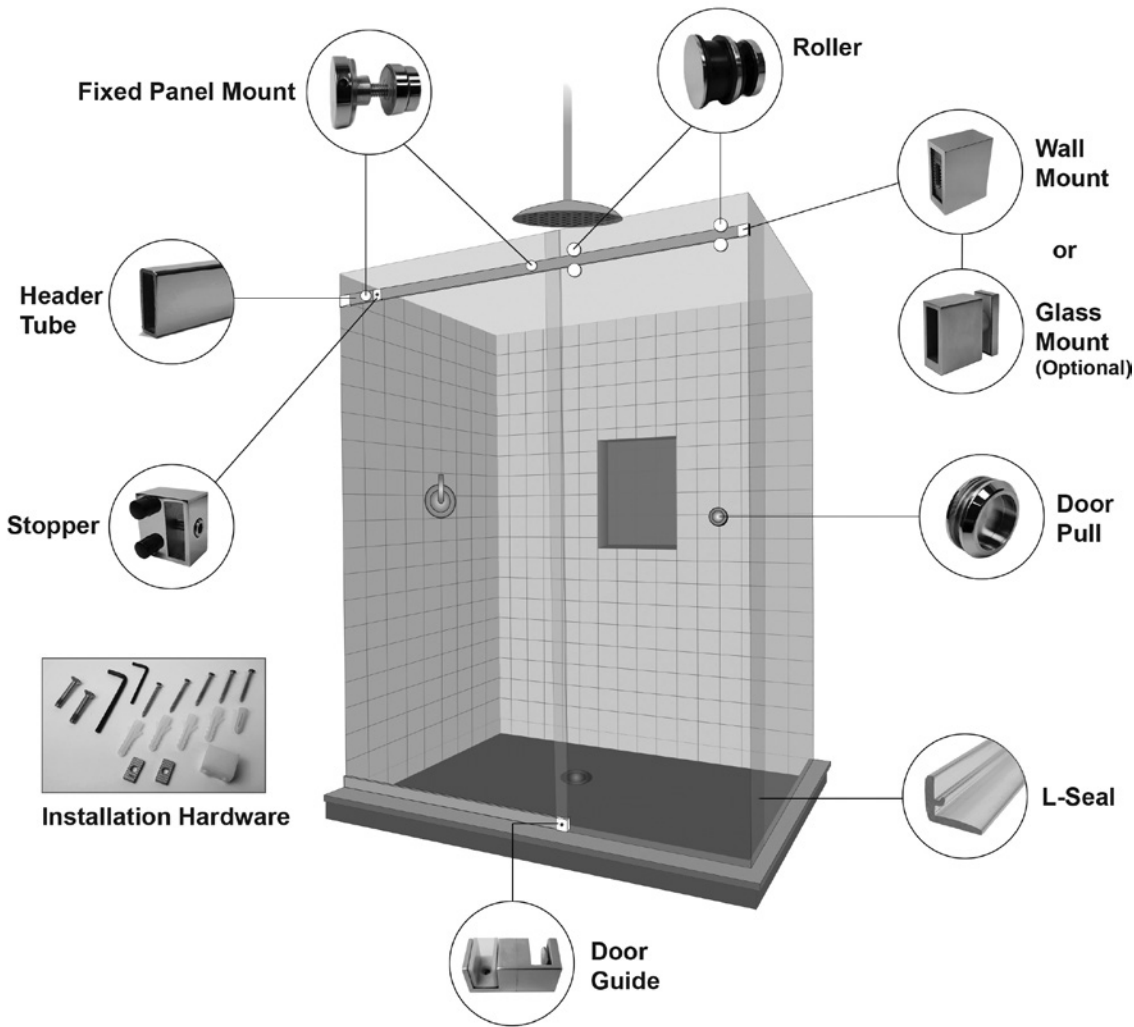

STORM DOOR HARDWARE

STORM DOOR KNOB/PUSH PULL LATCH SETS

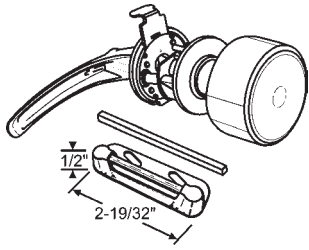

Tulip Knob Latch, Single Hole

Part #	Color
17-52	Aluminum

- Fits doors 1" - 1-1/4" thick
- Resilient strike
- Installs in single hole bore 1-1/4" diameter

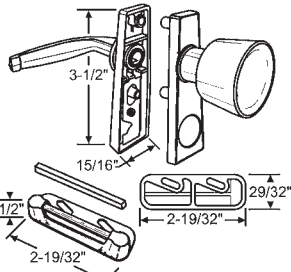

Tulip Knob Latch

Part #	Color
17-59	Black
17-60	Aluminum

- Resilient strike
- 1-3/4" installation hole spacing
- Fits doors 1" - 1-1/4" thick

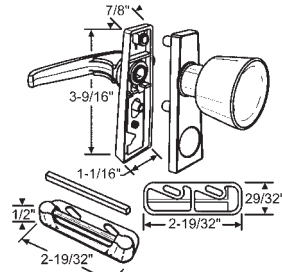

Tulip Knob Latch "No Lock Out" Feature

Part #	Color
17-61	Aluminum

- Solid strike
- 1-3/4" installation hole spacing
- "No Lock Out" feature prevents accidental lock out
- Fits doors 7/8" - 1-1/4" thick

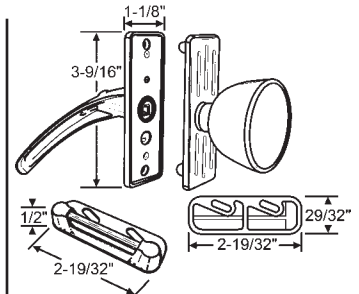

Tulip Knob Latch

Part #	Color
17-50	Aluminum
17-51	Black

- Resilient strike
- 3" installation hole spacing
- Fits doors 1" - 1-1/4" thick

STORM DOOR PUSH BUTTON LATCH SET

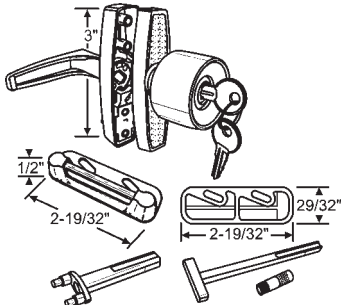

Tulip Key-In-Knob Lock (3")

Part #	Color
900-7320	Aluminum

- Resilient strike
- 3" installation hole spacing
- Key lock for extra security
- Fits doors 7/8" - 1-3/8" thick

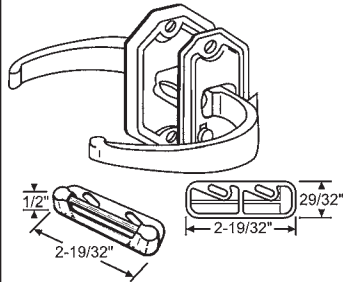

Push Pull Latch

Part #	Color
17-67	Aluminum

- Popular for wood door applications.
- Resilient strike
- Installs in 1" diameter single hole bore
- Fits Doors 1" - 1-1/4" Thick

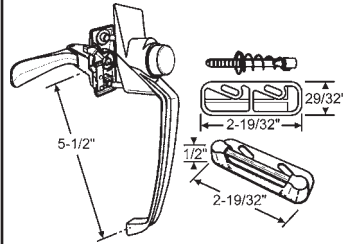

Part #	Color
17-65	Aluminum
17-66	Black

- Resilient strike
- 1-1/2" mounting hole spacing
- Fits doors 1" - 1-1/4" thick
- Tie down type
- No Key Lock

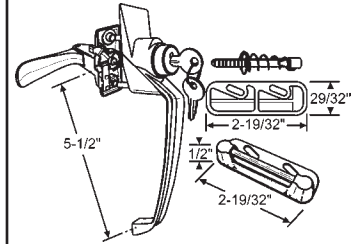

Part #	Color
17-66K	Black

- Resilient strike
- 1-1/2" mounting hole spacing
- Fits doors 1" - 1-1/4" thick
- Tie down type
- With Key Lock

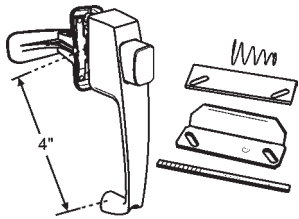

Part #	Color
17-58B	Black
17-58W	White

- Resilient strike
- 1-3/4" installation hole spacing
- Fits doors 1" - 1-1/4" thick
- Tie down type

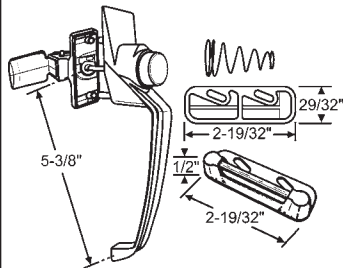

Part #	Color
17-82A	Aluminum
17-82	Black
17-82W	White

- Resilient strike
- 1-3/4" mounting hole spacing
- Fits doors 5/8" - 1-1/4" thick
- Tie down type
- No Key Lock

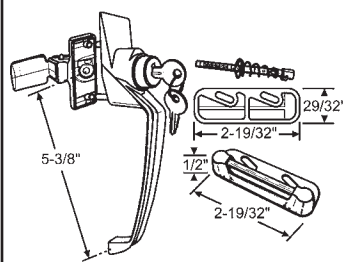

Part #	Color
17-82KB	Black

- Resilient strike
- 1-3/4" mounting hole spacing
- Fits doors 5/8" - 1-1/4" thick
- Tie down type
- With Key Lock

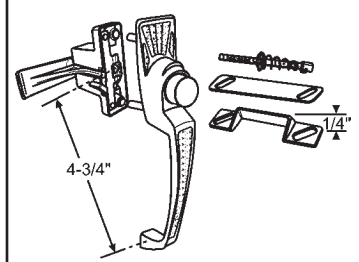

Part #	Color
17-73	Aluminum
17-72	Black

- Solid strike
- 1-3/4" installation hole spacing
- "No Lock Out" feature prevents accidental lock out
- Fits doors 5/8" - 1-1/4" thick

STORM DOOR PUSH BUTTON LATCH SET



Part #	Color
17-83KB	Black

- Heavy duty, solid strike with resilient inside handle
- Button pin handle
- 1-3/4" mounting hole spacing
- Fits doors 7/8" - 1-1/4" thick
- Push button unit furnished w/calibrated metal spindle & spring
- Anti-lockout feature



Part #	Color
17-83B	Black

- Heavy duty, solid strike with resilient inside handle
- Button pin handle
- 1-3/4" mounting hole spacing
- Fits doors 7/8" - 1-1/4" thick
- Push button unit furnished w/calibrated metal spindle & spring

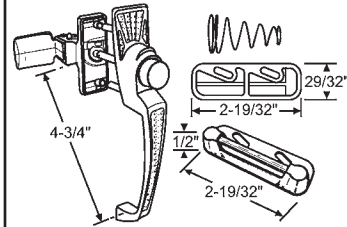

Part #	Color
17-53	Aluminum
17-54	Black

- Resilient strike
- 1-3/4" installation hole spacing
- Fits doors 1" - 1-1/4" thick

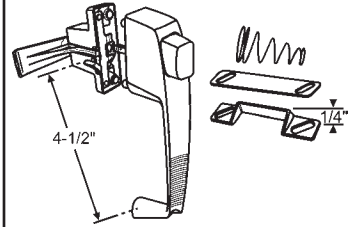

Part #	Color
900-7339	Aluminum
900-7339BL	Black
900-7339W	White

- Heavy Duty Push Button Latch
- Solid strike
 - 1-3/4" installation hole spacing
 - "No Lock Out" feature prevents accidental lock out
 - Fits doors 1" - 1-1/4" thick

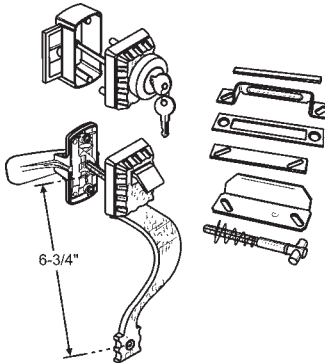

Push Button Set with Deadbolt

Part #	Color
900-13554K	Black

Deadbolt Only

Part #	Color
900-13554DB	Black

- Mounting hole center 1-3/4"
- Fits doors 1" - 1-1/4" Thick

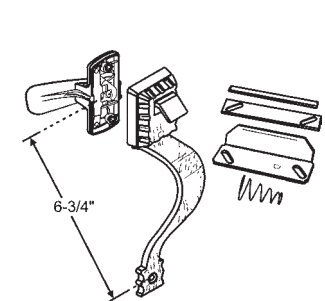

Push Button Set Only

Part #	Color
900-13554	Black

Part #	Color
900-13554BR	Brass with Black Internal Latch

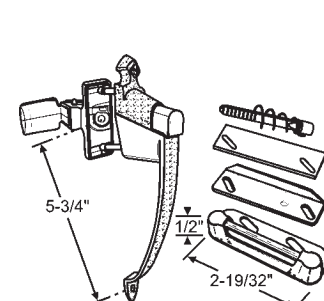

Part #	Color
17-181	Black

- Colonial Tie Down Push Button
- No Key Lock

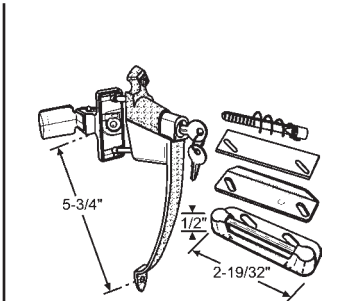

Part #	Color
17-181K	Black

- Colonial Tie Down Push Button
- With Key Lock

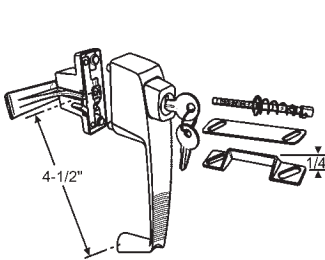

Part #	Color
900-7339KBL	Black

- Heavy Duty Push Button Latch
- Solid strike
 - 1-3/4" installation hole spacing
 - "No Lock Out" feature prevents accidental lock out
 - Furnished with 2 Brass Keys
 - Fits Doors 1" - 1-1/4" Thick

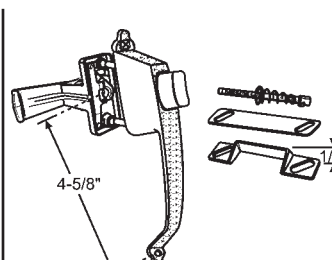

Part #	Color
900-14570	Black

- Colonial Heavy Duty Push Button Latch
- Solid strike
 - 1-3/4" installation hole spacing
 - "No Lock Out" feature prevents accidental lock out
 - Fits Doors 1" - 1-1/4" Thick

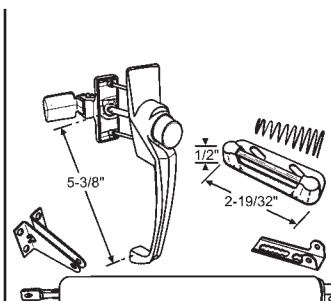

Part #	Color
19-709B	Black
19-709AL	Aluminum
19-709W	White

Storm Door Hardware Kit.
Does Not Include Chain

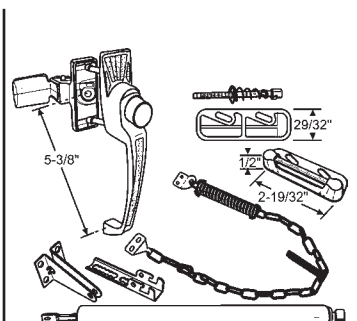

Part #	Color
19-199B	Black

Storm Door Hardware Kit with Chain
Steel Tube

STORM DOOR HARDWARE

STORM DOOR PUSH BUTTON LATCH SET

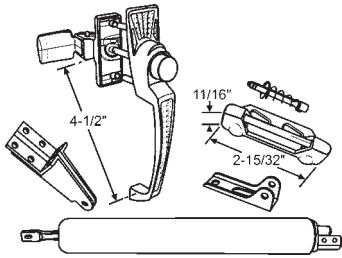

Part #	Color
19-376W	White
19-376BR	Bronze

Corrosion Resistant. Ideal for Coastal Applications. Includes Pneumatic Door Closer, Heavy Duty Plastic Jamb Bracket, Push-Button Latch with 1-3/4" Installation Hole Spacing, Screws, and Instructions

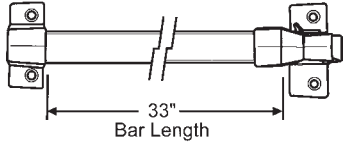

Part #	Color
17-301-3	White
17-301-10	Black

Touch Bar Latch. Fits up to 36"

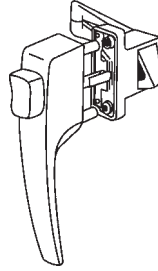

Part #	Color
17-70	Aluminum
17-70W	White
17-71	Black

- Solid strike
- 1-3/4" installation hole spacing
- "No Lock Out" feature prevents accidental lock out
- Fits doors 5/8" - 1-1/4" thick
- No Key Lock

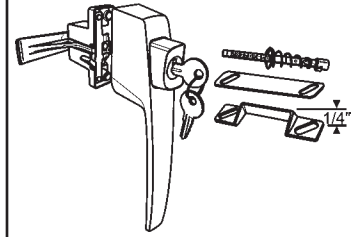

Part #	Color
17-70K	Aluminum
17-71K	Black

- Solid strike
- 1-3/4" installation hole spacing
- "No Lock Out" feature prevents accidental lock out
- Fits doors 5/8" - 1-1/4" thick
- With Key Lock

VP PULL HANDLE SET

LOCKING HANDLE SET

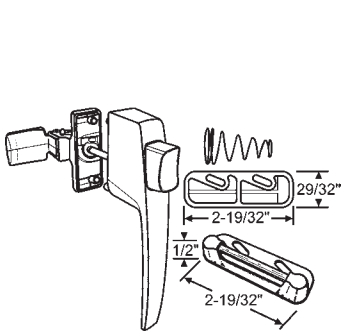

Part #	Color
17-56	Black
17-55	Aluminum

- Resilient strike
- 1-3/4" installation hole spacing
- Fits doors 1" - 1-1/4" thick

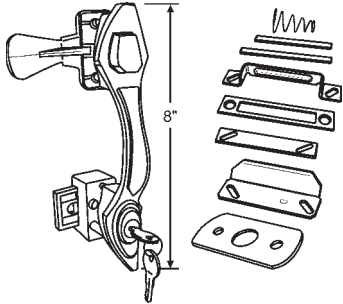

Part #	Color
17-127	Brass Finish
17-127AB	Antique Brass
17-127B	Black

Quincy Push Button Latch Set

- Elegant Styled Handle with Interior Deadbolt
- "No Lock Out" Feature
- 1-3/4" Hole Spacing
- Installs in six 5/16" Diameter Holes
- Handle: 8"
- Reversible

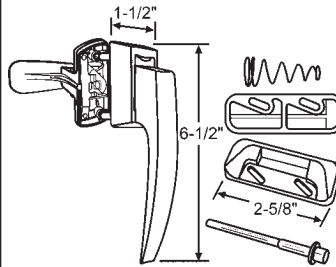

Part #	Color
17-191-1	Black
17-191-3	White

1-3/4" Hole Spacing. Operates with a single natural smooth action.

IDEAL

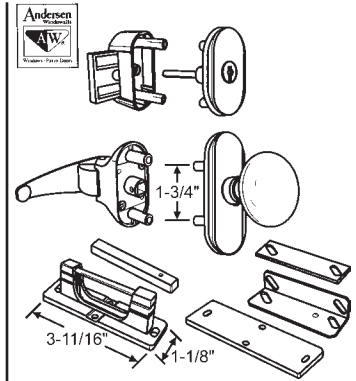

Part Number	Exterior Finish	Interior Finish
900-22536	Black	White
900-22536PB	Polished Brass	White
900-22536PB/AD	Polished Brass	Almond

LEVER LATCH SETS

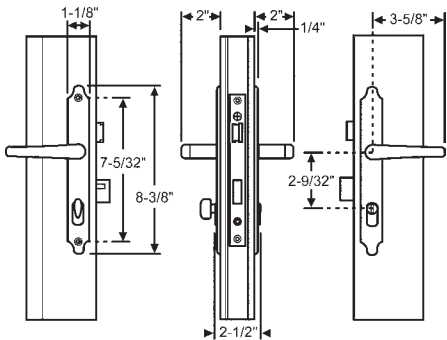

Part #	Finish
19-466	Polished Brass
19-466B	Black
19-466SNK	Satin Nickel
19-466W	White

Complete Handle Set with Mortise Lock, Single Deadbolt & Strike
LARSON

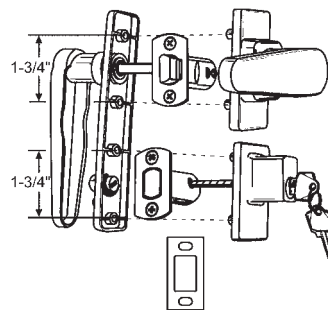

Part #	Interior	Exterior
17-128SCH	Satin Chrome	Satin Chrome

Storm Door Lever Set w/ Key & Deadbolt
1-3/4" Hole Centers

TEMO

LEVER LATCH SETS

Beautifully Designed, Classically Styled Lever Handle with an Elegantly Sculptured Escutcheon



Lever Latch Set with Keyed Deadbolt

Part #	Color
17-25BK	Black
17-25WK	White
17-25BR SK	Brass



Lever Latch Only

Part #	Color
17-25B	Black
17-25W	White
17-25BRS	Brass
17-25SV	Silver

- Positive Key Locking Deadbolt for Security • Strong Leveling Return Spring Eliminates Lever Droop • Fits Doors 1" to 2-1/4" Thick
- 1-3/4" Hole Spacing - Upper and Lower Trims • Install in 5/16" Diameter Holes • For Doors with a Stile Greater Than 2" • Escutcheon Width 1-5/8" • Escutcheon Length: Upper 2-3/4", Lower 4-7/16" • Lever Projection 2-1/8" (From Door) • Backset - Variable with Several Strike Options Included • Lever Length from Center of Hub: 4" • Non-Handed, Designed to Complement Both Right and Left Hand Doors • Escutcheon Plate Included for Use with Inside Latch



The newly redesigned Model 17-155 is a solid brass screen or storm door latch set. The lock case, escutcheon plate and strike are hot-forged and precision machined for smooth operation. The spring mechanism is stainless steel. The lever and threaded spindle are hot-forged in one piece for added strength, and the knob is turned from brass bar stock. The latch set is supplied with an angle strike and a rim strike. Backset is 1-9/16". The threaded spindle allows easy adjustment for door thicknesses of 1-1/8" to 1-3/4". Thinner doors can be accommodated by cutting the spindle.

Dimensions: Case 2-1/4" X 2"
Back Plate 1-1/4" X 4" Knob 1-5/8" diameter
Overall Depth: Lever side 1-7/16" Knob side 1-1/2"

Part #	Finish
17-155	Polished Lacquered
17-155SNK	Satin Nickel

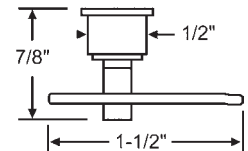
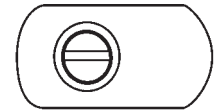

19-319

The Model 19-319 cam fastener is a solid brass assembly designed to fasten wood storm or screen inserts into a combination door or other frame. The standard finish is unlacquered.

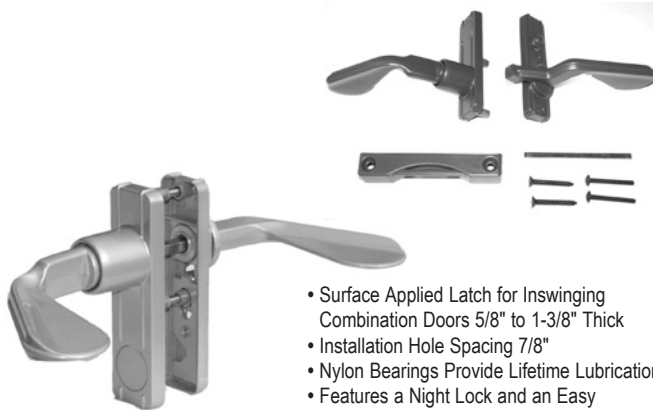

Inswing Door Latch Set

Part #	Color
900-7323	Aluminum
900-7323B	Black
900-7323W	White

- Surface Applied Latch for Inswing Combination Doors 5/8" to 1-3/8" Thick
- Installation Hole Spacing 7/8"
- Nylon Bearings Provide Lifetime Lubrication
- Features a Night Lock and an Easy Latching Resilient Strike
- Reversible for Right and Left Hand Doors and Fits Stilts as Narrow as 1-3/8"
- Installs in Three 1/4" Holes
- Inside Lever Projection is 3"
- Outside Lever Projection is 3-3/4"
- Mounts 1-3/4" Center to Center

IDEAL

TRAILER LATCH SETS

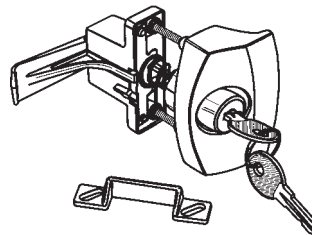

Part #	Color
17-21KA	Aluminum

Low Profile Trailer Lock Set with Key (Entrance)

- For Outswinging Wood or Metal Doors
- Fits 3/4" to 1-1/4" Doors
- Installation Hole Spacing 1-3/4"
- Installs in Two 5/16" Holes and One 7/8" Hole
- Use Wherever a Keyed Locking Unit is Required
- "No Lock Out" Feature

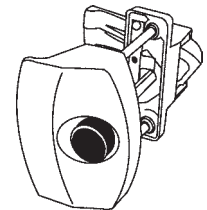

Part #	Color
17-21B	Black

Low Profile Trailer Lock Set with Push Button (Privacy)

- For Outswinging Wood or Metal Doors
- Fits 1/2" to 1-1/4" Doors
- Installation Hole Spacing 1-3/4"
- Installs in Three 5/16" Holes
- Emergency Entrance can be Made from the Outside by Using a Coin or Screwdriver
- "No Lock Out" Feature

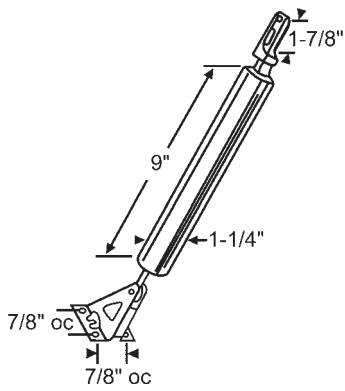

Part #	Color
18-52	Aluminum
18-53	Black
18-52W	White

Pneumatic Door Closer

- For Light Weight Screen Doors
- For Wood or Metal Doors
- For Outswinging Doors
- Full 90° Opening
- Adjustable Closing Speed
- Factory Lubricated

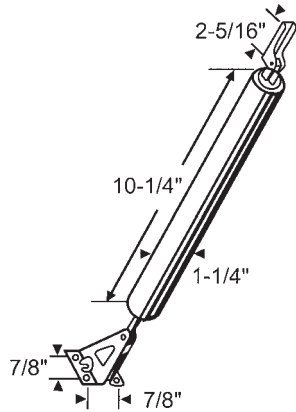

Part #	Color
18-63	Aluminum
18-62	Black
18-62W	White

Economy Air Closer

- For Doors up to 1-1/4" Thick
- Adjustable Closing Power

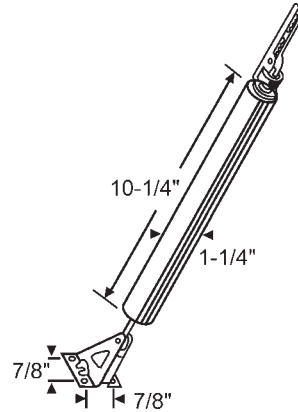

Part #	Color
18-65	Aluminum
18-64	Black
18-64W	White

Silent Action Door Closer

- For Doors up to 1-1/4" Thick
- Permanently Lubricated
- Adjustable Latching Power
- Adapter Plates to Cover Old Holes

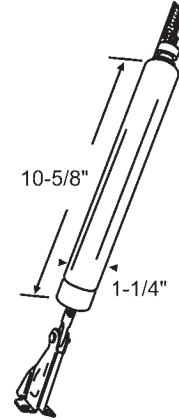

Part #	Color
18-71	Aluminum
18-71B	Black

Pneumatic Door Closer

- For Doors up to 1-1/4" Thick
- Temperature Changes Do Not Affect Closing Action
- Permanently Lubricated
- Automatic Hold Open/Easy Close Feature

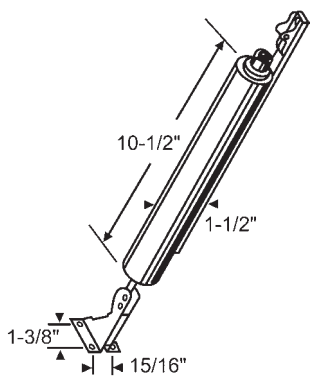

Part #	Color
18-58	Aluminum
18-57	Black

"Smooth Air" Heavy Duty Door Closer

- For Storm and Screen, Jalousie or Interior Doors up to 1-3/4" Thick
- Has Two Times the Power of Standard Closers at Latching Position
- Permanently Lubricated
- Adjustable Speed Control

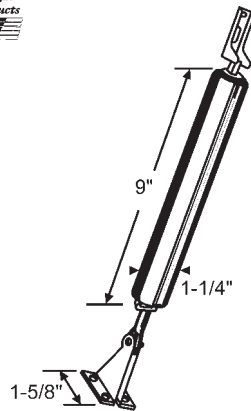

Part #	Color
18-103	Aluminum
18-102	Black
18-102W	White

820 Pneumatic Door Closer

- For Light Storm Doors of Wood or Metal
- Full 90° Opening
- Two-Hole End Plug for Summer and Winter Adjustment
- Adjustable Closing Speed
- Total Length when Mounted Per Instructions: 11-1/16"

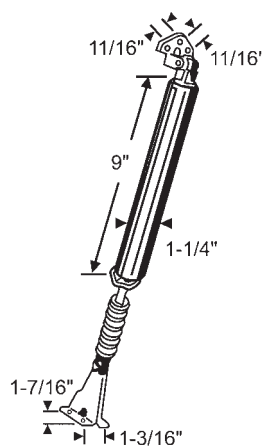

Part #	Color
18-61	Aluminum
18-60	Black

Pneumatic Door Closer

- For Wood or Metal Doors
- Full 90° Opening
- Two-Hole End Plug for Summer and Winter Adjustment
- Adjustable Closing Speed
- External Spring to Prevent Rod Bending
- Packaged with Narrow and Wide Bracket
- Total Length when Mounted Per Instructions: 13-7/16"

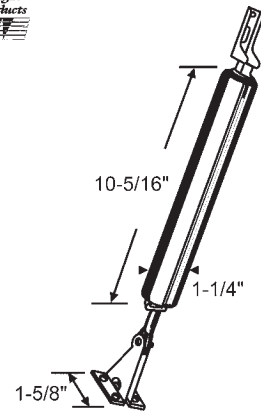

Part #	Color
18-114	Aluminum
18-112	Black
18-113	White

920 Pneumatic Door Closer

- For Wood or Metal Doors
- Full 90° Opening
- Two-Hole End Plug for Summer and Winter Adjustable Latching Power
- Adjustable Closing Speed
- Total Length when Mounted Per Instructions: 12-11/16"

STORM DOOR CLOSERS

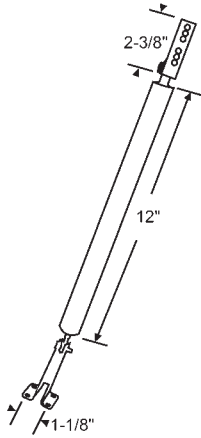

Part #	Color
18-146	Black

Hydraulic Door Closer

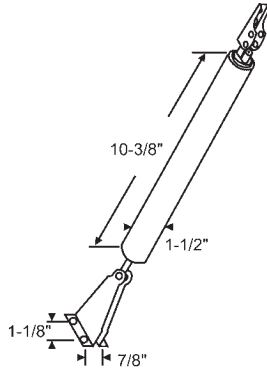

Part #	Color
18-97	Aluminum
18-97B	Black
18-97W	White
18-97G	Gold

150 Heavy Duty Torsion Pneumatic Door Closer

- For Wood or Metal Doors
- Full 90° Opening
- Two-Hole End Plug for Summer and Winter Adjustment
- Adjustable Closing Speed
- Internal Bumper for Prevention of Rod Bending
- Total Length when Mounted Per Instructions: 12-3/4"

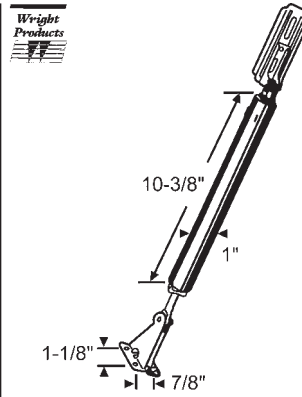

Part #	Color
18-55	Aluminum
18-56	Black

H440 Hydraulic Door Closer

- Hydraulic Mechanism Provides Smooth "No Bounce" Action
- For Wood or Metal Doors
- Full 90° Opening
- Two-Hole End Plug for Summer and Winter Adjustment
- Adjustable Closing Speed by Rotating the Tube
- Aluminum Tube Assembly
- Total Length when Mounted Per Instructions: 12-11/16"

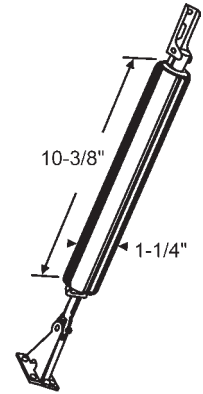

Part #	Color
18-143	Black
18-143AL	Aluminum
18-143W	White

Standard Pneumatic Door Closer

- Internal spring for shock absorption
- Provides 90° opening for outswinging doors
- Adjustable closing speed control valve
- Permanent internal lubrication
- All necessary hardware included

STORM DOOR INSIDE LATCHES

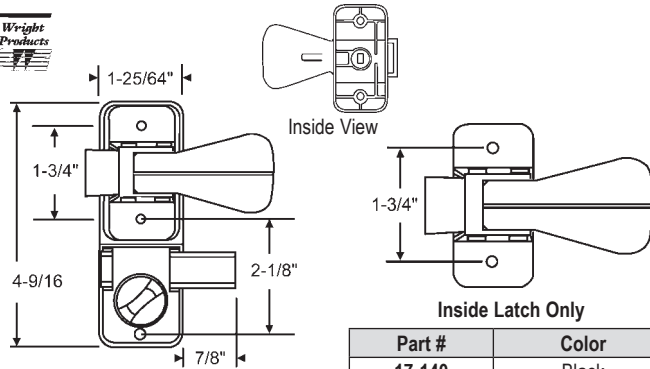

Inside Latch Only

Part #	Color
17-140	Black

Inside Latch and Deadbolt

Part #	Color
17-135	Black

Deadlock Only

Part #	Color
17-160	Black
17-160W	White

- Durable, Heavy-Duty Design
- 1-3/4" Installation Hole Spacing
- Installs in Three 5/16" Holes
- Spring Loaded Nose for use with Z-Bar or Solid Strike
- Latch Assembly and Deadbolt are Reversible
- Can Replace Lever, Knob or Push Button Latch Designs

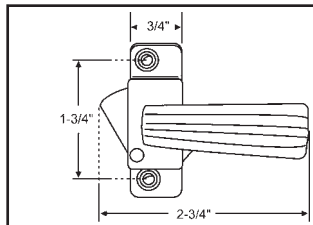

Part #	Color
17-1	Black
17-2	Aluminum

- For all Outswinging Doors 5/8" to 1-1/4" thick
- "No Lock Out" Feature
- 1-3/4" Mounting Hole Spacing
- Installs in Three 5/16" Holes
- Has a Spring Loaded Nose so a Solid Strike is Required

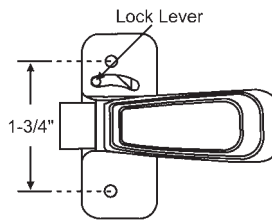

- Installs in Three 5/16" Holes
- Has a Spring Loaded Nose so Z-Bar or Solid Strike is Required
- "No Lock Out" Feature

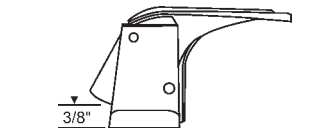

Part #	Color
17-174	Black

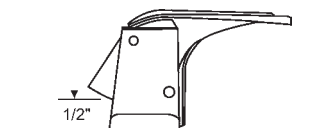

Part #	Color
17-18	Black

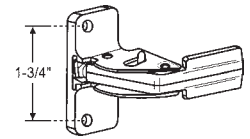

Part #	Color
17-3	Black

3/4" Mounting Hole Spacing Standard Latch

KEY LOCKS

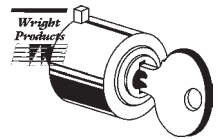

Part #	Color	Converts Handles
19-125	Black	17-65, 17-66

Converts Latches to Key Locking Sets

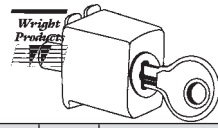

Part #	Color	Converts Handles
19-127	Black	17-56, 17-71, 17-96, 900-7339B, 900-7340

Converts Latches to Key Locking Sets

STORM DOOR HARDWARE

STORM DOOR PANEL CLIPS AND THUMB SCREWS

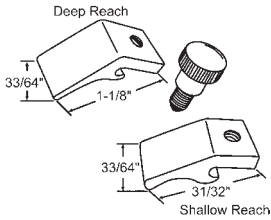

Part #	Color
19-465	White
19-465B	Black

Storm/Screen Door Panel Clip Kits. Includes 4 Each, 2 Styles (Deep and Shallow Reach) of Nylon Clips and 4 Aluminum Screws 8/32" x 1/4" (12pcs. Total)

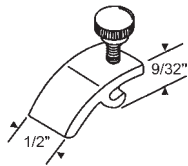

Part #	Color
19-122	Aluminum
19-112	White

1/4" Offset. Metal

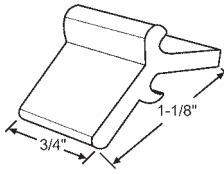

Part #	Color
19-129	White

Nylon

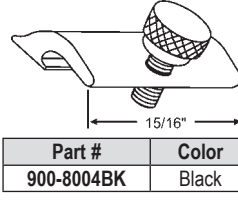

Part #	Color
900-8004BK	Black

Metal



Part #	Color
19-116	Aluminum
19-123	White
19-123B	Brown

8-32 x 9/16". Aluminum

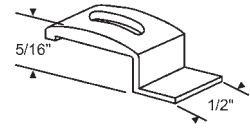

Part #	Color
19-100	Aluminum
19-108	White
19-109	Brown
19-109BZ	Bronze

1/4" Offset. Metal

HINGE PIN

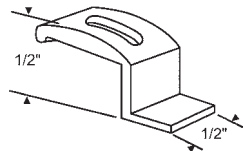

Part #	Color
19-102	Aluminum
19-110	White

3/8" Offset. Metal

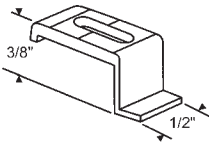

Part #	Color
900-14558	White
900-14558AL	Aluminum

1/4" Offset. Metal

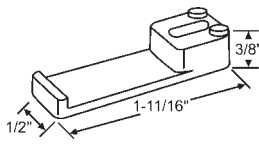

900-6759

Storm Door Clip. White

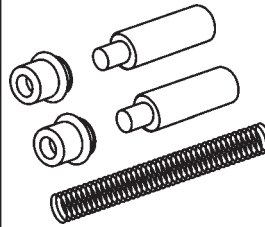

19-496

White Hinge Pins and Bushings

STRIKES

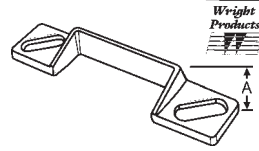

Part #	Color	A
19-185A	Silver	1/4"
19-185B	Black	1/4"
19-197	Steel	1/2"
19-197B	Black	1/2"

No Lock Out. Zinc Solid

SHIMS

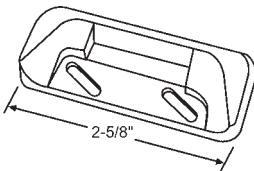

19-227

Black Nylon

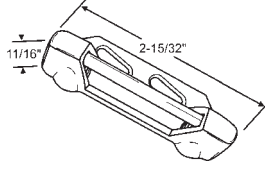

Part #	Color
19-194B	Black
19-194A	Aluminum

3/4" High Profile. Resilient

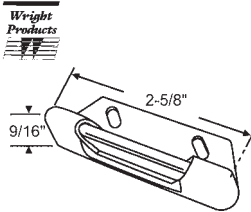

Part #	Color
19-300B	Black
19-300AL	Silver
19-300W	White

9/16" High Profile. Resilient

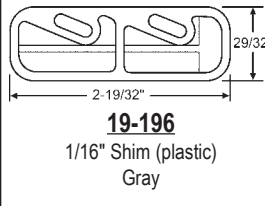

19-196

1/16" Shim (plastic)
Gray



19-186G

1/8" Shim (plastic)
Gray

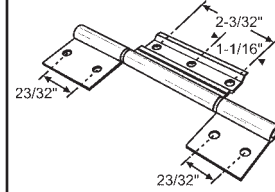

Part #	Color
19-708	Aluminum
19-708BZ	Bronze
19-708W	White

Offset Screen Door Hinge

PUSH BUTTON



19-128

Metal Breakaway Spindle with Spring

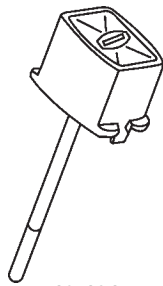

19-131

Black Plastic. Used with 17-56 & 17-58

DOOR CHAIN



19-106

Includes Hold-Up Spring to Prevent Chain from Hitting Door and Scratching Glass. Includes All Necessary Hardware

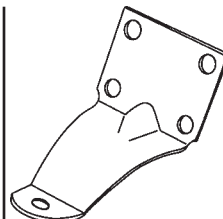

19-313

Inswinging Jamb Bracket for Heavy Duty Pneumatic Door Closer. Includes Pin, Screws and Instructions.

BRACKET

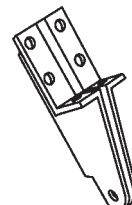

Part #	Color
19-332W	White
19-332B	Black
19-332FBN	Florida Brown

Florida Jamb Bracket. Plastic.

SCREEN SPLINE

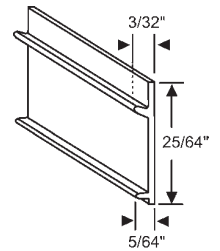

66-61X

Vinyl Screen Spline. Black, 100' Roll

FOREVER DOOR

GENERAL DOOR & BUILDERS HARDWARE

ENTRANCE DOOR CLOSERS

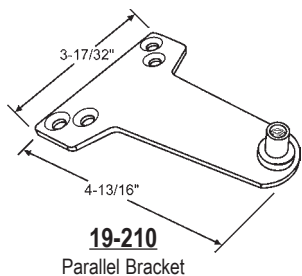
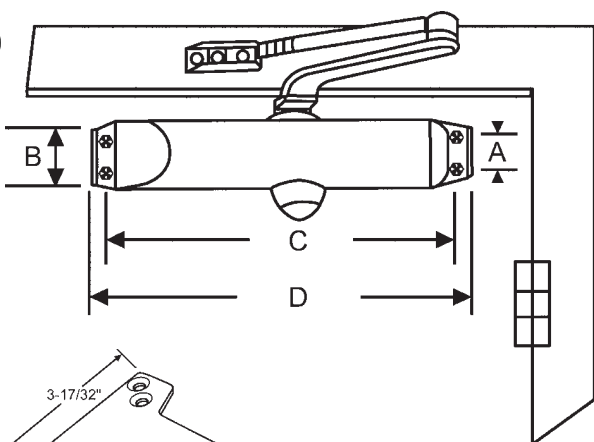

FEATURES

- Surface mounted interior and exterior
- Size 3 is used on 3 ft. wide interior door or 2-1/2 ft. wide exterior door
- Size 4 is used on 4 ft. wide interior door or 3 ft. wide exterior door
- Non-handed
- Permanent lubricating hydraulic fluid
- Easy, smooth action
- Housing made of non-corroding aluminum
- Narrow design is perfect for aluminum, glass, wood and other modern doors

Part #	Size	A	B	C	D	Finish
18-70	#3	3/4"	1-3/4"	8-3/16"	8-15/16"	Aluminum (Silver)
18-72	#3	3/4"	1-3/4"	8-3/16"	8-15/16"	Bronze (Gold)
18-74	#3	3/4"	1-3/4"	8-3/16"	8-15/16"	Duranodic (Dk. Brown)
18-68	#4	3/4"	1-3/4"	9-1/16"	9-13/16"	Aluminum (Silver)
18-69	#4	3/4"	1-3/4"	9-1/16"	9-13/16"	Bronze (Gold)
18-73	#4	3/4"	1-3/4"	9-1/16"	9-13/16"	Duranodic (Dk. Brown)

Dimensions for Closers with Backcheck Feature

Part #	Size	A	B	C	D	Finish
18-70BC	#3	3/4"	1-3/4"	8-3/16"	8-15/16"	Aluminum (Silver)
18-68BC	#4	3/4"	1-3/4"	9-1/16"	9-13/16"	Aluminum (Silver)

POWER ADJUSTABLE CLOSER WITH BACK CHECK OR DELAYED ACTION

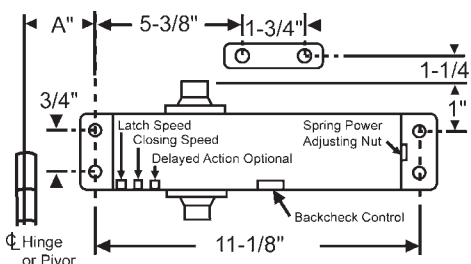
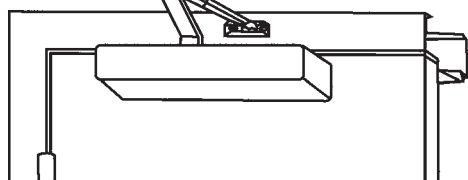

Opening	Dim. "A"
To 120°	7-3/32"
120° - 180°	3-15/16"

Part #	Finish
18-88	Aluminum (Silver)

**ANSI GRADE 1
A - 156.4 STANDARDS
APPLICABLE**

DOOR STOPS AND BUMPERS

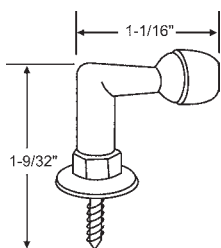

Part #	Finish
900-12356	Brass

Floor Type Door Stop

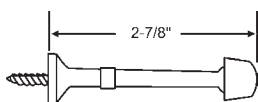

Part #	Finish
19-144	Brass

Solid Stop Bumper Assembly

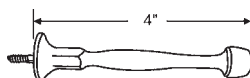

Part #	Finish
19-157	Brass
19-157DC	Dull Chrome

Solid Stop Bumper Assembly

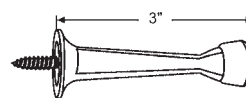

Part #	Finish
19-284SN	Satin Nickel
19-284	Brass Plated
19-284ORBZ	Oil Rubbed Bronze

Solid Type

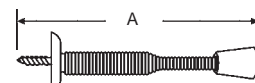

Part #	Finish	A
19-143	Brass	3-3/4"
19-143SN	Satin Nickel	3-3/4"
19-143CH	Chrome	3-3/4"
19-143-4	Brass	4-3/4"

Door Stop Bumper Assembly

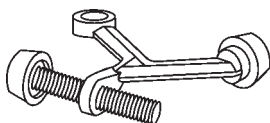

Part #	Finish
19-142	Brass
19-142A	Aluminum
19-142CH	Chrome
19-142W	White
19-142SN	Satin Nickel

Hinge Pin Door Stop

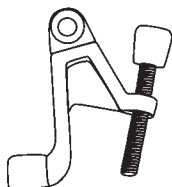

Part #	Finish
19-359	Bright Brass
19-359ORBZ	Oil Rubbed Bronze

Hinge Pin Door Stop

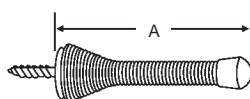

Part #	Finish	A
19-204	Brass	3"
19-204C	Chrome	3"
19-360CH	Chrome	3-3/4"
19-360	Brass	3-3/4"
19-360SNK	Satin Nickel	3-3/4"

Heavy Duty Door Stop Bumper Flexible

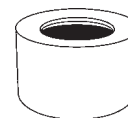

Part #	Color
19-145	White

Hinge Pin Door Stop Bumper Only. Fits 19-142, 19-142A, 19-142CH, 19-142W



Part #	Color
19-146	White

Door Stop Bumper Only. For 9/32" OD Door Stop

GENERAL DOOR & BUILDERS HARDWARE

DOOR STOPS AND BUMPERS

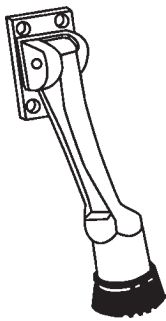

Part #	Finish
19-133	Brass
19-132	Aluminum
19-849CP	Chrome Plated
19-849BP	Brass Plated

4" Drop Down Door Stop

Part #	Finish
19-136	Brass
19-137	Aluminum

5" Drop Down Door Stop
Solid Cast Brass

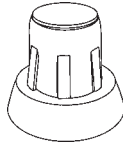

Part #	Color
19-187	Black

Rubber Tip Replacement Only.
For Drop Down Door Stops. Fits
19-132, 19-133, 19-136, 19-137



Part #	Finish
19-135	Brass
19-138	Aluminum
19-135PB	Bright Brass

19-135T
Screw type tip only.
Black

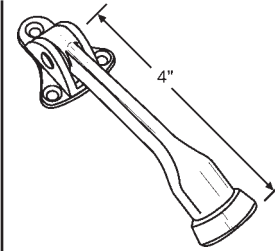

900-10823
Chrome Plated
3 Hole w/ Screws

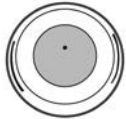

Part #	Color
19-361CH	Chrome Plated
19-361	Polished Brass

2-1/2" Diameter Solid Brass Wall
Door Stop. Concave Face

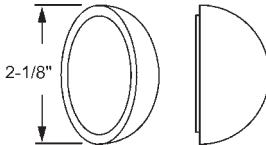

Part #	Color
19-242	White

Adhesive PVC Wall Bumper

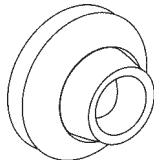

Part #	Finish
19-140	Stainless Brushed
19-140BZ	Dark Bronze
19-140AB	Antique Brass
19-140B	Brass

Screw mount, 2-1/2" diameter
with gray vinyl bumper, concealed
screw mount. Concave face to fit
interior lock button. Furnished with
anchor and screw.

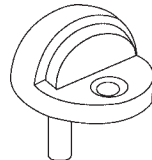

Part #	Finish
19-141	Satin Aluminum
19-141BC	Brushed Chrome

Zinc Die Cast, Low Profile
Door Stop. 1-3/4" Base, 1"
Height, 1/8" Clearance.

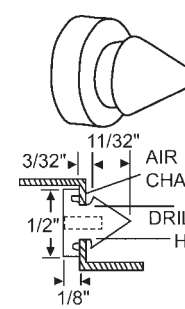

Part #	Color
19-134	Gray

Part # 19-134 Color Gray

RETRACTABLE GARMENT HOOK

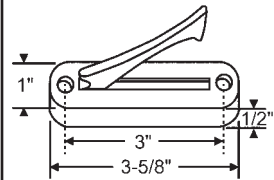

Part #	Color
19-328	Bright Chrome
19-329	Antique Brass

Part # 19-328 Color Bright Chrome
Part # 19-329 Color Antique Brass

WALL PROTECTORS

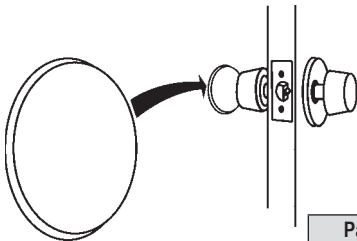

3" Diameter

Part #	Color
19-181	White
19-181OW	Off White

5" Diameter

Part #	Color
19-182	White

Made of high impact material
that can be painted or papered.
Use to repair larger areas of
wall damage. Foam adhesive
on back absorbs shock. 1/4"
Total thickness. Washable.

DOOR LOCK CHANNELS

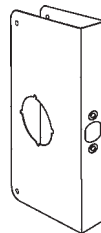

Part Number	Backset	Door Thickness
19-160-4	2-3/8"	1-3/8"

2-1/8" Bores. Large Single Hole.
Brass Plated Aluminum.
Overall Dimension 4" x 9"

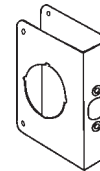

Part Number	Backset	Door Thickness
19-174-4	2-3/8"	1-3/8"

2-1/8" Bores. Small Single Hole.
Brass Plated Aluminum.
Overall Dimension 4" x 4-1/2"

DOOR KNOCKER

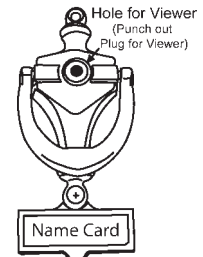

900-12213

Polished Brass. Name plate card.
Cast knocker with polished brass
finish. Surface mount application
Space for door viewer.
Viewer sold separately

CHAIN LOCK

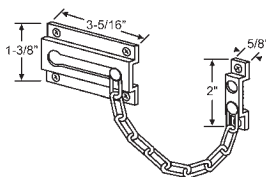

900-7490

Heavy Duty Brass Plated
Steel Door Chain with Solid
Brass Keeper



900-8108

Brass Plated Stamped Steel
Door Chain

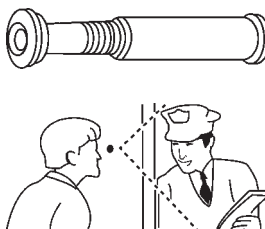

19-149

160° Angle Plastic Lens
1/2" Installation Hole. Fits doors
1-1/8" to 2-1/4" thick. Solid Brass

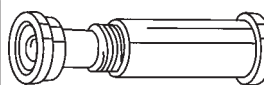

900-12562

160° angle plastic lens
fits doors 1-3/8" to 2-1/4" thick
1/2" installation hole, wide angle.
See who is on the other side
before you open the door.
Solid brass construction

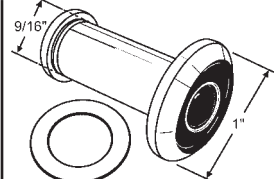

Part #	Color	Angle
19-215	Polished Brass	180°
19-215CP	Bright Chrome	180°
19-184	Polished Brass	200°

Solid Brass. 9/16" Bore, Fits
1-3/8" to 2-1/4" Thick Doors

DRAWER TRACK SETS

45-23
Track Mounting Bracket

45-14
Guide

45-52
Corner Guide

Part #	Description
45-87	22-3/4" Track Set

Single Drawer Set
(Track not available separately.)

900-11843
Track Mounting Bracket
Metal

900-17778
Roller Bracket

900-11808RH
Roller

900-11808LH
Roller

Part #	Description
45-103	22-7/16" Complete Track Set Galvanized

DRAWER INSERTS

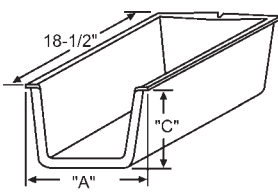

Part#	"A"	"C"	# Stamped on part	Carton Qty.
45-89	14-5/8"	4"	TP-154	8
45-90	20-1/2"	4"	214-24	8
45-91	11-3/4"	4"	TP-124	16
45-93	17-1/2"	4"	TP-184	10
45-94	8-3/4"	4"	TP-94	24
45-95	11-3/4"	8"	128-15	12

Replace old worn out cabinet drawers with plastic drawer inserts. Also replaces Old Style Triangle Pacific
A packing fee will be assessed on orders with less than carton quantity.

MONORAIL

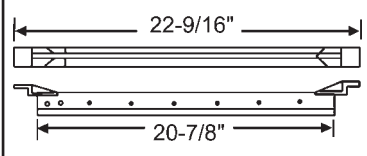

45-96

DRAWER SLIDES

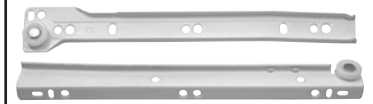

45-416
22" Drawer Slides. White

DRAWER GUIDES AND BRACKETS

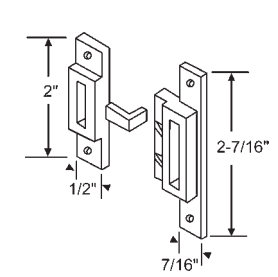

45-48
Front and Rear guide set for 45-96 monorail and drawer inserts.

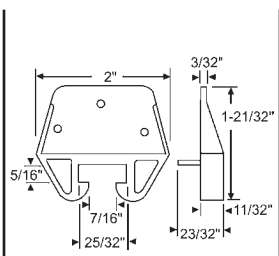

45-1
Drawer guide
Old KD-01

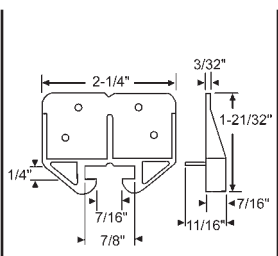

45-15
Drawer guide

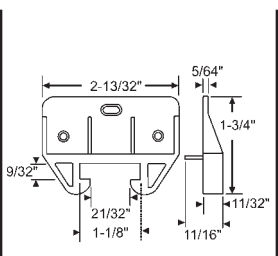

45-6
Drawer guide
Old KD-06

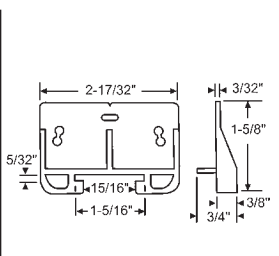

45-14
Drawer guide
Old KD-14

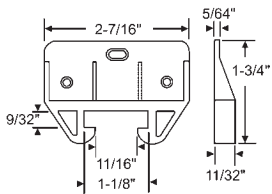

45-7
Drawer guide
Old KD-07

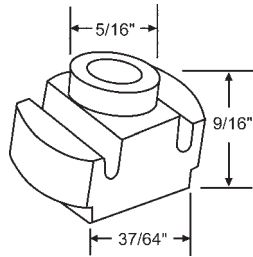

900-9936
Drawer guide

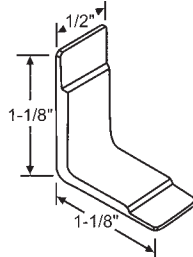

45-52
Drawer Guide
Nylon

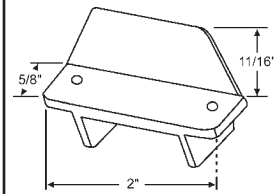

45-10
Drawer Guide

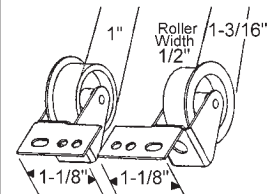

Part #	Hand
900-11808LH	LH
900-11808RH	RH

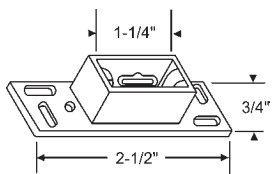

45-9
Drawer Mounting Bracket

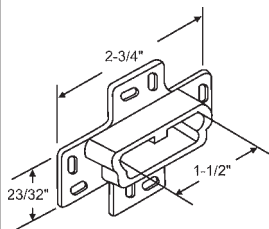

45-23
Drawer Mounting Bracket

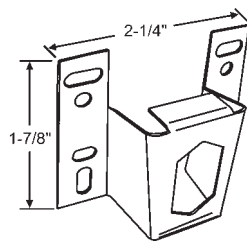

900-11843

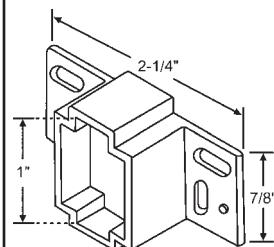

45-16
Drawer Bracket

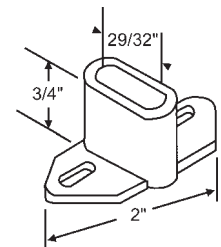

45-26
Drawer Bracket

SOCKETS

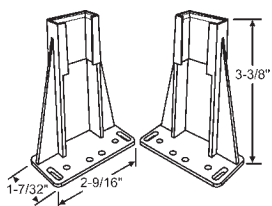

45-582
Rear Mounting Bracket Set
White Plastic

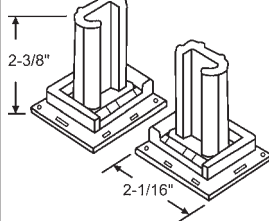

45-203
Adjustable Rear Mount Drawer
Slide Socket Set

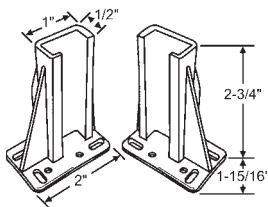

45-229
Rear Mount Drawer
Slide Socket Set

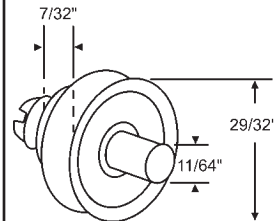

45-98
Drawer Roller with Axle

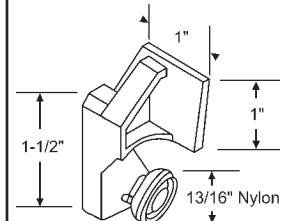

45-19
Cabinet Roller
AJAX

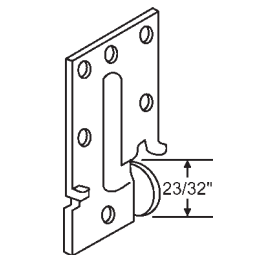

900-17778
Roller Bracket
No Longer Available.
Use: 900-17778NS

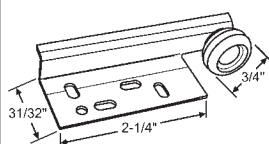

900-17778NS
Roller Bracket. New Style

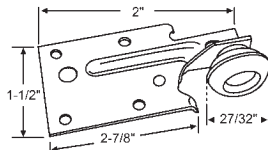

45-24
Drawer Roller. Nylon Roller

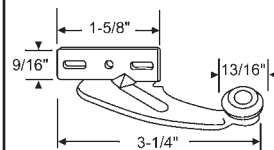

45-18

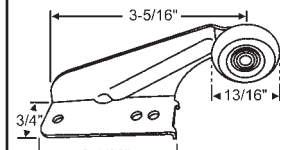

45-17-2
Sold & Bagged in Pairs

ROLLERS

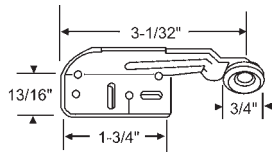

45-25

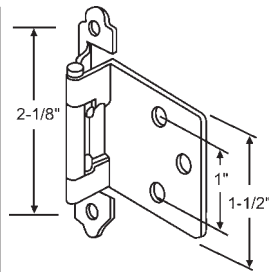

Part #	Finish
900-8910AB	Antique Brass

Pair with Screws and Pads

HINGES

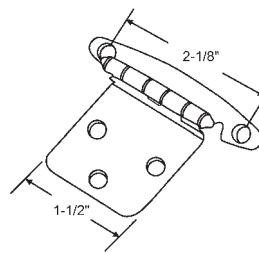

Part #	Finish
45-235PB	Polished Brass
45-235AB	Antique Brass

Flush Mount, Free Swinging Hinge

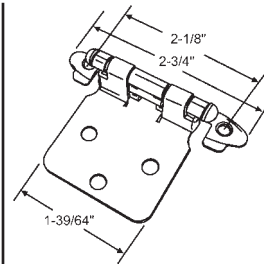

Part #	Finish
45-236PB	Polished Brass
45-236AB	Antique Brass

Flush Mount Self-Closing Hinge

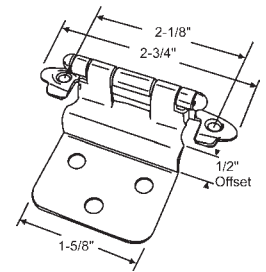

Part #	Finish
45-237PB	Polished Brass
45-237AB	Antique Brass

Offset Self-Closing Hinge

MINI DOOR STRUTS

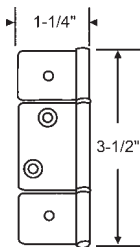

8-356
Polished Brass 3 Leaf

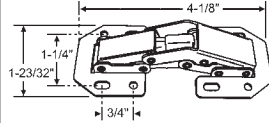

45-225
Nickel Finish Self-Closing Hinge
4 way Adjustable, 90° Opening

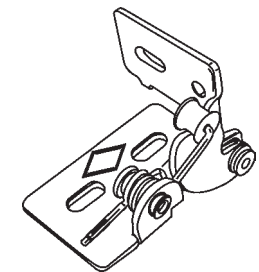

45-230
Polished Chrome #5 Knife Hinge

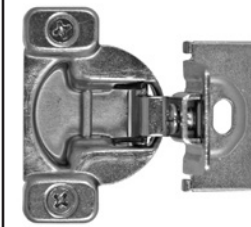

45-422
Concealed Hinge
1/2" Overlay

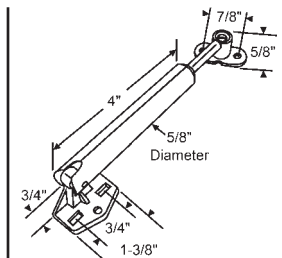

45-208
Black Mini Door Strut, Nylon

BUMPERS

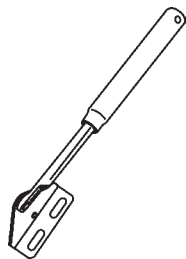

Part #	Finish
45-207	Satin Nickel
45-206	Antique English

Mini Door Strut, Steel

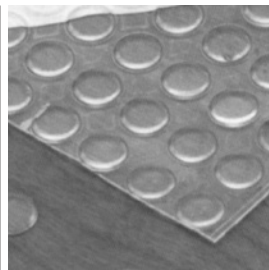

45-240
Clear Plastic Bumper
1/2" W x 1/16" H

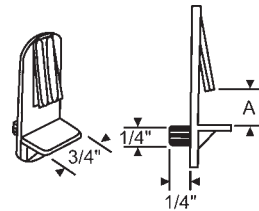

Part #	A
45-101W	1/2"
45-459W	5/8"
45-460W	3/4"

White. For 1/2" Shelf

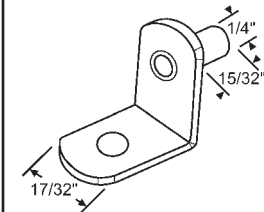

900-10820
Shelf Support

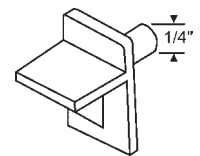

45-99
Shelf Support
Plastic

CABINET SHELF SUPPORTS AND BRACKETS

LATCH AND CATCH

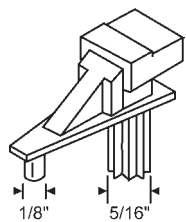

45-100
Shelf Support

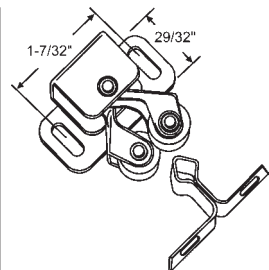

45-216
Heavy Duty Double Roller, RV
Cabinet Catch. Antique Copper

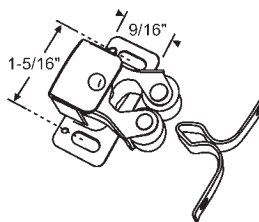

900-6698
Cabinet Catch
Zinc Nickel Plated

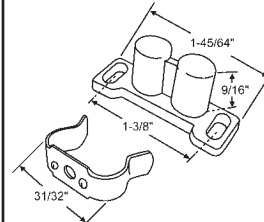

900-10756
Solid Plastic White Barrel Catch

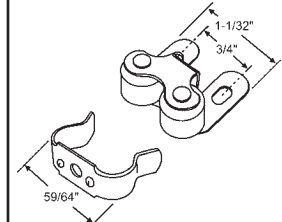

900-9130
Roller Catch
Zinc Nickel Plated

CABINET HARDWARE

LATCH AND CATCH

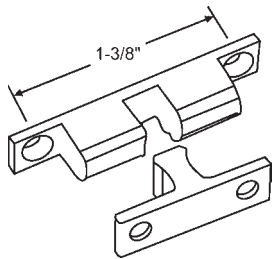

45-227

Solid Brass Ball Catch

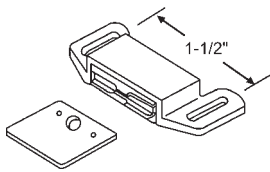

900-6695

Tan Plastic High Power Magnetic Catch with Flat Plate

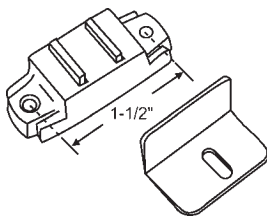

900-11343

Tan Plastic High Power Magnetic Catch with Angle Plate

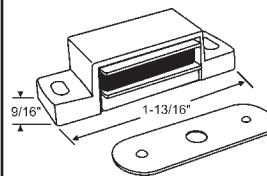

45-194

Brown Plastic Magnetic Cabinet Door Catch with Flat Plate

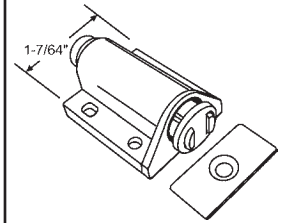

45-239

Black Magnetic Touch Latch

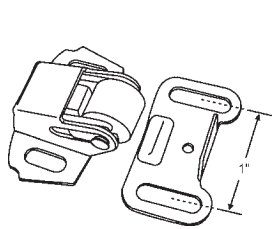

45-130

Roller Catch and Strike
Zinc Nickel Plated

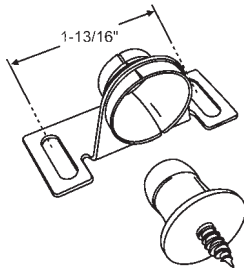

45-245

Black Self Aligning Catch

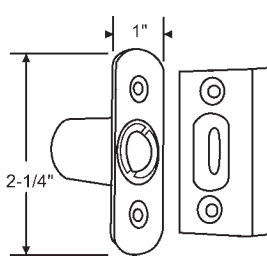

900-10858R

Ball Catch and Strike
with Rounded Corners
Brass Plated

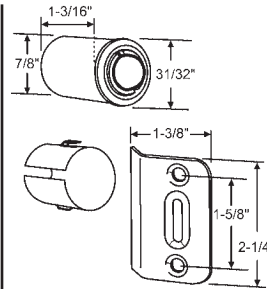

900-10858DI

Drive In Bullet Ball Catch with
Adjustable Tension Ball.
Brass Plated



8-471

1-1/8" Knob
Polished Brass

HANDLES AND KNOBS

CABINET PULLS



8-470

1-1/4" Knob
Polished Brass



8-482

1-1/4" Knob
Satin Nickel Finish



Part #	Finish
45-354PC	Polished Chrome
45-354BRS	Polished Brass
45-354SNK	Satin Nickel
45-354SCH	Satin Chrome

1-1/4" Knob



Part #	Finish
45-355CH	Chrome
45-355PB	Polished Brass
45-355SNK	Satin Nickel

3" Cabinet Pull



45-356SS

3" Cabinet Pull
Stainless Steel

ROSETTE

MIRROR HARDWARE



45-424AB

3" Cabinet Pull
Antique Brass

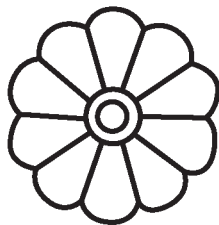

900-20751

White with Screws

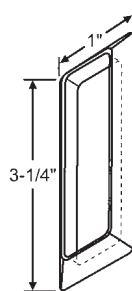

900-17639-1

Adhesive Backed Finger Pull.
Sold in Pairs. Clear

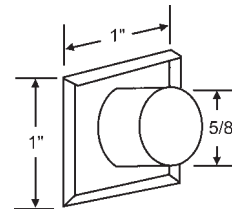

900-16236

Adhesive Backed Mirror Pull
Acrylic

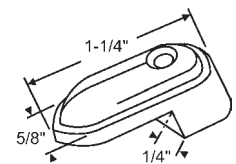

900-13119

Teardrop Mirror Clip with Screws

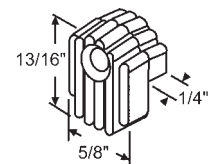

900-9137

Ribbed Mirror Clip
without Screws

MULTI-CAM MAIL BOX LOCK KITS

97-75

For Interior Mail Boxes
Bright Nickel Finish

Nut mounted lock meets specifications established by the U.S. Postal Service. Counter clockwise cam turn to open. Furnished with two keys, five different cams shown below, cam screw, mounting nut and instructions. Assemble with cam that matches lock. Keyway NA 14

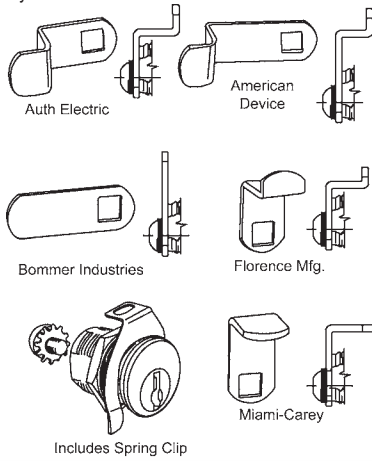

97-17

For Outside Mail Boxes
Bright Nickel Finish

Keyway Dust Shutter protects mechanism from the elements. Lock has dual slots for mounting indoor using spring clip. Clockwise cam turn to open. Furnished with three keys, five different cams shown below, nut, lock washer, spring clip and instructions. Assemble with cam that matches present lock. Keyway NA 14

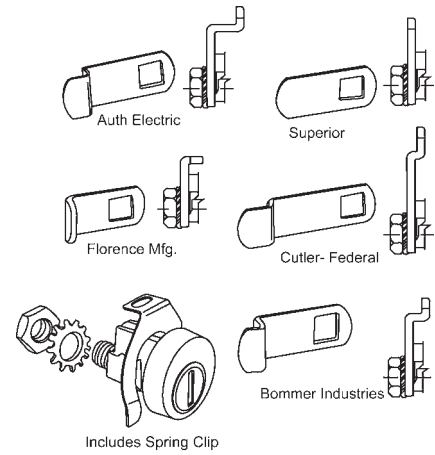

97-28

Replacement for Hudson #PT812

Multi-Cam Mail Box Lock Kit a suitable replacement for hudson #PT812. Hex nut mounted. Meets U.S. Postal Service specifications. 90° CCW cam rotation. Key removable in locked position only. Furnished with 3 keys, 5 cams, and all necessary mounting hardware. Keyway HL 1 - Nickel finish

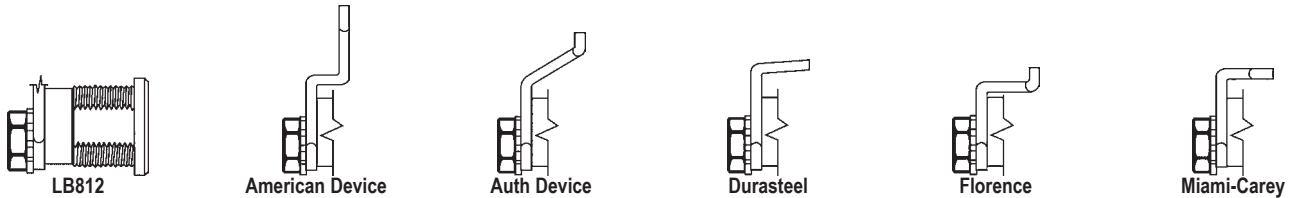

FIXED CAM MAIL BOX LOCKS

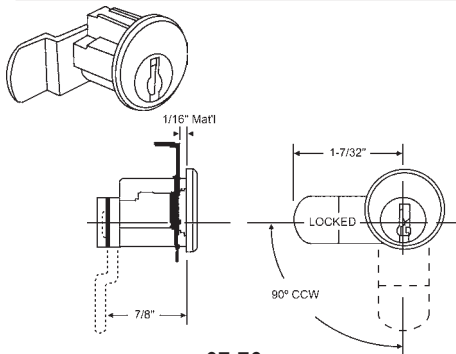

97-76

Bommer. Bright Chrome
Locked Cam Position - Left. Keyway NA14

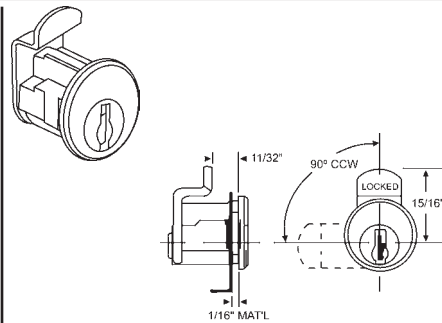

97-77

Florence Mfg. Bright Chrome.
Locked Cam Position - Up. Keyway NA14

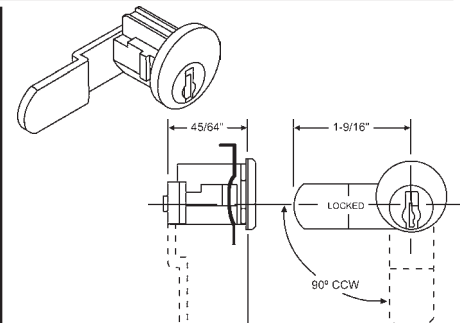

97-20

Cutler Federal. Bright Chrome
Locked Cam Position - Down. Keyway NA12

FLAT MAILBOX LOCKS

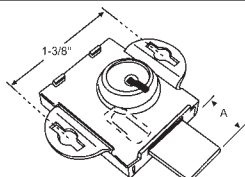

Part #	"A"
97-18	1/4"
97-19	1/2"

Replaces: Eagle #2616 1/4C, Iico #4070A Fits: Auth, United, Florence. Bright Brass Finish Furnished with Two Keys.

GARAGE DOOR HANDLES

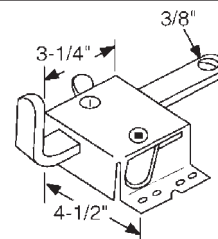

2529

Snap Lock

TOILET PARTITION HARDWARE

CONCEALED AND SURFACE MOUNTED LATCHES

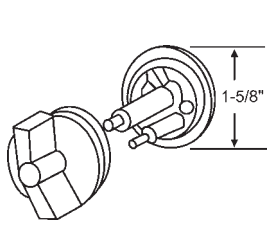

91-8
Used with 91-129 Housing
AMERICAN METAL

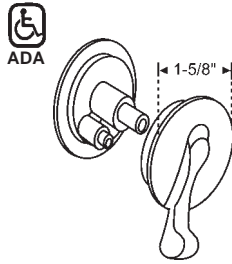

91-330
Used with 91-129 Housing

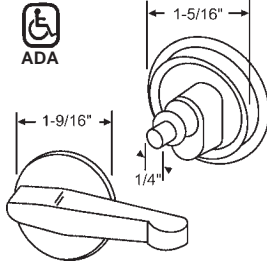

91-84
SANYMETAL

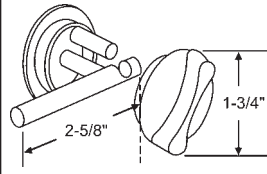

91-130
For 1\" Laminated Door

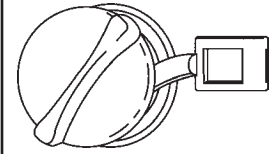

91-131
With Flat Tip Bar. For 1\" Steel Door

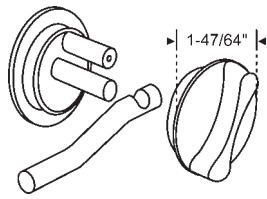

91-198
For 1\" Steel Door

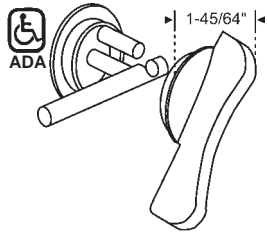

91-209
For 1\" Laminated Door

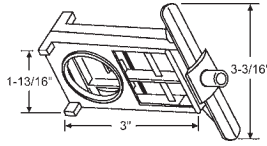

91-129
Zinc Die Cast - Unplated

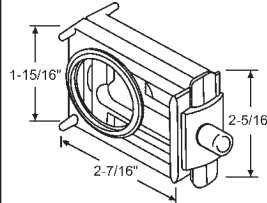

91-187
Zinc Die Cast - Unplated

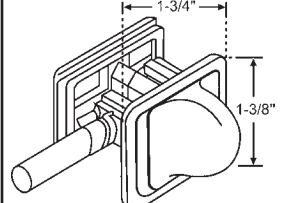

91-292
For 1\" Steel Door

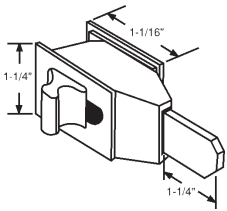

900-18069
With Red and Green Indicator.
For 1\" Steel Door

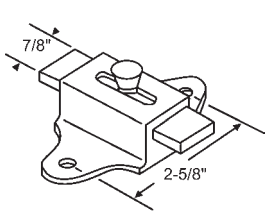

91-83

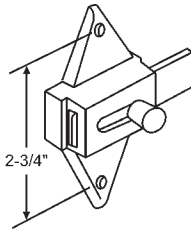

91-79

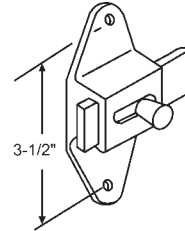

91-4

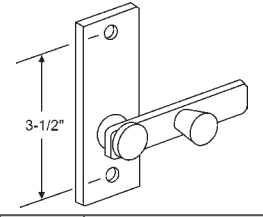

Part #	Finish
91-80	Chrome Plated Brass
91-80SS	Stainless Steel

CHROME PLATED DOOR PULLS, HOOKS AND DOOR STOPS

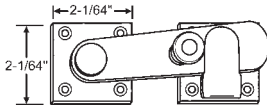

900-20480
Includes Keeper

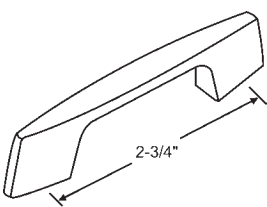

91-125
Mounting Holes Tapped 8-32

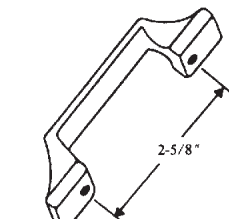

91-90
Mounting Holes Tapped 10-24

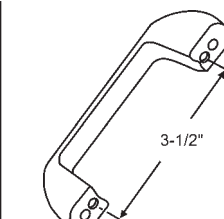

91-9
Mounting Holes Tapped 10-24

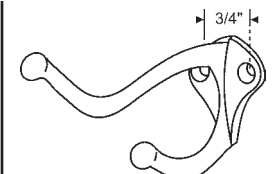

Part #	Finish
91-7	Chrome Plated
91-7BP	Brass Plated
91-7SS	Stainless Steel

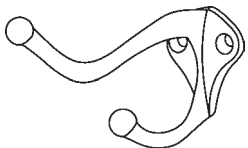

91-7J
Heavy Duty. 7/32\" Hole Diameter

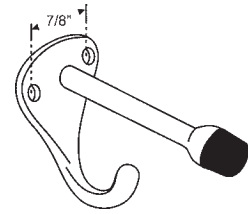

Part #	Finish
91-6	Chrome Plated
91-6SS	Stainless Steel

Coat Hook with Bumper
7/32\" Hole Diameter

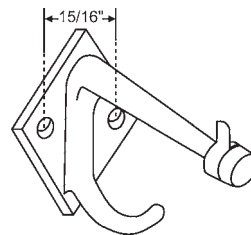

91-255
1/4\" Hole Diameter

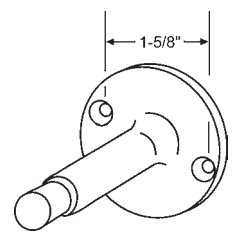

91-10
2\" High

TOILET PARTITION HARDWARE

CHROME PLATED KEEPERS AND STRIKES FOR 1-1/4" ROUND AND SQUARE POSTS

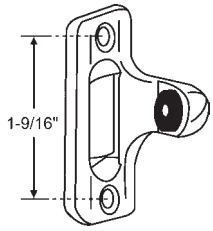

91-290

Inswing/Outswing for Concealed Latch with Flat Bar

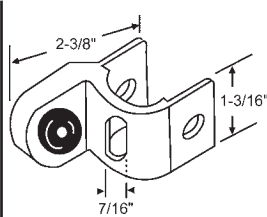

91-5

Inswing/Outswing for Concealed Latch with Round Bar

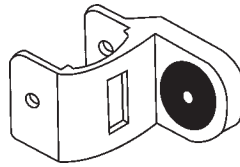

91-134

Inswing/Outswing for Concealed Latch with Flat Bar

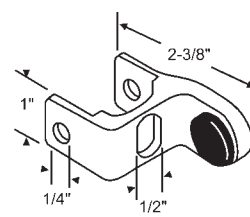

91-87

Inswing/Outswing for Concealed Latch

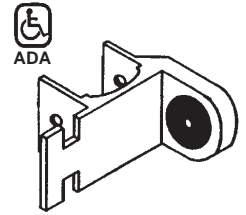

91-253

Inswing for Throw Latch. Emergency Access

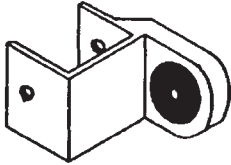

91-137

Outswing for Slide Latch

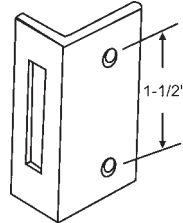

900-10535

Inswing for Slide Latch, Chrome

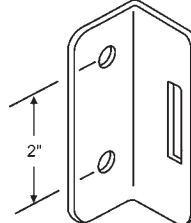

91-89

Inswing for Slide Latch
SANYMETAL

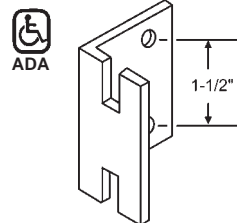

91-81

Inswing for Throw Latch
Emergency Access

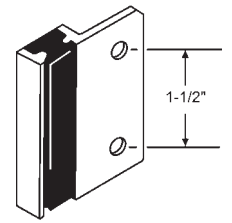

91-82

Inswing/Outswing for Slide Latch

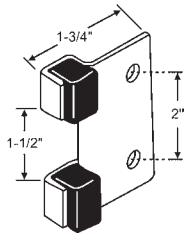

91-88

Inswing/Outswing Strike
SANYMETAL

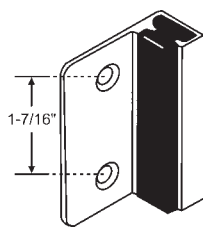

91-141

Outswing for Slide Latch

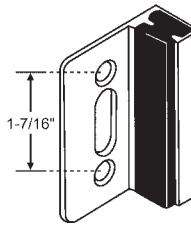

91-140

Inswing/Outswing for Concealed Latch

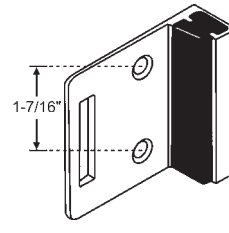

91-135

Inswing for Slide Latch

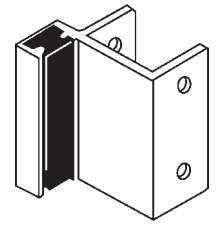

91-78

Outswing for Slide Latch

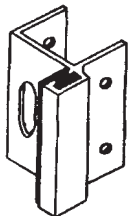

91-133

Inswing/Outswing for Concealed Latch

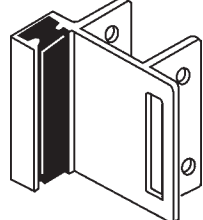

91-26

Inswing for Slide Latch

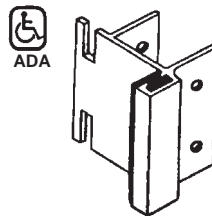

91-132

Inswing for Throw Latch
Emergency Access

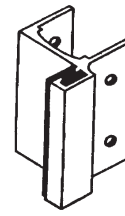

91-217

Outswing for Slide Latch

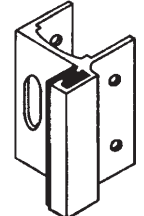

91-55

Inswing/Outswing for Concealed Latch with Round Bar

CHROME PLATED WRAP AROUND GRAVITY PIVOT HINGES FOR 1-1/4" ROUND AND SQUARE POSTS

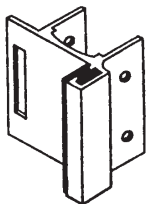

91-237

Outswing for Slide Latch

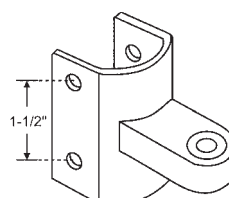
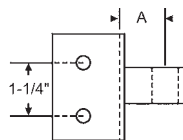

Part #

91-2

A

1-5/64"

FLUSHMETAL

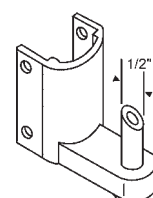

Part #

91-3

A

1-5/32"

FLUSHMETAL

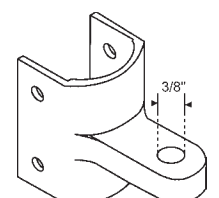

Part #

91-85

A

1-1/16"

SANYMETAL

TOILET PARTITION HARDWARE

CHROME PLATED WRAP AROUND GRAVITY PIVOT HINGES FOR 1-1/4" ROUND AND SQUARE POSTS

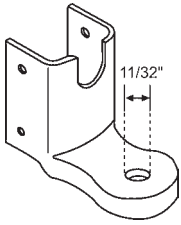

Part #	A
91-86	1-1/16"

SANYMETAL

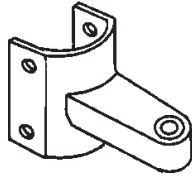

Part #	A
91-183	1-25/64"

GENERAL/KNICKERBOCKER

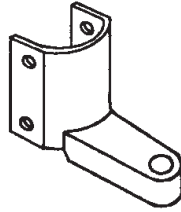

Part #	A
91-182	1-25/64"

GENERAL/KNICKERBOCKER

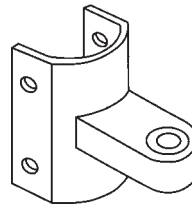

Part #	A
91-186	1-1/16"

AMPCO/METPAR

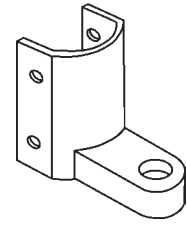

Part #	A
91-185	1-7/64"

AMPCO/METPAR

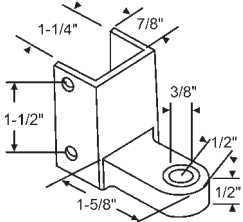

Part #	A
91-24	1-17/64"

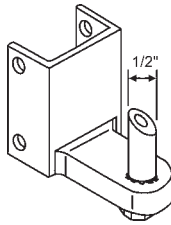

Part #	A
91-25	1-17/64"

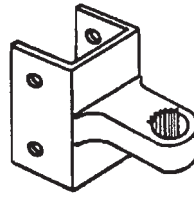

Part #	A
91-240	1-19/64"

Top and Bottom Hinge

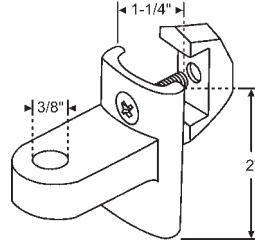

Use: 91-85

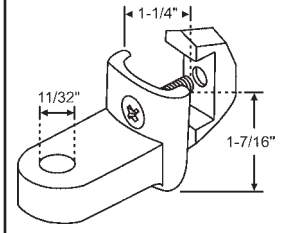

Use: 91-86

SURFACE MOUNTED GRAVITY HINGE

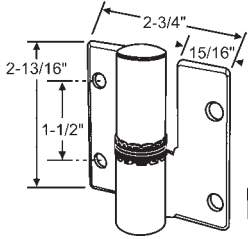

91-28

Round Barrel Hinge set for LH Inswing or RH Outswing. Chrome Plated. Includes 8 One Way Screws and 8 Barrel Nuts

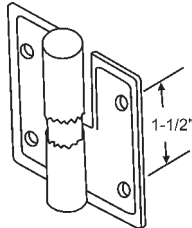

91-29

Round Barrel Hinge set for RH Inswing or LH Outswing. Chrome Plated. Includes 8 One Way Screws and 8 Barrel Nuts

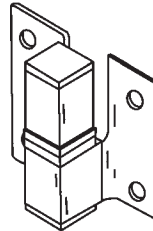

91-173

Square Barrel Hinge set for RH Inswing or LH Outswing. Cast Stainless Steel. Satin Finish

91-199

Square Barrel Hinge set for LH Inswing or RH Outswing. Cast Stainless Steel. Satin Finish

CHROME PLATED WALL BRACKETS

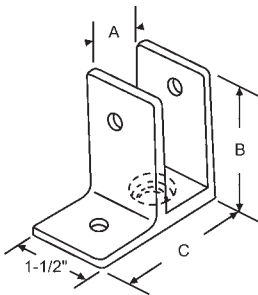

Part #	A	B	C
91-15	1"	2-1/2"	2-21/32"
91-16	1-1/4"	2-1/2"	2-3/4"
91-288	1-1/4"	3-1/2"	2-3/4"

One Ear

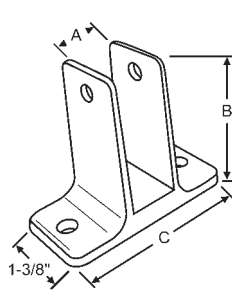

Part #	A	B	C
91-323	3/4"	2-1/2"	3"
91-367	1-1/4"	3-1/2"	4"

Two Ears

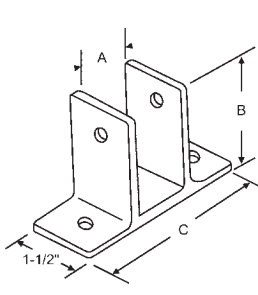

Part #	A	B	C
91-17	1"	2-1/2"	4"
91-97	1"	3-1/2"	4"
91-18	1-1/4"	2-1/2"	4"

Two Ears

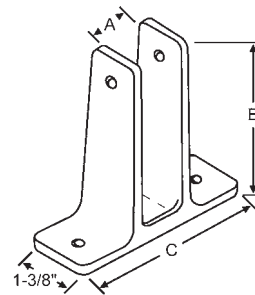

Part #	A	B	C
91-160	1"	3-1/2"	4"
91-161	1-1/4"	3-1/2"	4"

Screen Brackets

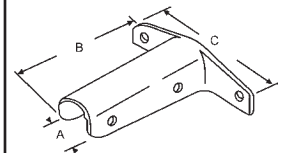

Part #	A	B	C
91-159	1"	12"	7"
91-11	1-1/4"	6"	6-1/4"

Wing Brackets

CHROME PLATED U - BRACKETS

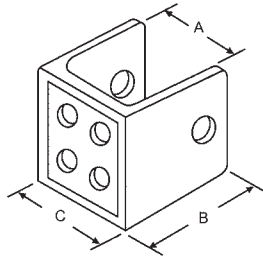

Part #	A	B	C
91-76	7/8"	1-3/8"	1-5/32"
91-12	1"	1-3/8"	1-1/4"
91-167	1-1/4"	1-3/8"	1-1/2"

REPLACEMENT PILASTER SHOES

Square Edge 1-1/4" Thick Pilaster Shoes
Open Front w/Holes. 22 Gauge Stainless Steel. Satin Finish

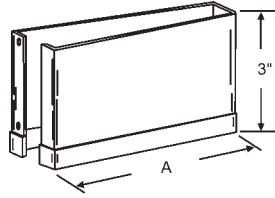

Part #	"A"
91-31	2"
91-33	3"
91-35	4"
91-37	5"
91-39	6"
91-41	7"
91-43	8"
91-45	10"
91-47	12"
91-468	24"

Round Edge 1-1/4" Thick Pilaster Shoes
Open Front w/Holes. 22 Gauge Stainless Steel. Satin Finish

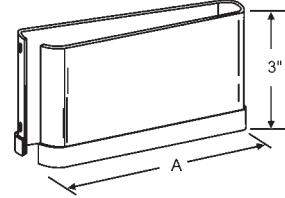

Part #	"A"
91-30	2"
91-32	3"
91-34	4"
91-36	5"
91-38	6"
91-40	7"
91-42	8"
91-44	10"
91-46	12"
91-469	24"

DOOR INSERTS

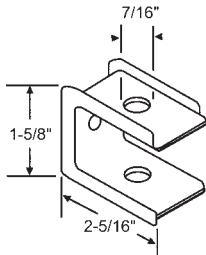

91-72
Top - for 1" Square Edge Door
Chrome Plated

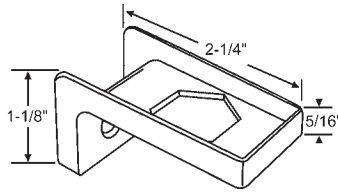

91-117
Bottom - for 1" Square Edge Door
Chrome Plated

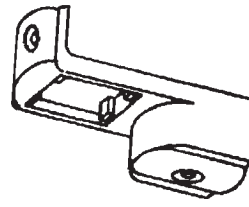

91-252NS
Bottom for 1" Round Edge Metal Door.
Chrome Plated
FLUSHMETAL

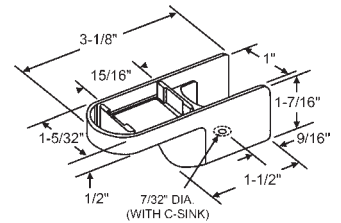

900-14906
Bottom for 1" Round Edge Metal Door.
AMPCO/METPAR

CAMS, PINTLES AND HINGE PINS

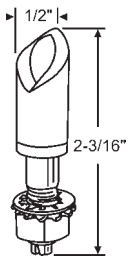

91-102B
Used with 91-114 and 91-191

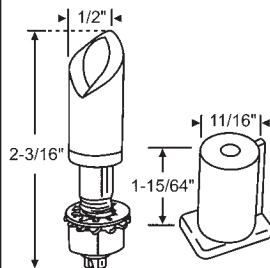

91-102
Set

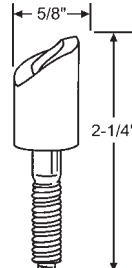

91-148
Used with 91-113, 91-190
and 91-189

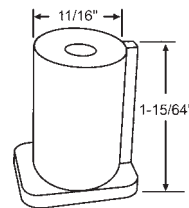

91-191
White Plastic. Fits Insert 91-73

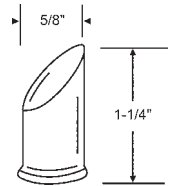

91-114
White Plastic. Fits Insert 91-153

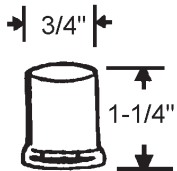

91-113
White Plastic. Fits Insert 91-117

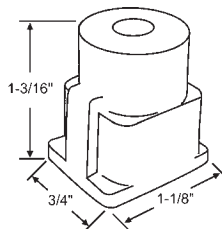

91-189
White Plastic

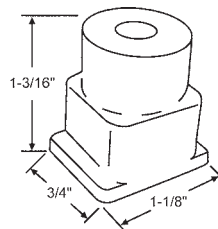

91-190
White Plastic



91-313
Nylon
HADRIAN



91-314
HADRIAN

TOILET PARTITION HARDWARE

CAMS, PINTLES AND HINGE PINS



91-152
METPAR

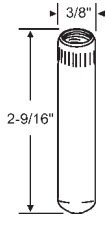

91-96
Plastic
SANYMETAL

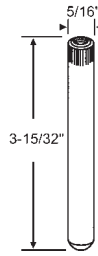

91-1

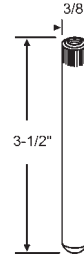

91-71
Hinge Bracket for Plastic
Laminated Pilasters

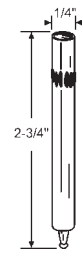

91-261
GENERAL

CHROME PLATED ALCOVE CLIPS, HEAD RAIL, END PLUGS AND BRACKETS

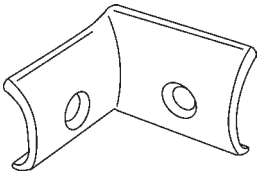

91-328
For 1" to 1-1/4" Post. Right Angle
Curved Molding
FLUSH METAL

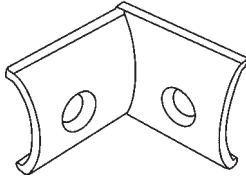

91-264
Alcove Right Angle
Curved Molding
METPAR

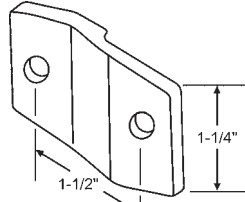

91-70
Alcove 1-1/4" Offset (1/8" per
side). For all Size Posts

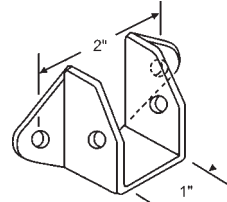

91-13
Headrail Bracket

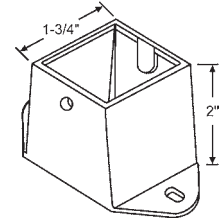

91-21
Pilaster Shoe for 1-3/4"
Square Tube

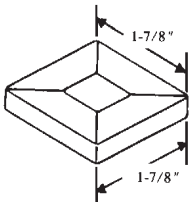

91-20
1-3/4" Nylon Square Post Cap

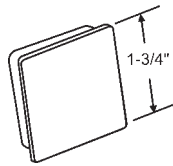

91-116
1-3/4" Nylon Square Post Plug

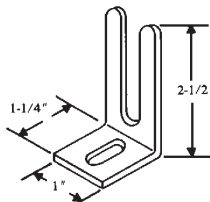

91-22
Floor Bracket

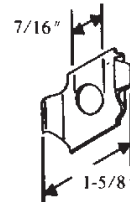

91-23
Spring Clip

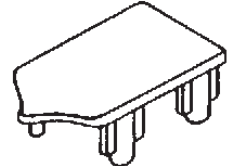

91-63
Anti-Grip End Plug for all Size
Handrails

ONE-WAY SCREW REMOVER

If you've tried to remove One-Way Tamper-Proof Screws from toilet partition, locks, fixtures and assemblies... you know the frustration involved. NO MORE DRILLING, POUNDING, PULLING, OR CHISELING... that wastes time, bruises knuckles and causes costly hardware damage. Highly praised by thousands of locksmiths, maintenance and service personnel, contractors and other professionals as a VALUABLE TOOL NEEDED FOR YEARS!

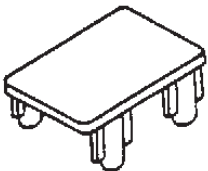

91-64
Rectangular End plug
for 1" Handrail

Part #	Screw Size
59-15	6-8
59-16	8-10
59-17	12-14

Three sizes available to fit
all one-way screws.

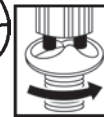
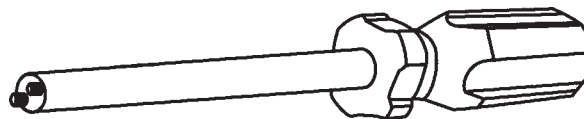

Easy to Use
Works like an ordinary
screwdriver. "No slip"
tip design provides
maximum holding power
until screw is removed.

CHROME PLATED TOILET PARTITION FASTENERS

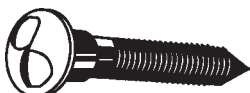

Part #	Screw Size
20-291	10-24 Thread x 15/16" Long
20-187	10-24 Thread x 1-3/16" Long
20-185	8-32 Thread x 1-3/8" Long

One Way Screws



Part #	Screw Size
20-293	10-24 Thread x 5/8" Long
20-186	10-24 Thread x 1/2" Long
20-186US	8-32 Thread x 1/2" Long (Not Slotted)

Barrel Nut

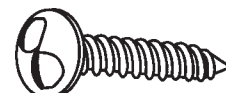

Part #	Screw Size
20-366	#10 x 3/4" Long
20-204	#10 x 1" Long
20-362	#10 x 5/8" Long

Self Tapping Screws

COMMERCIAL DOOR/STOREFRONT HARDWARE

MORTISE LOCKS

DEADLATCH



Specify RH or LH
(LH Shown)

DEADBOLT



Non Handed

HOOKBOLT



Non Handed

SPECIFICATIONS

- Function: Deadbolt, Hookbolt, Deadlatch
- Backset: 31/32", 1-1/8", 1-1/2"
- Case Dimensions: 7/8"W x 6"L x Depth specific to backset
- Latchbolt: Deadbolt - 5/8"W x 2-7/8" L x 1-3/8" throw
- Hookbolt - 5/8"W x 1-3/8" L x 13/16" throw
- Deadlatch - 1/2"W x 1.0" L x 1/2" throw
- Deadlatches: Zinc alloy latchbolt with Delrin plastic insert, auxiliary bolt zinc die cast, deadlocks latchbolt and prevents manipulation

Part #	Hand	Function	Lock Backset	Case Depth
19-411	Reversible	Deadlatch	31/32"	1-5/8"
19-401	Reversible	Deadlatch	1-1/8"	1-25/32"
19-435	Non- Handed	Deadbolt	31/32"	1-5/8"
19-403	Non- Handed	Deadbolt	1-1/8"	1-25/32"
19-436	Non- Handed	Hookbolt	31/32"	1-5/8"
19-402	Non- Handed	Hookbolt	1-1/8"	1-25/32"
19-405	Non- Handed	Hookbolt	1-1/2"	2-1/4"

Note: Faceplates must be ordered separately. See below for styles and colors.

FACEPLATES

APPLICABLE DOOR STILES

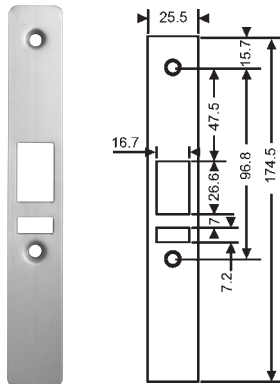

Faceplates for Mortise Lock with Deadlatch

Part #	Door Stile	Finish
19-434	Flat	Aluminum
19-434DBZ	Flat	Bronze
19-413	LH Bevel	Aluminum
19-413DBZ	LH Bevel	Bronze
19-414	RH Bevel	Aluminum
19-414DBZ	RH Bevel	Bronze
19-412	Radius	Aluminum
19-412DBZ	Radius	Bronze
19-415	Radius w/Weather-strip	Aluminum
19-415DBZ	Radius w/Weather-strip	Bronze

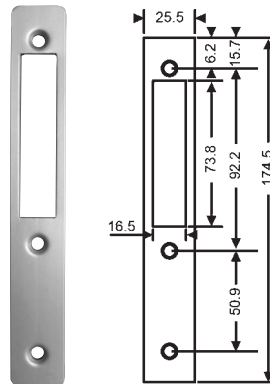

Faceplates for Mortise Lock with Deadbolt

Part #	Door Stile	Finish
19-432	Flat	Aluminum
19-432DBZ	Flat	Bronze
19-420	LH Bevel	Aluminum
19-420DBZ	LH Bevel	Bronze
19-421	RH Bevel	Aluminum
19-421DBZ	RH Bevel	Bronze
19-416	Radius	Aluminum
19-416DBZ	Radius	Bronze
19-423	Radius w/Weatherstrip	Aluminum
19-423DBZ	Radius w/Weatherstrip	Bronze

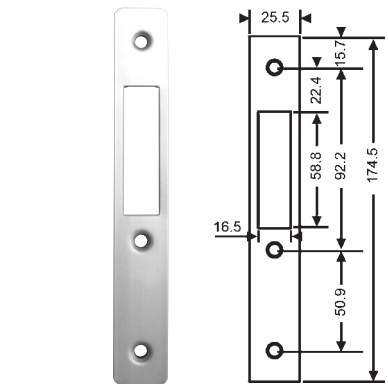

Faceplates for Mortise Lock with Hookbolt

Part #	Door Stile	Finish
19-433	Flat	Aluminum
19-433DBZ	Flat	Bronze
19-418	LH Bevel	Aluminum
19-418DBZ	LH Bevel	Bronze
19-419	RH Bevel	Aluminum
19-419DBZ	RH Bevel	Bronze
19-417	Radius	Aluminum
19-417DBZ	Radius	Bronze
19-422	Radius w/Weatherstrip	Aluminum
19-422DBZ	Radius w/Weatherstrip	Bronze

COMMERCIAL DOOR/STOREFRONT HARDWARE

PUSH/PULL PADDLE



For use with 19-401 and 19-411 deadlatch or any other brand of narrow stile mortise deadlatch. Paddle is four way reversible, select application required by referring to chart below. Handing can be reversed on cam plug by removing C- clip and flipping the cam over and reinstalling C- clip.

SPECIFICATIONS

- Paddle: Extruded aluminum
- Housing: Zinc alloy, black hard coat finish
- Operating assembly: Steel mechanism
- Hand: Non-handed, cam plug included - Reversible
- Standard package: Paddle arm, operating housing, binder posts, cam plug, self adhesive decals and mounting hardware

UNIVERSAL - 4 WAY REVERSIBLE

Type	Operation	Use
PULL - LH		Outside of left hand reverse door or inside of right hand
PUSH - LH		Outside of left hand door or inside of right hand reverse
PULL - RH		Outside of right hand reverse door or inside of left hand
PUSH - RH		Outside of right hand door or inside of left hand reverse

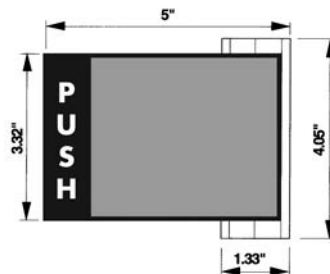

Part #	Finish
19-431	Aluminum
19-431BZ	Bronze

LEVER HANDLE

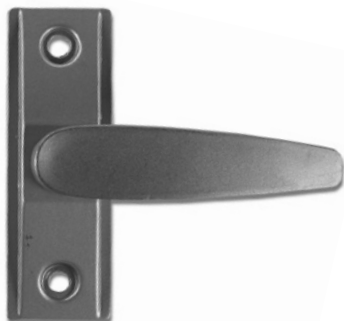

For use with 19-401 and 19-411 deadlatch or any other brand of narrow stile mortise deadlatch. Lever is reversible. Handing can be reversed on cam plug by removing C- clip and flipping the cam over and reinstalling C- clip. Cam plug is secured to lever by 2 hardened steel pins. Cam plug locks into deadlatch by use of set screw in deadlatch.

SPECIFICATIONS

- Lever: Aluminum alloy cast
- Escutcheon: Aluminum 1-3/8" x 4", heavy duty spring mechanism prevents sagging of lever handle
- Spindle: Wrought steel, 1/4" square hardened heat treated
- Hand: Non-handed easily reversible
- Operation: Turning lever downward will activate deadlatch
- Standard package: Cam plug included, all mounting screws, templates and installation instructions

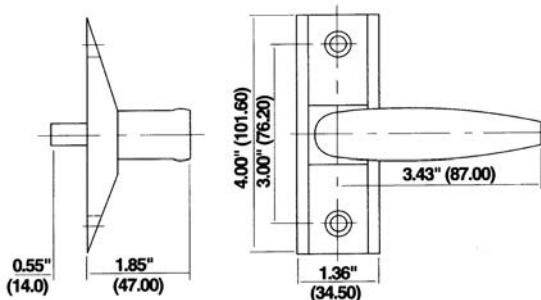

Part #	Finish
19-428	Aluminum
19-428BZ	Bronze

STRIKES

Part #	Description	Finish
19-570	Single Strike	Aluminum
19-571	Double Strike	Aluminum

Both strikes are for use with 19-401 and 19-411 deadlatch or any other brand of narrow stile mortise deadlatch. Order double strike when converting a narrow stile lock to a deadlatch, to cover elongated slot in aluminum frame.

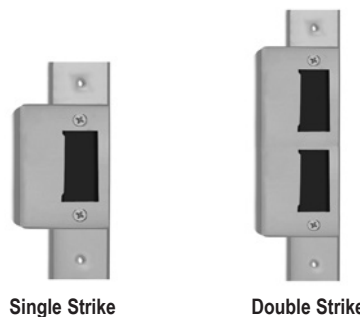

COMMERCIAL DOOR/STOREFRONT HARDWARE

CYLINDERS/TRIM RINGS/ COLLARS

Mortise Cylinder

Part #	Description	Finish	Material
19-573	Key Cylinder (Keyed Alike in Pairs)	Aluminum	Zinc
19-573BZ	Key Cylinder (Keyed Alike in Pairs)	Bronze	Zinc
19-410	Key Cylinder (Keyed Different)	Aluminum	Zinc
19-410BZ	Key Cylinder (Keyed Different)	Bronze	Zinc
19-755	Key Cylinder (Keyed Different)	Aluminum	Brass
19-755BZ	Key Cylinder (Keyed Different)	Bronze	Brass
19-572	Key Cylinder (Keyed Alike)	Aluminum	Zinc
19-572BZ	Key Cylinder (Keyed Alike)	Bronze	Zinc
19-409	Thumbturn Cylinder	Aluminum	Zinc
19-409BZ	Thumbturn Cylinder	Bronze*	Zinc
19-408	Dummy Cylinder	Aluminum	Zinc
19-408BZ	Dummy Cylinder	Bronze	Zinc

*Bronze Cylinder with Aluminum Thumbturn

Rim Cylinders

Part #	Description	Finish	Material
19-568	Keyed Rim Cylinder	Aluminum	Brass
19-568BZ	Keyed Rim Cylinder	Bronze	Brass

Part #	Description	Finish
19-565	Extruded Trim Ring 3/16" (Solid)	Aluminum
19-565BZ	Extruded Trim Ring 3/16" (Solid)	Bronze
19-566	Stamped Trim Ring 3/16" (Hollow)	Aluminum
19-566BZ	Stamped Trim Ring 3/16" (Hollow)	Bronze
19-567	Cylinder Guard Anti-Wrench Collar	Aluminum
19-567BZ	Cylinder Guard Anti-Wrench Collar	Bronze



Keyed Mortise Cylinder



Thumbturn Mortise Cylinder



Dummy Mortise Cylinder



Keyed Rim Cylinder



Extruded Trim Ring (Solid)



Stamped Trim Ring (Hollow)



Cylinder Guard Anti-Wrench Collar

SPECIFICATIONS

- Type: Mortise or Rim
- Finish: Zinc or Brass Mortise, Brass Rim
- Key cylinders - 5 pin Schlage "C" keyway
- Mortise cylinders are 1-5/32" diameter, 1" length
- Cam - MS A/R type, except DUM
- Rim cylinder, flat cut to size tail piece - Keyed different packed with collar ring, mounting plate, 2 screws
- Key options
 - Keyed different
 - Keyed alike
 - Keyed alike in pairs

FLUSH BOLT

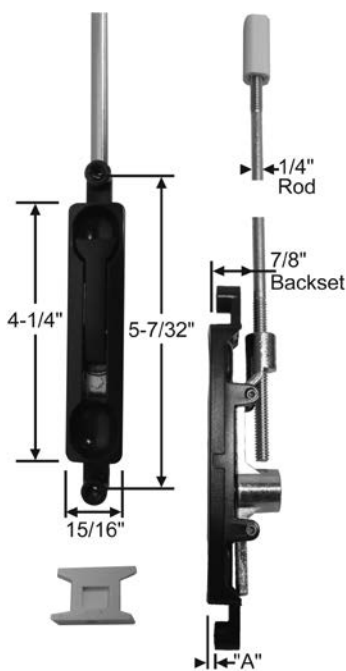

Mortise flush bolt for use on all commercial Storefront and architectural aluminum and glass narrow stile door. Made for easy installation, replaces most brands of Storefront flush bolt.

SPECIFICATIONS

- Spring loaded lever action
- Rod extension- 7/8" throw
- Backset 3/4"
- 5/8" adjustment on rod length
- Face plate dimensions 15/16" x 4-1/2" with 5/32" radius corner
- Square 1/2" nylon tip with beveled corners to prevent binding
- Supplied with nylon keeper and fasteners

Part #	A	Rod Length	Finish
19-426	1/8"	10"	Aluminum
19-426BZ	1/8"	10"	Bronze
19-427	1/4"	10"	Aluminum
19-427BZ	1/4"	10"	Bronze
19-569	1/8"	16"	Aluminum
19-569BZ	1/8"	16"	Bronze

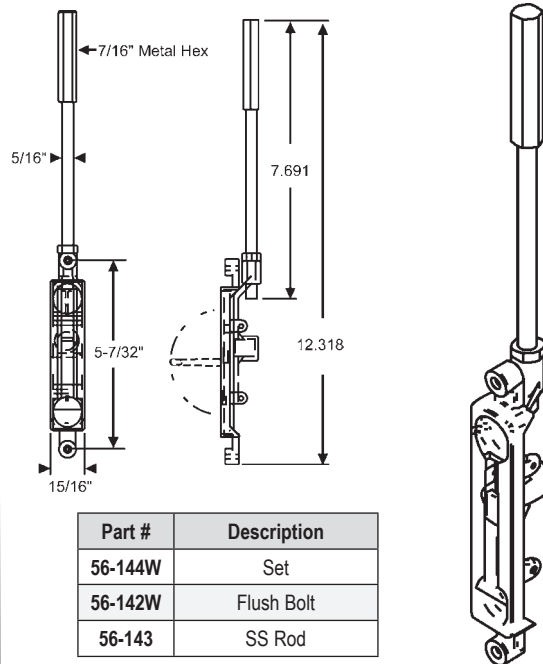

Part #	Description
56-144W	Set
56-142W	Flush Bolt
56-143	SS Rod

TRACO/SECURITY

COMMERCIAL DOOR/STOREFRONT HARDWARE

3/4" OFFSET PIVOT

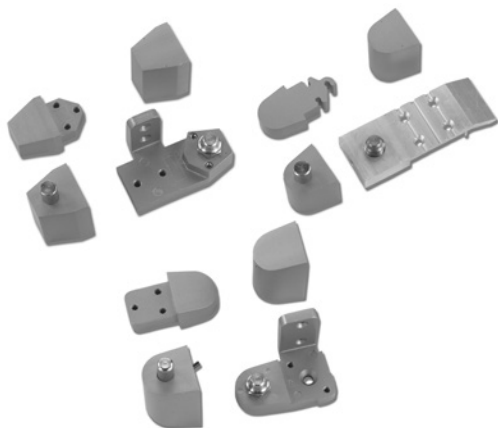

Offset Pivots are used for both flush face frame installation and recessed door applications. Pivots replace most major door manufacturers. Suitable for aluminum doors weighing up to 125 pounds. These pivots are engineered and designed for durability, style and are easy to install. To order pivot: For LHRB door order RH pivot. For RHRB door order LH pivot.

Left Hand Outswing (LH)

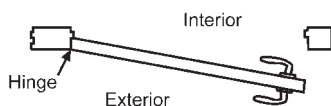

Right Hand Outswing (RH)

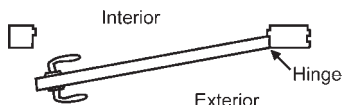

SPECIFICATIONS

- 3/4" offset pivots for aluminum doors and frames
- Weather resistant
- Aluminum case construction
- Vertical adjustment 1/8"
- Full race ball bearing and design, provides smooth operation on bottom pivot door portion
- No sag, entire weight of doors rests on floor mounted pivot portion
- Completely tamper proof, yet easily removable, replaceable in unlocked position

ARCH/VISTAWALL/TUBELITE/ARCADIA STYLE

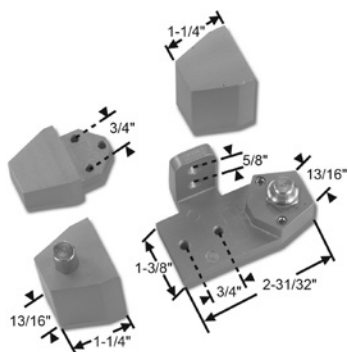

Left Hand Shown

Part #	Application	Hand	Finish
19-259LH	1/8" Recessed Door	LH	Aluminum
19-259RH	1/8" Recessed Door	RH	Aluminum
19-259LHBZ	1/8" Recessed Door	LH	Bronze
19-259RHBZ	1/8" Recessed Door	RH	Bronze
19-736LH	For Flush Face Frame	LH	Aluminum
19-736RH	For Flush Face Frame	RH	Aluminum
19-736LHBZ	For Flush Face Frame	LH	Bronze
19-736RHBZ	For Flush Face Frame	RH	Bronze

Includes Screws

PITCO/PPG STYLE

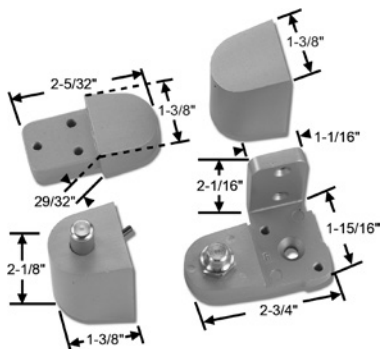

Right Hand Shown

Part #	Application	Hand	Finish
19-734LH	3/32" Recessed Door	LH	Aluminum
19-734RH	3/32" Recessed Door	RH	Aluminum
19-734LHBZ	3/32" Recessed Door	LH	Bronze
19-734RHBZ	3/32" Recessed Door	RH	Bronze

Includes Screws

AMARLITE/REBCO STYLE

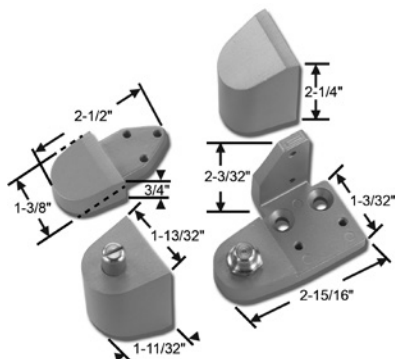

Right Hand Shown

Part #	Application	Hand	Finish
19-255LH	1/8" Recessed Door	LH	Aluminum
19-255RH	1/8" Recessed Door	RH	Aluminum
19-255LHBZ	1/8" Recessed Door	LH	Bronze
19-255RHBZ	1/8" Recessed Door	RH	Bronze

Includes Screws

COMMERCIAL DOOR/STOREFRONT HARDWARE

3/4" OFFSET PIVOT

ALDORA/ARCH STYLE

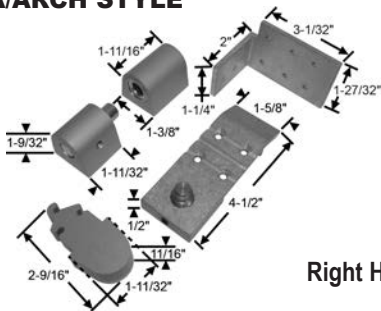

Right Hand Shown

Part #	Application	Hand	Finish
19-406LH	1/8" Recessed Door	LH	Aluminum
19-406RH	1/8" Recessed Door	RH	Aluminum
19-406LHBZ	1/8" Recessed Door	LH	Bronze
19-406RHBZ	1/8" Recessed Door	RH	Bronze

Includes Screws

US ALUM STYLE



Left Hand Shown

Part #	Application	Hand	Finish
19-735LH	1/8" Recessed Door	LH	Aluminum
19-735RH	1/8" Recessed Door	RH	Aluminum
19-735LHBZ	1/8" Recessed Door	LH	Bronze
19-735RHBZ	1/8" Recessed Door	RH	Bronze

Includes Screws

KAWNEER STYLE

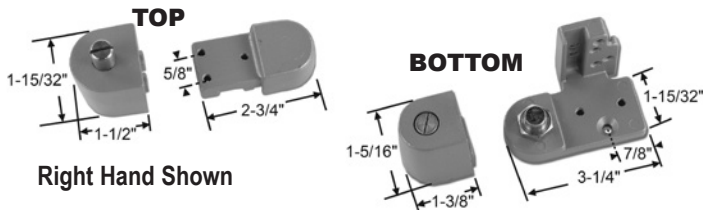

Right Hand Shown

Part #	Application	Description	Hand	Finish
19-424T	1/8" Recessed Door	Top	-	Aluminum
19-424TBZ	1/8" Recessed Door	Top	-	Bronze
19-424LH	1/8" Recessed Door	Bottom	LH	Aluminum
19-424RH	1/8" Recessed Door	Bottom	RH	Aluminum
19-424LHBZ	1/8" Recessed Door	Bottom	LH	Bronze
19-424RHBZ	1/8" Recessed Door	Bottom	RH	Bronze

Includes Screws

KAWNEER/BESAM STYLE

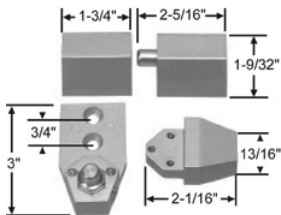

Non-Handed

Part #	Application	Hand	Finish
19-737	1/8" Recessed Door	Non-Handed	Aluminum
19-737BZ	1/8" Recessed Door	Non-Handed	Bronze
19-258	For Flush Face Frame	Non-Handed	Aluminum
19-258BZ	For Flush Face Frame	Non-Handed	Bronze

Includes Screws

OFFSET ALUMINUM PIVOT

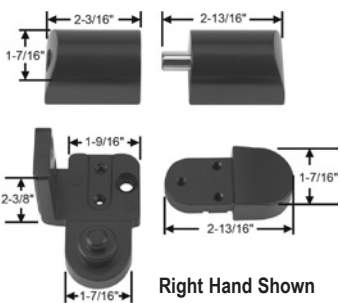

Right Hand Shown

Part #	Hand	Finish
19-612RH	Shown	Aluminum
19-612LH	Opposite	Aluminum
19-612RHBZ	Shown	Bronze
19-612LHBZ	Opposite	Bronze

YKK

INTERMEDIATE ALUMINUM PIVOT

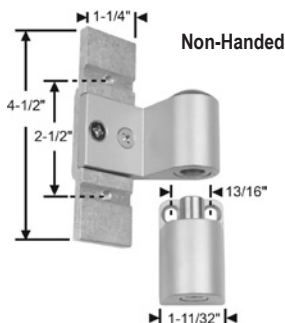

Non-Handed

Part #	Finish
19-404	Bronze
19-404AL	Aluminum

Non-Handed
ARCH ALUMINUM

ADJUSTABLE DOOR PIVOT SET

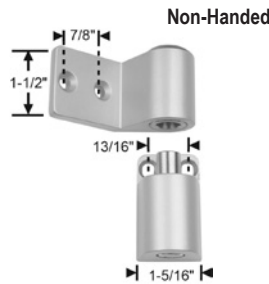

Non-Handed

Part #	Finish
19-407	Bronze
19-407AL	Aluminum

Non-Handed
KAWNEER



Part Number	Finish	Hand
19-1096	Clear	Shown
19-1096BZ	Bronze	Shown
19-1097	Clear	Opposite
19-1097BZ	Bronze	Opposite

REGENT/ TUBELITE

COMMERCIAL DOOR/STOREFRONT HARDWARE

STAINLESS STEEL BUTT HINGES



SPECIFICATIONS

- 4-1/2" x 4"
- Square Corner
- Ball Bearing
- Non Removable Pin
- Button Tip
- Packed & Sold in Pairs

Part #	Finish
8-474SS	Brushed Chrome

Per Pair

DELUXE HINGE KIT



KIT CONTAINS

- (2) Roto Pin Hinges
- (12) One-Way Screws
- (4) Cover strips
- (1) Allen Wrench for vertical adjustment
- (2) 1/8" shims for Flush Door Application
- (1) Instruction Sheet

Deluxe Hinge Kits are the ideal choice for multiple application door solutions, when existing hardware fails. A quick and easy fix for any compromised opening.

Part #	Finish
19-574	Aluminum
19-574BZ	Bronze

SPECIFICATIONS

- For commercial doors up to 500 lbs.
- Non handed full surface applications
- Made from high-tensile aluminum alloy
- Self-lubricating pin rotates on anti-friction bearings
- Hinges securely fastened with tamper proof screws
- Vertical adjustment screw
- Weather resistant
- Doors easily serviced without removal of hinge pin, lift off
- Packed and sold in pairs

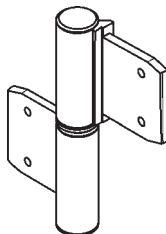
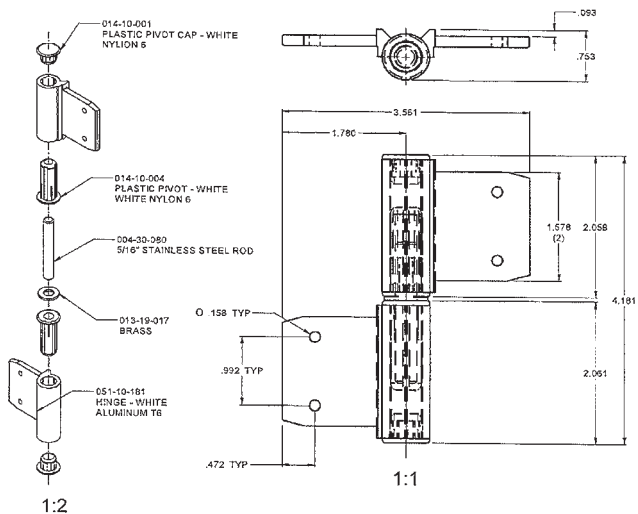

Part #	Finish	Hand
56-141RH	Mill	Shown
56-141LH	Mill	Opposite
56-141RHW	White	Shown
56-141LHW	White	Opposite
56-141RHBZ	Bronze	Shown
56-141LHBZ	Bronze	Opposite

TRACO/SECURITY

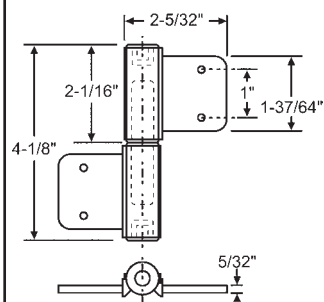

Part #	Hand
56-145LHW	Shown
56-145RHW	Opposite

White
TRACO/SECURITY

CONTINUOUS HINGES

- Available in full mortise and surface mount
- 6063 T6 Aluminum alloy, with interlocking extrusions
- Non-handed design
- 83" length
- Standard duty with 16 thrust type self-lubricating concealed bearings per hinge
- 200 lb. max weight capacity
- High degree of security
- Anodized aluminum after machining
- Through bolt and machine screws fixing
- Template hole patterns
- Minimum 5 Hinges Required or Combination

Full Mortise Type

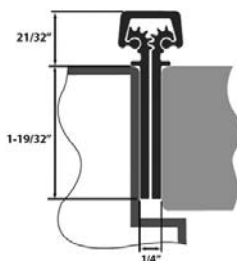

FEATURES

- Full mortise type
- Flush mount
- Each hinge leaf has an alignment stop
- 1/4" clearance between door and frame

Part #	Finish
8-640	Aluminum
8-640BZ	Bronze

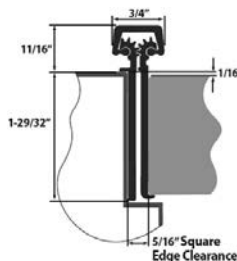

FEATURES

- Full mortise type
- 1/16" door offset
- Door edge guard
- 5/16" clearance between door and frame

Part #	Finish
8-641	Aluminum
8-641BZ	Bronze

Full Surface Type

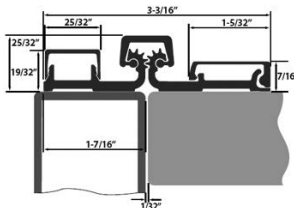
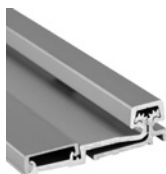

FEATURES

- Full surface continuous hinge
- For narrow (limited) frame applications
- Tamper resistant removable door leaf cover
- 1/32" clearance between door and frame

Part #	Finish
8-639	Aluminum
8-639BZ	Bronze

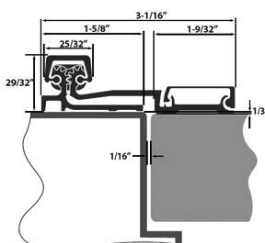

FEATURES

- Full surface continuous hinge
- 1/32" door panel offset
- Tamper resistant removable door leaf cover
- 1/16" clearance between door and frame

Part #	Finish
8-638	Aluminum
8-638BZ	Bronze

COMMERCIAL DOOR/STOREFRONT HARDWARE

DOOR CLOSERS

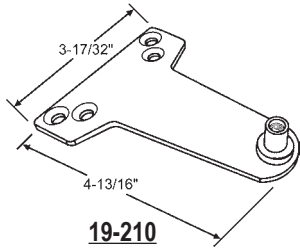
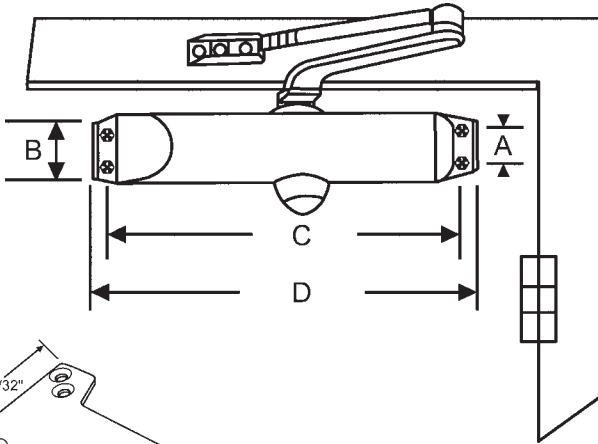

19-210
Parallel Bracket

FEATURES

- Surface mounted interior and exterior
- Size 3 is used on 3 ft. Wide interior door or 2-1/2 ft. Wide exterior door
- Size 4 is used on 4 ft. Wide interior door or 3 ft. Wide exterior door
- Non-handed
- Permanent lubricating hydraulic fluid
- Easy, smooth action
- Housing made of non-corroding aluminum
- Narrow design is perfect for aluminum, glass, wood and other modern doors

Part #	Size	A	B	C	D	Finish
18-70	#3	3/4"	1-3/4"	8-3/16"	8-15/16"	Aluminum (Silver)
18-72	#3	3/4"	1-3/4"	8-3/16"	8-15/16"	Bronze (Gold)
18-74	#3	3/4"	1-3/4"	8-3/16"	8-15/16"	Duranodic (Dk. Brown)
18-68	#4	3/4"	1-3/4"	9-1/16"	9-13/16"	Aluminum (Silver)
18-69	#4	3/4"	1-3/4"	9-1/16"	9-13/16"	Bronze (Gold)
18-73	#4	3/4"	1-3/4"	9-1/16"	9-13/16"	Duranodic (Dk. Brown)

Dimensions for Closers with Backcheck Feature

Part #	Size	A	B	C	D	Finish
18-70BC	#3	3/4"	1-3/4"	8-3/16"	8-15/16"	Aluminum (Silver)
18-68BC	#4	3/4"	1-3/4"	9-1/16"	9-13/16"	Aluminum (Silver)

POWER ADJUSTABLE CLOSER WITH BACK CHECK OR DELAYED ACTION

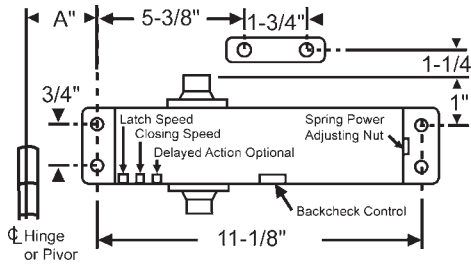
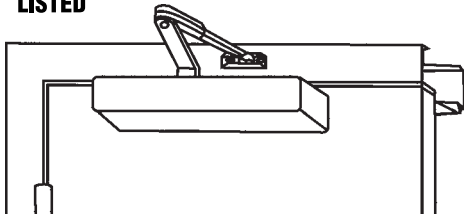

Opening	Dim. "A"
To 120°	7-3/32"
120° - 180°	3-15/16"

Part #	Finish
18-88	Aluminum (Silver)

**ANSI GRADE 1
A - 156.4 STANDARDS
APPLICABLE**

DOOR STOPS

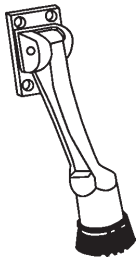

Part #	Color
19-136	Brass
19-137	Aluminum

5" Drop Down Door Stop



Part #	Finish
19-135	Brass
19-138	Aluminum
19-135PB	Bright Brass

19-135T

Screw type tip only.
Black



19-267

Heavy Duty Floor Mount Door Stop. Cast Aluminum. 3" Projector with 2-1/8" Base Plate. 3 Hole Surface Mount. Furnished with Screws

DOOR SILENCER

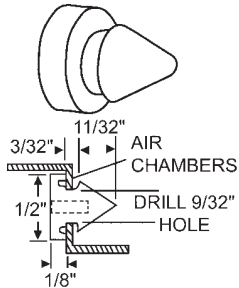

Part #	Finish
19-134	Gray

Rubber Grommet

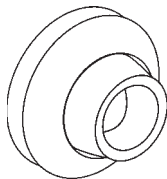

Part #	Finish
19-140	Stainless Brushed
19-140BZ	Dark Bronze
19-140AB	Antique Brass
19-140B	Brass

Screw mount, 2-1/2" diameter with gray vinyl bumper, concealed screw mount. Concave face to fit interior lock button. Furnished with anchor and screw.

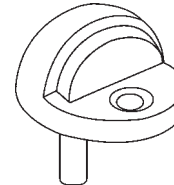

Part #	Finish
19-141	Satin Aluminum
19-141BC	Brushed Chrome

Zinc Die Cast, Low Profile Door Stop. 1-3/4" Base, 1" Height, 1/8" Clearance.

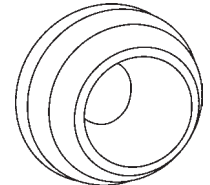

Part #	Color
19-139W	White
19-139	Gray

Adhesive backed, 1-7/8" diameter, gray rubber, peel-off label, pressure sensitive backed.

EXIT DEVICES

SURFACE VERTICAL ROD

Our Surface Vertical Rod panic device is the perfect choice for double doors without mullions. Reversible for right or left hand doors, they are ideal for new construction or renovations. Our panics can be used in conjunction with any of our exit device trims.



Grade - ANSI A156.3 Grade 2

Part #	Finish
19-732	Aluminum
19-732BZ	Bronze
19-732SS	Stainless Steel

FIRE RATED (3 HOURS)

Part #	Finish
19-733	Aluminum
19-733SS	Stainless Steel

Exit Device Trims



Night Latch Handle Set

Part #	Finish
19-752	Aluminum



Dummy Handle Set

Part #	Finish
19-753	Aluminum



Entry Handle Set

Part #	Description
19-1038AL	w/Cylinder
19-1035AL	no Cylinder

Aluminum Finish



Exit Only Plate

Part #	Finish
19-751	Aluminum



Entry Lever

Part #	Finish
19-604AL	Aluminum
19-604BZ	Bronze



Storeroom Lever

Part #	Finish
19-619AL	Aluminum



Passage Lever

Part #	Finish
19-618AL	Aluminum



Entry Ball

Part #	Finish
19-1034AL	Aluminum

FEATURES

- MATERIAL: Extruded anodized aluminum push bar, stainless steel springs
- LATCH: Top Pullman type, Bottom bolt assembly
- DOOR HEIGHT: 7" standard
- BACKSET: 2-3/4" on 4-1/2" minimum stile width - if less than 4-1/2" backset becomes half of the exposed stile width
- STRIKE: Top-surface mounted, Bottom-flat mortise or into threshold, vertical/rim application use DBLST double dr. strike
- PROJECTION: 2-1/2" - 1-7/8" dogged
- STILE: 4-1/2" minimum
- HANDING: Reversible, non-handed
- DOOR THICKNESS: 1-3/4" standard
- DOOR WIDTH: 36", can be field sized to 30"
- MOUNTING HEIGHT: Recommended installation at 41" from finished floor to center line of push rail.
- FASTENERS: Furnished with sheet metal and machine screws
- CYLINDER NOT INCLUDED
- DOGGING: 1/2 turn hex key

TOUCH BAR

"Touch bar" style exit devices are suitable for all doors (aluminum, hollow metal, or wood) where there is no projection on the face. Manufactured of extruded anodized aluminum, the touch bar is durable enough for the most demanding applications. Rim cylinder is not included and needs to be ordered separately.

Grade - ANSI A156.3 Grade 2.

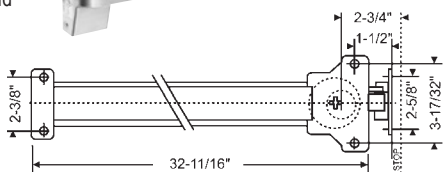

Part #	Finish
19-730	Aluminum
19-730BZ	Bronze
19-730SS	Stainless Steel

FIRE RATED (3 HOURS)

Part #	Finish
19-731	Aluminum
19-731SS	Stainless Steel

FEATURES

- MATERIAL: Extruded anodized aluminum push bar, stainless steel springs
- LATCH: Stainless Steel, 3/4" throw - 5/8" deadlatch
- BACKSET: 2-3/4" Covers 161 prep, includes latch & Strike filler plates
- STRIKE: Surface mounted for 5/8" stop with shim
- PROJECTION: 2-1/2" - 1-7/8" dogged
- STILE: 4-1/4" minimum
- HANDING: Reversible, non-handed
- DOOR THICKNESS: 1-3/4" standard
- DOOR WIDTH: 36", can be field sized to 30"
- MOUNTING HEIGHT: Recommended installation at 41" from finished floor to center line of push rail.
- FASTENERS: Furnished with sheet metal and machine screws
- DOGGING: 1/2 turn hex key
- CYLINDER NOT INCLUDED (order separately)

Exit Device Trims



Rim Cylinder

Part #	Finish
19-568	Aluminum
19-568BZ	Bronze

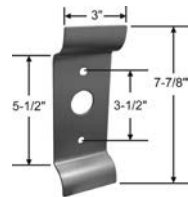

Pull Trim

Part #	Finish
19-749	Aluminum



Dummy Pull Trim

Part #	Finish
19-750	Aluminum



Entry Ball

Part #	Finish
19-1034AL	Aluminum



Entry Lever

Part #	Finish
19-604AL	Aluminum



Storeroom Lever

Part #	Finish
19-619AL	Aluminum



Passage Lever

Part #	Finish
19-618AL	Aluminum



Night Latch Handle Set

Part #	Finish
19-752	Aluminum



Dummy Handle Set

Part #	Finish
19-753	Aluminum



Entry Handle Set

Part #	Description
19-1038AL	w/Cylinder
19-1035AL	no Cylinder

Aluminum Finish



Exit Only Plate

Part #	Finish
19-751	Aluminum

NARROW STILE EXIT DEVICES

CONCEALED VERTICAL ROD

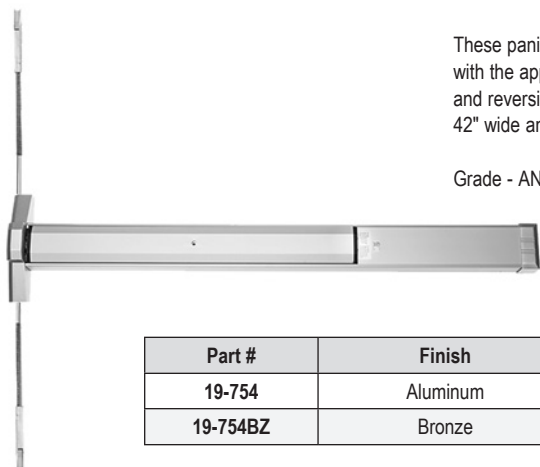

These panic devices blend the utility of a vertical rod application with the appearance of a traditional panic device. It is non-handed and reversible with a contoured cross bar that will fit doors up to 42" wide and can be field sized to accommodate narrow doors.

Grade - ANSI A156.3 Grade 2

Part #	Finish
19-754	Aluminum
19-754BZ	Bronze

FEATURES

- MATERIAL: Contoured anodized aluminum cross bar, stainless steel springs
- LATCH CASE: 1-1/4" wide x 7-1/4" long
- DOOR HEIGHT: 7" standard
- BACKSET: Center template on narrow door stile
- STRIKE: Top-flat mortise, Bottom-flat mortise or directly through threshold
- PROJECTION: 4-3/4"
- STILE: 1-7/8" minimum
- HANDING: Reversible, non-handed
- DOOR THICKNESS: 1-3/4" standard
- DOOR WIDTH: Up to 42"
- MOUNTING HEIGHT: 35-11/16" from floor to center line of the bottom latch case mounting stud
- FASTENERS: Furnished with sheet metal, machine screws and shoulder mounting studs with set screws
- CYLINDER: Accepts mortise type
- DOGGING: Inside- push up dog pin and rotate with screwdriver, Outside- by key cylinder

Exit Device Trims



Brass Mortise Cylinder

Part #	Finish
19-755	Aluminum
19-755BZ	Bronze

Zinc Mortise Cylinder

Part #	Finish
19-410	Aluminum
19-410BZ	Bronze



Cylinder Mounting Trim

Part #	Finish
19-756	Aluminum

*For exterior key application must order 19-756/19-756BZ. Insert mortise cylinder in mounting trim and secure with locking ring nut, included.

TOUCH BAR



These "crash bar" style exit devices are suitable for narrow, medium or wide stile aluminum and hollow metal doors. Contoured cross bar that will fit doors up to 42" wide and can be field sized to accommodate narrow doors.

Grade - ANSI A156.3 Grade 2

Part #	Finish	Hand
19-747RH	Aluminum	Right
19-747LH	Aluminum	Left
19-748RHBZ	Bronze	Right
19-748LHBZ	Bronze	Left

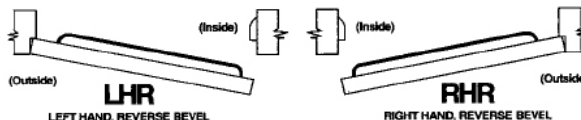

*For Left Hand Reverse Door; order RH device
*For Right Hand Reverse Door; order LH device

FEATURES

- MATERIAL: Contoured anodized aluminum cross bar, stainless steel springs
- LATCH CASE: 1-1/4" wide x 7-1/4" long with 1/2" stainless throw
- BACKSET: 1-5/32" from edge of door to center line of device
- STRIKE: Rim mounted roller strike with shim
- PROJECTION: 4-3/4"
- STILE: 1-7/8" minimum
- HANDING: Handed, please specify RH or LH
- DOOR THICKNESS: 1-3/4" standard
- DOOR WIDTH: Up to 42"
- MOUNTING HEIGHT: Recommended installation at 39-13/32" from floor to center line of latch or strike assemblies
- FASTENERS: Furnished with sheet metal, machine screws and shoulder mounting studs with set screws
- CYLINDER: Accepts rim cylinder only
- DOGGING: Inside-push up dog pin rotate with screwdriver, Outside-by key cylinder

Exit Device Trims



Rim Cylinder

Part #	Finish
19-568	Aluminum
19-568BZ	Bronze



Exit Only Plate

Part #	Finish
19-751	Aluminum

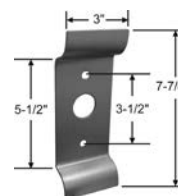

Pull Trim

Part #	Finish
19-749	Aluminum

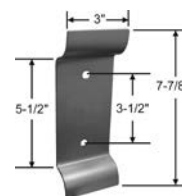

Dummy Pull Trim

Part #	Finish
19-750	Aluminum

*All trim applications for new door or existing hole less than 1-3/16"

COMMERCIAL DOOR/STOREFRONT HARDWARE

DOOR PULLS

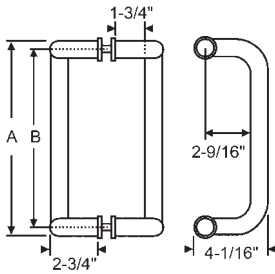

Part #	A	B	Finish
19-1103BSS	11"	10"	Brushed Stainless
19-1103PSS	11"	10"	Polished Stainless
19-1104BSS	13"	12"	Brushed Stainless
19-1104PSS	13"	12"	Polished Stainless

- Offset Back to Back Tempered Glass Mount Commercial
- Material Specifications: Stainless Steel
- Glass Thickness: 3/8" to 3/4"
- Construction: 1" (25mm) Diameter
- Offset: 3"
- Glass Fabrication: 2 X 5/8" diameter holes - 10" CTC or 12" CTC

Includes:

- 2 Through bolts for Glass mounting
- 4 Metal Washers - 1-1/4" diameter with rubber gaskets

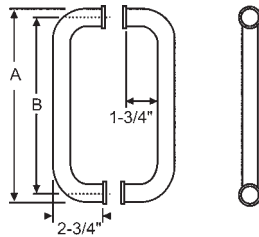

Part #	A	B	Finish
19-1101BSS	11"	10"	Brushed Stainless
19-1101PSS	11"	10"	Polished Stainless
19-1102BSS	13"	12"	Brushed Stainless
19-1102PSS	13"	12"	Polished Stainless

- In-line Back to Back Tempered Glass Mount Commercial
- Pull Sizes: 10" or 12"
- Material Specifications: Stainless Steel
- Application: Heavy Glass Doors
- Glass Thickness: 3/8" to 3/4"
- Construction: 1" (25mm) Diameter
- Glass Fabrication: 2 X 5/8" diameter holes - 10" CTC or 12" CTC

Includes:

- 2 Through bolts for Glass mounting
- 4 Metal Washers - 1-1/4" diameter with rubber gaskets

Rockwell Glass Mounted Straight Combination Push and Pull Handles

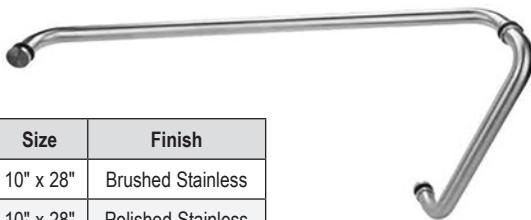

Rockwell Glass Mount Straight Combination Pulls are for Use with 3/8" to 3/4" (10 - 19 mm) Glass thickness

- Fits 3/8" - 3/4" (10 - 19 mm) Glass
- Diameter: 1" (25mm)
- Material: Stainless Steel or Brass Tubing
- Glass Fabrication: 3-5/8" (16 mm)
- Diameter Holes: 28" (711 mm CTC)

** TEMPERED GLASS Use Only

Includes:

- 2 Through bolts for Glass mounting
- 4 Metal Washers - 1-1/4" diameter with rubber gaskets

Part #	Size	Finish
19-1106BSS	10" x 28"	Brushed Stainless
19-1106PSS	10" x 28"	Polished Stainless
19-1107BSS	12" x 28"	Brushed Stainless
19-1107PSS	12" x 28"	Polished Stainless

Rockwell Dustproof Keeper with Mounting Plate

Part #	Finish
19-1116AL	Aluminum
19-1116B	Black
19-1116BSS	Brushed Stainless
19-1116PSS	Polished Stainless



Rockwell Dustproof Keeper with Mounting Plate available in four Finishes in Locking models. Accepts 5/8" (16 mm) Diameter Plunger Bolt

- Fits 5/8" (16 mm) Plunger from these or similar devices
- Function: Locking
- Material: Stainless Steel

Includes:

- 2 Flat Head Screws
- (Requires a 1" diameter hole drilled 2" into door for installation)

GLASS CLEANER, ADHESIVES, LUBRICANTS AND GUN FOAMS

FOAMING GLASS CLEANER



- Industrial Strength
- Cleans glass, windows, mirrors, windshields, enamel surfaces, chrome, tile, porcelain and other hard surfaces.
- Sprays in any position (360° Valve)
- Dissolves dirt, grease, grit and grime
- Non-ammoniated
- Guaranteed to leave no film - "Streak Free"
- Safe on tinted glass, plastic and mirrors
- Contains cosmetic-grade alcohol for best performance
- Superior quality at competitive pricing
- Patent Pending Formulation

59-101
19 oz. Can

"Private Label Spray-X Foam Glass Cleaner as your own!"
Just provide us with your logo and website and you can have your own Spray-X private label cans.



Part #	Can Size	Pallet Contents
59-101P50	19 oz. Can	600 Cans per Pallet (50 Cases, 12 cans per case)
59-101P450	4 oz. Can	600 4 oz. Cans per pallet (50 Cases, 12 cans per case)

LUBRICANTS

"L.C. Wax" Alumaslick Aluminum Lubricant & Liquid Masking

"L.C. Wax" Alumaslick Aluminum Lubricant & Liquid Masking cleans and lubricates



aluminum better than anything. Quick penetration/ release and long lasting lubrication. Cleans corrosion and tarnish, protects from salt corrosion, reduces wear, stops squeaks, bumps, klunks, clinks.

Part #	Size
59-50	11 oz. Can
59-50-1	1 Gal Can

Alum-A-Lub Lubricating Cleaner

Alum-A-Lub cleaner is the "All Purpose" lubricating cleaner that can be used on all products that stick or squeak. Alum-A-Lub assures ease of operation and a "like new" appearance for metal windows, doors, locks, hinges, cabinets and more. Simply spray and wipe away dirt, grime and gummy residue left by other lubricants. A must for your shop, workstation, home, maintenance department or garage. 12 per case



Part #	Size
59-5	9.4 oz. Can
59-5-1	15 oz. Can

SODAL ADHESIVES, GUN FOAMS & CLEANERS

Silirub N1 is a Premium Grade 100%, Neutral Cure Silicone

- Permanently flexible
- Easy to apply
- Excellent adhesion to glass, vinyl, wood, aluminum & many more
- Low odor
- UV resistant
- No shrinkage
- AAMA compliant

Applications:

- Building and construction joints
- Top sealing at glazing jobs
- Suitable as backbedding compound as well as weather sealant
- Joints with high movement between different building materials
- Sealing between treated wood, metal, PVC profiles and glass

Surfaces:

- Type: all usual building surfaces
- State of surface: clean, dry, free of dust and grease
- Preparation: Prime porous surfaces with Primer, no primer required for non-porous surfaces.



Part #	Color	Size
59-137W	White	10.1 oz. Tube
59-137	Clear	10.1 oz. Tube
59-138W	White	20 oz. Sausage

We recommend a preliminary compatibility test, especially on PVD and powder coated materials.

Note: Custom Color Matching Available. Three Case Minimum (12 Per Case). Check with Your Account Manager for Available Colors and Lead Times.



59-132
Gun Foam

Soudafoam Door & Window is a minimal expansion, one component, moisture curing PU foam

- 24 oz. Aerosol Can
- Minimal Expansion
- Easy Application
- Excellent Adhesion to Almost all Substrates
- Excellent Thermal and Acoustical Insulation
- No Shrinkage
- AAMA Compliant



59-134
Genius Gun with Foam

Soudafoam Door & Window is a minimal expansion, one component, moisture curing PU foam and gun all in one.

- 20 oz. Aerosol Can
- Integrated Gun System
- Reusable
- Minimal Expansion
- Easy Application
- Excellent Adhesion to Almost all Substrates
- Excellent Thermal and Acoustical Insulation
- No Shrinkage



59-136
Gun & Foam Cleaner

Soudal Gun & Foam Cleaner is a solvent cleaner specifically designed for cleaning of uncured PU foam

- 12 oz. aerosol can
- For Hands and Tools
- Cleans Uncured Solvent
- Removes Oil, Adhesive, Etc.



59-135
Cleaning Wipes

SwipeX are solvent based cleaning wipes for uncured sealants & adhesives.

- Non-Woven Wipes Impregnated with a Mixture of Solvents, Biodegradable Bon-Ionic Surfactants and Skin Emollients
- Suitable for all Non-Porous Surfaces
- For Hands and Tools
- Cleans Uncured Solvent
- Removes Oil, Adhesive, Etc.
- 100 Wipes

CARRYMATE® Non-Slip Panel Grips

Protects your hands, prevents back strain and improves productivity!



The unloading and transport of sheet materials to their installation sites is not only time-consuming but also very strenuous. Smooth surfaces make it difficult to securely carry the material, especially through narrow passages or across uneven grounds. Carrymate® Safety Grips are used in pairs and each grip is capable of holding up to 220 lbs, which makes them suitable for moving a wide variety of materials.

- The point of contact to the material can be wherever it is most suitable for each user's height
- Both users can walk forward and face the direction they are going in
- The user's lifting arm and back remain straight
- The user's other hand is now free to support the material or to move obstacles to the side (open doors, etc.)

The clamping system self-adjusts to the width of the material and securely holds it in place without damaging its surface. All parts of the Carrymate® Transport Grips that touch the load are covered with a special coating so that even the most polished materials will not be scratched. The ergonomically designed carrying grip provides a secure hold and even during turns and pivots the user can easily hold on to the load.

- Sturdy aluminium construction
- Self-adjusting non-slip Clamps
- Holds up to 220 lbs. per grip - sold in pairs
- Cushioned shaft prevents damage to the carried load

Suitable for:

- Glass/IGUs (double/triple)
- Sheet metal
- Plywood/Dry Wall
- PVC
- Solar modules
- Natural stone, etc.

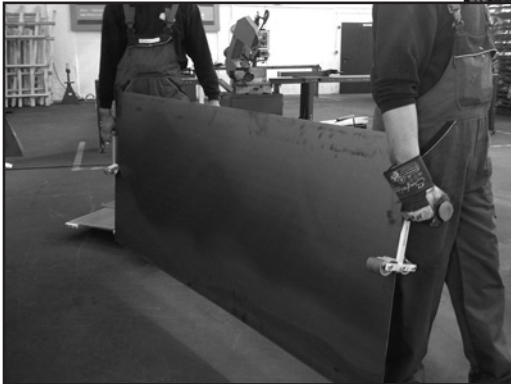

59-177

CARRYMATE® 5 Span width 0-3.15" (Pair)



59-177X

Carrymate® X-Spanders. Simply slip the X-Spanders over the clamps! No glue is necessary! Sold in packs of 8.

TOUCHLESS TOOLS

Used On:

Swing Door Handles
ATM Buttons
Gas Pump Buttons
Includes Bottle Opener
With Keychain Link Ability



59-184 (Generic)
Touchless Tool



59-184-PL (Private Label)
"Private Label" Touchless Tool
Minimum Order 250 pieces.

FOOT PULL FOR SWING DOORS



91-671

Door Foot Pull
Includes Screws and Label. 3" Depth



HANDS-FREE ARM DOOR PULL



19-1371

Hands-Free Arm Door Pull. Satin Chrome Finish

The 1st Touch-Screen “Window and Door Parts” Kiosk for Retail Stores!

- Store visitors can shop over 36,000+ popular and hard to find and obsolete window and door parts using the touch-screen online store and printed catalog.
- Choose from a Counter Kiosk station or Floor Kiosk.
- User-friendly Kiosk makes shopping for parts simple:
 1. Store visitors find the part they need.
 2. Add to cart.
 3. Enter a credit card, and the part is delivered direct to your store or drop ship to your customer.
- No need to stock hundreds of regional specialty hardware items.
- Promote this service to your residential and commercial accounts to increase store traffic.
- Small enough to fit on most counters. Floor models are a perfect fit for an end-cap unit.
- Call Account Manager for more details.

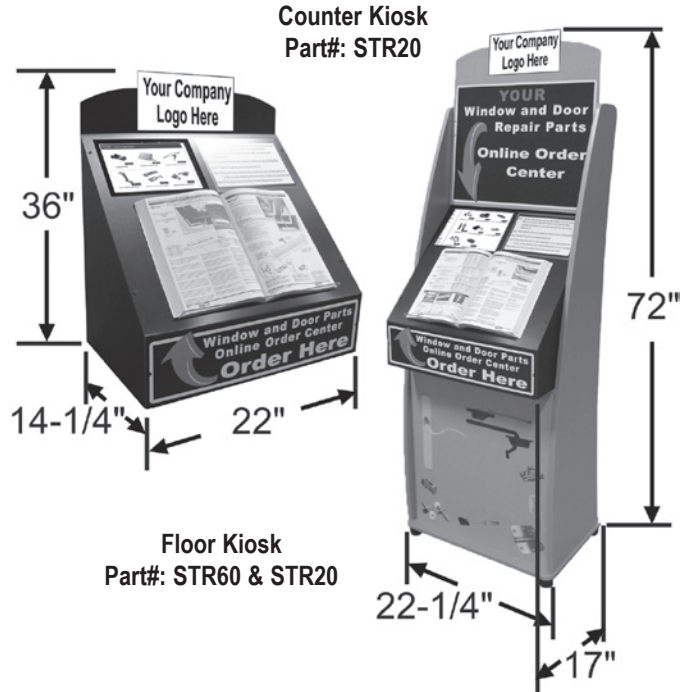

FIBALATH FIBERGLASS LATH



FibaLath™

Fiberglass alternative to metal lath
Attaches like metal lath and meets
IBC and IRC building code requirements

Introducing FibaLath™, the fiberglass alternative to metal lath

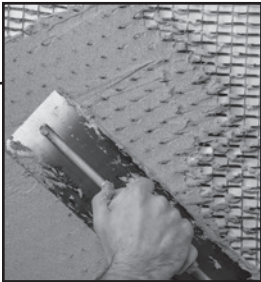

ADFORS FibaLath is an innovative fiberglass lath designed for use in stucco applications, and exterior/interior walls of manufactured stone and brick façades. The three dimensional profile of FibaLath is self-furring and is attached the same way as metal lath.

Additional Features & Benefits include:

- Alkali-resistant for long term performance. Will not rust or rot.
- Non-directional which means it can be applied vertically or horizontally
- Over 4 times lighter weight than metal lath (per unit area)

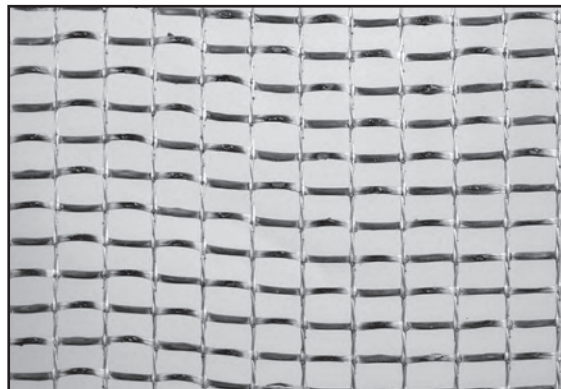
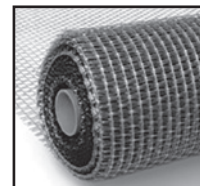

Why should you make the switch to FibaLath?

- Lightweight and pliable. Easier and safer to cut, lift, and carry than metal lath
- Self-furring, three dimensional profile is attached the same way as metal lath
- Meets International Building Code® (IBC) and International Residential Code® (IRC) requirements (Intertek Code Compliance Research Report CCRR-0249)



Part #	Roll Size	Roll Area
69-207-FLX	39 in x 25 ft	81 ^{ft} ²
69-206-FLX	39 in x 55 ft	180 ^{ft} ²
69-205-FLX	39 in x 150 ft	491 ^{ft} ²

TERMS AND CONDITIONS

TERMS	Net 30 days.
CREDIT	 &  accepted
MINIMUM	\$25.00 Excluding shipping and handling.
PRICING	All pricing subject to change. SBI reserves the right to make price adjustments due to changing market conditions, product discontinuation, manufacturers price changes, and errors in advertisements.
ORDERING	Our catalog has been designed to make ordering as easy as possible. However, if you are not a 100% sure that you have found the part you need - PLEASE SEND A SAMPLE. To help expedite your orders, please use our part numbers and include your account number on all purchase orders. Customers must specify at time of order if back orders should be canceled. Otherwise back orders will be released routinely and not subject to return.
QUOTATIONS	All quotations good for 30 days, unless otherwise specified. If an item is not shown in our catalog, PLEASE SEND A SAMPLE with any available information - such as name of manufacturer or brand name of their window or door, the type of window or door; e.g., sliding or casement. It is also important to know what function the part performs. If you are presently using a substitute item for your original part - please send both parts. We may be able to provide the original. The above information will help us reduce research time for hard to find and obsolete parts.
FINISHING	Standard finishes will be provided. Please specify if you require a particular finish.
HANDING INFORMATION	Strybuc Industries determines whether an item is left handed or right handed - by viewing it from the inside looking out. Items on your right will be right hand - items on your left will be left hand.
SUBSTITUTION	In order to satisfy need and provide our customers with the most economical and highest quality parts, we may replace catalog items with working substitutes from time to time.
CUSTOM MADE SPECIAL ORDER MERCHANDISE	In order to serve you better, we offer our machine shop facilities for items no longer available. A deposit may be required for custom made/special order material. We will not accept any returns or cancellations for custom made parts, therefore a written or faxed Purchase Order is required.
FREIGHT	No freight allowance. Shipping and handling charges are added to invoice. For "drop-ship" orders to residential buildings, higher shipping rates applied.
SHIPPING	Stock items - within 24 hours upon receipt of order. Non-stock items 3 to 8 weeks or as specified. FedEx® Delivery Service - Faster delivery options for all packages up to 20lbs. delivered within the Continental U.S.; (1) Economy Two Day SM Service. (2) Standard Overnight® Service for next day delivery. (3) Priority Overnight® Service delivered by 10:30 a.m. the next morning. Ask your Account Manager for current delivery costs.
DROP SHIP	SBI Express - Order Today, Install Tomorrow! A new program to "drop ship" directly to your customers using any of the above FedEx® Delivery Services
RETURNS	No material will be accepted without a Return Goods Authorization number (RGA# must appear outside of all cartons). Please call Account Manager for RGA#. A 25% Handling/Restocking charge will be assessed to all returns for reasons other than Strybuc errors. All returns must be made within 60 days of invoice date. Custom Made/Special Orders are not subject to return.
CLAIMS	It is your responsibility to inspect all shipments for shortages and damages (concealed or otherwise). If damage has occurred it is your responsibility to file a claim with the carrier, claims for shortages are to be filed with Strybuc Industries. All claims are to be made within 10 days.
DISCLAIMER	Photos and illustrations in this catalog are intended only to give an idea of what a product looks like. It is to identify that products use, and does not imply that the item is a genuine product of the said original manufacturer.
COPYRIGHT	© 2022 PGI. No part of this catalog may be reproduced without the express written consent of Strybuc Industries.

Fraction / Decimal / Millimeter Conversion Chart

Fraction	Decimal	Millimeter	Fraction	Decimal	Millimeter	Fraction	Decimal	Millimeter
1/64	0.0156	0.3969	1 1/64	1.0156	25.7969	2 1/64	2.0156	51.1969
1/32	0.0313	0.7938	1 1/32	1.0313	26.1938	2 1/32	2.0313	51.5938
3/64	0.0469	1.1906	1 3/64	1.0469	26.5906	2 3/64	2.0469	51.9906
1/16	0.0625	1.5875	1 1/16	1.0625	26.9875	2 1/16	2.0625	52.3875
5/64	0.0781	1.9844	1 5/64	1.0781	27.3844	2 5/64	2.0781	52.7844
3/32	0.0938	2.3813	1 3/32	1.0938	27.7813	2 3/32	2.0938	53.1813
7/64	0.1094	2.7781	1 7/64	1.1094	28.1781	2 7/64	2.1094	53.5781
1/8	0.1250	3.1750	1 1/8	1.1250	28.5750	2 1/8	2.1250	53.9750
9/64	0.1406	3.5719	1 9/64	1.1406	28.9719	2 9/64	2.1406	54.3719
5/32	0.1563	3.9688	1 5/32	1.1563	29.3688	2 5/32	2.1563	54.7688
11/64	0.1719	4.3656	1 11/64	1.1719	29.7656	2 11/64	2.1719	55.1656
3/16	0.1875	4.7625	1 3/16	1.1875	30.1625	2 3/16	2.1875	55.5625
13/64	0.2031	5.1594	1 13/64	1.2031	30.5594	2 13/64	2.2031	55.9594
7/32	0.2188	5.5563	1 7/32	1.2188	30.9563	2 7/32	2.2188	56.3563
15/64	0.2344	5.9531	1 15/64	1.2344	31.3531	2 15/64	2.2344	56.7531
1/4	0.2500	6.3500	1 1/4	1.2500	31.7500	2 1/4	2.2500	57.1500
17/64	0.2656	6.7469	1 17/64	1.2656	32.1469	2 17/64	2.2656	57.5469
9/32	0.2813	7.1438	1 9/32	1.2813	32.5438	2 9/32	2.2813	57.9438
19/64	0.2969	7.5406	1 19/64	1.2969	32.9406	2 19/64	2.2969	58.3406
5/16	0.3125	7.9375	1 5/16	1.3125	33.3375	2 5/16	2.3125	58.7375
21/64	0.3281	8.3344	1 21/64	1.3281	33.7344	2 21/64	2.3281	59.1344
11/32	0.3438	8.7313	1 11/32	1.3438	34.1313	2 11/32	2.3438	59.5313
23/64	0.3594	9.1281	1 23/64	1.3594	34.5281	2 23/64	2.3594	59.9281
3/8	0.3750	9.5250	1 3/8	1.3750	34.9250	2 3/8	2.3750	60.3250
25/64	0.3906	9.9219	1 25/64	1.3906	35.3219	2 25/64	2.3906	60.7219
13/32	0.4063	10.3188	1 13/32	1.4063	35.7188	2 13/32	2.4063	61.1188
27/64	0.4219	10.7156	1 27/64	1.4219	36.1156	2 27/64	2.4219	61.5156
7/16	0.4375	11.1125	1 7/16	1.4375	36.5125	2 7/16	2.4375	61.9125
29/64	0.4531	11.5094	1 29/64	1.4531	36.9094	2 29/64	2.4531	62.3094
15/32	0.4688	11.9063	1 15/32	1.4688	37.3063	2 15/32	2.4688	62.7063
31/64	0.4844	12.3031	1 31/64	1.4844	37.7031	2 31/64	2.4844	63.1031
1/2	0.5000	12.7000	1 1/2	1.5000	38.1000	2 1/2	2.5000	63.5000
33/64	0.5156	13.0969	1 33/64	1.5156	38.4969	2 33/64	2.5156	63.8969
17/32	0.5313	13.4938	1 17/32	1.5313	38.8938	2 17/32	2.5313	64.2938
35/64	0.5469	13.8906	1 35/64	1.5469	39.2906	2 35/64	2.5469	64.6906
9/16	0.5625	14.2875	1 9/16	1.5625	39.6875	2 9/16	2.5625	65.0875
37/64	0.5781	14.6844	1 37/64	1.5781	40.0844	2 37/64	2.5781	65.4844
19/32	0.5938	15.0813	1 19/32	1.5938	40.4813	2 19/32	2.5938	65.8813
39/64	0.6094	15.4781	1 39/64	1.6094	40.8781	2 39/64	2.6094	66.2781
5/8	0.6250	15.8750	1 5/8	1.6250	41.2750	2 5/8	2.6250	66.6750
41/64	0.6406	16.2719	1 41/64	1.6406	41.6719	2 41/64	2.6406	67.0719
21/32	0.6563	16.6688	1 21/32	1.6563	42.0688	2 21/32	2.6563	67.4688
43/64	0.6719	17.0656	1 43/64	1.6719	42.4656	2 43/64	2.6719	67.8656
11/16	0.6875	17.4625	1 11/16	1.6875	42.8625	2 11/16	2.6875	68.2625
45/64	0.7031	17.8594	1 45/64	1.7031	43.2594	2 45/64	2.7031	68.6594
23/32	0.7188	18.2563	1 23/32	1.7188	43.6563	2 23/32	2.7188	69.0563
47/64	0.7344	18.6531	1 47/64	1.7344	44.0531	2 47/64	2.7344	69.4531
3/4	0.7500	19.0500	1 3/4	1.7500	44.4500	2 3/4	2.7500	69.8500
49/64	0.7656	19.4469	1 49/64	1.7656	44.8469	2 49/64	2.7656	70.2469
25/32	0.7813	19.8438	1 25/32	1.7813	45.2438	2 25/32	2.7813	70.6438
51/64	0.7969	20.2406	1 51/64	1.7969	45.6406	2 51/64	2.7969	71.0406
13/16	0.8125	20.6375	1 13/16	1.8125	46.0375	2 13/16	2.8125	71.4375
53/64	0.8281	21.0344	1 53/64	1.8281	46.4344	2 53/64	2.8281	71.8344
27/32	0.8438	21.4313	1 27/32	1.8438	46.8313	2 27/32	2.8438	72.2313
55/64	0.8594	21.8281	1 55/64	1.8594	47.2281	2 55/64	2.8594	72.6281
7/8	0.8750	22.2250	1 7/8	1.8750	47.6250	2 7/8	2.8750	73.0250
57/64	0.8906	22.6219	1 57/64	1.8906	48.0219	2 57/64	2.8906	73.4219
29/32	0.9063	23.0188	1 29/32	1.9063	48.4188	2 29/32	2.9063	73.8188
59/64	0.9219	23.4156	1 59/64	1.9219	48.8156	2 59/64	2.9219	74.2156
15/16	0.9375	23.8125	1 15/16	1.9375	49.2125	2 15/16	2.9375	74.6125
61/64	0.9531	24.2094	1 61/64	1.9531	49.6094	2 61/64	2.9531	75.0094
31/32	0.9688	24.6063	1 31/32	1.9688	50.0063	2 31/32	2.9688	75.4063
63/64	0.9844	25.0031	1 63/64	1.9844	50.4031	2 63/64	2.9844	75.8031
1"	1.0000	25.4000	2"	2.0000	50.8000	3"	3.0000	76.2000