



## Rail Mate (AP-101)

Installation Instructions – Please read the entire installation sheet prior to installation.

**NOTE: Rail Mate is designed as an assist rail, intended for some weight bearing. Rail Mate is designed for right or left-hand mounting on most double, triple and quad entry manual steps. Instructions are written for a left-hand mount.**

**Equipment needed:** electric/battery drill,  $\frac{5}{16}$ " drill bit,  $\frac{7}{16}$ " (or adjustable) wrench, 2 clamps/vice grips

**Carton contents:** see reverse side

- 1) While facing your steps, identify mounting surface on left side plate of entry steps. (Note: camper siding may need to be trimmed away from step for rail installation/mounting purposes) For right hand mount, follow these same directions but use the mounting surface on the right side plate of entry steps.
- 2) Large pre-existing holes in the mounting plate are designed to accommodate bolt/obstruction patterns for Hickory Springs and Flexco steps. With steps in the open or close position, attach mounting plate (using clamps or vice grips) to the side plate of your steps, aligning the mounting plate's bottom edge with the bottom edge of the step side plate. The mounting plate's right edge should extend out from the front edge of the step side plate approximately two inches to allow for rail clearance. There are six screw holes in the mounting plate to accommodate your application, but only (5) holes need to be drilled in your step side plate. Drill holes (using  $\frac{5}{16}$ " drill bit) through side plate of entry steps to accommodate the (5) desired bolt locations, being careful not to drill through and step arms or other step components.
- 5) Attach mounting plate using the (5)  $\frac{3}{4}$ " long bolts and (5) lock nuts. (Note: bolt heads should be on the inside of the step side plate, lock nuts on the outside of the step plate to avoid interference with the open/close function of the steps). Remove clamps/vice grips.
- 6) Mount L-bracket to mounting plate with long side of L going away from your steps, using (4) carriage bolts and (4) lock nuts (see picture below). Please note, the 4 attachment locations are identified as the (4) square holes on the L-bracket.
- 7) Based on clearance required for proper open/close function of your RV door, U-bracket mounting placement will vary. It is recommended that you initially attach the U-bracket to the middle set of top and bottom holes on each side of the L-bracket (use remaining carriage bolts and loosely tightened lock nuts).
- 8) Attach foot plate to bottom of drop leg using enclosed foot plate screw, noting one side of the foot plate is indented to allow the foot plate screw to remain flush against the plate.
- 9) Slide hand rail tube into U-bracket on mounting bracket assembly, supporting the rail weight. At this point, open/close your RV door to ensure proper clearance between the door and rail. Remove rail. If necessary, adjust U-bracket right or left to accommodate your specific needs. Once you have finalized the U-bracket location and tightened everything securely, re-insert the rail and tighten the bent bolt (provided at the rear of the U-bracket) to ensure a secure fit.
- 10) Once rail is securely in receiver tube, lower the drop leg while lifting up on the hand rail to create tension between the foot and the ground (use lock pin in leg to secure). If none of the pre drilled holes accommodate your application, you can drill additional holes in the drop leg. Please note, do not drill holes too close together or you will weaken the integrity of the metal.
- 11) To prevent tampering, it is suggested a lock (not provided) is slid through the hole in the rail tube nearest your RV, below the U-bracket.
- 12) Secure your rail using the 18" Velcro strap by connecting the top corner of the hand rail and the grab handle on your RV. Tighten the strap to eliminate play in your railing.

**Please note: Mounting bracket is designed to remain on your RV during transportation, handrail is NOT.**

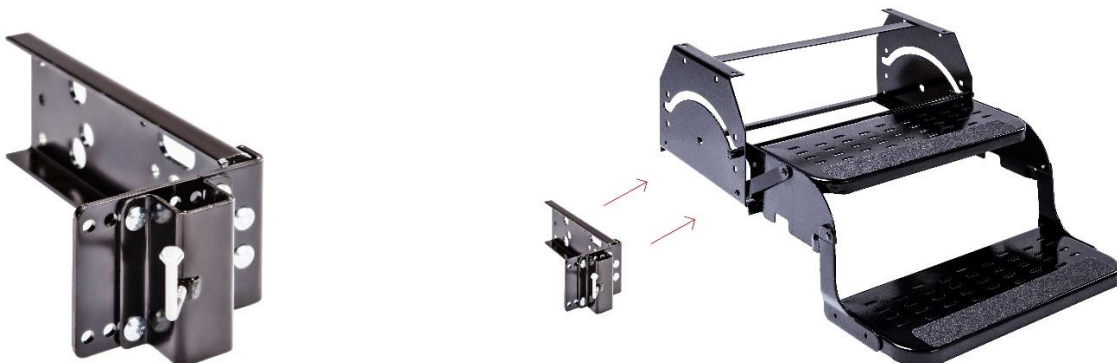

# Rail Mate (AP-101) Carton Contents

The 4031 hardware kit, consisting of Items 7750-103, 7750-107, 7750-109 & 4030 hardware kit is available to order. Please note, this DOES NOT include Items 5115-002, 5114-DL & FST-9915

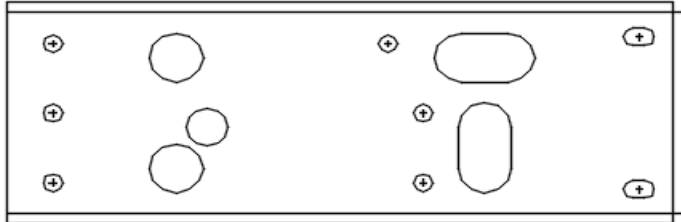

(1) mounting plate

Item 7750-103

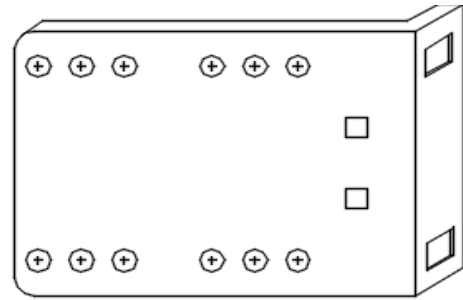

(1) L-bracket

Item 7750-107

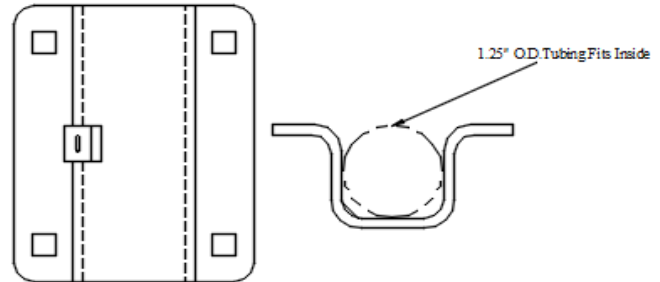

(1) U-bracket

Item 7750-109

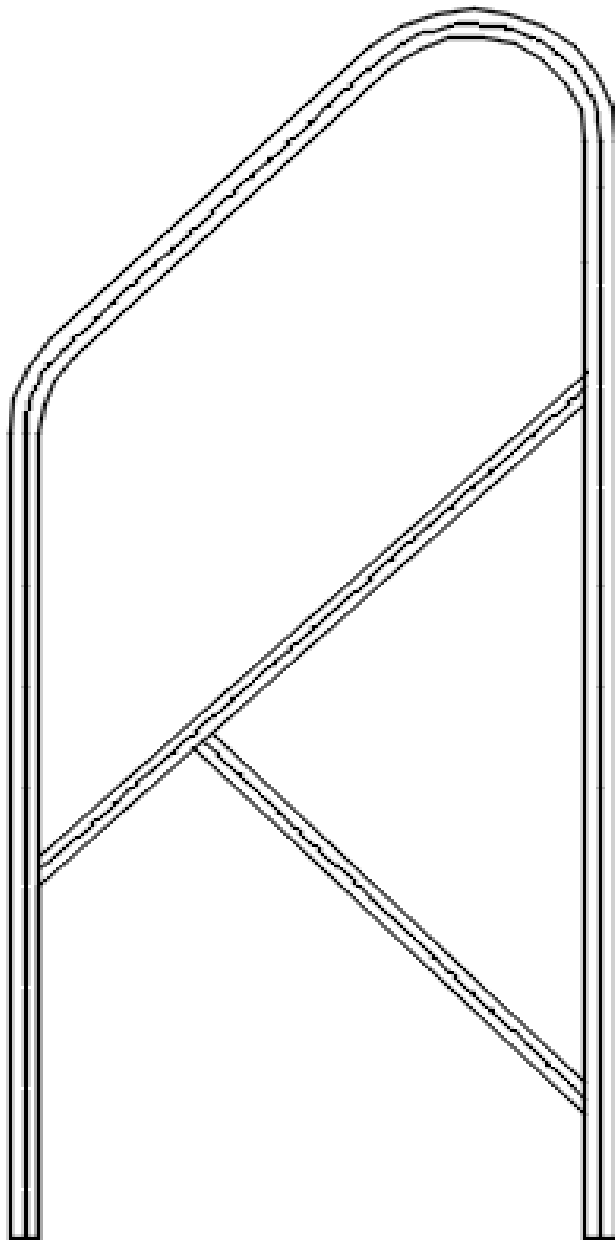

(1) rail with drop leg and lock pin (not shown)

Items 5115-002, 5114-DL, FST-9915

## 4030 Hardware Kit

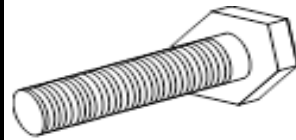

(5) 3/4" long bolts

Item FST-1620

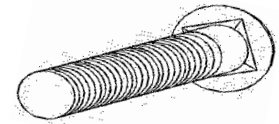

(8) carriage bolts

Item FST-1622

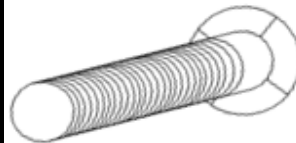

(1) foot plate screw

Item FST-1616

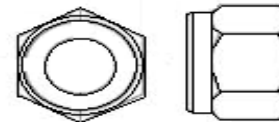

(13) lock nuts

Item FST-1680

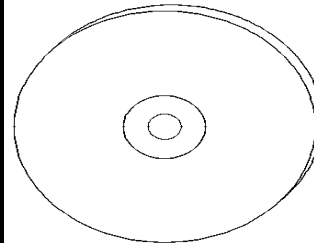

(1) foot plate

Item 7750-105

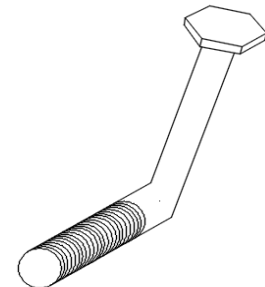

(1) bent bolt

Item 7750-111

Also included: 18" double sided hook and loop strap