

Align template to rear edge of recess

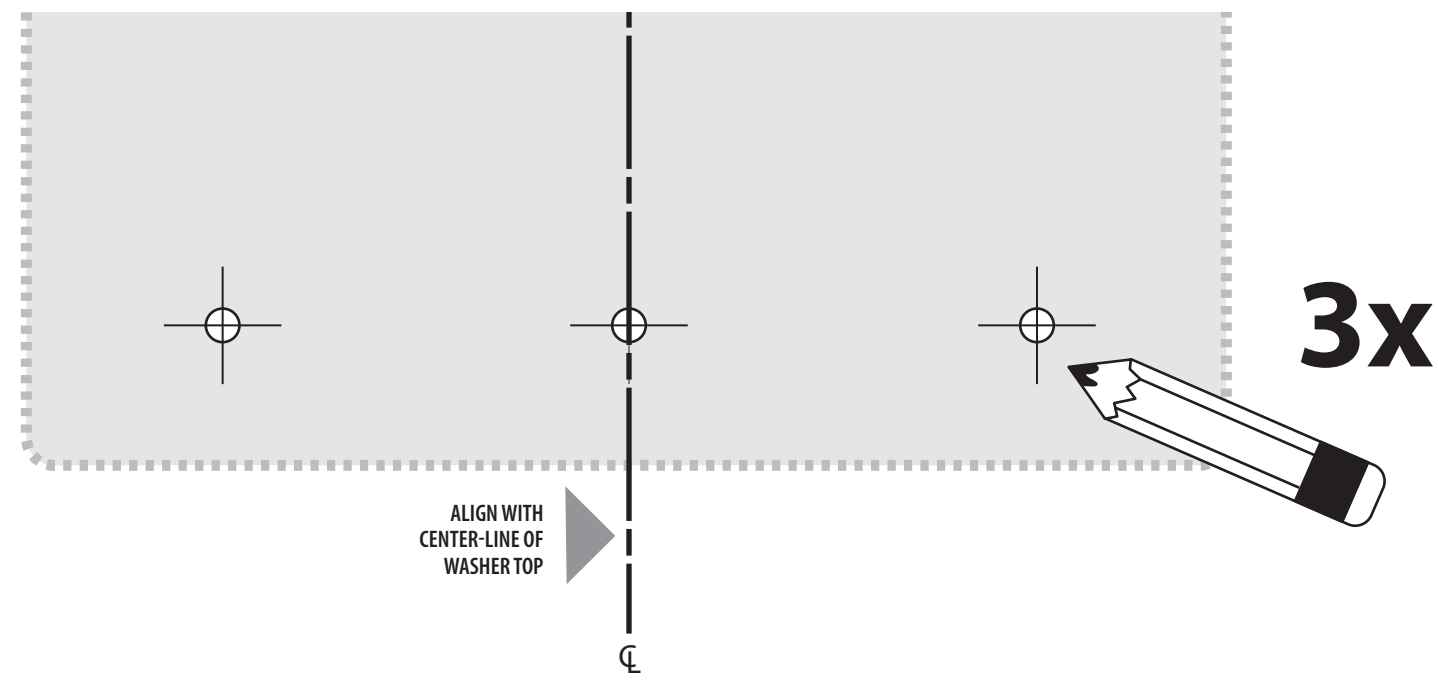

Align template to rear edge of recess

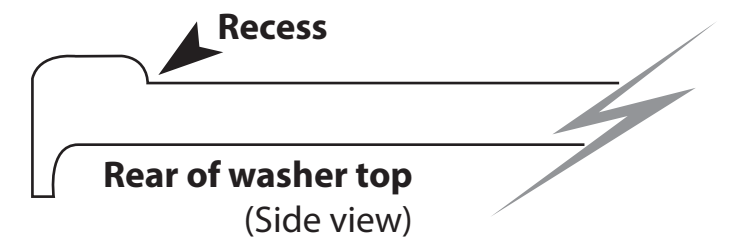

### SK03 STACK KIT MOUNTING INSTRUCTIONS AND PATTERN

FOR USE WITH TVM63X OR DV6400X 110V ELECTRIC DRYER & ARWXF129W OR WFL1300XD FRONT-LOADING WASHER

1x **C**

1x **E** **F**

1x **E** **G**

7x **D** **D**  
SIZE 3/32"  
**DRILL BIT NOT INCLUDED**

3x **F** Self-Tapping

**TVM63XNA or DV6400X Dryer**

**ARWXF129W or WFL1300XD Washer**

**UL**

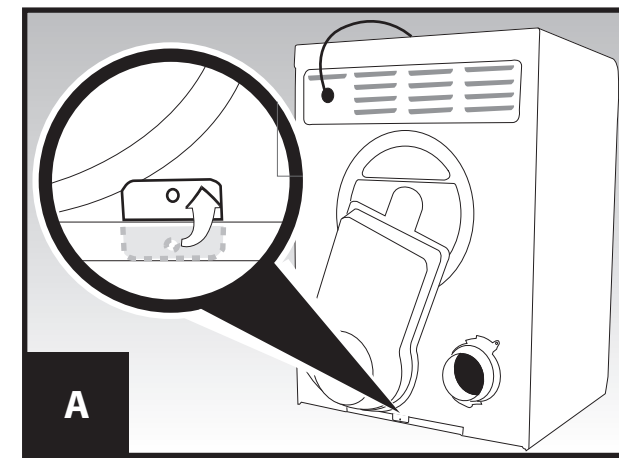

**A** Bend tab up so rear bracket can be inserted later

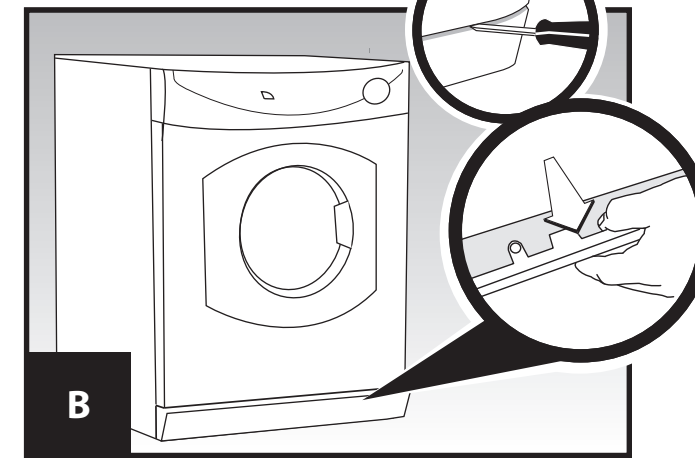

**B** Remove dryer kick-plate

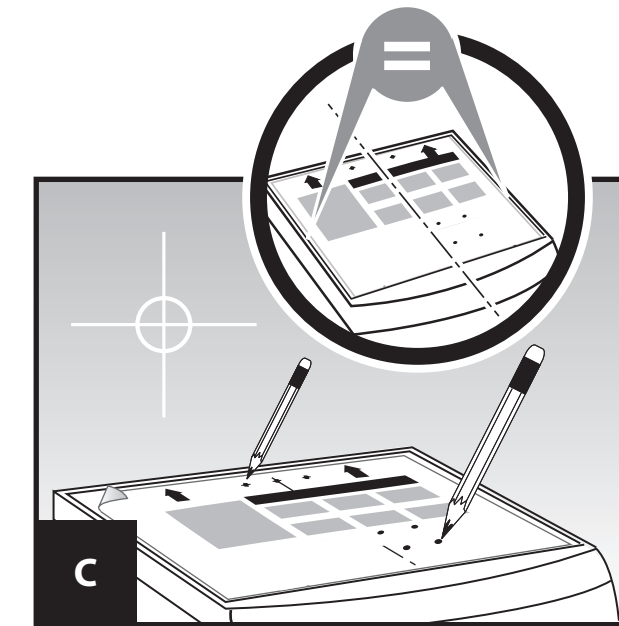

**C** Use pattern to mark drill hole positions on washer top

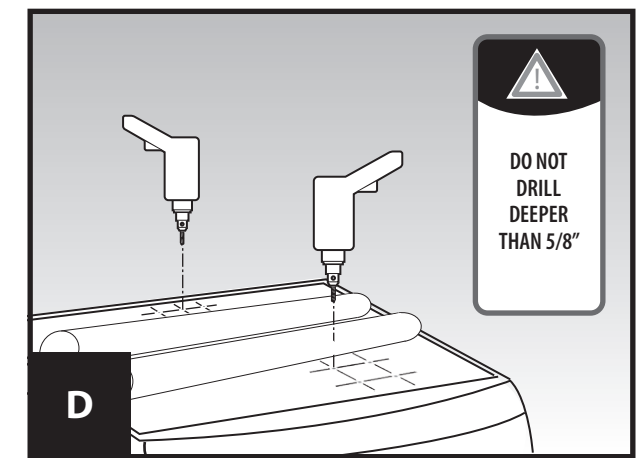

**D** Drill holes into washer top

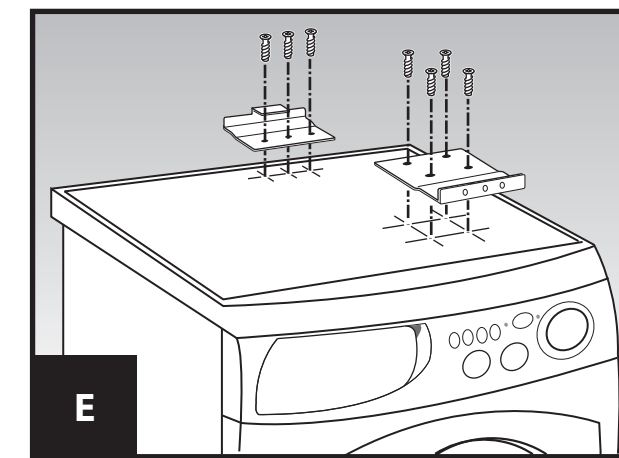

**E** Secure brackets to washer top

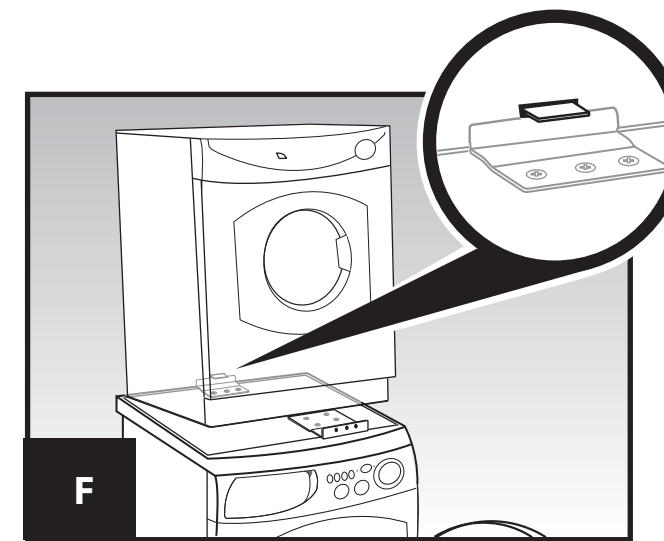

**F** Insert rear bracket into dryer

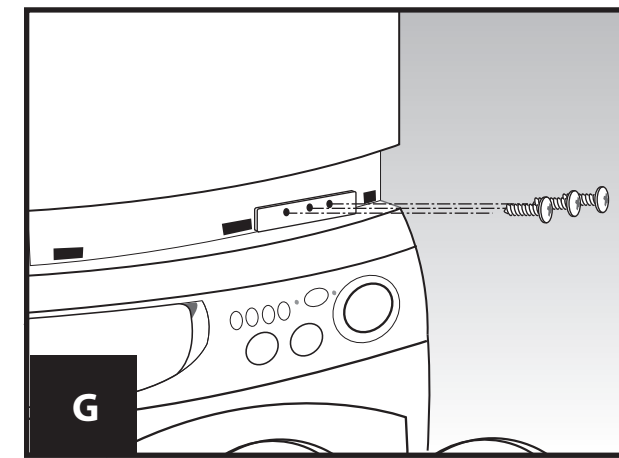

**G** Secure front bracket to dryer

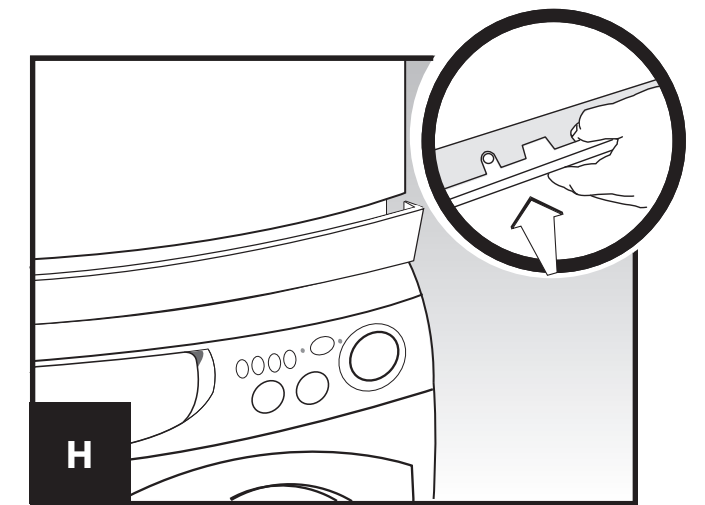

**H** Reinstall dryer kick-plate

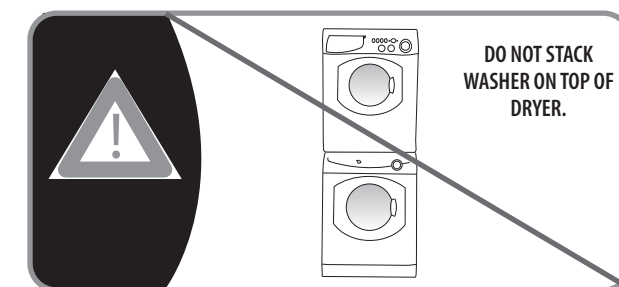
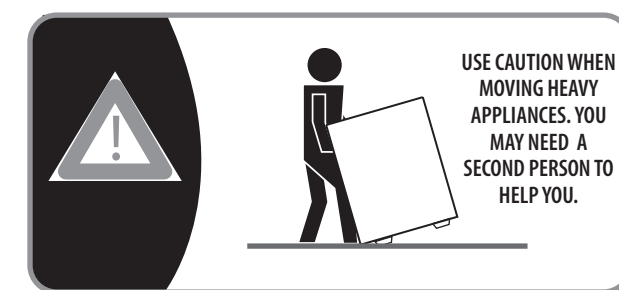

4x

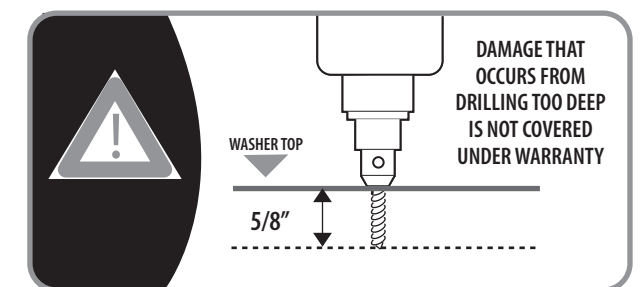
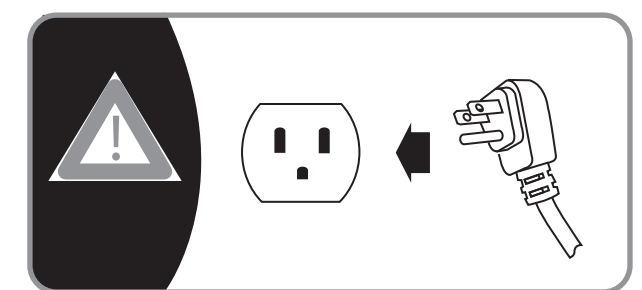
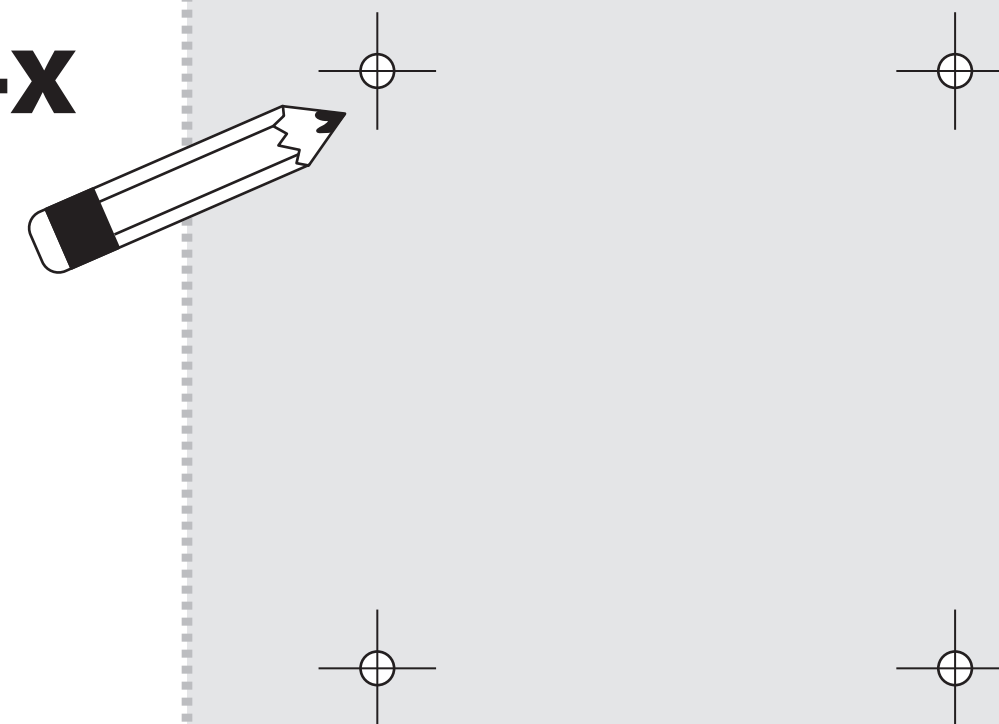

USE ONLY SCREWS FROM KIT