

sparco[®]

2
0

/ 2020

2
0





Our products have been used by champions for decades, but that's not our finishline. We are dedicated to creating new products to produce the next generations of racing legends.



TRUE RACING DNA

Since day one, driving towards the future



THE LOOK OF A CHAMPION.

SUITS INDEX

MADE IN ITALY

16

PRIME+ (ON DEMAND)  **NEW**



HOMOLOGATION	LAYERS	WEIGHT g/m ²	SIZES	CUSTOMIZATION
FIA 8856-2018	4	320-350	ON DEMAND	ON DEMAND



001152SP

PRIME



HOMOLOGATION	LAYERS	WEIGHT g/m ²	SIZES	CUSTOMIZATION
FIA 8856-2000	3	240-270	48-66	CUSTOM EASY ON DEMAND

001133..BO 001133..NR

EXTREMA-S **NEW**

HOMOLOGATION	LAYERS	WEIGHT g/m ²	SIZES	CUSTOMIZATION
FIA 8856-2000	HOCOTEXI4L	290-320	48-66	ON DEMAND

001151H..BI 001151H..NR

EAGLE 2.0 **NEW**

HOMOLOGATION	LAYERS	WEIGHT g/m ²	SIZES	CUSTOMIZATION
FIA 8856-2018	HOCOTEXI4L	300-330	48-66	ON DEMAND





001136H..BNRS 001136H..RNBO 001136H..BBNR 001136H..NNBO

X-LIGHT **NEW**

HOMOLOGATION	LAYERS	WEIGHT g/m ²	SIZES	CUSTOMIZATION
FIA 8856-2000	3	270-300	48-66	CUSTOM EASY 3D CONFIGURATOR ON DEMAND







001165X..BNGC 001165X..GNRS 001165X..RBNR 001165X..BBCE 001165X..NRBI

VICTORY **NEW**

HOMOLOGATION	LAYERS	WEIGHT g/m ²	SIZES	CUSTOMIZATION
FIA 8856-2000 SFI 3.2A/5	HOCOTEXI4L	330-360	48-66	ON DEMAND





001135H..BNRS 001135H..BGBL 001135H..GNAR 001135H..NGBO

VICTORY YOUTH (ON DEMAND) **NEW**

HOMOLOGATION	LAYERS	WEIGHT g/m ²	SIZES	CUSTOMIZATION
FIA 8856-2000 SFI 3.2A/5	HOCOTEXI4L	330-360	120-150	ON DEMAND





001135HYSP 001135HYSP 001135HYSP 001135HYSP

GI

17

COMPETITION+

HOMOLOGATION	LAYERS	WEIGHT g/m ²	SIZES	CUSTOMIZATION
FIA 8856-2000	3	300-330	48-66	3D CONFIGURATOR ON DEMAND







001128..BINR 001128..RSBI 001128..BMBI 001128..NRBI

COMPETITION+ LADY

HOMOLOGATION	LAYERS	WEIGHT g/m ²	SIZES	CUSTOMIZATION
FIA 8856-2000	3	300-330	38-50	ON DEMAND



001128L..NRBF

VINTAGE CLASSIC

HOMOLOGATION	LAYERS	WEIGHT g/m ²	SIZES	CUSTOMIZATION
FIA 8856-2000	3	300-330	48-66	ON DEMAND



001128V..BIRS

COMPETITION

HOMOLOGATION	LAYERS	WEIGHT g/m ²	SIZES	CUSTOMIZATION
FIA 8856-2000	3	330-360	48-66	CUSTOM EASY ON DEMAND





001137..BINR 001137..RSBI 001137..BMBI 001137..NRBI

SPRINT **NEW**

HOMOLOGATION	LAYERS	WEIGHT g/m ²	SIZES	CUSTOMIZATION
FIA 8856-2000 SFI 3.2A/5	2	360-390	48-66	CUSTOM EASY 3D CONFIGURATOR ON DEMAND







001092..RSNR 001092..BELNR 001092..BMBI 001092..NRRS 001092..NR

SPRINT YOUTH (ON DEMAND) **NEW**

HOMOLOGATION	LAYERS	WEIGHT g/m ²	SIZES	CUSTOMIZATION
FIA 8856-2000 SFI 3.2A/5	2	360-390	120-150	ON DEMAND







001092YSP 001092YSP 001092YSP 001092YSP 001092YSP

ONE

HOMOLOGATION	LAYERS	WEIGHT g/m ²	SIZES	CUSTOMIZATION
SFI 3.2A/1	1	170-200	XS-XXL	NOT CUSTOMIZABLE



001058..NR

THE INDICATED WEIGHT IS CALCULATED ON THE AVERAGE VALUE OF THE ANALYZED SAMPLES, THEREFORE IT IS POSSIBLE THAT IT WILL UNDERGO VARIATIONS.



Ultralight double-sliding zip.

Extra-flat seams.

Seamless cuffs.

PRIME+

NEW

NEW FIA 8856-2018



MANUFACTURER: SPARCO
MODEL: R557
HOM. NO: DC.XXX.XX-O
FIA STANDARD: 8856-2018

HOMOLOGATION: FIA8856-2018 ■ **WEIGHT:** 320-350 G/M² ■ **SIZES:** ON DEMAND
LAYERS: 4 ■ **CUSTOMIZATION:** ON DEMAND



Ultra-thin collar



Elasticated and more lightweight half floating arm construction



Elasticated back panel



001152..SP

PRIME



MANUFACTURER: SPARCO
MODEL: R546-PRIME SP16-SPEC1
HOM. NO: RS.281.16
FIA STANDARD: 8856-2000

HOMOLOGATION: FIA8856-2000 ▪ **WEIGHT:** 240-270 G/M² ▪ **SIZES:** 48-66
LAYERS: 3 ▪ **CUSTOMIZATION:** CUSTOM EASY - ON DEMAND



Ultralight double-sliding zip.

Extra-flat seams.

Seamless cuffs.

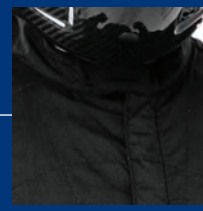

Ultra-thin collar



Elasticated half floating arm construction

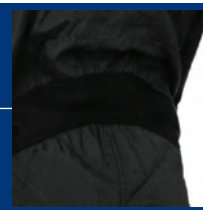

Elasticated back panel



001133..BO



001133..NR

EXTREMA-S

NEW



MANUFACTURER: SPARCO
MODEL: R542 EXTREMA RS-10
HOM. NO: RS.271.15
FIA STANDARD: 8856-2000

HOMOLOGATION: FIA8856-2000 ▪ **WEIGHT:** 290-320 G/M² ▪ **SIZES:** 48-66
LAYERS: 4-IN-1 THANKS TO HOCOTEX 14L TECHNOLOGY ▪ **CUSTOMIZATION:** ON DEMAND



Belt.

Hidden pockets.

Seamless cuffs.

Extra-flat seams.



Extraction handle

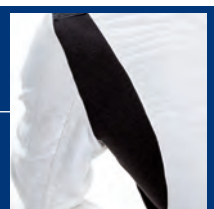

Elasticated half floating arm construction



Soft elasticated back panel

HOCOTEX 14L[®]

PAG.7



3 TIMES MORE BREATHABLE



30% MORE FIRE RESISTANT



30% HINNER



001151H..BI



001151H..NR

EAGLE 2.0

NEW

NEW FIA 8856-2018



MANUFACTURER: SPARCO
MODEL: R555
HOM. NO: DC.031.19-O
FIA STANDARD: 8856-2018

HOMOLOGATION: FIA8856-2018 ▪ **WEIGHT:** 300-330 G/M² ▪ **SIZES:** 48-66
LAYERS: 4-IN-1 THANKS TO HOCOTEX 14L TECHNOLOGY ▪ **CUSTOMIZATION:** ON DEMAND

Elasticated fully floating arm construction.



Hidden pockets.

Extra-flat seams.

Seamless cuffs.



Breathable lateral inserts



Elasticated anti-abrasion rear panel and lateral inserts



Elasticated and breathable inner thigh insert

HOCOTEX 14LX

PAG.7

3 TIMES MORE BREATHABLE

30% MORE FIRE RESISTANT

30% HINNER



001136H..BNRS



001136H..RNBO



001136H..BBNR



001136H..NNBO

X-LIGHT

NEW



MANUFACTURER: SPARCO
MODEL: R546
HOM. NO: RS.281.16
FIA STANDARD: 8856-2000



27

HOMOLOGATION: FIA8856-2000 ▪ **WEIGHT:** 270-300 G/M² ▪ **SIZES:** 48-66
LAYERS: 3 ▪ **CUSTOMIZATION:** CUSTOM EASY - 3D CONFIGURATOR - ON DEMAND

Elasticated fully floating arm construction.

Elasticated anti-abrasion back panel.

Anti-abrasion inserts on elbows

Breathable lateral inserts

Elasticated and breathable inner thigh insert

Extra-flat seams.

Hidden pockets.

Seamless cuffs.



001165X..BNGC

001165X..RBNR

001165X..BBCE



001165X..GNRS



001165X..NRBI

VICTORY

NEW



MANUFACTURER: SPARCO
MODEL: R541
HOM. NO: RS.267.15
FIA STANDARD: 8856-2000

HOMOLOGATION: FIA8856-2000 - SFI 3.2A/5 (ON DEMAND) ■ **WEIGHT:** 330-360 G/M² ■ **SIZES:** 48-66
YOUTH SIZES: ON DEMAND ■ **LAYERS:** 4-IN-1 THANKS TO HOCOTEX 14L ■ **CUSTOMIZATION:** ON DEMAND



Extra-flat seams.

Seamless cuffs.



Under arm elastic and breathable inserts



Elasticated back panel



Hidden pockets

HOCOTEX 14LX

PAG.7



3 TIMES MORE BREATHABLE



30% MORE FIRE RESISTANT



30% HINNER



001135H..BNRS



001135H..BGBL



001135H..GNAR



001135H..NGBO

COMPETITION+



MANUFACTURER: SPARCO
MODEL: R554
HOM. NO: RS.341.18
FIA STANDARD: 8856-2000

HOMOLOGATION: FIA8856-2000 - SFI 3.2A/5 (ON DEMAND) ■ **WEIGHT:** 300-330 G/M² ■ **SIZES:** 48-66
LAYERS: 3 ■ **CUSTOMIZATION:** 3D CONFIGURATOR - ON DEMAND



Hidden hip pockets.

No box-quilting.

Seamless cuffs.



Elasticated fully floating arm construction



Underarm and lateral anti-abrasion inserts



Elasticated back panel



001128..BINR



001128..RSBI



001128..BMBI



001128..NRBI



Seamless cuffs.

COMPETITION+

LADY

FIA APPROVED
MANUFACTURER: SPARCO
MODEL: R554
HOM. NO: RS.341.18
FIA STANDARD: 8856-2000

HOMOLOGATION: FIA8856-2000 - SFI 3.2A/5 (ON DEMAND) ■ **WEIGHT:** 300-330 G/M² ■ **SIZES:** 38-50
LAYERS: 3 ■ **CUSTOMIZATION:** ON DEMAND



Elasticated fully floating arm construction



Inverted closure

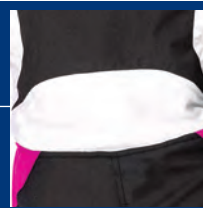

Elasticated back panel



001128L...NRBF



VINTAGE

CLASSIC



MANUFACTURER: SPARCO
MODEL: R554
HOM. NO: RS.341.18
FIA STANDARD: 8856-2000

HOMOLOGATION: FIA8856-2000 - SFI 3.2A/5 (ON DEMAND) ■ **WEIGHT:** 300-330 G/M² ■ **SIZES:** 48-66
LAYERS: 3 ■ **CUSTOMIZATION:** ON DEMAND



Hidden front pocket



Rear elastic band

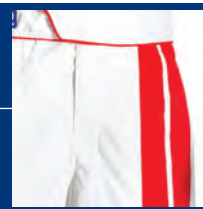

Hidden hip pockets



001128V..BIRS



COMPETITION



MANUFACTURER: SPARCO
 MODEL: R556
 HOM. NO: RS.349.19
 FIA STANDARD: 8856-2000

HOMOLOGATION: FIA8856-2000 ▪ **WEIGHT:** 330-360 G/M² ▪ **SIZES:** 48-66
LAYERS: 3 ▪ **CUSTOMIZATION:** ON DEMAND - CUSTOM EASY

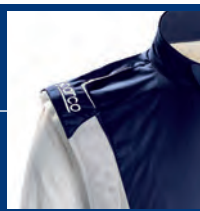

Extraction handle



Elasticated back panel

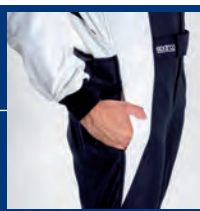

Hidden hip pockets



001137..BINR



001137..RSBI



001137..BMBI



001137..NRBI

SPRINT

NEW



MANUFACTURER: SPARCO
MODEL: R548-SPRINT RS2.1
HOM. NO: RS.287.16
FIA STANDARD: 8856-2000



HOMOLOGATION: FIA8856-2000 - SFI 3.2A-5 (ON DEMAND) ■ **WEIGHT:** 360-390 G/M² ■ **SIZES:** 48-66
YOUTH SIZES: ON DEMAND ■ **LAYERS:** 2 ■ **CUSTOMIZATION:** CUSTOM EASY - 3D CONFIGURATOR - ON DEMAND



Elasticated half floating arm construction.

Cross-cut belt.

New semi-gloss external finish.

New details and stitching.



Extraction handle



Front pockets



Elasticated back panel



001092..RSNR

001092..BELNR

001092..BMBI



001092..NRRS

001092..NR

ONE

HOMOLOGATION: SFI 3.2A/1 ■ WEIGHT: 170-200 G/M² ■ SIZES: XS-XXL ■ LAYERS: 1



Side pockets.

Lightweight exterior.

Vertical quilting.

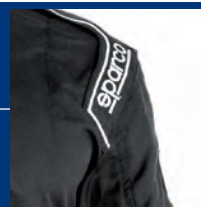

Extraction handle



Rear elastic band



Adjustable ankle closure



001058..NR



**NEVER OVERHEAT
UNDER PRESSURE.**

PRIME+

NEW

NEW FIA 8856-2018

44

HOMOLOGATION: FIA 8856-2018

F1-derived double weave construction.
Optimised flat seams for greater comfort.
Super breathable.



FIA APPROVED

MANUFACTURER: SPARCO
MODEL: R559
HOM. NO: DC.038.19-B
FIA STANDARD: 8856-2018

WEIGHT: 220 G/M² ■ ONE SIZE

00149880..

F1-derived double weave construction.
Extra thin cuffs.
Shoulder stitching moved to the back.
Super breathable.



FIA APPROVED

MANUFACTURER: SPARCO
MODEL: R559
HOM. NO: DC.040.19-T
FIA STANDARD: 8856-2018

WEIGHT: 220 G/M² ■ SIZES: XS-XXL

001773MBO..

F1-derived double weave construction.
Extra thin ankle cuffs.
Breathable inserts on the inside of the thigh.



FIA APPROVED

MANUFACTURER: SPARCO
MODEL: R559
HOM. NO: DC.041.19-L
FIA STANDARD: 8856-2018

WEIGHT: 220 G/M² ■ SIZES: XS-XXL

001774PBO..

RACING Underwear

FIA 8856-2018 SOCK

HOMOLOGATION: FIA 8856-2018

Double weave construction.
Extra comfort fabric.
Extra-flat toe and heel stitching.



FIA APPROVED

MANUFACTURER: SPARCO
MODEL: R560
HOM. NO: DC.039.19-S
FIA STANDARD: 8856-2018

WEIGHT: 250 G/M²
SIZES: 38/39 - 40/41 - 42/43 - 44/45 - 46

00152281..

GI

45



L. Norris - McLaren driver

RACING Underwear

SHIELD

RW-9

46

HOMOLOGATION: FIA 8856-2000/SFI 3.3 ■ **MATERIAL:** ARAMID, MODACRYLIC, MODAL VISCOSE, ELASTANE JERSEY

Yarn constructed to eliminate perspiration.
Guarantees maximum breathability.
Seamless fabric with unmachined areas.
Yreated with X-Cool to ensure maximum freshness.



ONE SIZE

001494BO.. 001494NR..



SIZES: XS/S - M/L - XL/XXL - XXXL

001764MBO.. 001764MNR...



SIZES: XS/S - M/L - XL/XXL - XXXL

001765PBO.. 001765PNR...

COMPRESSION SOCKS

COMPRESSION SOCKS WITH INNER SILICONING, OUTER SILICONING OR STANDARD VERSION

GI

47

HOMOLOGATION: FIA 8856-2000
COMPOSITION: 10% META-ARAMID
84% VISCOSE, 6% ELASTAN.
Outer stocking silicone insert.
Increased sensitivity between stocking and shoe.
Reduced slippage between stocking and shoe.



WEIGHT: 270 G/M²
SIZES: 38/39 - 40/41 - 42/43 - 44/45 - 46

001515BI.. 001515NR..

HOMOLOGATION: FIA 8856-2000
COMPOSITION: 10% META-ARAMID
84% VISCOSE, 6% ELASTAN.
Inner stocking silicone insert.
Increased sensitivity between foot and stocking.
Reduced slippage between foot and stocking.



WEIGHT: 270 G/M²
SIZES: 38/39 - 40/41 - 42/43 - 44/45 - 46

001514BI.. 001514NR..

HOMOLOGATION: FIA 8856-2000
COMPOSITION: 10% META-ARAMID
84% VISCOSE, 6% ELASTAN.
Class 1 (>21 mmHg) compression force.
Preventing circulatory problems.
Alleviating the feeling of heaviness.



WEIGHT: 260 G/M²
SIZES: 38/39 - 40/41 - 42/43 - 44/45 - 46

001512BI.. 001512NR..



SIZES: XS/S - M/L - XL/XXL - XXXL

001795BO.. 001795NR..



SIZES: 38/39 - 46

001510ICE.. 001510ICENR..



X-COOL RECHARGE

The X-COOL refill extends the refreshing treatment on suit and underwear (knitwear, trousers and stockings). The application can be done by machine wash.

00157RECHARGE

DELTA

RW-6

HOMOLOGATION: FIA 8856-2000 - **MATERIAL:** 50% FR COTTON, 50% FR MODACRYLIC (FIRE-RETARDANT)

GUARD

RW-3

HOMOLOGATION: FIA 8856-2000 - SFI 3.3 - **MATERIAL:** 100% META-ARAMIDIC

Double differentiated front/rear structure.
Two types of eye openings, single and double.
Eye-opening finished with knitted edge.



FIA APPROVED

MANUFACTURER: SPARCO
MODEL: BALACLAVA DELTA RW-6
FIA STANDARD: 8856-2000

ONE SIZE

001483BI

001483BI

Mixed body-size unmachined fibres.
No side seams.
Elasticised areas for greater comfort.
Elasticised ribbed neck band.
Jersey cuffs and hem with thin finish.



FIA APPROVED

MANUFACTURER: SPARCO
MODEL: TOP DELTA RW-6
FIA STANDARD: 8856-2000

WEIGHT: 190/200 G/M²
SIZES: XS/S - M/L - XL/XXL

001770MBI..

Soft-touch.
Single eye opening.



FIA APPROVED

MANUFACTURER: SPARCO
MODEL: RW3
FIA STANDARD: 8856-2000

ONE SIZE

001486BI

Soft-touch.
Raglan sleeves.
Preformed hips.



FIA APPROVED

MANUFACTURER: SPARCO
MODEL: RW3
FIA STANDARD: 8856-2000

SIZES: S - M - L - XL - XXL

001772M



Mixed body-size unmachined fibres.
Elasticated areas for greater comfort.
Elasticated ribbed waistband.
Thin finish ankles.

FIA APPROVED

MANUFACTURER: SPARCO
MODEL: 001521
FIA STANDARD: 8856-2000

SIZES: 38/39 - 46

001521..

FIA APPROVED

MANUFACTURER: SPARCO
MODEL: 001511
FIA STANDARD: 8856-2000

SIZES: 38/39 - 46

001511..

FIA APPROVED

MANUFACTURER: SPARCO
MODEL: BOTTOM DELTA RW-6
FIA STANDARD: 8856-2000

WEIGHT: 190/200 G/M²
SIZES: XS/S - M/L - XL/XXL

001770MBI..



FIA APPROVED

MANUFACTURER: SPARCO
MODEL: RW3
FIA STANDARD: 8856-2000

SIZES: S - M - L - XL - XXL

001772P

NOT FIA APPROVED

Single layer balaclava specifically for all championships in which FIA/SFI type approved garments are not mandatory. Double differentiated structure between the front and rear of the balaclava. Soft eye holes with mesh edgles for improved resistance to wear and tear.

ONE SIZE

001485BI..



KNEE PADS

00156N



Low neck, short sleeve T-shirt specifically for all championships in which FIA/SFI type approved garments are not mandatory. Differentiated mesh structure to provide better comfort and enhance breathability in different specific areas. Elastic low ribbed neck band. The raglan sleeve pattern makes the garment more comfortable thanks to the stitching of the sleeves which is positioned in an area that is subjected to less pressure. The wrists and waist have finer stitching for increased comfort.

SIZES: XS/S - M/L - XL/XXL

001796TBI..



ELBOW PADS

00157N



Bermuda shorts specifically for all championships in which FIA/SFI type approved garments are not mandatory. Differentiated mesh structure of the shorts to provide better comfort and enhance breathability in certain specific areas. Elastic, ribbed, mesh waist band edges.

SIZES: XS/S - M/L - XL/XXL

0017108BI..



ARM RESTRAINTS



00158SETRS 00158SETAZ 00158SETNR

Arm restraints system recommended for open vehicles such as Dragsters, Midgets and Off-road Vehicles. SFI 3.3 homologated.

A. Giovannazzi - F1 driver



**ENHANCE YOUR
CONNECTION.**



SHOES INDEX

MADE IN ITALY

54

PRIME+ (ON DEMAND)		NEW	HOMOLOGATION	MATERIAL	SOLE	SIZES	YOUTH SIZES	CUSTOMIZATION
			FIA 8856-2018	KANGAROO LEATHER	NATURAL RUBBER + EVA	37-48	-	ON DEMAND



001276SP

PRIME T		NEW	HOMOLOGATION	MATERIAL	SOLE	SIZES	YOUTH SIZES	CUSTOMIZATION
			FIA 8856-2018	KANGAROO LEATHER	NATURAL RUBBER + EVA	37-48	-	ON DEMAND



001281..BI

PRIME R		NEW	HOMOLOGATION	MATERIAL	SOLE	SIZES	YOUTH SIZES	CUSTOMIZATION
			FIA 8856-2018	KANGAROO LEATHER AND PU LEATHER	NATURAL RUBBER + EVA	37-48	-	ON DEMAND



001282..BI

X-LIGHT+		NEW	HOMOLOGATION	MATERIAL	SOLE	SIZES	YOUTH SIZES	CUSTOMIZATION
			FIA 8856-2018 SFI 3.3/5 ON DEMAND	KANGAROO LEATHER AND FABRIC	NATURAL RUBBER + CARBON	39-46	-	ON DEMAND



001278..NREB



001278..NRBI

X-LIGHT		NEW	HOMOLOGATION	MATERIAL	SOLE	SIZES	YOUTH SIZES	CUSTOMIZATION
			FIA 8856-2018 SFI 3.3/5 ON DEMAND	TUMBLED LEATHER AND PU LEATHER	TPU FR + EVA	37-48	-	3D CONFIGURATOR ON DEMAND



001283..BIRS



001283..GRAF



001283..BMBI



001283..NRGR

FORMULA RB-8.1		HOMOLOGATION	MATERIAL	SOLE	SIZES	YOUTH SIZES	CUSTOMIZATION
		FIA 8856-2000 SFI 3.3/5	TUMBLED LEATHER	NATURAL RUBBER	37-48	-	3D CONFIGURATOR ON DEMAND



001251..BINR



001251..RSBI



001251..AZBI



001251..NRBI

51

55

APEX		HOMOLOGATION	MATERIAL	SOLE	SIZES	YOUTH SIZES	CUSTOMIZATION
		FIA 8856-2018 SFI 3.3/5	TUMBLED LEATHER AND PU LEATHER	TPU FR + EVA	37-48	-	3D CONFIGURATOR ON DEMAND



001261..BIRS



001261..NRGI



001261..NRBI

SKID		NEW	HOMOLOGATION	MATERIAL	SOLE	SIZES	YOUTH SIZES	CUSTOMIZATION
			FIA 8856-2000	TUMBLED LEATHER AND PU LEATHER	NATURAL RUBBER	37-48	-	ON DEMAND



001275..BIBI



001275..RSNR



001275..BNBI



001275..NRGR



001275..NRNR

SLALOM+ FABRIC AND SUEDE		NEW	HOMOLOGATION	MATERIAL	SOLE	SIZES	YOUTH SIZES	CUSTOMIZATION
			FIA 8856-2018 SFI 3.3/5	SUEDE AND FABRIC	NATURAL RUBBER	35-48	-	-



001274F..RSNR



001274F..BXNR



001274F..NRNR

SLALOM+		NEW	HOMOLOGATION	MATERIAL	SOLE	SIZES	YOUTH SIZES	CUSTOMIZATION
			FIA 8856-2018 SFI 3.3/5	FULL SUEDE	NATURAL RUBBER	35-48	ON DEMAND	-



001274..RS



001274..BRFX



001274..NR

SLALOM RB 3.1		HOMOLOGATION	MATERIAL	SOLE	SIZES	YOUTH SIZES	CUSTOMIZATION
		FIA 8856-2000 SFI 3.3/5	FULL SUEDE	NATURAL RUBBER	36-48	-	-



001264..RS



001264..AZ



001264..NR

SLALOM CLASSIC		HOMOLOGATION	MATERIAL	SOLE	SIZES	YOUTH SIZES	CUSTOMIZATION
		FIA 8856-2000	CALF LEATHER	NATURAL RUBBER	36-48	-	ON DEMAND



001239..MA



001239..NR

PRIME+

NEW

NEW FIA 8856-2018



MANUFACTURER: SPARCO
MODEL: PRIME
HOM. NO: DC.022.19-Z
FIA STANDARD: 8856-2018

HOMOLOGATION: FIA 8856-2018 ■ WEIGHT: 190 GR. TG.42 ■ SIZES: ON DEMAND ■ CUSTOMIZATION: ON DEMAND



001276SP

PRIME T

NEW

NEW FIA 8856-2018



MANUFACTURER: SPARCO
MODEL: PRIME
HOM. NO: DC.022.19-Z
FIA STANDARD: 8856-2018

HOMOLOGATION: FIA 8856-2018 ■ WEIGHT: 220GR. TG.42 ■ SIZES: 37-48 ■ CUSTOMIZATION: ON DEMAND



001281..B1

PRIME R

NEW

NEW FIA 8856-2018



MANUFACTURER: SPARCO
MODEL: PRIME R
HOM. NO: DC.044.19-Z
FIA STANDARD: 8856-2018

HOMOLOGATION: FIA 8856-2018 ▪ **WEIGHT:** 240GR. TG.42 ▪ **SIZES:** 36-48 ▪ **CUSTOMIZATION:** ON DEMAND



Strap for blocking laces and ankle with ultragrip hook and loop fastener.

Padded tongue in ultra-breathable fabric.

Ultralight flat laces.

Anti-perspiration and breathable lining.



Kangaroo leather uppers fully inkjet printed.

High abrasion-resistant leather inserts.

Perforations for maximum breathability.

Comfortable insole.



Thin rubber sole with differentiated grip texture.



001282..BI

PRIME R: the new shoe developed together with the 6 times World Rally Champion Sébastien Ogier.



X-LIGHT+

NEW

NEW FIA 8856-2018



MANUFACTURER: SPARCO
MODEL: X-LIGHT+
HOM. NO.:
FIA STANDARD: 8856-2018

X-LIGHT

NEW

NEW FIA 8856-2018



MANUFACTURER: SPARCO
MODEL: X-LIGHT
HOM. NO.:
FIA STANDARD: 8856-2018

HOMOLOGATION: FIA 8856-2018 - SFI 3.3/5 (ON DEMAND) ■ **WEIGHT:** 220GR. TG. 42 ■ **SIZES:** 39-46
CUSTOMIZATION: ON DEMAND

HOMOLOGATION: FIA 8856-2018 - SFI 3.3/5 (ON DEMAND) ■ **WEIGHT:** 260GR. TG.42 ■ **SIZES:** 37-48
CUSTOMIZATION: 3D CONFIGURATOR - ON DEMAND

Available from February 2020.



Rollable fabric ankle with lace flap.

Ultra-light external closure. Double laces, flat and rounded.

Jaquard uppers.

High abrasion-resistant leather heel.

Inkjet printed kangaroo leather.

Protective 3D texture.

Real carbon insole with differentiated areas.

Thin rubber sole with differentiated grip texture.



Rollable jaquard tongue with lace flap.

Elasticated jaquard rear insert.

Flat, light glossy laces.

Perforations for maximum breathability.

Strong and ultra-light Kevlar loops.

Silkscreen printed tumbled calfskin uppers.

High abrasion-resistant leather inserts.

Comfortable insole.

TPU FR sole with differentiated grip texture.



001278..NREB



001278..NRBI



001283..BIRS



001283..GRAF



001283..BMBI



001283..NRGR

FORMULA

RB-8.1



MANUFACTURER: SPARCO
MODEL: RB-8.1
FIA STANDARD: 8856-2000

HOMOLOGATION: FIA 8856-2000 - SFI 3.3/5 ■ **WEIGHT:** 330GR. TG.42 ■ **SIZES:** 37-48
CUSTOMIZATION: 3D CONFIGURATOR - ON DEMAND

Adjustable strap.

Anti-perspiration and breathable lining.



Elasticated rear insert.

Tumbled calfskin uppers silkscreen printed.

Perforations for maximum breathability.

Thin rubber sole.



001251..BINR



001251..RSBI



001251..AZBI



001251..NRBI

APEX



MANUFACTURER: SPARCO
MODEL: RB-7
FIA STANDARD: 8856-2000

HOMOLOGATION: FIA 8856-2000 ■ **WEIGHT:** 325GR. TG.42 ■ **SIZES:** 37-48
CUSTOMIZATION: 3D CONFIGURATOR - ON DEMAND

Light and breathable lining.



Quick lacing.

Specific perforation zones.

PU leather side reinforcements.

Elasticated rear insert.

Tumbled calfskin uppers silkscreen printed.

Thin rubber sole.



001261..BIRS



001261..NRGI



001261..NRBI

SKID

NEW

NEW FIA 8856-2018



MANUFACTURER: SPARCO
MODEL: SKID
HOM. NO: DC.047.19-Z
FIA STANDARD: 8856-2018

HOMOLOGATION: FIA 8856-2018 - SFI 3.3/5 ■ WEIGHT: 310GR. TG.42 ■ SIZES: 37-48
CUSTOMIZATION: ON DEMAND



Overlap tongue integrated with side.

Elasticated rear insert.

Anti-perspiration and breathable lining.

Ultra strong shiny rounded wire.

Ultra resistant Kevlar loops.

Tumbled calfskin uppers silkscreen printed.

High abrasion-resistant leather inserts.

Perforations for maximum breathability.

Comfortable insole.

Shock absorber and anti vibration sole.

TPU FR sole with differentiated grip texture.



001275..BIBI

001275..RSNR

001275..BNBI

001275..NRGR

001275..NRNR

SLALOM+

NEW

NEW FIA 8856-2018



MANUFACTURER: SPARCO
MODEL: SLALOM +
HOM. NO: DC.037.19-Z
FIA STANDARD: 8856-2018

HOMOLOGATION: FIA8856-2018 - SFI 3.3/5 ■ WEIGHT: 330GR. TG. 42 ■ SIZES: 35-48



Perforated tongue.

Round glossy laces.

Anti-perspiration and breathable lining.

High abrasion-resistant reinforced leather heel.

Silkscreen printed perforated suede leather uppers.

Fabric insert.

Reinforced toe.

Comfortable insole.

Natural rubber sole with differentiated grip zones.



001274E..RSNR

001274E..BXNR

001274E..NRNR

SLALOM+

NEW

NEW FIA 8856-2018



MANUFACTURER: SPARCO
MODEL: SLALOM +
HOM. NO: DC.037.19-Z
FIA STANDARD: 8856-2018

HOMOLOGATION: FIA8856-2018 - SFI 3.3/5 ■ WEIGHT: 330GR. TG. 42 ■ SIZES: 35-48
YOUTH SIZES: 28-30-32-34 (ON DEMAND)

SLALOM

RB-3.1



MANUFACTURER: SPARCO
MODEL: SLALOM RB-3
FIA STANDARD: 8856-2000

HOMOLOGATION: FIA 8856-2000 - SFI 3.3/5 ■ WEIGHT: 360 GR. TG. 42 ■ SIZES: 36-48



SLALOM CLASSIC



MANUFACTURER: SPARCO
MODEL: SLALOM RB-3
FIA STANDARD: 8856-2000

MB CREW



MANUFACTURER: SPARCO
MODEL: MB CREW
HOM. NO: DC.003.19-Z
FIA STANDARD: 8856-2018



HOMOLOGATION: FIA 8856-2000 ■ WEIGHT: 370 GR. TG. 42 ■ SIZES: 36-48 ■ CUSTOMIZATION: ON DEMAND



001239..MA



001239..NR

OVERSHOES

SIZES : S-XL - S (38.5-40), M (40-41.5), L (41.5-43), XL (43.5-45)

Natural rubber overshoes, ideal for protecting the shoe soles on wet or abrasive surfaces.



002431..

HOMOLOGATION: FIA 8856-2018 ■ SIZES: 38-48

NEW FIA 8856-2018



001265..NR



FEEL THE SPEED.



GLOVES INDEX

MADE IN ITALY

72

NEW		HOMOLOGATION	PALM COMPOSITION	PRECURVED	SEAMS	SIZES	CUSTOMIZATION
TIDE		FIA 8856-2018 SFI 3.3/5	HTX - VULCANO	YES	EXTERNAL	8-13	3D CONFIGURATOR ON DEMAND



001356..BINR



001356..RSNR



001356..AZBI



001356..NRAF



001356..NRRS

NEW		HOMOLOGATION	PALM COMPOSITION	PRECURVED	SEAMS	SIZES	CUSTOMIZATION
ARROW		FIA 8856-2018 SFI 3.3/5	HTX - FLAT	YES	EXTERNAL	7-13	INFINITY PROJECT 3D CONFIGURATOR ON DEMAND



001314..BINR



001314..RSNR



001314..NRBI



001314..BMBI



001314..NRRS

NEW		HOMOLOGATION	PALM COMPOSITION	PRECURVED	SEAMS	SIZES	CUSTOMIZATION
LAP		FIA 8856-2000 SFI 3.3/5	SILICONE	YES	DIFFERENTIATED	7-13	BY STOCK



001315..RSNR



001315..BNBI



001315..BINR



001315..NRBI

NEW		HOMOLOGATION	PALM COMPOSITION	PRECURVED	SEAMS	SIZES	CUSTOMIZATION
LAND		FIA 8856-2000 SFI 3.3/5	SUEDE	YES	INTERNAL	8 - 13 4 e 6 YOUTH SIZE ON DEMAND	BY STOCK



001357..GF



001357..RS



001357..EB



001357..NR

NEW		HOMOLOGATION	PALM COMPOSITION	PRECURVED	SEAMS	SIZES	CUSTOMIZATION
LAND CLASSIC		FIA 8856-2000 SFI 3.3/5	SUEDE	NO	INTERNAL	8 - 13	BY STOCK



001358..ECRS



001358..NRBI

TIDE

NEW

NEW FIA 8856-2018

FIA APPROVED
 MANUFACTURER: SPARCO
 MODEL: TIDE
 HOM. NO: DC.032.19-G
 FIA STANDARD: 8856-2018



73



TECHNOLOGY
PATENTED
ALL RIGHTS RESERVED

HTX

PAG.7



001356..BINR



001356..RSNR



001356..AZBI



001356..NRAF



001356..NRRS

ARROW

NEW

NEW FIA 8856-2018



MANUFACTURER: SPARCO
MODEL: ARROW
HOM. NO: DC.014.19-G
FIA STANDARD: 8856-2018

LAP

NEW



MANUFACTURER: SPARCO
MODEL: RG-5
FIA STANDARD: 8856-2000

HOMOLOGATION: FIA 8856-2018 - SFI 3.3/5 - SIZES: 7-13



Ergonomic seam.



Aramid jersey fabric.

External seams.



HTX Flat palm.

Precurved glove.

Touch-S on index finger and thumb.

PAG.7

In compliance with:
FIA Standard 8856-2018
Manufacturer name:
sparco
Homologation N°: DC.000.00X
Not valid after: 20XX



001314..BIRS

001314..RSNR

001314..NRBI

001314..BMBI

001314..NRRS

HOMOLOGATION: FIA 8856-2000 - SFI 3.3/5 - SIZES: 8-13



Joined thumb to upper.

Differentiated external and internal seams.

Wrist strap with internal elastic.



New optimised silicone grip graphics.

Preformed glove.



001315..RSNR

001315..BNBI

001315..BINR

001315..NRBI

LAND

NEW



MANUFACTURER: SPARCO
MODEL: LAND
FIA STANDARD: 8856-2000

LAND CLASSIC

NEW



MANUFACTURER: SPARCO
MODEL: LAND
FIA STANDARD: 8856-2000



HOMOLOGATION: FIA 8856-2000 - SFI 3.3/5 ■ SIZES: 8-13 ■ YOUTH SIZES: 4 and 6 ON DEMAND

HOMOLOGATION: FIA 8856-2000 - SFI 3.3/5 ■ SIZES: 8-13



sparco

NEW WORLD OF PROTECTION.



RACING Helmets

HELMETS INDEX



MADE IN ITALY



80

FULL FACE HELMET

PRIME RF-9W SUPERCARBON	HOMOLOGATION	MATERIAL	HANS® CLIPS	SIZES	 003342
	FIA 8860-2010 SNELL SA 2015	CARBON FIBER	FITTED	XS-XL	



SKY RF-7W CARBON	HOMOLOGATION	MATERIAL	HANS® CLIPS	SIZES	 003344
	FIA 8859-2015 SNELL SA 2015	CARBON FIBER	FITTED	XS-XL	

AIR PRO RF-5W	HOMOLOGATION	MATERIAL	HANS® CLIPS	SIZES	 003345	 003345NR
	FIA 8859-2015 SNELL SA 2015	KEVLAR/ FIBERGLASS	FITTED	XS-XXL		

CLUB X-1	HOMOLOGATION	MATERIAL	HANS® CLIPS	SIZES	 003319	 003319N
	NOT FIA HOMOLOGATED ECE 22-05	ATM (ADVANCED THERMO MATERIAL)	NOT FITTED	XS-XXL		

PRIME RJ-9i SUPERCARBON	HOMOLOGATION	MATERIAL	HANS® CLIPS	SIZES	 003364
	FIA 8860-2010 SNELL SA 2015	CARBON FIBER	FITTED	XS-XL	

SKY RJ-7i CARBON	HOMOLOGATION	MATERIAL	HANS® CLIPS	SIZES	 003365
	FIA 8859-2015 SNELL SA 2015	CARBON FIBER	FITTED	XS-XL	

AIR PRO RJ-5i	HOMOLOGATION	MATERIAL	HANS® CLIPS	SIZES	 003366	 003366NR
	FIA 8859-2015 SNELL SA 2015	CARBON FIBER	FITTED	XS-XXL		

PRO RJ-3i	HOMOLOGATION	MATERIAL	HANS® CLIPS	SIZES	 003367
	FIA 8859-2015 SNELL SA 2015	KEVLAR/ FIBERGLASS	FITTED	XS-XXL	

SKY RJ-7 CARBON	HOMOLOGATION	MATERIAL	HANS® CLIPS	SIZES	 003348
	FIA 8859-2015 SNELL SA 2015	KEVLAR/ FIBERGLASS	FITTED	XS-XL	

PRO RJ-3	HOMOLOGATION	MATERIAL	HANS® CLIPS	SIZES	 003353
	FIA 8859-2015 SNELL SA 2015	KEVLAR/ FIBERGLASS	FITTED	XS-XXL	

CLUB J-1	HOMOLOGATION	MATERIAL	HANS® CLIPS	SIZES	 003317
	NOT FIA HOMOLOGATED ECE 22-05	ATM (ADVANCED THERMO MATERIAL)	NOT FITTED	XS-XL	

PRIME RF-9W

SUPERCARBON

HOMOLOGATION: FIA 8860-2010 - SNELL SA 2015 - SIZES: SMALL SHELL from XS to M+ - LARGE SHELL from L to XL



Pre-preg carbon fiber shell reinforced with carbon fiber.

Double sizes shell and polystyrene with ventilation ducts.



FIA homologated visor with continuous adjustment.

Hans® Clips.

Removable, repositionable and washable interiors.

Predisposed for drink system.



MANUFACTURER: VM SAFETY
MODEL: SPARCO PRIME RF-9W
HOM. NO: AH.029.17-C
FIA STANDARD: 8860-2010

CARBON		
XS	53-54	0033420XS
S	55-56	0033421S
M	57-58	0033422M
M+	59	0033423ML



MANUFACTURER: VM SAFETY
MODEL: SPARCO PRIME RF-9W
HOM. NO: AH.035.18-C
FIA STANDARD: 8860-2010

CARBON		
L	60	0033424L
XL	61	0033425XL



SKY RF-7W

CARBON

FIA APPROVED
 MANUFACTURER: VM SAFETY
 MODEL: SPARCO SKY RF-7W
 HOM. NO: PH.036.16-C
 FIA STANDARD: 8859-2015

HOMOLOGATION: FIA 8859-2015 - SNELL SA 2015 ■ **SIZES:** SMALL SHELL from XS to M+ - LARGE SHELL from L to XL



Carbon fiber shell reinforced with carbon-kevlar.

Double sizes shell and polystyrene with ventilation ducts.

FIA homologated visor with continuous adjustment.

Hans® Clips.

Removable, repositionable and washable interiors.

Predisposed for drink system.



CARBON		
XS	53-54	0033440XS
S	55-56	00033441S
M	57-58	0033442M
M+	59	0033443ML
L	60	0033444L
XL	61	0033445XL

AIR PRO

RF-5W

FIA APPROVED
 MANUFACTURER: VM SAFETY
 MODEL: SPARCO AIR RF-5W
 HOM. NO: PH.037.16-C
 FIA STANDARD: 8859-2015

HOMOLOGATION: FIA 8859-2015 ■ **SIZES:** SMALL SHELL from XS to M+ - LARGE SHELL from L to XXL



Fiberglass shell reinforced with carbon-kevlar layers.

Double sizes shell and polystyrene with ventilation ducts.

FIA homologated visor with continuous adjustment.

Hans® Clips.

Removable, repositionable and washable interiors.

Predisposed for drink system.



WHITE		
XS	53-54	0033450XS
S	55-56	00033451S
M	57-58	0033452M
M+	59	0033453ML
L	60	0033454L
XL	61	0033455XL
XXL	62	0033456XXL

MATT BLACK		
XS	53-54	0033450XSNR
S	55-56	00033451SNR
M	57-58	0033452MNR
M+	59	0033453MLNR
L	60	0033454LNR
XL	61	0033455XLNR
XXL	62	0033456XXLNR

CLUB

X-1

HOMOLOGATION: ECE 22-05 ▪ SIZES: XS-XXL



ATM (Advanced Thermo Material) shell.

Not homologated for FIA competitions.

Inner lining in hypoallergenic material.

Helmet suitable for kart rental.

WHITE		
XS	53-54	0033190XS
S	55-56	0033191S
M	57-58	0033192M
L	59	0033193L
XL	60	0033194XL
XXL	61	0033195XXL

MATT BLACK		
XS	53-54	0033190XS
S	55-56	0033191S
M	57-58	0033192M
L	59	0033193L
XL	60	0033194XL
XXL	61	0033195XXL



PRIME

NEW

RJ-9i



HOMOLOGATION: FIA 8860-2010 - SNELL - SA 2015 ▪ SIZES: SMALL SHELL from XS to M+ - LARGE SHELL from L to XL



Pre-preg carbon fiber shell reinforced with carbon fiber.

Double sizes shell and polystyrene with ventilation ducts.

Carbon fiber peak.

Hans® Clips.

Removable, repositionable and washable interiors.

Complete with new professional communication system (adjustable arm, noise-cancelling microphone, high quality speaker).

Removable, repositionable and washable interiors.

CARBON		
XS	53-54	0033640XS
S	55-56	0033641S
M	57-58	0033642M
M+	59	0033643ML
L	60	0033644L
XL	61	0033645XL



HOMOLOGATION: FIA 8859-2015 - SNELL - SA 2015 ■ **SIZES:** SMALL SHELL from XS to M+ - LARGE SHELL from L to XL



Carbon fiber shell reinforced with carbon-kevlar.

Double sizes shell and polystyrene with ventilation ducts.

Carbon fiber peak.

Removable, repositionable and washable interiors.

Complete with new professional communication system (adjustable arm, noise-cancelling microphone, high quality speaker).

Military type connections (die-cast Nexus connector).

Hans® Clips.



CARBON		
XS	53-54	0033650XS
S	55-56	0033651S
M	57-58	0033652M
M+	59	0033653ML
L	60	0033654L
XL	61	0033655XL



Carbon fiber shell reinforced with carbon fiber.

Double sizes shell and polystyrene with ventilation ducts.

Carbon fiber peak.

Removable, repositionable and washable interiors.

Hans® Clips.



CARBON		
XS	53-54	0033480XS
S	55-56	0033481S
M	57-58	0033482M
M+	59	0033483ML
L	60	0033484L
XL	61	0033485XL



AIR PRO

NEW

RJ-5i



MANUFACTURER: VM SAFETY
MODEL: SPARCO PRO RJ-3i AIR
HOM. NO: PH.042.16-O
FIA STANDARD: 8859-2015

PRO

NEW

RJ-3i



MANUFACTURER: VM SAFETY
MODEL: SPARCO PRO RJ-3i
HOM. NO: PH.042.16-O
FIA STANDARD: 8859-2015

HOMOLOGATION: FIA 8859-2015 - SNELL - SA 2015 ■ **SIZES:** SMALL SHELL from XS to M+ - LARGE SHELL from L to XXL



WHITE		
XS	53-54	0033660XS
S	55-56	0033661S
M	57-58	0033662M
M+	59	0033663ML
L	60	0033664L
XL	61	0033665XL
XXL	62	0033666XXL

MATT BLACK		
XS	53-54	0033660XSNR
S	55-56	0033661SNR
M	57-58	0033662MNR
M+	59	0033663MLNR
L	60	0033664LNR
XL	61	0033665XLNR
XXL	62	0033666XXLNR



WHITE		
XS	53-54	0033670XS
S	55-56	0033671S
M	57-58	0033672M
M+	59	0033673ML
L	60	0033674L
XL	61	0033675XL
XXL	62	0033676XXL



PRO

RJ-3



MANUFACTURER: VM SAFETY
MODEL: SPARCO PRO RJ-3
HOM. NO: PH.042.16-O
FIA STANDARD: 8859-2015

CLUB

J-1



HOMOLOGATION: FIA 8859-2015 - SNELL - SA 2015 ■ **SIZES:** SMALL SHELL from XS to M+ - LARGE SHELL from L to XXL



WHITE		
XS	53-54	0033530XS
S	55-56	0033531S
M	57-58	0033532M
M+	59	0033533ML
L	60	0033534L
XL	61	0033535XL
XXL	62	0033536XXL



WHITE		
XS	53-54	0033170XS
S	55-56	0033171S
M	57-58	0033172M
L	60	0033174L
XL	61	0033175XL



ACCESSORIES

ACCESSORIES - JET HELMETS

= STANDARD/SPARE = OPTION

	INTERCOM SYSTEM	BLACK ABS PEAK	WHITE ABS PEAK	MATT BLACK ABS PEAK	CARBON PEAK 8859	CARBON PEAK 8860	NEW MIC. 00537035	SET OF SMALL MATT BLACK AIR INTAKES	SET OF SMALL WHITE AIR INTAKES
PRIME RJ-9i	FACTORY FITTED	00316F01	00316F03	00316F02	00316F04	FACTORY FITTED	FITTED	00315K04	0032WTXK06
SKY RJ-7i	FACTORY FITTED	00316F01	00316F03	00316F02	FACTORY FITTED	00316F05	FITTED	00315K04	0032WTXK06
SKY RJ-7	NOT FITTABLE	00316F01	00316F03	00316F02	FACTORY FITTED	00316F05	NOT FITTABLE	00315K04	0032WTXK06
AIR PRO RJ-5i WHITE	FACTORY FITTED	00316F01	00316F03	00316F02	00316F04	00316F05	FITTED	00315K04	0032WTXK06
AIR PRO RJ-5i BLACK	FACTORY FITTED	00316F01	00316F03	00316F02	00316F04	00316F05	FITTED	00315K04	0032WTXK06
PRO RJ-3i	FACTORY FITTED	00316F01	00316F03	00316F02	00316F04	00316F05	537010	00315K04	0032WTXK06
PRO RJ-3	NOT FITTABLE	00316F01	00316F03	00316F02	00316F04	00316F05	NOT FITTABLE	00315K04	0032WTXK06

ACCESSORIES

VISORS



CLEAR VISOR

00314V01



DARK VISOR

00314V02



SILVER IRIDIUM VISOR

00314V04



BLUE IRIDIUM VISOR

00314V03

ACCESSORIES - FULL FACE HELMETS

= STANDARD/SPARE = OPTION

	CLEAR VISOR	DARK VISOR	BLUE IRIDIUM VISOR	SILVER IRIDIUM VISOR	SET OF 5 TEAR-OFFS	VISOR FASTENER KIT	CENTRAL MATT BLACK AIR INTAKE	SET OF SMALL MATT BLACK AIR INTAKES	CENTRAL WHITE AIR INTAKE	SET OF SMALL WHITE AIR INTAKES
PRIME RF-9W	00314V01	00314V02	00314V03	00314V04	00315K01	00315K02	00315K03	00315K04	0032WTXK04	0032WTXK06
SKY RF-7W	00314V01	00314V02	00314V03	00314V04	00315K01	00315K02	00315K03	00315K04	0032WTXK04	0032WTXK06
AIR PRO RF-5W WHITE	00314V01	00314V02	00314V03	00314V04	00315K01	00315K02	00315K03	00315K04	0032WTXK04	0032WTXK06
AIR PRO RF-5W BLACK	00314V01	00314V02	00314V03	00314V04	00315K01	00315K02	00315K03	00315K04	0032WTXK04	0032WTXK06
AIR KF-7W	00314V01	00314V02	00314V03	00314V04	00315K01	00315K02	00315K03	00315K04	0032WTXK04	0032WTXK06
SKY KF-5W	00314V01	00314V02	00314V03	00314V04	00315K01	00315K02	00315K03	00315K04	0032WTXK04	0032WTXK06



SET OF 5 TEAR-OFFS

00315K01



VISOR FASTENER KIT

00315K02



CENTRAL BLACK AIR INTAKE

00315K03



SMALL LATERAL AIR INTAKES

00315K04



CENTRAL WHITE AIR INTAKE

0032WTXK04



SMALL LATERAL AIR INTAKES

0032WTXK06

ACCESSORIES

PEAKS

94



SUPERCARBON PEAK 8860

00316F05



CARBON PEAK 8859

00316F04



WHITE ABS PEAK

00316F03



BLACK ABS PEAK

00316F01



MATT BLACK ABS PEAK

00316F02

ACCESSORIES

INTERCOM KIT

GI

95

INTERCOM KIT FOR FULL-FACE HELMETS

00537025



Intercom kit for full-face helmets - Nexus Connection - Noise cancelling microphone, high-quality speakers.

INTERCOM KIT FOR JET HELMETS

00537026



Intercom kit for jet helmets - Nexus Connection - Noise cancelling microphone installed on flexible arm.

00537013



Intercom kit for full-face helmets.

00537011



Intercom kit for jet helmets.

00537015



Nexus F-F adaptor.

00537019



Nexus M-M adaptor.

ACCESSORIES

CHEEK PADDING



25 mm	0032RF01ML
30 mm	0032RF01MXLXL
35 mm	0032RF01SL
40 mm	0032RF01XS

TOP PADDING



10 mm	0032R01XXL
15 mm	0032R01MMLXL
15+5 mm	0032R01XSS

These kits allow for the best possible helmet fitting, with the right choice of thickness for the user's needs. Installation is simple and rapid, thanks to the hook and loop fastener.

FRONT SPOILER



The front spoiler reduces high-speed helmet vibrations to stabilise the helmet and make it more comfortable.

00315K07	00315K08
----------	----------

REAR SPOILER



The rear spoiler stabilises the helmet at high speeds and at the same time facilitates hot air extraction from the helmet.

00315K09	00315K10
----------	----------

PUMPER



XS - M/L	00317P02
L - XXL	00317P04
XS - M/L	00317P01
L - XXL	00317P03

MICROPHONE NEW

00537035



Noise cancelling microphone. Adjustable microphone position. Compatible with PRIME RJ-9i, SKY RJ-7i, AIR PRO RJ-5i.

ACCESSORIES

HELMET BAG

003112NGR

DIMENSIONS: H28XL42XP24 cm - 28 LT.



HELMET NET

00313

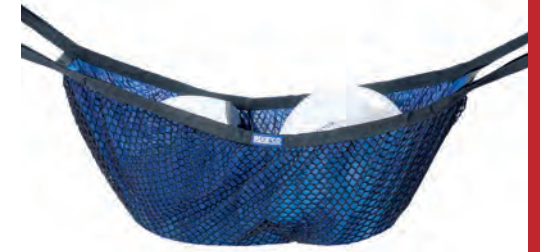

HELMET BOXES



01662R	01662A	01662N
--------	--------	--------

HOOK

01666



F.H.R. DEVICES

Thanks to the new trade agreement, Sparco is able to provide the best range of Head Restraint for sizes, structure, weight and price. Moreover, thanks to the usual care for its products, Sparco is the only factory able to provide to customers a full package compatible with the set (helmet, harness and seat).

ULTIMATE

100% carbon
Weight: 490g (without padding)
Improved fitting
Sliding Tethers



DEGREE	SIZES
20	M
20	L
30	M
30	L

00393U...

HI TECH

Carbon made
Weight: about 550g
All sizes available
Sliding Tethers



DEGREE	SIZES
10	M
20	S - M - L
25	S
30	M - L
30	SPECIAL M - L
40	M

00391N...

CLUB 3

Made of thermoplastic material
Weight: about 640g
2 sizes available
Sliding Tethers



DEGREE	SIZES
20	M/L - L/XL

00394C20...

CLUB

Realized in high resistance PVC
Weight: around 950g
Ergonomic design shape
Sliding Tethers
Low price



DEGREE	SIZES
20	M/L - L/XL

00391C...

INTERCOM NEW

IS-BT 150

Professional Digital DSP intercom control unit kit with preset noise filters.
 Double potentiometer with independent Driver and Co-Driver volume.
 BlueTooth telephone module.
 Nexus Female - Female connectors with 2m cables.
 RCA connector for in-car camera.
 Remote connector for FIRMWARE update via PC.
 AUX connector for telephone and radio.
 Power cable for connection to the 12V car battery.
 9V power supply with battery compartment.
 Automatic exclusion of the 9V battery in the presence of a 12V power supply.
 Rollcage or dashboard attachment with anti-vibration pad.

00537030



INTERCOM NEW

IS 140

Professional intercom control unit kit.
 Double potentiometer with independent Driver and Co-Driver volume.
 Nexus Female - Female connectors with 2m cables.
 RCA connector for in-car camera.
 Remote connector for FIRMWARE update via PC.
 Power cable for connection to the 12V car battery.
 9V power supply with battery compartment.
 Automatic exclusion of the 9V battery in the presence of a 12V power supply.
 Rollcage or dashboard attachment with anti-vibration pad.

00537029



INTERCOM NEW

IS 110

Entry level intercom control unit kit with single volume potentiometer.
 12V car battery connection cable.
 RCA connection cable for in-car camera.
 9V battery compartment.
 2m driver/navigator cable with 6.3mm female output jack.
 Bottom suitable for rollcage or dashboard attachment.

00537028



INTERCOM NEW

GSM

GSM communication control unit with clear and stable driver-pits communication.
 Magnetic GSM antenna.
 Antenna fixing bracket for plastic surfaces.
 Nexus male connector.
 Integrated SIM slot.
 On/Off potentiometer with volume control.
 12V power cable.
 Rollcage or dashboard installation.

Notes: disable the PIN function on the SIM card,
 the performance of the system depends on the availability
 of the GSM signal.

00537033



HEADSETS

HEAD NX-1

Asymmetrical design for better microphone fit with ambient
 noise ablation and NEXUS connectors.

00537034



SHAPED TO RACE.



sparco





RACING Seats

SEATS INDEX

HOMOLOGATION 8862-2009

	SHELL	SIZE	HRS	WEIGHT (gr)	
ADV XT	CARBON FIBER	L	YES	SHELL: 7500 SEAT: 10750	 008002ZNR

	SHELL	SIZE	HRS	WEIGHT (gr)	
ADV ELITE	CARBON FIBER	L	YES	SHELL: 7810 SEAT: 10300	 00849ZNR



	SHELL	SIZE	HRS	WEIGHT (gr)	
ADV SCX SCX-H	CARBON FIBER	M/L	YES	SHELL SCX: 8575 SHELL SCX: 8575 — SEAT: 10750 SEAT: 10750	 00804ZNR  00805ZNR

	SHELL	SIZE	HRS	WEIGHT (gr)	
ADV SC	CARBON FIBER	M	YES	SHELL: 10485 SEAT: 12900	 008020ZNR

	SHELL	SIZE	HRS	WEIGHT (gr)	
ADV XT GF	CARBON FIBER	L	YES	SHELL: 18100 SEAT: 20000	 008002FNR

	SHELL	SIZE	HRS	WEIGHT (gr)	
PRO ADV	CARBON FIBER	L	YES	SHELL: 6000 SEAT: 8100	 008095ZNR



	SHELL	SIZE	HRS	WEIGHT (gr)	
QRT-C	CARBON FIBER	M	NO	SHELL: 4300 SEAT: 5500	 008005ZNR

	SHELL	SIZE	HRS	WEIGHT (gr)	
QRT-R QRT-R SKY	QRT	M	NO	SHELL QRT-R: 5900 SHELL QRT-R SKT: 5900 — SEAT QRT-R: 7600 SEAT QRT-R SKT: 8300	 008012RNR  008012RNR SKY



HOMOLOGATION 8855-1999

	SHELL	SIZE	HRS	WEIGHT (gr)	
PILOT QRT	QRT	L/XL	YES	SHELL: 9300 SEAT: 11100	 008018RNR

	SHELL	SIZE	HRS	WEIGHT (gr)	
PRO ADV QRT	QRT	M/L	YES	SHELL: 7800 SEAT: 9300	 008017RNR

	SHELL	SIZE	HRS	WEIGHT (gr)	
GRID-Q GRID-Q SKY	QRT	M	NO	SHELL GRID-Q: 6500 SHELL GRID-Q SKY: 6500 — SEAT GRID-Q: 7300 SEAT GRID-Q SKY: 7700	 008009RNR  008009RNR SKY



	SHELL	SIZE	HRS	WEIGHT (gr)	
PRO 2000	QRT	L	NO	SHELL: 6800 SEAT: 8000	 008016RNR

	SHELL	SIZE	HRS	WEIGHT (gr)	
CIRCUIT QRT CIRCUIT II QRT	QRT	L	YES	SHELL CIRCUIT: 7100 SHELL CIRCUIT II: 7200 — SEAT CIRCUIT: 8600 SEAT CIRCUIT II: 9600	 008019RNR  008011RNR

	SHELL	SIZE	HRS	WEIGHT (gr)	
EVO QRT/ EVO SKY QRT	QRT	M/L/XL	NO	SHELL EVO/SKY QRT: 5000 — SEAT EVO/SKY QRT: 7300	 008007RNR  008007RNR SKY

	SHELL	SIZE	HRS	WEIGHT (gr)	
EVO L QRT EVO XL QRT	QRT	M/L/XL	NO	SHELL EVO L QRT: 6700 SHELL EVO XL QRT: 6500 — SEAT EVO L QRT: 7900 SEAT EVO XL QRT: 7700	 008013RNR  008015RNR

	SHELL	SIZE	HRS	WEIGHT (gr)	
REV QRT	QRT	M	NO	SHELL: 6000 SEAT: 7100	 008014RNR

	SHELL	SIZE	HRS	PESO (gr)	
SPRINT/ SPINT SKY SPRINT L	TUBULAR	M/L	NO	SHELL SPRINT/SPRINT SKY: 7940 SHELL SPRINT L: 10400 — SSEAT SPRINT/SPRINT SKY: 9700 SHELL SPRINT L: 11000	 008235  008235RNR SKY  008234L

HOMOLOGATION 8855-1999

THE INDICATED WEIGHT IS CALCULATED ON THE AVERAGE VALUE OF THE ANALYZED SAMPLES, THEREFORE IT IS POSSIBLE THAT IT WILL UNDERGO VARIATIONS.

ADV XT



HOMOLOGATION: FIA 8862-2009 ■ **MATERIAL:** CARBON ■ **WEIGHT (gr):** SHELL: 7500 - SEAT: 10750

ULTRALIGHT SEAT.



Self-extinguishing fabric lining



Non-slip fabric for shoulders and seat



Split legrest cushion

008002ZNR

FIA-approved energy absorbing padding.



Fixed using M12 lateral fastenings with 290 mm spacing.



The seat is approved in conjunction with the side mounting frames 0049605.

0049605

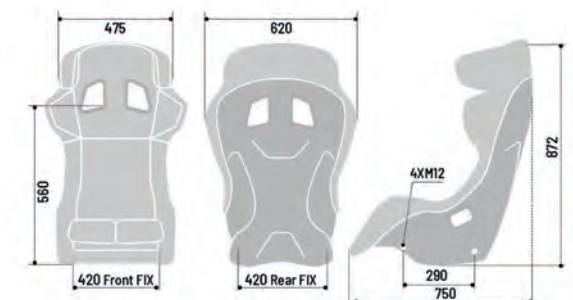



00849ZNR

ADV ELITE

FIA APPROVED
 MANUFACTURER: SPARCO
 MODEL: ADV ELITE
 HOM. NO: AS.037.14
 FIA STANDARD: 8862-2009



HOMOLOGATION: FIA 8862-2009 ■ **MATERIAL:** CARBON ■ **WEIGHT (gr):** SHELL 7810 - SEAT 10300

TOP-LEVEL PERFORMANCE.



Self-extinguishing fabric lining



Non-slip fabric for shoulders and seat



Improved habitability and comfort

FIA-approved energy absorbing padding.



Fixed using M12 lateral fastenings with 290 mm spacing.



The seat is approved in conjunction with the side mounting frames 004988ADV.



004988ADV

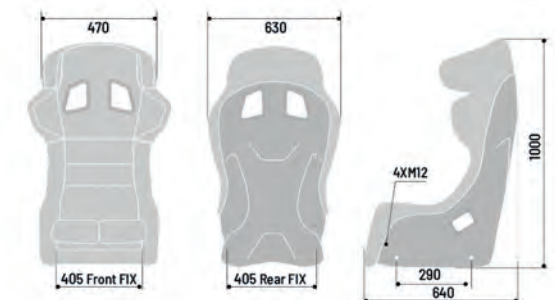

IS



00804ZNR

ADV SCX

SCX-H



ADV SCX HOMOLOGATION: FIA 8862-2009 - **MATERIAL:** CARBON - **WEIGHT (gr):** SHELL 8575 - SEAT 11000
ADV SCX-H HOMOLOGATION: FIA 8862-2009 - **MATERIAL:** CARBON - **WEIGHT (gr):** SHELL 9280 - SEAT 11700

ULTRA-RESISTANT SEAT.
AVAILABLE IN 2 SIZES SCX AND SCX-H.



Self-extinguishing fabric lining



Non-slip fabric for shoulders and seat



Split legrest cushion

FIA-approved energy absorbing padding.

ADV SCX-H



00805ZNR



Fixed using M12 lateral fastenings with 290 mm spacing.

The seat is approved in conjunction with the side mounting frames.

ADV SCX 004985ADV
 ADV SCX-H 004984ADV

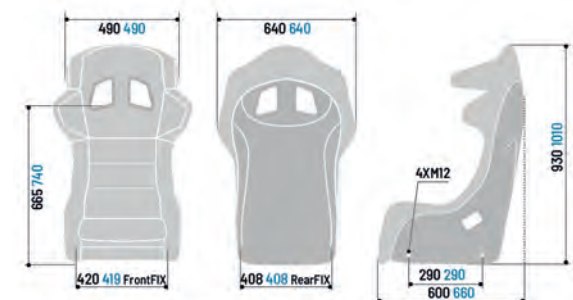

ADV SC



ADV XT GF NEW



HOMOLOGATION: FIA 8862-2009 ■ **MATERIAL:** CARBON ■ **WEIGHT (gr):** SHELL 10485 - SEAT 12900

TOP-LEVEL STRENGTH.



008020ZNR

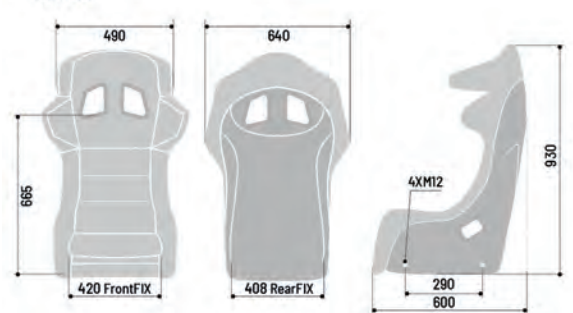

The seat is approved in conjunction with the side mounting frames 004982ADV.



HOMOLOGATION: FIA 8862-2009 ■ **MATERIAL:** FIBERGLASS ■ **WEIGHT (gr):** SHELL 18100 - SEAT 20000

M-SPORT FORD FIESTA R5 OFFICIAL EQUIPMENT.



008002FNR

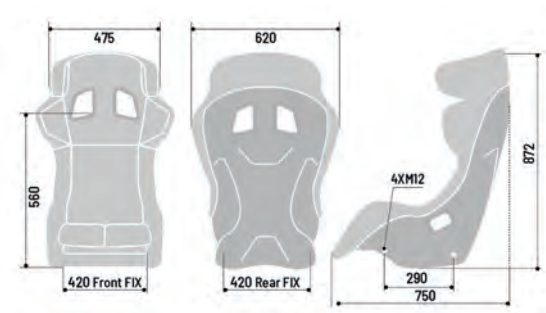

The seat is approved in conjunction with the side mounting frames 0049605.

0049605

PRO ADV



QRT C



HOMOLOGATION: 8855-1999 ■ **MATERIAL:** CARBON ■ **WEIGHT (gr):** SHELL 6000 - SEAT 8100

SIMPLIFIED AND LIGHTER VERSION COMPARED TO THE ADV SC.



008095ZNR

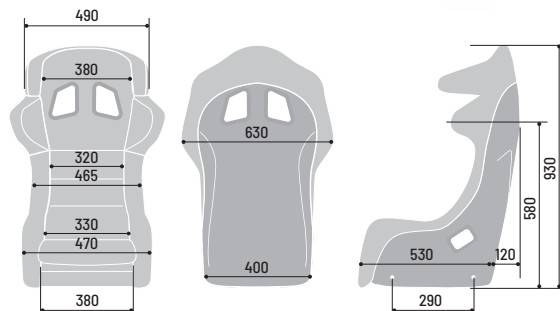

HOMOLOGATION: FIA 8855-1999 ■ **MATERIAL:** CARBON ■ **WEIGHT (gr):** SHELL 4300 - SEAT 5500

DESIGN AND FUNCTIONALITY.



008025ZNR

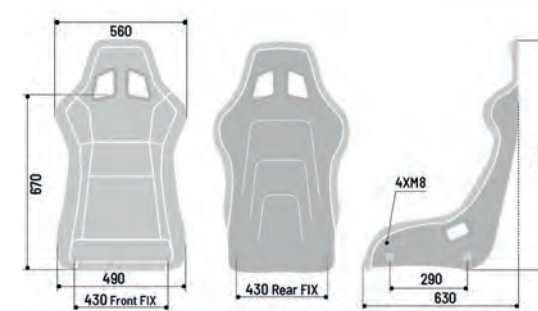

QRT R



QRT R SKY



HOMOLOGATION: FIA 8855-1999 ■ MATERIAL: QRT ■ WEIGHT (gr): SHELL 5900 - SEAT 7600

DESIGN AND FUNCTIONALITY.



008012RNR

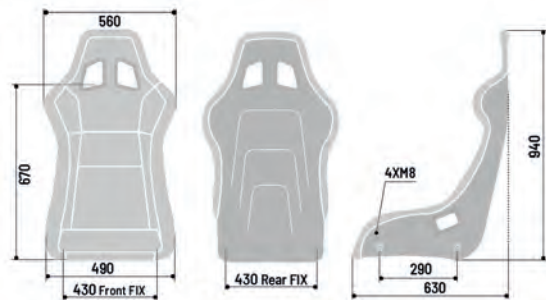

HOMOLOGATION: FIA 8855-1999 ■ MATERIAL: QRT ■ WEIGHT (gr): SHELL 5900 - SEAT 7600

DESIGN AND FUNCTIONALITY.



008012RNRSKY

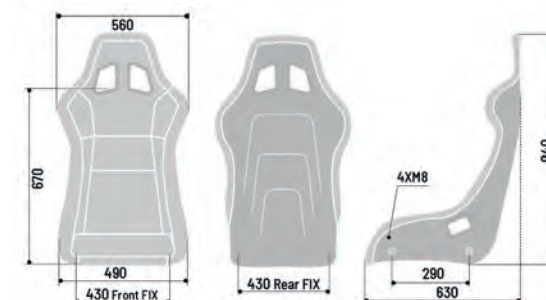

PILOT QRT

NEW



MANUFACTURER: SPARCO
MODEL: PILOT
HOM. NO: CS.425.19
FIA STANDARD: 8855-1999

PRO ADV QRT

NEW



MANUFACTURER: SPARCO
MODEL: PRO ADV QRT
HOM. NO: CS.434.19
FIA STANDARD: 8855-1999

HOMOLOGATION: FIA 8855-1999 ■ MATERIAL: QRT ■ WEIGHT (gr): SHELL 9300 - SEAT 11100

IDEAL FOR TALL DRIVERS.



Integrated, narrow head restraint for small car interiors.

Non-slip fabric for shoulder and seat restraint.

Divisible legrest and seat cushion.

Fixed using M8 lateral fastenings with 290 mm spacing.

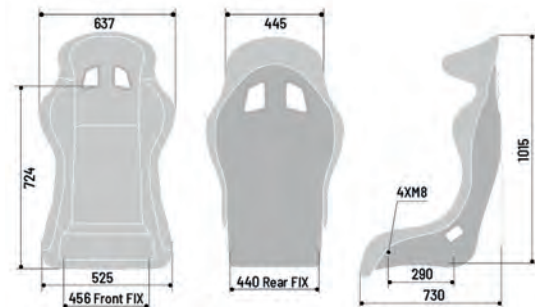

008018RNR

HOMOLOGATION: FIA 8855-1999 ■ MATERIAL: QRT ■ WEIGHT (gr): SHELL 7800 - SEAT 9300

IDEAL FOR TOURING AND RALLY RACES.



Non-slip fabric for shoulder and seat restraint.

Divisible legrest and seat cushion.

Fixed using M8 lateral fastenings with 290 mm spacing.

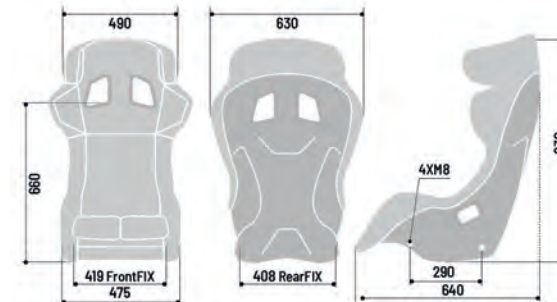

008017RNR

REV QRT

NEW



MANUFACTURER: SPARCO
MODEL: REV QRT
HOM. NO: CS.423.19
FIA STANDARD: 8855-1999

EVO QRT



MANUFACTURER: SPARCO
MODEL: EVO QRT
HOM. NO: CS.373.17
FIA STANDARD: 8855-1999

HOMOLOGATION: FIA 8855-1999 ■ MATERIAL: QRT ■ WEIGHT (gr): SHELL 6000 - SEAT 7100

ULTRA-COMPACT SEAT.



Non-slip fabric for shoulder and seat restraint.

Divisible legrest and seat cushion.

Fixed using M8 lateral fastenings with 290 mm spacing.

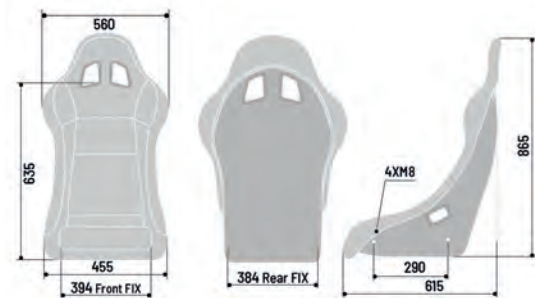

008014RNR

UNPARALLELED COMFORT AND PERFORMANCE.



Non-slip fabric for shoulder and seat restraint.

Divisible legrest and seat cushion.

Fixed using M8 lateral fastenings with 290 mm spacing.

008007RNR

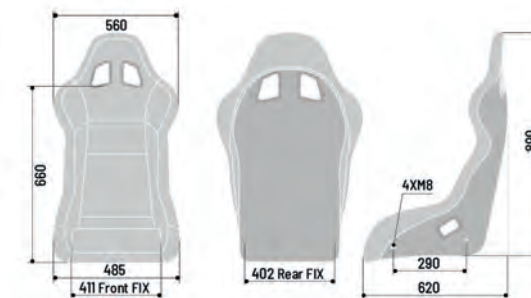

EVO L/XL QRT

NEW



MANUFACTURER: SPARCO
MODEL: EVO L QRT
HOM. NO: CS.432.19
FIA STANDARD: 8855-1999

EVO SKY QRT

NEW



MANUFACTURER: SPARCO
MODEL: EVO QRT
HOM. NO: CS.373.17
FIA STANDARD: 8855-1999

HOMOLOGATION: FIA 8855-1999 ■ **MATERIAL:** QRT ■ **EVO L QRT WEIGHT (gr):** SHELL 6700 - SEAT 7900I
EVO XL QRT WEIGHT (gr): SHELL 6500 - SEAT 7700

UNPARALLELED COMFORT AND PERFORMANCE.



Non-slip fabric for shoulder and seat restraint.

Divisible legrest and seat cushion.

Fixed using M8 lateral fastenings with 290 mm spacing.

008013RNR



EVO XL QRT



MANUFACTURER: SPARCO
MODEL: EVO XL QRT
HOM. NO: CS.433.19
FIA STANDARD: 8855-1999

008015RNR

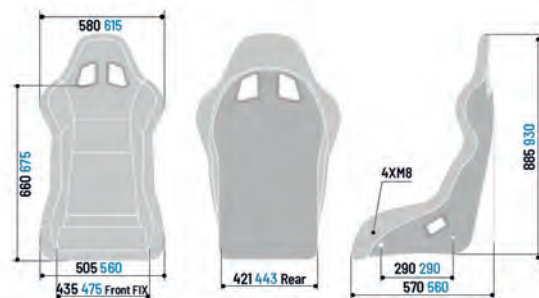

UNPARALLELED COMFORT AND PERFORMANCE.



Sky upholstery.

Non-slip fabric for shoulder and seat restraint.

Divisible legrest and seat cushion.

Fixed using M8 lateral fastenings with 290 mm spacing.

008007RNRSKY

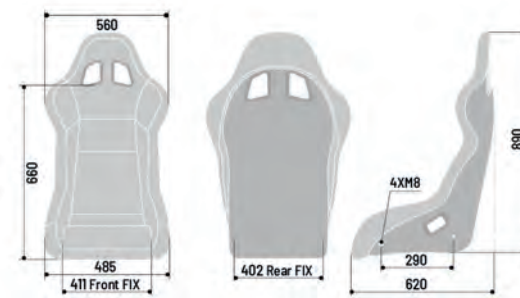

GRID Q

FIA APPROVED
 MANUFACTURER: SPARCO
 MODEL: GRID Q
 HOM. NO: CS.407.18
 FIA STANDARD: 8855-1999

GRID-Q SKY

NEW

FIA APPROVED
 MANUFACTURER: SPARCO
 MODEL: GRID Q
 HOM. NO: CS.407.18
 FIA STANDARD: 8855-1999



HOMOLOGATION: FIA 8855-1999 ▪ **MATERIAL:** QRT ▪ **WEIGHT (gr):** SHELL 6500 - SEAT 7300

TOP-LEVEL VERSATILITY.



Non-slip fabric for shoulder and seat restraint.



Divisible legrest and seat cushion.

Fixed using M8 lateral fastenings with 290 mm spacing.

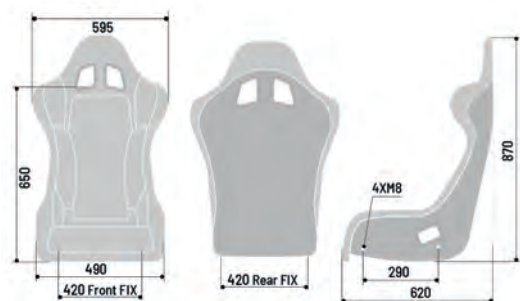

008009RNR

HOMOLOGATION: FIA 8855-1999 ▪ **MATERIAL:** QRT ▪ **WEIGHT (gr):** SHELL 6500 - SEAT 7700

TOP-LEVEL VERSATILITY.



Customisable padded pads applied with hook and loop fastener.



Sky upholstery.

High mobility due to small footprint.

Fixed using M8 lateral fastenings with 290 mm spacing.

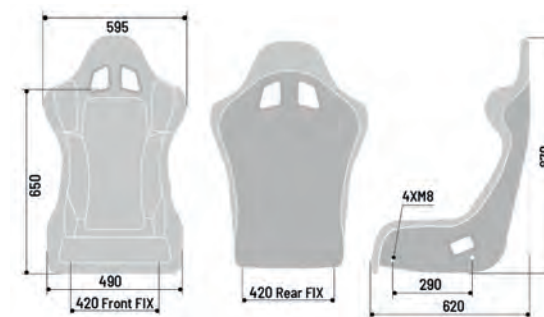

008009RNRSKY

PRO 2000 QRT NEW

FIA APPROVED
 MANUFACTURER: SPARCO
 MODEL: PRO 2000 QRT
 HOM. NO: CS.424.19
 FIA STANDARD: 8855-1999

HOMOLOGATION: FIA 8855-1999 ■ **MATERIAL:** QRT ■ **WEIGHT (gr):** SHELL 6800 - SEAT 8000

SEAT WITH INTEGRATED LUMBAR SIDE BACKREST.

QRT
 TECHNOLOGY ▶ PAG.7



Non-slip fabric for shoulder and seat restraint.

Lateral kidney supports.



Divisible legrest and seat cushion.

Lower fixed directly on M8 271x345 base.

Fixed using M8 lateral fastenings with 290 mm spacing.

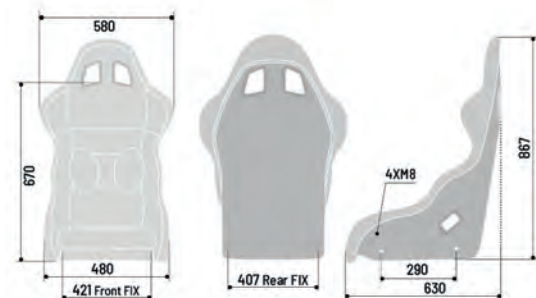

008016RNR

CIRCUIT/II QRT NEW

FIA APPROVED
 MANUFACTURER: SPARCO
 MODEL: CIRCUIT QRT 20
 HOM. NO: CS.431.19
 FIA STANDARD: 8855-1999

HOMOLOGATION: FIA 8855-1999 ■ **MATERIAL:** QRT ■ **CIRCUIT QRT WEIGHT (gr):** SHELL 7100 - SEAT 8600
CIRCUIT II QRT WEIGHT (gr): SHELL 7200 - SEAT 9600

M-SPORT FORD FIESTA R2 OFFICIAL EQUIPMENT.

QRT
 TECHNOLOGY ▶ PAG.7

Head Restraint System integrated.

Non-slip fabric for shoulder and seat restraint.



Divisible legrest and seat cushion.

Fixed using M8 lateral fastenings with 290 mm spacing.

008019RNR



008011RNR

CIRCUIT II

FIA APPROVED

MANUFACTURER: SPARCO
 MODEL: CIRCUIT II QRT
 HOM. NO: CS.408.18
 FIA STANDARD: 8855-1999



SPRINT/SPRINT L



SPRINT SKY



HOMOLOGATION: FIA 8855-1999 - **MATERIAL:** TUBULAR STEEL FRAME
SPRINT WEIGHT (gr): SHELL 7940 - SEAT 9000 - **SPRINT L WEIGHT (gr):** SHELL 10400 - SEAT 11000

HOMOLOGATION: FIA 8855-1999 - **MATERIAL:** TUBULAR STEEL FRAME - **WEIGHT (gr):** SHELL 7940 - SEAT 9700



008235RS 008235AZ 008235NR



008235NRSKY

SPRINT L

MANUFACTURER: SPARCO
MODEL: SPRINT L
HOM. NO: CS.314.14
FIA STANDARD: 8855-1999

008234LAZ 008234LRS 008234LNR

ACCESSORIES

SIDE SEAT

130

FIA-APPROVED MOUNTING FRAMES FOR SEATS WITH SIDE MOUNTING

004903



Longitudinal distance between holes 290 mm. 2 symmetrical pieces. Max length 415 mm. Simple mounting in the car with more than 25 positions. 6 mm anodized aluminium, FIA compliant. M8 mounting kit included.

00492LAT

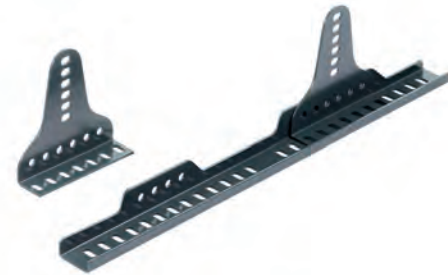

Dismountable mounting frame made of Steel. Maximum height and length adjustability. New L shape of the lateral element to allow a double lockage with the base element. New C shape of the base element to increase the grip of the lateral element. 22 eyelets on the base element.

FIA-APPROVED MOUNTING FRAMES FOR SEATS WITH SIDE MOUNTING

004902



Longitudinal distance between holes 290 mm. 2 symmetrical pieces. Max length 400 mm. Simple mounting in the car with more than 25 positions. 3 mm black powder coated, FIA compliant. M8 mounting kit included.

004901NR



Longitudinal wheelbase 290 mm. 3mm thick steel.

SUBFRAMES FOR BOTTOM MOUNTING.

FOR THE COMPLETE APPLICATION LIST SEE THE PRICE LIST.



ACCESSORIES

GI

131

DRIVER DRINK

01045NR

Drink bag. Insulates from outside heat and keeps drinks at a constant temperature. Holds 1.5 litres, inner bottle and spout also available as spare parts. Four braces for attachment to the seat.



OPTIONAL PADDING



Pair of side cushions suitable for FIA 8855-1999 seats.

04108009PAD

NEW



Leg support cushion.

01011



Pair of lumbar side backrests.

01022



Universal lumbar backrest.

01023

OPTIONAL CUSHION



SEAT
REV
EVO
EVO L
EVO XL
PRO 2000

CODE
01048B
01048B
01048A
01048A
01048A
01048A

SEAT
CIRCUIT
CIRCUIT II
PRO-ADV
PILOT
PRO-ADV CARB

CODE
01048C
01048C
01048A
01048A
01048A



**FASTEN YOUR SEATBELT,
IT'S TIME TO RACE.**



RACING Harnesses



HARNESSES INDEX

MADE IN ITALY

134

HOMOLOGATION 8853-2016

PRIME H-10 	NEW	TYPE	FIXING	ANCHORAGE POINT	 04822H
		FORMULA	DOGBONE	6 POINTS	

PRIME H-9	TYPE	FIXING	ANCHORAGE POINT	 04820HNR
	RALLY/SALOON	ROLLCAGE/ CARABINER	6 POINTS	

PRIME H-7	TYPE	FIXING	ANCHORAGE POINT	 04821HMRS 04821HMAZ 04821HMNR
	RALLY/SALOON	ROLLCAGE/ SNAP ON/ CARABINER	6 POINTS	

04818HAL1	TYPE	FIXING	ANCHORAGE POINT	 04818HAL1RS 04818HAL1AZ 04818HAL1NR
	RALLY/SALOON	ROLLCAGE/ SNAP ON	6 POINTS	

04818RH1	TYPE	FIXING	ANCHORAGE POINT	 04818RH1RS 04818RH1AZ 04818RH1NR
	RALLY/SALOON	ROLLCAGE/ SNAP ON	6 POINTS	

04818RHALPD1	TYPE	FIXING	ANCHORAGE POINT	 04818RHALPD1RS 04818RHALPD1AZ 04818RHALPD1NR
	RALLY/SALOON	ROLLCAGE/ SNAP ON	6 POINTS	

04818RAL	TYPE	FIXING	ANCHORAGE POINT	 04818RALRS 04818RALAZ 04818RALNR
	RALLY/SALOON	ROLLCAGE/ SNAP ON	6 POINTS	

GI

135

HOMOLOGATION 8853-2016

04818RAC	TYPE	FIXING	ANCHORAGE POINT	 04818RACRS 04818RACAZ 04818RACNR
	RALLY/SALOON	ROLLCAGE/ SNAP ON	6 POINTS	

04818RALPD	TYPE	FIXING	ANCHORAGE POINT	 04818RALPDRS 04818RALPDZ 04818RALPDNR
	GT/SALOON	ROLLCAGE/ SNAP ON	6 POINTS	

04823H	NEW	TYPE	FIXING	ANCHORAGE POINT	 04823HNR
		FORMULA	DOGBONE ON SHOULDER/ BOLT ON	6 POINTS	

04819H2	TYPE	FIXING	ANCHORAGE POINT	 04819H2RS 04819H2AZ 04819H2NR
	FORMULA	ROLLCAGE/ BOLT ON	6 POINTS	

04831H	NEW	TYPE	FIXING	ANCHORAGE POINT	 04831HNR
		FORMULA	DOGBONE ON SHOULDER/ BOLT ON	8 POINTS	

8854-1998

04716M1	TYPE	FIXING	ANCHORAGE POINT	 04716M1RS 04716M1AZ 04716M1NR
	RALLY/SALOON	SNAP ON	4 POINTS	

04806SFI 04806SFIVDM	TYPE	FIXING	ANCHORAGE POINT	 04806SFIVD 04806SFIVDM 04806SFINR
	OFFROAD/ OFFSHORE	SNAP ON	5 POINTS	

RACING Harnesses

RACING Harnesses

PRIME H-10

NEW



MANUFACTURER: SPARCO
MODEL: 04822H
HOM. NO: SH.060.19-T-6
FIA STANDARD: 8853-2016

HOMOLOGATION: FIA 8853-2016



6 point seat belt.
2" specific HANS shoulder straps.
Full release titanium buckle.
Aluminium adjusters.
Dogbone fixing (screw fixing on request).
McLaren F1 racing and Alfa Romeo racing officiale equipment.

04822HNR

PRIME H-9



MANUFACTURER: SPARCO
MODEL: 04820H
HOM. NO: SH.053.18-T-6
FIA STANDARD: 8853-2016

HOMOLOGATION: FIA 8853-2016



6 point seat belt.
2" specific HANS shoulder straps.
Aluminium buckle.
Ultra-light ultra-resistant steel adjusters.
Roll-cage fastening for shoulder and thigh straps,
abdominals with karabiner for 7/16 eyebolt.

04820HNR

PRIME H-7



MANUFACTURER: SPARCO
MODEL: 04821RH
HOM. NO: SH.019.17-T-6
FIA STANDARD: 8853-2016

HOMOLOGATION: FIA 8853-2016



6 point seat belt.
2" specific HANS shoulder straps.
Aluminium buckle.
High resistance steel adjusters.
Roll-cage fastening for shoulder and thigh straps,
abdominals with karabiner for 7/16 eyebolt.
M-Sport racing team Official WRC2 Championship
harness equipment.

04821HMNR 04821HMAZ

04821HMRS

04818RHAL1



MANUFACTURER: SPARCO
MODEL: 04818RH
HOM. NO: SH.005.16-T-6
FIA STANDARD: 8853-2016

HOMOLOGATION: FIA 8853-2016



6 point seat belt.
3" specific HANS shoulder straps with reduction to 2".
Aluminium buckle.
Aluminium shoulder and abdominal strap adjusters.
Pull-up adjustment on abdominal straps.
Snap-hook fasteners on all straps.
Possibility of roll-cage fixing on shoulder and thigh straps.

04818RHAL1NR 04818RHAL1AZ

04818RHAL1RS

04818RH1



HOMOLOGATION: FIA 8853-2016



6 point seat belt.
3" specific HANS shoulder straps with reduction to 2".
Aluminium buckle.
Steel shoulder and abdominal strap adjusters.
Pull-up adjustment on abdominal straps.
Snap-hook fasteners on all straps.
Possibility of roll-cage fixing on shoulder and thigh straps.



04818RAL



HOMOLOGATION: FIA 8853-2016



6 point seat belt.
3" specific shoulder straps.
Aluminium buckle.
Aluminium adjusters.
Snap-hook fasteners on all straps.
Rollbar fixing by removing the snap-hook.



04818RHALPD1



HOMOLOGATION: FIA 8853-2016



6 point seat belt.
3" specific HANS shoulder straps with reduction to 2".
Aluminium buckle.
Aluminium shoulder and abdominal strap adjusters.
Pull-down adjustment on abdominal straps.
Snap-hook fasteners on all straps.
Possibility of roll-cage fixing on shoulder and thigh straps.



04818RAC



HOMOLOGATION: FIA 8853-2016



6 point seat belt.
3" specific shoulder straps.
Aluminium buckle.
Snap-hook fasteners on all straps.
Rollbar fixing by removing the snap-hook.



04818RALPD



04819H2



HOMOLOGATION: FIA 8853-2016

HOMOLOGATION: FIA 8853-2016



6 point seat belt.
2" specific HANS shoulder straps.
Aluminium buckle.
Steel buckle.
pull-down abdominal adjustment.
Snap-hook fasteners on all straps.
Rollbar fixing by removing the snap-hook.



6 point seat belt for single-seater.
2" specific HANS straps.
Aluminium buckle.
Steel adjusters on shoulder and abdominal straps.
Triangle screw fixings, 13 mm diameter hole,
roll-cage or dog bone mounting possible by
eliminating triangles.



04823H

NEW



04831H

NEW



HOMOLOGATION: FIA 8853-2016

HOMOLOGATION: FIA 8853-2016



6 point seat belt for single-seater.
2" specific HANS straps.
Aluminium buckle with short lever.
Aluminium adjusters only on shoulder straps.
Adjustable abdominal and thigh straps.
Fixings: loop with tribar on each
branch for dog bone fixing.



8 point seat belt for single-seater.
2" specific HANS straps and 3" for body contact.
Aluminium buckle with short lever.
Aluminium adjusters only on shoulder straps.
Adjustable abdominal and thigh straps.
Fixings: loop with tribar on each
branch for dog bone fixing.



04716M1



HOMOLOGATION: 8854-1998



4 point seat belt.
Aluminium buckle.
High resistance steel adjusters.
Snap-hook fasteners on all straps.

04716M1NR

04806SFI

HOMOLOGATION: SFI



5 point seat belt.
Latch-n-link buckle.
3 colours available,
ideal for off-road vehicles and/or boats.

04806SFIVDM

04806SFINR

04806SFIVD

ACCESSORIES

PAIRS OF SHOULDER PADS

Pair of pads for 3" harnesses. Made of padded velour.
NOT FIREPROOF.



01098S3R

01098S3A

01098S3N

€ 3,00
VAT NOT INCLUDED



Thread 7/16
04502

€ 3,50
VAT NOT INCLUDED



Thread 7/16
04501

**RACING MAKES
THE WORLD GO ROUND.**





sparco





RACING Steering Wheels



STEERING WHEELS INDEX



146



F-10C 	TYPE	DIAMETER (mm)	 015PC270SSN
	FORMULA	270	



F-10A 	TYPE	DIAMETER (mm)	 015P270SSN
	FORMULA	270	

P310 	TYPE	DIAMETER (mm)	 015P310F2SN
	FORMULA/SALOON	310	



P300 	TYPE	DIAMETER (mm)	 015P300SN
	FORMULA/SALOON	300	



R353 	TYPE	DIAMETER (mm)	 015R353PSN
	RALLY/SALOON	330	



R368 	TYPE	DIAMETER (mm)	 015R368MSN
	RALLY	380	



R323 	TYPE	DIAMETER (mm)	 015R323PSNR
	RALLY/SALOON	270	



 MADE IN ITALY

R383 	TYPE	DIAMETER (mm)	 015R383PSN
	RALLY/SALOON	330	

R375 	TYPE	DIAMETER (mm)	 015R375PSN
	RALLY/SALOON	350	

R345 	TYPE	DIAMETER (mm)	 015R345MLN
	RALLY	350	

R215 	TYPE	DIAMETER (mm)	 015R215CSN
	RALLY	350	

R325 	TYPE	DIAMETER (mm)	 015R325CSN
	RALLY	350	

HUB

FOR THE APPLICATION LIST PLEASE CHECK PRICE LIST.



F-10C

148

MATERIAL: SUEDE



Carbon steering wheel for prototype single-seater and sports vehicle.



Hole interaxis 3x50.8 mm.

015PC270SSN

Ergonomic grip, designed based on experience gained with the racing teams of the most prestigious motor manufacturers.

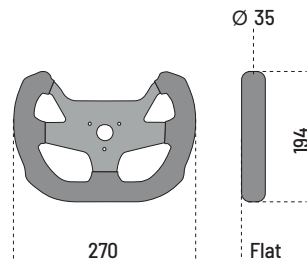

P310

DI®

149

MATERIAL: SUEDE



015P310F2SN

Flat steering wheel ideal for GT car.



Hole interaxis: 6x70 mm.

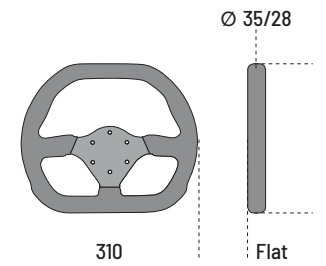

F-10A

MATERIAL: SUEDE



Aluminium steering wheel for prototype single-seater and sports vehicle.



Hole interaxis 3x50.8 mm.

Ergonomic grip, designed based on experience gained with the racing teams of the most prestigious motor manufacturers.

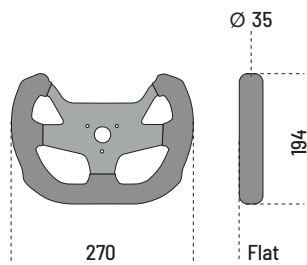

P300

MATERIAL: SUEDE



015P300SN

Hole interaxis: 6x70 mm.

Flat steering wheel with small grip.

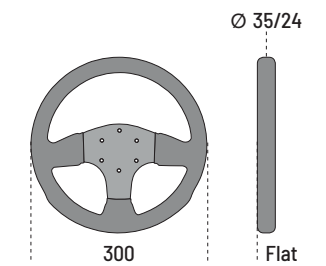

R353

150

MATERIAL: SUEDE



015R353PSN

Hole interaxis: 6x70 mm.

Flat steering wheel with large grip.

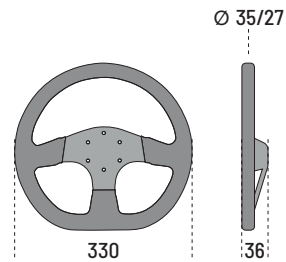

R323

DI

151

MATERIAL: SUEDE



015R323PSNR

Hole interaxis: 6x70 mm.

Dished steering wheel with small grip.

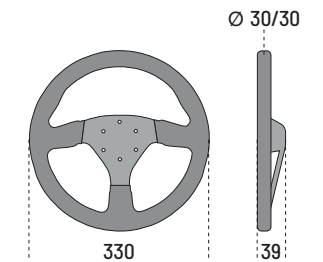

R368

MATERIAL: SUEDE



015R368MSN

Hole interaxis: 6x70 mm.

Dished steering wheel optimal for off-road use.

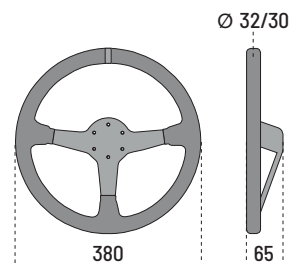

R383

MATERIAL: SUEDE



015R383PSN

Hole interaxis: 6x70 mm.

Steering wheel with special comfortable grip shape.

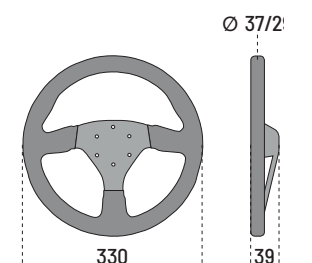

R375

152

MATERIAL: SUEDE



015R375PSN

Hole interaxis: 6x70 mm.

Special 36 mm dished.

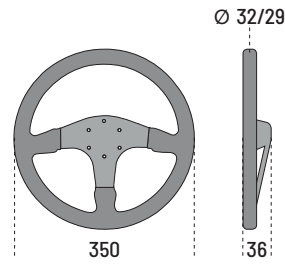

R215

DI

153

MATERIAL: SUEDE



015R215CSN

Hole interaxis: 6x70 mm.

Dished steering wheel with lighter spokes.

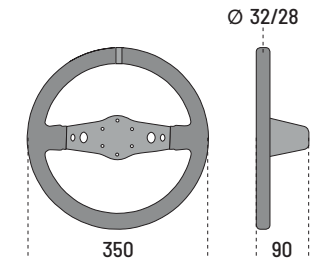

R345

MATERIAL: SUEDE/LEATHER



015R345MLN

015R345MSN

Hole interaxis: 6x70 mm.

Dished steering wheel with small grip.

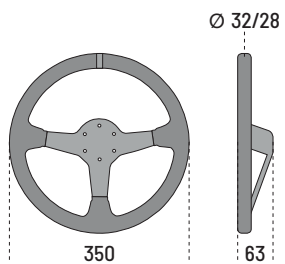

R325

MATERIAL: SUEDE



015R325CSN

Hole interaxis: 6x70 mm.

Dished steering wheel with three spokes and small grip.

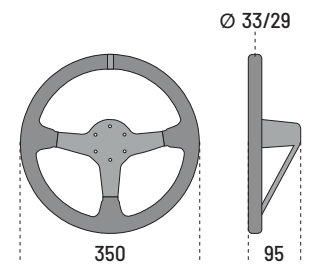

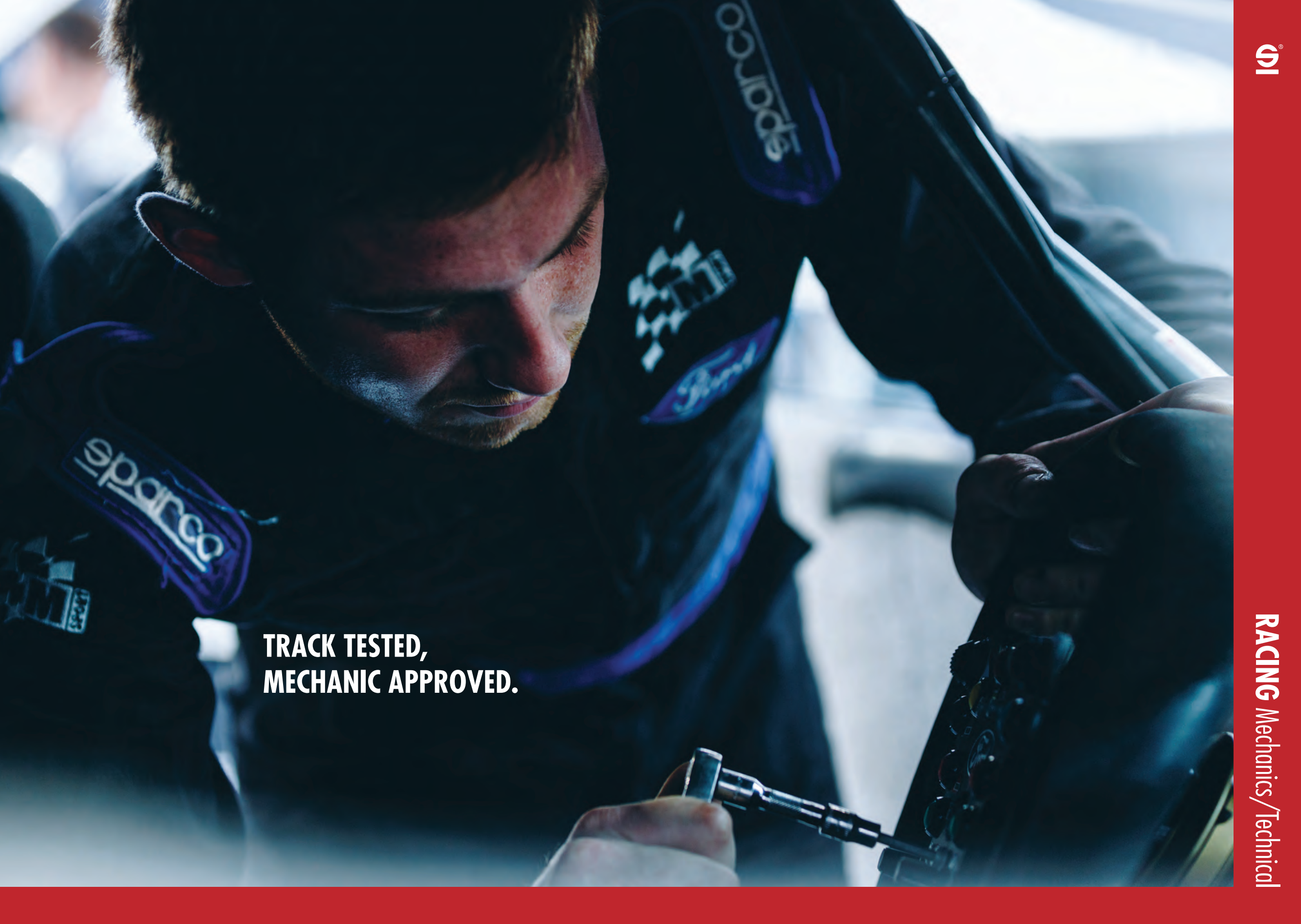

**TRACK TESTED,
MECHANIC APPROVED.**



Fully floating arm construction.



MS-D

FIA APPROVED
MANUFACTURER: SPARCO
MODEL: RMO-001
HOM. NO: MO.004.17
FIA STANDARD: 8867-2016

HOMOLOGATION: FIA 8867-2016 ■ **WEIGHT:** 360/390 G/M² ■ **SIZES:** S-XXXL ■ **LAYERS:** 2



Elasticated band



Side pockets



Adjustable waist



Large rear pockets

002013JNR..



002013PNR..





MS-5 NEW

HOMOLOGATION: NOT HOMOLOGATED ▪ **WEIGHT:** 170/190 G/M² ▪ **SIZES:** S-XXL ▪ **LAYERS:** 1



Reinforced elbow material



Elasticated back panel



Removable kneepads



002019NR..



002019GR..



MS-3

HOMOLOGATION: NOT HOMOLOGATED ■ WEIGHT: 230/250 G/M² ■ SIZES: S-XXL ■ LAYERS: 1



Front and side pocket



Adjustable wrist straps

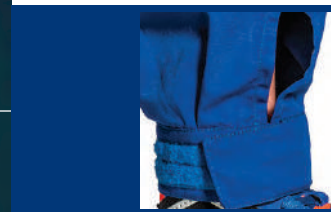

Adjustable ankle straps



002015RS..

002015AZ..



002015GR..

002015NR..

MECA

RMG-7



MANUFACTURER: SPARCO
MODEL: RMG-MECA
FIA STANDARD: 8856-2000

MECA III

SIZES: S-XL

162

HOMOLOGATION: FIA 8856-2000 ■ SIZES: 9-13

GI

163



001313NR..

Features: FIA homologated glove developed in conjunction with M-Sport for use by Bentley Team M-Sport.
Internal seams, pre-curved, deviated seam on thumb and index finger to avoid blisters and rubbing, reinforced with FR silicone coating. Inserts on back and wrist in shock-absorbing FR silicone, external reinforcements in FR silicone coating on the back, wrist and palms and in silicone transfers on the fingers to protect from heat and wear.



002093NR 002093AZ 002093RS

The backs of Meca-3 gloves are made from elasticised, printed, scuff resistant fabric. The palms are in synthetic, scuff resistant hide and there are reinforcements positioned between the thumb and index finger. Pads between the fingers provide better breathing. Hook and loop fastener belt for tighter fitting.

TIDE

MG-9



MANUFACTURER: SPARCO
MODEL: TIDE
FIA STANDARD: 8856-2000

MECA

OVERGLOVES

HOMOLOGATION: FIA 8856-2000 ■ SIZES: 8-12

SIZES: S/M/L



001303NR..

Gloves with preformed ergonomic high-grip palm, shock absorber and reinforced padded back.
COMPOSITION: 100% meta-aramid jersey. Palm with 3D "Volcano" HTX reinforcements (Sparco patent). Back with knitted aramid reinforcements with silicone coating.



00259NR..

MB CREW

NEW FIA 8856-2018



MANUFACTURER: SPARCO
MODEL: MB CREW
HOM. NO: DC.003.19-Z
FIA STANDARD: 8856-2018

HOMOLOGATION: FIA 8856-2018 - **SIZES:** 38-48

FEATURES: brand new shoe created in two types of leather, one very soft and one reinforced, to provide the best fit together with the maximum resistance to abrasion. Padded ankle, tongue and specific perforated areas for maximum breathability, double lacing system with ultra-flat laces and straps, distinctive Sparco lace holder pocket, elasticised rear insert, ultra-lightweight and breathable lining, ergonomic and shock-absorbing insole, EVA and TPU sole with pattern designed to facilitate the movements of mechanics and co-drivers.

001265..NR



MX-RACE

SIZES: 39-48

Two types of mesh: high breathability and texture quadrilateral mesh with honeycomb structure. Reinforcements and heel leather textured. Internal lacing system with ribbon loops. Anatomic pre-shaped inner sole. Antistatic VIBRAM sole in EVA, oil and hydrocarbons resistant.

FEATURES: Lightweight and breathable. High grip and shock absorber VIBRAM sole for maximum comfort and low stress. Laces in 2 different colours are provided with the package.

001216..NR

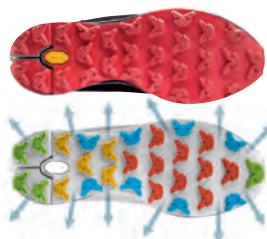

- GRIP
- TRACTION
- BRAKING
- CUSHIONING
- STABILITY
- SELF-CLEANING



DUNGAREES

SIZES: S-XXL

0020011NR..

0020011AZ..

Overall with pockets on front and sides.



RAIN CLOAK

SIZES: S/M - L/XL - XXL

002398..



TOOLS BELT

Radio belts, adjustable.



M-L
min 90 - max 120 cm

016451 ML

L-XXL
min 120 - max 150 cm

016451 LXL

TRACKMATE

Professional tool of telemetry data.



00537027



FIRE EXTINGUISHERS

 MADE IN ITALY

168

		ACTIVATION	TYPE	CAPACITY (LT.)	WEIGHT (KG.)	
FIA 2000	014772FEAL <small>NEW</small>	ELECTRIC	FORMULA	0,9	1,8	 014772FEAL
	014776EXL2 <small>NEW</small>	ELECTRIC	CIRCUIT	2	3,9	 014776EXL2
	014776EXL3 <small>NEW</small>	ELECTRIC	RALLY/ CIRCUIT	3	5,1	 014776EXL3
	014772EXL	ELECTRIC	RALLY/ CIRCUIT	4,25	6,7	 014772EXL
	014772MSL	MECHANIC	RALLY/ CIRCUIT	4,25	8,1	 014772MSL
ART. 253/J	014773BXL24 <small>NEW</small>	HAND HELD	RALLY	2,4	4,5	 014773BXL24
	014773BXLN2	HAND HELD	RALLY	2	3,4	 014773BXLN2
	EN3 014773BSS2	HAND HELD	RALLY	2	2,8	 014773BSS2

PERFORMANCE (PAG. 240)

	ACTIVATION	TYPE	ACTIVATION	WEIGHT (KG.)	
014775BXL2 <small>NEW</small>	HAND HELD	RALLY	2	2,8	 014775BXL2

014772FEAL

NEW

 **APPROVED**
 MANUFACTURER: SPARCO
 MODEL: SP425
 HOM. NO: EX.052.18
 FIA STANDARD: FIA 2000



169

HOMOLOGATION: FIA 2000

1.3 litre aluminium single-seater extinguishing system.
 AFFF extinguishing agent (0.9 litres).
 Pressurised to 16 Bar.
 Solid block-machined nozzles,
 all-metal connectors.



014772FEAL



MA0142083
MA0142082



MA0142029



MA014RL24CL



MA0142023



MA0142030



MA0142043



MA0142041



MA0142042



MA0142040

014776EXL2

NEW



014776EXL3

NEW



HOMOLOGATION: FIA 2000

Ultra-light, electrically activated extinguisher system.
 2.5 litre 160 mm diameter 180 mm
 high CE certified stainless steel cylinder
 (tested at over 40 Bar).
 AFFF extinguishing agent (2 litres.)
 Solid block-machined nozzles, all-metal connectors.



014776EXL2



MA0142049
MA0142046



MA0142029



MA014RL24CL



MA0142023



MA0142030



MA0142043



MA0142041



MA0142042



MA0142040

HOMOLOGATION: FIA 2000

Ultra-light, electrically activated extinguisher system.
 3.75 litre 160 mm diameter 235 mm
 high CE certified stainless steel cylinder
 (tested at over 40 Bar).
 AFFF extinguishing agent (3 litres).
 Solid block-machined nozzles, all-metal connectors.



014776EXL3



MA0142049
MA0142046



MA0142029



MA014RL24CL



MA0142023



MA0142030



MA0142043



MA0142041



MA0142042



MA0142040

014772EXL



014772MSL



Ultra-light, electrically activated extinguisher system.
 CE certified bottle in stainless steel (tested at over 40 Bar).
 AFFF foam extinguisher (4.25 litres).
 Solid block-machined nozzles, all-metal connectors.



Mechanically activated extinguisher system.
 CE certified bottle in steel (tested at over 40 Bar).
 AFFF foam extinguisher (4.25 litres).
 Solid block-machined nozzles, all-metal connectors.

014772EXL

014772MSL



MA0142013
 MA0142049
 MA01480



MA0142029



MA014RL24CL



MA0142023



MA0142013
 MA0142049
 MA01480



MA0142029



MA014RL24CL



MA0142023



MA0142030



MA0142043



MA0142041



MA0142043



MA0142041



MA0142042



MA0142040



MA0142042



MA0142040

HAND HELD EXTINGUISHERS

174

014773BXLN2

014773BXLN2

Ultra-light FIA approved extinguisher.
2 litre Novec extinguishing agent.



014773BXL24 **NEW**

014773BXL24

Ultra-light FIA approved extinguisher.
2.4 litre AFFF extinguishing agent.
3.9 litre stainless steel cylinder (h 345 mm diameter 130).



014773BSS2 

014773BSS2

Hand-held extinguisher 2.0 kg EN3 compliant powder.
complete with 2 brackets.
Ultra-light FIA approved extinguisher.



ROLL BAR

GI

175

FEATURES

Passage adhering to the body shell wherever possible. Accurate manufacturing. Specific boxed reinforcements. Made with certified material. Front suspension fixing points on some models.

- 1A Multipoint welded-in, 25CrMo4 with front suspension fixing points.
- 1B Multipoint welded-in, Fe45 with front suspension fixing points.
- 2A Multipoint built-in, 25CrMo4 with front suspension fixing points.
- 2B Multipoint built-in, Fe45 with front suspension fixing points.
- 3A 25CrMo4 roll cage without front suspension fixing points.
- 3B Fe45 roll cage without front suspension fixing points.
- 3C Weld-in roll cage without front suspension point.
- 4 Roll cages with door bars Fe 45.

FOR THE COMPLETE APPLICATION LIST PLEASE CHECK PRICE LIST.

1A-1B

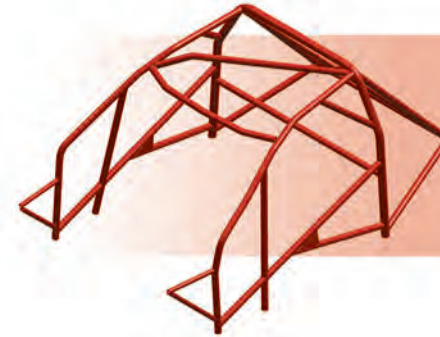

3A-3B-3C

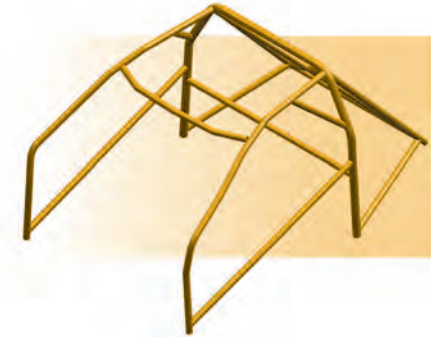

2A-2B

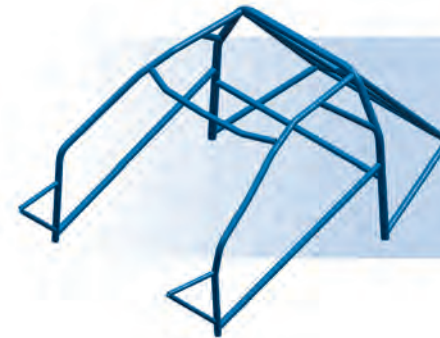

4



ROLL BAR PADDINGS



As from 01.01.2003 FIA-approved padding has become compulsory in all types of races and cars, Sparco supplies a material certified in accordance with FIA regulation 8857-2001. in different choices of length and diameter. The paddings are fitted to the roll cages in all possible points of contact with driver with harnesses fastened.



FIA APPROVED
 MANUFACTURER: SPARCO
 MODEL: FIA PADDING
 HOM. NO: CP.0003-03-A
 FIA STANDARD: 8857-2001

0076050
 Ø 50 mm - 500 mm - 122 g - Set 2 pcs



FIA APPROVED
 MANUFACTURER: SPARCO
 MODEL: FIA PADDING
 HOM. NO: CP.0003-03-A
 FIA STANDARD: 8857-2001

0076045
 Ø 45 mm - 500 mm - 131 g - Set 2 pcs



FIA APPROVED
 MANUFACTURER: SPARCO
 MODEL: FIA PADDING
 HOM. NO: CP.0003-03-A
 FIA STANDARD: 8857-2001

0076040
 Ø 40 mm - 500 mm - 129 g - Set 2 pcs



FIA APPROVED
 MANUFACTURER: SPARCO
 MODEL: 00706035
 HOM. NO: CP.008.17.A
 FIA STANDARD: 8857-2001

0076035
 Ø 35 mm - 500 mm - 135 g - Set 2 pcs

RACING START ADAPTATION KIT

00780KS

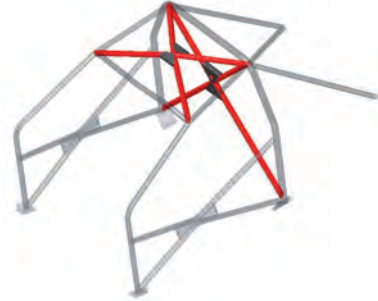

Racing start kit is proposed to upgrade the existing Appendix J roll cages. This kit is composed of 6 tubes to build up the cross reinforcement for the roof and the main roll bar, complete with reinforcement gussets.

DOOR BARS KIT

00797

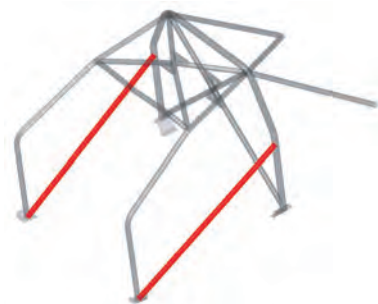

Universal kit composed of 2x door bars (diam. 40x2 mm) with 2x welded plugs on one side, 4x M 10 screws, 4x M10 self-locking bolts, 4x forks, 2x plugs.



00797

UNIVERSAL GUSSET KIT FOR ROOF

00798SP1

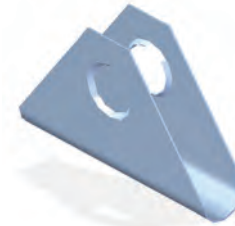

Kit composed of 2x universal reinforcement gussets to be mounted on the tubes' cross joint (dimensions 190x85 mm). This is a universal kit so it's could be necessary for the user to adapt it to his own roll cage.

UNIVERSAL GUSSET KIT FOR DOORBAR CROSS

00780M

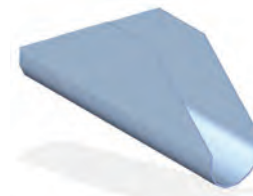

Kit composed of 4x universal reinforcement gussets to be mounted on the tubes' cross joint (dimensions 100x170 mm). This is a universal kit so it's could be necessary for the user to adapt it to his own roll cage.

ROLL CAGE PLUG

00782NTS



Forged plug for tubes' assembly, using plug + fork system.

ROLL CAGE FORK

00798SP1



Ø 40 mm

Ø 50 mm

0078140S

0078150S

Fork for tubes' assembly, using plug + fork system (tube diameter 40 mm) (tube diameter 50 mm).

ROLL CAGE PLUGS

00780M



Pair of perforated sleeves (diameter 45 mm) for tubes' assembly.

REINFORCEMENT PLATES + COUNTERPLATES FIA 2010 UPDATING KIT

00780P



Kit composed of 4x perforated plates + 4x flat counter plates (3 mm thick). These plates must be adapted in according to the different configurations of roll cages or body shells and allow to update the roll cage fixing in accordance with 2010 FIA regulation.

DRIVER FOOTRESTS

178

03780AN

Embossed anodised aluminium, with brackets, bolts and screws.



03788BRI (until stock last)

Footrest collapsible in the event of a crash. Embossed anodised aluminium.



PEDAL SETS

03775

Steel. Black.



03779AN

3 piece set in embossed anodised aluminium, complete with brackets, bolts and screws.



03783L



3-piece set in pre-bent and shaped mixed carbon. Brake and clutch with non-slip inserts.

BONNET PINS

Pair of stainless steel bonnet pins with captive slide pin.



01606S

01606AA

01606AR

01608

KIT OF 8 STICKERS

ASPA002



AERO FUEL CAPS

270050A

Without key.



27009G



HAMMERS

01615

Professional hammer.



01613

Hammer with seatbelt cutter built-in.



TYRE WARMERS

FOR THE APPLICATION LIST PLEASE CHECK PRICE LIST.



WINDOW NETS

- 002192FA-R
- 002192FA-G
- 002192FA-BM

Approved in compliance with FIA 2003 spec.
Dimensions: 50 cm long and 52 cm high.
hook and loop fastener tape for quick fastening to roll bar.

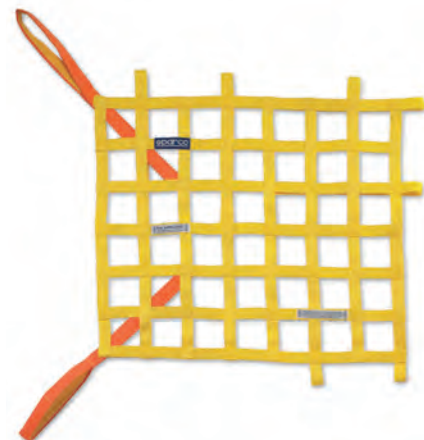

FIA 8863-2013 APPROVED WINDOW NET SPECIFICALLY FOR TRACK USE

Seat side fixing with 1" belts and 2 bar adjusters for fixing to rollbar.
Dashboard side fixing with optional double use:
- Quick release fixing with 1" strap.
- Quick release fixing 2" strap and spring-operated adjuster for better net tension .

002193NR

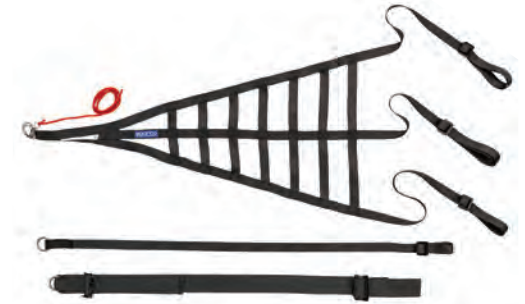

FIA APPROVED
MANUFACTURER: SPARCO
MODEL: 002193NR
HOM. NO: RN.008.16
FIA STANDARD: 8863-2013

002194NR

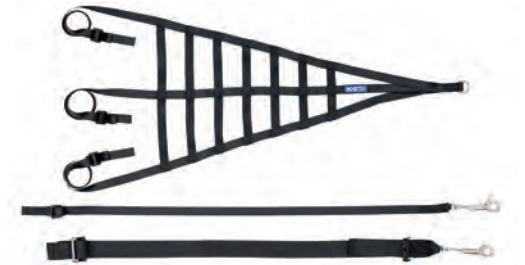

FIA APPROVED
MANUFACTURER: SPARCO
MODEL: 002194NR
HOM. NO: RN.011.17
FIA STANDARD: 8863-2013

PIT SIGNAL BOARD



Pit signal kit.
00594

4 row reflection-proof black aluminium frame.



Cover. 00594C
Number sets. 00592/1
Pit board. 00594T

MAPLIGHTS

01628



Led Reading lamp, length 49 cm, flexible tube, 12V.

PACENOTE BOOK

03725



TYRE PRESSURE GAUGES

2941463



Scale 0-4 bar, aluminium handle, rubber cap, high-precision recording.

29424101C



Scale 0-4 bar, aluminium handle, rubber cap, high-precision recording.

BATTERY MASTER SWITCH

01337



Battery master switch with rotating lever. Instant disconnection of all electric circuits. Provision for remote control. Complies with FIA spec. Suitable for 6, 12 and 24V systems, rated at 100A continuous.

01336



Bipolar master battery cutout switch with rotating lever. Instant disconnection of master electric circuit. Provision for remote control. Suitable for 6, 12 and 24V systems, rated at 100A continuous.

RACERS TAPE

01691

All-purpose heavy duty racer tape. Roll 50 mm wide x50 metres. 7 different colours.

01692

Aluminised tape. Roll 50 mm wide x50 m.

0169550

Transparent, scratchproof adhesive tape. Roll 50 mm wide x50 m.



01691

01692

0169550

03773



Universal spare wheel fastening with high-strength tape, complete with locking ratchet, 3 eyebolts and 3 fixing plates.

CIRCUIT/RALLY STOP-WATCH

29424103



TOWING EYE

01626G1 (until stock last)



Steel towing eye. Hole diameter 80 mm, FIA compliant.

01627G1 (until stock last)



Steel towing eye. Hole diameter 50 mm, FIA compliant.

01612RS



Ribbon towing eye. Hole diameter 13 mm, MAX load 3000 kg.

03776



Cross spanner fastening with retainer springs and anti-vibration rubber.

THE LOOK OF A CHAMPION.



KARTING Suits

SUITS INDEX

PRIME-K **NEW**

HOMOLOGATION	LAYERS	WEIGHT g/m ²	SIZES	CUSTOMIZATION
CIK-FIA N 2013-1	2	430-460	44-62	ON DEMAND

002307..NBRS 002307..EBNR 002307..NARS

PRIME-K YOUTH **NEW**

HOMOLOGATION	LAYERS	WEIGHT g/m ²	SIZES	CUSTOMIZATION
CIK-FIA N 2013-1	2	430-460	120-150	ON DEMAND

002307..NBRS 002307..EBNR 002307..NARS

X-LIGHT K **NEW**

HOMOLOGATION	LAYERS	WEIGHT g/m ²	SIZES	CUSTOMIZATION
CIK-FIA N 2013-1	2	370-400	44-62	CUSTOM EASY ON DEMAND

002339NBRS.. 002339GNAF.. 002339RBNR.. 002339BBNR.. 002339NRBI..

X-LIGHT K YOUTH **NEW**

HOMOLOGATION	LAYERS	WEIGHT g/m ²	SIZES	CUSTOMIZATION
CIK-FIA N 2013-1	2	370-400	120-150	ON DEMAND

002339NBRS.. 002339GNAF.. 002339RBNR.. 002339BBNR.. 002339NRBI..

KERB **NEW**

HOMOLOGATION	LAYERS	WEIGHT g/m ²	SIZES	CUSTOMIZATION
CIK-FIA N 2013-1	2	470-500	XS-XXL	BY STOCK

002341RNBO.. 002341..BNGB 002341BNBV.. 002341GNBG.. 002341NBAF.. 002341NBRS..

KERB LADY **NEW**

HOMOLOGATION	LAYERS	WEIGHT g/m ²	SIZES	CUSTOMIZATION
CIK-FIA N 2013-1	2	470-500	XXS-L	BY STOCK

002341LNRBF.. 002341LNRGF..

KERB YOUTH CHILD **NEW**

HOMOLOGATION	LAYERS	WEIGHT g/m ²	SIZES	CUSTOMIZATION
CIK-FIA N 2013-1	2	470-500	120-150	BY STOCK

002341RNBO.. 002341..BNGB 002341BNBV.. 002341GNBG.. 002341NBAF.. 002341NBRS..

KERB YOUTH GIRL **NEW**

HOMOLOGATION	LAYERS	WEIGHT g/m ²	SIZES	CUSTOMIZATION
CIK-FIA N 2013-1	2	470-500	120-150	BY STOCK

002341LNRBF.. 002341LNRGF..

THUNDER **NEW**

HOMOLOGATION	LAYERS	WEIGHT g/m ²	SIZES	CUSTOMIZATION
CIK-FIA N 2013-1	2	500-530	XS-XXL	BY STOCK

002342RSNR.. 002342AZRS.. 002342GSGE.. 002342NRAF.. 002342NRRS.. 002342NRAZ..

THUNDER YOUTH **NEW**

HOMOLOGATION	LAYERS	WEIGHT g/m ²	SIZES	CUSTOMIZATION
CIK-FIA N 2013-1	2	500-530	120-150	BY STOCK

002342RSNR.. 002342AZRS.. 002342GSGE.. 002342NRAF.. 002342NRRS.. 002342NRAZ..

ROOKIE **NEW**

HOMOLOGATION	LAYERS	WEIGHT g/m ²	SIZES	CUSTOMIZATION
NOT HOMOLOGATED	1	160-190	XS-XXL	NOT CUSTOMIZABLE

002343NRGF.. 002343NRRS.. 002343NREB..

THE INDICATED WEIGHT IS CALCULATED ON THE AVERAGE VALUE OF THE ANALYZED SAMPLES, THEREFORE IT IS POSSIBLE THAT IT WILL UNDERGO VARIATIONS.



Concealed zip.

Low collar.

Breathable insert outside calf.

PRIME K

NEW



MANUFACTURER: SPARCO
MODEL: K38 PRIME KS-10
HOM. NO: CIK-FIA 2013/023
FIA STANDARD: N 2013-1

HOMOLOGATION: CIK-FIA N2013.1 **CE** ■ **WEIGHT:** 430/460 G/M² ■ **SIZES:** 44-62
YOUTH SIZES: 120-150 ■ **CUSTOMIZATION:** FULLY PRINTABLE

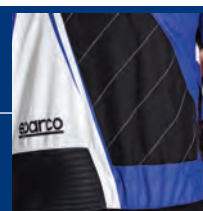

Anti-abrasion Cordura® back protection



Elasticated perforated back panel



Hidden hip pockets



002307..NBRS



002307..NARS



002307..EBNR



X-LIGHT K NEW



MANUFACTURER: SPARCO
 MODEL: K41 X-Light KS-7
 HOM. NO: CIK-FIA 2013/028
 FIA STANDARD: N 2013-1

HOMOLOGATION: CIK-FIA N2013.1 **CE** ■ **WEIGHT:** 370/400 G/M² ■ **SIZES:** 44-62
YOUTH SIZES: 120-150 ■ **CUSTOMIZATION:** CUSTOM EASY - ON DEMAND

Rounded collar.



Ergonomic impact-absorbing padding (on the outside elbow and inside knee)

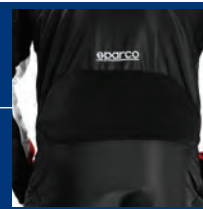

Elasticated anti-abrasion back panel

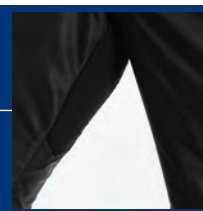

Breathable insert on inside leg and underarm

Hidden hip pockets.



002339NBRS..

002339GNAF..

002339RBNR..



002339BBNR..

002339NRBI..



Rounded collar.

Hidden hip pockets.

KERB

NEW



MANUFACTURER: SPARCO
MODEL: K44 KERB
HOM. NO: CIK-FIA 2013/047
FIA STANDARD: N 2013-1

HOMOLOGATION: CIK-FIA N2013.1 **CE** ■ **WEIGHT:** 470/500 G/M² ■ **SIZES:** XS-XXL
YOUTH SIZES: 120-150 ■ **CUSTOMIZATION:** BY STOCK



Elasticated back panel



Breathable inserts on inside leg and underarm



New waist adjustment using straps



002341RNBO..

002341BNGB..

002341BNBV..



002341GNBG..

002341NBAF..

002341NBR5..

KERB LADY

NEW



MANUFACTURER: SPARCO
MODEL: K44 KERB
HOM. NO: CIK-FIA 2013/047
FIA STANDARD: N 2013-1

HOMOLOGATION: CIK-FIA N2013.1 CE ■ WEIGHT: 470/500 G/M² ■ SIZES: XXS-L
YOUTH SIZES: 120-150 ■ CUSTOMIZATION: BY STOCK



Elasticated back panel.

Specific fit for women.

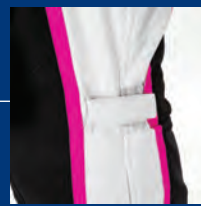

New waist adjustment using straps

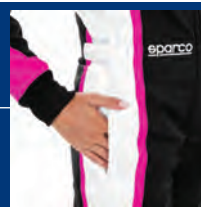

Hidden hip pockets

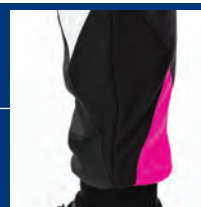

Breathable inserts on inside leg and underarm



002341LNRBF..



002341LNRGF..



Hidden hip pockets.

THUNDER

NEW



MANUFACTURER: SPARCO
MODEL: K43 THUNDER
HOM. NO: CIK-FIA 2013/046
FIA STANDARD: N 2013-1

HOMOLOGATION: CIK-FIA N2013.1 CE ■ WEIGHT: 500/530 G/M² ■ SIZES: XS-XXL
YOUTH SIZES: 120-150 ■ CUSTOMIZATION: BY STOCK



Low collar



Elasticated back panel



Breathable inserts on inside leg and underarm



002342RSNR..



002342GSGF..



002342NRAF..



002342NRRS..



002342NRAZ..



002342AZRS..

ROOKIE

NEW

HOMOLOGATION: NOT HOMOLOGATED CE ■ WEIGHT: 430/460 G/M² ■ SIZES: XS-XXL



Racing style cuffs and ankles.



Under arm elastic insert

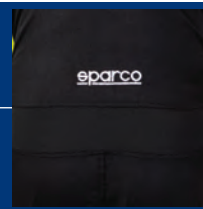

Rear elastic band

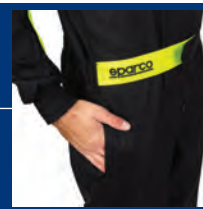

Hidden hip pockets



002343NRGF..



002343NRRS..



002343NREB..

**WE'VE GOT YOUR BACK,
AND SIDES.**



IL CARBONIO

RIB PRO K7

202

SIZES: XS-XXL ■ SHELL MATERIAL: CARBON FIBER

SIZES: XS-XXL ■ SHELL MATERIAL: HAND LAMINATED FIBERGLASS

GI

203



002404K..



F1-derived ultralight tape



High-strength tape



Adjustable width



Adjustable width



Ultra-strong hook and loop fastener



Ultra-strong hook and loop fastener



002403K..



S.I.TECH
SPARCO IMPACT TECHNOLOGY

Sparco Impact Technology: the new technology made in SPARCO® developed by combining a 4 mm EPDM material with a 6 mm PU foam that provides an incredible performance in terms of anti-vibration and shock absorber. All the energy absorption performances have been verified with an impact attenuation test foreseen by the EN 1621-2 standard with a mass of 2500 g (10 Joule) and a fall height of 50 cm.



S.I.TECH
SPARCO IMPACT TECHNOLOGY

Sparco Impact Technology: the new technology made in SPARCO® developed by combining a 4 mm EPDM material with a 6 mm PU foam that provides an incredible performance in terms of anti-vibration and shock absorber. All the energy absorption performances have been verified with an impact attenuation test foreseen by the EN 1621-2 standard with a mass of 2500 g (10 Joule) and a fall height of 50 cm.

SJ PRO K3

BASIC UNDERWEAR

SIZES: XS-XL - YOUTH SIZES: 120-140 - EXTERNAL MATERIAL: STRETCH POLYESTER



002402K..



Preformed and ergonomic back padding



Elastic band



Front zip closure



This protective jacket has been designed for both outdoor and indoor use, for the non-professional pilot who wants to ensure high shock absorption and anti-vibration performance without sacrificing comfort and lightness. The outer fabric is characterized by a great breathability combined with excellent resistance to abrasion and tearing. It is also breathable and antibacterial to ensure maximum comfort even during the most intense driving sessions. The padding on the back is preformed and the grooves have been specially developed to facilitate the pilot while driving. The frontal zip closure allows the pilot to wear the jacket quickly.



Flat seams thanks to the use of the extra thin thread.

00224B 00224N



Made of 100% Coolmax Jersey and perforated double.

Designed to be comfortable in a driving position.

00226B 00226N



Extra flat seams.

Single eye-opening.

002231B 002231N

KNEE PADS



00154KN

ELBOW PADS



00155EN

ENHANCE YOUR
CONNECTION.



SHOES INDEX

K-SKID NEW		MATERIAL	SOLE	SIZES	CUSTOMIZATION
		TUMBLLED LEATHER + PU LEATHER	NATURAL RUBBER	35-48	ON DEMAND



001277..NRAF 001277..BMBI 001277..RSNR 001277..NRNR

K-RUN NEW		MATERIAL	SOLE	SIZES	CUSTOMIZATION
		MESH 3D + MICROFIBER	NATURAL RUBBER	35-48	BY STOCK



001271..AZRS 001271..NRAF 001271..AZVF 001271..NRGF 001271..RSBI 001271..NRGR

K-RUN YOUTH NEW		MATERIAL	SOLE	SIZES	CUSTOMIZATION
		MESH 3D + MICROFIBER	NATURAL RUBBER	26-28-30-32-34	BY STOCK



001271..AZRS 001271..NRAF 001271..AZVF 001271..NRGF 001271..RSBI 001271..NRGR

K-POLE NEW		MATERIAL	SOLE	SIZES	CUSTOMIZATION
		MICROFIBER	NATURAL RUBBER	35-48	-



001269..NRGF 001269..RSBI 001269..NRAF 001269..NRAZ 001269..BMBI 001269..NRNR

K-POLE YOUTH NEW		MATERIAL	SOLE	SIZES	CUSTOMIZATION
		MICROFIBER	NATURAL RUBBER	26-28-30-32-34	-



001269..NRGF 001269..RSBI 001269..NRAF 001269..NRAZ 001269..BMBI 001269..NRNR

K-POLE WP NEW		MATERIAL	SOLE	SIZES	CUSTOMIZATION
		MICROFIBER	NATURAL RUBBER	35-48	-



001269WP..NRNR

K-POLE WP YOUTH NEW		MATERIAL	SOLE	SIZES	CUSTOMIZATION
		MICROFIBER	NATURAL RUBBER	26-28-30-32-34	-



001269WP..NRNR

K-SKID **NEW**

SIZES: 35-48 ■ CUSTOMIZATION: ON DEMAND



001277..NRAF 001277..BMBI 001277..RSNR 001277..NRNR

K-RUN

NEW

SIZES: 35-48 ■ YOUTH SIZES: 26 - 28 - 30 - 32 - 34 ■ CUSTOMIZATION: BY STOCK



K-POLE

NEW

SIZES: 35-48 ■ YOUTH SIZES: 26 - 28 - 30 - 32 - 34





FEEL THE SPEED.



GLOVES INDEX

MADE IN ITALY

214

TIDE	NEW	PRECURVED	SEAMS	SIZES	CUSTOMIZATION
		YES	EXTERNAL	8-13	ON DEMAND - BY STOCK



00286..NRAF



00286..NRVF



00286..RSNR



00286..NRNR

ARROW	NEW	PRECURVED	SEAMS	SIZES	CUSTOMIZATION
		YES	EXTERNAL	7-12	BY STOCK



002557..BINR



002557..RSBI



002557..BMBI



002557..NRGF

RECORD	NEW	PRECURVED	SEAMS	SIZES	CUSTOMIZATION
		YES	EXTERNAL	7-13	BY STOCK



002555..AZRS



002555..NRBI



002555..NRGF



002555..NRRS

RECORD WP	NEW	PRECURVED	SEAMS	SIZES	CUSTOMIZATION
		YES	EXTERNAL	4-13	BY STOCK



002555WP..NR

RUSH	NEW	PRECURVED	SEAMS	SIZES	CUSTOMIZATION
		NO	INTERNAL	4-13	BY STOCK



002556..RSNR



002556..AZNR



002556..BXNR



002556..GRNR



002556..GRAF

CRW	NEW	PRECURVED	SEAMS	SIZES	CUSTOMIZATION
		NO	HEAT-SEALED	XXS-XL	-



00260NR..

TIDE

NEW

SIZES: 8-13 ■ CUSTOMIZATION: ON DEMAND - BY STOCK



TECHNOLOGY
PATENTED
ALL RIGHTS RESERVED

HTX

PAG.7

Ergonomic seam.

Touch-S on index finger and thumb.

Thumb joined to back.

HTX 3D Volcano palm with differentiated zones.

Precurved glove.

Internal wrist stitching.

PA elasticated jersey fabric.



00286..NRAF



00286..NRVF



00286..RSNR



00286..NRNR

ARROW

NEW

RECORD

NEW

216

SIZES: 7-12 ■ CUSTOMIZATION: BY STOCK

SIZES: 7-13 ■ CUSTOMIZATION: BY STOCK

GI

217



002557..BINR



002557..RSBI



002557..BMBI



002557..NRGF



002555..AZRS



002555..NRGF



002555..NRRS



002555..NRBI



RUSH

NEW

218

SIZES: 4-13 ■ CUSTOMIZATION: BY STOCK



002556..RSNR



002556..AZNR



002556..BXNR



002556..GRNR



002556..GRAF

WP ACCESSORIES

RECORD WATER PROOF GLOVE

GI®

219

SIZES: 4-13 ■ CUSTOMIZATION: BY STOCK



CRW GLOVE

SIZES: XXS/XL



WP ACCESSORIES

K-POLE WATER PROOF SHOES

SIZES: 35-48 YOUTH SIZES: 26 - 28 - 30 - 32 - 34

Evolution of the k-pole shoe in wp version.

NEW



Closure system with cables and rotor.

External lacing with adjustment.

Microfibre uppers with matt finish.

Internal lateral reinforcement insert.

Anatomical insole.

Natural rubber sole with differentiated grip texture.

001269WP..NRNR

WATER PROOF RALLY OVERSHOES

WATER PROOF RAIN BOOTS

SIZES: 35-48 YOUTH SIZES: 24-26-28-30-32

SIZES: S(38,5-40) - M(40-41,5)
L(41,5-43) - XL(43,5-45)

NEW



Neoprene 100% with external coating
80% Nylon + 20% Spandex.

Natural rubber sole.

002445..NRNR

002431..N

WP ACCESSORIES

WATER PROOF CLOAKS

T-1

SIZES T- 1: S-XXL ■ YOUTH SIZES: AVAILABLE

RAIN CLOAK

SIZES: S/M - L/XL - XXL

Karting rainwear.
Made of transparent material that doesn't become yellow.



00239T..

002398..

ACCESSORIES

222

NECK SUPPORT COLLARS

Characterized by a special rear anatomic shape and variable density padding (more consistent in the helmet support area and softer under the chin and in the spoiler) in order to reduce the weight of the helmet on the back.



001602AZNR-B

001602RSNR-B

001602GRNR-B

TIRE BAG

Light and strong.
Color: blue.



02719AZ

KART COVER

Professional, very wide to suit any type of kart, with outline for the steering wheel, case included. Two colors, silver/blue and silver/red.



02712R

02712A

ADHESIVE PROTECTION FOR SEATS

Adaptable to any type of seat. new density, softer.
Color: black.



02798



P. De Conto - 2 times World Kart Champion



sparco



NEW WORLD OF PROTECTION.



HELMETS INDEX

MADE IN ITALY



226

FULL FACE HELMETS

AIR KF-7W CARBON 	HOMOLOGATION	MATERIAL	SIZES	 003354
	SNELL K 2015	CARBON	XS-XL	

SKY KF-5W 	HOMOLOGATION	MATERIAL	SIZES	 003355	 003355NR
	SNELL K 2015	KEVLAR/ FIBERGLASS	XS-XXL		

GP KF-4W CMR 	HOMOLOGATION	MATERIAL	SIZES	 003358
	SNELL CMR 2016	KEVLAR/ FIBERGLASS	XS-L	

CLUB X-1	HOMOLOGATION	MATERIAL	SIZES	 003319	 003319N
	ECE 22-05	ATM (ADVANCED THERMO MATERIAL)	XS-XXL		

PAG. 84

AIR KF-7W

HOMOLOGATION: SNELL K 2015 ■ SIZES: SMALL SHELL from XS to M+ · LARGE SHELL FROM L to XL



Carbon fiber shell reinforced with carbon-kevlar.

Double size shell and polystyrene with ventilation ducts.

FIA homologated visor with continuous adjustment.

Removable, repositionable and washable interiors.

Predisposed for drink system.



CARBON		
XS	53-54	0033540XS
S	00335	0033541S
M	57-58	0033542M
M+	59	0033543ML
L	60	0033544L
XL	61	0033545XL



SKY

KF-5W

HOMOLOGATION: SNELL K 2015 ■ **SIZES:** SMALL SHELL from XS to M+ - LARGE SHELL from L to XXL



GP

KF-4W CMR

HOMOLOGATION: SNELL CMR 2016 ■ **SIZES:** XS - S - M - L



WHITE		
XS	53-54	0033550XS
S	55-56	0033551S
M	57-58	0033552M
M+	59	0033553ML
L	60	0033554L
XL	61	0033555XL
XXL	62	0033556XXL

MATT BLACK		
XS	53-54	0033550XSNR
S	55-56	0033551SNR
M	57-58	0033552MNR
M+	59	0033553MLNR
L	60	0033554LNR
XL	61	0033555XLNR
XXL	62	0033556XXLNR



WHITE		
XS	53-54	0033580XS
S	55-56	0033581S
M	57-58	0033582M
L	59	0033583L





TAKE ON THE STREETS.





SEATS INDEX

 MADE IN ITALY

232

SPX 	SHELL MATERIAL	LINING	 00974ZN
	CARBON	LEATHER/ ALCANTARA®	

QRT PERFORMANCE	SHELL MATERIAL	LINING	 008006RNR
	QRT	LEATHER/ ALCANTARA®	

STRADALE NEW	SHELL MATERIAL	LINING	 009101RNR
	QRT	SKY	

STRADALE PERFORMANCE NEW	SHELL MATERIAL	LINING	 009102RNR
	QRT	LEATHER/ ALCANTARA®	

R333	SHELL MATERIAL	LINING			
	TUBULAR FRAME	FABRIC	00965NRGRS	00965NRGR	00965NR

R100	SHELL MATERIAL	LINING				
	TUBULAR FRAME	FABRIC	00961NRRS	00961NRGR	00961NRAZ	00961NRNR

R100 SKY	SHELL MATERIAL	LINING	 00961NRSKY
	TUBULAR FRAME	SKY	

SPRINT PERFORMANCE NEW	SHELL MATERIAL	LINING	 00984GR
	TUBULAR FRAME	SKY/MICROFIBER	

HARNESSES INDEX

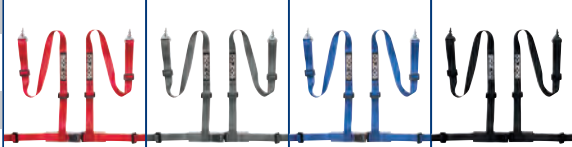

233

04604BM1	ANCHORAGE POINT					
	4 POINTS					
	TYPE	FIXING				
	CLUBMAN/ STRADALE	SNAP ON	04604BM1RS	04604BM1GR	04604BM1AZ	04604BM1NR

04608DF1	ANCHORAGE POINT					
	3 POINTS					
	TYPE	FIXING				
	CLUBMAN	SNAP ON	04608DF1RS	04608DF1GR	04608DF1AZ	04608DF1NR

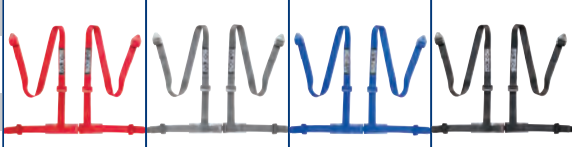
04604BV1	ANCHORAGE POINT					
	4 POINTS					
	TYPE	FIXING				
	CLUBMAN/ STRADALE	BOLT ON	04604BV1RS	04604BV1GR	04604BV1AZ	04604BV1NR

04608BV1	ANCHORAGE POINT					
	3 POINTS					
	TYPE	FIXING				
	CLUBMAN	BOLT ON	04608BV1RS	04608BV1GR	04608BV1AZ	04608BV1NR

ECE



Reclining carbon fiber seat that meets the same specifications as those imposed on OEMs.



Hand sewn.

Leather and Alcantara® upholstery.

Backrest with knob for millimetric adjustment.



Made with QRT technology.

Leather and Alcantara® upholstery.



€ 120,00
VAT NOT INCLUDED



0049616QRT

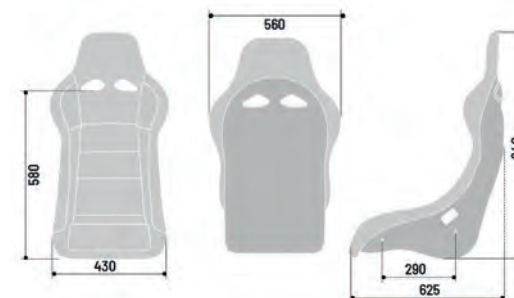
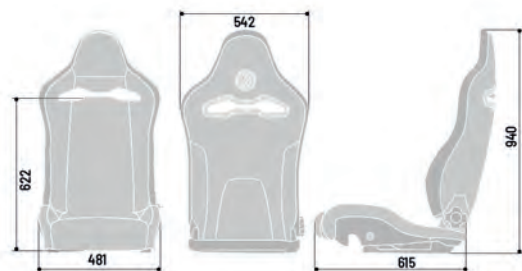

008006RNR

R333

236

COMPATIBLE WITH 3 AND 4 POINT SPORTS SEAT BELTS



Tubular frame.

Double adjustment lever and rapid tilting.

Lower 271x345 fixing.

00965NRGRS

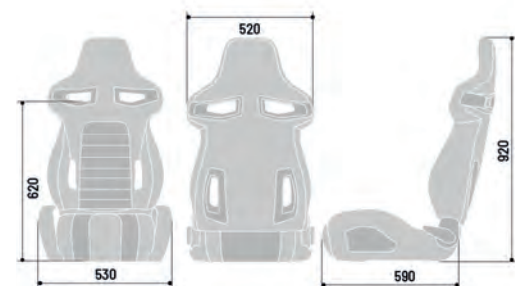

00965NRGR



00965NR

R100

R100 SKY

DI

237

COMPATIBLE WITH 3 AND 4 POINT SPORTS SEAT BELTS



R 100 SKY

00961NRSKY

€ 295,00
VAT NOT INCLUDED

3D or SKY fabric upholstery.

Lower 271x345 fixing.

Tubular frame.

Double adjustment lever and rapid tilting.

00961NRRS



00961NRGR

00961NRAZ

00961NRRR

STRADALE

NEW



238

STREET USE QRT SEAT



Lateral fixings 290 mm apart.

Seat without headrest for old school applications.



SKY upholstery.

009101RNR

STRADALE PERFORMANCE

NEW



STREET USE QRT SEAT

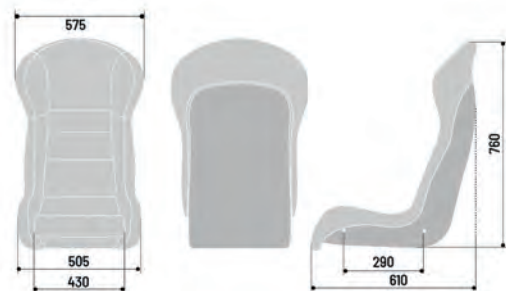

Seat without headrest for old school applications.

Leather and Alcantara® upholstery.

Lateral fixings 290 mm apart.



009102RNR

SPRINT PERFORMANCE

NEW



239

SKY UPHOLSTERY AND MICROFIBER



Tubular frame.

Elastic straps on seat and backrest for maximum comfort.



M8 lower fixings with 345 x 271 mm spacing.
Lateral M8 fixings with 290 mm spacing.

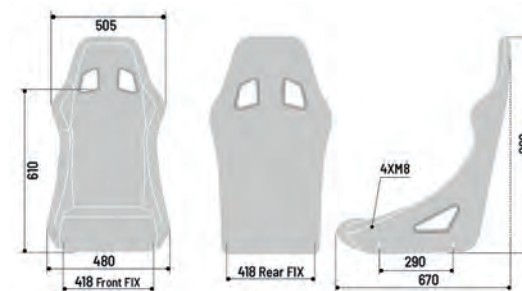

009846R

ACCESSORIES

SEAT SLIDES, SUBFRAMES FOR BOTTOM MOUNTING

240

04604BM1

HOMOLOGATION: ECE

GI®

241

ADAPTOR

00497RACE



For racing seats on seat rails.



For the complete application list see the price list.

SET OF SLIDE RUNNERS

0049302

00493



Longitudinal distance 271 mm.

UNIVERSAL FITTING KIT

00495



With 4 brackets with height adjustment, 2 reinforced aluminium corner pieces and the necessary screws and nuts.

TILT FORWARD BRACKET

00494

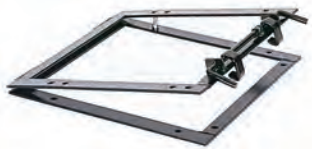

To be fitted between slides and subframes to allow easy access to the rear seats also on cars with front seats with fixed backrest.

UNIVERSAL SUBFRAME

00491



With mechanism to adjust the height of the seat, for cars with removable slides from the original seat with distance between slides up to 430 mm.



4 fixing points, snap on, lap reinforcement.

04604BM1RS 04604BM1GR 04604BM1AZ 04604BM1NR

04608DF1

HOMOLOGATION: ECE



3 fixing points, double buckle, snap on and lap reinforcement.

04608DF1RS 04608DF1GR
04608DF1AZ 04608DF1NR

MUD FLAPS

03791

03791RS

03791AZ

03791NR

Curved polyethylene mud guards kit thickness 1,5 mm not FIA compliant.



EXTINGUISHER

HAND HELD **NEW**

014775BXL2

Ultra-light extinguisher.
2.0 litre AFFF extinguishing agent.
Stainless steel cylinder complete with frame and clamp.



04604BV1

242

HOMOLOGATION: ECE



4 fixing point by bolt with lap reinforcement.

04604BV1RS 04604BV1GR 04604BV1AZ 04604BV1NR

GT

DI®

243



Thin microfiber pads.

01090R3RS 01090S4AZ 01090S4NR

04608BV1

HOMOLOGATION: ECE



3 bolted fixing points.

04608BV1RS 04608BV1GR
04608BV1AZ 04608BV1NR

MINI



Pair of pads in Microfiber with high grip neoprene inner layer. Useful to improve comfort of driving when fitted on steering wheels or handbrake handle.



01099RS 01099AZ 01099NR

HANDS ON PERFORMANCE.



PERFORMANCE Steering Wheels



STEERING WHEELS INDEX

MADE IN ITALY



246

TARGA 350 	DIAMETER (mm)	
		350



015TARGA350PLNR

CHAMPION 	DIAMETER (mm)	
		330



015R330CHAMPION

R383 CHAMPION 	DIAMETER (mm)		
		330	330



015R83PLUNRS 015R83PLUNNR

L777 	DIAMETER (mm)		
		350	350



015L800PL 015L800SC

L550 	DIAMETER (mm)	
		350



015TTMZS1

L575 	DIAMETER (mm)		
		350	350



015L750PL 015L750SC

L505 	DIAMETER (mm)	
		350



015TL522TUV

L360 	DIAMETER (mm)		
		330	330

015TRGL1TUV 015TRGS1TUV

L999 	DIAMETER (mm)	
		330

015TMG22TUV

P222	DIAMETER (mm)		
		345	345

015THPUGR345 015THPUNR345

TARGA 350

MATERIAL: LEATHER



Leather.

015TARGA350PLNR

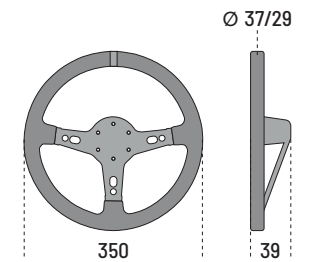

CHAMPION

MATERIAL: LEATHER



Leather.

015R330CHAMPION

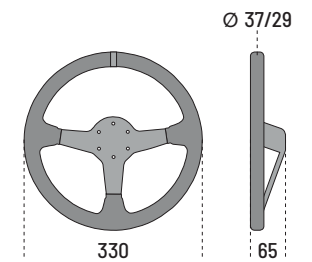

R383

CHAMPION

248

MATERIAL: LEATHER



L550

DI®

249

MATERIAL: SUEDE

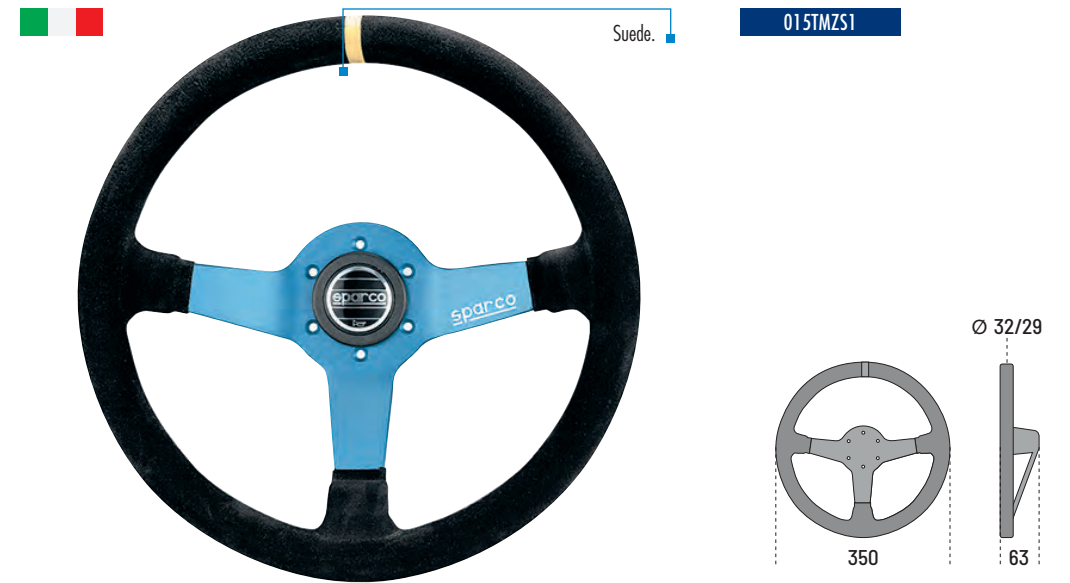

L777

MATERIAL: LEATHER/SUEDE



L575

MATERIAL: LEATHER/SUEDE



L505

250

MATERIAL: LEATHER



Leather.

015TL522TUV

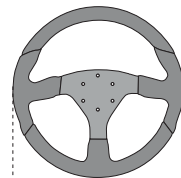

Ø 32/29

350

Flat

L999

GI®

251

MATERIAL: LEATHER AND SUEDE



Leather/Suede.

015TMG22TUV

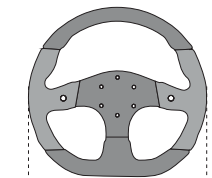

Ø 36/28

330

Flat

L360

MATERIAL: LEATHER/SUEDE

015TRGL1TUV



Leather.

015TRGS1TUV



Suede.

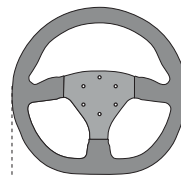

Ø 37/28

330

Flat

P222

MATERIAL: POLYURETHANE

015THPUGR345



Polyurethane.

015THPUNR345



Polyurethane.

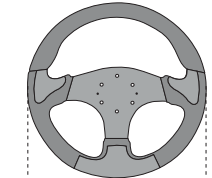

Ø 35/28

345

Flat

ACCESSORIES

PEDAL SETS / GEAR KNOBS

HUB

FOR THE APPLICATION LIST PLEASE CHECK PRICE LIST.

Sparco collapsible hubs are cast iron made with a steel frame that collapse during impacts. This item absorbs kinetics energy avoiding transfer to the driver. The Sparco steering wheels are TUV approved only if coupled with the Sparco hubs.



QUICK RELEASE STEERING BOSSES

015R98TU

CNC machined with steel spline. Black anodized and orange. Universal fixing system for 3 or 6 fixing point, steering hub, steering column.



RACING PUSH BUTTONS KIT

Black anodized supports with push buttons.

015NE981



015NE982



ANODIZED STEERING WHEEL SPACERS

01595ANR



RING

Anodized aluminium.

01599NR



PIUMA

Lightened grey/black gear knob.



03741BN01



03741BT01

SETTANTA

Titan/black two colour gear knob.



03736AT



03736A0

SPEED

Chromed gear knob with leather insert.



03744PTN

TECNO

Chromed or wrapped in perforated leather gear knob.



03747CR

CARBON

3-piece set in pre-bent and shaped mixed carbon. Brake and clutch with non-slip inserts.



03783L (NO ECE)

SETTANTA - OMOLOGAZIONE: ECE

Lightened universal black or silver pedal.



037879IT01

Set of pedals, long accelerator pedal.



0378790P01

0378790P01

MORE THAN A GAME.



SIM RACING

ADVANCED LINE

256

SIM RIG II

G02300B



AK RIG Sparco Edition PC MSI INFINITE-X + Logitech K400 wireless keyboard + Assetto Corsa Ultimate Edition.

SIM RIG I

G02302B



GI

257

SIM RACING

SIM RACING

SIM RACING

STARTER LINE

258

EVOLVE CARBON SIM RACING FRAME + EVOLVE CARBON MONOCOQUE GAMING SEAT

Cockpit with monocoque real carbon fibre gaming seat that guarantees high torsional rigidity together with very low weight for top performance and unmistakable Racing style. The lining has removable and movable ergonomic padding.



G01985ZNRRS

EVOLVE-E SIM RACING FRAME + EVO II MONOCOQUE QRT SEAT

Cockpit with monocoque QRT-technology gaming seat, lining with special areas of non-slip fabric for shoulder and seat restraint with cushion divided into 2 parts.



G018008RNR

EVOLVE-C SIM RACING FRAME + CIRCUIT I QRT MONOCOQUE GAMING SEAT

Cockpit with monocoque QRT-technology gaming seat, with integrated DTC system. The lining is made of special areas of non-slip fabric for shoulder and seat restraint with cushion divided into 2 parts.



G018010RNR

EVOLVE-G SIM RACING FRAME + MONOCOQUE GRID-Q QRT SEAT

Cockpit with monocoque QRT-technology gaming seat, lining with ergonomic and moveable padding and special areas of non-slip fabric for shoulder and seat restraint with cushion divided into 2 parts.



G018802FNR

EVOLVE-P SIM RACING FRAME + PRO2000 MONOCOQUE QRT SEAT

Cockpit with monocoque QRT gaming seat, with non-slip fabric for shoulder and seat restraint, backrest with side kidney rest kit and slim cushion.



G018282FNR

EVOLVE-R SIM RACING FRAME + R100 TUBULAR FRAME RECLINING SEAT

Cockpit with a tubular frame reclining seat, covered with soft, resistant and breathable fabric.



G01961NRRS

ACCESSORIES

260

EVOLVE-RHS GEAR SHIFT AND HANDBRAKE SUPPORT

The RHS gear shift and handbrake support for Evolve, made of satin-finish steel, allows all handbrakes and sequential gear shifts on market (Thrustmaster, Fanatec and Logitech) to be installed. To be positioned on the right of the EVOLVE frame.

G02085NRRS



EVOLVE-LHS GEAR SHIFT AND HANDBRAKE SUPPORT

The LHS gear shift and handbrake support for Evolve, made of satin-finish steel, allows all handbrakes and sequential gear shifts on market (Thrustmaster, Fanatec and Logitech) to be installed. To be positioned on the left of the EVOLVE frame.

G02285NRRS



TM-STAND1 24" TO 49" MONITOR/TV SUPPORT

High quality contoured tubes with embossed powder coating and compact design to ensure maximum stability even with ultra-wide 49" monitors.

- Up to 5 height and inclination adjustments.
- Anti-friction bushing for easy and precise adjustment of the support height.
- VESA 75x75 and 100x100 fixing .
- Dimensions: L/D/H 570 mm x700 mm x (1135-1275 mm).
- 22.44" x 27.56" x (44.68"- 50.20").
- Compatible with all SPARCO EVOLVE series cockpits .
- MADE IN ITALY

G02385NRRS



ACCESSORIES

GI®

261

HYPERGRIP GLOVES - SIZES: 8-12

002094..NRRS

Gaming gloves designed for use with both steering wheels and PC and console controllers.

- Micro-perforated microfibre on the palm guarantees maximum ventilation without compromising grip.
- Perforations in the part of the palm that separates the fingers.
- "Touch-sensitive" thumb and index finger fingertips which are also reversible to allow their removal in "controller" configuration.
- Protective foam pads on the palm reduce the stress exerted on the hand.



T-SHIRT GT VENT - SIZES: S-XXL

01233..NRRS

The GT Vent t-shirt is made of top-quality perforated polyester which, in long gaming sessions, guarantees maximum comfort thanks to the high breathability of the product. The model sizes have been designed in such a way that the gaming t-shirt is comfortable when sitting in a car racing simulator or on a gaming seat. The 5-needle seams are flat and enhance the comfort of the gaming t-shirt.



EVERY DAY
POLE POSITION.

sparco



CHAIRS

STINT

264

DESIGN INSPIRED BY THE SPARCO R333 SEAT

Warning: this seat must not be used in a car, it is not a car seat.



Seat adjustable in height and inclination.



4D armrests with multidirectional movement.



Seat adjustable in height and inclination.

Sparco AIRFLOW system for maximum breathability.

Anti-tip device with 150° backrest lock.

Base with SGS/BIFMAX5.1/EN1335 certified piston.

Colour-coded base with kickplate.

Fitted with lockable Pro Caster wheels.



00988NRRS



00988NRVF



00988NRAZ



00988NRNR

CHAIRS

GRIP SKY

NEW

SI

265

GRIP SEAT VARIANT WITH SKY LINING - **CUSTOMIZATION:** EASY CUSHION APPLICATION ON VEP AREA

Warning: this seat must not be used in a car, it is not a car seat.



Seat adjustable in height and inclination.



2D armrests with multidirectional movement.



Special VEP and SKY fabric multi-material lining.

Reclinable backrest with micrometric lumbar adjustment.

Cushions and accessories easily installed with Hook and loop fastener on VEP.

Anti-tip device with 150°.

Backrest lock-base with SGS/BIFMAX5.1/EN1335 certified piston.

High-strength polymer spoke base with 5 solid wheels.



00989SKYNRRS



00989SKYNRCE



00989SKYNRAZ

CHAIRS

GRIP

NEW

266

GRIP SEAT VARIANT WITH FABRIC LINING - CUSTOMIZATION: EASY CUSHION APPLICATION ON VEP AREA

Warning: this seat must not be used in a car, it is not a car seat.



Seat adjustable in height and inclination.



2D armrests with multidirectional movement.

Cushions and accessories easily installed with Hook and loop fastener on VEP.

Backrest lock -base with SGS/BIFMAX5.1/EN1335 certified piston.



High-strength polymer spoke base with 5 solid wheels.



00989NRG1



00989NRVF



00989NRAZ

ICON

NEW

SI

267

SPARCO R100S CAR SPORTS SEAT REPLICA

Warning: this seat must not be used in a car, it is not a car seat.



Seat adjustable in height and inclination.

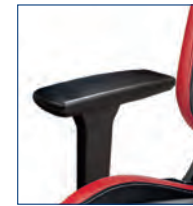

2D armrests with multidirectional movement.



High-strength polymer spoke base with 5 solid wheels.



00998NRRS



00998NRVD



00998NRAZ



00998NRNR

ACCESSORIES

CUSHIONS (COMPATIBLE WITH GRIP/GRIP SKY)

ERGONOMIC HEAD CUSHION



01024NR

NEW

LUMBAR SIDE BACKREST KIT



01022RS 01022AZ 01022NR

UNIVERSAL LUMBAR BACKREST



01023NR

ARMRESTS (COMPATIBLE WITH GRIP/GRIP SKY/ICON) NEW



010808BI



010808RS



010808VD



010808AZ



010808NR

SWIVEL BASES (COMPATIBLE WITH GRIP/GRIP SKY/ICON) NEW



010812BI



010812RS



010812VD



010812AZ



010812NR

ARMRESTS COVER (COMPATIBLE WITH GRIP/GRIP SKY/ICON) NEW

010810



PRO CASTER WHEELS

010811

COMPATIBLE WITH STINT, GRIP, GRIP SKY, ICON





**PERFORMANCE
ON THE GO.**



A. Giovannazzi - F1 driver

TEAMWEAR - BAGS - MERCHANDISING



TOP-TECH

SOFTSHELL

NEW

272

SIZES: XS - XXXL - COMPOSITION: 100% POLYESTER 270 GR/M²

Soft-shell in water-repellent multi-pocket fabric.



01253AZ..



01253BM..



01253NR..

FRAME

GILET

NEW

GI

273

SIZES: S - XXL - COMPOSITION: 100% POLYESTER 70 GR/M²

Wilson windstopper in water-repellent fabric with internal pocket.



01259BM..



01259NR..

TEAMWEAR

TEAMWEAR

WILSON

NEW

WINDSTOPPER

274

SIZES: S - XXXL ■ COMPOSITION: 100% POLYESTER 100 GR/M²

Wind-proof jacket with lightweight water-repellent hood.



02405AZ..



02405NR..

CLUB

NEW

FULL ZIP SWEATSHIRT

GI

275

SIZES: XS - XXXL ■ COMPOSITION: 100% POLYESTER 260 GR/M²

Full zip sweatshirt in Scooba 3D fabric with side pockets and breathable inserts.



01254AZ..



01254BM..



01254NR..

PRO-TECH

NEW

POLO

276

SIZES: XS - XXXL ■ COMPOSITION: 62% COTTON/30% POLYESTER/8% SPANDEX 220 GR/M²

Polo shirt in hollow fiber anti-perspiration technical fabric, collar with snap buttons and breathable inserts.



Polymer snap buttons.

Hollow fibre anti-perspiration technical fabric.

Breathable 3D mesh side inserts.



01255BI..

01255AZ..

01255BM..

01255NR..

TEAMWEAR

CRUISE

NEW

SHIRT LONG SLEEVES

SI

277

SIZES: XS - XXXL ■ COMPOSITION: 100% COTTON 140 GR/M²

Soft micro-Oxford cotton shirt with welt pocket and hidden buttons.



Button-down collar.

Hidden buttons.

Welt pocket.

Micro-Oxford cotton.

01257BI..

TEAMWEAR

SH-17

278

SIZES: 36 - 46

Leather and breathable fabric fashion sneakers.

Detail of the loop inspired by the curves of the R100s seat belt holes.



Detail on the heel inspired by the curves of the SPX seat belt holes



100% recyclable two-tone TPR sole.



001262..SIAZ

001262..NRRS

001262..BM

001262..NR

SL-17

SI®

279

SIZES: 36 - 46

Light leather low fashion shoe.

Detail of the loop inspired by the curves of the R100s seat belt holes.



Detail on the heel inspired by the curves of the SPX seat belt holes



P6 outsole racing inspired.



001263..BINR

001263..NRRS

001263..AZBI

001263..NRBI

TOUR

NEW

TROLLEY BAG

DIMENSIONS: H40 X L84 X P38 ■ **WEIGHT:** 4,7 KG ■ **CAPACITY:** 127 LT ■ **MATERIAL:** COATED POLYESTER

280

TRAVEL

NEW

SOFT CABIN SIZE TROLLEY

DIMENSIONS: H25 X L55 X P35 ■ **WEIGHT:** 3 KG ■ **CAPACITY:** 48 LT ■ **MATERIAL:** COATED POLYESTER

SI

281



TRIP NEW

BAG WITH SHOULDER STRAP

282

DIMENSIONS: H35 X L66 X P38 ■ **WEIGHT:** 2,1 KG ■ **CAPACITY:** 87 LT ■ **MATERIAL:** POLYESTER

Double handle with seat belt style straps.



Customised Sparco inner lining.

Internal pocket with zip closure.

Protective feet for the underside.

016439NRSI

STAGE NEW

RUCKSACK

GI®

283

DIMENSIONS: H40 X L30 X P14 ■ **WEIGHT:** 0,76 KG ■ **CAPACITY:** 16 LT ■ **MATERIAL:** POLYESTER

2 hidden front pockets with graphics that echo the Sparco seat belt slider.

Ergonomic padded and back lined with breathable mesh, horizontal band for inserting telescopic trolley bag handle.



Handle covered in soft-touch coated fabric.

Padded seat belt style shoulder straps.

Inner pocket for inserting PC up to 15".
Customised Sparco inner lining.



2 side pockets with hidden zip opening.



016440NRRS



016440NRAZ



016440NRNR

DRY-TECH

NEW

HELMET AND F.H.R. COLLAR BAG

284

DIMENSIONS: H35 X L35 X P40 ▪ **WEIGHT:** 1,3 KG ▪ **CAPACITY:** 49 LT ▪ **MATERIAL:** POLYESTER

Helmet drying system with USB 12V power cable.



Fan cover.

016441NRSI

Protective padding with racing suit style quilting. Customised Sparco inner lining.

Seat belt style shoulder strap.



CO-DRIVER

NAVIGATOR'S BAG

DIMENSIONS: H35 X L30 X P10 ▪ **CAPACITY:** 10,5 LT ▪ **MATERIAL:** POLYESTER

Bag developed with the co-drivers Ingrassia and Andreussi. Double closure.



Supplied with shoulder strap.

0164281NR

Interior divided into 2 compartments with contrasting lining. Several pockets and external pocket in transparent PVC.



Ear part fitted with straps and eyelets for rollbar fixing.

A. Giovannazzi - F1 driver



GI

285

BAGS

BAGS

HOODIES NEW

COMPOSITION: 50% COTTON - 50% POLYESTER - BRUSHED 280 G/M²

SKID COLLECTION NEW

COMPOSITION: 100% POLYESTER

286

GI

287

HOODIE 1977

SIZES: S-XXL

01268NR..



HOODIE MOTORSPORT

SIZES: S-XXL

01267BI..



HOODIE PERFORMANCE

SIZES: S-XXL

01266BM..



HOODIE PUNISH

SIZES: S-XXL

01270NR..



HOODIE VINTAGE

SIZES: S-XXL

01269NR..



SWEATSHIRT 1977

SIZES: S-XXL

01271NR..

Round neck.



POLO SKID

SIZES: S-XXL



01265BINR..



01265NRBI..

T-SHIRT SKID

SIZES: S-XXL



01264BIAZ..



01264AZBI..

MERCHANDISING

MERCHANDISING

T-SHIRTS

288

COMPOSITION: 50% POLYESTER/25% COTTON/25% RAYON

CIRCUIT

SIZES: S-XXL

01235..NR



CORPORATE

SIZES: S-XXL

01236..NR



HANDCRAFTED

SIZES: S-XXL

01237..NR



PUNISH

SIZES: S-XXL

01239..NR



VINTAGE 77

SIZES: S-XXL



01242..NR



01242..IN



01242..GR

RALLY

SIZES: S-XXL



01240..IN



01240..NR

COMPOSITION: 100% COTTON

K-CREW

NEW

SIZES: S-XXL



01261BI..



01261AZ..

TRACK

NEW

SIZES: S-XXL



01262BI..



01262BM..

TRON

NEW

SIZES: S-XXL



01263BI..



01263NR..

1977

NEW

SIZES: S-XXL



01260BI..



01260BM..

CAPS

290

FLEXFIT - ORIGINAL CAP

01245..

COMPOSITION: 63% Polyester/34% Cotton 3%/P.U. Spandex.



REBEL

01229NR

COMPOSITION: 100% Acrylic fabric with pvc adjustable strap.



40TH

01231 BM

COMPOSITION: 97% Cotton/3% elasticised Spandex.



1977

01230NR

COMPOSITION: 100% Acrylic fabric polyester mesh - with pvc adjustable strap.



WINDY

01232BMAZ

COMPOSITION: 100% Acrylic fabric.



WELCOME

099058



PADDOCK

0990058

The comfortable Sparco paddock Chair has an aluminium frame and is finished in coloured Oxford 600D fabric. The soft arms are padded for maximum comfort at all times. Easy to transport thanks to its folding mechanism.



KIT OF 10 STICKERS

09003

DIMENSION: 2 PCS 18 cm - 4 PCS 12 cm - 4 PCS 8 cm



POUF

0750006B

Soft pouf diameter 40 cm, height 40 cm, with printed S logo in the upper surface.



ACCESSORIES

292

FOLDABLE UMBRELLA **NEW**

099067

Foldable automatic polyester umbrella with light.
Ø 96 cm



UMBRELLA **NEW**

099068

Polyester automatic umbrella.
Ø 130 cm



LEATHER PHONE HOLDER **NEW**

099069AZ..



099069NR..

Phone holder produced with the same real leather used for supercar seats.

DIMENSIONS: S (iPhone 6, 6s, 7, 8) - M (iPhone X, XS) - L (iPhone XR) - XL (iPhone Plus 6, 6s, 7, 8)



LEATHER KEY HOLDER **NEW**

099070AZ 099070NR



Keychain produced with the same real leather used for supercar seats.



BADGE HOLDER **NEW**

0992BADGE



SPORTSACK **NEW**

0160013AZ 0160013NR

€ 8,00

VAT NOT INCLUDED

DIMENSIONS: 33x51 cm



SUIT'S BAG **NEW**

0168LU06

DIMENSIONS: 44x35 cm



MICROFIBER SPORT TOWEL **NEW**



099073

DIMENSIONS: 100x50 cm

COMPOSITION: 90% Poliestere/10% Nylon



KEYCHAIN **NEW**

099071SUIT

099071SHOE

099071SEAT

099071GLOVE



SUNGLASSES



099059



THERMOS **NEW**

099072

CAPACITY: 0,4 Lt



THE FUTURE OF RACING.

T-SHIRT FUTURE DRIVER

SIZES: 3-4, 5-6, 7-8, 9-11 (years).
COMPOSITION: 100% Cotton with digital print.



0170138I..



017013NR..

NEXT GENERATION SWEATSHIRT

SIZES: 3-4, 5-6, 7-8, 9-11 (years).
COMPOSITION: 80% Cotton/20% Polyester with digital print.



017017NR..

SNEAKERS SH-17

Leather and breathable fabric fashion sneakers.
SIZES: 26-28-30-32-34.



001262..SIAZ

YOUTH BASEBALL CAP (REBEL)

SIZES: 54-60 (cm).
COMPOSITION: 100% Acrylic.



017015

YOUTH BEANIE (WINDY)

SIZES: 54-60 (cm).
COMPOSITION: 100% Acrylic.
DIMENSIONS: L18x19H.



017019BMAZ

EAGLE 2.0 BABY REPLICASUIT

SIZES: 3-6, 6-9, 9-12, 12-18 (months).
COMPOSITION: 100% organic Cotton with digital print.



017012AZ..

BABY SLEEPSUIT

SIZES: 3-6, 6-9, 9-12, 12-18 (months).
COMPOSITION: 100% organic Cotton with digital print.



017018AZ..

BABY RACER SWEATSHIRT

SIZES: 6-12, 12-18, 18-24 (months).
COMPOSITION: 80% Cotton/20% Polyester with digital print.



017016NR..

T-SHIRT BABY RACER

SIZES: 6-12, 12-18, 18-24 (months).
COMPOSITION: 100% organic Cotton with digital print.



017010NR..

BODY BABY RACER

SIZES: 3-6, 6-12, 12-18, 18-24 (months).
COMPOSITION: 100% organic Cotton with digital print.



017011BI..

BABY HAT

SIZES: 0-3, 3-6, 6-12, 12-24 (months).
COMPOSITION: 100% organic Cotton with digital print.



017014..

SK500I

CHILD SEAT GROUP 0+1 (0-18KG)

HOMOLOGATION: ECE R129 (I-SIZE)

- Age: 0-4 years (approx).
- ISOFIX + support Leg.
- Suitable for children up to 105 cm tall.
- Head supports with memory foam.
- 3 position recline for forward facing.
- 8 position headrest up and down.
- 5 point harness system.
- Waterproof & Oil proof fabric without sewing on seat.
- Forward facing & Rearward facing.
- Unique manufacturing technology of foam combination FCC Certifications.

Dimensions: 45x65x70/105 cm.
Weight: 14.5 kg.

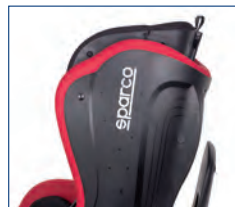

01923IRS



01923IAZ



01923INR

SK700

CHILD SEAT GROUP 1+2+3 (9-36KG) ISOFIX

HOMOLOGATION: ECE R44/04

MATERIAL: COVER: 82% POLYESTER + 18% PU, FILLING: 100% POLYESTER, WADDING: 100% POLYPROPYLENE

- Age: 9 months - 12 years (approx).
- Anchorage system: universal.
- ISOFIX + TOP TETHER.



01920RS



01920AZ



01920GR

F1000KI

CHILD SEAT GROUP 1+2+3 (9-36KG) ISOFIX

HOMOLOGATION: ECE R44/04

MATERIAL: POLYESTER + PU + SUEDE + HDPE (HIGH DENSITY POLYETHYLENE) + PUR SPONGE

- Child seat with the highest quality and standards for maximum safety.
- Isofix - connects to car's Isofix.
- Age: 9m -12 years (approx).
- Anchorage system: universal.
- ISOFIX + TOP TETHER.



01922IRS



01922IAZ



01922IGR

SK900I

BOOSTER SEAT ISOFIX (22-36 KG)

300

HOMOLOGATION: ECE R44/04

- Age: 6-12 years (approx).
- Anchorage system: universal.
- ISOFIX.



019211RS



01921IAZ



01921IGR

ACCESSORIES

301

SK1313-SK1314

Side window car sun shade.

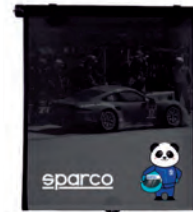

01926AZ

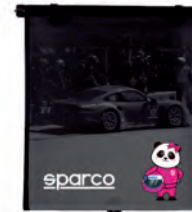

01926PK

DIMENSIONS: 50x36 cm.
MATERIAL: Polyester.

SK1311-SK1312

Side window car sun shade.

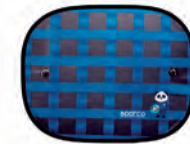

01925AZ



01925PK

DIMENSIONS: 44x36 cm.
MATERIALE: Polyester.

SK1105-SK1106

Neck pillows.

Super soft material.
Conforms to the shape of your neck.
Provides superior support and comfort.
Relieves pressure.
Helps prevent headache and neck pain.
Machine washable.
This is not a toy and must be used under direct adult supervision.
MATERIAL: 100% Polyester.
DIMENSIONS: 27x23x8 cm.



01924AZ



01924PK

SPARKY PELUCHE

099051

DIMENSIONS: 41 cm.
MATERIAL: Polyester.
3+ years.



NEW WHEELS, SAME SPIRIT.



SEM 1

E-SCOOTER

NEW

304

MATERIAL: ALLOY ■ **RANGE:** UP TO 25KM ■ **MAXIMUM SPEED:** 25KM/H ■ **MAX LOAD:** 120KG

Body size: 1150x480x1135 mm
 Folding size: 1030x220x405 mm
 Ground distance: 100 mm
 Net weight: 14.3 kg

Available from March 2020.

BATTERY: 36V/7.5 AH ■ **CHARGING TIME:** 4-6 HOURS ■ **MOTOR POWER:** 350 W ■ **WHEELS:** 8,5"

Display: LCD
 High-Luminous Front + Rear Light
 Max Gradability: 15°
 Ingress Protection: IPX4



Adjustable Height

- Adjust the height in 2 simple steps
- 3 height options possible
- Supports your back
- Ride in the most convenient position



Powerful Battery

- High performance e long-lasting cells
- Choose between 7.5Ah
- Up to 35km on one single charge
- Rapid charging system



Powerful Double Brake

- Double braking system
- Electric rear brake
- Rear drum brake
- Fast braking distance & smooth settings



App

- Connects via Bluetooth to your phone
- Shows Speed, total length, actual length etc.
- Scooter Lock function for safety & security
- Regulate 3 riding modes (Eco, Normal, Sport)



FEW SECONDS FOLDING SYSTEM



099075AZ



099075RS



099075GR



099075BI



099075NR





Check out the collection of automotive seats we offer.