

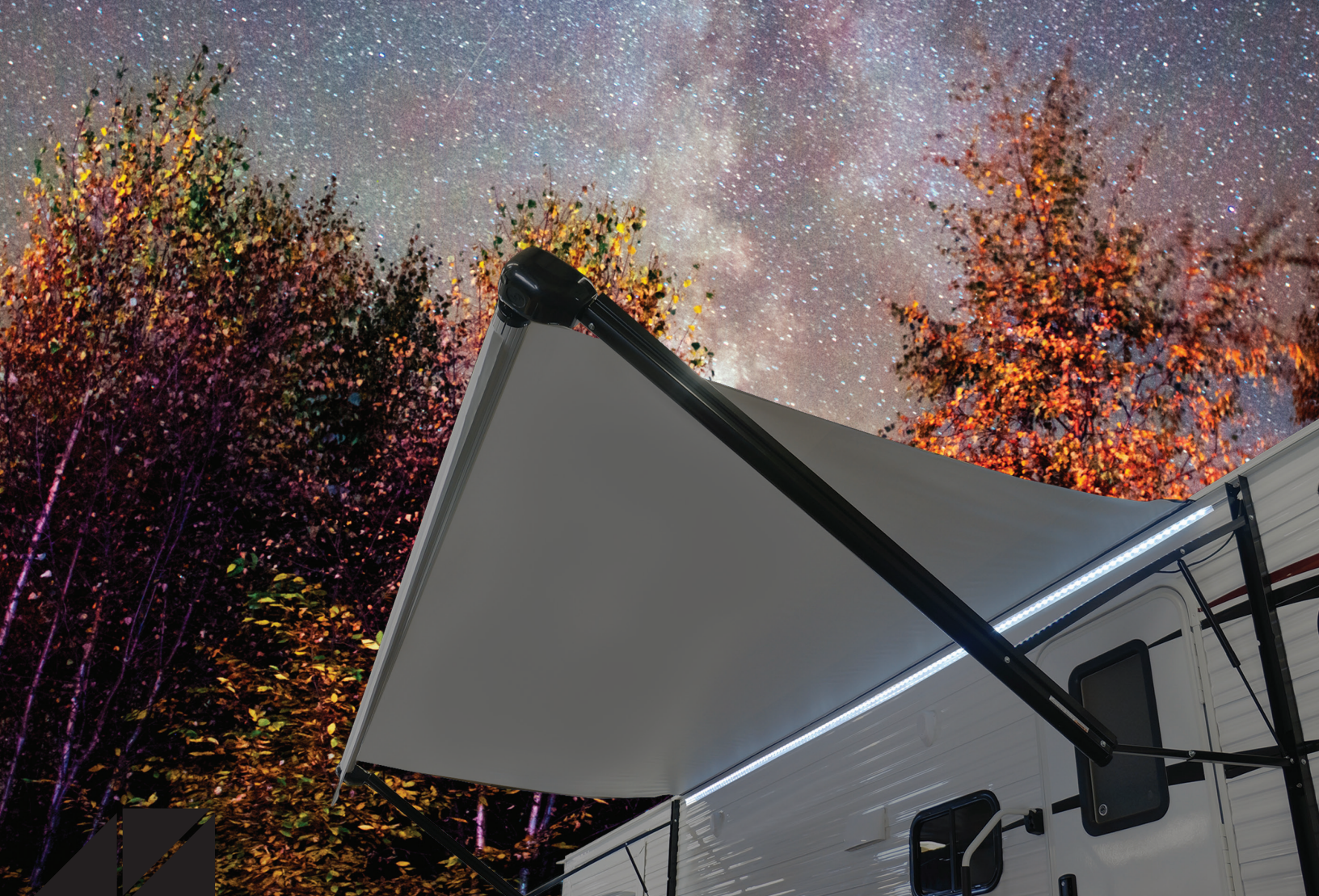

INTRODUCING
SOLERA[®] UNIVERSAL

2017 AWNINGS & ACCESSORIES



**The world's fastest growing
RV awning brand just got even better**



SOLERA: UNIVERSAL
The world's fastest growing
RV awning brand just got even better

INTRODUCING
SOLERA UNIVERSAL
2017 AWNINGS & ACCESSORIES

Solera Universal Arms fit any of these brands:



Universal Hardware fits the following Solera 8' extension awnings models: Power 12V, Power 18V, Hybrid and Classic Manual



Universal Hardware fits the following Dometic® 8' extension awnings models: 8500, 9000, 9100, Sunchaser and Weather Pro



Universal Hardware fits the following Carefree 8' extension awnings models: Spirit, Fiesta, Simplicity Traveler and Eclipse

Making it simple and easy to...



POWER UP

Power Up your mobile lifestyle with the Solera 12V Power or 18V Battery Operated awnings. Save yourself the stress and added time of manually setting up your awning!



UPGRADE

Upgrade your current manual or power awning with Solera Universal Hardware! Our Hybrid and Power awnings set up automatically for camping as they extend.



FIX IT

Tired of your old manual or power awning? With our newly designed Solera Universal hardware, replacing your broken or worn out awning has never been easier, no matter what awning brand you have.

The world's fastest growing RV awning brand



Solera Universal Products:

UNIVERSAL SOLERA: CLASSIC



UNIVERSAL SOLERA: 12V POWER



UNIVERSAL SOLERA: SHADES



UNIVERSAL SOLERA: HYBRID



UNIVERSAL SOLERA: FAMILY ROOM



UNIVERSAL SOLERA: 18V POWER



UNIVERSAL SOLERA: SCREEN ROOM



UNIVERSAL SOLERA: GROUND CENTER SUPPORT



UNIVERSAL SOLERA: AWNBRELLA



UNIVERSAL SOLERA: UNIVERSAL PATIO FABRICS

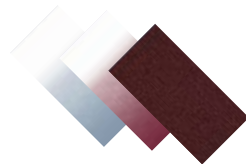

UNIVERSAL SOLERA: UNIVERSAL SLIDER FABRICS





SOLERA: UNIVERSAL
 The world's fastest growing
 RV awning brand just got even better

Solera makes it simple.

These icons help to indicate which Solera awning is right for you.



UNIVERSAL

This icon represents an available Universal application for your Solera, Dometic® or Carefree™ awning, fabric or awning accessory.



POWER UP

This icon represents the ability to Power Up your old manual or power awning hardware with Solera 12V Power or 18V Battery Operated awning.



UPGRADE

This icon represents the ability to upgrade your current awning, fabric or awning accessory with Solera's awning components.



FIX IT

This icon represents a great opportunity to renew and refresh your broken or worn out awning, patio fabric, slide-out topper fabric, screen rooms, family rooms and ground center supports.



GO LARGE

This icon represents the only solution that gives campers 20% more shade than the standard 8' projection awning. Go Large, and maximize your outdoor living space.

The world's fastest growing RV awning brand



Choose from these innovative Solera Awning models

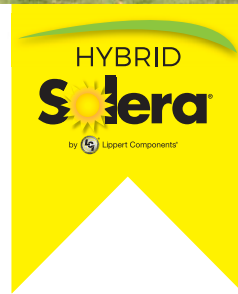
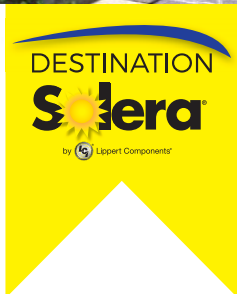

SOLERA: 18V POWER

18V Battery Power Pack



18V POWER

Solera

by Lippert Components

UNIVERSAL

FIX IT

POWER UP

UPGRADE

SOLERA: 18V POWER

18V Battery Power Pack

Introducing the industry first Solera 18V Power Awnings! Upgrading to a power awning has never been easier! An industry first, the Solera 18V Power Pack features a unique, rechargeable battery that fits right inside your Solera Power Awning arm and comes with everything you need to connect to the motor wire. This is the perfect awning for DIY RVers who don't want to spend the installation dollars to wire a 12V awning into their RV. Better yet, the Solera 18V Power awning extends and retracts faster than other power awnings. Not that you're in a hurry, but who wouldn't want the fastest awning on the planet?



SOLERA: 18V POWER FEATURES

- Save 1-2 hours of additional installation expense as there is no need to wire this directly in to your RV's power supply
- Waterproof switch offers easy, push-button operation
- Auto rain dump feature activates when rain water pools in the canopy, automatically lifting the awning arms to release the pooled water
- Operates 22-25 times before needing a simple plug-in recharge
- Exclusive, quick and simple independent pitch adjustment for relief from the sun at any point in the day
- Faster extend and retract time
- Includes 110V charging kit
- Easy DIY installation; no internal wiring needed to the RV's main power source
- Easy access manual override, an industry first!* In case of power failure, simply use a power drill to extend or retract your awning in case of power failure
- **NEW!** Universal Solera 18V Power Hardware option allows for an easy UPGRADE on Dometic® (A&E)** and Carefree*** manual or power awnings

SOLERA: 18V POWER HARDWARE

TALL ARM



Adjustable Pitch

- Requires 69" unobstructed area from awning rail straight down
- Requires min. clearance of 2-1/2" between awning rail and top of entry door
- This hardware will roll the awning out to a pre-set pitch for maximum shade and ideal rain runoff
- Two-position pitch

Easy DIY Installation!



UNIVERSAL ARMS AVAILABLE

Our Universal options fit standard Carefree and Dometic® patio awning roller bars making Solera the Universal easy choice.

See page 31 to order



RV Doctor's Tip: "Upgrading to a power awning from a manual awning can be pretty labor intensive. Wiring the awning into the RV's main power source can take a technician quite some time. When I saw the new Power Pack option from Lippert Components, my first thought was, "Why didn't I think of that?" The Solera 18V Power Pack option is most definitely the easiest way to get out of the Stone Age and upgrade to a power awning, folks."

*Manual override not available on 2017 Forest River Cherokee

**Universal Hardware fits the following Dometic® 8' extension awnings models: 8500, 9000, 9100, Sunchaser and Weather Pro

***Universal Hardware fits the following Carefree 8' extension awnings models: Spirit, Fiesta, Simplicity Traveler and Eclipse

SOLERA: 12V POWER

12V Push-Button Control



UNIVERSAL

FIX IT

POWER UP

UPGRADE

GO LARGE

12V POWER
Solera
by Lippert Components

SOLERA: 12V POWER

12V Push-Button Control

Isn't it time you made the switch from a manual, spring-assisted awning to something easier? How many years have you daydreamed of a simplified camp setup? Stop wasting time and energy with manual awnings and POWER UP to a Solera 12V Power Awning. Featuring a premium, heavy-duty canopy and a one-handed adjustable pitch projection, the Solera 12V Power Awning allows for simple, effortless setup. With the push of a button, the awning's direct drive motor easily extends or retracts your awning's canopy. Simple, stress-free and with manual override functionality, the 12V Push-Button Control Awning takes the hassle out of camp setup and all but eliminates campsite setup frustrations.



SOLERA: 12V POWER FEATURES

- Push-of-a-button, automatic operation from inside or outside of your RV
- Auto rain dump feature activates when rain water pools in the canopy, automatically lifting the awning arms to release the pooled water
- Easy access manual override, an industry first!* In case of power failure, simply use a power drill to extend or retract your awning in case of power failure
- Exclusive, quick and simple independent pitch adjustment for relief from the sun at any point in the day
- With a range of unique awning styles, sizes and options including awning lights, speakers and multiple fabric and hardware color options, Solera Power can offer you so much more than shade and shelter
- **NEW!** Universal Solera Power Hardware option allows for an easy UPGRADE on Dometic® (A&E)** and Carefree®*** manual or power awnings



SOLERA: 12V POWER HARDWARE

SHORT ARM

Adjustable Pitch

- Requires 60-1/2" unobstructed area from awning rail straight down
- Requires min. clearance of 6" between awning rail and top of entry door
- This hardware will roll the awning out to a pre-set pitch for maximum shade and ideal rain runoff
- Two-position pitch

TALL ARM

Flat Adjustable Pitch

- Requires 69" unobstructed area from awning rail straight down
- Requires min. clearance of 2-1/2" between awning rail and top of entry door
- This hardware will roll the awning out flat to allow for clearance over slides, and allows quick and easy pitch adjustment at either side of the awning
- Infinite adjustment

XL ARM XL

Flat Adjustable Pitch

- Requires 78" unobstructed area from awning rail straight down
- Requires min. clearance of 4-1/2" between awning rail and top of entry door
- This hardware is configured to operate a 9'-8" projection canopy. It will roll the awning out flat to allow for clearance over slides, and allows quick and easy pitch adjustment at either side of the awning
- Two-position pitch

**20%
MORE
SHADE**

See more
XL on the
next page

NOTES: Solera XL arms are not universal and require XL roller assemblies.



UNIVERSAL ARMS AVAILABLE

Our Universal options fit standard Carefree and Dometic® patio awning roller bars making Solera the Universal easy choice.

See page 31 to order



RV Doctor's Tip: "One RVer recently asked me, "I have an old Dometic power awning. Is it worth switching to the Solera Power Awning?" The short answer is, yes. There are several advantages to a Solera Power Awning that the other two brands don't offer, but one stands out to me above the rest. How many times have you run your batteries dry? I know I have. If this happens when your awning is out, you could have a problem on your hands, but not with Solera. With it's easy to use manual override function, simply roll your awning back in with a power drill and you're ready to hit the road. The other brands' manual operation isn't so easy. There's a great video on YouTube showing all three awnings being manually retracted – you should check it out. The video will show you that not all power awnings are created equal."

*Manual override not available on 2017 Forest River Cherokee

**Universal Hardware fits the following Dometic® 8' extension awnings models: 8500, 9000, 9100, Sunchaser and Weather Pro

***Universal Hardware fits the following Carefree 8' extension awnings models: Spirit, Fiesta, Simplicity Traveler and Eclipse

SOLERA: XL 12V POWER AWNING

Extended Shade and Relief From the Sun



FIX IT

POWER UP

UPGRADE

GO LARGE



SOLERA: XL 12V POWER AWNING

Extended Shade and Relief From the Sun

The Solera XL Awning features an industry first 9' 8" projection, making it perfect for taller RVs and RVs with a slide-out under the awning. Class A motorhomes, fifth-wheel and toy hauler RVs continue to get taller and taller, so it can be difficult to get the shade you need from a standard 8' projection awning. Not only that, but many brands now feature slide-outs under the awning, which can really limit your shaded patio area. Choose a Solera Power XL Awning to enjoy 20% more shade than a standard 8' projection pitch! Featuring an adjustable projection pitch Sleeve, the Solera XL Awning can be pitched at multiple points to block the sun at any time of day. The two-stage projection pitch arms also provide added strength and support for your awning, making the XL Awning one of the best values on the market.



THE FIRST! **XL 9'8"** PROJECTION

SOLERA: XL 12V POWER FEATURES

- 9'8" projection offers 20% more shade than standard 8' projection awnings
- Push-of-a-button, automatic 12V operation from inside or outside your RV
- Adjustable two-position pitch arms provide added strength and offer multiple adjustments, offering shade at any time of day

NOTES: Solera XL arms require XL roller assemblies.
Vinyl and Acrylic with Solera Shield not available on XL awnings.
18V Battery Power Pack not available for Solera XL awnings.

SOLERA: XL 12V POWER HARDWARE

XL ARM XL

Flat Adjustable Pitch

- Requires 78" unobstructed area from awning rail straight down
- Requires min. clearance of 4-1/2" between awning rail and top of entry door
- This hardware is configured to operate a 9'-8" projection canopy. It will roll the awning out flat to allow for clearance over slides, and allows quick and easy pitch adjustment at either side of the awning
- Two-position pitch

**20%
MORE
SHADE**

See page 34 to order

SOLERA: AWNBRELLA



XL & STANDARD SIZES AVAILABLE

- Adjustable rust-resistant aluminum bows
- Keeps canopy from flapping in the wind
- Increases clearance over entry door
- Prevents canopy from sagging
- Stops water from pooling
- Enhances appearance

See page 24 for more information



Gary Bunzer
The RV Doctor &
RV Hall of Fame Member

RV Doctor's Tip: "Every year, I walk the National RV Show in Louisville, and the RV's always seem to be getting bigger, taller and have more slide-outs. 8' projection awnings just don't cut it in some cases anymore, so the Solera Power XL Awning is a perfect solution for those RV owners. **Solera also offers the Awmbrella tensioner bars in XL sizes too, so your awning fabric can be kept tight and arched while you're at the campsite.**"

SOLERA: DESTINATION
Big Carport-Sized Shade & Shelter



**DON'T JUST
REPLACE.
EXPAND
YOUR
OUTDOOR
LIVING
AREA BY
20%
with the
SOLERA
DESTINATION
9'8" projection
canopy!**



FIX IT UPGRADE GO LARGE

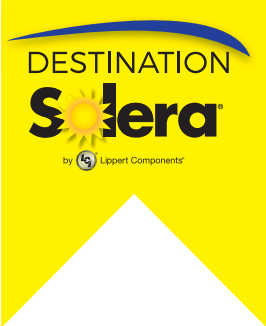

SOLERA: DESTINATION
Big Carport-Sized Shade & Shelter

Destination campers (or seasonal campers) who setup camp for extended stays will love the Solera Destination Awning. With 20 percent more shaded area compared to standard 8' projection awnings, the 9' 8" Solera Destination Awning is the ultimate solution when you need added living space. Not only does the Destination awning provide extra shade, it also comes with a center ground support, a Solera Shield to protect the vinyl canopy and Solera Awnbrellas™ to keep the fabric arched and taut to minimize wind flap and enable rain runoff.



SOLERA: DESTINATION FEATURES

- 9'8" projection offers 20% more shade than standard 8' projection awnings
- Manual spring assist operation
- Includes Solera Awnbrella fabric tensioning bars
- Includes center ground support bar
- Includes standard Solera Shield fabric protector
- Arms detach from bottom bracket and easily swing to "carport" position providing varied pitch options to block the sun at any time of the day

SOLERA: DESTINATION HARDWARE

DESTINATION XL

Flat Adjustable Pitch

- Requires 78" unobstructed area from awning rail straight down
- This hardware will roll the awning out flat to allow for clearance over slides, and allows quick and easy pitch adjustment at either side of the awning
- Multiple adjustment for shade

See page 35 to order

UPGRADED STANDARD FEATURES!

SOLERA: AWNBRELLA



SOLERA: SHIELD



SOLERA: GROUND SUPPORT



RV Doctor's Tip: "Seasonal campers, take note. The Solera Destination awning is what you've been waiting for. Not only do you get 20% more shade, but the included Awnbrella tensioning arms allow you to rest easy. Wind and rain are no longer a big deal. The Awnbrella arms keep the fabric tight and arched so wind won't catch the awning as easily and water runs off without having to pitch the awning."

Gary Bunzer
The RV Doctor &
RV Hall of Fame Member

SOLERA: HYBRID

Sets up & stores in a fast one-step operation



UNIVERSAL

FIX IT

UPGRADE

HYBRID
Solera
by Lippert Components

SOLERA: HYBRID

Sets Up & Stores Automatically as you Crank

The Solera Hybrid Awning combines the best of both worlds. Featuring a simple crank operation, the Solera Hybrid Awning extends and retracts just like a Power Awning, except you supply the power. The next best thing to a fully powered awning, the Hybrid allows you to skip the potential hassle and installation cost of running wiring and acts as a do-it-yourself upgrade from a manual spring-loaded awning.



SOLERA: HYBRID FEATURES

- Simple crank operation makes for fast one-step setup
- Auto rain dump feature – if water pools in the canopy, the arms will release it
- Exclusive, quick and simple independent pitch adjustment – enjoy full or partial extension
- Designed to provide optimum pitch when used over slide-outs
- Includes crank wand
- **NEW!** Universal Solera Hybrid hardware allows for an easy and inexpensive upgrade to Dometic® (A&E)* and Carefree** spring-assisted patio awnings

SOLERA: HYBRID HARDWARE

SHORT ARM



Adjustable Pitch

- Requires 60-1/2" unobstructed area from awning rail straight down
- Requires min. clearance of 6" between awning rail and top of entry door
- This hardware will roll the awning out to a pre-set pitch for maximum shade and ideal rain runoff
- Two-position pitch

TALL ARM



Flat Adjustable Pitch

- Requires 69" unobstructed area from awning rail straight down
- Requires min. clearance of 2-1/2" between awning rail and top of entry door
- This hardware will roll the awning out flat to allow for clearance over slides, and allows quick and easy pitch adjustment at either side of the awning
- Infinite adjustment



UNIVERSAL ARMS AVAILABLE

Our Universal options fit standard Carefree and Dometic® patio awning roller bars making Solera the Universal easy choice.

See page 31 to order



Gary Bunzer
The RV Doctor &
RV Hall of Fame Member

RV Doctor's Tip: "Traditional spring-assisted awnings have been around forever. Veteran campers can set these awnings up in a matter of minutes, but to those new to camping, setup can be a little difficult. The Solera Hybrid Awning is perfect for those campers who don't want to make the jump to a power awning, but also want something easier to extend and retract. If this is the case, press the "easy button," and get yourself a Solera Hybrid. You get the best of both worlds!"

*Universal Hardware fits the following Dometic® 8' extension awnings models: 8500, 9000, 9100, Sunchaser and Weather Pro

**Universal Hardware fits the following Carefree 8' extension awnings models: Spirit, Fiesta, Simplicity Traveler and Eclipse

SOLERA: CLASSIC

Traditional Manual Spring Roll Up



UNIVERSAL

FIX IT

UPGRADE

CLASSIC
Solera
by Lippert Components

SOLERA: CLASSIC

Traditional Manual Spring Roll Up

Classic design, classic operation. The Solera Classic's manual spring-assisted design has been an industry favorite for decades. The rugged Solera Classic extends and retracts in just a few easy steps. Simply release the travel locks on each arm, loosen the rafter knobs, use the pull cane to unlock the roller, then hook the pull strap and walk it out to unroll the awning. Once extended, set the tension, tighten rafter knobs and raise the awning arms to whatever pitch you want for shade and water runoff. You can also detach the arms from the bottom bracket and rotate them to a vertical "carport" position. This carport position makes it easy to attach accessories like the Solera Screen Room and Solera Family Room™.



SOLERA: CLASSIC FEATURES

- Traditional manual spring-assisted roll up operation
- Arms detach from bottom bracket and easily swing to “carport” position providing varied pitch options to block the sun at any time of the day
- Great value for replacing any Dometic®, Carefree or Solera® spring-loaded manual awning
- Simple standard manual operation: Unlock with included wand, unroll with strap, set the braces and raise the arms
- **NEW!** Universal hardware now makes Solera the easy choice for repairing or replacing your old spring-assisted patio awning. Solera Universal Classic Hardware fits into Dometic® (A&E)* and Carefree** roller assemblies with ease.

SOLERA: CLASSIC HARDWARE

SHORT ARM



- Rail to floor line 63"-68" from awning rail straight down

STANDARD ARM



- Rail to floor line 68"-81" from awning rail straight down

LONG ARM



- Rail to floor line 81"-96" from awning rail straight down



UNIVERSAL ARMS AVAILABLE

Our Universal options fit standard Carefree and Dometic® patio awning roller bars making Solera the Universal easy choice.

See page 31 to order



Gary Bunzer
The RV Doctor &
RV Hall of Fame Member

RV Doctor's Tip: "Most RVers love these spring-assisted awnings because of the “carport” set-up option. This is great if you plan on spending extended periods of time at the campsite. One potential issue here is that when the legs go all the way to the ground, there is no pitch adjustment option, so water pooling can become an issue. No problem there folks – the Solera Awmbrella tensioning arms are easy to install and keep your awning fabric taut and arched so water slides right off the awning. Problem solved!"

* Universal Hardware fits the following Dometic® 8' extension awnings models: 8500, 9000, 9100, Sunchaser and Weather Pro

** Universal Hardware fits the following Carefree 8' extension awnings models: Spirit, Fiesta, Simplicity Traveler and Eclipse

SOLERA: UNIVERSAL SLIDER FABRICS



UNIVERSAL

FIX IT

UPGRADE



SOLERA: UNIVERSAL SLIDER FABRICS

Stop wasting time by custom ordering slide topper fabric every time you get an order, and save room for more inventory! Our Slide Topper Replacement Fabric boxes are compact yet durable and are a UNIVERSAL fit, meaning no more guesswork when it comes to replacing slide topper fabric.























Works with: Solera®, Carefree and Dometic®

See your local dealer for options

FEATURES

- Our slide topper fabric is universal, fitting all three major patio awning brands
- Premium, 13.5 oz fabric - not the competition's 10 oz fabric
- Best of all, we offer a cut-to-fit option in a "Kleenex" style box, complete with easy-to-use roller. Just extend out the amount of fabric you need and cut
- Roll stays in place with plastic reel (competitors do not offer this)
- **5-year warranty** on Solera Universal Slider fabric.

Dealers see page 38 to order our slide out topper cut to fit box

		Carefree	Dometic®
The box includes plastic reels that strengthen the box for shipment and hold the fabric in place, allowing for easy roll out			
Standard 13.5 oz vinyl fabric		 10 oz only	 10 oz only
Perforation lets you easily pull out the fabric you need, safely keeping the rest of the fabric in the box and protected			
Heated wedge welding fuses vinyl together for strong, leak-resistant seams			
The fabric box stays closed after each use, protecting it from dirt, grime and other elements that could damage the product			
5-year warranty	 5-year	 1-year	 1-year
Available in Black and White			



UNIVERSAL Fit to Solera, Dometic® & Carefree

UNIVERSAL



Replace your old moldy fabric

FIX IT



UPGRADE to Maintenance-Free Acrylic Fabric

UPGRADE

SOLERA: UNIVERSAL PATIO FABRICS

Solera's premium awning replacement fabric is head and shoulders above other brands with super heavy-duty materials, a **5-year warranty**, heat-welded seams and more.























Our canopy fabric also features an integrated light track so you can easily add the Solera Fabric Light Kit and enjoy LED lighting at the campsite.

See next page for color options

FEATURES

- **5-year warranty** vs. 1-year with the competition
- Universal - it works with all three major awning brands
- Welded, state-of-the-art construction at critical points of the patio awning
- Premium 13.5 oz fabric used, not 10 oz base fabric
- Great colors to match your RV, and ability to customize your rig
- Our canopy fabric features an integrated light track so you can easily add the Solera Fabric Light Kit to light up your patio

See page 42-43 to order

		Carefree	Dometic®
Heavy-duty 13.5 oz fabric			
5-year prorated warranty	 5-year	 1-year	 1-year
Integrated track for LED light kit attachment			
Heat-welded fabric seams prevent leaks			
Universal fit for all awnings			
Same day shipping (in by 1:00 EST, out same day)			
Free standard UPS shipping in the continental United States			

SOLERA: UNIVERSAL FABRIC OPTIONS



SELECT FROM THESE PATIO AWNING REPLACEMENT CHOICES:



All vinyl

- Heavy-duty 13.5 oz fabric
- Cold-crack tested to -25° F
- Nine color choices

See pages 42-43 to order



Vinyl Canopy with Solera Shield

- Painted Solera Shield is available in black, white, and two custom colors

NOTE: Solera Shield not available on XL Awning



Woven Acrylic Canopy with Solera Shield

- Woven fabric is breathable, so the area under the canopy may stay cooler than vinyl canopies
- Five color choices
- Mildew-resistant fabric
- Comes complete with Solera Shield

NOTE: Solera Shield not available on XL Awning

SOLERA: UNIVERSAL ALL VINYL OPTIONS:



Solid Black BKSOLID



Black Fade BKWG



White Fade BKWG



Sand Fade BKWG



Sand Fade WHWG



Burgundy Fade WHWG



Blue Fade WHWG



Silver Fade WHWG



Green Fade WHWG

SOLERA: UNIVERSAL FABRIC OPTIONS



SOLERA: SHIELD

The built-in Solera Shield is available on replacement slider and patio awning fabrics. It provides elegant and practical protection for your Solera vinyl or acrylic awning canopy. As the awning retracts, the aluminum Solera Shield automatically rolls up around the fabric to protect it against the elements during travel. Be sure to order your Solera Shield to match your hardware.



UPGRADE

NOTE: Solera Shield not available on XL

SOLERA: UNIVERSAL VINYL WITH SOLERA SHIELD OPTIONS:

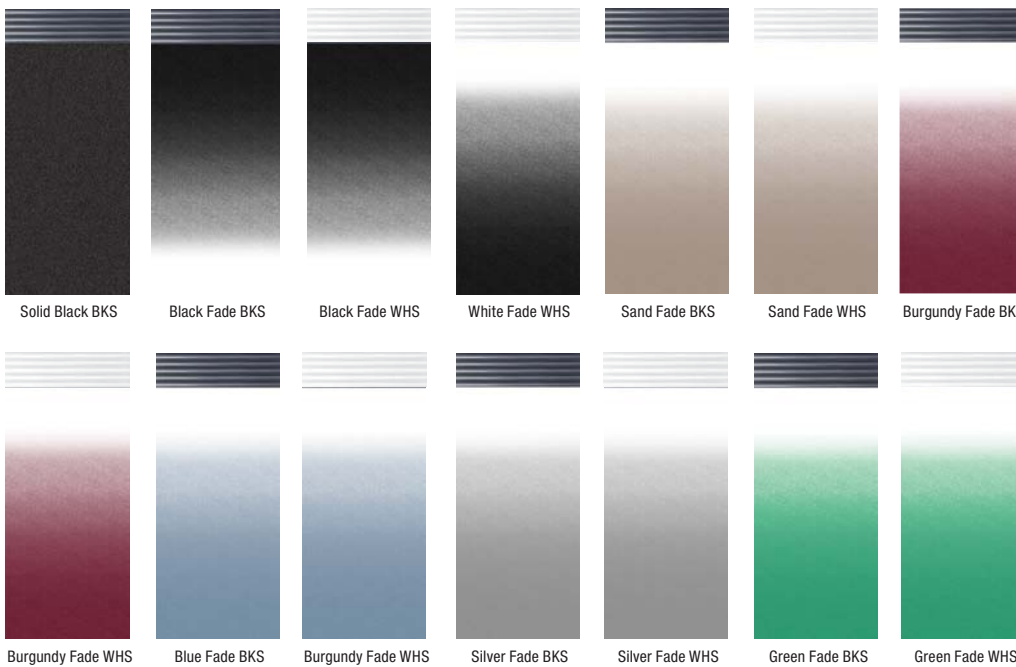

Special Order Canopy Option:
 - Vinyl Fabric with Solera Shield
 (Allow for standard lead time)

NOTE: Solera Shield not available on XL

SOLERA: UNIVERSAL ACRYLIC FABRIC WITH SOLERA SHIELD:



Special Order Canopy Option:
 - Woven acrylic fabric with Solera Shield
 (Allow for standard lead time)

NOTE: Solera Shield not available on XL

SOLERA: WINDOW AWNINGS

Keep cool, and block the sun's rays from invading your RV interior living space

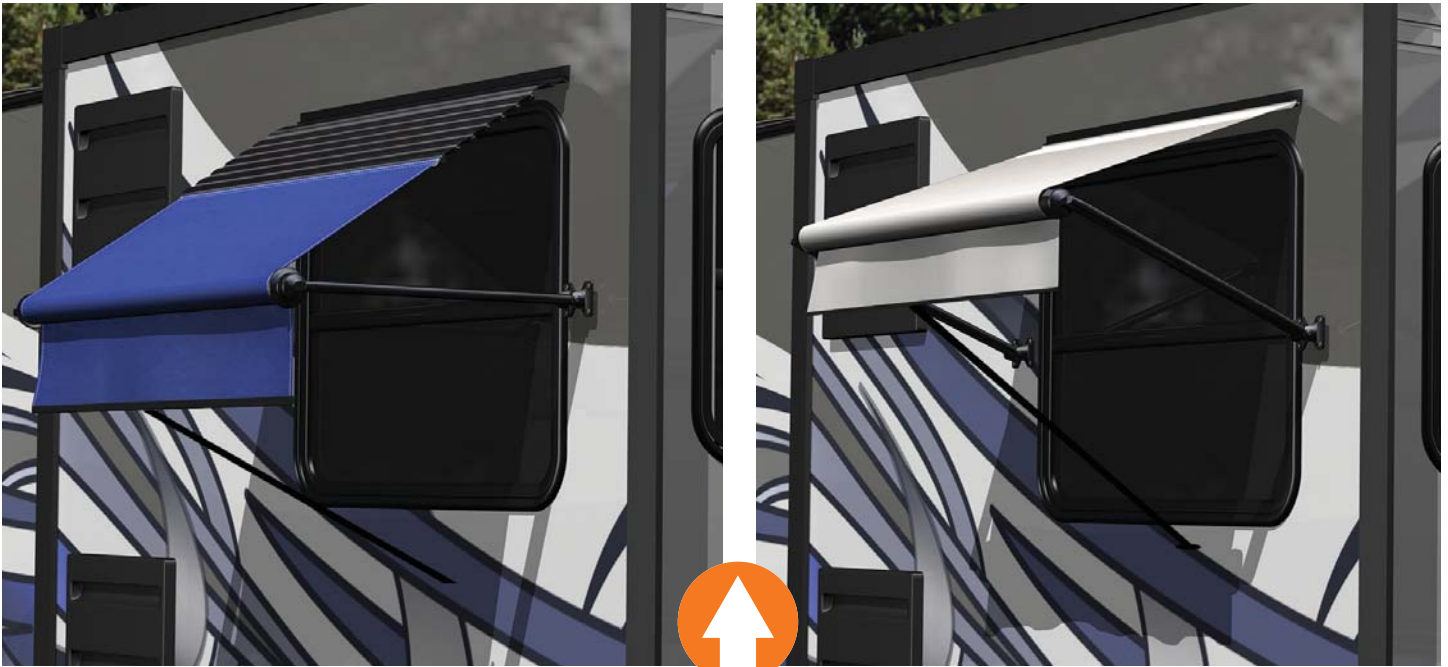

UPGRADE

SOLERA: WINDOW AWNINGS

Keep the heat out, and save on AC with Solera Window Awnings. Just use the pull cane to hook the pull strap, and pull to extend the awning. Secure the strap loop onto a hook on the RV wall to keep the awning extended. Go for the best value and the best look, and cover two windows with one window awning. Solera window awnings are available in standard arm and canopy sizes for windows that are under 33" in height and in XL sizes for windows over 33". Standard window awning arms are 18" long so they'll have an 18" projection, and XL window awning arms are 30" long so they'll have a 30" projection. Order arms and roller separately.

See pages 36-37 to order

KEEP THE HEAT OUT AND SAVE ON AC

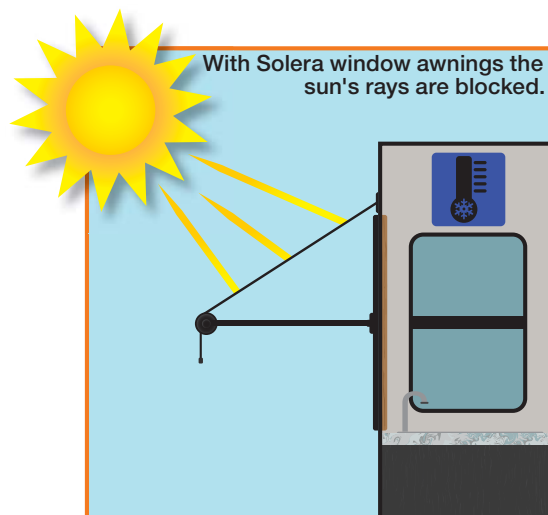
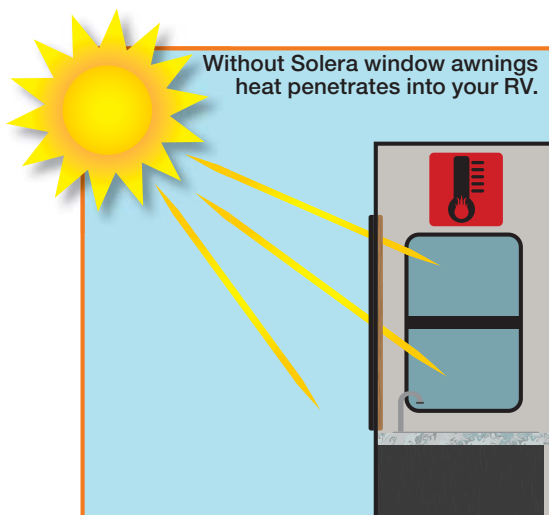



UPGRADE

SOLERA: SLIDERS

Give your slide-outs extra protection from debris and water infiltration with Solera Sliders. These attractive and economical slide-out awnings automatically retract and extend with your slide-out and prevent block leaves, bird droppings, branches and more from damaging slide-out seals.

FEATURES

- Attractive and economical protection for your slide-out
- Full coverage over the slide-out roof and the RV sidewall slide-out opening
- Blocks leaves, bird droppings, branches and debris
- Automatically retracts and extends with slide-out
- Fits slides ranging from 66" to 192" long and extending up to 48"
- Comes complete with awning rail and all mounting brackets
- Choose from multiple vinyl & acrylic fabric colors
- Available with the Solera Shield

See page 38 to order

		Competitor A	Competitor B
Fits slide-outs ranging from 66" to 192" in length	✓	✓	✗
(1) Part number that comes complete with awning rail, topper and all mounting brackets	✓	✗	✗
Multiple colors and options available	✓	✗	✗
Standard 13.5 oz vinyl fabric	✓	✓	✓
No anti-billowing device needed	✓	✗	✗
Heated wedge welding fuses vinyl together for strong, leak-resistant seams	✓	✗	✗
Accommodates slide-outs up to 48" wide	✓	✗ 42"	✗ 42"
Flexible placement; can be installed up to five inches above slide box trim	✓	✗	✗
NEW! Available (8) custom colors for the hardware to custom match your investment	✓	✗	✗

SOLERA: AWNBRELLA

Give your awning the extra support it needs



Awnbrella™



UNIVERSAL UPGRADE

SOLERA: AWNBRELLA

Give your awning extra support and a better angle for water runoff with the Solera Awnbrella. Perfect for destination campers who like to leave the awning extended for long periods, the patented rust-resistant aluminum bows hold fabric taut and arched so water doesn't pool and debris can easily run off. Now you won't have to camp with one end of your awning pitched lower than the other end. Solera Awnbrella's also complement Solera Screen Rooms and Family Rooms.

FEATURES

- Adjustable rust-resistant aluminum bows
- Keeps canopy from flapping in the wind
- Increases clearance over entry door
- Prevents canopy from sagging
- Stops water from pooling
- Enhances appearance

See page 39 to order

Great DIY for customers



Simple camp setup



① Position ② Slide ③ Tighten



Enjoy your Awnbrella!



FREE DISPLAY WITH STOCKING ORDER





UPGRADE

SOLERA: FABRIC LIGHT KIT

Destination Awning models and patio replacement fabrics feature a **NEW** integrated light cord sewn right into the awning hem. The flexible Solera Fabric Light Kit slides into the light cord by the coach side wall and under the awning. The innovative design allows you to enjoy dramatic lighting outside the RV when the awning is extended or retracted.
See page 39 to order



UPGRADE

SOLERA: SHIELD

The built-in Solera Shield is available on replacement slider and patio awning fabrics. It provides elegant and practical protection for your Solera vinyl or acrylic awning canopy. As the awning retracts, the aluminum Solera Shield automatically rolls up around the fabric to protect it against the elements during travel. Be sure to order your Solera Shield to match your hardware.
See page 39 to order

NOTE: Solera Shield not available on Solera XL awnings



UNIVERSAL UPGRADE

SOLERA: GROUND SUPPORT

Commonly lost or damaged, Solera Ground Support bars fit all three major awning brands. This aids you in support for the awning roller and allow more stability when you add screen rooms and family rooms to your awning. Stabilize your awning and prevent the roller from sagging with Solera Ground Support.
See page 39 to order



UPGRADE

SOLERA: AWNING CRADLE SUPPORT

The Awning Cradle Support works with power or manual awnings to support the roller assembly when in the travel position; support automatically accepts and releases the roller assembly as it extends and retracts.
See page 39 to order

SOLERA: SHADES AND ROOMS

Front, Side and Super Shades. Screen and Family Rooms



SOLERA: CLASSIC FRONT AND SIDE SHADES

Perfect for all awnings, the one-piece, black Solera Front Shade is easy to slide into your awning roller tube whenever you need a little extra shade, privacy or wind block. Solera Front Shade panels are available in 8', 10', 13', 15', 17' & 19' widths, each with a 6-foot screen height. The Solera Front Shade kit includes spikes and tie downs so you can secure it to the ground. The entire kit stores neatly in the included storage bag when not in use. Front and side shades sold separately.

Available in black plastic only.



SOLERA: SUPER SHADE

Many of the larger RV's today have patio awnings that are too high to reach when they are fully extended, and that's why we created the Solera Super Shade! The two-piece, black Solera Super Shade features a standard 6-foot shade height that easily zips into a Super Shade extension and can be permanently installed into your awning's roller tube.

NOTE: Must order both Super Shade Side Panels and Super Shade of same drop length to make a complete Super Shade kit. Solera Super Shade is available for standard 8' extension patio awnings only; not compatible with Solera XL awnings. Available in black plastic only.

The Super Shade extension can be ordered in five sizes that would provide either a 6', 7', 8', 9' or 10' total screen height. Order the Super Shade extension height based on how high your patio awning is from the ground to the roller tube while fully extended. For example, if your patio awning measures 10' high from ground to roller tube, order the 10' Super Shade. The Solera Super Shade comes in 10', 13', 15', 17' & 19' widths.

SOLERA: SHADES AND ROOMS

Front, Side and Super Shades. Screen and Family Rooms



SOLERA: FAMILY ROOM™

Turn the space under your awning into an enclosed outdoor patio with the Solera Family Room kit. Add up to 160 square feet of enclosed space so you can enjoy meals minus pesky insects. Or roll down the all-weather panels and use as a cozy sleeping area for kids.

FEATURES

- Lightweight gray fabric complements any RV color scheme
- Fits most 10'–21' manual and power awnings
- Accommodates RVs with awning rail-to-ground measurement up to 130"
- Fits 8' extension Solera, Carefree and Dometic® awnings
- Measure center of arm to center of arm to determine room size needed



SOLERA: SCREEN ROOM

Keep the bugs out and enjoy the breeze with the Solera Screen Room. Its neutral tan material helps to block out extra heat, making the Solera Screen Room perfect for outdoor dining, board games and social gatherings on hot summer days.

FEATURES

- Fits most 10'–21' manual and power awnings
- Accommodates RVs with awning rail-to-ground measurement up to 130"
- Fits 8' extension Solera, Carefree and Dometic awnings
- Measure center of arm to center of arm to determine room size needed



UNIVERSAL SHADES AND ROOMS

Our Universal shades and rooms fit the following:

- Solera 8' Extension Classic, Hybrid and 12V Power
- Carefree 8' Extension Spirit, Fiesta, Simplicity, Traveler and Eclipse Awnings
- Dometic® (A&E) 8' Extension 8500, 9000, 9100, Sunchaser and WeatherPro Awnings

See pages 40-41 to order

SOLERA: SHADES AND ROOMS COMPARISON

Screen and Family Rooms



SOLERA: SCREEN ROOM



SOLERA: FAMILY ROOM™



Solera Screen Room and Family Room™ Comparison

SOLERA® SCREEN ROOM	SOLERA® FAMILY ROOM	DOMETIC® ROOM (PATTY O'ROOM™)	CAREFREE BUENA VISTA	CAREFREE VACATION'R
Easy set-up	Easy set-up	Hard to set-up	Harder to set up, you have some small pieces that you have to connect to the room during set up. Takes longer to set-up	Harder to set up, you have some small pieces that you have to connect to the room during set up. Takes longer to set-up
Only screen/mesh room on the market. Perfect addition to your awning when you are not looking for an all weather room	Fully zippered privacy panels that keep out the wind and rain	This is an all weather room. To fit different sized awnings you have to buy zippered inserts. This means you can have several zippers in the screen that obstructs your view	Includes panels that cover screen	Includes panels that cover screen
Fits manual and 12V power awnings (with vertical arms) with awning rail to ground measurements of 101" to 130"	Fits manual and 12V power awnings (with vertical arms) with awning rail to ground measurements of 101" to 130"	Doesn't work well with 12V awnings. The room has rafter poles that hold the side panels under the awning. On 12V awnings that do not have a pitch, the awning can fill up with water and collapse	Fits manual and 12V power awnings (with vertical arms) with awning rail to ground measurements of 86" to 120". At the 120" maximum height you miss a lot of business	Fits manual and 12V power awnings (with vertical arms) with awning rail to ground measurements of 86" to 138", leaving lots of excess material on the ground
Neutral khaki mesh material keeps the space cool and doesn't attract heat	Cool gray polyester	Available in white vinyl only	Gray polyester	Gray polyester
Available to fit awnings 10' to 21' long in 1' increments	Available to fit awnings 10' to 21' long in 1' increments, this is a BIG PLUS – NEVER SETTLE FOR A ROOM SMALLER THAN YOUR AWNING WITH SOLERA'S 1' INCREMENTS.	Available to fit awnings 10' to 21' long in 2' increments. The room will be 1 foot short on some awnings	Available to fit awnings 10' to 21' long in 2' increments. The room will be 1 foot short on some awnings	Available to fit awnings 10' to 21' long in 2' increments. The room will be 1 foot short on some awnings
Lightweight, stores in 1 bag	Lightweight, stores in 1 bag	Heavy room, stores in 2 bags	Lightweight, stores in 1 bag	Lightweight, stores in 1 bag
Does not interfere with the rain dump feature of a 12V powered awning	Does not interfere with the rain dump feature of a 12V powered awning		Does not interfere with the rain dump feature of a 12V powered awning	Does not interfere with the rain dump feature of a 12V powered awning



ORDERING: **UNIVERSAL HARDWARE**

The world's fastest growing
RV awning brand just got even better

Solera Universal Arms fit any of these brands:



Universal Hardware fits the following Solera 8' extension awnings models: Power 12V, Power 18V, Hybrid and Classic Manual



Universal Hardware fits the following Dometic® 8' extension awnings models: 8500, 9000, 9100, Sunchaser and Weather Pro*



Universal Hardware fits the following Carefree 8' extension awnings models: Spirit, Fiesta, Simplicity Traveler and Eclipse**

Making it simple and easy to...



POWER UP

Power Up your mobile lifestyle with the Solera 12V Power or 18V Battery Operated awnings. Save yourself the stress and added time of manually setting up your awning!



UPGRADE

Upgrade your current manual or power awning with Solera Universal Hardware! Our Hybrid and Power awnings set up automatically for camping as they extend.



FIX IT

Tired of your old manual or power awning? With our newly designed Solera Universal hardware, replacing your broken or worn out awning has never been easier, no matter what awning brand you have.



Solera Universal Arms:

SOLERA: 18V POWER



Arm Type	Arm Size	Universal White Hardware	Universal Black Hardware
Tall Arm, Infinite Pitch	69"	434730	434729

SOLERA: 12V POWER



Arm Type	Arm Size	Universal White Hardware	Universal Black Hardware
Short Arm, Two-Position Pitch	60-1/2"	434722	434721
Tall Arm, Infinite Pitch	69"	434724	434723

SOLERA: HYBRID



Arm Type	Arm Size	Universal White Hardware	Universal Black Hardware
Short Arm, Two-Position Pitch	60-1/2"	434726	434725
Tall Arm, Infinite Pitch	69"	434728	434727

SOLERA: CLASSIC



Arm Type	Arm Size	Universal White Hardware	Universal Black Hardware
Short Arm	63"-68"	434716	434715
Standard Arm	68"-81"	434718	434717
Long Arm	81"-96"	434720	434719



ORDERING: UNIVERSAL AWNING HARDWARE AND ROLLER ASSEMBLIES

Solera 18V Power | Solera 12V Power | Solera Hybrid

HOW TO ORDER: UNIVERSAL 18V POWER, 12V POWER AND HYBRID

1. Measure the area where you want to mount the Solera awning, making sure the awning will not interfere with windows and doors.
2. Taking that measurement, order that size Awning Roller Assembly, and choose your desired vinyl color. Use the Awning Roller guide for 12V Power, Hybrid, & Power 18V Battery to select the correct part number.
3. Measure the distance from the awning rail down the side wall to order the correct arms from the arm guide. You will need to have 1 part number for the awning roll and 1 part number for the hardware selected for a complete order.

SOLERA: 18V POWER



Arm Type	Arm Size	Universal White Hardware	Universal Black Hardware
Tall Arm, Infinite Pitch	69"	434730	434729

SOLERA: 12V POWER



Arm Type	Arm Size	Universal White Hardware	Universal Black Hardware
Short Arm, Two-Position Pitch	60-1/2"	434722	434721
Tall Arm, Infinite Pitch	69"	434724	434723

SOLERA: HYBRID



Arm Type	Arm Size	Universal White Hardware	Universal Black Hardware
Short Arm, Two-Position Pitch	60-1/2"	434726	434725
Tall Arm, Infinite Pitch	69"	434728	434727

Standard 8' Projection Vinyl Roller Assemblies for 18V Power, 12V Power and Hybrid

Length	Solid Black BKSOLID	Black Fade BKWG	White Fade WHWG	Sand Fade BKWG	Sand Fade WHWG	Burgundy Fade WHWG	Blue Fade WHWG	Silver Fade WHWG	Green Fade WHWG
10'	V000211447	V000211446	V000211450	V000231492	V000231508	V000286883	V000286908	V000307065	V000344965
11'	V000256341	V000211452	V000213035	V000223158	V000223153	V000286885	V000286909	V000342917	V000344966
12'	V000231439	V000211455	V000211457	V000223159	V000223177	V000286886	V000286910	V000342918	V000344969
13'	V000211460	V000211459	V000211462	V000223160	V000223178	V000286887	V000286911	V000342919	V000344970
14'	V000211468	V000211466	V000211475	V000223161	V000223179	V000286888	V000286912	V000324187	V000344971
15'	V000231442	V000211480	V000211483	V000223162	V000223185	V000286889	V000286914	V000312456	V000344972
16'	V000211487	V000211486	V000211492	V000223163	V000223189	V000286890	V000286915	V000342920	V000344973
17'	V000231446	V000211498	V000211502	V000223165	V000223190	V000286891	V000286916	V000342921	V000344974
18'	V000211506	V000211505	V000211510	V000223170	V000223191	V000286892	V000286920	V000342922	V000344975
19'	V000211513	V000211512	V000211514	V000231497	V000231519	V000286893	V000286921	V000342924	V000344976
20'	V000211518	V000211517	V000211523	V000231498	V000231520	V000286894	V000286922	V000342925	V000344977
21'	V000211532	V000211531	V000254845	V000255587	V000266033	V000286895	V000286924	V000324185	V000344978



HOW TO ORDER: UNIVERSAL CLASSIC MANUAL PATIO AWNINGS

1. Measure the area where you want to mount the Solera awning, making sure the awning will not interfere with windows and doors.
2. Taking that measurement, order that size Awning Roller Assembly, and choose your desired vinyl color. Use the Awning Roller guide for Classic Manual to select the correct part number.
3. Measure the distance from the awning rail down the side wall to order the correct arms from the arm guide. You will need to have 1 part number for the awning roll and 1 part number for the hardware selected for a complete order.

SOLERA: CLASSIC



Arm Type	Arm Size	Universal White Hardware	Universal Black Hardware
Short Arm	63"-68"	434716	434715
Standard Arm	68"-81"	434718	434717
Long Arm	81"-96"	434720	434719

Standard 8' Projection Vinyl Roller Assemblies for Classic Manual Patio Awnings

width	Solid Black BKSOLID	Black Fade BKWG	White Fade WHWG	Sand Fade BKWG	Sand Fade WHWG	Burgundy Fade WHWG	Blue Fade WHWG	Silver Fade WHWG	Green Fade WHWG
10'	V000343115	V000343034	V000343000	V000343059	V000343048	V000343071	V000343090	V000343101	V000344991
11'	V000343114	V000343033	V000343001	V000343058	V000343047	V000343070	V000343089	V000343100	V000344992
12'	V000343113	V000343032	V000343002	V000343057	V000343046	V000343069	V000343088	V000343099	V000344993
13'	V000343112	V000343031	V000343003	V000343056	V000343045	V000343068	V000343087	V000343098	V000344994
14'	V000343111	V000343030	V000343004	V000343055	V000343044	V000343067	V000343085	V000343097	V000344995
15'	V000343109	V000343029	V000343005	V000343054	V000343043	V000343065	V000343083	V000343096	V000344996
16'	V000343108	V000343027	V000343006	V000343053	V000343042	V000343064	V000343080	V000343095	V000344997
17'	V000343107	V000343026	V000343007	V000343052	V000343038	V000343063	V000343078	V000343094	V000344998
18'	V000343106	V000343025	V000343008	V000343051	V000343037	V000343062	V000343075	V000343093	V000344999
19'	V000343105	V000343024	V000343009	V000343050	V000343036	V000343061	V000343074	V000343092	V000345000
20'	V000343102	V000343023	V000343010	V000343049	V000343035	V000343060	V000343073	V000343091	V000345001
21'	V000343022	V000343015	V000343011	V000343017	V000343016	V000343018	V000343019	V000343020	V000345002

ORDERING: XL POWER AWNING HARDWARE AND ROLLER ASSEMBLIES

Solera XL Power

HOW TO ORDER: XL POWER AWNINGS

1. Measure the area where you want to mount the Solera XL Awning, making sure the awning will not interfere with windows and doors.
2. Taking that measurement, order that size Awning Roller Assembly and choose your desired vinyl color. Use the Awning Roller guide for XL Power to select the correct part number.
3. Measure the distance from the awning rail down the side wall to make sure it fits. You will need to have 1 part number for the awning roll and 1 part number for the hardware selected for a complete order.

Solera XL Power Hardware

Arm Type	Arm Size	Standard Head/ White Hardware	Standard Head/ Black Hardware	Standard Head/ Satin Hardware	Standard Head/ Cream Hardware
XL Arm, Flat Adjustable Pitch	78"	383091	383092	V000389154	V000389059

9'8" Projection XL Vinyl Roller Assemblies

Length	Solid Black BKSOLID	Black Fade BKWG	White Fade WHWG	Sand Fade BKWG	Sand Fade WHWG	Burgundy Fade WHWG	Blue Fade WHWG	Silver Fade WHWG	Green Fade WHWG
10'	V000334746	V000334742	V000334743	V000334745	V000334744	V000334747	V000334748	V000334749	V000344979
11'	V000334914	V000334909	V000334911	V000334912	V000334913	V000334915	V000334916	V000334917	V000344980
12'	V000334922	V000334918	V000334919	V000334920	V000334921	V000334923	V000334924	V000334925	V000344981
13'	V000334937	V000334926	V000334927	V000334928	V000334934	V000334938	V000334939	V000334940	V000344982
14'	V000334946	V000334941	V000334942	V000334944	V000334945	V000334947	V000334948	V000334949	V000344983
15'	V000334954	V000334950	V000334951	V000334952	V000334953	V000334955	V000334956	V000334957	V000344984
16'	V000334979	V000334959	V000334965	V000334970	V000334976	V000334983	V000334987	V000334992	V000344985
17'	V000335005	V000334961	V000334998	V000334999	V000335001	V000335009	V000335014	V000335020	V000344986
18'	V000335034	V000334963	V000335000	V000335029	V000335031	V000335037	V000335039	V000335041	V000344987
19'	V000335046	V000334966	V000335007	V000335043	V000335044	V000335048	V000335050	V000335052	V000344988
20'	V000335062	V000334969	V000335011	V000335055	V000335059	V000335066	V000335071	V000335074	V000344989
21'	V000335092	V000334972	V000335015	V000335067	V000335089	V000335093	V000335094	V000335095	V000344990

HOW TO ORDER: DESTINATION PATIO AWNINGS

1. Measure the area where you want to mount the Solera awning, making sure the awning will not interfere with windows and doors.
2. Taking that measurement, order that size Awning Roller Assembly, and choose your desired vinyl color. Use the Awning Roller guide for Destination to select the correct part number.
3. Measure the distance from the awning rail down the side wall and order the correct arms from the arm guide. You will need to have 1 part number for the awning roll and 1 part number for the hardware selected for a complete order.

Solera Destination Hardware

White Hardware	Black Hardware	Satin Hardware	Cream Hardware
V000334718	V000334719	V000334720	V000386361

Solera Destination 9'8" Projection Awning Roller Assemblies
13.5 oz Vinyl Fabric with wraparound aluminum Solera Shield

Remember to specify the Solera Shield color to match the hardware color of your awning

Width	Black Solid, BKS	Black Fade, BKS	Black Fade, WHS	White Fade, WHS	White Fade, BKS	Sand Fade, BKS	Sand Fade, WHS
16'	V000334847	V000334818	V000334867	V000334839	V000334843	V000334873	V000334870
17'	V000335317	V000335268	V000335279	V000335294	V000335302	V000335338	V000335329
18'	V000335319	V000335270	V000335281	V000335296	V000335310	V000335340	V000335331
19'	V000335322	V000335272	V000335287	V000335298	V000335324	V000335342	V000335332
20'	V000335323	V000335274	V000335289	V000335300	V000335326	V000335345	V000335334
21'	V000335325	V000335276	V000335292	V000335301	V000335327	V000335348	V000335336

Width	Burgundy Fade, WHS	Burgundy Fade, BKS	Blue Fade, WHS	Blue Fade, BKS	Silver Fade, BKS	Silver Fade, WHS	Green Fade, WHS	Green Fade, BKS
16'	V000334857	V000334859	V000334861	V000334865	V000334864	V000334862	V000345003	V000345009
17'	V000335370	V000335337	V000335389	V000335397	V000335350	V000335364	V000345004	V000345010
18'	V000335378	V000335343	V000335393	V000335401	V000335352	V000335368	V000345005	V000345011
19'	V000335383	V000335347	V000335396	V000335408	V000335354	V000335372	V000345006	V000345012
20'	V000335386	V000335361	V000335404	V000335414	V000335356	V000335375	V000345007	V000345013
21'	V000335390	V000335366	V000335410	V000335423	V000335358	V000335380	V000345008	V000345014

The color of the Shield is noted as BKS meaning black; or WHS, meaning white

ORDERING: WINDOW AWNING HARDWARE AND ROLLER ASSEMBLIES

Window awning hardware and roller assemblies

HOW TO ORDER: WINDOW AWNINGS

1. Measure outside frame to outside frame of the window you desire to cover.
2. Round up to the next size. Example: a 50" window use a 54" window awning base on the chart provided.
3. Measure the height of the window. If the window measures 32" or greater, use the XL model arms. You will need to have 1 part number for the window awning roll and 1 part number for the hardware selected for a complete order.

Window Awning Hardware

Height	White Hardware	Black Hardware	Satin Hardware	Cream Hardware
Standard (Under 33")	V000334754	V000334750	V000334753	V000389164

Standard Solera Vinyl Window Awning Roller Assemblies, 18" Projection

Width	Solid Black BKWG	Black Fade BKWG	White Fade WHWG	Sand Fade BKWG	Sand Fade WHWG	Burgundy Fade WHWG	Blue Fade WHWG	Silver Fade WHWG	Green Fade WHWG
36"	V000334804	V000334776	V000334778	V000334824	V000334779	V000334800	V000334802	V000334806	V000345015
42"	V000335426	V000334962	V000335002	V000335040	V000335087	V000335153	V000335351	V000335469	V000345016
48"	V000335427	V000334964	V000335004	V000335056	V000335088	V000335154	V000335355	V000335472	V000345019
54"	V000335428	V000334967	V000335006	V000335057	V000335090	V000335155	V000335359	V000335474	V000345020
60"	V000335429	V000334968	V000335008	V000335058	V000335091	V000335156	V000335362	V000335475	V000345021
66"	V000335430	V000334971	V000335010	V000335060	V000335105	V000335158	V000335367	V000335476	V000345022
72"	V000335432	V000334973	V000335012	V000335061	V000335106	V000335159	V000335371	V000335477	V000345023
78"	V000335434	V000334974	V000335013	V000335063	V000335107	V000335160	V000335377	V000335478	V000345024
84"	V000335436	V000334975	V000335016	V000335064	V000335108	V000335162	V000335381	V000335480	V000345025
90"	V000335438	V000334977	V000335017	V000335065	V000335109	V000335164	V000335384	V000335481	V000345026
96"	V000335440	V000334978	V000335019	V000335068	V000335110	V000335165	V000335388	V000335482	V000345027
102"	V000335445	V000334980	V000335021	V000335069	V000335116	V000335167	V000335392	V000335483	V000345028
108"	V000335447	V000334981	V000335022	V000335070	V000335117	V000335169	V000335394	V000335484	V000345029
114"	V000335448	V000334982	V000335023	V000335072	V000335119	V000335171	V000335398	V000335485	V000345030
120"	V000335450	V000334984	V000335024	V000335073	V000335121	V000335172	V000335400	V000335486	V000345031
126"	V000335453	V000334985	V000335025	V000335075	V000335123	V000335173	V000335403	V000335487	V000345032
132"	V000335454	V000334986	V000335026	V000335078	V000335124	V000335175	V000335405	V000335488	V000345033
138"	V000335456	V000334989	V000335027	V000335079	V000335125	V000335177	V000335407	V000335489	V000345034
144"	V000335458	V000334990	V000335028	V000335080	V000335126	V000335179	V000335411	V000335490	V000345035
150"	V000335460	V000334991	V000335030	V000335081	V000335128	V000335181	V000335413	V000335491	V000345062
156"	V000335462	V000334993	V000335032	V000335082	V000335130	V000335183	V000335416	V000335492	V000345063
162"	V000335463	V000334994	V000335033	V000335083	V000335131	V000335184	V000335418	V000335493	V000345064
168"	V000335466	V000334995	V000335035	V000335084	V000335132	V000335186	V000335420	V000335494	V000345065
174"	V000335467	V000334996	V000335036	V000335085	V000335133	V000335188	V000335422	V000335495	V000345066
180"	V000335468	V000334997	V000335038	V000335086	V000335135	V000335189	V000335424	V000335496	V000345067

ORDERING: XL WINDOW AWNING HARDWARE AND ROLLER ASSEMBLIES

XL window awning hardware and roller assemblies

XL Window Awning Hardware

Height	White Hardware	Black Hardware	Satin Hardware	Cream Hardware
XL (Over 33")	V000334759	V000334764	V000334765	V000389165

XL Solera Vinyl Window Awning Roller Assemblies, 30" Projection

Width	Solid Black BKWG	Black Fade BKWG	White Fade WHWG	Sand Fade BKWG	Sand Fade WHWG	Burgundy Fade WHWG	Blue Fade WHWG	Silver Fade WHWG	Green Fade WHWG
36"	V000334814	V000335254	V000334808	V000334825	V000334811	V000334812	V000334813	V000334807	V000345068
42"	V000335199	V000335262	V000335253	V000335357	V000335255	V000335111	V000335150	V000335176	V000345069
48"	V000335200	V000335265	V000335263	V000335360	V000335256	V000335112	V000335151	V000335228	V000345070
54"	V000335201	V000335266	V000335306	V000335363	V000335257	V000335113	V000335152	V000335229	V000345071
60"	V000335202	V000335267	V000335308	V000335365	V000335258	V000335114	V000335157	V000335230	V000345072
66"	V000335203	V000335269	V000335309	V000335369	V000335259	V000335115	V000335161	V000335231	V000345073
72"	V000335204	V000335271	V000335311	V000335373	V000335260	V000335118	V000335163	V000335234	V000345074
78"	V000335209	V000335273	V000335312	V000335374	V000335261	V000335120	V000335166	V000335235	V000345075
84"	V000335210	V000335275	V000335313	V000335376	V000335431	V000335122	V000335168	V000335236	V000345076
90"	V000335211	V000335277	V000335314	V000335379	V000335433	V000335127	V000335170	V000335237	V000345077
96"	V000335212	V000335278	V000335315	V000335382	V000335435	V000335129	V000335174	V000335238	V000345078
102"	V000335213	V000335280	V000335316	V000335385	V000335437	V000335134	V000335178	V000335239	V000345079
108"	V000335214	V000335282	V000335318	V000335387	V000335439	V000335136	V000335180	V000335240	V000345080
114"	V000335215	V000335283	V000335320	V000335391	V000335441	V000335137	V000335182	V000335241	V000345081
120"	V000335216	V000335284	V000335321	V000335395	V000335442	V000335139	V000335185	V000335242	V000345082
126"	V000335217	V000335285	V000335328	V000335399	V000335444	V000335140	V000335187	V000335243	V000345083
132"	V000335218	V000335286	V000335330	V000335402	V000335446	V000335141	V000335190	V000335244	V000345084
138"	V000335219	V000335288	V000335333	V000335406	V000335449	V000335142	V000335191	V000335245	V000345085
144"	V000335220	V000335290	V000335335	V000335409	V000335452	V000335143	V000335192	V000335246	V000345086
150"	V000335222	V000335291	V000335339	V000335412	V000335455	V000335144	V000335193	V000335247	V000345087
156"	V000335223	V000335293	V000335341	V000335415	V000335457	V000335145	V000335194	V000335248	V000345088
162"	V000335224	V000335295	V000335344	V000335417	V000335459	V000335146	V000335195	V000335249	V000345089
168"	V000335225	V000335297	V000335346	V000335419	V000335461	V000335147	V000335196	V000335250	V000345090
174"	V000335226	V000335299	V000335349	V000335421	V000335464	V000335148	V000335197	V000335251	V000345091
180"	V000335227	V000335264	V000335353	V000335425	V000335465	V000335149	V000335198	V000335252	V000345092

ORDERING: **SLIDE-OUT TOPPERS** **UNIVERSAL CUT TO FIT SLIDE-OUT FABRIC REPLACEMENT**

Give your slide-outs extra protection

HOW TO ORDER: **SLIDE-OUT TOPPERS**

1. Measure outside flange to outside flange of the slide-out you want to cover with the Solera Slide-Out Topper.
2. Use the Slide-Out Topper chart to select the correct size for you. One part number will supply you the slide-out topper roll, all hardware and the rail to mount the Slide-Out Topper

Vinyl Roller Assemblies for Solera Sliders

Flange Measurement	Fabric Size	Black vinyl & hardware	White vinyl & hardware
57" to 61"	61"	V000168104	V000163273
62" to 67"	67"	V000231482	V000163274
68" to 73"	73"	V000165063	V000163279
74" to 79"	79"	V000168105	V000163285
80" to 85"	85"	V000165062	V000163287
86" to 91"	91"	V000168106	V000163288
92" to 97"	97"	V000168107	V000163289
98" to 103"	103"	V000168108	V000163290
104" to 109"	109"	V000168325	V000163291
110" to 115"	115"	V000251461	V000163292
116" to 121"	121"	V000182037	V000163293
122" to 127"	127"	V000168326	V000163294
128" to 133"	133"	V000184673	V000163295
134" to 139"	139"	V000168328	V000139496
140" to 145"	145"	V000177334	V000163298
146" to 151"	151"	V000165061	V000163299
152" to 157"	157"	V000168109	V000163300
158" to 163"	163"	V000168110	V000163301
164" to 169"	169"	V000168112	V000163302
170" to 175"	175"	V000251477	V000163303
176" to 181"	181"	V000251478	V000163304
182" to 187"	187"	V000194925	V000163307

Solera Universal Slide-Out Topper Cut to Fit Replacement Fabric



Description	Part no.
Fabric Assembly - Slide Topper - 50 ft Black 57" x 12.5" x 13.25"	432253
Fabric Assembly - Slide Topper - 50 ft White 57" x 12.5" x 13.25"	432252

Solera Awmbrella



Part no.	Description
362237	8' Awmbrella, 3 pack
362238	8' Awmbrella, 2 pack
362239	10' Awmbrella, 3 pack
362240	10' Awmbrella, 2 pack

awning width	number of boxes needed (total arms)
between 10' - 14'	1 (total 2 arms)
between 14' - 18'	1 (total 3 arms)
between 18' - 22'	2 (total 4 arms)
between 22' - 27'	1 + 1 (total 5 arms)

Universal Awning Ground Support



Part no.	Color
362246	White Ground Support
362247	Black Ground Support



Solera Fabric Light Kit

Part no.	Length	Color
387593	15'	Black Plastic
387594	21'	Black Plastic



Awning Cradle Support

Part no.	Description
289373	White Support
289374	Black Support





ORDERING: UNIVERSAL FIT SHADES AND ROOMS

Front, Side and Super Shades. Screen and Family Rooms

HOW TO ORDER: SHADES AND ROOMS

1. 1.Measure center arm to center arm of the RV awning and order that size. Example: if your awning measures 15' order a 15' room. 1 part number will supply you the correct product.

Quick Tip: The biggest mistake when ordering a Screen Room or Family Room is usually measuring the awning fabric and not measuring center arm to center arm. If you measure by fabric, the room will arrive one foot too short.



Classic Front Shade

Width	Part no.
8'	3833980608
10'	3833980610
13'	3833980613
15'	3833980615
17'	3833980617
19'	3833980619



Side Shade Panels

Drop	Part no.
6' Drop	37978606
7' Drop	37978607
8' Drop	37978608
9' Drop	37978609
10' Drop	37978610



Super Shade

Width	6' drop	7' drop	8' drop	9' drop	10' drop
10'	3797820610	3797820710	3797820810	3797820910	3797821010
13'	3797820613	3797820713	3797820813	3797820913	3797821013
15'	3797820615	3797820715	3797820815	3797820915	3797821015
17'	3797820617	3797820717	3797820817	3797820917	3797821017
19'	3797820619	3797820719	3797820819	3797820919	3797821019

ORDERING: UNIVERSAL FIT SHADES AND ROOMS
 Front, Side and Super Shades. Screen and Family Rooms



Solera Family Room™ 

Size	Part no.	Size	Part no.
10'	362225	16'	362231
11'	362226	17'	362232
12'	362227	18'	362233
13'	362228	19'	362234
14'	362229	20'	362235
15'	362230	21'	362236



Solera Screen Room 

Size	Part no.	Size	Part no.
10'	362213	16'	362219
11'	362214	17'	362220
12'	362215	18'	362221
13'	362216	19'	362222
14'	362217	20'	362223
15'	362218	21'	362224



ORDERING: **UNIVERSAL REPLACEMENT FABRIC**

HOW TO ORDER: **UNIVERSAL REPLACEMENT FABRICS**

1. Measure center of arm to center of arm of the patio awning to correctly order that size fabric.
2. Choose the color of the fabric you desire.
3. Use the chart provided and your measurement of center arm to center arm and vinyl color desired to select your part number. Example: If your measurement from center arm to center arm is 15' then you would select 15' and choose your desired color of vinyl. 1 part number will supply you the correct product.

Quick fact: Do not order fabric replacement size based on the actual awning fabric width as it will arrive too short

SELECT FROM THESE PATIO AWNING REPLACEMENT CHOICES:



All vinyl

- Heavy-duty 13.5 oz fabric
- Cold-crack tested to -25° F
- Nine color choices



Vinyl Canopy with Solera Shield

- Painted Solera Shield is available in black or white

NOTE: Solera Shield not available on XL Awning



Woven Acrylic Canopy with Solera Shield

- Woven fabric is breathable, so the area under the canopy may stay cooler than vinyl canopies
- Six color choices
- Mildew-resistant fabric
- Comes complete with Solera Shield

NOTE: Solera Shield not available on XL Awning

ALL VINYL OPTIONS:



Solid Black BKSOLID



Black Fade WHWG



White Fade BKWG



Sand Fade BKWG



Sand Fade WHWG



Burgundy Fade WHWG



Blue Fade WHWG



Silver Fade WHWG



Green Fade WHWG

The world's fastest growing RV awning brand



Universal Replacement Fabrics for 8' Projection Vinyl Patio Awnings



Width	Black Fade BKWG	White Fade WHWG	Sand Fade BKWG	Sand Fade WHWG	Solid Black BKWG	Burgundy Fade WHWG	Blue Fade WHWG	Silver Fade WHWG	Green Fade WHWG
10'	V000334336	V000334335	V000334337	V000334346	V000334338	V000334339	V000334340	V000334345	V000345093
11'	V000334341	V000334342	V000334343	V000334344	V000334347	V000334348	V000334351	V000334353	V000345094
12'	V000334355	V000334356	V000334357	V000334358	V000334359	V000334360	V000334361	V000334363	V000345095
13'	V000334364	V000334365	V000334366	V000334367	V000334368	V000334369	V000334370	V000334372	V000345096
14'	V000334373	V000334374	V000334375	V000334376	V000334377	V000334378	V000334379	V000334382	V000345097
15'	V000334383	V000334385	V000334387	V000334388	V000334389	V000334390	V000334391	V000334393	V000345098
16'	V000334394	V000334397	V000334398	V000334399	V000334400	V000334401	V000334402	V000334404	V000345099
17'	V000334405	V000334406	V000334407	V000334408	V000334409	V000334410	V000334411	V000334413	V000345101
18'	V000334415	V000334416	V000334417	V000334418	V000334419	V000334420	V000334421	V000334423	V000345102
19'	V000334424	V000334426	V000334428	V000334429	V000334430	V000334431	V000334432	V000334434	V000345103
20'	V000334435	V000334436	V000334437	V000334438	V000334439	V000334440	V000334441	V000334443	V000345104
21'	V000334444	V000334445	V000334446	V000334447	V000334448	V000334449	V000334450	V000334452	V000345105

*The color of the exposed vinyl in the rolled up position is noted as BKWG meaning black; or WHWG, meaning white

VINYL WITH SOLERA SHIELD: ACRYLIC FABRIC WITH SOLERA SHIELD:

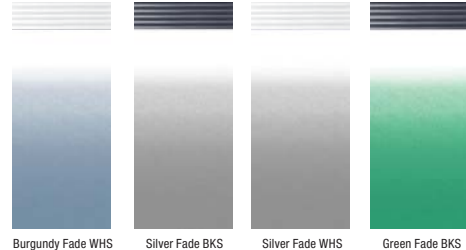
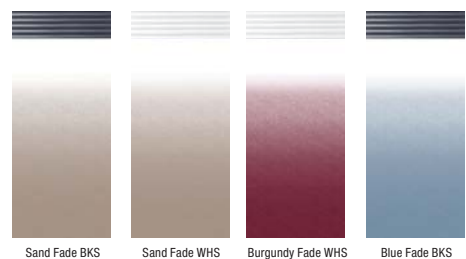
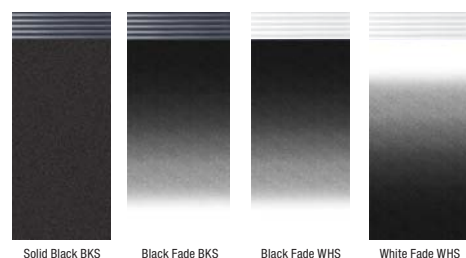

Special Order Canopy Option:
- Woven acrylic fabric with Solera Shield (Allow for standard lead time)

Special Order Canopy Option:
- Vinyl Fabric with Solera Shield (Allow for standard lead time)



Solera Fabric Light Kit

Part no.	Length	Color
387593	15'	Black Plastic
387594	21'	Black Plastic

ORDERING: AWNING REPLACEMENT PARTS (NON-UNIVERSAL)

Power & Manual Awning Parts (Non-Universal)



Power & Manual Awning Parts (Non-Universal)

Part no.	Description
295742	61 1/2" Short Awning Support Arm Assembly, White
295743	61 1/2" Short Awning Support Arm Assembly, Black
260294	66 1/8" Pitched Awning Support Arm Assembly, White
266169	66 1/8" Pitched Awning Support Arm Assembly, Black
281152	69" Standard Flat Awning Support Arm Assembly, White
281154	69" Standard Flat Awning Support Arm Assembly, Black
280343	Gas Strut 26", 124 lb For Short And Flat Arms
260282	Gas Strut, 124-144 lb For Pitched Arms
289557	Awning Plain Drive Head Front Cover, White
289560	Awning Plain Drive Head Front Cover, Black
289558	Awning Plain Drive Head Back Cover, White
289561	Awning Plain Drive Head Back Cover, Black
289563	Awning Plain Idler Head Front Cover, White
289566	Awning Plain Idler Head Front Cover, Black
289564	Awning Plain Idler Head Back Cover, White
289567	Awning Plain Idler Head Back Cover, Black

Continued

Part no.	Description
289373	Awning Cradle Support, White
289374	Awning Cradle Support, Black
406511	Rollbar Only For 12' Black Awning, Black Tube
422429	Rollbar Only For 15' Black Awning, Black Tube
422432	Rollbar Only For 16' Black Awning, Black Tube
422435	Rollbar Only For 18' Black Awning, Black Tube
422438	Rollbar Only For 21' Black Awning, Black Tube
406513	Rollbar Only For 12' White Awning, Grey Tube
422430	Rollbar Only For 15' White Awning, Grey Tube
422433	Rollbar Only For 16' White Awning, Grey Tube
422436	Rollbar Only For 18' White Awning, Grey Tube
422439	Rollbar Only For 21' White Awning, Grey Tube
275071	Grommet, Diaphragm, .75 ID x 1 OD, Black, For Manual Over-Ride Hole

ORDERING: AWNING REPLACEMENT PARTS (NON-UNIVERSAL)

Manual Awning Parts Only (Non-Universal)



Manual Awning Parts Only (Non-Universal)

Part no.	Description
271181	Manual Pull Style Awning Drive Head Assembly, White
272067	Manual Pull Style Awning Drive Head Assembly, Black
272397	Manual Pull Style Awning Idler Head Assembly, White
285147	Manual Pull Style Awning Idler Head Assembly, Black
292794	Manual Awning Pull Strap Replacement
344391	Manual Awning Pull Rod
300029	Manual Crank Style Awning Drive Head Assembly, White
300031	Manual Crank Style Awning Drive Head Assembly, Black
266147	Manual Crank Style Awning Idler Head Assembly, White
273479	Manual Crank Style Awning Idler Head Assembly, Black
300030	Manual Crank Style Awning Hook And Crank Rod, White
351831	Manual Crank Style Awning Drive Head Front Cover, White
351832	Manual Crank Style Awning Drive Head Front Cover, Black
333410	Pull Style Manual to Crank Style Manual Upgrade Kit, White
333411	Pull Style Manual to Crank Style Manual Upgrade Kit, Black
299993	Grommet Diaphragm, 1.625 ID X 1.929 OD, Black, For Manual Crank Hole

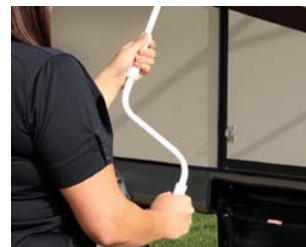

292794

300030

ORDERING: AWNING REPLACEMENT PARTS (NON-UNIVERSAL)

Power Awning Parts (Non-Universal)



Power Awning Parts (Non-Universal)

Part no.	Description
373566	Power Awning Replacement Motor
266146	Power Awning Plain Drive Head Assembly, White
273478	Power Awning Plain Drive Head Assembly, Black
266147	Power Awning Plain Idler Head Assembly, White
273479	Power Awning Plain Idler Head Assembly, Black
342147	Power Awning Speaker Drive Head Assembly, White
342149	Power Awning Speaker Drive Head Assembly, Black
342148	Power Awning Speaker Idler Head Assembly, White
342150	Power Awning Speaker Idler Head Assembly, Black
354181	Power Awning Speaker Drive Head Front Cover, White
354185	Power Awning Speaker Drive Head Front Cover, Black
300005	Power Awning Speaker Drive Head Back Cover, White
300009	Power Awning Speaker Drive Head Back Cover, Black
354186	Power Awning Speaker Idler Head Front Cover, White

Continued

Part no.	Description
354189	Power Awning Speaker Idler Head Front Cover, Black
300007	Power Awning Speaker Idler Head Back Cover, White
300011	Power Awning Speaker Idler Head Back Cover, Black
285499	Power Awning Switch Kit, White
285500	Power Awning Switch Kit, Black
285079	Power Awning Bezel Spacer, White
285077	Power Awning Bezel Spacer, Black
280570	16 GA Power Awning Harness
329250	Manual Pull Style To Power Awning Conversion Kit, White
329251	Manual Pull Style To Power Awning Conversion Kit, Black
337727	Manual Crank Style To Power Awning Conversion Kit, White
337728	Manual Crank Style To Power Awning Conversion Kit, Black
351863	Plain Power Awning To Speaker Head Conversion Kit, White
351864	Plain Power Awning To Speaker Head Conversion Kit, Black

ORDERING: AWNING REPLACEMENT PARTS (NON-UNIVERSAL)

Idler Head Assembly

266147 – White
273479 – Black

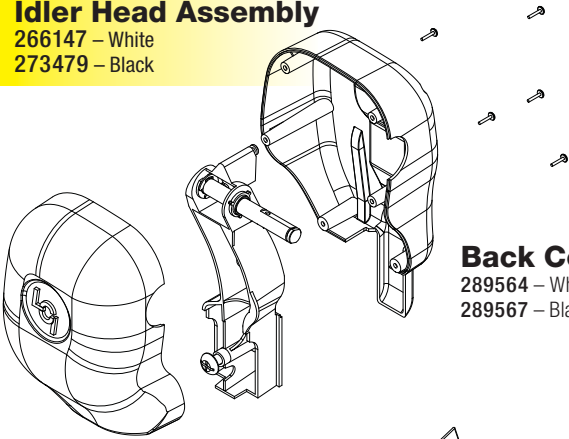

Back Cover

289564 – White
289567 – Black

Front Cover

289563 – White
289566 – Black

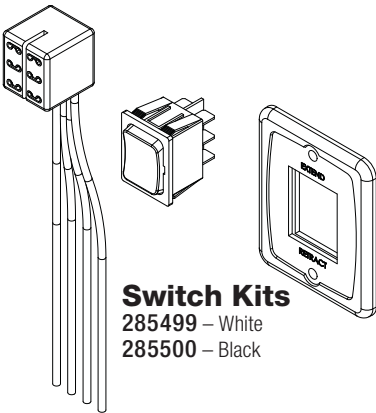

Switch Kits

285499 – White
285500 – Black

Drive Head Assembly

266146 – White
273478 – Black

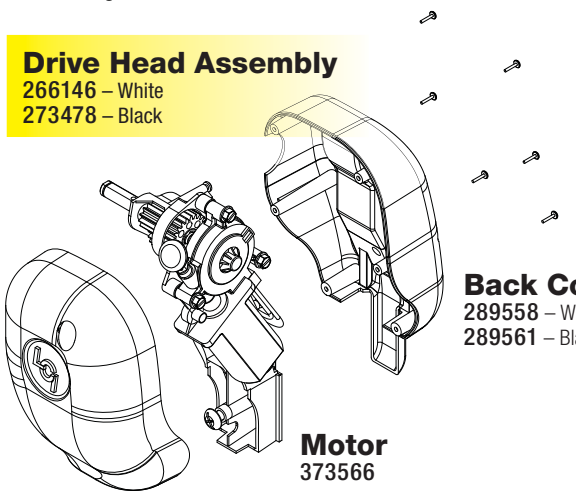

Back Cover

289558 – White
289561 – Black

Motor

373566

Front Cover

289557 – White
289560 – Black

Arms

295742 – 61-1/2" White
295743 – 61-1/2" Black
260294 – 66-1/8" White
266169 – 66-1/8" Black
281152 – 69" White
281154 – 69" Black

Drive Side

Front of coach/right

Idler Side

Rear of coach/left

Ordering Replacement Arms

There are three types of Solera replacement arms. These arms are universal to both power and manual awnings. Simply measure the length of the wall-mount extrusion from top to bottom.

- Short style arms measure 60-1/2"
- Pitched style arms measure 66-1/8"
- Flat style arms measure 69"



Wiring Harness

280570

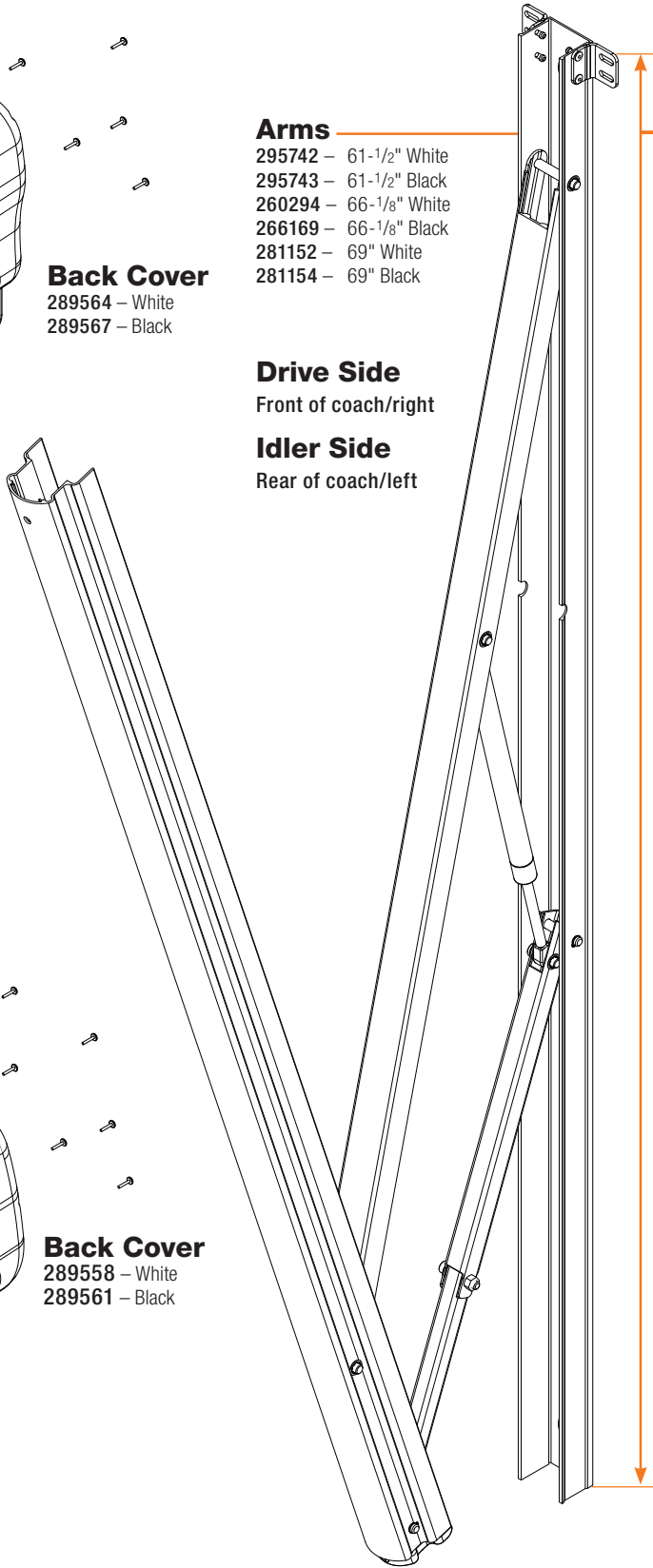

Solera®

by  Lippert Components®



2016 AWNINGS & ACCESSORIES



LIPPERT
COMPONENTS®

➤ SO MUCH MORE THAN SHADE & SHELTER

Solera Awnings by Lippert Components offer so much more than shade and shelter with a range of unique awning styles, sizes and options including awning lights, speakers and multiple fabric and hardware color options to compliment the colors in your RV's exterior graphics. Nothing gives an RV a more noticeable facelift than installing a new awning or replacing the awning fabric, so choose the best – choose Solera.



AWNINGS



CHOOSE FROM FOUR INNOVATIVE SOLERA AWNING MODELS



SOLERA: **POWER**
12V Push-Button Control



SOLERA: **CLASSIC**
Traditional Manual Spring Roll Up



SOLERA: **HYBRID**
Sets Up & Stores Automatically as you Crank



SOLERA: **DESTINATION**
Carport-Sized Shade & Shelter

SOLERA POWER



NOTE: All awnings available from 10' to 21' widths in 1' increments



SOLERA: **POWER** 12V Push-Button Control

Isn't it time to replace your old manual awning? Upgrade to enjoy quick and easy setup with a premium Solera Power Awning. The top bracket fits right over the mounting holes from your old awning and the kit includes a label to cover mounting holes from the old bottom bracket. Choose from a wider range of sizes and fabric and hardware colors than any other RV awning brand under the sun.



- Exclusive, quick and simple independent pitch adjustment



- Enjoy full or partial extension

Additional Features

- Auto rain dump feature — if water pools in the canopy, the arms will release it
- Designed to provide optimum pitch when used over slide-outs
- Easy access with optional manual override
- Super easy operation: operates with push button mounted inside RV

Solera® Power Hardware

Short Arm, Fixed Pitch

- Requires 60-1/2" unobstructed area from awning rail straight down
- Requires min. clearance of 13-1/2" between awning rail and top of entry door
- This hardware will roll the awning out to a pre-set pitch for maximum shade and ideal rain runoff

Tall Arm, Flat Adjustable Pitch

- Requires 69" unobstructed area from awning rail straight down
- Requires min. clearance of 2-1/2" between awning rail and top of entry door
- This hardware will roll the awning out flat to allow for clearance over slides and quick and easy pitch adjustment at either side of the awning

Standard Arm, Adjustable Pitch

- Requires 66-1/8" unobstructed area from awning rail straight down
- Requires min. clearance of 11" between awning rail and top of entry door
- This hardware will roll the awning out at a pitch and allow quick and easy pitch adjustment at either side of the awning

XL Arm, Flat Adjustable Pitch

- Requires 78" unobstructed area from awning rail straight down
- Requires min. clearance of 4-1/2" between awning rail and top of entry door
- This hardware is configured to operate a 9'8" projection canopy; it will roll the awning out flat to allow for clearance over slides and quick and easy pitch adjustment at either side of the awning

Options

- Wide selection of vinyl and woven acrylic fabrics available with aluminum Solera Shield®
- Optional Solera Power Pack perfect for DIY installs — eliminates wiring to RV
- Choose the XL 9'8" projection canopy — perfect shade for tall motorhomes and fifth-wheel RVs
- Choose from 8 premium hardware colors to match your RV graphics (pg. 16)

SOLERA XL POWER AND XL HYBRID AWNINGS

SOLERA XL POWER AND XL HYBRID AWNINGS



The Solera XL Awning features a 9-foot-8-inch projection making it perfect for taller RVs and RVs with a slide-out under the awning. Class A motorhome, fifth-wheel and toy hauler RVs keep getting taller and taller, so it can be hard to get the shade you need from an 8-foot awning. Not only that, but many brands now feature slide-outs under the awning, which can really limit your shaded patio area. Choose an XL Power or Hybrid Solera Awning to enjoy 20 percent more shade where you need it most!

XL Power Awning Arm Kit Includes:

- Two Arms
- Switch & Wiring Harness
- Fasteners

**Power Pack not available for Solera XL Awnings.*

XL Hybrid Awning Arm Kit Includes:

- Two Arms
- Crank rod
- Fasteners

**Power Pack not available for Solera XL Awnings.*



**20%
MORE SHADE**

XL **REGULAR**

SOLERA: **XL**

- Perfect for taller RVs with slide-outs under the awning
-

Enjoy 20% more shade than a standard 8' projection awning

SOLERA HYBRID

*NOTE: All awnings available from 10' to 21'
widths in 1' increments*



SOLERA: **HYBRID** Sets Up & Stores Automatically as you Crank

The Solera Hybrid Awning is the next best thing to a power awning. Simple crank operation makes setting up camp fast and easy, and the Hybrid locks into place when retracted for safe travel. Skip the hassle and cost of wiring and enjoy an easy do-it-yourself upgrade from a manual awning. The top bracket fits right over the mounting holes from your old awning and the kit includes a label to cover mounting holes from the old bottom bracket. Choose from a wider range of sizes and fabric and hardware colors than any other RV awning brand under the sun.



- Deploys and retracts just like a Power Awning, except you supply the power – the awning opens, raises itself into camping position and lowers for secure travel as you crank

- Enjoy full or partial extension

Additional Features

- Auto rain dump feature – if water pools in the canopy, the arms will release it
- Exclusive, quick and simple independent pitch adjustment
- Designed to provide optimum pitch when used over slide-outs

Solera® Hybrid Hardware

Short Arm, Fixed Pitch

- Requires 60-1/2" unobstructed area from awning rail straight down
- Requires min. clearance of 13-1/2" between awning rail and top of entry door
- This hardware will roll the awning out to a pre-set pitch for maximum shade and ideal rain runoff

Standard Arm, Adjustable Pitch

- Requires 66-1/8" unobstructed area from awning rail straight down
- Requires min. clearance of 11" between awning rail and top of entry door
- This hardware will roll the awning out at a pitch and allow quick and easy pitch adjustment at either side of the awning

Tall Arm, Flat Adjustable Pitch

- Requires 69" unobstructed area from awning rail straight down
- Requires min. clearance of 2-1/2" between awning rail and top of entry door
- This hardware will roll the awning out flat to allow for clearance over slides and quick and easy pitch adjustment at either side of the awning

XL Arm, Flat Adjustable Pitch

- Requires 78" unobstructed area from awning rail straight down
- Requires min. clearance of 4-1/2" between awning rail and top of entry door
- This hardware is configured to operate a 9'8" extension canopy; it will roll the awning out flat to allow for clearance over slides and quick and easy pitch adjustment at either side of the awning

Options

- Wide selection of vinyl and woven acrylic fabrics available with aluminum Solera Shield®
- Choose the XL 9'8" projection canopy – perfect shade for tall motorhomes and fifth-wheel RVs
- Choose from 8 premium hardware colors to match your RV graphics (pg. 16)

SOLERA CLASSIC



SOLERA: **CLASSIC** Traditional Manual Spring Roll Up

The rugged spring-loaded Solera Classic extends and retracts in just a few easy steps. Simply release the travel locks on each arm, loosen the rafter knobs, use the pull cane to unlock the roller, then hook the pull strap and walk it out to unroll the awning. Once extended, set the tension, tighten rafter knobs and raise the awning arms to whatever pitch you want for shade and water runoff. You can also detach the arms from the bottom bracket and rotate them to a vertical “carport” position. This carport position makes it easy to attach accessories like the Solera Screen Room and Solera Family Room™.



- Great value for replacing any brand spring-loaded manual awning

Additional Features

- Arms detach from bottom bracket and easily swing to “carport” position
- Brackets fit right over the mounting holes from your old awning

Solera® Classic Hardware

Short Arm

- Requires 60-1/2" unobstructed area from awning rail straight down

Standard Arm

- Requires 66-1/8" unobstructed area from awning rail straight down

Classic Long Arm

- Requires 69" unobstructed area from awning rail straight down

Options & Accessories

- Wide selection of vinyl and woven acrylic fabrics available with aluminum Solera Shield®
- Choose the Solera Awmbrella™ for extra canopy support and better angle for water runoff (pg. 25)
- Add Solera shades for extra shade, privacy and wind block (pg. 27)
- Choose from 8 premium hardware colors to match your RV graphics (pg. 16)

SOLERA DESTINATION



**DON'T JUST
REPLACE.
EXPAND
YOUR
OUTDOOR
LIVING
AREA BY
20%
with the
SOLERA
DESTINATION
9'8" projection
canopy!**



SOLERA: DESTINATION **Big Carport-Sized Shade & Shelter**

Destination campers (or seasonal campers) who set up camp for extended stays will love the Solera Destination Awning because it provides an additional 20 percent more shaded outdoor area. Not only does the Solera Destination Awning provide a 9-foot-8-inch projection canopy, it also comes with a center ground support, a Solera Shield to protect the vinyl canopy and a Solera Awnbrella™ to keep the fabric arched and taut to minimize wind flap and enable rain runoff.

SOLERA DESTINATION



- Operates like any manual spring roll up awning — basically it's a jumbo Solera Classic Awning
- Large 9'8" projection canopy features the aluminum Solera Shield® and the Solera Awnbrella™ (pg. 25)

Solera® Destination Hardware

9'8" Projection Roller Assembly

- Requires 78" unobstructed area from awning rail straight down
- This hardware is configured to operate a 9'8" projection canopy

Options

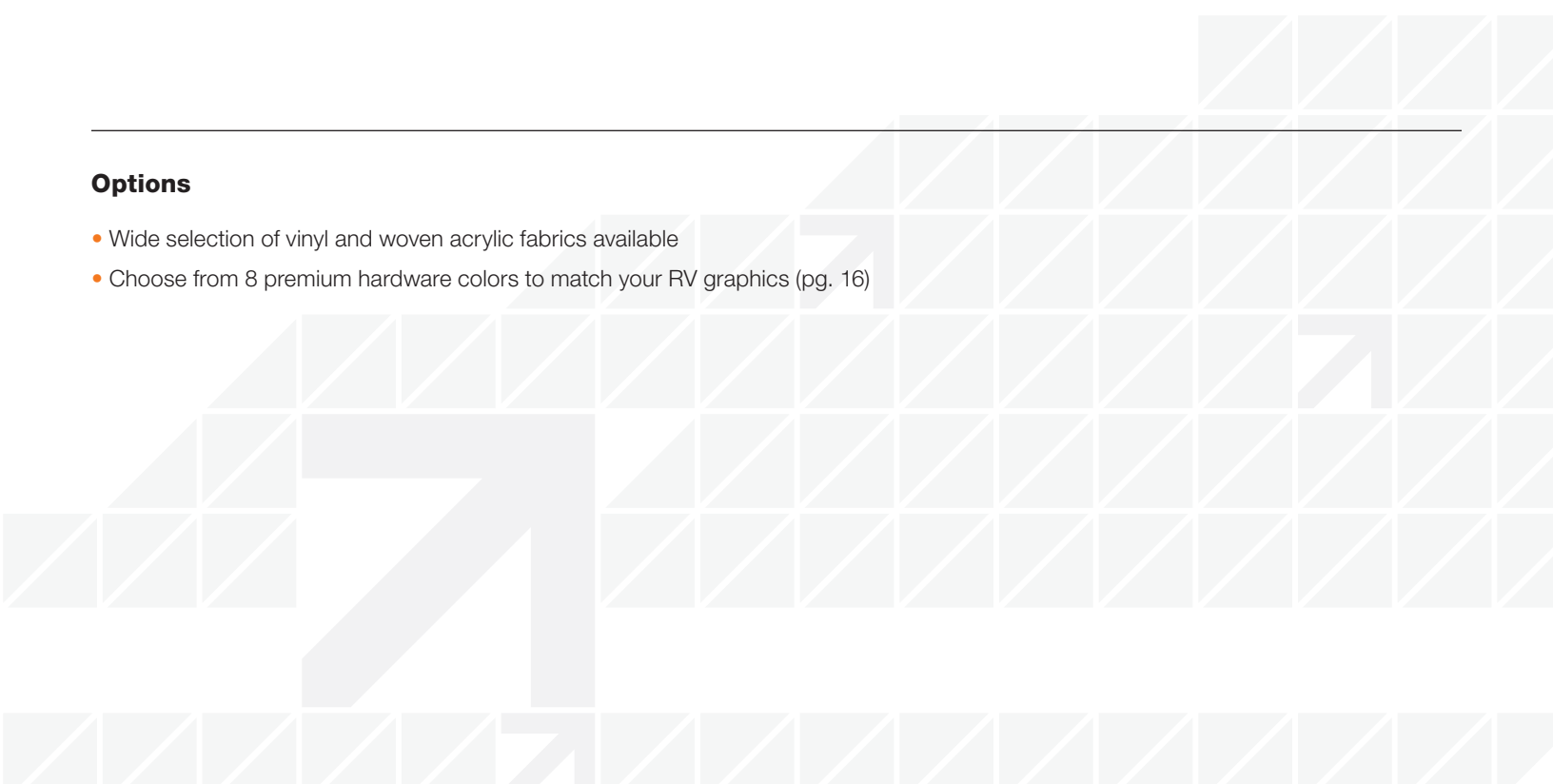
- Wide selection of vinyl and woven acrylic fabrics available
 - Choose from 8 premium hardware colors to match your RV graphics (pg. 16)
- 

WINDOW AWNINGS

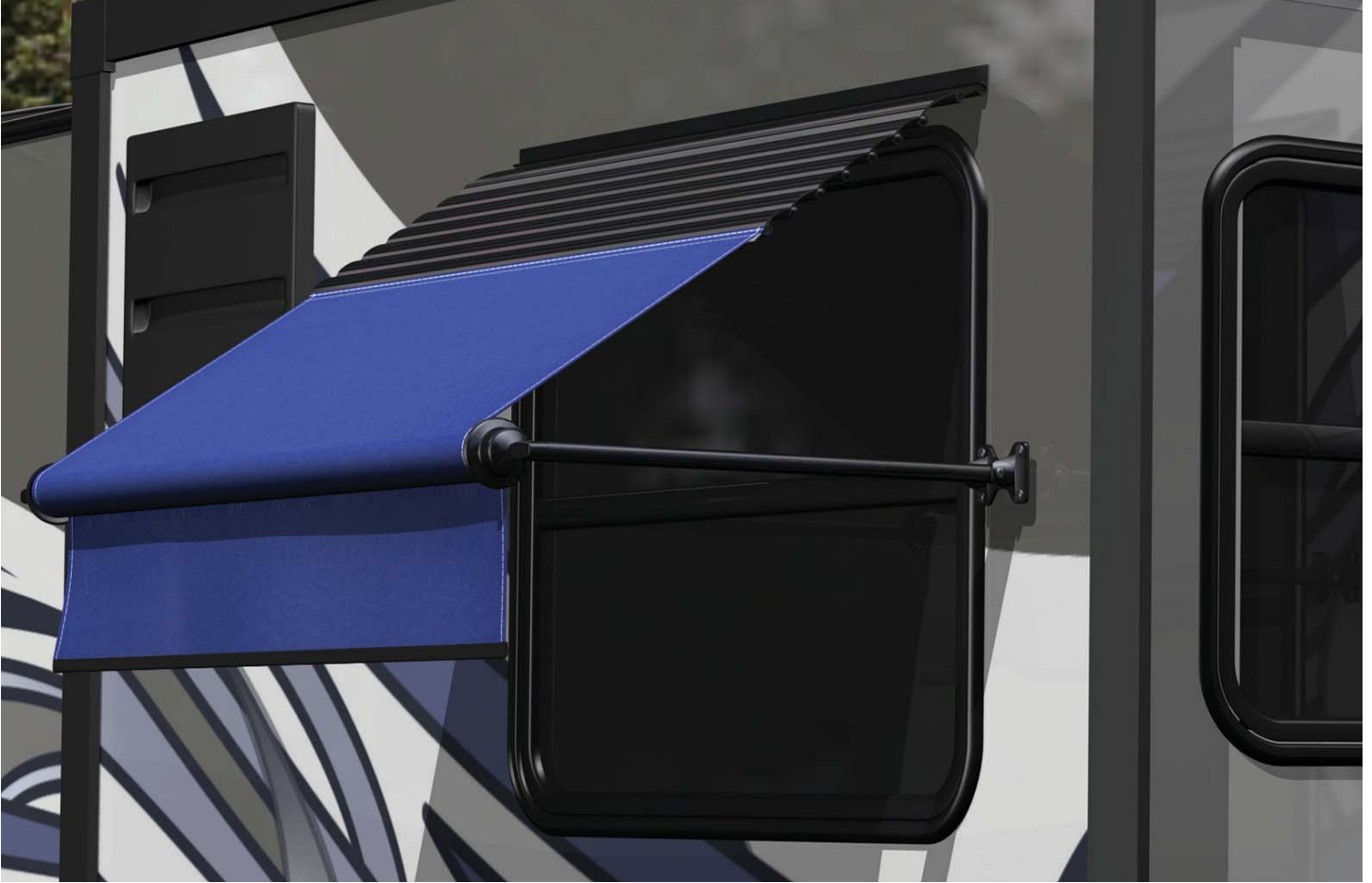

Keep the heat out and save on AC with Solera Window Awnings. Just use the pull cane to hook the pull strap and pull it to extend the awning. Secure the strap loop onto a hook on the RV wall to keep the awning extended. Go for the best value and the best look and cover two windows with one window awning.

Solera window awnings are available in standard arm and canopy sizes for windows that are under 33 inches in height, and in XL sizes for windows over 33 inches. Standard window awning arms are 18 inches long so they'll have an 18-inch projection, and XL window awning arms are 30 inches long so they'll have a 30-inch projection. Order arms and roller separately.



Give your slide-outs extra protection from debris and water infiltration with Solera Sliders. These attractive and economical slide-out awnings automatically retract and extend with your slide-out and block leaves, bird droppings, branches and more from damaging slide-out seals.

- Attractive and economical protection for your slide-out
- Full coverage over the slide-out roof and the RV sidewall slide-out opening
- Blocks leaves, bird droppings, branches and debris
- Automatically retracts and extends with slide-out
- Fits slides ranging from 66" to 192" long and extending up to 42"
- Comes complete with awning rail and all mounting brackets
- Choose from multiple vinyl & acrylic fabric colors
- Available with the Solera Shield



HARDWARE & FABRIC

Standard Color Options



Custom Color Options



Painted hardware comes standard with black bracketry

Vinyl Fabric

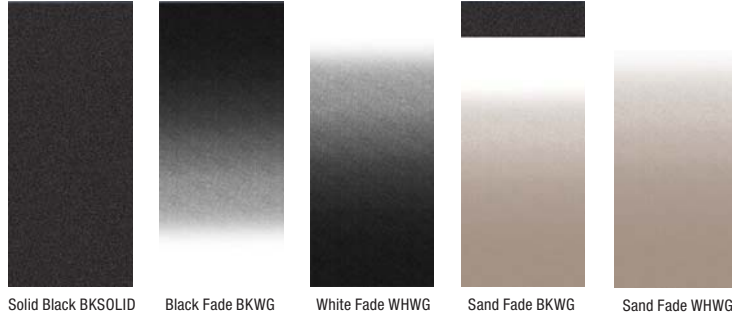

Solid Black BKSOLID Black Fade BKWG White Fade WHWG Sand Fade BKWG Sand Fade WHWG

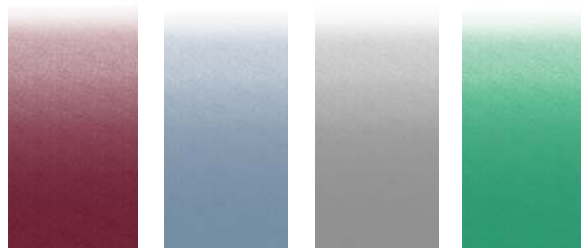

Burgundy Fade WHWG Blue Fade WHWG Silver Fade WHWG Green Fade WHWG

Vinyl Fabric with Solera Shield

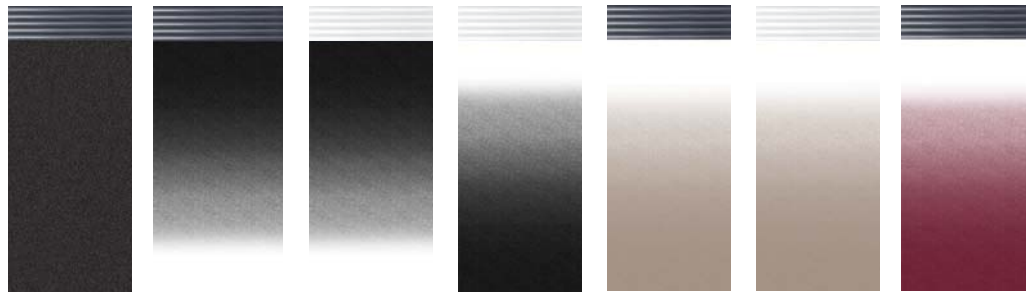

Solid Black BKS Black Fade BKS Black Fade WHS White Fade WHS Sand Fade BKS Sand Fade WHS Burgundy Fade BKS

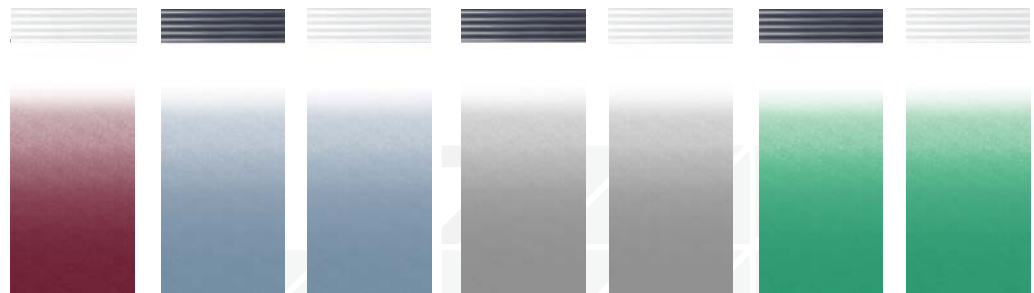

Burgundy Fade WHS Blue Fade BKS Burgundy Fade WHS Silver Fade BKS Silver Fade WHS Green Fade BKS Green Fade WHS



Sunbrella® is a registered trademark of Glen Raven, Inc.

All Solera Awning canopies feature an integrated track that works with the flexible Solera Fabric Light Kit (pg. 26). The Light Kit slides into the integrated track by the coach side wall and under the awning so you can enjoy light outside the RV when the awning is extended or retracted!

Acrylic Fabric with Solera Shield



Black Cherry



Charcoal Tweed



Hemlock Tweed



Linen Tweed



Mediterranean
Blue Tweed



Sunbrella® is a registered trademark of Glen Raven, Inc.

NOTE: All acrylic fabric features the Solera Shield

Special Order Canopy Options:*

- Vinyl fabric with Solera Shield
- Woven acrylic fabric with Solera Shield

*See dealer for part #.

All Solera Awning canopies feature an integrated track that works with the flexible Solera Fabric Light Kit (pg. 26). The Light Kit slides into the integrated track by the coach side wall and under the awning so you can enjoy light outside the RV when the awning is extended or retracted!



Solera Shield

The built-in Solera Shield provides elegant and practical protection for your Solera vinyl or acrylic awning canopy. As the awning retracts, the aluminum Solera Shield automatically rolls up around the fabric to protect it against the elements during travel. Be sure to order your Solera Shield to match your hardware.

ORDERING

SOLERA: POWER HARDWARE

Arm Type	Arm Size	Standard Head/ White Hardware	Speaker Head/ White Hardware	Standard Head/ Black Hardware	Speaker Head/ Black Hardware
Short Arm, Fixed Pitch	60-1/2"	388073	388075	388074	388076
Standard Arm, Adjustable Pitch	66-1/8"	351393	351394	351392	351395
Tall Arm, Flat Adjustable Pitch	69"	309221	351397	309223	351396
XL Arm, Adjustable Pitch*	78"	362241	362242	362243	362244

Power Awning Kit Includes

- Two Arms
- Switch & Wiring Harness
- Fasteners

*Power Pack not available for Solera XL Awnings.

SOLERA: HYBRID HARDWARE

Arm Type	Arm Size	Plain Head/ White Hardware	Plain Head/ Black Hardware
Short Arm, Fixed Pitch	60-1/2"	388419	388420
Standard Arm, Adjustable Pitch	66-1/8"	351826	351825
Tall Arm, Flat Adjustable Pitch	69"	351828	351827
XL Arm, Adjustable Pitch*	78"	V000335590	V000335589

Hybrid Awning Arm Kit Includes:

- Two arms
- Crank rod
- Fasteners

*NOTE: Solera XL arms require XL roller assemblies

SOLERA: POWER & HYBRID VINYL FABRIC & ROLLER ASSEMBLIES

Standard 8' Projection

Width	Black Fade BKWG	White Fade WHWG	Sand Fade BKWG	Sand Fade WHWG	Solid Black BKSOLID	Burgundy Fade WHWG	Blue Fade WHWG	Silver Fade WHWG	Green Fade WHWG
10'	V000211446	V000211450	V000231492	V000231508	V000211447	V000286883	V000286908	V000307065	V000344965
11'	V000211452	V000213035	V000223158	V000223153	V000256341	V000286885	V000286909	V000342917	V000344966
12'	V000211455	V000211457	V000223159	V000223177	V000231439	V000286886	V000286910	V000342918	V000344969
13'	V000211459	V000211462	V000223160	V000223178	V000211460	V000286887	V000286911	V000342919	V000344970
14'	V000211466	V000211475	V000223161	V000223179	V000211468	V000286888	V000286912	V000324187	V000344971
15'	V000211480	V000211483	V000223162	V000223185	V000231442	V000286889	V000286914	V000312456	V000344972
16'	V000211486	V000211492	V000223163	V000223189	V000211487	V000286890	V000286915	V000342920	V000344973
17'	V000211498	V000211502	V000223165	V000223190	V000231446	V000286891	V000286916	V000342921	V000344974
18'	V000211505	V000211510	V000223170	V000223191	V000211506	V000286892	V000286920	V000342922	V000344975
19'	V000211512	V000211514	V000231497	V000231519	V000211513	V000286893	V000286921	V000342924	V000344976
20'	V000211517	V000211523	V000231498	V000231520	V000211518	V000286894	V000286922	V000342925	V000344977
21'	V000211531	V000254845	V000255587	V000266033	V000211532	V000286895	V000286924	V000324185	V000344978

*The color of the exposed vinyl in the rolled up position is noted as BKWG meaning black; or WHWG, meaning white

SOLERA: XL POWER & XL HYBRID VINYL FABRIC & ROLLER ASSEMBLIES

Width	Black Fade BKWG	White Fade WHWG	Sand Fade BKWG	Sand Fade WHWG	Solid Black BKSOLID	Burgundy Fade WHWG	Blue Fade WHWG	Silver Fade WHWG	Green Fade WHWG
10'	V000334742	V000334743	V000334745	V000334744	V000334746	V000334747	V000334748	V000334749	V000344979
11'	V000334909	V000334911	V000334912	V000334913	V000334914	V000334915	V000334916	V000334917	V000344980
12'	V000334918	V000334919	V000334920	V000334921	V000334922	V000334923	V000334924	V000334925	V000344981
13'	V000334926	V000334927	V000334928	V000334934	V000334937	V000334938	V000334939	V000334940	V000344982
14'	V000334941	V000334942	V000334944	V000334945	V000334946	V000334947	V000334948	V000334949	V000344983
15'	V000334950	V000334951	V000334952	V000334953	V000334954	V000334955	V000334956	V000334957	V000344984
16'	V000334959	V000334965	V000334970	V000334976	V000334979	V000334983	V000334987	V000334992	V000344985
17'	V000334961	V000334998	V000334999	V000335001	V000335005	V000335009	V000335014	V000335020	V000344986
18'	V000334963	V000335000	V000335029	V000335031	V000335034	V000335037	V000335039	V000335041	V000344987
19'	V000334966	V000335007	V000335043	V000335044	V000335046	V000335048	V000335050	V000335052	V000344988
20'	V000334969	V000335011	V000335055	V000335059	V000335062	V000335066	V000335071	V000335074	V000344989
21'	V000334972	V000335015	V000335067	V000335089	V000335092	V000335093	V000335094	V000335095	V000344990

SOLERA: CLASSIC HARDWARE

Arm Type	Arm Range	White Hardware	Black Hardware	Satin Hardware
Short Arm	63" - 68"	V000334715	V000334958	V000335042
Standard Arm	68" - 81"	V000334716	V000335045	V000335047
Classic Long Arm	81" - 97"	V000334717	V000335059	V000335051

Classic Awning Arm Kit Includes:

- Two Arms
- Mounting Brackets
- Hardware
- Pull Cane

SOLERA: CLASSIC VINYL FABRIC & ROLLER ASSEMBLIES

Standard 8' Projection

Width	Black Fade BKWG	White Fade WHWG	Sand Fade BKWG	Sand Fade WHWG	Solid Black BKSOLID	Burgundy Fade WHWG	Blue Fade WHWG	Silver Fade WHWG	Green Fade WHWG
10'	V000343034	V000343000	V000343059	V000343048	V000343115	V000343071	V000343090	V000343101	V000344991
11'	V000343033	V000343001	V000343058	V000343047	V000343114	V000343070	V000343089	V000343100	V000344992
12'	V000343032	V000343002	V000343057	V000343046	V000343113	V000343069	V000343088	V000343099	V000344993
13'	V000343031	V000343003	V000343056	V000343045	V000343112	V000343068	V000343087	V000343098	V000344994
14'	V000343030	V000343004	V000343055	V000343044	V000343111	V000343067	V000343085	V000343097	V000344995
15'	V000343029	V000343005	V000343054	V000343043	V000343109	V000343065	V000343083	V000343096	V000344996
16'	V000343027	V000343006	V000343053	V000343042	V000343108	V000343064	V000343080	V000343095	V000344997
17'	V000343026	V000343007	V000343052	V000343038	V000343107	V000343063	V000343078	V000343094	V000344998
18'	V000343025	V000343008	V000343051	V000343037	V000343106	V000343062	V000343075	V000343093	V000344999
19'	V000343024	V000343009	V000343050	V000343036	V000343105	V000343061	V000343074	V000343092	V000345000
20'	V000343023	V000343010	V000343049	V000343035	V000343102	V000343060	V000343073	V000343091	V000345001
21'	V000343015	V000343011	V000343017	V000343016	V000343022	V000343018	V000343019	V000343020	V000345002

ORDERING

SOLERA: DESTINATION HARDWARE

White Hardware	Black Hardware	Satin Hardware	Custom Colors
V000334718	V000334719	V000334720	Special Order

SOLERA: DESTINATION VINYL FABRIC WITH SOLERA SHIELD & ROLLER ASSEMBLIES

NEW 9'8" Projection

Width	Black Fade, BKS	Black Fade, WHS	White Fade, WHS	White Fade, BKS	Sand Fade, BKS	Sand Fade, WHS	Black Solid, BKS
16'	V000334818	V000334867	V000334839	V000334843	V000334873	V000334870	V000334847
17'	V000335268	V000335279	V000335294	V000335302	V000335338	V000335329	V000335317
18'	V000335270	V000335281	V000335296	V000335310	V000335340	V000335331	V000335319
19'	V000335272	V000335287	V000335298	V000335324	V000335342	V000335332	V000335322
20'	V000335274	V000335289	V000335300	V000335326	V000335345	V000335334	V000335323
21'	V000335276	V000335292	V000335301	V000335327	V000335348	V000335336	V000335325

Width	Burgundy Fade, WHS	Burgundy Fade, BKS	Blue Fade, WHS	Blue Fade, BKS	Silver Fade, BKS	Silver Fade, WHS	Green Fade, WHS	Green Fade, BKS
16'	V000334857	V000334859	V000334861	V000334865	V000334864	V000334862	V000345003	V000345009
17'	V000335370	V000335337	V000335389	V000335397	V000335350	V000335364	V000345004	V000345010
18'	V000335378	V000335343	V000335393	V000335401	V000335352	V000335368	V000345005	V000345011
19'	V000335383	V000335347	V000335396	V000335408	V000335354	V000335372	V000345006	V000345012
20'	V000335386	V000335361	V000335404	V000335414	V000335356	V000335375	V000345007	V000345013
21'	V000335390	V000335366	V000335410	V000335423	V000335358	V000335380	V000345008	V000345014

The color of the Solera Shield is noted as BKS meaning black; or WHS, meaning white



WINDOW AWNING HARDWARE

Height	White Hardware	Black Hardware	Satin Hardware	Custom Paint
Standard (Under 33")	V000334754	V000334750	V000334753	Special Order
XL (Over 33")	V000334759	V000334764	V000334765	Special Order

WINDOW AWNING VINYL FABRIC & ROLLER ASSEMBLIES

Standard 18" Projection

Width	Black Fade BKWG	White Fade WHWG	Sand Fade BKWG	Sand Fade WHWG	Burgundy Fade WHWG	Blue Fade WHWG	Solid Black BKWG	Silver Fade WHWG	Green Fade WHWG
36"	V000334776	V000334778	V000334824	V000334779	V000334800	V000334802	V000334804	V000334806	V000345015
42"	V000334962	V000335002	V000335040	V000335087	V000335153	V000335351	V000335426	V000335469	V000345016
48"	V000334964	V000335004	V000335056	V000335088	V000335154	V000335355	V000335427	V000335472	V000345019
54"	V000334967	V000335006	V000335057	V000335090	V000335155	V000335359	V000335428	V000335474	V000345020
60"	V000334968	V000335008	V000335058	V000335091	V000335156	V000335362	V000335429	V000335475	V000345021
66"	V000334971	V000335010	V000335060	V000335105	V000335158	V000335367	V000335430	V000335476	V000345022
72"	V000334973	V000335012	V000335061	V000335106	V000335159	V000335371	V000335432	V000335477	V000345023
78"	V000334974	V000335013	V000335063	V000335107	V000335160	V000335377	V000335434	V000335478	V000345024
84"	V000334975	V000335016	V000335064	V000335108	V000335162	V000335381	V000335436	V000335480	V000345025
90"	V000334977	V000335017	V000335065	V000335109	V000335164	V000335384	V000335438	V000335481	V000345026
96"	V000334978	V000335019	V000335068	V000335110	V000335165	V000335388	V000335440	V000335482	V000345027
102"	V000334980	V000335021	V000335069	V000335116	V000335167	V000335392	V000335445	V000335483	V000345028
108"	V000334981	V000335022	V000335070	V000335117	V000335169	V000335394	V000335447	V000335484	V000345029
114"	V000334982	V000335023	V000335072	V000335119	V000335171	V000335398	V000335448	V000335485	V000345030
120"	V000334984	V000335024	V000335073	V000335121	V000335172	V000335400	V000335450	V000335486	V000345031
126"	V000334985	V000335025	V000335075	V000335123	V000335173	V000335403	V000335453	V000335487	V000345032
132"	V000334986	V000335026	V000335078	V000335124	V000335175	V000335405	V000335454	V000335488	V000345033
138"	V000334989	V000335027	V000335079	V000335125	V000335177	V000335407	V000335456	V000335489	V000345034
144"	V000334990	V000335028	V000335080	V000335126	V000335179	V000335411	V000335458	V000335490	V000345035
150"	V000334991	V000335030	V000335081	V000335128	V000335181	V000335413	V000335460	V000335491	V000345062
156"	V000334993	V000335032	V000335082	V000335130	V000335183	V000335416	V000335462	V000335492	V000345063
162"	V000334994	V000335033	V000335083	V000335131	V000335184	V000335418	V000335463	V000335493	V000345064
168"	V000334995	V000335035	V000335084	V000335132	V000335186	V000335420	V000335466	V000335494	V000345065
174"	V000334996	V000335036	V000335085	V000335133	V000335188	V000335422	V000335467	V000335495	V000345066
180"	V000334997	V000335038	V000335086	V000335135	V000335189	V000335424	V000335468	V000335496	V000345067

ORDERING

WINDOW AWNING VINYL FABRIC & ROLLER ASSEMBLIES

XL 30" Projection

Width	Black Fade BKWG	White Fade WHWG	Sand Fade BKWG	Sand Fade WHWG	Burgundy Fade WHWG	Blue Fade WHWG	Solid Black BKWG	Silver Fade WHWG	Green Fade WHWG
36"	V000335254	V000334808	V000334825	V000334811	V000334812	V000334813	V000334814	V000334807	V000345068
42"	V000335262	V000335253	V000335357	V000335255	V000335111	V000335150	V000335199	V000335176	V000345069
48"	V000335265	V000335263	V000335360	V000335256	V000335112	V000335151	V000335200	V000335228	V000345070
54"	V000335266	V000335306	V000335363	V000335257	V000335113	V000335152	V000335201	V000335229	V000345071
60"	V000335267	V000335308	V000335365	V000335258	V000335114	V000335157	V000335202	V000335230	V000345072
66"	V000335269	V000335309	V000335369	V000335259	V000335115	V000335161	V000335203	V000335231	V000345073
72"	V000335271	V000335311	V000335373	V000335260	V000335118	V000335163	V000335204	V000335234	V000345074
78"	V000335273	V000335312	V000335374	V000335261	V000335120	V000335166	V000335209	V000335235	V000345075
84"	V000335275	V000335313	V000335376	V000335431	V000335122	V000335168	V000335210	V000335236	V000345076
90"	V000335277	V000335314	V000335379	V000335433	V000335127	V000335170	V000335211	V000335237	V000345077
96"	V000335278	V000335315	V000335382	V000335435	V000335129	V000335174	V000335212	V000335238	V000345078
102"	V000335280	V000335316	V000335385	V000335437	V000335134	V000335178	V000335213	V000335239	V000345079
108"	V000335282	V000335318	V000335387	V000335439	V000335136	V000335180	V000335214	V000335240	V000345080
114"	V000335283	V000335320	V000335391	V000335441	V000335137	V000335182	V000335215	V000335241	V000345081
120"	V000335284	V000335321	V000335395	V000335442	V000335139	V000335185	V000335216	V000335242	V000345082
126"	V000335285	V000335328	V000335399	V000335444	V000335140	V000335187	V000335217	V000335243	V000345083
132"	V000335286	V000335330	V000335402	V000335446	V000335141	V000335190	V000335218	V000335244	V000345084
138"	V000335288	V000335333	V000335406	V000335449	V000335142	V000335191	V000335219	V000335245	V000345085
144"	V000335290	V000335335	V000335409	V000335452	V000335143	V000335192	V000335220	V000335246	V000345086
150"	V000335291	V000335339	V000335412	V000335455	V000335144	V000335193	V000335222	V000335247	V000345087
156"	V000335293	V000335341	V000335415	V000335457	V000335145	V000335194	V000335223	V000335248	V000345088
162"	V000335295	V000335344	V000335417	V000335459	V000335146	V000335195	V000335224	V000335249	V000345089
168"	V000335297	V000335346	V000335419	V000335461	V000335147	V000335196	V000335225	V000335250	V000345090
174"	V000335299	V000335349	V000335421	V000335464	V000335148	V000335197	V000335226	V000335251	V000345091
180"	V000335264	V000335353	V000335425	V000335465	V000335149	V000335198	V000335227	V000335252	V000345092

*The color of the exposed vinyl in the rolled up position is noted as BKWG meaning black; or WHWG, meaning white



SOLERA SLIDERS VINYL FABRIC & ROLLER ASSEMBLIES

Flange Measurement	Fabric Size	Black Vinyl & Hardware	Black Vinyl & Hardware
5'6" (66")	61" to 66"	V000168104	V000163273
6' (72")	67" to 72"	V000231482	V000163274
6'6" (78")	73" to 78"	V000165063	V000163279
7' (84")	79" to 84"	V000168105	V000163285
7'6" (90")	85" to 90"	V000165062	V000163287
8' (96")	91" to 96"	V000168106	V000163288
8'6" (102")	97" to 102"	V000168107	V000163289
9' (108")	103" to 108"	V000168108	V000163290
9'6" (114")	109" to 114"	V000168325	V000163291
10' (120")	115" to 120"	V000251461	V000163292
10'6" (126")	121" to 126"	V000182037	V000163293
11' (132")	127" to 132"	V000168326	V000163294
11'6" (138")	133" to 138"	V000184673	V000163295
12' (144")	139" to 144"	V000168328	V000139496
12'6" (150")	145" to 150"	V000177334	V000163298
13' (156")	151" to 156"	V000165061	V000163299
13'6" (162")	157" to 162"	V000168109	V000163300
14' (168")	163" to 168"	V000168110	V000163301
14'6" (174")	169" to 174"	V000168112	V000163302
15' (180")	175" to 180"	V000251477	V000163303
15'6" (186")	181" to 186"	V000251478	V000163304
16' (192")	187" to 192"	V000194925	V000163307

To order the correct Solera Slider, select the size that extends a minimum of 2-1/2" beyond each side of your box width. Solera Sliders come with all the hardware needed for installation.



➤ AWNING ACCESSORIES



AWNING ACCESSORIES



Solera® Power Pack

Want to upgrade to a Power Awning without having to wire into your 12V RV system? The Solera Power Pack is a unique rechargeable battery that fits right inside your Solera Power Awning arm and comes with everything you need to connect to the motor wire. Perfect for DIY installers who don't want to go through the hassle of wiring into the 12V RV system.



Solera Awnbrella™

Give your awning extra support and better angle for water runoff with the Solera Awnbrella. Perfect for destination campers who like to leave the awning extended for long periods, the patented rust-resistant aluminum bows hold fabric taut and arched so water doesn't pool and debris can easily run off. Now you won't have to camp with one end of your awning pitched lower than the other end. The Solera Awnbrella also complements the Solera Screen Room and Solera Family Room™.

**NOTE: The Awnbrella may leave minor stretch marks on the awning fabric, depending on use. Fabric in worn condition should be replaced before using the Awnbrella.*

- Provides ample extend and retract power
- Comes with 110V charging kit
- Easy DIY installation
- Straightforward alternative to wiring into the RV power source

Part No.	Description	Dimensions	Awning Width	Number of Awnbrella Arms
362237	Awnbrella for 8' extension awning, 3 pack	Extends 59" – 106"		
362238	Awnbrella for 8' extension awning, 2 pack	Extends 59" – 106"	10'-14'	2 arms
362239	Awnbrella for 9'-8" extension awning, 3 pack	Extends 79" – 120"	14'-18'	3 arms
362240	Awnbrella for 9'-8" extension awning, 2 pack	Extends 79" – 120"	18'-22'	4 arms
			22'-27'	5 arms

	Standard Pitch 66-1/8" arm size	Flat Pitch 69" arm size
Plain Head, White	V000334711	V000334714
Plain Head, Black	V000334712	V000334713

**NOTE: Power Pack not available for XL Awnings.*

AWNING ACCESSORIES

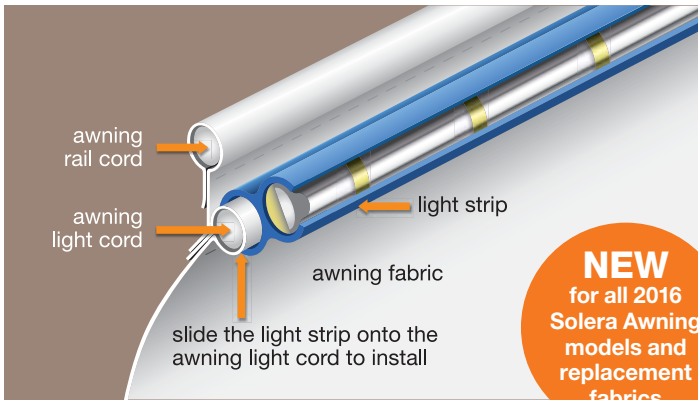

Solera Fabric Light Kit

All 2016 Solera Awning models and replacement fabrics feature a NEW integrated light rail sewn right into the awning hem! The flexible Solera Fabric Light Kit slides into the track by the coach side wall and under the awning. The innovative design allows you to enjoy dramatic lighting outside the RV when the awning is extended or retracted!

Length	Part No.	Color
15'	387593	Black Plastic
21'	387594	Black Plastic



Awning Ground Support

Stabilize your awning and prevent the roller from sagging with the Awning Ground support

- Fits all awning brands
- Adjustable leg extension
- Stake the Awning Ground Support to the ground for best results

Part No.	Color
362246	White Ground Support
362247	Black Ground Support



Awning Wall Light Kits

Light up your outdoor patio space with a Solera Awning Wall Light Kit. LED lights come in an easy-to-install extruded plastic rail and operate on minimal batter power. Enjoy optimum lighting as the LED lights reflect off the RV sidewall and the bottom of the canopy.

Length	Part No.	Color
15'	329825	White Plastic
15'	329826	Black Plastic
21'	329887	White Plastic
21'	329888	Black Plastic



Awning Cradle Support

The Awning Cradle Support works with power or manual awnings to support the roller assembly when in the travel position; the Awning Cradle Support automatically accepts and releases the roller assembly as it extends and retracts.

Part No.	Description
289373	White
289374	Black

AWNING ACCESSORIES

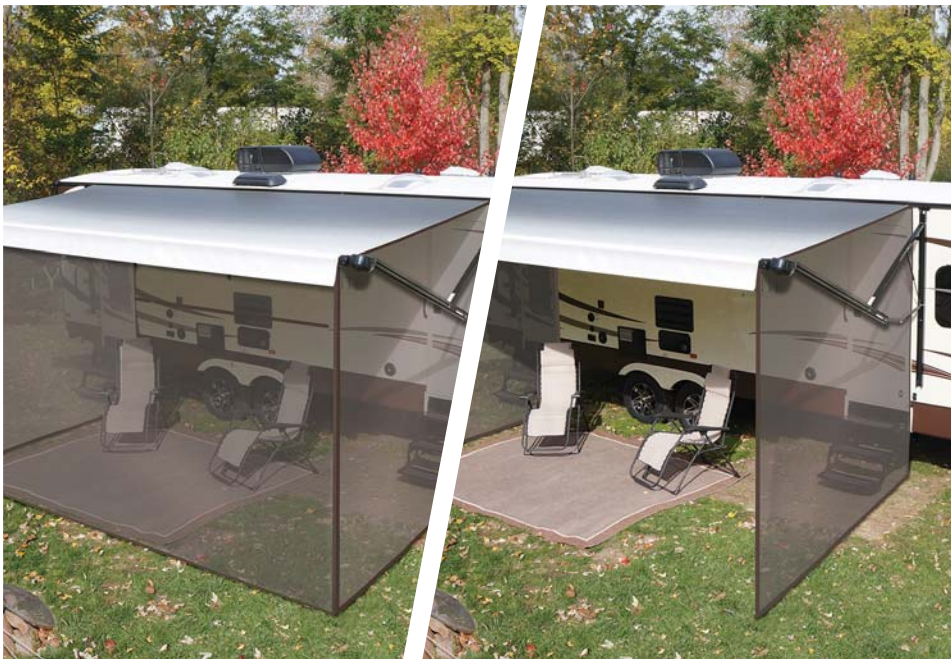

Solera® Classic Front and Side Shades

Perfect for all awnings, the one-piece Solera Classic Shade is easy to slide into your awning roller tube whenever you need a little extra shade, privacy or wind block. Solera Classic Front and Side Shades drop 6 feet and include spikes and tie downs so you can secure it to the ground. The whole kit stores neatly in the included storage bag when not in use. Front and side shades sold separately.

Classic Shade

Width	Part No.
8'	3833980608
10'	3833980610
13'	3833980613
15'	3833980615
17'	3833980617
19'	3833980619

Available in black plastic only.



Solera Super Shade™

If you have a Class A motorhome, fifth-wheel or toy hauler RV with a tall awning rail, the two-piece Solera Super Shade is perfect for you! The shorter piece easily slides into your awning roller tube and can stay there throughout the camping season and even rolls up with the awning. When you need extra shade, privacy or wind block, simply zip on the longer 6-foot tall piece.

The length of the shorter top portion varies based on the drop (measure from roller tube to ground) so that the shorter portion always hangs within reach. The longer piece always measures 6-feet tall so you can reach to zip it into the shorter portion.

NOTE: Super Shade is available for standard 8' patio awnings only; not compatible with Solera XL awnings.

Super Shade

Width	6' drop	7' drop	8' drop	9' drop	10' drop
10'	3797820610	3797820710	3797820810	3797820910	37978201010
13'	3797820613	3797820713	3797820813	3797820913	37978201013
15'	3797820615	3797820715	3797820815	3797820915	37978201015
17'	3797820617	3797820717	3797820817	3797820917	37978201017
19'	3797820619	3797820719	3797820819	3797820919	37978201019

Solera Shade Side Panels

	Part no.
6' Drop	37978606
7' Drop	37978607
8' Drop	37978608
9' Drop	37978609
10' Drop	37978610

Available in black plastic only.

AWNING ACCESSORIES



Solera® Family Room™

Turn the space under your awning into an enclosed outdoor patio with the Solera Family Room kit. Add up to 160 square feet of enclosed space so you can enjoy meals minus pesky insects. Or roll down the all-weather panels and use as a cozy sleeping area for kids.

- Lightweight gray fabric compliments any RV color scheme
- Fits most 10'–21' wide manual and power awnings
- Accommodates RVs with awning rail-to-ground measurement up to 130"
- Fits 8' projection Solera, Carefree and Dometic awnings
- Measure center of arm to center of arm to determine room size needed

Size	Part no.
10'	362225
11'	362226
12'	362227
13'	362228
14'	362229
15'	362230

Size	Part no.
16'	362231
17'	362232
18'	362233
19'	362234
20'	362235
21'	362236



Solera® Screen Room

Keep the bugs out and enjoy the breeze with the Solera screen room. Its neutral tan material helps to block out extra heat, making the Solera screen room perfect for outdoor dining, board games and social gatherings on hot summer days.

- Fits most 10'–21' wide manual and power awnings
- Accommodates RVs with awning rail-to-ground measurement up to 130"
- Fits 8' extension Solera, Carefree and Dometic awnings
- Measure center of arm to center of arm to determine room size needed

Size	Part No.	Size	Part No.
10'	362213	16'	362219
11'	362214	17'	362220
12'	362215	18'	362221
13'	362216	19'	362222
14'	362217	20'	362223
15'	362218	21'	362224

➤ REPLACEMENT FABRIC & PARTS



REPLACEMENT FABRICS

Replacement Fabrics

- For 10' – 21' wide Carefree, Dometic and Solera Patio Awnings with an 8' projection
- To determine the size of replacement fabric you need, measure your awning from the center of the back arm to the center of the front arm
- All Solera Replacement Fabrics feature a new integrated light rail that accommodates the Solera Fabric Light Kit (pg. 25)

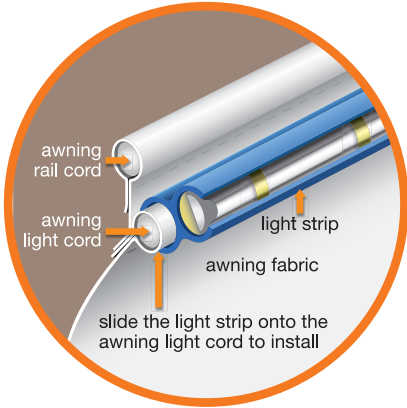

Fabric Options:

Vinyl Canopy

- Heavy-duty 13.5 ounce fabric
- Cold-crack tested to -25° F
- 8 color choices

Vinyl Canopy with Solera Shield

- Painted Solera Shield is available in black, white, satin and 8 custom colors

Woven Acrylic Canopy with Solera Shield

- Woven fabric is breathable, so the area under the canopy may stay cooler
- 5 color choices
- Mildew-resistant fabric
- Comes complete with Solera Shield available in black, white, satin and 8 custom colors



Sunbrella® is a registered trademark of Glen Raven, Inc.

Universal Replacement Fabrics For 8' Projection Vinyl Patio Awnings*

Width	Black Fade BKWG	White Fade WHWG	Sand Fade BKWG	Sand Fade WHWG	Solid Black BKWG	Burgundy Fade WHWG	Blue Fade WHWG	Silver Fade WHWG	Green Fade WHWG
10'	V000334336	V000334335	V000334337	V000334346	V000334338	V000334339	V000334340	V000334345	V000345093
11'	V000334341	V000334342	V000334343	V000334344	V000334347	V000334348	V000334351	V000334353	V000345094
12'	V000334355	V000334356	V000334357	V000334358	V000334359	V000334360	V000334361	V000334363	V000345095
13'	V000334364	V000334365	V000334366	V000334367	V000334368	V000334369	V000334370	V000334372	V000345096
14'	V000334373	V000334374	V000334375	V000334376	V000334377	V000334378	V000334379	V000334382	V000345097
15'	V000334383	V000334385	V000334387	V000334388	V000334389	V000334390	V000334391	V000334393	V000345098
16'	V000334394	V000334397	V000334398	V000334399	V000334400	V000334401	V000334402	V000334404	V000345099
17'	V000334405	V000334406	V000334407	V000334408	V000334409	V000334410	V000334411	V000334413	V000345101
18'	V000334415	V000334416	V000334417	V000334418	V000334419	V000334420	V000334421	V000334423	V000345102
19'	V000334424	V000334426	V000334428	V000334429	V000334430	V000334431	V000334432	V000334434	V000345103
20'	V000334435	V000334436	V000334437	V000334438	V000334439	V000334440	V000334441	V000334443	V000345104
21'	V000334444	V000334445	V000334446	V000334447	V000334448	V000334449	V000334450	V000334452	V000345105

*The color of the exposed vinyl in the rolled up position is noted as BKWG meaning black; or WHWG, meaning white

SOLERA® POWER AWNING REPLACEMENT PARTS

Universal Power & Manual Awning Parts



61-1/2" Arm
295742 – White

66-1/8" Arm
260294 – White

69" Arm
281152 – White

61-1/2" Arm
295743 – Black

66-1/8" Arm
266169 – Black

69" Arm
281154 – Black



289557

289560

289563

289566

275071

289373

289374

289558

289561

289564

289567

Manual Awning Parts Only



300029

300031

266147

273479

351831

351832

299993

272067

271181

272397

285147

292794

300030

334391

SOLERA® AWNING REPLACEMENT PARTS

Power Awning Parts



266149

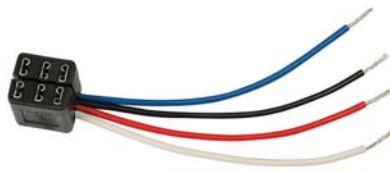

280570



285077



266146



273478



266147



273479



285079



354181



354185



354186



354189



285499



300005



300009



300007



300011



285500



342147



342149



342148



342150

SOLERA® POWER AWNING REPLACEMENT PARTS

Universal Power & Manual Awning Parts

part no.	description
295742	61 ¹ / ₂ " Short Awning Support Arm Assembly, White
295743	61 ¹ / ₂ " Short Awning Support Arm Assembly, Black
260294	66 ¹ / ₈ " Pitched Awning Support Arm Assembly, White
266169	66 ¹ / ₈ " Pitched Awning Support Arm Assembly, Black
281152	69" Standard Flat Awning Support Arm Assembly, White
281154	69" Standard Flat Awning Support Arm Assembly, Black
280343	Gas Strut 26", 124 lb For Short And Flat Arms
260282	Gas Strut, 124-144 lb For Pitched Arms
289557	Awning Plain Drive Head Front Cover, White
289560	Awning Plain Drive Head Front Cover, Black
289558	Awning Plain Drive Head Back Cover, White
289561	Awning Plain Drive Head Back Cover, Black
289563	Awning Plain Idler Head Front Cover, White
289566	Awning Plain Idler Head Front Cover, Black
289564	Awning Plain Idler Head Back Cover, White
289567	Awning Plain Idler Head Back Cover, Black
289373	Awning Cradle Support, White
289374	Awning Cradle Support, Black
260560261	Rollbar Only For 12' Black Awning, Black Tube
260560333	Rollbar Only For 15' Black Awning, Black Tube
260560357	Rollbar Only For 16' Black Awning, Black Tube
260560405	Rollbar Only For 18' Black Awning, Black Tube
260560477	Rollbar Only For 21' Black Awning, Black Tube
338512261	Rollbar Only For 12' White Awning, Grey Tube
338512333	Rollbar Only For 15' White Awning, Grey Tube
338512357	Rollbar Only For 16' White Awning, Grey Tube
338512405	Rollbar Only For 18' White Awning, Grey Tube
338512477	Rollbar Only For 21' White Awning, Grey Tube
275071	Grommet, Diaphragm, .75 ID x 1 OD, Black, For Manual Over-Ride Hole

Manual Awning Parts Only

part no.	description
271181	Manual Pull Style Awning Drive Head Assembly, White
272067	Manual Pull Style Awning Drive Head Assembly, Black
272397	Manual Pull Style Awning Idler Head Assembly, White
285147	Manual Pull Style Awning Idler Head Assembly, Black
292794	Manual Awning Pull Strap Replacement
334391	Manual Awning Pull Rod
300029	Manual Crank Style Awning Drive Head Assembly, White
300031	Manual Crank Style Awning Drive Head Assembly, Black
266147	Manual Crank Style Awning Idler Head Assembly, White
273479	Manual Crank Style Awning Idler Head Assembly, Black
300030	Manual Crank Style Awning Hook And Crank Rod, White
351831	Manual Crank Style Awning Drive Head Front Cover, White
351832	Manual Crank Style Awning Drive Head Front Cover, Black
333410	Pull Style Manual to Crank Style Manual Upgrade Kit, White
333411	Pull Style Manual to Crank Style Manual Upgrade Kit, Black
299993	Grommet Diaphragm, 1.625 ID X 1.929 OD, Black, For Manual Crank Hole

Power Awning Parts

part no.	description
266149	Power Awning Replacement Motor
266146	Power Awning Plain Drive Head Assembly, White
273478	Power Awning Plain Drive Head Assembly, Black
266147	Power Awning Plain Idler Head Assembly, White
273479	Power Awning Plain Idler Head Assembly, Black
342147	Power Awning Speaker Drive Head Assembly, White
342149	Power Awning Speaker Drive Head Assembly, Black
342148	Power Awning Speaker Idler Head Assembly, White
342150	Power Awning Speaker Idler Head Assembly, Black
354181	Power Awning Speaker Drive Head Front Cover, White
354185	Power Awning Speaker Drive Head Front Cover, Black
300005	Power Awning Speaker Drive Head Back Cover, White
300009	Power Awning Speaker Drive Head Back Cover, Black
354186	Power Awning Speaker Idler Head Front Cover, White
354189	Power Awning Speaker Idler Head Front Cover, Black
300007	Power Awning Speaker Idler Head Back Cover, White
300011	Power Awning Speaker Idler Head Back Cover, Black
285499	Power Awning Switch Kit, White
285500	Power Awning Switch Kit, Black
285079	Power Awning Bezel Spacer, White
285077	Power Awning Bezel Spacer, Black
280570	16 GA Power Awning Harness
329250	Manual Pull Style To Power Awning Conversion Kit, White
329251	Manual Pull Style To Power Awning Conversion Kit, Black
337727	Manual Crank Style To Power Awning Conversion Kit, White
337728	Manual Crank Style To Power Awning Conversion Kit, Black
351863	Plain Power Awning To Speaker Head Conversion Kit, White
351864	Plain Power Awning To Speaker Head Conversion Kit, Black

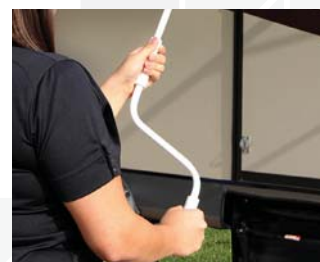

292794

SOLERA® POWER AWNING REPLACEMENT PARTS

Idler Head Assembly

266147 – White
273479 – Black

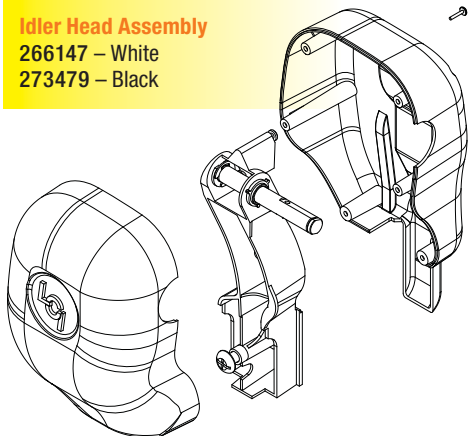

Back Cover

289564 – White
289567 – Black



Front Cover

289563 – White
289566 – Black

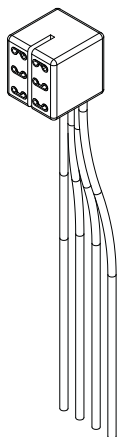

Switch Kits

285499 – White
285500 – Black

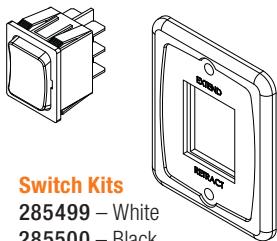

Drive Head Assembly

266146 – White
273478 – Black

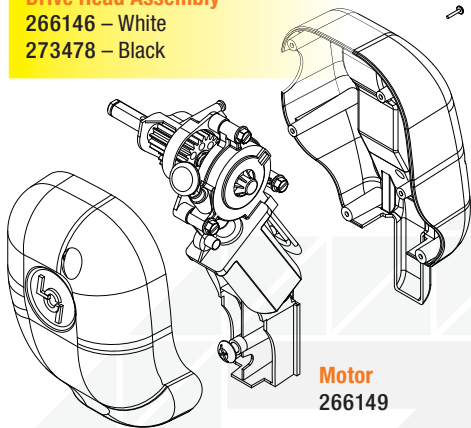

Back Cover

289558 – White
289561 – Black

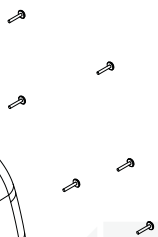

Motor
266149

Front Cover

289557 – White
289560 – Black

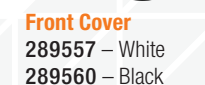

Arms

295742 – 61-1/2" White
295743 – 61-1/2" Black
260294 – 66-1/8" White
266169 – 66-1/8" Black
281152 – 69" White
281154 – 69" Black

Drive Side

Front of coach/right

Idler Side

Rear of coach/left

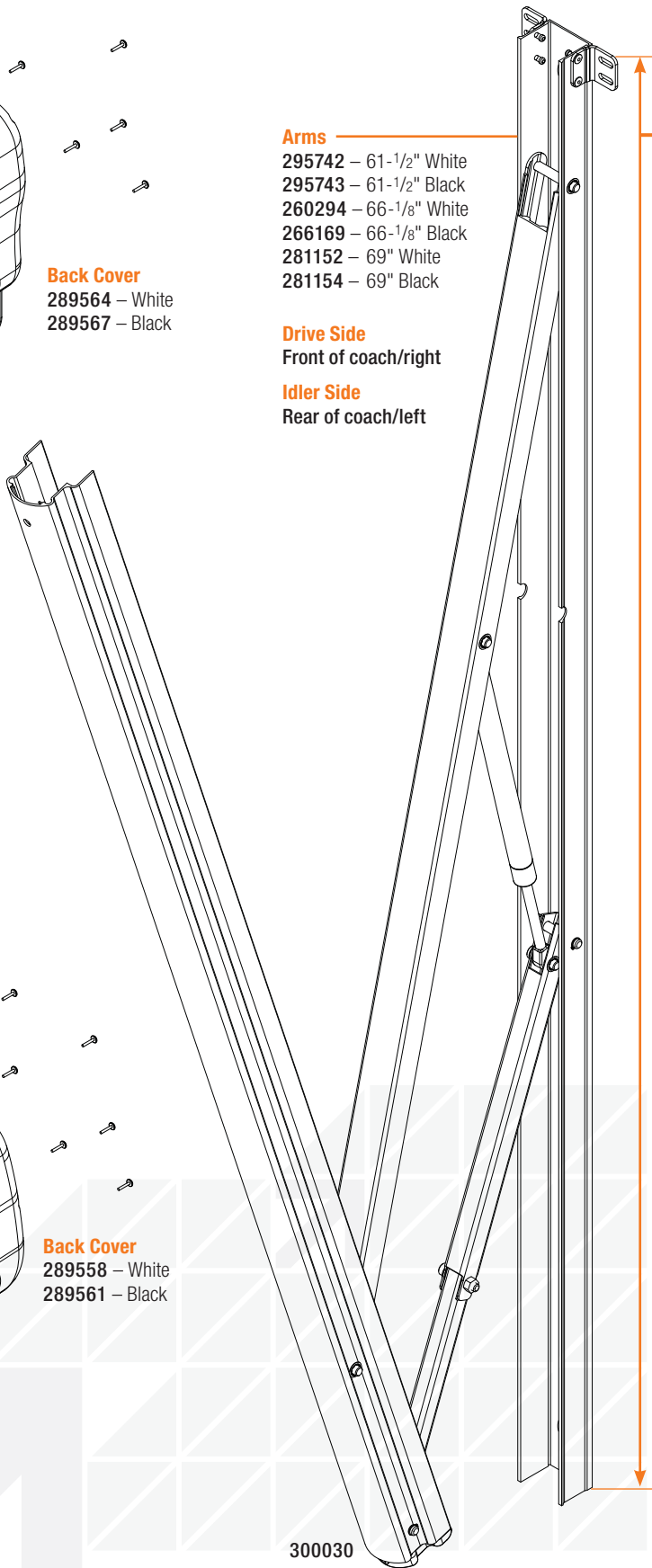

Ordering

Replacement Arms

There are three types of Solera replacement arms. These arms are universal to both power and manual awnings. Simply measure the length of the wall-mount extrusion from top to bottom.

- Short style arms measure 60-1/2"
- Pitched style arms measure 66-1/8"
- Flat style arms measure 69"



Wiring Harness
280570

300030



ALIGNMENT, SUSPENSION & AXLES

CORRECT TRACK™ SUSPENSION ALIGNMENT SYSTEM

Your customers will feel the difference in their tow and in their wallet

Correct Track™ by Lippert Components can be integrated into your RV suspension system to allow for simple and safe alignment adjustments to ensure your trailer tows with the tow vehicle, not against it. After performing a laser alignment check, we can customize the wheel alignment to your specific load requirements by turning the octagon cam in ¼-inch increments. Heavy slide-outs, appliances and cargo can cause unbalance, premature tire wear and uncontrollable RV vibration, but Correct Track suspension alignment system keeps your tires running smoothly, improves gas mileage and ultimately saves you money.



part no.	description
87120	Correct Track II Single Axle Kit
87220	Correct Track II Tandem Axle Kit
87320	Correct Track II Triple Axle Kit



ALIGNMENT
SUSPENSION
& AXLES

LEVELING &
STABILIZATION

TOWING

CARGO,
SECURITY &
STORAGE

WASTE
MANAGEMENT

AWNINGS

STEPS

SLIDE-OUTS

HAPPYJAC

DOORS
& SEALS

KITCHEN
& BATH

FURNITURE &
MATTRESS

CORRECT TRACK™ SUSPENSION ALIGNMENT SYSTEM

Every one of your customers wants better gas mileage. You can give it to them.

Is your trailer pulling against you?

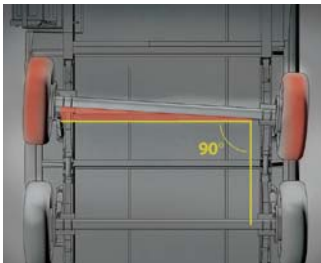

Misaligned suspension can cause uneven tire wear.

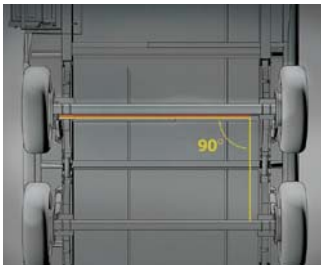

A properly aligned suspension tows straighter and can lead to better fuel mileage.



Correct Track is endorsed by The RV Doctor, Gary Bunzer.

- Easy bolt-on installation
- Can improve fuel economy
- Tires run smoother and cooler
- Helps prevent uneven tire wear
- Trailer tows with the tow vehicle, not against it
- Prevents vibrations, protecting RV equipment from damage

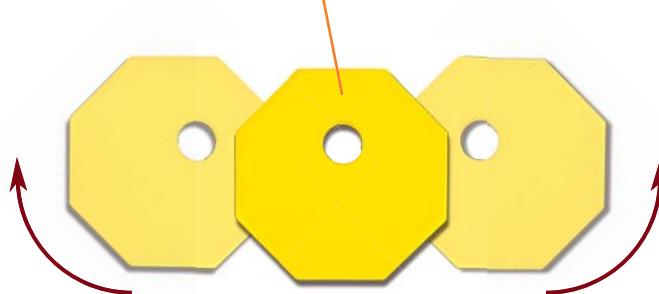

Each turn clockwise or counterclockwise adjusts alignment 1/4 inch

Ask your LCI sales rep about the Correct Track Profit Program.

NeverFail™ BUSHINGS

no maintenance • life-time suspension

Never Fail Spring and Shackle Bushings are maintenance-free, permanently lubricated and guaranteed to never fail. Never Fail Bushings are significantly less expensive and more durable than wet bolts with bronze bushings that become worn over time.



Actual Never Fail Bushing
with 100,000 miles



Never Fail Bushing Replacement Kits

Replace your old, worn-out bushings with our Never Fail Bushing kits in convenient single, tandem and triple axle retail packages.



Never Fail Shackle, Bolt & Bushing Kits

Our Never Fail Shackle, Bolt & Bushing kits come complete with all the hardware you need to replace your standard running gear kit. Replace today and forget about bushing maintenance forever

part no.	description
279684	Never Fail Bushings Single Axle Kit
2796841	Never Fail Bushings Single Axle Kit (French)
279685	Never Fail Bushings Double Axle Kit
2796851	Never Fail Bushings Double Axle Kit (French)
279686	Never Fail Bushings Triple Axle Kit
2796861	Never Fail Bushings Triple Axle Kit (French)
281285	Never Fail Shackle, Bolt & Bushing Upgrade Kit; Double Axle
281288	Never Fail Shackle, Bolt & Bushing Upgrade Kit; Triple Axle
331179	Never Fail Can of Bushings; 50/Can

EQUA-FLEX® RUBBERIZED EQUALIZER

equa-flex

The patented Equa-Flex rubberized equalizer absorbs road shock like a sponge instead of transferring it to the RV and cargo, preventing damage that can be caused by a bumpy ride. Equa-Flex also reduces fore-to-aft movement, often referred to as "chucking," to provide a smooth, comfortable ride. Equa-Flex also Scored a 7.5 out of 10 in independent testing, compared to 5.0 by the leading competitor.



Equa-Flex Equalizer Frame Chatter Testing Results

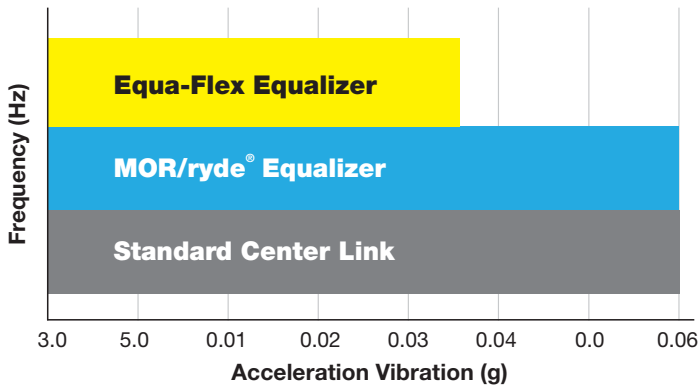

Equa-Flex reduces frame acceleration by 40% at 15-40Hz compared to both MOR/ryde and a standard non-ride enhanced suspension.

part no.	description
1455393	Equa-Flex Rubberized Suspension; Single Axle; 3.5K
279687	Equa-Flex Rubberized Suspension; Tandem Axle; 4K-6K
279688	Equa-Flex Rubberized Suspension; Tandem Axle; 6K-8K
314336	Equa-Flex Rubberized Suspension; Spread Tandem Axle; 5.2K
281314	Equa-Flex Rubberized Suspension; Triple Axle; 3K-6K
279689	Equa-Flex Rubberized Suspension; Triple Axle; 5K-8K

Single Axle Application 1455393



5,200-lb Capacity 314336 Tandem Spread Axle

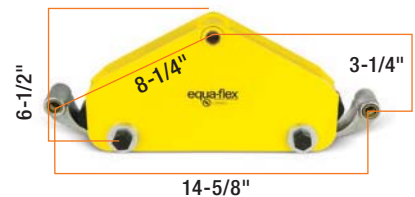

Under 6,000-lb Capacities 279687 Tandem Application 281314 Triple Application 279689 Triple Application



Over 6,000-lb Capacities 279688 Tandem Application 279689 Triple Application



ALIGNMENT
SUSPENSION
& AXLES

LEVELING &
STABILIZATION

TOWING

CARGO
SECURITY &
STORAGE

WASTE
MANAGEMENT

AWNINGS

STEPS

SLIDE-OUTS

HAPPYAC

DOORS
& SEALS

KITCHEN
& BATH

FURNITURE &
MATTRESS

SUSPENSION ENHANCEMENT

Our Center Point suspension system absorbs impact caused by road shock and provides a smoother ride and optimum brake efficiency. It's easy to install and dramatically improves passenger comfort and reduces side-to-side trailer sway. It dampens road shock more effectively than torsion axles. It also dramatically improves braking distance in panic stops.



part no.	description
1565391	Center Point Air Ride Suspension; Tandem Axle (3 Boxes)
1565401	Center Point Air Ride Suspension; Triple Axle (7 Boxes)

**Call for individual replacement parts*

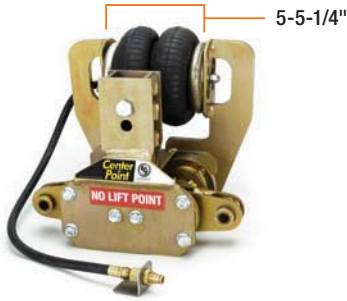

Air Suspension Unit



Each kit comes complete with mounting hardware

- ALIGNMENT, SUSPENSION & AXLES
- LEVELING & STABILIZATION
- TOWING
- CARGO, SECURITY & STORAGE
- WASTE MANAGEMENT
- AWNINGS
- STEPS
- SLIDE-OUTS
- HAPPYJAC
- DOORS & SEALS
- KITCHEN & BATH
- FURNITURE & MATTRESS

SHOCK MOUNT KITS

Instantly improve your customer's suspension with our complete shock mounting kits. Shocks help to manage axle spring movement to provide a smoother, more comfortable ride. Complete mounting kits for 2-³/₈" and 3" axle tubes available as well as single replacement shocks. Shock installation requires 4" of clearance between tire and frame.



Complete Shock Mount Kits

part no.	description
281281	Shock Mount Kit; 3" Axle Tube
281255	Shock Mount Kit; 2-3/8" Axle Tube
283271	Standard Replacement Shock (Black)
283280	Heavy-Duty Replacement Shock (Yellow)



Heavy-duty gas shock

8.625" compressed length
13.5" extended length



Standard oil shock

7.5" compressed length
12" extended length

FORWARD SELF-ADJUSTING BRAKES

Be prepared in case of an emergency stop

Standard brakes should be adjusted every three months. Forward Self-Adjusting Brakes self-adjust during every forward stop, providing up to 50 percent better braking distance and preventing premature brake line and magnet wear.



GET UP TO **50** PERCENT **BETTER BRAKING DISTANCE**



Trailer equipped with forward self-adjusting brakes



Trailer Equipped with Standard Electric Brakes

Trailer equipped with standard electric brakes

SIMULATED STOPPING DISTANCE AT 60 MPH

part no.	description
296649	10" x 2-1/4" LH Forward Self-Adjusting Brake Assembly, 3.5K
296650	10" x 2-1/4" RH Forward Self-Adjusting Brake Assembly, 3.5K
296651	12" x 2" LH Forward Self-Adjusting Brake Assembly, 7K
296652	12" x 2" RH Forward Self-Adjusting Brake Assembly, 7K

ALIGNMENT
SUSPENSION
& AXLES

LEVELING &
STABILIZATION

TOWING

CARGO,
SECURITY &
STORAGE

WASTE
MANAGEMENT

AWNINGS

STEPS

SLIDE-OUTS

HAPPYJAC

DOORS
& SEALS

KITCHEN
& BATH

FURNITURE &
MATTRESS

SPRING AXLES



Redefining “standard”

With more than 500,000 square feet of total manufacturing space on the east, west & Texas coasts, LCI can meet any axle challenge in the RV, marine, horse and cargo trailer markets. Our robotic welders ensure the highest precision on our spindles, spring seats, torsion arms and torsion brackets. Every axle assembly is traceable down to the exact production run and original component lot number.



QUICK FACTS

- 2,000–12,000-pound spring axle capacity
- 2,000–7,000-pound spring idler axles
- CSA certification on all 2,000–7,000-pound axles
- Integrated, one-piece spindle flange
- Complete axle assembly and component traceability and serialization
- Single, tandem or triple axle assemblies with standard or upgraded equalized suspension available
- Straight or drop spindles
- Slipper or double eye leaf spring suspension
- Rust-prohibitive powder-coated axle tubing
- Waterproof connections on all electrical wiring
- Electric, hydraulic, hydraulic free-backing and hydraulic disc brakes available
- Forward Self-Adjusting Brakes available on 3.5–10K
- Super lube hubs and bearing lubrication option (standard on 8K spring axle)

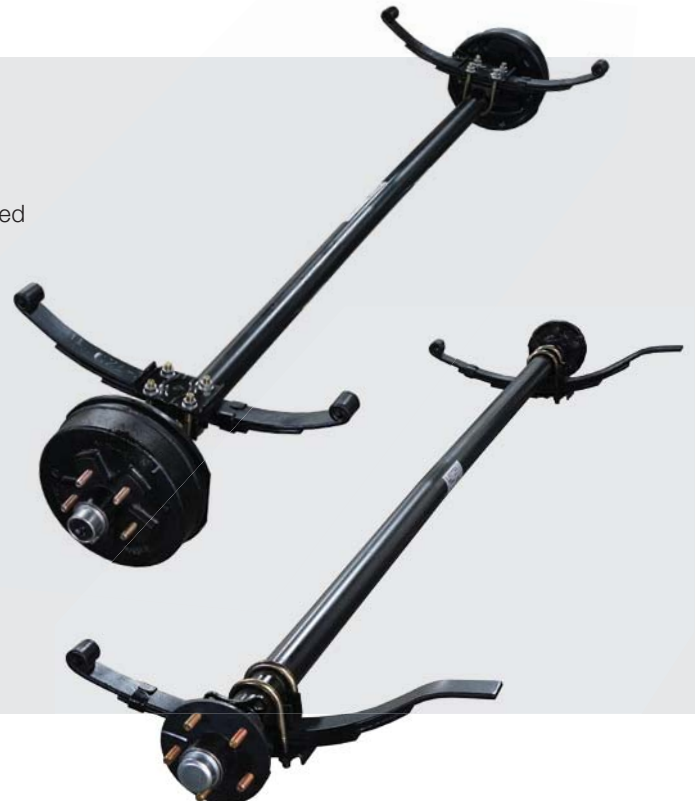

ALIGNMENT
SUSPENSION
& AXLES

LEVELING &
STABILIZATION

TOWING

CARGO
SECURITY &
STORAGE

WASTE
MANAGEMENT

AWNINGS

STEPS

SLIDE-OUTS

HAPPYJAC

DOORS
& SEALS

KITCHEN
& BATH

FURNITURE &
MATTRESS

TORSION AXLES

QUICK FACTS

- 2,000–8,000-pound torsion axle capacity (square bolt orientation)
- 2,000–7,000-pound torsion axle capacity (diamond bolt orientation)
- 2,000–7,000-pound torsion idler axle capacity
- Rubberized torsion beam for a quiet, smooth ride
- Require less maintenance than spring axles
- Torsion bar absorbs road shock and vibrations
- Square and diamond orientation available
- Various starting angles to control trailer height
- Independent wheel suspension
- CSA certification on all 2,000–7,000-pound capacity axles
- Complete axle assembly and component traceability and serialization on all axles
- Single and tandem axle assemblies with standard or upgraded equalized suspension available
- Rust-prohibitive powder-coated axle tubing
- Waterproof connections on all electrical wiring
- Electric, hydraulic, hydraulic free-backing and hydraulic disc brakes available
- Forward Self-Adjusting Brakes available on 3.5–10K
- Super lube hubs and bearing lubrication option

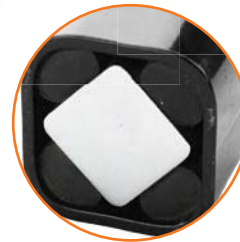

Diamond Pattern



Square Pattern

Super Lube advantages:

- Time-saving lubrication system requires no disassembly of wheels or hubs
- Makes changing grease easier and cleaner
- Super Lube system fills the entire bearing cavity with grease, allowing for complete submersion
- Grease cap with rubber plug allows easy access to grease zerk in axle spindle
- Pumping new grease through zerk purges old grease for a complete repack
- Better long-term protection than standard hubs

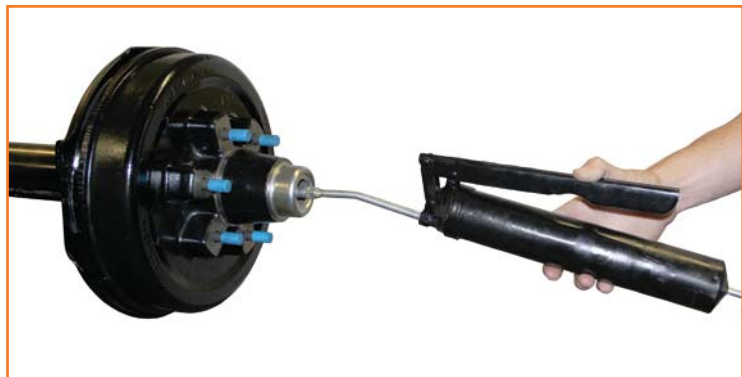

ALIGNMENT
SUSPENSION
& AXLES

LEVELING &
STABILIZATION

TOWING

CARGO,
SECURITY &
STORAGE

WASTE
MANAGEMENT

AWNINGS

STEPS

SLIDE-OUTS

HAPPYJAC

DOORS
& SEALS

KITCHEN
& BATH

FURNITURE &
MATTRESS

AXLE REPLACEMENT PARTS – 3.5K & 5.2K

3500K Wheel End Replacements

item	part no.	description
1	122065	Rubber Plug for lubed grease caps
2	122067	Dust Cap; 2" bore; super lube
	122099	Dust Cap; 2" bore; non-lubed
3	122075	Cotter Pin
4	122081	Spindle Nut; 6 slot
5	119214	Spindle Washer; round 1D
5a	119215	Spindle Washer; D-flat
5b	119216	Spindle Washer; locking tang
6	122089	Outer Bearing Cone L44649
	125102	Outer Bearing Cup L44610
7	126003	Hub Drum w/ cups & studs 5/4.5"
8	122092	Inner Bearing Cone L68149
	124296	Inner Bearing Cup L68111
9	122087	Grease Seal; Double Lip; 1.72" ID x 2.565" OD
10	122258	Brake Assembly 10" x 2.25" LH
	122450	Brake Assembly 10" x 2.25" RH
	136451	Shoe & lining kit for (1) brake
	136454	Magnet kit; green wire
	136452	Spring & hardware kit for (1) brake
	136453	Adjuster screw and spring kit

Use 5a/5b in place of 3 & 5 if spindle has no hole for cotter pin and has D-flat washer

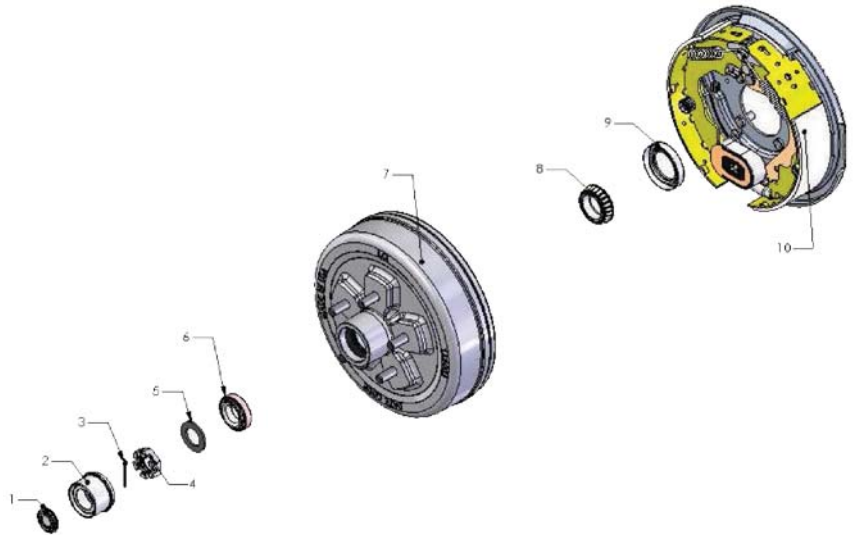

5200K Wheel End Replacements

item	part no.	description
1	122065	Rubber Plug for lubed grease caps
2	122064	Dust Cap; 2.5" bore; super lube
	122071	Dust Cap; 2.5" bore; non-lubed
3	122075	Cotter Pin
4	122081	Spindle Nut; 6 slot
5	119214	Spindle Washer; round ID
5a	119215	Spindle Washer; D-flat
5b	119216	Spindle Washer; locking tang
6	122090	Outer Bearing Cone LM67048
	124292	Outer Bearing Cup LM67010
7	122463	Hub Drum w/ cups & studs 6/5.5"
8	122066	Inner Bearing Cone 25580
	124287	Inner Bearing Cup 25520
9	122088	Grease Seal; Double Lip; 2.25" ID x 3.376" OD
10	122259	Brake Assembly 12" x 2" LH
	122451	Brake Assembly 12" x 2" RH
	136444	Shoe & lining kit for (1) brake
	136447	Magnet kit; black or white wire
	136445	Spring & hardware kit
	136453	Adjuster screw and spring kit

Use 5a/5b in place of 3 & 5 if spindle has no hole for cotter pin and has D-flat washer

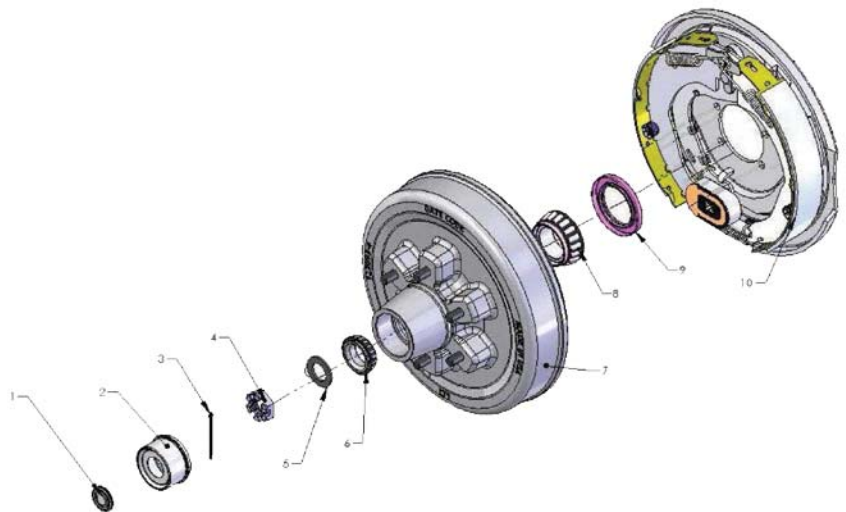

AXLE REPLACEMENT PARTS – 6K & 7K

6000K Wheel End Replacements

item	part no.	description
1	122065	Rubber Plug for lubed grease caps
2	122064 122071	Dust Cap; 2.5" bore; super lube Dust Cap; 2.5" bore; non-lubed
3	122075	Cotter Pin
4	122081	Spindle Nut; 6 slot
5	179660	Spindle Washer; round ID
5a	172888	Spindle Washer; D-flat
5b	119216	Spindle Washer; locking tang
6	122091 126996	Outer Bearing Cone 15123 Outer Bearing Cup 15245
7	122094	Hub Drum w/ cups & studs 6/5.5"
8	122066 124287	Inner Bearing Cone 25580 Inner Bearing Cup 25520
9	122088	Grease Seal; Double Lip; 2.25" ID x 3.376" OD
10	122259 122451 136444 136447 136445 136453	Brake Assembly 12" x 2" LH Brake Assembly 12" x 2" RH Shoe & lining kit for (1) brake Magnet kit; black or white wire Spring & hardware kit for (1) brake Adjuster screw and spring kit

Use 5a/5b in place of 3 & 5 if spindle has no hole for cotter pin and has D-flat washer



7000K Wheel End Replacements

item	part no.	description
1	122065	Rubber Plug for lubed grease caps
2	127300 127206	Dust Cap; 2.75" bore; super lube Dust Cap; 2.75" bore; non-lubed
3	122075	Cotter Pin
4	122081	Spindle Nut; 6 slot
5	179660	Spindle Washer; round ID
5a	172888	Spindle Washer; D-flat
5b	119216	Spindle Washer; locking tang
6	127009 127012	Outer Bearing Cone 14125A Outer Bearing Cup 14276
7	122094	Hub Drum w/ cups & studs 6/5.5"
7a	134543	Hub Drum; 9/16" studs; 8/6.5"
8	122066 124287	Inner Bearing Cone 25580 Inner Bearing Cup 25520
9	122088	Grease Seal; Double Lip; 2.25" ID x 3.376" OD
10	122259 122451 136444 136447 136445 136453	Brake Assembly 12" x 2" LH Brake Assembly 12" x 2" RH Shoe & lining kit for (1) brake Magnet kit; black or white wire Spring & hardware kit for (1) brake Adjuster screw and spring kit

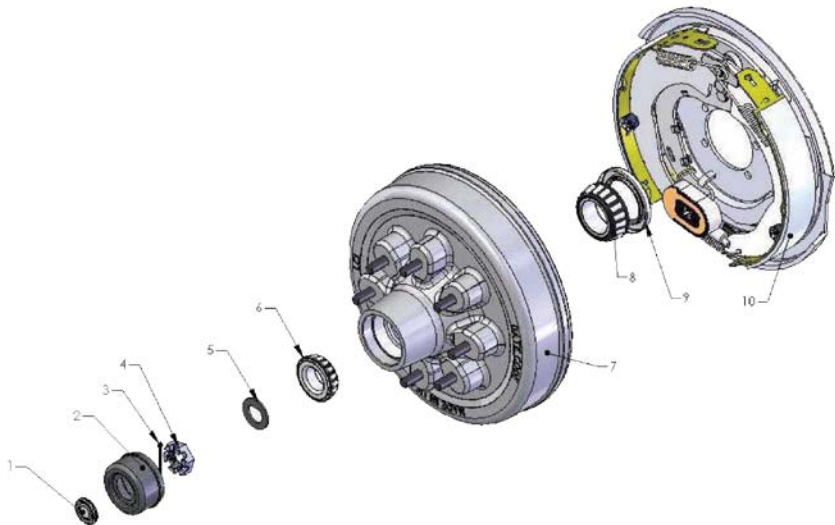

ALIGNMENT
SUSPENSION
& AXLES

LEVELING &
STABILIZATION

TOWING

CARGO
SECURITY &
STORAGE

WASTE
MANAGEMENT

AWNINGS

STEPS

SLIDE-OUTS

HAPPYJAC

DOORS
& SEALS

KITCHEN
& BATH

FURNITURE &
MATTRESS

ELECTRIC BRAKE ASSEMBLIES & PARTS

10" x 2.25" Electric Brake Assembly fits 3.5K axles

part no.	description
297956	LH Electric Brake Assembly (Single)
298274	RH Electric Brake Assembly (Single)
122258	LH Electric Brake Assembly (Bulk-156 pc)
122450	RH Electric Brake Assembly (Bulk-156 pc)

12.25" x 3.38" Electric Brake Assembly fits 8K axles

part no.	description
298277	LH Electric Brake Assembly; 8K (Single)
298279	RH Electric Brake Assembly; 8K (Single)
156443	LH Electric Brake Assembly; 8K (Bulk-117pc)
156444	RH Electric Brake Assembly; 8K (Bulk-117 pc)



122258 (front)



156444 (front)

12" x 2" Electric Brake Assembly fits 4-7K axles

part no.	description
298275	LH Electric Brake Assembly (Single)
298276	RH Electric Brake Assembly (Single)
122259	LH Electric Brake Assembly (Bulk-117 pc)
122451	RH Electric Brake Assembly (Bulk-117 pc)

12.25" x 3.38" Electric Brake Assembly fits 10K axles

part no.	description
181935	LH Electric Brake Assembly; 10K (Single)
181936	RH Electric Brake Assembly; 10K (Single)

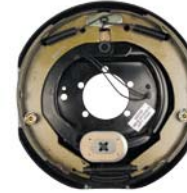

122259 (front)



156443 (front)

12.25" x 5" 7-Bolt Electric Brake Assembly fits 12K axles

part no.	description
297998	LH Electric Brake Assembly; 12K (Single)
2979981	RH Electric Brake Assembly; 12K (Single)

10" x 2.25" Electric Brake Replacement Parts

part no.	description
136451	Shoe & Lining Kit (includes primary & secondary shoe/lining)
136452	Spring & Hardware Kit (includes hold-down pin, cup, spring, adjustment & retractor spring)
136453	Adjustment Screw Kit (includes adjustment screw assembly & spring)
136454	Magnet Kit (includes magnet w/ green lead wires, retainer clip & spring)



136451



136452



136453



136454

12" x 2" Electric Brake Replacement Parts

part no.	description
136444	Shoe & Lining Kit (includes primary & secondary shoe/lining)
136445	Spring & Hardware Kit (includes hold-down pin, cup, spring, adjustment & retractor spring)
136453	Adjustment Screw Kit (includes adjustment screw assembly & spring)
136447	Magnet Kit (includes magnet w/ white lead wires, retainer clip & spring)



136444



136445



136447

Use 5a/5b in place of 3 & 5 if spindle has no hole for cotter pin and has D-flat washer

HUBS/BEARING ASSEMBLIES/GREASE SEALS

141280



158530



122461



Idler Hubs

part no.	capacity	bolt pattern	stud size
141280	2200 lb. (5.5" HFD)	5-4.5"	1/2"
158530	2000 lb. (6.5" HFD)	5-4.5"	1/2"
122461	3500 lb.	5-4.5"	1/2"

122460



122463



122465



141290



Brake Hubs

part no.	capacity	bolt pattern	stud size
122460	3500 lb.	5-4.5"	1/2"
122463	5200 to 6000 lb.	6-5.5"	1/2"
122465	6000 to 7000lb.	8-6.5"	1/2"
141290	6000 to 7000 lb.	8-6.5"	9/16"

1,250 lb.
1.249" ID



2,200 lb.
1.5" ID



3,500 lb.
1.719" ID



5.2,6,7 & 8 lb.
2.25" ID



Grease Seals

part no.	description
333953	Grease Seal; 1,250 lb. (1" Spindle); 1.249" ID; 2/package
333954	Grease Seal; 1,250 lb. (1" Spindle); 1.249" ID; 10/package
333956	Grease Seal; 2,200 lb.; 1.5" ID; 1.987" OD; 2/package
333957	Grease Seal; 2,200 lb.; 1.5" ID; 1.987" OD; 10/package
333960	Grease Seal; 3,500 lb.; 1.719" ID; 2.565" OD; 2/package
333961	Grease Seal; 3,500 lb.; 1.719" ID; 2.565" OD; 10/package
333962	Grease Seal; 5.2, 6, 7 & 8 lb.; 2.25" ID; 2/pkg
333963	Grease Seal; 5.2, 6, 7 & 8 lb.; 2.25" ID; 10/pkg

Each Kit Contains:

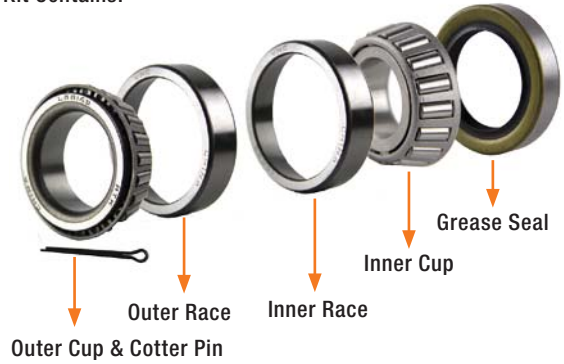

Bearing, Race & Cup Kits

part no.	description
333948	Bearing Kit; 3,500lb. Axle (includes Outer Bearing L44649, Inner Bearing L68149, Inner Cup L68111, Outer Cup L44610, Grease Seal & Pin)
333949	Bearing Kit; 5,200 lb. Axle (includes Outer Bearing LM67048, Inner Bearing 25580, Inner Cup 25520, Outer Cup LM67010, Grease Seal & Pin)
333950	Bearing Kit; 6,000 lb. Axle (includes Outer Bearing 15123, Inner Bearing 25580, Inner Cup 25520, Outer Cup 15245, Grease Seal & Pin)
333951	Bearing Kit; 7,000 lb. Axle (includes Outer Bearing 14125A, Inner Bearing 25580, Inner Cup 25520, Outer Cup 14276, Grease Seal & Pin)

ALIGNMENT
SUSPENSION
& AXLES

LEVELING &
STABILIZATION

TOWING

CARGO
SECURITY &
STORAGE

WASTE
MANAGEMENT

AWNINGS

STEPS

SLIDE-OUTS

HAPPYJAC

DOORS
& SEALS

KITCHEN
& BATH

FURNITURE &
MATTRESS

AXLE SPRINGS & ATTACHING PART KITS



Double Eye Leaf Spring

Leaf Springs

part no.	springs	capacity	loaded length	eye-to-eye length	loaded arch length	standens
127094	3	1,000 lb.	21"	20.375"	2.12"	72-17
127103	3	1,250 lb.	24"	23.125"	2.5"	72-06
125269	4	1,400 lb.	21"	20.5"	2.38"	72-13
125215	3	1,750 lb.	24"	23.2"	2.5"	72-09
124903	4	1,750 lb.	26"	25.25"	1.5"	72-42
125799	4	2,000 lb.	24"	23.125"	2.5"	72-18
125797	3	2,000 lb.	26"	25.25"	1.75"	72-24
129745	4	2,200 lb.	26"	25.25"	2"	72-78
124886	4	2,600 lb.	26"	25.25"	1.75"	72-25
133982	4	2,500 lb.	24"	23.125"	2.5"	72-20
122111	4	3,000 lb.	26"	25.25"	1.75"	72-26
122113	6	3,500 lb.	26"	24.875"	1.75"	72-27
132887	7	4,000 lb.	26"	24.875"	1.75"	72-79



Slipper Spring

Slipper Springs

part no.	springs	capacity	loaded length	eye-to-eye length	loaded arch length	standens
132819	2	1,000 lb.	25"	24.75"	4"	72-2
136527	4	2,000 lb.	25"	26.5"	2"	72-30
125250	4	2,500 lb.	25"	26.5"	2"	72-31
125203	5	3,500 lb.	25"	26.5"	2"	72-32
156446	7	4,000 lb.	25"	26.5"	n/a	72-33
176326	5	5,000 lb.	30"	30"	2.7"	72-80

121101



121097



121098



121099



121100



128877



137383



Attaching Part Kits

part no.	description
121101	Single Axle AP Kit; 3-1/8" Link
121097	15" Tandem AP Kit; 33" Axle Spacing; EQ-104
121098	15" Tandem AP Kit; 33" Axle Spacing; EQ-310
121099	16" Tandem AP Kit; 35" Axle Spacing; EQ-E1
121100	Triple AP Kit; 33" Axle Spacing; EQ-104 & 105
128877	Tandem Slipper AP Kit; 33.5" Axle Spacing; EQ-13-4
137383	Triple Slipper AP Kit; 33.5" Axle Spacing; 13-4

EQUALIZERS/SPINDLE WASHERS/U-BOLTS/SHACKLE LINKS

122106

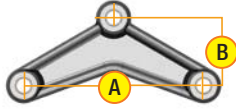

126277

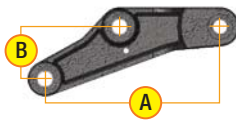

126460

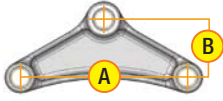

126741

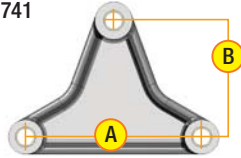

122771

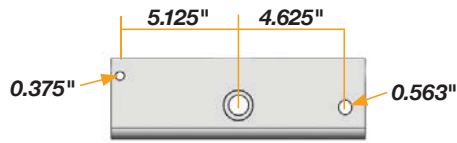

Leaf Springs

part no.	equalizer type	A	B	hole diameter
122106	EQ-E1	7-3/4"	2-7/8"	9/16"
126277	EQ-105	6-3/4"	2"	9/16"
126460	EQ-104	5-3/4"	2"	9/16"
126741	EQ-310	6-1/16"	4"	9/16"
127771	EQ-1304 (Slipper)	See Drawing	See Drawing	See Drawing

All cast equalizers come with nylon bushings



U-Bolts

part no.	description
139737	U-Bolt 3/8"-24 x 4" for 1.75" Axle Tube; Yellow Zinc
122073	U-Bolt 1/2"-20 x 5.1" for 2.38" Axle Tube; Yellow Zinc
122070	U-Bolt 1/2"-20 x 6.5" for 3" Axle Tube; Yellow Zinc
132049	U-Bolt 1/2"-20 x 7.25" for 3" Axle Tube; Yellow Zinc



Note - shackle link dimensions are measured from center of hole to center of hole

Shackle Links

part no.	description
122487	Standard 2.25" Shackle Link
133207	Standard 3.13" Shackle Link
126172	Heavy-Duty 2.25" Shackle Link
1567651	Heavy-Duty 3.13" Shackle Link

119215



119214



119216



Spindle Washers

part no.	description
119215	1" D-Flat Spindle Washer
119214	1" Round Spindle Washers
119216	Tang Washer

122487



133207



126172



1567651



125675



133485



Shackle Link Assemblies

part no.	description
125675	Standard 2.25" Shackle Link Assembly
133485	Standard 3.13" Shackle Link Assembly

ALIGNMENT
SUSPENSION
& AXLES
LEVELING &
STABILIZATION
TOWING
CARGO
SECURITY &
STORAGE
WASTE
MANAGEMENT
AWNINGS
STEPS
SLIDE-OUTS
HAPPYJAC
DOORS
& SEALS
KITCHEN
& BATH
FURNITURE &
MATTRESS

AXLE HANGERS & HARDWARE

106181



106182



106183



106185



106184



102906

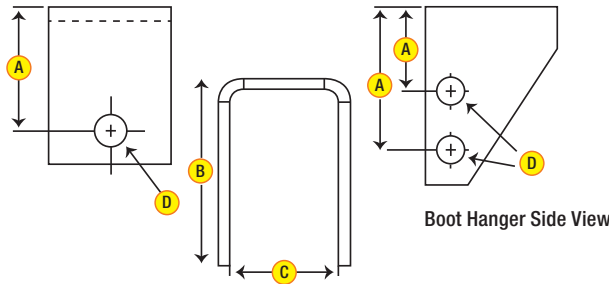

Boot Hanger Side View

Axle Hangers

part no.	description	A	B	C	D
106181	1.25" Axle Hanger	1.25"	1.86"	2"	9/16"
106182	2.25" Axle Hanger	2.14"	2.87"	2"	9/16"
106183	3.25" Axle Hanger	3.13"	3.87"	2"	9/16"
106185	4.25" Axle Hanger	4.05"	4.75"	2"	9/16"
106184	5" Axle Hanger	4.82"	5.55"	2"	9/16"
102906	3" & 5" Boot Hanger	3 & 5"	5.75"	2"	9/16"

297426



297427



297429



Axle Mounting Kits (mounts one axle)

part no.	description
297426	Axle Mounting Kit; 1.75" Axle Tube 3/8"-24 x 4" U-Bolts
297427	Axle Mounting Kit; 2.375" Axle Tube 1/2"-20 x 5" U-Bolts
297429	Axle Mounting Kit; 3.0" Axle Tube 1/2"-20 x 7.25" U-Bolts

122102



121803



271254



126238



126197



129767



Axle Bolts

part no.	description
122102	Shoulder Bolt; 9/16" x 2.32" w/ 7/16"-20 Thread End
121803	Press-In Wheel Stud; 1/2"-20 UNF x 1.98", 0.617" Knurl
271254	Shoulder Bolt; 9/16" x 2.82" w/ 7/16"-20 Thread End
126238	Wet Bolt; 9/16" x 3.24" Black Phosphate & Oil w/ 7/16"-20 Thread End
126197	Wet Bolt; 9/16" x 3.74" Black Phosphate & Oil w/ 7/16"-20 Thread End

122081



122076



122079



122077



122085



134851



Axle Nuts

part no.	description
129767	Shackle Bolt Nut; 7/16"-20
122081	6-Slot Castle Spindle Nut; 1"-14
122076	600 Cone Wheel Nut; 1/2"-20
122079	U-Bolt Flange Nut; 1/2"-20
122077	U-Bolt Self-Locking Nut; 3/8"-24
122085	Hex Lug Nut; 7/16"-20
134581	600 Lug Nut; 9/16"-18

*Standard stud size is 9/16"

DUST CAPS/MISC. PARTS

122099



122067



122071



122064



127206



127300



122065



Dust Caps

part no.	description
122099	Dust Cap; Non-Lubed for 2K & 3.5K; DC 200
122067	Dust Cap; Lubed for 2K & 3.5K; DC 200L
122071	Dust Cap; Non-Lubed for 5.2K & 6K; DC 250
122064	Dust Cap; Lubed for 5.2K & 6K; DC 250L
127206	Dust Cap; Non-Lubed for 7K & 8K; DC 275
127300	Dust Cap; Lubed for 7K & 8K; DC 275L
122065	Universal Rubber Dust Cap Plug

122075



122084



126171



122255



176984



Miscellaneous Parts

part no.	description
122075	Standard Cotter Pin for LCI Axle Assemblies
122084	3M Sealed Wire Connector
126171	Bronze Bushing, .58ID x .7000 x 1.74
122255	Grease Zerk for LCI 2K, 3.5K, 7K & 8K Axles
176984	Grease Zerk for LCI 5.2K & 6K Axles

ALIGNMENT
SUSPENSION
& AXLES

LEVELING &
STABILIZATION

TOWING

CARGO,
SECURITY &
STORAGE

WASTE
MANAGEMENT

AWNINGS

STEPS

SLIDE-OUTS

HAPPYJAC

DOORS
& SEALS

KITCHEN
& BATH

FURNITURE &
MATTRESS

LEVELING & STABILIZATION



GROUND CONTROL® ELECTRIC LEVELING SYSTEM



With the push of a button, Ground Control 3.0 levels and stabilizes an RV quickly and accurately, enhancing the overall camping experience. It can take up to an hour to get an RV level with manual jacks, chocks and wedges. Ground Control 3.0 levels and stabilizes the RV in a matter of minutes and features automatic re-hitch memory that remembers the exact height at which the RV was unhitched to save RVers time when hooking up.

Ground Control Speed vs. Atwood

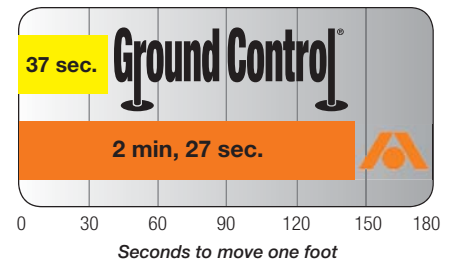

Automatic, one-touch electric leveling



Only 3 minutes to level



Stronger, faster jacks



Easy bolt-on installation



Optional one-touch wireless remote

part no.	description
358590	Ground Control Fifth-Wheel Kit w/ Wireless Remote
358597	Short Bracket Package (Fits 6" I-Beam Frames)
358601	Replacement Remote & Charger



358590:
Fifth-Wheel Kit

ALIGNMENT,
SUSPENSION
& AXLES

LEVELING &
STABILIZATION

TOWING

CARGO,
SECURITY &
STORAGE

WASTE
MANAGEMENT

AWNINGS

STEPS

SLIDE-OUTS

HAPPYJAC

DOORS
& SEALS

KITCHEN
& BATH

FURNITURE &
MATTRESS

POWER GEAR® HYDRAULIC LEVELING SYSTEM



The four-point Power Gear Hydraulic Leveling System levels and stabilizes a motorhome in just a few minutes using one-touch, automatic or semi-automatic leveling. Power Gear Motorhome Leveling enhances the overall camping experience by preventing annoying rocking and swaying at the campsite and can accommodate a wide range of vehicle sizes from Class A to Class C units.



QUICK FACTS

- American-made leveling jacks can lift 6,000–24,000 pounds each
- Automatic and semi-automatic aftermarket kits available
- Automatic system uses smart electronics to minimize frame twist
- Manual bi-level mode can lift front or back only
- Patented safety feature retracts all jacks when the parking brake is released
- Lightweight and compact; all components fit under the coach

A complete line of aftermarket kits and replacement parts available

Automatic and semi-automatic aftermarket kits for a range of vehicles from class A to class C units

part no.	description	pump kit	hose kit	electrical kit	leveling jack rear	leveling jack front	interconnect harness
359155	Heavy-Duty with Tag Axle - GVWR to 54K	359327 Pump	359249 (Contains 8 Hoses)	359080 Touch Pad	359351 Jack Leg	359352 Jack Leg	359478 Harness
359156	Heavy-Duty GVWR to 36K	359327 Pump	359250 (Contains 8 Hoses)	359080 Touch Pad	359352 Jack Leg	359352 Jack Leg	359066 Harness
359157*	Medium-Duty GVWR to 30K	359269 Pump	359251 (Contains 4 Hoses)	359080 Touch Pad 359248 Control	359384 Jack Leg	359394 Jack Leg	359478 Harness
359158*	Light-Duty GVWR to 18K	359360 Pump	1010001272 (Contains 4 Hoses)	359080 Touch Pad 359248 Control 359067 Harness	359394 Jack Leg	359404 Jack Leg	359478 Harness

*Medium and Light-Duty Kits require a Mounting Bracket Kit that is sold separately. Ford Mounting Kit Part #1010001271. Workhorse Mounting Kit Part #1010001549.

ALIGNMENT, SUSPENSION & AXLES

LEVELING & STABILIZATION

TOWING

CARGO SECURITY & STORAGE

WASTE MANAGEMENT

AWNINGS

STEPS

SLIDE-OUTS

HAPPYJAC

DOORS & SEALS

KITCHEN & BATH

FURNITURE & MATTRESS

LEVELING SERVICE KITS

jack leg	supersedes part no.	description	spring kit	repair kit/ seal kit
359384	500082HR9	9K Spring Return	359434	359465
359496	500235H	9K Spring Return	359430	359465
359492	500498H	9K Spring Return	359430	359465
359394	500759	9K Spring Return	359434	359459
359377	500833	9K Spring Return	359434	359459
359375	500843	9K Spring Return	359434	359459
359364	500932	9K Spring Return	359434	359459
359050	500070TH	16K Power Down/Power Up	n/a	359463
359348	501136	16K Power Down/Power Up	n/a	359463
359347	501137	16K Power Down/Power Up	n/a	359463
359498	500145	16K Power Down/Power Up	n/a	359463
359404	500730	6K Spring Return	359412	359461
359376	500832	6K Spring Return	359412	359461
359378	500842	6K Spring Return	359412	359461
359372	500876	6K Spring Return	359412	359461
359372	500933	6K Spring Return	359412	359461
359384	500800	12K Spring Return	359434	359458
359170	3510000111	12K Spring Return	359434	359458
n/a	n/a	Jack Obsolete; For Repair Purchase spring kit or repair kit	359434	359459
n/a	n/a	Jack Obsolete; For Repair Purchase spring kit or repair kit	359434	359458
359394*	500384HR*	6K Spring Return Kit	359413	359462*
*Seal kit only works for 500384HR made after 2003. If 2003 or earlier, must replace with entire leg kit #501022				
359495	500385TH88	12L Spring Return	n/a	359460**
**Seal kit only works for 500385TH made after 2003. If 2003 or earlier, must replace with entire leg kit #500385TH				

ALIGNMENT,
SUSPENSION
& AXLES

LEVELING &
STABILIZATION

TOWING

CARGO,
SECURITY &
STORAGE

WASTE
MANAGEMENT

AWNINGS

STEPS

SLIDE-OUTS

HAPPYJAC

DOORS
& SEALS

KITCHEN
& BATH

FURNITURE &
MATTRESS

POWER STABILIZER JACKS

POWER STABILIZER JACKS

Redesigned for better stability and higher speed

After a long road trip, cranking manual scissor jacks can be a lengthy and strenuous process. Stabilize faster with Power Stabilizer Jacks. Easily retract and extend the jacks with the flip of a switch. In just a few minutes, the coach will be stable, so you can spend less time setting up camp and more time enjoying your vacation. Power Stabilizer Jacks are an affordable way to upgrade to power stabilization and easily bolt on to the existing frame.

QUICK FACTS

- Legs extend up to 30"
- Heavy-gauge steel construction
- **New** embossed legs add strength
- Lighter than previous models
- One motor independently controls both legs
- Powder-coat finish stands up to the elements
- **New** patented technology, motor is 2x faster
- Front and rear mounting applications available for maximum stability
- Jacks automatically adjust to the terrain



part no.	description
347132	High Speed Electric Stabilizer Jack Without Sway Lock
1134121	Electric Stabilizer Jack Support Arm – Black
1134122	Electric Stabilizer Jack Support Arm – Yellow
119226	Electric Stabilizer Jack Crank Handle
266030	Electric Stabilizer Jack Double Spacer 2" (Weld-on, Each)
352338	Motor



1134121



352338



266030



119226

ALIGNMENT, SUSPENSION & AXLES

LEVELING & STABILIZATION

TOWING

CARGO, SECURITY & STORAGE

WASTE MANAGEMENT

AWNINGS

STEPS

SLIDE-OUTS

HAPPYAC

DOORS & SEALS

KITCHEN & BATH

FURNITURE & MATTRESS

New look. More features.

The new 3,500-pound Smart Jack by Lippert Components offers many new features never-before-seen on a power tongue jack. The new backlit control panel lets users easily operate the jack in the dark. The control panel also features a battery indicator that alerts the user of the remaining battery life. Halo effect LED lights shine down on the ball and coupler, where light is needed the most. The Smart Jack also features an auto-retract feature; just press the retract button three times, holding it for a few seconds on the third time to automatically retract the jack to towing height. Updated aesthetics give your trailer an updated look while hiding the motor and protecting it from the elements. Kit comes complete with mounting hardware, foot pad and manual override crank handle in case of power failure.



NEW bright halo effect LED light package shines down onto your ball and coupler where light is needed the most



NEW backlit buttons illuminate when any button is hit, and turn off automatically in order to prevent battery drain

QUICK FACTS

- **New** backlit modern control panel replaces tired looking rocker switches
- **New** battery indicator alerts user of remaining battery life
- **New** easy auto-retract feature retracts the jack to towing height without having to hold down the switch
- **New** updated hood mirrors the design in today's travel trailers and hides the motor, preventing cords and wires from becoming snagged
- 3,500-pound capacity
- Helical cut gears reduce noise and improve operating efficiency
- Easy access manual override on top of jack in case of power failure
- 30 AMP, 18" stroke
- Color offered: Black

part no.	description
431423	Smart Jack - Black



POWER TONGUE JACK



Stop wasting time cranking a manual tongue jack over and over. With just the flip of a switch, the 3,500-pound capacity Power Tongue Jack quickly lifts and lowers a travel trailer RV. The Power Tongue Jack is quiet and efficient and features four LED lights so it's easy to set up camp day or night.



QUICK FACTS

- 3,500-pound rating
- 30 AMP, 18" Stroke
- Textured casing helps protect from chips and cracks
- 4 LED lights provide excellent illumination
- Helical cut gears reduce noise and improve operating efficiency
- Kit includes mounting hardware, pins and manual crank handle

part no.	description
285318	Power Tongue Jack - Black

ALIGNMENT,
SUSPENSION
& AXLES

LEVELING &
STABILIZATION

TOWING

CARGO
SECURITY &
STORAGE

WASTE
MANAGEMENT

AWNINGS

STEPS

SLIDE-OUTS

HAPPYAC

DOORS
& SEALS

KITCHEN
& BATH

FURNITURE &
MATTRESS

MANUAL JACKS



24" Scissor Jack Kit
(mounting hardware not shown)



30" Scissor Jack Kit
(mounting hardware not shown)

QUICK FACTS

- 6,000-pound load capacity
- Rust-prohibitive finish on all metal surfaces
- Universal weld-on or bolt-on application
- Available in one- or two-jack kits; crank handle included in two-jack kit only
- Each jack comes with four mounting screws

part no.	description
285325	24" Stabilizer Jack; 1 per package w/ mounting hardware
285326	24" Stabilizer Jack Kit; 2 jacks, mounting hardware & crank handle
285332	30" Stabilizer Jack; 1 per package w/ mounting hardware
285344	30" Stabilizer Jack Kit; 2 jacks, mounting hardware & crank handle
285324	Standard Manual Stabilizer Jack Crank Handle

MANUAL SIDEWINDER JACKS



(hardware not shown)

QUICK FACTS

- 2,000-pound load capacity
- Rust-resistant finish on all metal surfaces
- Comes with hardware mounting kit
- 14-3/4" stroke
- 2-3/8" outer, 2" inner tube

part no.	description
285420	2,000 lb. Manual Sidewinder Jack w/ mounting hardware

ALIGNMENT,
SUSPENSION
& AXLES

LEVELING &
STABILIZATION

TOWING

CARGO,
SECURITY &
STORAGE

WASTE
MANAGEMENT

AWNINGS

STEPS

SLIDE-OUTS

HAPPYJAC

DOORS
& SEALS

KITCHEN
& BATH

FURNITURE &
MATTRESS

JT'S STRONG ARM™ JACK STABILIZER KITS

ALIGNMENT, SUSPENSION & AXLES

LEVELING & STABILIZATION

TOWING

CARGO SECURITY & STORAGE

WASTE MANAGEMENT

AWNINGS

STEPS

SLIDE-OUTS

HAPPYJAC

DOORS & SEALS

KITCHEN & BATH

FURNITURE & MATTRESS

JT'S STRONG ARM™



Put an end to unwanted chassis movement

Each JT's Strong Arm stabilizer tube bolts on to each landing gear leg and to the RV frame, forming a rigid triangle to eliminate unwanted chassis movement and provide a rock-solid camping experience, no welding required. The patented universal system is designed to attach to the three main types of jacks found on RVs: scissor, front landing gear and telescoping. JT's Strong Arm Jack Stabilizers come in easy bolt-on kits of four or six stabilizer tubes and include everything needed for installation.

If unit has hydraulic jacks, three #314592 jack adapter lugs are required. If unit has electric stabilizer jacks, one #314597 adapter kit needed per set of electric stabilizer jacks.

part no.	description
191023	Fifth-Wheel Kit Over 58" Between Landing Gear
191024	Fifth-Wheel Kit Under 58" Between Landing Gear
191025	Travel Trailer Kit



JT'S STRONG ARM™ JACK STABILIZER ACCESSORIES



Jack Adapter Lug: Hydraulic

2 per package: Lugs can be welded to round hydraulic foot pads to attach JT's Strong™ Arm Jack Stabilizers. Bolt-on or weld-on application. Bolts included.

314592



4" Swing Bolt Kit

Replacement bolt kit: 4" swing bolts are used on front and rear jacks to attach stabilizer bar.

314596



Spacer Mount

2 per package: Spacer kit used when Nylock nut can't be installed at the end of the bolt due to restricted access such as a chassis or floor insulation/underbelly.

314600



Silver Bullet Lifting Handle

2 per package: Threads into 4" swing bolt on front landing gear leg and can be used to manually lift front jack when needed.

314593



Electric Stabilizer Jack Pad Adapter Kit

4 per package: Used to attach stabilizers to LCI® electric stabilizer jack foot pads. One plate goes on each side of jack pad to allow electric jack to retract fully.

314597



Front Landing Gear Clevis Kit

Replacement kit: Fits around fifth-wheel front landing gear legs in order to attach stabilizer bars.

314601



T-Bolts

2 per package: Replacement T-Bolts tighten stabilizer arms. Must loosen T-Bolts before extending or retracting all jacks or else jack damage can occur.

314594



Stiffening Pads

2 per package: Use on cross members to strengthen thinner gauge material or use two to sandwich compartment floor. Place pads 1/4" from the front or back edge.

314598



T-Handle Tightening Tool

This 27-1/2" tool allows you to tighten or loosen T-Bolts without kneeling or crawling on the ground.

314602



1-1/4" Swing Bolt Kit

Replacement bolt kit: 1-1/4" swing bolts are bolted to the frame or spacer mount on units with an enclosed underbelly to attach stabilizer bar.

314595



Thread Cutting Bolt Kit

12 per package: Used to attach spacer mounts to the frame. Drill 1/8" pilot hole, then use 5/16" bit. Bolts are designed to cut through frame as you drill.

314599

ALIGNMENT,
SUSPENSION
& AXLES

LEVELING &
STABILIZATION

TOWING

CARGO,
SECURITY &
STORAGE

WASTE
MANAGEMENT

AWNINGS

STEPS

SLIDE-OUTS

HAPPYJAC

DOORS
& SEALS

KITCHEN
& BATH

FURNITURE &
MATTRESS

LANDING GEAR

Power front landing gear is standard on most fifth-wheels produced today. Shouldn't your customers have access to the same time-saving feature? Easily raise the front of a fifth-wheel RV with our universal mount Power Landing Gear.

QUICK FACTS

- Universal mount design
- 6,000-pound capacity
- 21" stroke
- Inner tube extends an additional 16"
- 1" between tube holes
- Rust-prohibitive surface on outer leg
- IP-rated switch
- Standard, high-speed & heavy-duty motor options



part no.	description
333964	6,000 lb. Universal Mount Power Landing Gear Kit (Includes legs, feet, pins, brackets, crank handle, gears, motor & switch)
333966	6,000 lb. Universal Mount Manual Landing Gear Kit (Includes legs, feet, pins, brackets, crank handle & gears)
217884	Standard Landing Gear Motor & IP-rated switch & harness
179013	Lead Universal Mount Landing Gear Leg & pin
179014	Follow Universal Mount Landing Gear Leg & Pin
276602	Aluminum Landing Gear Box for Universal Mount Legs
119225	Standard Landing Gear Foot
334096	Universal Landing Gear Cross Shaft Kit Includes (1) 1" x 1" and (1) 3/4" x 3/4" cross shaft tubes
119226	Manual Crank Handle
142178	Standard Landing Gear Motor only
145236	White IP-Rated Switch and harness only
196308	Heavy-Duty 6500 lb. Tuson Landing Gear Motor only
141893	High Speed Tuson Landing Gear Motor only
113511	Weld-on Landing Gear Leg Bracket
146060	Follow Leg Repair Kit
146059	Lead Leg Repair Kit



2 179013 Lead Leg



3 334096 Cross Shaft Kit



5 142178 Standard Motor



196308 HD Motor



217884 Power Kit



141893 High Speed Motor



113511 Bracket



146060 Follow Repair Kit



146059 Lead Repair Kit

ALIGNMENT, SUSPENSION & AXLES
LEVELING & STABILIZATION
TOWING
CARGO SECURITY & STORAGE
WASTE MANAGEMENT
AWNINGS
STEPS
SLIDE-OUTS
HAPPIJAC
DOORS & SEALS
KITCHEN & BATH
FURNITURE & MATTRESS

QUICK RELEASE PULL PINS

Standard landing gear pull pins are a pain. Simply pull the Quick Release Pull Pin and let the inside leg drop to the ground. When jacks are raised or lowered, the pin will automatically snap itself into place. No more messing with those cumbersome lynch pins. Simply pull and release.

QUICK FACTS

- Makes operating landing gear legs less cumbersome
- Quicker and easier than standard hair pin
- Bright, zinc-plated finish
- 3/8" diameter pin fits 7/16" hole
- One-time installation/ permanently attached
- Works with all type of jacks
- Bolt-on installation; no welding required



Heavy-duty spring-loaded pull pins

allow for quick height adjustment and secure hook-ups on a fifth-wheel trailer.

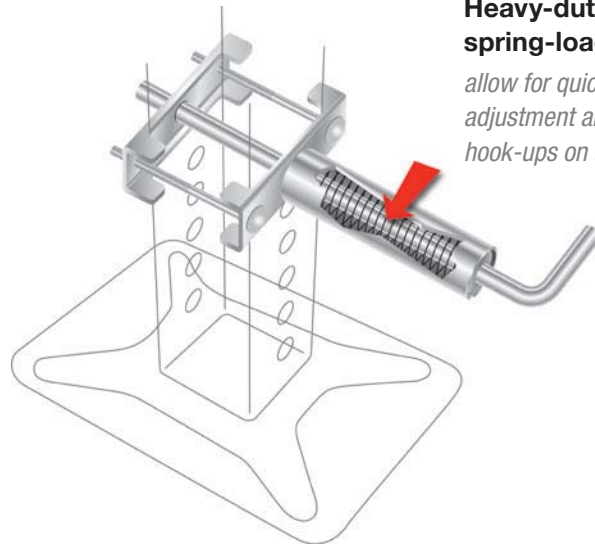

part no.	description
308287	Quick Release Pull Pins (Pair)

ALIGNMENT,
SUSPENSION
& AXLES

LEVELING &
STABILIZATION

TOWING

CARGO,
SECURITY &
STORAGE

WASTE
MANAGEMENT

AWNINGS

STEPS

SLIDE-OUTS

HAPPYJAC

DOORS
& SEALS

KITCHEN
& BATH

FURNITURE &
MATTRESS

ELEPHANT FOOT JACK PADS



Double your stability

A larger footprint means more stability and less rocking and swaying while camping. Our molded composite Elephant Foot Pads are twice the footprint of standard jack pads and increase the jack footprint to 10 inches in diameter and don't get stuck in the ground as easily as steel feet do. Easy installation.

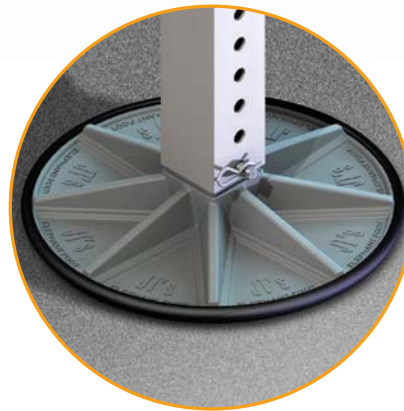

Front Landing Gear Application



Scissor & Telescoping Jack Applications

part no.	description
191386	Elephant Feet Fifth-Wheel Kit; Set of 4 Feet & Shoes
191387	Elephant Feet Travel Trailer Kit; Set of 4 Feet & Shoes
314603	Elephant Shoes (Pair)

ALIGNMENT, SUSPENSION & AXLES

LEVELING & STABILIZATION

TOWING

CARGO SECURITY & STORAGE

WASTE MANAGEMENT

AWNINGS

STEPS

SLIDE-OUTS

HAPPYJAC

DOORS & SEALS

KITCHEN & BATH

FURNITURE & MATTRESS

STANDARD JACK PADS



9" Round Jack Pad

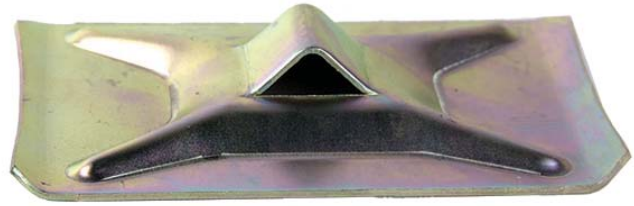

Standard Landing Gear Foot

part no.	description
314667	9" Round Landing Gear Pad (Pair)
119225	Standard Landing Gear Pad
294156	Snap Pin 3/8" x 2" – Bulk
329267	Snap Pin 3/8" x 2" – 2/pkg.

ALIGNMENT,
SUSPENSION
& AXLES

LEVELING &
STABILIZATION

TOWING

CARGO,
SECURITY &
STORAGE

WASTE
MANAGEMENT

AWNINGS

STEPS

SLIDE-OUTS

HAPPYJAC

DOORS
& SEALS

KITCHEN
& BATH

FURNITURE &
MATTRESS

TOWING

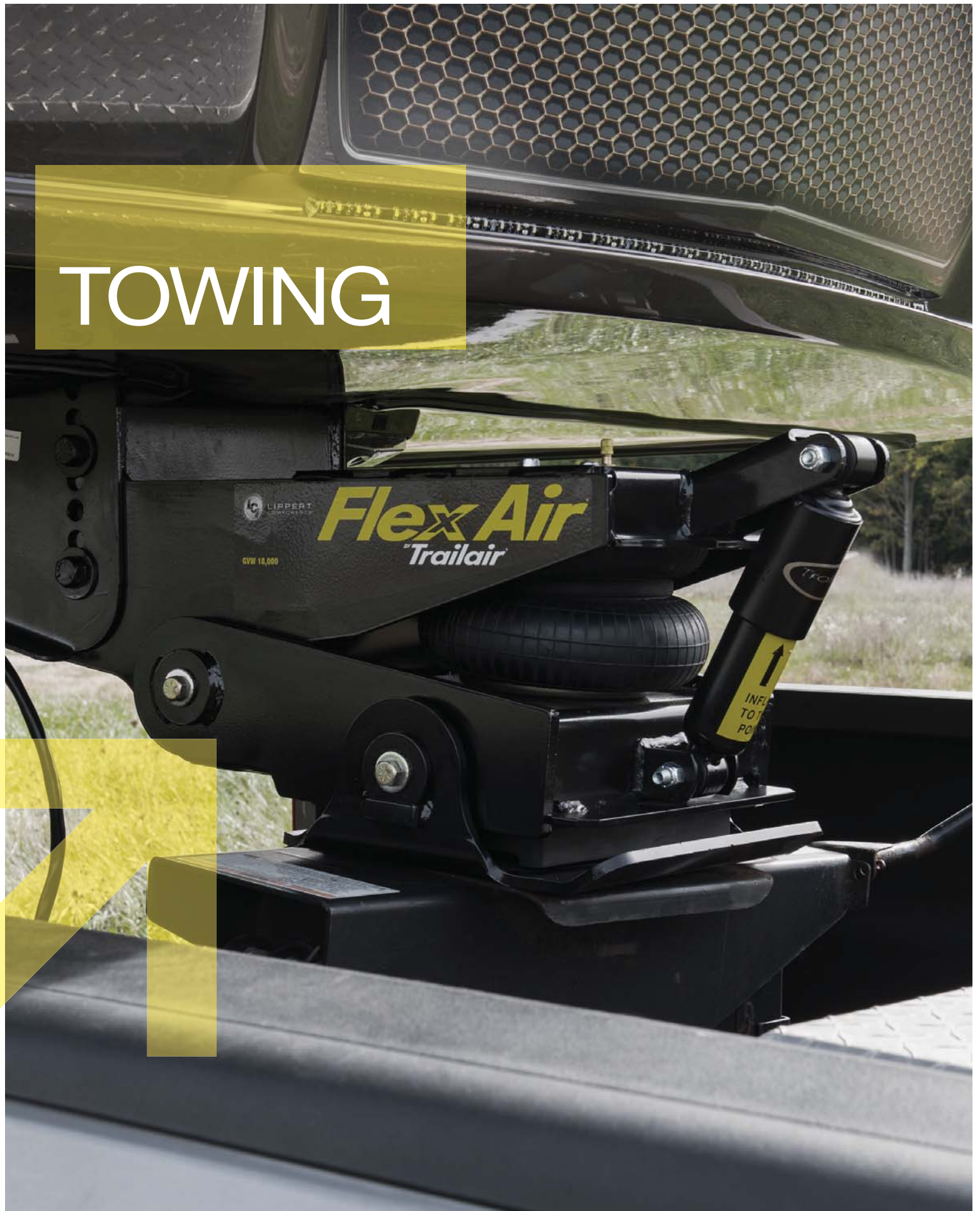

TRAILAIR® PIN BOX PROFIT PROGRAM

The Trailair Pin Box Profit Program features a complete line of pin box solutions to cover the novice weekend RVer and the full-timer RVer, who demands nothing but the best towing experience. Each Trailair pin box dampens road shock to make fifth-wheel towing more comfortable and less stressful for the driver. The in-store product display shown below makes it easy to educate customers on how to enhance their towing experience, and we can work with you to create custom web ads, email blasts and more to further support your sales efforts.

Optional monitor loops RV Doctor videos and Trailair info.



Display up to two Trailair pin boxes at a time.

Pin boxes are removable and can be sold right off the display.



ALIGNMENT,
SUSPENSION
& AXLES
LEVELING &
STABILIZATION

TOWING

CARGO,
SECURITY &
STORAGE

WASTE
MANAGEMENT

AWNINGS

STEPS

SLIDE-OUTS

HAPPYJAC

DOORS
& SEALS

KITCHEN
& BATH

FURNITURE &
MATTRESS

PIN BOX FIT-UP GUIDE

Follow these steps to determine the correct Pin Box replacement model:

Step 1:

Look for the white sticker with a 4-digit number on it. (ex. 1621 or 1716)

Step 2:

What is the GVWR of the unit?

Step 3:

Visually compare the illustration to the mounting wing on the trailer.

Step 4:

Measure length of box (front row of bolts to center of pin).

Step 5:

Measure bolt pattern (all three dimensions).

Step 6:

Measure box width.

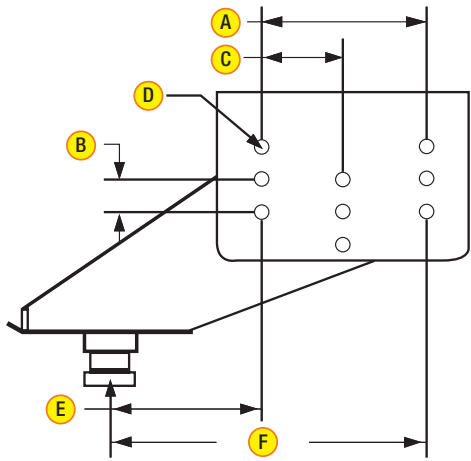

Three-Row Hole Pattern

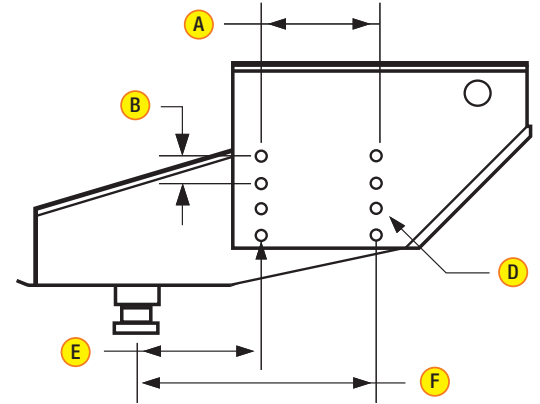
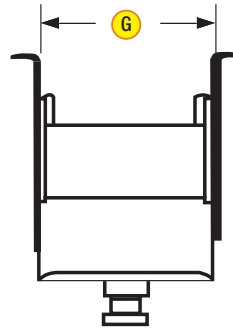

Two-Row Hole Pattern

LCI Pin Boxes

OEM part no.	LCI replacement	bolt pattern	style	horizontal distance between bolt pattern A	vertical distance between bolt pattern B	distance between rows C	bolt size D	bolt head size	front row bolts to center of kingpin E	rear row bolts to center of kingpin F	box width G
1621	L05	2-row	Long	7-3/4"	2"	n/a	5/8"	15/16"	17-3/4"	25-5/8"	12"
0719	M15	2-row	Medium	7-3/4"	2"	n/a	5/8"	15/16"	9"	16-7/8"	12"
1716	L07	3-row	Long	8-3/4"	2-1/2"	4-3/8"	5/8"	15/16"	20-3/8"	29-1/8"	12-1/2"
1116	M19	3-row	Medium	8-3/4"	2-1/2"	4-3/8"	5/8"	15/16"	14-5/8"	23-1/4"	12-1/2"

NOTE: We realize there are many different pin boxes on the market. If your pin box does not match up to these specs, please feel free to contact your customer service representative.

ALIGNMENT, SUSPENSION & AXLES
LEVELING & STABILIZATION
TOWING
CARGO SECURITY & STORAGE
WASTE MANAGEMENT
AWNINGS
STEPS
SLIDE-OUTS
HAPPYJAC
DOORS & SEALS
KITCHEN & BATH
FURNITURE & MATTRESS

The most comfortable towing experience

The Flex Air Pin Box combines LCI's time-tested Trailair® Air Ride technology with its Rota-Flex® pivoting head to significantly reduce fore-to-aft movement and vertical tug-of-war between a fifth-wheel RV and tow vehicle, providing the user a more comfortable ride. The Flex Air Pin Box utilizes an air bag to absorb road shock and vibrations, a rubberized compound to soften jarring motion, and an oil shock absorber to handle rebound action, dampen kickback and control chucking.



Flex Air

part no.	description
328484	M15 18K Flex-Air, Med. Tow
328492	L05 18K Flex Air, Long Tow



1 Air Ride Technology

The air bag acts as a buffer between the tow vehicle and coach to absorb road shock and vibrations that can damage an RV.



2 Oil Shock

As the air bag absorbs road shock and vibration, the oil shock absorber handles rebound action, dampening kickback.



3 Pivoting head

The heavy-duty pivoting head in the lower jaw controls the vertical tug-of-war between the tow vehicle and fifth-wheel RV.



4 Rubberized compound

The durable rubberized compound provides an additional buffer to help protect the fifth-wheel RV from jarring motion.

AIR RIDE™ & ROTA FLEX™ PIN BOXES

Enhance your towing experience

AirRide

part no.	description
171200	L05 Air Ride Pin Box; 16K <i>(replaces LCI 1621 Pin Box)</i>
155930	L05 Air Ride Pin Box; 18K <i>(replaces LCI 1621 Pin Box)</i>
158778	Long Jaw Air Ride Pin Box; 21K <i>(replaces LCI 1716 Pin Box)</i>
155933	L07 Air Ride Pin Box; 21K <i>(replaces LCI 1716 Pin Box)</i>
179879	M15 HD Air Ride Pin Box; 18K <i>(replaces LCI 0719 Pin Box)</i>
155943	M19 Air Ride Pin Box; 21K <i>(replaces LCI 1116 Pin Box)</i>



- Air bag acts as a buffer between the tow vehicle and coach to absorb road shock and vibrations
- Oil shock absorber handles rebound action, dampening kickback and controlling chucking



Rota-Flex vs. MOR/ryde® Pin Boxes Accelerated Frame Chatter

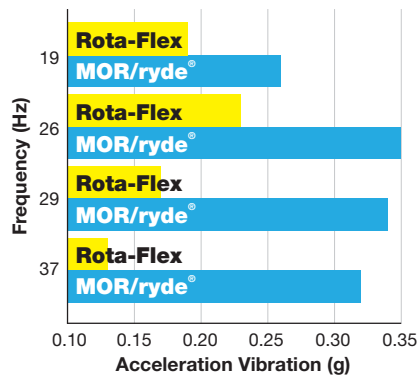

■ Rota-Flex Pin Box Standard Suspension
■ Mor/Ryde Pin Box Standard Suspension



- Pivoting head controls vertical tug-of-war between tow vehicle and RV
- Durable rubberized compound absorbs motion and vibration caused by road shock

ROTA-FLEX™ Trailair

part no.	description
328330	Rota-Flex 1621 Pin Box; 18K
176440	Rota-Flex 1116 Pin Box; 19K
328329	Rota-Flex 1621 SHD Pin Box; 21K

ALIGNMENT,
SUSPENSION
& AXLES

LEVELING &
STABILIZATION

TOWING

CARGO,
SECURITY &
STORAGE

WASTE
MANAGEMENT

AWNINGS

STEPS

SLIDE-OUTS

HAPPYJAC

DOORS
& SEALS

KITCHEN
& BATH

FURNITURE &
MATTRESS

STANDARD PIN BOXES

LCI pin boxes are the industry standard. Each pin box has a rust-resistant powder-coated surface. Please consult your original equipment label before purchasing a new LCI pin box.



1621 Pin Box Shown

LCI Pin Boxes

part no.	description
1270271	1116 Retracted Pin Box, 19K
1191191	1621 Standard Pin Box, 15.5K
1191151	1621 HD Pin Box, 18K
1387883	1621 SHD Pin Box, 21K
1324791	1716 Retracted Pin Box, 15.5K

ALIGNMENT,
SUSPENSION
& AXLES

LEVELING &
STABILIZATION

TOWING

CARGO,
SECURITY &
STORAGE

WASTE
MANAGEMENT

AWNINGS

STEPS

SLIDE-OUTS

HAPPYJAC

DOORS
& SEALS

KITCHEN
& BATH

FURNITURE &
MATTRESS

STANDARD PIN BOX COVERS

Give any RV an upgraded look with our stylish Pin Box covers. Available in gray, white and black, our Pin Box covers are easy to install on LCI 1621 pin boxes, which are standard on most fifth-wheel RVs.



part no.	description
301458	1621 Pin Box Cover (White)
301459	1621 Pin Box Cover (Black)
301460	1621 Pin Box Cover (Gray)



ALIGNMENT,
SUSPENSION
& AXLES

LEVELING &
STABILIZATION

TOWING

CARGO
SECURITY &
STORAGE

WASTE
MANAGEMENT

AWNINGS

STEPS

SLIDE-OUTS

HAPPYJAC

DOORS
& SEALS

KITCHEN
& BATH

FURNITURE &
MATTRESS

STRAPTEK™ WEIGHT DISTRIBUTION TECHNOLOGY

THROW YOUR CHAINS AWAY

Straptek™ simplifies weight distribution hitch systems for trailers by employing a ratchet winch and heavy-duty polyester straps instead of traditional chains and snap-up brackets. Straptek allows users to safely adjust weight distribution spring bars on their trailer with a standard socket wrench. It also provides sway control and is compatible with most weight distribution hitch systems.

Easier Adjustment

Standard weight distribution systems (WDS) require raising the tow vehicle with a tongue jack over and over in order to get the right tension. Straptek adjusts by simply tightening or loosening the heavy-duty polyester straps with a standard socket wrench, saving time and energy.

Safer Adjustment

Standard WDS spring bars can bear hundreds of pounds of built-up pressure. When unhooking a trailer, an RVer must eventually unlatch the snap up chains using a lifting accessory. If too much tension remains on the spring bars, they can snap back and cause serious injury. Straptek does away with chains and can be adjusted and readjusted using an easy-to-use ratchet and winch system.

Controls Sway

A standard WDS system requires at least 7-1/2 inches of extra chain between the snap-up hook and the spring bar. Straptek's low-profile design reduces the pendulum length by about half, providing increased sway control. Straptek reduces the anxiety that comes with the dangerous trailer movement sometimes allowed by traditional chain and bracket systems.



Standard weight distribution systems can require raising and lowering the tow vehicle with a jack over and over to get the right tension.



Straptek adjusts by simply tightening or loosening the heavy-duty polyester straps with a standard socket wrench, saving time and energy.

QUICK FACTS

- Integrates with most WDS hitches on the market; will not function with Equal-i-zer® Sway Control Hitches
- Attaches to any tubular or C-Channel frame trailers
- 1-1/8" socket head attachment required (not included)
- Spring bars and hitch sold separately
- Kit includes two Straptek Tensioner Assemblies, two straps and attachment bolts

part no.	description
335852	Straptek Tensioner Kit

ALIGNMENT,
SUSPENSION
& AXLES

LEVELING &
STABILIZATION

TOWING

CARGO,
SECURITY &
STORAGE

WASTE
MANAGEMENT

AWNINGS

STEPS

SLIDE-OUTS

HAPPYJAC

DOORS
& SEALS

KITCHEN
& BATH

FURNITURE &
MATTRESS

CARGO, SECURITY & STORAGE



JACK-IT™ DOUBLE BIKE CARRIER

JACK-IT™

Ever wished you could see your bikes from your rear view mirror as you tow your travel or cargo trailer down the road? Now you can with the Patented Jack-It™ double bike carrier from Let's Go Aero®. The Jack-It's innovative frame design installs over the tongue jack on the trailers A-Frame, the softest riding area on the frame. The BikeWing™ carrier holds two bikes safely, securely and simply by the wheels.

The adjustable wheel cradles and SwayStop straps secure the bike wheels to the bike carrier for a secure ride. The Jack-It allows travel trailer owners to utilize the valuable rear hitch/cargo space for additional gear and gives owners a new cargo utilization space.

QUICK FACTS

- 25-pound total weight
- Fits most A-Frame travel and cargo trailers
- Frees up travel trailer's rear hitch/cargo area
- Fits all bike frames
- Carries your bikes by the wheels for balance, stability and ease of use.
- PowerTower frame protects tongue jack from impact
- Optional accessory allows for conversion onto Lippert Component's TailGate® Storage System
- Will not void chassis warranty
- Optional accessory doubles BikeWing as a hitch rack
- Includes (2) SwayControl cradles, (2) Lockable NoMotion™ pins and (3) 3/8"-16 1-1/2" bolts



part no.	description
429756	Jack-It Bike Rack

ALIGNMENT,
SUSPENSION
& AXLES

LEVELING &
STABILIZATION

TOWING

CARGO
SECURITY &
STORAGE

WASTE
MANAGEMENT

AWNINGS

STEPS

SLIDE-OUTS

HAPPYJAC

DOORS
& SEALS

KITCHEN
& BATH

FURNITURE &
MATTRESS

TOYLOK® ANTI-THEFT DEVICE

Loop it, lock it and leave it.

Lock up the bike, ATV, grill, generator, camp chairs, dirt bike— just about anything — with the ToyLok anti-theft device. Simply bolt ToyLok onto the RV chassis, hitch or bumper and easily secure valuable personal property outside by extending the self-retracting cable, looping it through valuables and locking it with the heavy-duty padlock.



QUICK FACTS

- Weighs only 5.5 pounds
- Easy bolt-on application
- 8,000-pound capacity cable
- Built-in clutch prevents cable snap back while retracting
- Features padlock, 2 keys and 15-foot PVC-coated cable
- Internal braking and pulley system allows users to choose the optimal cable length
- Easy bolt-on hardware kit includes two 1/4" 28 tpi x 3" bolts with security nuts

Optional mounting kits for every application



Receiver hitch



Truck stake pocket



Trailer bumper



ATV/UTV



Tool box

part no.	description
337120	Toylok Anti-Theft Device; Nylon Nylon Casing; Padlock included
337118	Toylok Anti-Theft Device; Steel Steel Casing; Padlock not included
337111	Toylok Hitch Mounting Kit Fits 1-1/4" or 2" receivers; Hardware included
337112	Truck Mounting Adapter Mounts in truck stake pocket; protective pad and hardware included
337113	RV Bumper Mount Adapter Designed to fit most 4" square RV bumpers
337114	ATV/UTV Mount; Front/Rear Attaches to front or rear rack
337117	Tool Box Mount Adapter Includes hole saw, grommet and label
337110	Toylok Repair Kit



337111



337112



337113



337114



337117



337110

ALIGNMENT, SUSPENSION & AXLES
LEVELING & STABILIZATION
TOWING
CARGO SECURITY & STORAGE
WASTE MANAGEMENT
AWNINGS
STEPS
SLIDE-OUTS
HAPPYAC
DOORS & SEALS
KITCHEN & BATH
FURNITURE & MATTRESS

UNDERCHASSIS STORAGE SYSTEM

Underchassis Storage Systems help RVers save space and fit everything they need in their home away from home.



Optional spare tire winch option available (tire not included)



Includes two detachable molded storage boxes

Storage bin dimensions:
27.875" L x 17" W x 8" D

Rust-resistant
surfaces on steel parts

Each bin can
store up to 100 pounds

Spring-loaded latch
allows storage
compartment to easily
slide in and out

part no.	description	dimensions
236558	Underchassis Storage Container; Double; No Tire Carrier	99.5" L x 19.125" W x 10.1875" D
125460	Underchassis Storage Container; Double; With Spare Tire Carrier	99.5" L x 19.125" W x 8.28" D
175180	Underchassis Storage Container; Double; No Tire Carrier	96" L x 19.125" W x 8.28" D
159056	Spare Tire Winch (Only)	6.5" L x 2.5" W x 6" D



159056 Winch Only

TV LIFT SYSTEM



This TV Lift is a great way to save on counter space and an impressive way to display a TV. The lightweight system is easy to install and program, and smart technology shuts the motor off in case of obstruction.



Convenient remote control included



Includes mounting hardware; easily mounts to cabinet, fireplace, counter, etc.†

QUICK FACTS

- Patented worm rail design efficiently moves TV up and down
- Easy one-button programming; use the same button to program two stopping points; programming takes less than one minute
- Lifts TVs weighing up to 200 pounds
- Requires less depth than other systems
- Wireless remote and manual switch included
- 10-foot wiring harness allows flexible installation
- Perfect for the home as well
- Can be used for other applications, such as cabinets, etc.

part no.	description
309690	TV Lift System with RF Remote

†Hardware included will mount TV Lift system and motor to desired mounting location. Hardware to mount TV sold separately. Please consult your TV's owner's manual for correct bolt dimensions.

ALIGNMENT, SUSPENSION & AXLES
LEVELING & STABILIZATION
TOWING
CARGO SECURITY & STORAGE
WASTE MANAGEMENT
AWNINGS
STEPS
SLIDE-OUTS
HAPPYJAC
DOORS & SEALS
KITCHEN & BATH
FURNITURE & MATTRESS

KWIKEE® CARGO TRAYS

Customize for easy access to storage

KwikEE Cargo Trays make accessing storage so much easier. RVers can stop climbing into deep storage compartments or straining to reach items in the back. Instead they can simply slide out the tray and grab what they need. Industrial grade ball-bearing slides keep trays gliding smoothly and allow them to extend all the way out. You customize the KwikEE Cargo Trays to perfectly fit each customer's storage compartments using plywood. Once installed, cover with carpet, rubber matting or vinyl.



How to Measure

1. To select slide size (length), measure depth of compartment.

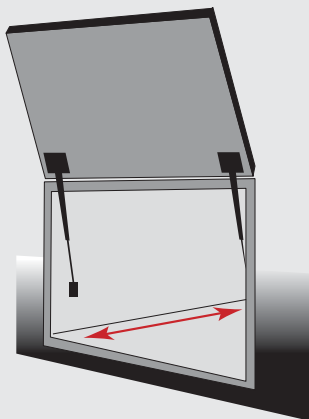

2. Determine desired width, allowing 4" for frame sides. Cut a section of 3/4" plywood (not supplied) and both trim pieces (if needed). Attach plywood to inner slide frame.
3. Square outer slide frame. Mark support holes, drill, and secure outer frame through the basement floor.

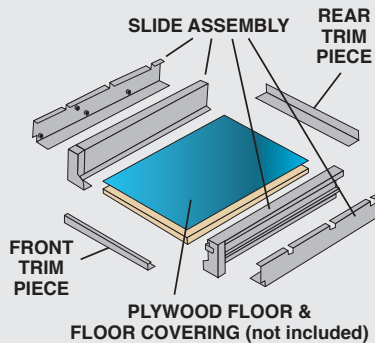

4. Cover plywood with carpet, rubber mat, or vinyl (not supplied).

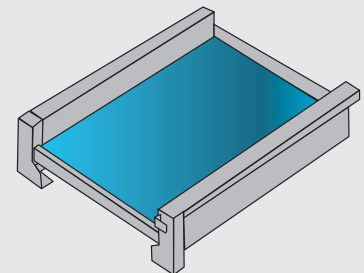

ALIGNMENT,
SUSPENSION
& AXLES

LEVELING &
STABILIZATION

TOWING

CARGO,
SECURITY &
STORAGE

WASTE
MANAGEMENT

AWNINGS

STEPS

SLIDE-OUTS

HAPPYJAC

DOORS
& SEALS

KITCHEN
& BATH

FURNITURE &
MATTRESS

Heavy-Duty Slide



Shown as packaged



Flooring not included;
Shown as installed

QUICK FACTS

- Industrial grade ball-bearing slide
- 200-400-pound weight capacity
- Safety latch holds platform secure during travel and when fully extended
- Made with heavy-gauge steel and powder-coated finish
- Optional trim kit sold separately

part no.	description	capacity	latches
378870*	16" Heavy-Duty Slide	200 lbs.	Right Side
370793	22" Heavy-Duty Slide	200 lbs.	Right Side
370794	22" Heavy-Duty Slide	400 lbs.	Right Side
378956*	30" Heavy-Duty Slide	200 lbs.	Right Side

*You determine width with plywood. Trim Kit optional.

Super Slide I



Flooring not included;
shown as installed



Shown as packaged

QUICK FACTS

- 1,000-pound capacity cargo hauler with roller-bearing action
- Ships with U-Channel and L-Bracket for trim and stiffener
- If longer trim is needed, order from trim kit listing and cut to fit
- Fits almost any sub-floor compartment
- A spring-loaded latch locks the slide in three positions
- Color-matched trim pieces available for the deck
- Width is defined by the size of the compartment

part no. w/o trim kits	part no. with trim kits included	description	capacity	latches
370770	370773 (37.75")	36" Super Slide I	1,000 lbs.	3-position
370763	370764 (37.75")	42" Super Slide I	1,000 lbs.	3-position
379973	370765 (48")	48" Super Slide I	1,000 lbs.	3-position
n/a	370769 (46")	54" Super Slide I	1,000 lbs.	3-position
379904*	379811* (46")	60" Super Slide I	1,000 lbs.	3-position
379507*	370774 (46")	70" Super Slide I	1,000 lbs.	3-position
370775	380272* (46")	90" Super Slide I	1,000 lbs.	2-way slide
370778	370780 (46")	80" Super Slide I	1,000 lbs.	2-way slide

*You determine width with plywood. Trim Kit optional for P/N w/o trim kits. For P/N with trim kit included, size of trim kit is specified in parenthesis.

Trim Kits for Heavy-Duty & Super Slide I

part no.	description
380319	32" Trim Pieces
380318	48" U-Channel

KWIKEE® CARGO TRAYS

Super Slide II



Flooring not included; shown as installed



Shown as packaged

part no.	description	capacity	pulls
378806*	36" Super Slide II	800 lbs.	1-way slide
370782	42" Super Slide II	800 lbs.	1-way slide
370783	48" Super Slide II	800 lbs.	1-way slide
370785	54" Super Slide II	800 lbs.	1-way slide
370787	60" Super Slide II	800 lbs.	1-way slide
370761	80" Super Slide II	800 lbs.	2-way slide
370762	90" Super Slide II	800 lbs.	2-way slide

*You determine width with plywood. Trim kit required.

QUICK FACTS

- Heavy-duty roller bearings
- 800-pound weight capacity
- One-direction slides lock in closed position
- Two-way slides lock in center
- Corrosion-resistant roller bearing action
- Compartment depths from 36" to 90"

Trim Kits for Super Slide II

part no.	trim kit end piece width	compartment opening
370669	17"	21"
380150*	19"	23"
370672	21"	25"
370674	23"	27"
370676	24"	28"
370678	27"	31"
370680	30"	34"
370682	32"	36"
370684	33"	37"
370688	36"	40"
370690	37"	41"
370692	39"	43"
379805*	41"	45"
370753	42"	46"
370755	44"	48"
370757	48"	52"
370759	51"	55"



Shown as packaged

Trim kit is required for Super Slide II. Order trim kit to desired compartment width less 4" (see chart). Trim kit includes (2) end trim pieces, jig kit, and (3) mid-rails. You add the plywood and carpet.

ALIGNMENT,
SUSPENSION
& AXLES

LEVELING &
STABILIZATION

TOWING

CARGO
SECURITY &
STORAGE

WASTE
MANAGEMENT

AWNINGS

STEPS

SLIDE-OUTS

HAPPYAC

DOORS
& SEALS

KITCHEN
& BATH

FURNITURE &
MATTRESS

Battery Trays

- Fully assembled
- Smooth ball-bearing and roller-bearing movement
- Powder-coated finish
- Trays lock securely in stowed position
- Safety latch locks slide
- Holds 1 to 8 batteries



part no.	outside dimensions			inside dimensions		weight capacity
366333	15-1/2"	15-1/8"	3-3/8"	14"	13"	130 lbs.
366485	14-9/16"	15-1/2"	3-5/16"	13"	14-1/4"	130 lbs.
366345	15-3/8"	13"	2-1/2"	14"	12-1/8"	130 lbs.
366357	16-1/8"	13"	2-1/2"	14-3/4"	12-7/64"	130 lbs.
366502	14-9/16"	16-3/8"	3-3/8"	13"	15-1/8"	130 lbs.
366329	15-13/16"	24"	3-3/16"	13-3/8"	21-3/8"	200 lbs.
366342	16-9/16"	16-13/16"	3-3/16"	14-1/4"	14-1/4"	200 lbs.
366331	25-1/8"	24-13/16"	3-3/16"	22-7/8"	22-7/8"	200 lbs.
366332	22-1/4"	15-1/4"	3-1/16"	20"	13-7/8"	200 lbs.
366328	16-15/16"	22-5/8"	3-3/16"	14-3/8"	21"	200 lbs.
366499	24-9/16"	18-5/16"	3-3/16"	22-1/8"	17-1/8"	200 lbs.

*Inside dimension is for battery configuration; outside dimension is for compartment fit.



Battery strap available for replacement; solid metal hooks at each end and adjustable buckle for easy access

part no.	description
366325	Battery Strap

Freezer/Refrigerator Trays



- Opening in bottom accommodates drainage and circulation
- Smooth ball-bearing and roller-bearing movement
- Safety latch locks slide
- Tray comes assembled

part no.	outside dimensions			inside dimensions		weight capacity
379870	33-3/4"	28-1/16"	3-11/16"	31-1/2"	20-1/8"	200 lbs.
380021*	16-3/4"	28-1/16"	3-11/16"	14-1/2"	25-1/2"	200 lbs.
380009*	27-1/2"	18-1/16"	3-11/16"	25-1/4"	14-5/8"	200 lbs.

*Inside dimension for freezer/refrigerator size; outside dimension for compartment fit



WASTE MANAGEMENT

WASTE MANAGEMENT PROFIT PROGRAM

We Make it Easy.
You Make the Sale.



*shelving not included

RV Waste Management Profit Center Program

Lippert Components is offering a new RV Waste Management Profit Center program featuring the 360 Siphon® RV holding tank vent cap, Waste Master® RV waste management system and Flow Down™ RV drain support system, all backed by comprehensive marketing support to ensure your success

- Durable, patented product technology
- Eye-catching, shelf-ready packaging
- Compelling product display header
- Digital product awareness campaign
- Custom web ads, email blasts and more



ALIGNMENT, SUSPENSION & AXLES
LEVELING & STABILIZATION
TOWING
CARGO, SECURITY & STORAGE
WASTE MANAGEMENT
AWNINGS
STEPS
SLIDE-OUTS
HAPPYJAC
DOORS & SEALS
KITCHEN & BATH
FURNITURE & MATTRESS

WASTE MASTER®

Goodbye, stinky slinky

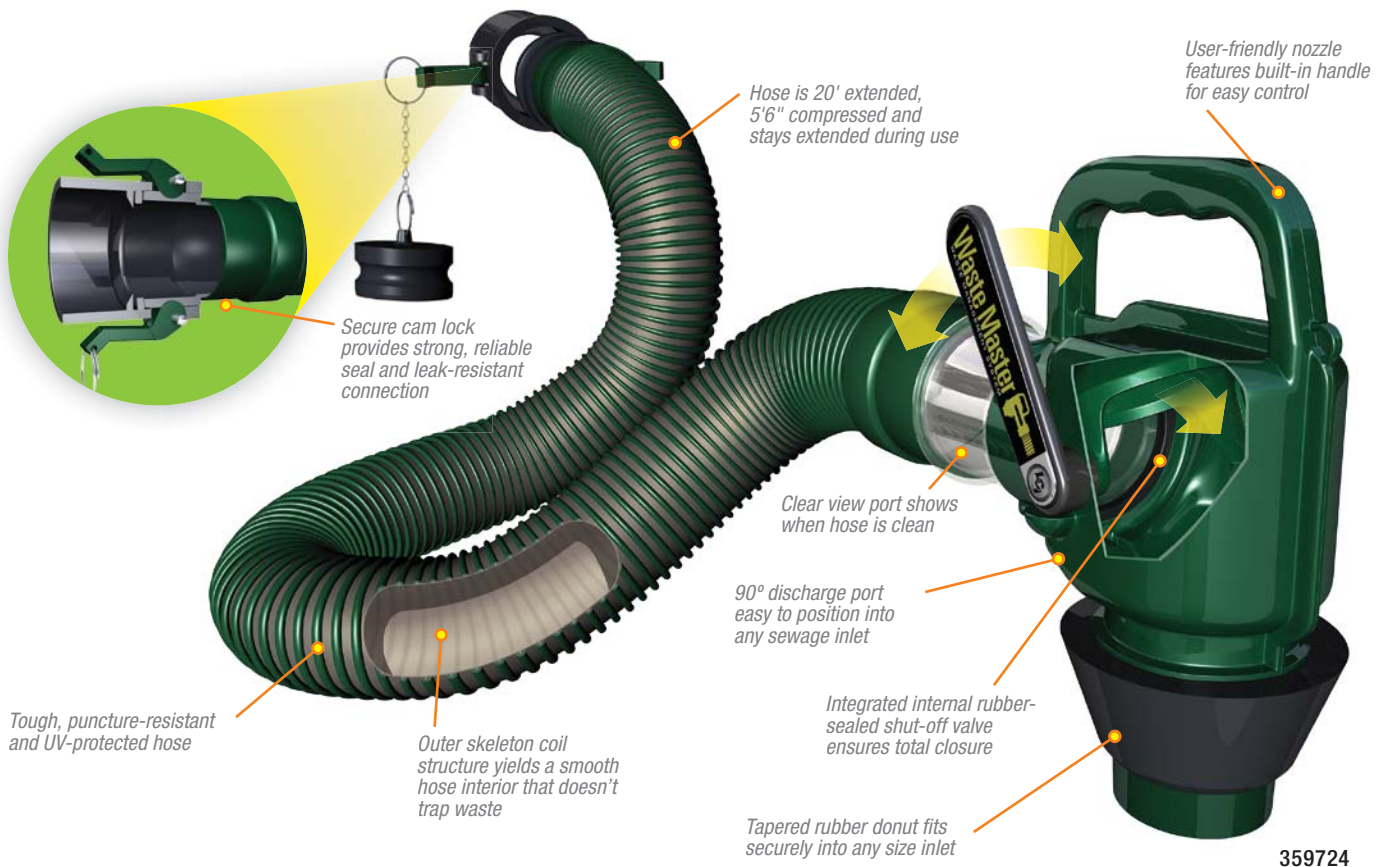

359724



Secure Cam Lock

The Waste Master isn't just a hose and nozzle, it comes complete with a time-tested cam lock connector that ensures a leak-resistant connection to the sewer outlet. Traditional RV hose bayonet fittings can leak, but industrial grade cam locks have been used in the liquid transportation industry for decades and are proven to provide a strong, reliable seal.



Tough Clean Hose

Unlike traditional hose coils that trap debris, the patented Waste Master hose is designed with its helical coil on the outside, while the inside is much smoother, preventing waste from getting trapped inside the hose. The UV-protected hose is 5' 6" compressed and 20' extended and features technology that keeps it extended during use to the exact length required.



User-Friendly Nozzle

The permanently-connected nozzle is molded with an easy-grip handle, an integrated shut-off valve and a clear view port that allows the user to see when waste has completely evacuated, helping ensure the tanks and hose are clean. The nozzle also features a 90 degree discharge port that is easy to fit and secure into any sewage inlet.

ALIGNMENT,
SUSPENSION
& AXLES

LEVELING &
STABILIZATION

TOWING

CARGO
SECURITY &
STORAGE

WASTE
MANAGEMENT

AWNINGS

STEPS

SLIDE-OUTS

HAPPIJAC

DOORS
& SEALS

KITCHEN
& BATH

FURNITURE &
MATTRESS

WASTE MASTER® ACCESSORIES

part no.	description
359724	Waste Master Cam Lock Adapter Kit – 20'
360782	20' Hose Nozzle Assembly without Cam Lock Fitting
360784	20' Extension for Waste Master Cam Lock Adapter Kit
360785	Male Cam to Male Bayonet Fitting
360578	Cam Lock Assembly with Black Cap
360788	Male Cam Garden Hose Adapter
360789	Tote Tank adapter Kit
362886	3" Cam Lock Male/Female - Threaded Fitting
376294	20' Hose Assembly with Cam Lock Fitting



360782



360784



360785



360578



360788



360789



362886



376294

part no.	description
363201	Female Cam by Female Cam with Caps
349521	Sewer Nozzle
340919	Donut Seal for Nozzle
360807	Replacement Seal Kit for Nozzle
360808	Replacement Seal for Female Cam Lock Fitting
359954	Male Cam Cap
360806	3" Flexible Rubber Coupling with SS Hose Clamps
362881	Nozzle Enclosure with Door & Frame Assembly
363357	Deluxe Storage Plug for Waste Master Hose



363201



349521



340919



360807



360808



359954



360806



362881



363357

ALIGNMENT,
SUSPENSION
& AXLES

LEVELING &
STABILIZATION

TOWING

CARGO,
SECURITY &
STORAGE

WASTE
MANAGEMENT

AWNINGS

STEPS

SLIDE-OUTS

HAPPYJAC

DOORS
& SEALS

KITCHEN
& BATH

FURNITURE &
MATTRESS

FLOW DOWN™



Adjustable RV drain support system

The Flow Down™ adjustable RV drain support system keeps your drain hose up off of the ground and easily adjusts to nearly any slope, preventing sewage from getting trapped in the hose. This premium system eliminates odor by preventing waste buildup and protects your hose from damage. No more carrying lumber, rocks or modified PVC pipe to hold your hose up off the ground. The legs of each section can be simply adjusted using the knobs, and the kit can also be set to safely pivot the hose around obstructions. One kit extends to more than 10 feet and it can be easily expanded to 20 feet by adding a second kit.



part no.	description
365053	Flow Down
365051	Single Ended Half Pipe Connector, Flow Down
365052	Double Ended Half Pipe Connector, Flow Down
365046	30" Section Half Pipe, Flow Down
365045	10" SQ Shaft Legs, Flow Down (Sold Each)
365044	Flow Down Embroidered Carry Bag



Custom setting to turn corners and level to nearly any uneven surface



Smooth, 30" half pipe support sections prevent waste buildup and protect the hose

ALIGNMENT,
SUSPENSION
& AXLES

LEVELING &
STABILIZATION

TOWING

CARGO,
SECURITY &
STORAGE

WASTE
MANAGEMENT

AWNINGS

STEPS

SLIDE-OUTS

HAPPIJAC

DOORS
& SEALS

KITCHEN
& BATH

FURNITURE &
MATTRESS



Eliminate tank odors from the source

The 360 Siphon® RV holding tank vent cap eliminates odors from the source — the holding tanks — and exhausts them out through the roof vent before they have a chance to invade the RV living space. By design, the patented 360 Siphon can only create an updraft, expelling odors and fostering an oxygen-rich environment to speed up waste breakdown. Breathe easier and enjoy a healthy, odor-free living environment with the 360 Siphon.

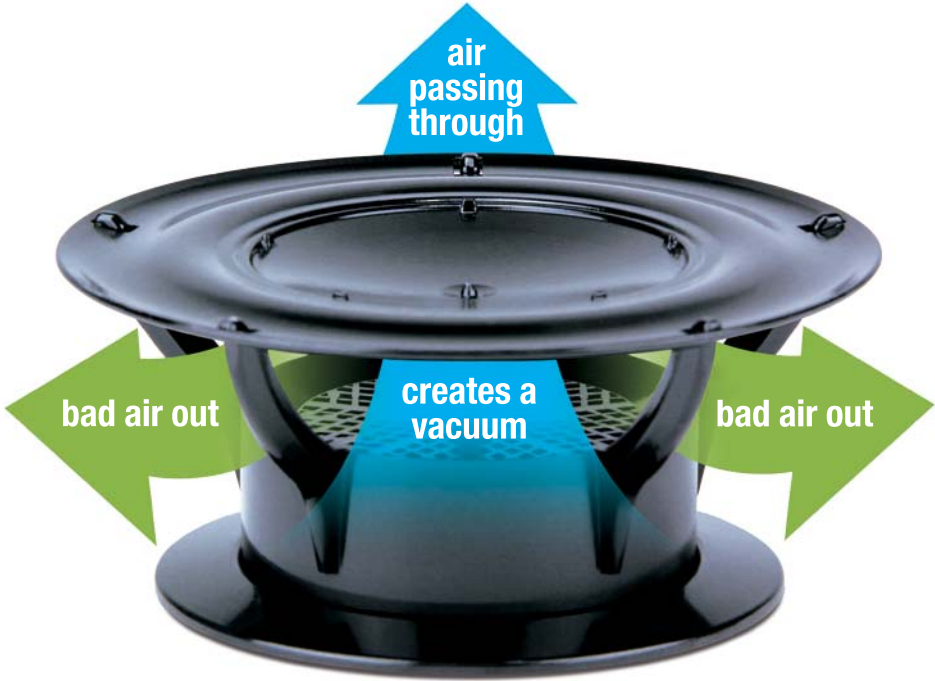

FEATURES

- Sophisticated, patented design with no moving parts
- Made in America of strong polycarbonate
- Easy installation and universal fit
- Works in any wind condition
- Built-in bug screen
- No maintenance

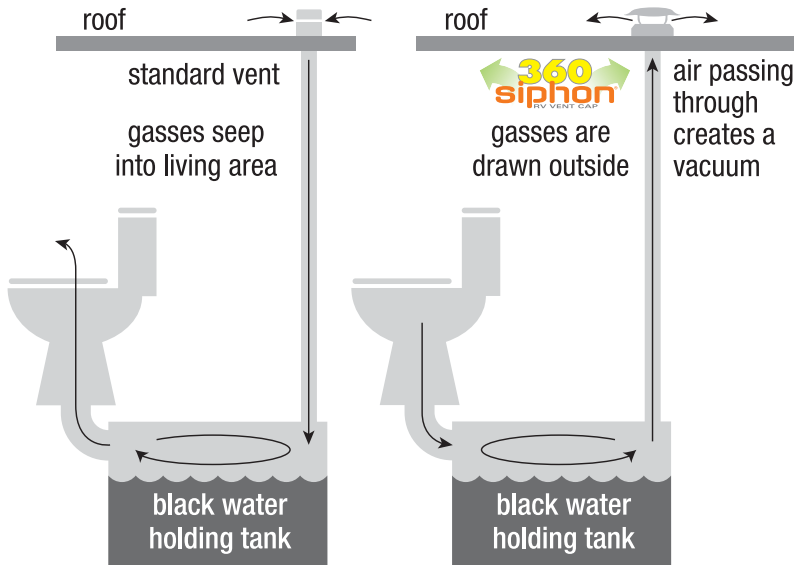

part no.	description
389381	360 Siphon Roof Vent White
389380	360 Siphon Roof Vent Black

AWNINGS

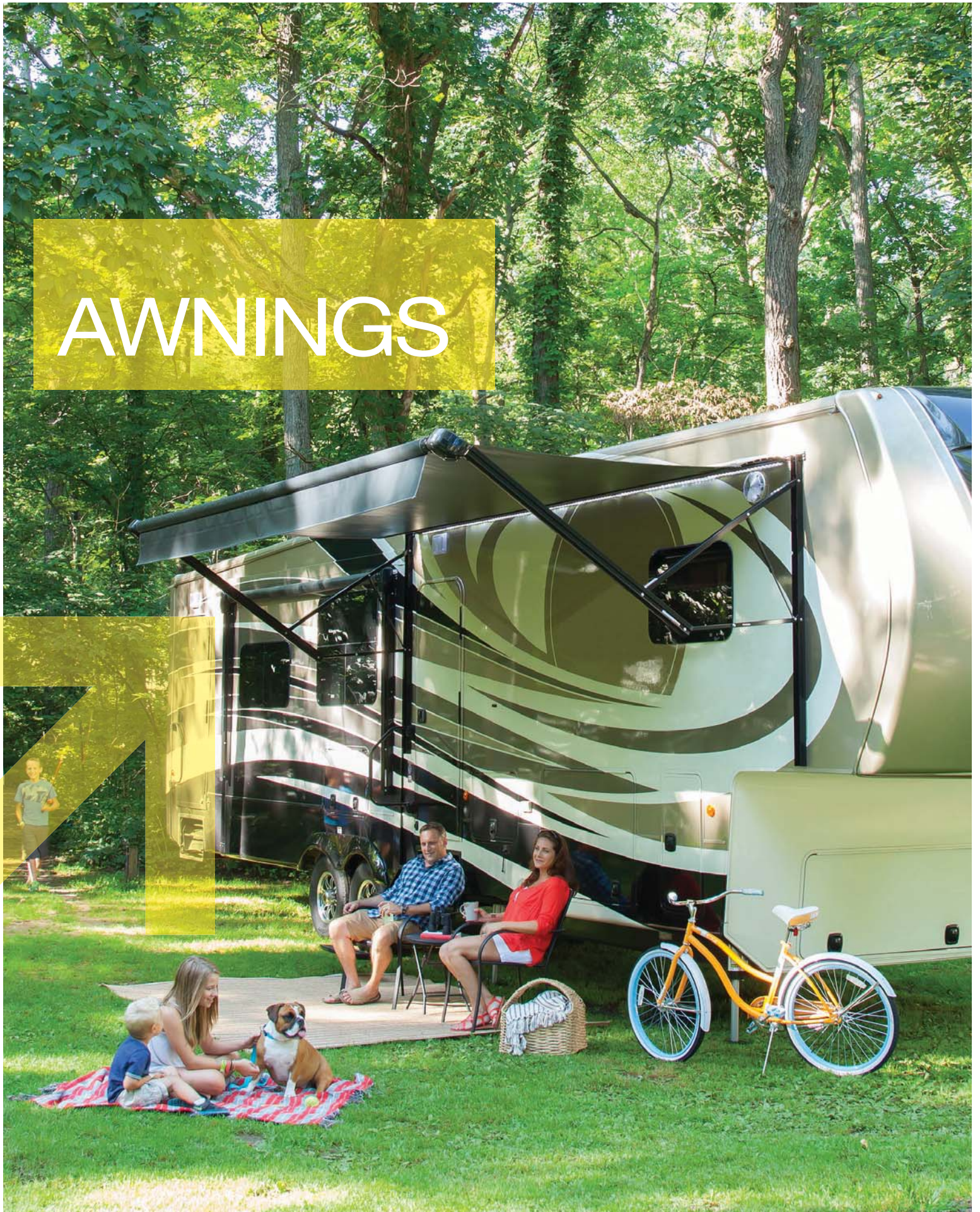

Solera Awnings by Lippert Components offer so much more than shade and shelter with a range of unique awning styles, sizes and options including awning lights, speakers and multiple fabric and hardware color options to complement the colors in your RV's exterior graphics. Nothing gives an RV a more noticeable facelift than installing a new awning or replacing the awning fabric, so choose the best – choose Solera.



AMERICA'S FASTEST GROWING BRAND OF RV AWNINGS



POWER UP

SOLERA: **POWER**



FIX IT

SOLERA: **CLASSIC**



UPGRADE

SOLERA: **HYBRID**



**THE FIRST!
XL 9'8"
PROJECTION**

GO LARGE

SOLERA: **DESTINATION**
SOLERA: **XL**

SOLERA POWER AWNINGS

ALIGNMENT, SUSPENSION & AXLES
LEVELING & STABILIZATION
TOWING
CARGO, SECURITY & STORAGE
WASTE MANAGEMENT
AWNINGS
STEPS
SLIDE-OUTS
HAPPIJAC
DOORS & SEALS
KITCHEN & BATH
FURNITURE & MATTRESS

POWER UP

Isn't it time you made the switch from a manual spring-loaded awning to something easier? Stop wasting time and energy with manual awnings! With our new universal hardware, you can now easily swap your old spring-loaded awning and POWER UP with one of three easy-to-use Solera awnings by Lippert Components. Choose between full or partial extensions for sunlight coverage at any hour of the day. With stress-free setup and operation, Solera awnings leave you with more time to relax and enjoy yourself. POWER UP today, and save the stress for your day job.



NOTE: All awnings available from 10' to 21' widths in 1' increments

Power Awning Kit Includes

- Two arms
- Switch & wiring harness
- Fasteners

*Power Pack not available for Solera XL Awnings.

- Super easy operation: operates with push button mounted inside RV
- Enjoy full or partial extension
- Exclusive, quick and simple independent pitch adjustment
- Easy access manual override
- Auto rain dump feature – if water pools in the canopy, the arms will release it
- Designed to provide optimum pitch when used over slide-outs
- Optional Solera Power Pack perfect for DIY installs – eliminates wiring to RV
- Wide selection of quality vinyl and woven acrylic fabrics available with aluminum Solera Shield®
- Choose the XL 10' projection canopy – perfect shade for tall motorhomes and fifth-wheel RVs

Solera® Power Hardware

SHORT ARM	TALL ARM	XL ARM
Adjustable Pitch <ul style="list-style-type: none"> • Requires 60-1/2" unobstructed area from awning rail straight down • Requires min. clearance of 13-1/2" between awning rail and top of entry door • This hardware will roll the awning out to a pre-set pitch for maximum shade and ideal rain runoff • 2-position pitch 	Flat Adjustable Pitch <ul style="list-style-type: none"> • Requires 69" unobstructed area from awning rail straight down • Requires min. clearance of 2-1/2" between awning rail and top of entry door • This hardware will roll the awning out flat to allow for clearance over slides, and allows quick and easy pitch adjustment at either side of the awning • Infinite adjustment 	Flat Adjustable Pitch <ul style="list-style-type: none"> • Requires 78" unobstructed area from awning rail straight down • Requires min. clearance of 4-1/2" between awning rail and top of entry door • This hardware is configured to operate a 9'-8" projection canopy. It will roll the awning out flat to allow for clearance over slides, and allows quick and easy pitch adjustment at either side of the awning



Painted hardware comes standard with black bracketry

arm type	arm size	standard head/white hardware	speaker head/white hardware	standard head/black hardware	speaker head/black hardware
Short Arm, Fixed Pitch	60-1/2"	388073	388075	388074	388076
Tall Arm, Flat Adjustable Pitch	69"	309221	351397	309223	351396
XL Arm, Adjustable Pitch	78"	362241	362242	362243	3562244

*NOTE: Solera XL arms require XL roller assemblies

UPGRADE

The Solera Hybrid Awning combines the best of both worlds. Featuring a simple crank operation, the Solera Hybrid Awning extends and retracts just like a Power Awning, except you supply the power. The next best thing to a fully powered awning, the Hybrid allows you to skip the potential hassle and installation cost of running wiring and acts as a do-it-yourself upgrade from a manual spring-loaded awning.

Hybrid Awning Arm Kit Includes:

- Two arms
- Switch & wiring harness
- Fasteners



NOTE: All awnings available from 10' to 21' widths in 1' increments

- Enjoy full or partial extension
- Deploys and retracts just like a Power Awning, except you supply the power - the awning opens, raises itself into camping position and lowers for secure travel as you crank
- Exclusive, quick and simple independent pitch adjustment
- Auto rain dump feature – if water pools in the canopy, the arms will release it
- Designed to provide optimum pitch when used over slide-outs
- Wide selection of quality vinyl and woven acrylic fabrics available with aluminum Solera Shield
- Choose the XL 10' extension canopy – perfect shade for tall motorhomes and fifth-wheel RVs

**XL requires different roller assemblies*

Solera® Hybrid Hardware



Painted hardware comes standard with black bracketry

SHORT ARM	TALL ARM	XL ARM
<p>Adjustable Pitch</p> <ul style="list-style-type: none"> • Requires 60-1/2" unobstructed area from awning rail straight down • Requires min. clearance of 13-1/2" between awning rail and top of entry door • This hardware will roll the awning out to a pre-set pitch for maximum shade and ideal rain runoff • 2-position pitch 	<p>Flat Adjustable Pitch</p> <ul style="list-style-type: none"> • Requires 69" unobstructed area from awning rail straight down • Requires min. clearance of 2-1/2" between awning rail and top of entry door • This hardware will roll the awning out flat to allow for clearance over slides, and allows quick and easy pitch adjustment at either side of the awning • Infinite adjustment 	<p>Flat Adjustable Pitch (2-Stage)</p> <ul style="list-style-type: none"> • Requires 78" unobstructed area from awning rail straight down • Requires min. clearance of 4-1/2" between awning rail and top of entry door • This hardware is configured to operate a 9'-8" projection canopy. It will roll the awning out flat to allow for clearance over slides, and allows quick and easy pitch adjustment at either side of the awning

arm type	arm size	plain head/white hardware	plain head/black hardware
Short Arm, Fixed Pitch	60-1/2"	388419	388420
Tall Arm, Flat Adjustable Pitch	69"	351828	351827
XL Arm, Adjustable Pitch*	78"	405201	405202

**NOTE: Solera XL arms require XL roller assemblies*

SOLERA POWER & HYBRID XL AWNINGS

ALIGNMENT, SUSPENSION & AXLES
 LEVELING & STABILIZATION
 TOWING
 CARGO SECURITY & STORAGE
 WASTE MANAGEMENT
 AWNINGS
 STEPS
 SLIDE-OUTS
 HAPPYAC
 DOORS & SEALS
 KITCHEN & BATH
 FURNITURE & MATTRESS



**20%
 MORE
 SHADE**
 THAN A STANDARD 8'
 PROJECTION AWNING

**THE FIRST!
 XL 9'8"
 PROJECTION**

GO LARGE

The Solera XL Awning features a 9'8" projection making it perfect for taller RVs and RVs with a slide-out under the awning. Class A motorhomes, fifth-wheel and toy hauler RVs continue to get taller and taller, so it can be difficult to get the shade you need from a standard 8' projection awning. Not only that, but many brands now feature slide-outs under the awning, which can really limit your shaded patio area. Choose a Solera XL Awning to enjoy 20 percent more shade than a standard 8-foot projection pitch.

Now featuring an adjustable projection pitch Sleeve, the Solera XL Awning can be pitched at multiple points to block the sun at any time of day. The two-stage projection pitch Sleeve also provides added strength and support for your awning making the XL awning one of the best values on the market.



Painted hardware comes standard with black bracketry

XL Power Awning Arm Kit Includes:

- Two arms
- Switch & wiring harness
- Fasteners

**Power Pack not available for Solera XL Awnings.*

XL Hybrid Awning Arm Kit Includes:

- Two arms
- Crank rod
- Fasteners

XL ARM

Flat Adjustable Pitch

- Requires 78" unobstructed area from awning rail straight down
- Requires min. clearance of 4-1/2" between awning rail and top of entry door
- This hardware is configured to operate a 9'-8" projection canopy. It will roll the awning out flat to allow for clearance over slides, and allows quick and easy pitch adjustment at either side of the awning

SOLERA POWER & HYBRID FABRIC ROLLER ASSEMBLIES

Standard 8' Projection Vinyl Roller Assemblies

length	black fade BKWG	white fade WHWG	sand fade BKWG	sand fade WHWG	solid black BKSOLID	burgundy fade WHWG	blue fade WHWG	silver fade WHWG
10'	00-0295	00-0307	V000231492	V000231508	V000211447	V000286883	V000286908	V000307065
11'	00-0296	00-0308	V000223158	V000223153	V000256341	V000286885	V000286909	V000342917
12'	00-0297	00-0309	V000223159	V000223177	V000231439	V000286886	V000286910	V000342918
13'	00-0298	00-0310	V000223160	V000223178	V000211460	V000286887	V000286911	V000342919
14'	00-0299	00-0311	V000223161	V000223179	V000211468	V000286888	V000286912	V000324187
15'	00-0300	00-0312	V000223162	V000223185	V000231442	V000286889	V000286914	V000312456
16'	00-0301	00-0313	V000223163	V000223189	V000211487	V000286890	V000286915	V000342920
17'	00-0302	00-0314	V000223165	V000223190	V000231446	V000286891	V000286916	V000342921
18'	00-0303	00-0315	V000223170	V000223191	V000211506	V000286892	V000286920	V000342922
19'	00-0304	00-0316	V000231497	V000231519	V000211513	V000286893	V000286921	V000342924
20'	00-0305	00-0317	V000231498	V000231520	V000211518	V000286894	V000286922	V000342925
21'	00-0306	00-0318	V000255587	V000266033	V000211532	V000286895	V000286924	V000324185

NEW 10' Projection XL Vinyl Roller Assemblies

length	black fade BKWG	white fade WHWG	sand fade BKWG	sand fade WHWG	solid black BKSOLID	burgundy fade WHWG	blue fade WHWG	silver fade WHWG
10'	V000334742	V000334743	V000334745	V000334744	V000334746	V000334747	V000334748	V000334749
11'	V000334909	V000334911	V000334912	V000334913	V000334914	V000334915	V000334916	V000334917
12'	V000334918	V000334919	V000334920	V000334921	V000334922	V000334923	V000334924	V000334925
13'	V000334926	V000334927	V000334928	V000334934	V000334937	V000334938	V000334939	V000334940
14'	V000334941	V000334942	V000334944	V000334945	V000334946	V000334947	V000334948	V000334949
15'	V000334950	V000334951	V000334952	V000334953	V000334954	V000334955	V000334956	V000334957
16'	V000334959	V000334965	V000334970	V000334976	V000334979	V000334983	V000334987	V000334992
17'	V000334961	V000334998	V000334999	V000335001	V000335005	V000335009	V000335014	V000335020
18'	V000334963	V000335000	V000335029	V000335031	V000335034	V000335037	V000335039	V000335041
19'	V000334966	V000335007	V000335043	V000335044	V000335046	V000335048	V000335050	V000335052
20'	V000334969	V000335011	V000335055	V000335059	V000335062	V000335066	V000335071	V000335074
21'	V000334972	V000335015	V000335067	V000335089	V000335092	V000335093	V000335094	V000335095

*The color of the exposed vinyl in the rolled up position is noted as BKWG meaning black; or WHWG, meaning white

Vinyl Fabric

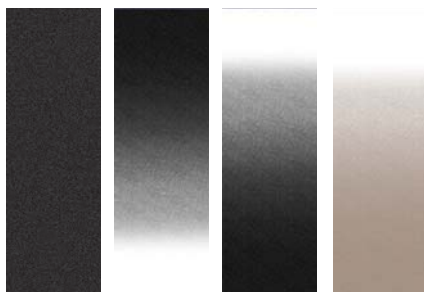

Solid Black BKSOLID Black Fade BKWG White Fade WHWG Sand Fade BKWG

Acrylic Fabric



Black Cherry Charcoal Tweed Hemlock Tweed

Solera Shield



The built-in Solera Shield provides elegant and practical protection for your Solera vinyl or acrylic awning canopy. As the awning retracts, the aluminum Solera Shield automatically rolls up around the fabric to protect it against the elements during travel. Be sure to order your Solera Shield to match your hardware.

NOTE: Solera Shield not available on XL



Sand Fade WHWG Burgundy Fade WHWG Blue Fade WHWG Silver Fade WHWG



Linen Tweed Mediterranean Blue Tweed

NOTE: All acrylic fabric features the solera shield

Special Order Canopy Options:

- Vinyl fabric with Solera Shield
- Woven acrylic fabric with Solera Shield

*See your LCI sales representative for part #.

ALIGNMENT, SUSPENSION & AXLES
LEVELING & STABILIZATION
TOWING
CARGO, SECURITY & STORAGE
WASTE MANAGEMENT
AWNINGS
STEPS
SLIDE-OUTS
HAPPYJAC
DOORS & SEALS
KITCHEN & BATH
FURNITURE & MATTRESS

SOLERA CLASSIC AWNINGS

ALIGNMENT, SUSPENSION & AXLES
 LEVELING & STABILIZATION
 TOWING
 CARGO SECURITY & STORAGE
 WASTE MANAGEMENT
 AWNINGS
 STEPS
 SLIDE-OUTS
 HAPPYJAC
 DOORS & SEALS
 KITCHEN & BATH
 FURNITURE & MATTRESS

FIX IT

Is your RV awning in need of a fix? Take the hassle out of fixing or replacing your classic awning. With our improved line of universal awning hardware, replacing your awning has never been easier. Fix your old, worn out awning with the Solera Classic Awning. The rugged, spring-loaded Solera Classic extends and retracts in just a few easy steps. Simply release the travel locks on each arm, loosen the rafter knobs, and use the pull cane to unlock the roller. Then hook the pull strap and walk it out to unroll the awning. Once extended, set the tension, tighten rafter knobs and raise the awning arms to whatever pitch you want for shade and water runoff. Take advantage of the "carport" position with this awning, making it easy to attach accessories such as the Solera Screen Room™ and Solera Family Room™.

Classic Awning Arm Kit Includes:

- Two Arms
- Mounting Brackets
- Hardware
- Pull cane



- Traditional Manual Spring Roll Up
- Arms detach from bottom bracket and easily swing to "carport" position providing varied pitch options to block the sun at any time of the day
- Universal hardware makes replacing your awning a breeze. Brackets fit right over the mounting holes from your old awning making it easier than ever to exchange your worn out awning
- Great value for replacing any Dometic®, Carefree® or Solera spring-loaded manual awning
- Simple standard manual operation: unlock with wand, unroll with strap, set the braces and raise the arms

Solera® Classic Hardware

SHORT ARM	STANDARD ARM	LONG ARM
• Rail to floor line 63"-68"	• Rail to floor line 68"-81"	• Rail to floor line 81"-96"



arm type	arm range	white hardware	black hardware	satin hardware
Short Arm	63" - 68"	V000334715	V000334958	V000231492
Standard Arm	68" - 81"	V000334716	V000335045	V000335047
Classic Long Arm	81" - 96"	V000334717	V000335059	V000335051

SOLERA CLASSIC FABRIC & ROLLER ASSEMBLIES

Standard 8' Projection Vinyl Roller Assemblies

width	black fade BKWG	white fade WHWG	sand fade BKWG	sand fade WHWG	solid black BKSOLID	burgundy fade WHWG	blue fade WHWG	silver fade WHWG
10'	90-2750	90-2721	V000343059	V000343048	V000343115	V000343071	V000343090	V000343101
11'	90-2749	90-2722	V000343058	V000343047	V000343114	V000343070	V000343089	V000343100
12'	90-2748	90-2723	V000343057	V000343046	V000343113	V000343069	V000343088	V000343099
13'	90-2747	90-2724	V000343056	V000343045	V000343112	V000343068	V000343087	V000343098
14'	90-2746	90-2725	V000343055	V000343044	V000343111	V000343067	V000343085	V000343097
15'	90-2745	90-2726	V000343054	V000343043	V000343109	V000343065	V000343083	V000343096
16'	90-2744	90-2727	V000343053	V000343042	V000343108	V000343064	V000343080	V000343095
17'	90-2743	90-2728	V000343052	V000343038	V000343107	V000343063	V000343078	V000343094
18'	90-2742	90-2729	V000343051	V000343037	V000343106	V000343062	V000343075	V000343093
19'	90-2741	90-2730	V000343050	V000343036	V000343105	V000343061	V000343074	V000343092
20'	90-2740	90-2731	V000343049	V000343035	V000343102	V000343060	V000343073	V000343091
21'	90-2739	90-2732	V000343017	V000343016	V000343022	V000343018	V000343019	V000343020

Vinyl Fabric



Acrylic Fabric



All Solera Awning canopies feature an integrated track that works with the flexible Solera Fabric Light Kit. The Light Kit slides into the integrated track by the coach side wall and under the awning so you can enjoy light outside the RV when the awning is extended or retracted!

Solera Shield



The built-in Solera Shield provides elegant and practical protection for your Solera vinyl or acrylic awning canopy. As the awning retracts, the aluminum Solera Shield automatically rolls up around the fabric to protect it against the elements during travel. Be sure to order your Solera Shield to match your hardware.

NOTE: Solera Shield not available on XL

Special Order Canopy Options:

- Vinyl fabric with Solera Shield
- Woven acrylic fabric with Solera Shield

*See your LCI sales representative for part #.

ALIGNMENT, SUSPENSION & AXLES
LEVELING & STABILIZATION
TOWING
CARGO, SECURITY & STORAGE
WASTE MANAGEMENT
AWNINGS
STEPS
SLIDE-OUTS
HAPPYJAC
DOORS & SEALS
KITCHEN & BATH
FURNITURE & MATTRESS

SOLERA DESTINATION AWNINGS

DON'T JUST
REPLACE.
EXPAND
YOUR
OUTDOOR
LIVING
AREA BY
20%
with the
**SOLERA
DESTINATION**
9'-8"
projection
canopy.



GO LARGE

Destination campers (or seasonal campers) who set up camp for extended stays will love the Solera Destination Awning. With 20% more shaded area compared to standard 8-foot projection awnings, the 9'-8" Solera Destination Awning is the ultimate solution when you need added living space. **Not only does the Destination awning provide extra shade, it also comes with a center ground support, a Solera Shield to protect the vinyl canopy and a Solera Awnbrella™ to keep the fabric arched and taut to minimize wind flap and enable rain runoff.**

- Operates like any manual spring roll up awning — basically it's a jumbo Solera Classic Awning
- Large 10' projection canopy with aluminum Solera Shield®
- Wide selection of vinyl fabric colors and custom color hardware
- Comes standard with Solera Awnbrella® support bows*

*NOTE: Awnbrella may leave minor stretch marks on awning fabric, depending on use. Fabric in worn condition should be replaced before using Awnbrella. Standard size Awnbrella shown below is not for use on awnings extending more than 9' or awnings that have no roller tube.

Solera® Destination Hardware

9'-8" Projection Roller Assembly

- Requires 78" unobstructed area from awning rail straight down
- This hardware is configured to operate a 10' projection canopy
- Solera Awnbrella bows are also available for 8' projection awnings - see page 72

white hardware	black hardware	satin hardware	custom colors
V000334718	V000334719	V000334720	Special Order

Painted hardware comes standard with black bracketry

ALIGNMENT, SUSPENSION & AXLES
LEVELING & STABILIZATION
TOWING
CARGO SECURITY & STORAGE
WASTE MANAGEMENT
AWNINGS
STEPS
SLIDE-OUTS
HAPPIJAC
DOORS & SEALS
KITCHEN & BATH
FURNITURE & MATTRESS

Standard Color Options

White

Black

Special Order Options

Satin Silver

Cream

SOLERA DESTINATION FABRIC & ROLLER ASSEMBLIES

Solera Destination 9'-8" Projection Awning Roller Assemblies

13.5 oz. Vinyl Fabric with wraparound aluminum Solera Shield

Remember to specify the Solera Shield color to match the hardware color of your awning

width	black fade, BKS	black fade, WHS	white fade, WHS	white fade, BKS	sand fade, BKS	sand fade, WHS	black solid, BKS
16'	V000334818	V000334867	V000334839	V000334843	V000334873	V000334870	V000334847
17'	V000335268	V000335279	V000335294	V000335302	V000335338	V000335329	V000335317
18'	V000335270	V000335281	V000335296	V000335310	V000335340	V000335331	V000335319
19'	V000335272	V000335287	V000335298	V000335324	V000335342	V000335332	V000335322
20'	V000335274	V000335289	V000335300	V000335326	V000335345	V000335334	V000335323
21'	V000335276	V000335292	V000335301	V000335327	V000335348	V000335336	V000335325

width	burgundy fade, WHS	burgundy fade, BKS	blue fade, WHS	blue fade, BKS	silver fade, BKS	silver fade, WHS	green fade, BKS	green fade, WHS
16'	V000334857	V000334859	V000334861	V000334865	V000334864	V000334862	V000345003	V000345009
17'	V000335370	V000335337	V000335389	V000335397	V000335350	V000335364	V000345004	V000345010
18'	V000335378	V000335343	V000335393	V000335401	V000335352	V000335368	V000345005	V000345011
19'	V000335383	V000335347	V000335396	V000335408	V000335354	V000335372	V000345006	V000345012
20'	V000335386	V000335361	V000335404	V000335414	V000335356	V000335375	V000345007	V000345013
21'	V000335390	V000335366	V000335410	V000335423	V000335358	V000335380	V000345008	V000345014

The color of the Solera Shield is noted as BKS meaning black; or WHS, meaning white

Vinyl Fabric



Solera Shield



The built-in Solera Shield provides elegant and practical protection for your Solera vinyl or acrylic awning canopy. As the awning retracts, the aluminum Solera Shield automatically rolls up around the fabric to protect it against the elements during travel. Be sure to order your Solera Shield to match your hardware.

Special Order Canopy Options:

- Woven acrylic fabric with Solera Shield

All Solera Awning canopies with the Solera Shield feature an integrated track that works with the flexible Solera Fabric Light Kit. The Light Kit slides into the integrated track by the coach side wall and under the awning so you can enjoy light outside the RV when the awning is extended or retracted!

*See your LCI sales representative for part #.

ALIGNMENT, SUSPENSION & AXLES
LEVELING & STABILIZATION
TOWING
CARGO, SECURITY & STORAGE
WASTE MANAGEMENT
AWNINGS
STEPS
SLIDE-OUTS
HAPPYJAC
DOORS & SEALS
KITCHEN & BATH
FURNITURE & MATTRESS

SOLERA AWNBRELLA®

ALIGNMENT, SUSPENSION & AXLES

LEVELING & STABILIZATION

TOWING

CARGO SECURITY & STORAGE

WASTE MANAGEMENT

AWNINGS

STEPS

SLIDE-OUTS

HAPPYJAC

DOORS & SEALS

KITCHEN & BATH

FURNITURE & MATTRESS



The Awmbrella's adjustable bows can be installed in about 10 minutes and work with virtually every awning on the market.

Simple camp setup



1 Position 2 Slide 3 Tighten



Enjoy your Awmbrella



Give your awning extra support and better angle for water runoff with the Solera Awmbrella.

Perfect for destination campers who like to leave their awning extended for long periods of time, the patented rust-resistant aluminum bows hold fabric taut and arched so water doesn't pool and debris can easily run off. Now you won't have to camp with one end of your awning pitched lower than the other end. The Solera Awmbrella also complements the Solera Screen Room™ and Solera Family Room™.

Order your Awmbrella based on the width of your awning!

8' Awmbrella: Fits all standard 8 foot awnings. Comes in a two or three pack.

10' Awmbrella: Fits 10 foot Lippert Components® Destination manual awnings as well as Power and Hybrid XL awnings. Comes in a two or three pack.

part no.	description	dimensions
362237	Awmbrella for 8' extension awning, 3 pack	Extends 59" – 106"
362238	Awmbrella for 8' extension awning, 2 pack	Extends 59" – 106"
362239	Awmbrella for 9'-8" extension awning, 3 pack	Extends 79" – 120"
362240	Awmbrella for 9'-8" extension awning, 2 pack	Extends 79" – 120"

width	# of awmbrella arms
10'-14'	2 arms
14'-18'	3 arms
18'-22'	4 arms
22'-27'	5 arms

*NOTE: The Awmbrella may leave minor stretch marks on awning fabric, depending on use. Fabric in worn condition should be replaced before using the Awmbrella.

Awmbrella display available



SOLERA AWNING ACCESSORIES



Solera® 18V Power Pack

Upgrading to a power awning has never been easier! The Solera Power Pack is a unique, rechargeable battery that fits right inside your Solera Power Awning arm and comes with everything you need to connect to the motor wire. This is the perfect awning for DIY RVers who don't want to spend the installation dollars to wire a 12V awning into their RV.



- Same great pitch features as our 12V power awning
- Provides faster extend and retract time
- Comes with 110V charging kit
- Easy DIY installation
- Straightforward alternative to wiring into the RV power source
- Universal hardware option allows for easy replacement on Dometic®, Carefree® and Solera patio awnings

	standard pitch 66.125" arm size	flat pitch 69" arm size
Plain Head, White	V000161791	V000151067
Plain Head, Black	V000161789	V000151151



Solera Fabric Light Kit

All Solera Awning models and replacement fabrics feature a NEW integrated light rail sewn right into the awning hem. The flexible Solera Fabric Light Kit slides into the track by the coach side wall and under the awning. The innovative design allows you to enjoy dramatic lighting outside the RV when the awning is extended or retracted.

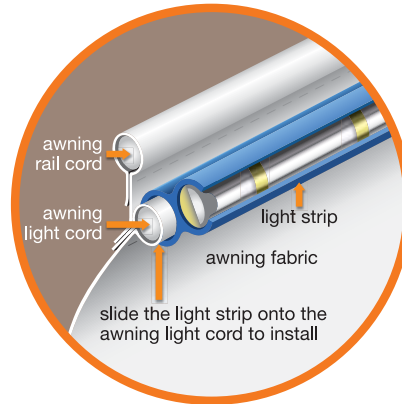

length	part no.	color
15'	387593	Black Plastic
21'	387594	Black Plastic



Universal Awning Ground Support

Stabilize your awning and prevent the roller from sagging with the Awning Ground support

- Fits all awning brands
- Adjustable leg extension
- Stake the Awning Ground Support to the ground for best results

part no.	color
362246	White Ground Support
362247	Black Ground Support



Awning Cradle Support

The Awning Cradle Support works with all brands of power or manual awnings to support the roller assembly when in the travel position. The support automatically accepts and releases the roller assembly as it extends and retracts.

part no.	description
289373	White
289374	Black

ALIGNMENT, SUSPENSION & AXLES
LEVELING & STABILIZATION
TOWING
CARGO, SECURITY & STORAGE
WASTE MANAGEMENT
AWNINGS
STEPS
SLIDE-OUTS
HAPPYJAC
DOORS & SEALS
KITCHEN & BATH
FURNITURE & MATTRESS

SOLERA AWNING ACCESSORIES

ALIGNMENT, SUSPENSION & AXLES

LEVELING & STABILIZATION

TOWING

CARGO SECURITY & STORAGE

WASTE MANAGEMENT

AWNINGS

STEPS

SLIDE-OUTS

HAPPYAC

DOORS & SEALS

KITCHEN & BATH

FURNITURE & MATTRESS



Solera® Classic Front and Side Shades

The Solera Side and Front Shade are the perfect solutions whenever you need extra shade, privacy or wind block. Solera Side Shade panels are available in 6', 7', 8', 9' & 10' screen heights.

Classic Front Shade

width	part no.
8'	3833980608
10'	3833980610
13'	3833980613
15'	3833980615
17'	3833980617
19'	3833980619

Available in black plastic only.



NOTE: Solera Super Shade is available for standard 8' extension patio awnings only; not compatible with Solera XL awnings.

Solera® Super Shade

Many of the larger RV's today have patio awnings that are too high to reach when they are fully extended, and that's why we created the Solera Super Shade! The two-piece, black Solera Super Shade features a standard 6' shade height that easily zips into a Super Shade extension that can be permanently installed into your awning's roller tube. The Super Shade extension can be ordered in five sizes that would provide either a 6', 7', 8', 9' or 10' total screen height. Order the Super Shade extension height based on how high your patio awning is from the ground to roller tube while fully extended. For example, if your patio awning measures 10' high from ground to roller tube, order the 10' Super Shade. The Solera Super Shade comes in 10', 13', 15', 17' & 19' widths.

Super Shade

width	6' drop	7' drop	8' drop	9' drop	10' drop
10'	379820610	379820710	379820810	379820910	379820610
13'	379820613	379820713	379820813	379820913	379820613
15'	379820615	379820715	379820815	379820915	379820615
17'	379820617	379820717	379820817	379820917	379820617
19'	379820619	3798206719	379820819	379820919	379820619

Solera Shade Side Panels

drop	part no.
6' Drop	37978606
7' Drop	37978607
8' Drop	37978608
9' Drop	37978609
10' Drop	37978610

Available in black plastic only.

SOLERA AWNING ACCESSORIES



Solera® Family Room™

Turn the space under your awning into an enclosed outdoor patio with the Solera Family Room kit. Add up to 168 square feet of enclosed space so you can enjoy meals minus pesky insects. Or roll down the all-weather panels and use as a cozy sleeping area for kids.

- Available in various widths to fit awnings spanning from 10' to 21' in length
- Measure center of arm to center of arm to determine room size needed
- Light gray fabric and black screening complements any RV color scheme
- Features 3' zippered door panel

size	part no.
10'	362225
11'	362226
12'	362227
13'	362228
14'	362229
15'	362230

size	part no.
16'	362231
17'	362232
18'	362233
19'	362234
20'	362235
21'	362236

BIG PLUS

NEVER SETTLE FOR A ROOM SMALLER THAN YOUR AWNING WITH SOLERA'S 1' INCREMENTS. AVAILABLE ON SOLERA FAMILY ROOMS & SCREEN ROOMS ONLY.



Solera® Screen Room™

Keep the bugs out, and enjoy the breeze with the Solera Screen Room. Its neutral tan material helps to block out extra heat, making the Solera Screen Room perfect for outdoor dining, board games and social gatherings on hot summer days.

- Available in various widths to fit awnings spanning from 10' to 21' in length
- Measure center of arm to center of arm to determine room size needed
- Features 3' zippered door panel

size	part no.
10'	362213
11'	362214
12'	362215
13'	362216
14'	362217
15'	362218

size	part no.
16'	362219
17'	362220
18'	362221
19'	362222
20'	362223
21'	362224

Solera Classic Shade, Front and Side Shade, Super Shade, Family Room and Screen Room fit: (Awning ground-to-rail can measure up to 130")

- Solera® 8' Extension Classic, Hybrid and 12V Power
- Carefree® 8' Extension Spirit, Fiesta, Simplicity, Traveler and Eclipse Awnings
- Dometic® (A&E) 8' Extension 8500, 9000, 9100, Sunchaser and WeatherPro Awnings

ALIGNMENT, SUSPENSION & AXLES

LEVELING & STABILIZATION

TOWING

CARGO, SECURITY & STORAGE

WASTE MANAGEMENT

AWNINGS

STEPS

SLIDE-OUTS

HAPPYJAC

DOORS & SEALS

KITCHEN & BATH

FURNITURE & MATTRESS

WINDOW AWNINGS

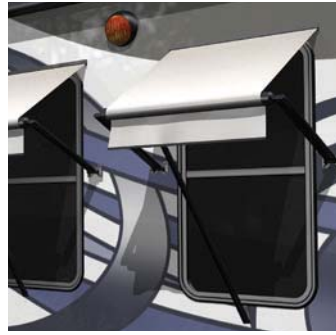

Vinyl Fabric



Solid Black
BKSOLID



Black Fade
BKWG



White Fade
WHWG



Sand Fade
BKWG



Sand Fade
WHWG



Burgundy Fade
WHWG



Blue Fade
WHWG



Silver Fade
WHWG



Green Fade
WHWG

Acrylic Fabrics



Black Cherry



Charcoal Tweed



Hemlock Tweed



Linen Tweed



Mediterranean
Blue Tweed

NOTE: All acrylic fabric features the Solera Shield

Save money and keep cool with Solera Window Awnings. Solera Window Awnings block the sun's rays from invading your RV windows and help you cut down on AC usage during the hot summer months. Just use the pull cane to hook the pull strap and pull it to extend the awning. Secure the strap loop onto a hook on the RV wall to keep the awning extended. Go for the best value and the best look and cover two windows with one window awning.

Solera Window Awnings are available in standard arm and canopy sizes for windows that are under 33 inches in height, and in XL sizes for windows over 33 inches. Standard window awning arms are 18 inches long so they'll have an 18-inch projection, and XL window awnings arms are 30 inches long so they'll have a 30-inch projection. Order arms and roller separately.

Keep the heat out and save on AC

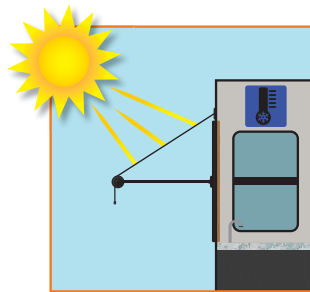
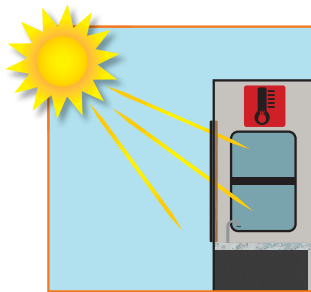

Painted hardware comes standard with black bracketry

Window Awning Hardware

height	white hardware	black hardware	satin hardware	custom paint
Standard (Under 33")	V000334754	V000334750	V000334753	Special Order
XL (Over 33")	V000334759	V000334764	V000334765	Special Order

ALIGNMENT, SUSPENSION & AXLES

LEVELING & STABILIZATION

TOWING

CARGO SECURITY & STORAGE

WASTE MANAGEMENT

AWNINGS

STEPS

SLIDE-OUTS

HAPPYAC

DOORS & SEALS

KITCHEN & BATH

FURNITURE & MATTRESS

Standard Color Options

White

Black

Special Order Options

Satin Silver

Cream

SOLERA WINDOW AWNING ROLLER ASSEMBLIES

Standard Solera Vinyl Window Awning Roller Assemblies, 18" Projection*

width	black fade BKWG	white fade WHWG	sand fade BKWG	sand fade WHWG	burgundy fade WHWG	blue fade WHWG	solid black BKWG	silver fade WHWG	green fade WHWG
36"	V000334776	V000334778	V000334824	V000334779	V000334800	V000334802	V000334804	V000334806	V000345015
42"	V000334962	V000335002	V000335040	V000335087	V000335153	V000335351	V000335426	V000335469	V000345016
48"	V000334964	V000335004	V000335056	V000335088	V000335154	V000335355	V000335427	V000335472	V000345019
54"	V000334967	V000335006	V000335057	V000335090	V000335155	V000335359	V000335428	V000335474	V000345020
60"	V000334968	V000335008	V000335058	V000335091	V000335156	V000335362	V000335429	V000335475	V000345021
66"	V000334971	V000335010	V000335060	V000335105	V000335158	V000335367	V000335430	V000335476	V000345022
72"	V000334973	V000335012	V000335061	V000335106	V000335159	V000335371	V000335432	V000335477	V000345023
78"	V000334974	V000335013	V000335063	V000335107	V000335160	V000335377	V000335434	V000335478	V000345024
84"	V000334975	V000335016	V000335064	V000335108	V000335162	V000335381	V000335436	V000335480	V000345025
90"	V000334977	V000335017	V000335065	V000335109	V000335164	V000335384	V000335438	V000335481	V000345026
96"	V000334978	V000335019	V000335068	V000335110	V000335165	V000335388	V000335440	V000335482	V000345027
102"	V000334980	V000335021	V000335069	V000335116	V000335167	V000335392	V000335445	V000335483	V000345028
108"	V000334981	V000335022	V000335070	V000335117	V000335169	V000335394	V000335447	V000335484	V000345029
114"	V000334982	V000335023	V000335071	V000335119	V000335171	V000335398	V000335448	V000335485	V000345030
120"	V000334984	V000335024	V000335073	V000335121	V000335172	V000335400	V000335450	V000335486	V000345031
126"	V000334985	V000335025	V000335075	V000335123	V000335173	V000335403	V000335453	V000335487	V000345032
132"	V000334986	V000335026	V000335078	V000335124	V000335175	V000335405	V000335454	V000335488	V000345033
138"	V000334989	V000335027	V000335079	V000335125	V000335177	V000335407	V000335456	V000335489	V000345034
144"	V000334990	V000335028	V000335080	V000335126	V000335179	V000335411	V000335458	V000335490	V000345035
150"	V000334991	V000335030	V000335081	V000335128	V000335181	V000335413	V000335460	V000335491	V000345062
156"	V000334993	V000335032	V000335082	V000335130	V000335183	V000335416	V000335462	V000335492	V000345063
162"	V000334994	V000335033	V000335083	V000335131	V000335184	V000335418	V000335463	V000335493	V000345064
168"	V000334995	V000335035	V000335084	V000335132	V000335186	V000335420	V000335466	V000335494	V000345065
174"	V000334996	V000335036	V000335085	V000335133	V000335188	V000335422	V000335467	V000335495	V000345066
180"	V000334997	V000335038	V000335086	V000335135	V000335189	V000335424	V000335468	V000335496	V000345067

XL Solera Vinyl Window Awning Roller Assemblies, 30" Projection*

width	black fade BKWG	white fade WHWG	sand fade BKWG	sand fade WHWG	burgundy fade WHWG	blue fade WHWG	solid black BKWG	silver fade WHWG	green fade WHWG
36"	V000335254	V000334808	V000334825	V000334811	V000334812	V000334813	V000334814	V000334807	V000345068
42"	V000335262	V000335253	V000335357	V000335255	V000335111	V000335150	V000335199	V000335176	V000345069
48"	V000335265	V000335263	V000335360	V000335256	V000335112	V000335151	V000335200	V000335228	V000345070
54"	V000335266	V000335306	V000335363	V000335257	V000335113	V000335152	V000335201	V000335229	V000345071
60"	V000335267	V000335308	V000335365	V000335258	V000335114	V000335157	V000335202	V000335230	V000345072
66"	V000335269	V000335309	V000335369	V000335259	V000335115	V000335161	V000335203	V000335231	V000345073
72"	V000335271	V000335311	V000335373	V000335260	V000335118	V000335163	V000335204	V000335234	V000345074
78"	V000335273	V000335312	V000335374	V000335261	V000335120	V000335166	V000335209	V000335235	V000345075
84"	V000335275	V000335313	V000335376	V000335431	V000335122	V000335168	V000335210	V000335236	V000345076
90"	V000335277	V000335314	V000335379	V000335433	V000335127	V000335170	V000335211	V000335237	V000345077
96"	V000335278	V000335315	V000335382	V000335435	V000335129	V000335174	V000335212	V000335238	V000345078
102"	V000335280	V000335316	V000335385	V000335437	V000335134	V000335178	V000335213	V000335239	V000345079
108"	V000335282	V000335318	V000335387	V000335439	V000335136	V000335180	V000335214	V000335240	V000345080
114"	V000335283	V000335320	V000335391	V000335441	V000335137	V000335182	V000335215	V000335241	V000345081
120"	V000335284	V000335321	V000335395	V000335442	V000335139	V000335185	V000335216	V000335242	V000345082
126"	V000335285	V000335328	V000335399	V000335444	V000335140	V000335187	V000335217	V000335243	V000345083
132"	V000335286	V000335330	V000335402	V000335446	V000335141	V000335190	V000335218	V000335244	V000345084
138"	V000335288	V000335333	V000335406	V000335449	V000335142	V000335191	V000335219	V000335245	V000345085
144"	V000335290	V000335335	V000335409	V000335452	V000335143	V000335192	V000335220	V000335246	V000345086
150"	V000335291	V000335339	V000335412	V000335455	V000335144	V000335193	V000335222	V000335247	V000345087
156"	V000335293	V000335341	V000335415	V000335457	V000335145	V000335194	V000335223	V000335248	V000345088
162"	V000335295	V000335344	V000335417	V000335459	V000335146	V000335195	V000335224	V000335249	V000345089
168"	V000335297	V000335346	V000335419	V000335461	V000335147	V000335196	V000335225	V000335250	V000345090
174"	V000335299	V000335349	V000335421	V000335464	V000335148	V000335197	V000335226	V000335251	V000345091
180"	V000335264	V000335353	V000335425	V000335465	V000335149	V000335198	V000335227	V000335252	V000345092

*The color of the exposed vinyl in the rolled up position is noted as BKWG meaning black; or WHWG, meaning white

ALIGNMENT, SUSPENSION & AXLES
LEVELING & STABILIZATION
TOWING
CARGO, SECURITY & STORAGE
WASTE MANAGEMENT
AWNINGS
STEPS
SLIDE-OUTS
HAPPYJAC
DOORS & SEALS
KITCHEN & BATH
FURNITURE & MATTRESS

SOLERA® SLIDERS



ALIGNMENT, SUSPENSION & AXLES
LEVELING & STABILIZATION
TOWING
CARGO SECURITY & STORAGE
WASTE MANAGEMENT
AWNINGS
STEPS
SLIDE-OUTS
HAPPIJAC
DOORS & SEALS
KITCHEN & BATH
FURNITURE & MATTRESS

Because whatever gets on your slide-out roof could end up inside your RV

- Attractive and economical protection for your slide-out
- Full coverage over the slide-out roof and the RV sidewall slide-out opening
- Blocks leaves, bird droppings, branches and debris
- Automatically retracts and extends with slide-out
- Fits slides ranging from 66" to 192" long and extending up to 42"
- Comes complete with awning rail and all mounting brackets
- Choose from 9 vinyl fabric colors or 5 woven acrylic fabric colors
- Available with Solera Shield in 2 colors

	 <small>Report Comments</small>	Competitor A	Competitor B
Fits slide-outs ranging from 66" to 192" in length			
(1) Part number that comes complete with awning rail, topper and all mounting brackets			
Multiple colors and options available			
Standard 13.5 oz vinyl fabric		10 oz only	10 oz only
No anti-billowing device needed			
Heated wedge welding fuses vinyl together for strong, leak-resistant seams			
Accommodates slide-outs up to 48" wide		42"	42"
Flexible placement; can be installed up to five inches above slide box trim			
NEW! Available (8) custom colors for the hardware to custom match your investment			

Vinyl Roller Assemblies for Solera Sliders

flange measurement	solera fabric size	replace with solera slide topper	black vinyl & hardware	white vinyl & hardware
57" - 61"	61	Solera Slider 57"-61"	V000168104	V000163273
62" - 67"	67	Solera Slider 62"-67"	V000231482	V000163274
68" - 73"	73	Solera Slider 68"-73"	V000165063	V000163279
74" - 79"	79	Solera Slider 74"-79"	V000168105	V000163285
80" - 85"	85	Solera Slider 80"-85"	V000165062	V000163287
86" - 91"	91	Solera Slider 86"-91"	V000168106	V000163288
92" - 97"	97	Solera Slider 92"-97"	V000168107	V000163289
98" - 103"	103	Solera Slider 98"-103"	V000168108	V000163290
104" - 109"	109	Solera Slider 104"-109"	V000168325	V000163291
110" - 115"	115	Solera Slider 110"-115"	V000251461	V000163292
116" - 121"	121	Solera Slider 116"-121"	V000182037	V000163293
122" - 127"	127	Solera Slider 122"-127"	V000168326	V000163294
128" - 133"	133	Solera Slider 128"-133"	V000184673	V000163295
134" - 139"	139	Solera Slider 134"-139"	V000168328	V000139496
140" - 145"	145	Solera Slider 140"-145"	V000177334	V000163298
146" - 151"	151	Solera Slider 146"-151"	V000165061	V000163299
152" - 157"	157	Solera Slider 152"-157"	V000168109	V000163300
158" - 163"	163	Solera Slider 158"-163"	V000168110	V000163301
164" - 169"	169	Solera Slider 164"-169"	V000168112	V000163302
170" - 175"	175	Solera Slider 170"-175"	V000251477	V000163303
176" - 181"	181	Solera Slider 176"-181"	V000251478	V000163304
182" - 187"	187	Solera Slider 183"-187"	V000194925	V000163307

To order the correct Solera Slider, select the size that extends a minimum of 2-1/2" beyond each side of your box width. Solera Sliders come with all the hardware needed for installation.

ALIGNMENT, SUSPENSION & AXLES
 LEVELING & STABILIZATION
 TOWING
 CARGO, SECURITY & STORAGE
 WASTE MANAGEMENT
 AWNINGS
 STEPS
 SLIDE-OUTS
 HAPPYJAC
 DOORS & SEALS
 KITCHEN & BATH
 FURNITURE & MATTRESS

SOLERA UNIVERSAL REPLACEMENT FABRICS

Easily replace your awning fabric and skip the guesswork when deciding which fabric to buy. Our updated line of awning fabric is now universal and works with all major competitor awning brands.

- Fits 10' – 21' Carefree®, Dometic® and Solera patio awnings with an 8' projection
- To determine which size of replacement fabric you need, measure your awning from the center of the back arm to the center of the front arm
- All Solera replacement fabrics feature an integrated light cord that accommodates the Solera Fabric Light Kit (pg. 73)— the easiest way to upgrade your awning with LED lighting. LED lights not included

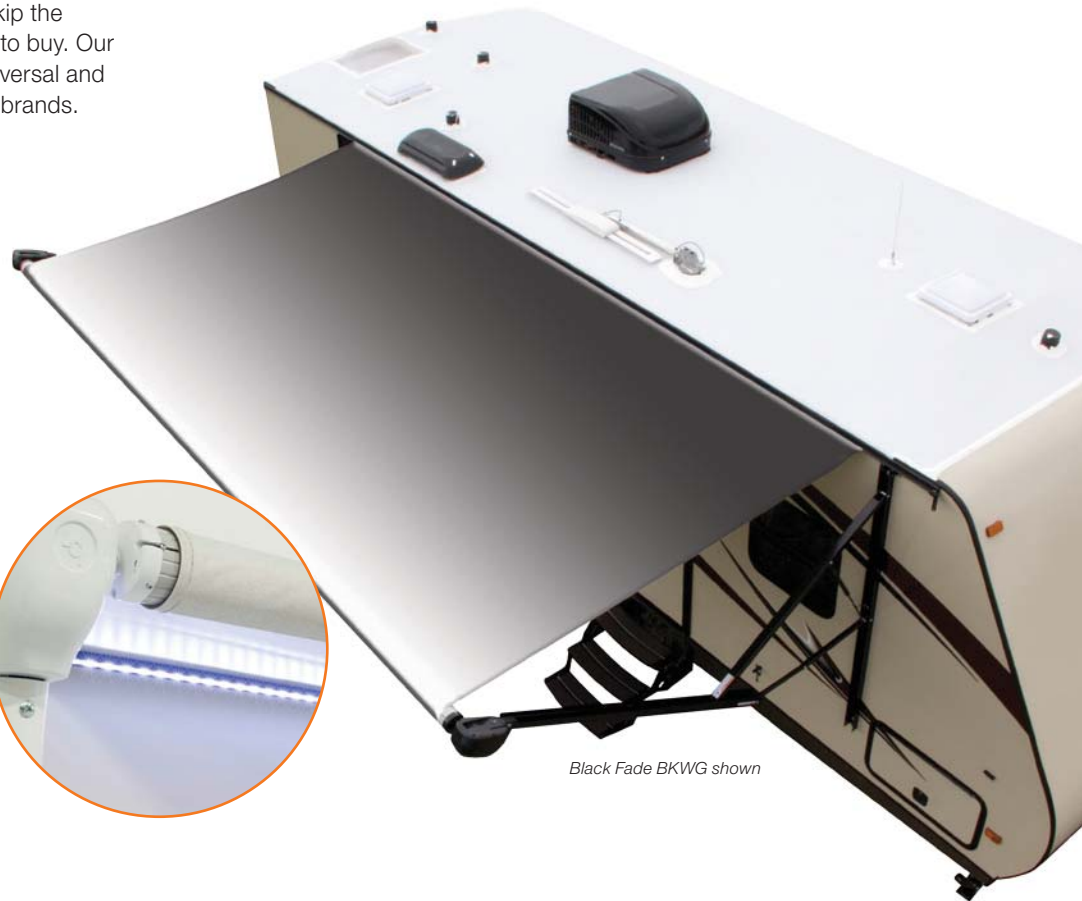

Black Fade BKWG shown

Select From Three Patio Awning Replacement Fabric Options:

All vinyl

- Heavy-duty 13.5 ounce fabric
- Cold-crack tested to -25° F
- 8 color choices























Vinyl canopy with Solera Shield

- Painted Solera Shield is available in black and white

Woven acrylic canopy with Solera Shield

- Woven fabric is breathable, so the area under the canopy may stay cooler than vinyl canopies
- 5 color choices
- Mildew-resistant fabric
- Painted Solera Shield is available in black and white

To order, measure awning center of arm to center of arm.

		Carefree	Dometic
Heavy-duty 13.5 oz fabric			
5-year prorated warranty	 5-year	 1-year	 2-year
Integrated track for LED light kit attachment			
Heat-welded fabric seams prevent leaks			
Universal fit for all awnings			
Same day shipping (in by 1:00 EST, out same day)			
Free standard UPS shipping in the continental United States			

ALIGNMENT, SUSPENSION & AXLES
LEVELING & STABILIZATION
TOWING
CARGO SECURITY & STORAGE
WASTE MANAGEMENT
AWNINGS
STEPS
SLIDE-OUTS
HAPPYJAC
DOORS & SEALS
KITCHEN & BATH
FURNITURE & MATTRESS

SOLERA UNIVERSAL REPLACEMENT FABRICS

Universal Replacement Fabrics For 8' Projection Vinyl Patio Awnings

width	black fade BKWG	white fade WHWG	sand fade BKWG	sand fade WHWG	solid black BKWG	burgundy fade WHWG	blue fade WHWG	silver fade WHWG	green fade WHWG
10'	V000334336	V000334335	V000334337	V000334346	V000334338	V000334339	V000334340	V000334345	V000345093
11'	V000334341	V000334342	V000334343	V000334344	V000334347	V000334348	V000334351	V000334353	V000345094
12'	V000334355	V000334356	V000334357	V000334358	V000334359	V000334360	V000334361	V000334363	V000345095
13'	V000334364	V000334365	V000334366	V000334367	V000334368	V000334369	V000334370	V000334372	V000345096
14'	V000334373	V000334374	V000334375	V000334376	V000334377	V000334378	V000334379	V000334382	V000345097
15'	V000334383	V000334385	V000334387	V000334388	V000334389	V000334390	V000334391	V000334393	V000345098
16'	V000334394	V000334397	V000334398	V000334399	V000334400	V000334401	V000334402	V000334404	V000345099
17'	V000334405	V000334406	V000334407	V000334408	V000334409	V000334410	V000334411	V000334413	V000345101
18'	V000334415	V000334416	V000334417	V000334418	V000334419	V000334420	V000334421	V000334423	V000345102
19'	V000334424	V000334426	V000334428	V000334429	V000334430	V000334431	V000334432	V000334434	V000345103
20'	V000334435	V000334436	V000334437	V000334438	V000334439	V000334440	V000334441	V000334443	V000345104
21'	V000334444	V000334445	V000334446	V000334447	V000334448	V000334449	V000334450	V000334452	V000345105

*The color of the exposed vinyl in the rolled up position is noted as BKWG meaning black; or WHWG, meaning white

Vinyl Fabric



Solid Black
BKSOLID



Black Fade
BKWG



White Fade
WHWG



Sand Fade
BKWG



Sand Fade
WHWG



Burgundy Fade
WHWG



Blue Fade
WHWG



Silver Fade
WHWG



Green Fade
WHWG

Acrylic Fabric



Black Cherry



Charcoal Tweed



Hemlock Tweed



Linen Tweed



Mediterranean
Blue Tweed

NOTE: All acrylic fabric features the Solera Shield

Special Order Canopy Options:

- Vinyl fabric with Solera Shield
- Woven acrylic fabric with Solera Shield

*See dealer for part #.

Solera Shield



The built-in Solera Shield provides elegant and practical protection for your Solera vinyl or acrylic awning canopy. As the awning retracts, the aluminum Solera Shield automatically rolls up around the fabric to protect it against the elements during travel. Be sure to order your Solera Shield to match your hardware.

ALIGNMENT, SUSPENSION & AXLES
LEVELING & STABILIZATION
TOWING
CARGO, SECURITY & STORAGE
WASTE MANAGEMENT
AWNINGS
STEPS
SLIDE-OUTS
HAPPYJAC
DOORS & SEALS
KITCHEN & BATH
FURNITURE & MATTRESS

SOLERA® AWNING REPLACEMENT PARTS

Power & Hybrid Awning Parts

part no.	description
295742	61 1/2" Short Awning Support Arm Assembly, White
295743	61 1/2" Short Awning Support Arm Assembly, Black
260294	66 1/8" Pitched Awning Support Arm Assembly, White
266169	66 1/8" Pitched Awning Support Arm Assembly, Black
281152	69" Standard Flat Awning Support Arm Assembly, White
281154	69" Standard Flat Awning Support Arm Assembly, Black
280343	Gas Strut 26", 124 lb For Short And Flat Arms
260282	Gas Strut, 124-144 lb For Pitched Arms
289557	Awning Plain Drive Head Front Cover, White
289560	Awning Plain Drive Head Front Cover, Black
289558	Awning Plain Drive Head Back Cover, White
289561	Awning Plain Drive Head Back Cover, Black
289563	Awning Plain Idler Head Front Cover, White
289566	Awning Plain Idler Head Front Cover, Black
289564	Awning Plain Idler Head Back Cover, White
289567	Awning Plain Idler Head Back Cover, Black
289373	Awning Cradle Support, White
289374	Awning Cradle Support, Black
406511	Rollbar Only For 12' Black Awning, Black Tube
422429	Rollbar Only For 15' Black Awning, Black Tube
422432	Rollbar Only For 16' Black Awning, Black Tube
422435	Rollbar Only For 18' Black Awning, Black Tube
422438	Rollbar Only For 21' Black Awning, Black Tube
406513	Rollbar Only For 12' White Awning, Grey Tube
422430	Rollbar Only For 15' White Awning, Grey Tube
422433	Rollbar Only For 16' White Awning, Grey Tube
422436	Rollbar Only For 18' White Awning, Grey Tube
422439	Rollbar Only For 21' White Awning, Grey Tube
275071	Grommet, Diaphragm, .75 ID x 1 OD, Black, For Manual Over-Ride Hole

Power Awning Parts

part no.	description
266149	Power Awning Replacement Motor
266146	Power Awning Plain Drive Head Assembly, White
273478	Power Awning Plain Drive Head Assembly, Black
266147	Power Awning Plain Idler Head Assembly, White
273479	Power Awning Plain Idler Head Assembly, Black
342147	Power Awning Speaker Drive Head Assembly, White
342149	Power Awning Speaker Drive Head Assembly, Black
342148	Power Awning Speaker Idler Head Assembly, White
342150	Power Awning Speaker Idler Head Assembly, Black
354181	Power Awning Speaker Drive Head Front Cover, White
354185	Power Awning Speaker Drive Head Front Cover, Black
300005	Power Awning Speaker Drive Head Back Cover, White
300009	Power Awning Speaker Drive Head Back Cover, Black
354186	Power Awning Speaker Idler Head Front Cover, White
354189	Power Awning Speaker Idler Head Front Cover, Black
300007	Power Awning Speaker Idler Head Back Cover, White
300011	Power Awning Speaker Idler Head Back Cover, Black
285499	Power Awning Switch Kit, White
285500	Power Awning Switch Kit, Black
285079	Power Awning Bezel Spacer, White
285077	Power Awning Bezel Spacer, Black
280570	16 GA Power Awning Harness
329250	Manual Pull Style To Power Awning Conversion Kit, White
329251	Manual Pull Style To Power Awning Conversion Kit, Black
337727	Manual Crank Style To Power Awning Conversion Kit, White
337728	Manual Crank Style To Power Awning Conversion Kit, Black
351863	Plain Power Awning To Speaker Head Conversion Kit, White
351864	Plain Power Awning To Speaker Head Conversion Kit, Black

ALIGNMENT, SUSPENSION & AXLES

LEVELING & STABILIZATION

TOWING

CARGO SECURITY & STORAGE

WASTE MANAGEMENT

AWNINGS

STEPS

SLIDE-OUTS

HAPPYAC

DOORS & SEALS

KITCHEN & BATH

FURNITURE & MATTRESS

SOLERA® AWNING REPLACEMENT PARTS

Manual Awning Parts

part no.	description
271181	Manual Pull Style Awning Drive Head Assembly, White
272067	Manual Pull Style Awning Drive Head Assembly, Black
272397	Manual Pull Style Awning Idler Head Assembly, White
285147	Manual Pull Style Awning Idler Head Assembly, Black
292794	Manual Awning Pull Strap Replacement
344391	Manual Awning Pull Rod
300029	Manual Crank Style Awning Drive Head Assembly, White
300031	Manual Crank Style Awning Drive Head Assembly, Black
266147	Manual Crank Style Awning Idler Head Assembly, White
273479	Manual Crank Style Awning Idler Head Assembly, Black
300030	Manual Crank Style Awning Hook And Crank Rod, White
351831	Manual Crank Style Awning Drive Head Front Cover, White
351832	Manual Crank Style Awning Drive Head Front Cover, Black
333410	Pull Style Manual to Crank Style Manual Upgrade Kit, White
333411	Pull Style Manual to Crank Style Manual Upgrade Kit, Black
299993	Grommet Diaphragm, 1.625 ID X 1.929 OD, Black, For Manual Crank Hole



300030



292794

ALIGNMENT,
SUSPENSION
& AXLES

LEVELING &
STABILIZATION

TOWING

CARGO,
SECURITY &
STORAGE

WASTE
MANAGEMENT

AWNINGS

STEPS

SLIDE-OUTS

HAPPYJAC

DOORS
& SEALS

KITCHEN
& BATH

FURNITURE &
MATTRESS

SOLERA® POWER AWNING REPLACEMENT PARTS

ALIGNMENT, SUSPENSION & AXLES

LEVELING & STABILIZATION

TOWING

CARGO SECURITY & STORAGE

WASTE MANAGEMENT

AWNINGS

STEPS

SLIDE-OUTS

HAPPIJAC

DOORS & SEALS

KITCHEN & BATH

FURNITURE & MATTRESS

Idler Head Assembly

266147 – White
273479 – Black

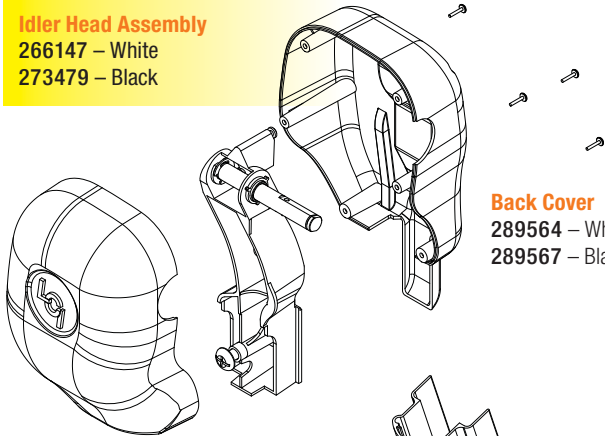

Back Cover

289564 – White
289567 – Black

Front Cover

289563 – White
289566 – Black

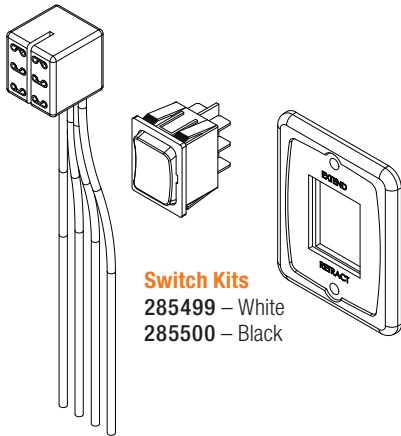

Switch Kits

285499 – White
285500 – Black

Drive Head Assembly

266146 – White
273478 – Black

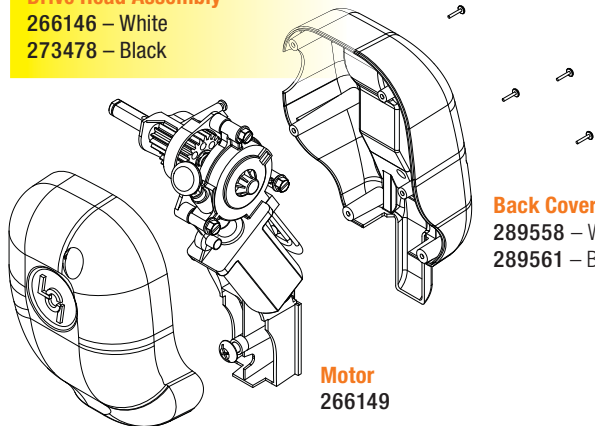

Motor
266149

Back Cover

289558 – White
289561 – Black

Front Cover

289557 – White
289560 – Black

Arms

260294 – 66-1/8" White
266169 – 66-1/8" Black
281152 – 69" White
281154 – 69" Black

Drive Side

Front of coach/right

Idler Side

Rear of coach/left

Ordering

Replacement Arms

There are three types of Solera replacement arms. These arms are universal to both power and manual awnings. Simply measure the length of the wall mount extrusion from top to bottom.

- Short style arms measure 60-1/2"
- Pitched style arms measure 66-1/8"
- Flat style arms measure 69"

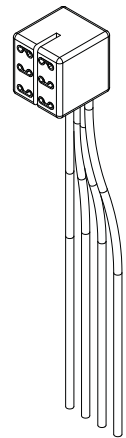

Wiring Harness
280570

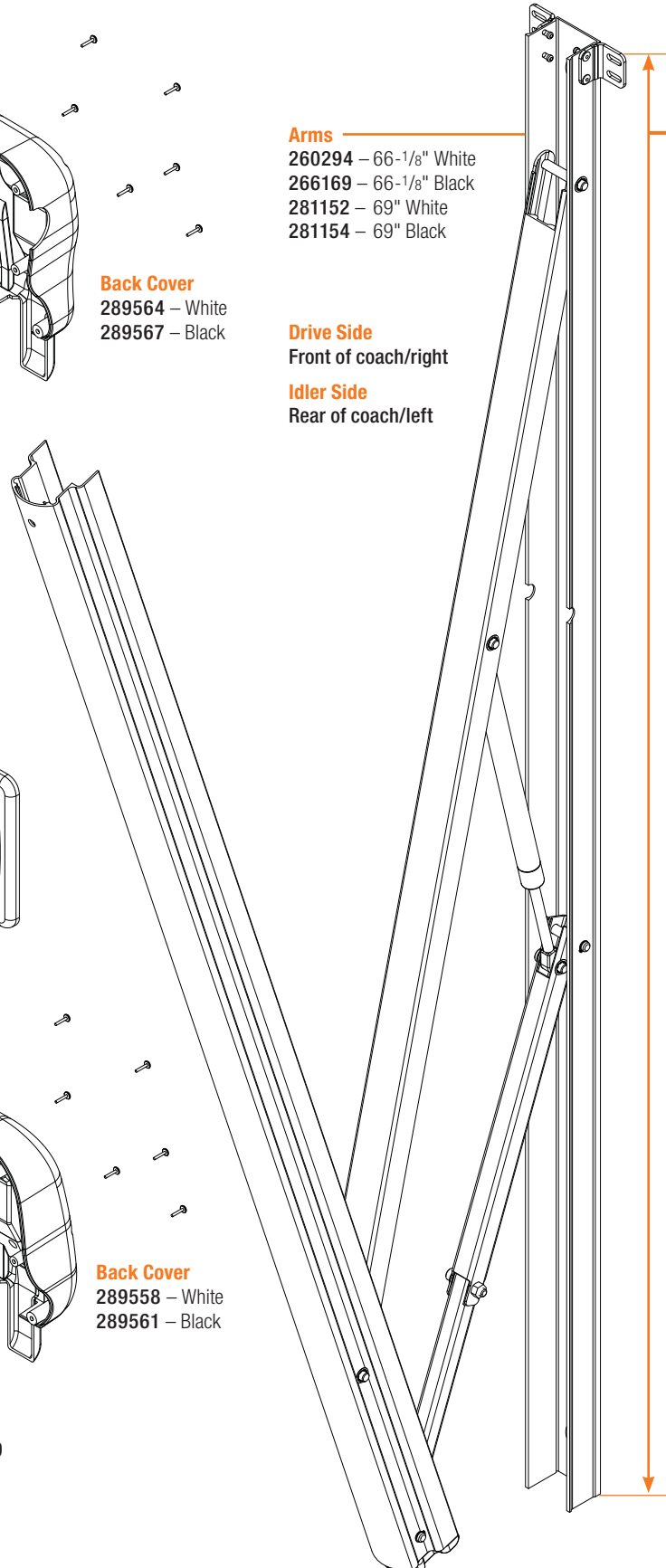

THULE CROWN

The Thule Crown is a wall-mounted awning featuring an 8-foot projection and quick release, aluminum support legs. With a large range of adapters available, the Thule Crown can be easily mounted in the awning rail of any caravan, RV or motorhome. Thule's contemporary awning design matches modern RV designs and features an improved integration on vehicle sides. This lightweight yet sturdy awning is available in seven different lengths from 6.2 feet to 14.8 feet with a maximum projection of 8.2 feet.



QUICK FACTS

- Thule's sturdy spring arms with patented tension arms ensures a perfectly tensioned awning fabric.
- Support legs are dropped vertically from the lead rail to prevent damage to the RV's exterior.
- Gaps between your RV and awning are no longer an issue. Thule created an optional tent rail to cover the gap under the awning so wall adapters are no longer visible. With the optional tent rail, you can install Thule accessories like the Thule tent or Thule LED strip.

part no.	description
COMING SOON	Thule Crown Awning

ALIGNMENT,
SUSPENSION
& AXLES

LEVELING &
STABILIZATION

TOWING

CARGO,
SECURITY &
STORAGE

WASTE
MANAGEMENT

AWNINGS

STEPS

SLIDE-OUTS

HAPPYJAC

DOORS
& SEALS

KITCHEN
& BATH

FURNITURE &
MATTRESS



STEPS

TREAD LITE® POWER STEP

You don't have to settle for a standard manual RV step. Upgrade to the sleek, stylish and lightweight Tread Lite Power Step to enjoy fast, automatic operation, weatherproof components and LED lighting. Available in a single, double or triple configuration, the Tread Lite Power Step features non-slip coating for excellent traction and obstruction-sensing technology that stops the step if anything is in its way.

QUICK FACTS

- Powerful, heavy-duty motor provides smooth operation
- Weatherproof components ensure durable operation
- 13 pounds lighter on average than the competition
- Obstruction-sensing technology prevents step damage
- Non-slip coating provides excellent traction
- LED lighting makes it easy to see step location at night
- Sleek, stylish and significantly lighter than its steel counterpart
- 8.5" step rise and tread depth
- Available in single & double configurations



part no.	description
353542	24" Single Tread Lite Power Step w/switch, harness
353543	24" Double Tread Lite Power Step w/switch, harness
353620	30" Single Tread Lite Power Step w/switch, harness
353621	30" Double Tread Lite Power Step w/switch, harness



ALIGNMENT, SUSPENSION & AXLES
 LEVELING & STABILIZATION
 TOWING
 CARGO, SECURITY & STORAGE
 WASTE MANAGEMENT
 AWNINGS
 STEPS
 SLIDE-OUTS
 HAPPYJAC
 DOORS & SEALS
 KITCHEN & BATH
 FURNITURE & MATTRESS

KWIKEE® POWER STEPS



KwikEE brand power steps have been the favorite of RVers for more than 40 years. KwikEE steps are versatile, durable and time-tested. Each 750-pound-capacity step is made in America and features air pressed rivets in the pivot points instead of bolts for long-term strength. KwikEE steps automatically extend and retract when the door is opened or closed and also feature a reflective strip for added safety.

The Revolution Step

- Extra sturdy
- 30 percent lighter than competing power steps
- Single and double step configurations
- Only weighs 24 pounds



372604



3725791

part no.	description
372604	Revolution Series. Complete Single Step (Reference OEM P/N 10000880)
3725791	Revolution Series. Complete Double Step (Reference OEM P/N 9010000464)
380073	Revolution Step Motor (Reference PGK P/N 1010002326)
363980	Revolution Step Control Module (Reference PGK P/N 1510000172)



363980



380073

ALIGNMENT, SUSPENSION & AXLES
LEVELING & STABILIZATION
TOWING
CARGO SECURITY & STORAGE
WASTE MANAGEMENT
AWNINGS
STEPS
SLIDE-OUTS
HAPPIJAC
DOORS & SEALS
KITCHEN & BATH
FURNITURE & MATTRESS

Original Kwikkee Step - Single Tread



Series 26

Rise: 5" Run: 8.5"
Bolt pattern: 7.5" x 20.5"

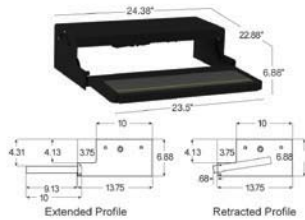

Series 28

Rise: 7" Run: 10"
Bolt pattern: 6.5" x 22"

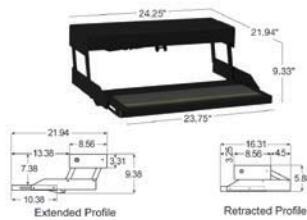

Series 30

Rise: 7.5" Run: 16.75"
Bolt pattern: 6" x 31"

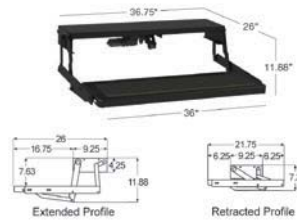

Series 33

Rise: 8" Run: 16.75"
Bolt pattern: 6" x 23.5"

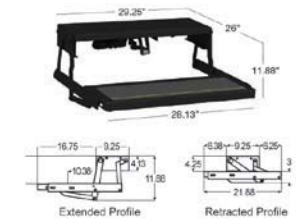

Series 35

Rise: 5" Run: 10.75"
Bolt pattern: 8" x 22"

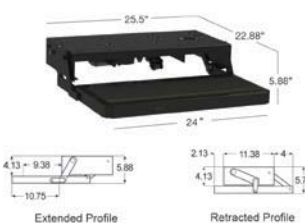

Series 36

Rise: 5" Run: 10.75"
Bolt pattern: 8" x 26"

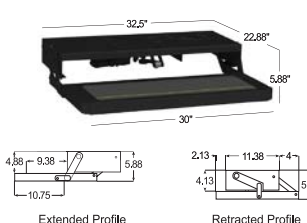

Series 38

Rise: 4" Run: 10.75"
Bolt pattern: 8" x 22"

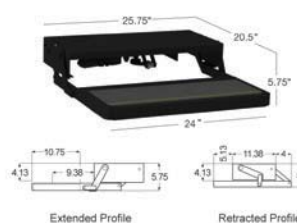

Series 39

Rise: 8" Run: 10"
Bolt pattern: 7.5" x 20.5"



*Available with brackets for van applications

*Available with brackets for van applications

step series	part no.	step control	tread size	switch kit	rise	run
26 Series	3711361	No	23.5"	371010	5"	8.5"
26 Series	3711363	Yes	23.5"	369311	5"	8.5"
28 Series	3747451	No	23.75"	371010	7"	10"
28 Series	3747453	Yes	23.75"	369311	7"	10"
30 Series	369411	No	36"	None	7.5"	16.75"
30 Series	3694112	Yes	36"	None	7.5"	16.75"
33 Series	3722662	No	28.13"	371010	8"	16.75"
33 Series	3722661	Yes	28.13"	369311	8"	16.75"
35 Series	3691462	No	24"	371010	4"	11"
35 Series	3691461	Yes	30"	369311	4"	11"
36 Series	3756271	Yes	30"	369311	5"	10.75"
38 Series	372338	No	24"	371010	4"	14"
38 Series	3723383	Yes	24"	369311	4"	14"
39 Series	3724741	Yes	23.75"	371010	7"	10"
39 Series	3724742	Yes	23.75"	369311	7"	10"

QUICK FACTS

- Supports up to 750 pounds
- Heavy-gauge steel, powder-coated for a long-lasting finish
- 12V DC motor with sealed connections
- Solid steel 3/4" drive rods and stainless steel bushings
- Electric steps available with basic power switch or Logic Control Unit sensor mode operation

**All Steps listed come with appropriate motor. **Rise/Run is estimated. See diagrams for exact dimensions. *36 Series Step dimensions have changed. Verify sizing by specific part number.

KWIKEE® POWER STEPS

The Original KwikEE Step - Double & Triple Tread



Series 32

Rise: 7" Run: 9"
Bolt pattern: 8" x 22"

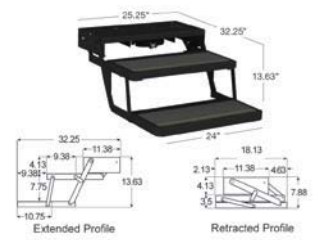

Series 34

Rise: 7" Run: 9"
Bolt pattern: 8" x 22"



Series 40

Rise: 8" Run: 9"
Bolt pattern: 8" x 26"

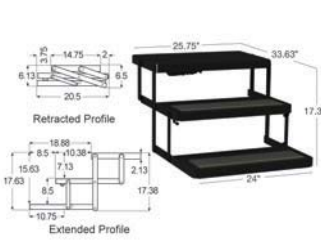

Series 42

Rise: 6" Run: 9"
Bolt pattern: 8" x 29"

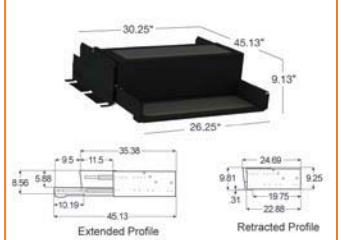

Series 23

Rise: 8" Run: 8"
Bolt pattern: 9" x 25.25"



Series 24

Rise: 8" Run: 9"
Bolt pattern: 8" x 26"



Series 25

8" Drop
Rise: 8" Run: 9"
Bolt pattern: 8" x 22"

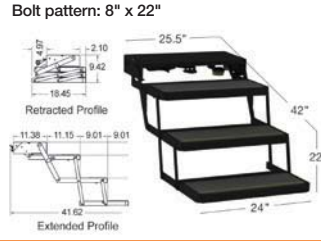

Series 25

7" Drop
Rise: 7" Run: 8"
Bolt pattern: 8" x 22"



step series	part no.	step control	tread size	switch kit	rise	run
32 Series	3722617	No	24"	371010	7"	9"
32 Series	372261	Yes	24"	369311	7"	9"
34 Series	3722863	No	30"	371010	7"	9"
34 Series	3722862	Yes	30"	369311	7"	9"
40 Series	3726891	No	24"	371010	8"	10"
40 Series	3726892	Yes	24"	369311	8"	10"
Platinum	372558	Yes	24"	none	9"	11"
42 Series	372779	Yes	26.25"	none	6"	9"
23 Series	369404	No	24"	371010	8"	8"
23 Series	3694042	Yes	24"	369311	8"	8"
24 Series	375821	Yes	30"	No Switches	8"	9"
25 Series	365837	Yes	24"	8" Drop; No Switches	8"	9"
25 Series	369552	Yes	24"	7" Drop; No Switches	7"	8"
25 Series	3658373	Yes	24"	369311	8"	9"

QUICK FACTS

- Supports up to 750 pounds
- Heavy-gauge steel, powder-coated for a long-lasting finish
- 12V DC motor with sealed connections
- Solid steel 3/4" drive rods and stainless steel bushings
- Electric steps available with basic power switch or Logic Control Unit sensor mode operation

**All Steps listed come with appropriate motor. **Rise/Run is estimated. See diagrams for exact dimensions.

ALIGNMENT, SUSPENSION & AXLES

LEVELING & STABILIZATION

TOWING

CARGO SECURITY & STORAGE

WASTE MANAGEMENT

AWNINGS

STEPS

SLIDE-OUTS

HAPPIJAC

DOORS & SEALS

KITCHEN & BATH

FURNITURE & MATTRESS



Electric Step Improvements

IMGL

Integrated Motor/Gear Box/Linkage offers improved performance and longer life.

Improved Motor

40% more motor torque gives step a strong lock-out and solid feel.

Improved Gearbox

Fully-sealed dual ball bearing improves efficiency and requires no maintenance. Case halves seal to keep consistent alignment and protect gear from the elements.

Improved Linkage

Investment cast zinc-plated steel linkage assembly is strong and more resistant to corrosion. The brass spherical outer cage hardened ball in the linkage is stronger, wears longer and will not oblong.

Improved Control Unit Logic

The 9510 Control Unit keeps the step open when the door is open. Step can be locked in the extended position, but cannot be locked in the retracted position. Automatic ignition override makes step follow the door.

MOTOR ASSEMBLY DRAWING AND PARTS KEY NUMBERS

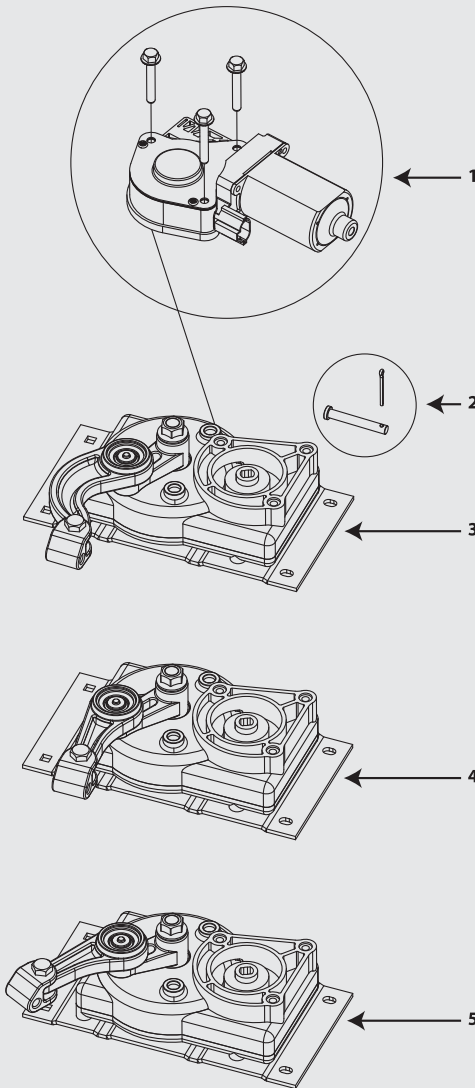

Replacement Parts Kits for Steps Series

22, 23, 30, 32, 33, 34, 35, 36, 38 and 40

parts key #	description	replacement kit part no.
1,2,3	"A" Linkage IMGL & Control Unit	379145
3	"A" Linkage Gearbox	379160
1	Step Motor Only	379147
2	Pin & Clevis Kit	379178

Replacement Parts Kits for Steps Series 28, 31, 37 and 39

parts key #	description	replacement kit part no.
1,2,4	"B" Linkage IMGL & Control Unit	379769
4	"B" Linkage Gearbox	379161
1	Step Motor Only	379147
2	Pin & Clevis Kit	379178

Replacement Parts Kits for Steps Series 26

parts key #	description	replacement kit part no.
1,2,5	"C" Linkage IMGL & Control Unit	379801
5	"C" Linkage Gearbox	379162
1	Step Motor Only	379147
2	Pin & Clevis Kit	379178

Replacement parts for older motor/control combinations are the same as for steps fitted with the IMGL and 9510 Control. IMGL and 9510 Control require a 'NORMALLY OPEN' door switch to operate correctly. Replacement switches included in kit.



379145 for steps with 'A' linkage



379769 for steps with 'B' linkage



379801 for steps with 'C' linkage

MOTORIZED STEP ACCESSORIES



Kwikee Step Control With Override & PKD

Designed to replace the step control unit on your Kwikee Step. It will automatically retract and extend the step when the coach door is opened and closed. It also includes a manual override switch.

379605



Kwikee 9510 Control For IMGL/9510 Step Control

Designed to replace the control unit on pre-IMGL step units that were manufactured from 1999 to 2005.

379146



Kwikee Control Unit For 37 and 42 Series

The Kwikee Control Unit for 37 and 42 Series is designed to automatically retract and extend step when the coach door is opened and closed.

379604



Kwikee Step Motor, Gearbox Upgrade Kit

Specifically designed for Kwikee electric step 25 series.

379804



Kwikee Step Motor Conversion Kit, 42 Series

Specifically designed for the Kwikee step 42 series.

380266



Kwikee Step Repair Kit

Specifically designed for series 28, 31, 37, 39 Kwikee electric steps.

379769



Kwikee Linkage Kit "A" Pre-IMGL

Specifically designed for certain electric Kwikee step series.

379649



Kwikee Linkage Kit "C" Pre-IMGL

Specifically designed for certain electric Kwikee step series.

379647



Kwikee Control Unit For Pre-IMGL/9510 Step Control With 5323 And 5327 Switches

Designed to replace the control unit on pre-IMGL step units that were manufactured from 1999 to 2005.

379606

ALIGNMENT, SUSPENSION & AXLES

LEVELING & STABILIZATION

TOWING

CARGO SECURITY & STORAGE

WASTE MANAGEMENT

AWNINGS

STEPS

SLIDE-OUTS

HAPPYJAC

DOORS & SEALS

KITCHEN & BATH

FURNITURE & MATTRESS

MOTORIZED STEP ACCESSORIES



Kwikee Step Motor Replacement Kit For Pre-IMGL

Designed to help the step automatically retract and extend when coach door is opened and closed. This is for a Pre-IMGL/9510 Control Step.

379608



Kwikee Step Light

For series steps 22, 23, 28, 30, 32, 33, 34, 35, 36, 38, and 40

379414



**Kwikee step only*

Kwikee Step Frame Only

If the motor control unit, light and wiring are still in working order, make your step as good as new by replacing the step frame.

3747457: 28 Series Frame **3722618:** 32 Series Frame
3658374: 25 Series Frame **3722864:** 34 Series Frame



Kwikee Plate Plunger Door Switch

Actuated as the door opens or closes.

379388



Kwikee Motor And Screws For New IMGL Step

Designed to help the step automatically retract and extend when the coach door is opened and closed.

379147



**Kwikee step only*

Kwik Test Tool

A time-saving diagnostic tool for RV service, the Kwik Test isolates step functions from RV power and wiring. Quickly locate the problem and replace only the parts needed.

379607



Kwikee Large Round Door Jam Switch

Large Round Electric Step Door Jam Switch is a replacement switch.

378054



Kwikee Step Motor Table For 42 Series

Designed to help the step automatically retract and extend when coach door is opened and closed.

372749



**Works with Kwikee and Coach steps*

Kwik Lube 11 oz. can

Regular use prevents step problems caused by other lubricants, reduces wear, and prevents rust. The cured KwikLUBE grease creates a film that is impervious to moisture and temperatures above 400° F.

379176 **379177:** Kwik Lube (Case of 24 cans)

ALIGNMENT,
SUSPENSION
& AXLES

LEVELING &
STABILIZATION

TOWING

CARGO,
SECURITY &
STORAGE

WASTE
MANAGEMENT

AWNINGS

STEPS

SLIDE-OUTS

HAPPYJAC

DOORS
& SEALS

KITCHEN
& BATH

FURNITURE &
MATTRESS

MOTORIZED STEP ACCESSORIES

ALIGNMENT, SUSPENSION & AXLES

LEVELING & STABILIZATION

TOWING

CARGO SECURITY & STORAGE

WASTE MANAGEMENT

AWNINGS

STEPS

SLIDE-OUTS

HAPPYAC

DOORS & SEALS

KITCHEN & BATH

FURNITURE & MATTRESS



Kwikee 4-Way Tester Plug With Packard Connector

The Kwikee 4-Way Tester Plug with Packard Connector fits multiple makes and models.

379416



Kwikee Plunger Door Switch With Rocker Kit

Kwikee's camper electric step switch, with rocker kit, allows you to operate your electric camper steps with the touch of a button.

379398



Also available in the original reflective and commercial yellow applications.

Kwikee Glow in the Dark Step Tread Replacements

Kwikee Glow-in-the-Dark Step Treads carry all the features of our original and commercial step treads, and also uses a reflective stripe and a night glow phosphorus stripe. 21" x 6".

379600



Kwikee Electric Step Repair Kit (Replaces Rivets)

The Kwikee Electric Step repair kit is specifically designed for certain Kwikee step series.

380269



Kwikee Cotter And Clevis Pin

The Kwikee Cotter and Clevis Pin offers a low cost option for replacing worn or broken pins.

379178



Kwikee Tape

The Kwikee Tape is designed to ensure traction on RV stairs.

358911: 32" x 8" non-skid

381178: 21" x 6" non-skid

379518: 25" x 8"

165221: 25" x 8" reflective

Grit Tape

237520: Radius Step, 21" x 3"

Anti-Skid Tape

181638: Radius Step, 19.5" x 1.25"

226893: Radius Step, 22.5" x .5"

226894: 4" x .5"

164958: 21" x 6"; Motorized



Kwikee Hardware Kit

Replaces parts within the Coach Step that helps it automatically retract and extend when coach door is opened and closed.

379646



Kwikee Electric Step Repair Kit

The Kwikee 5/8" Electric Step Frame repair kit is specifically designed for certain Kwikee step series.

380268



Kwikee Non-Skid Tread - YELLOW

The Kwikee 8" x 33" Non-Skid Tread - Yellow is designed to ensure traction on RV steps.

380063

COACH STEP® REPLACEMENT PARTS



301702



301703



301695



128958

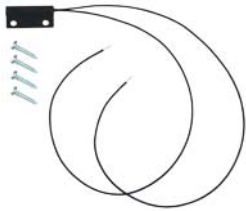

165041



301692



301699



216567



301696



116531



301701

part no.	description
301702	Electric step control module/brain
301703	Electric step amber light
301695	Electric step motor
165041	Electric step switch kit
301692	Electric step 4-way wiring harness
301699	Triple electric step gear plate
301696	Single & double electric step gear plate
116531	Electric step bronze bushing
301701	Electric step double ball joint
128958	Electric step spacer
216567	Electric step wet bolt kit

REMEDY REPAIR KITS NOW AVAILABLE

On September 18, 2015, we submitted a voluntary recall of the LCI Coachstep electric double and triple entrance steps produced from May 25, 2007 through December 18, 2014. We are offering repair kits at no charge for all motorhomes that have been affected by this.

part no.	description
389761	Each Double Coachstep Repair kit includes the pieces necessary to install a retainer bracket on a Double Coachstep assembly.
389152	Each Triple Coachstep Repair kit includes the pieces necessary to install a linkage assembly and a retainer bracket on a Triple Coachstep assembly.

ALIGNMENT,
SUSPENSION
& AXLES

LEVELING &
STABILIZATION

TOWING

CARGO,
SECURITY &
STORAGE

WASTE
MANAGEMENT

AWNINGS

STEPS

SLIDE-OUTS

HAPPYJAC

DOORS
& SEALS

KITCHEN
& BATH

FURNITURE &
MATTRESS

MANUAL ENTRY STEPS

ALUMI-TREAD Step®

Upgrade your RV with the sleek, Euro-style Alumi-Tread hybrid step featuring strong, proven steel linkage and attractive aluminum treads with anti-slip rubber grooves for excellent traction. Lightweight aluminum step treads resist rust, ensuring long-lasting durability. The Alumi-Tread Step is available in triple and quad configurations, and provides both style and functionality. Alumi-Tread lends a clean, modern appearance to your RV and consistent, smooth operation at an attractive price point.



432696

part no.	description
432696	Alumi-Tread Triple Manual Step
432698	Alumi-Tread Quad Manual Step



432698

ALIGNMENT,
SUSPENSION
& AXLES

LEVELING &
STABILIZATION

TOWING

CARGO,
SECURITY &
STORAGE

WASTE
MANAGEMENT

AWNINGS

STEPS

SLIDE-OUTS

HAPPYAC

DOORS
& SEALS

KITCHEN
& BATH

FURNITURE &
MATTRESS

MANUAL RADIUS STEPS

One step ahead of the competition

Lippert Components provides a full line of radius style steps for towable RV's. These steps extend and retract easily with only one hand. All steps have a black powder coat finish that will protect it from the elements. All steps are 24" wide and come with anti-slip skid tape.

QUICK FACTS

- New compact design allows user to expand and collapse step with one hand
- All four steps are equidistant from each other, taking the guesswork out of step location
- Powder coat finish protects from the elements

part no.	description
432678	24" Radius Single Manual Step
432682	24" Radius Double Manual Step
432687	24" Radius Triple 7" Manual Step
432690	24" Radius Triple 9" Manual Step
432693	24" Radius Quad 8" Manual Step

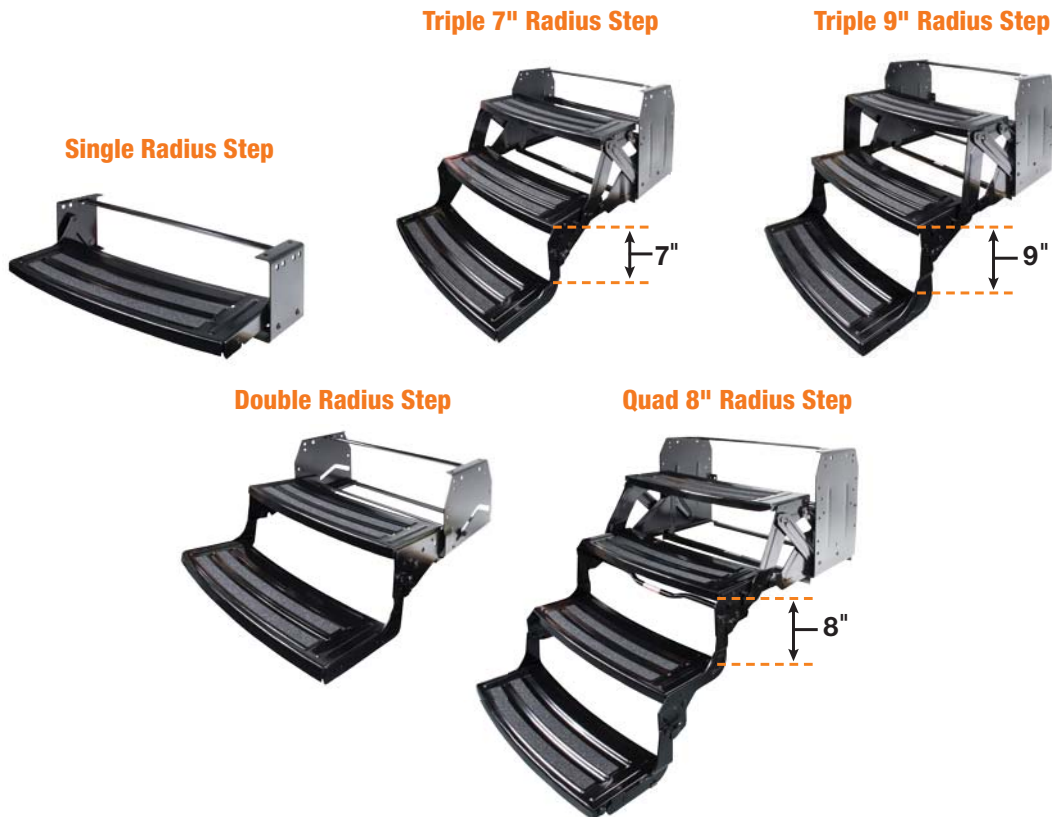

- ALIGNMENT, SUSPENSION & AXLES
- LEVELING & STABILIZATION
- TOWING
- CARGO, SECURITY & STORAGE
- WASTE MANAGEMENT
- AWNINGS
- STEPS
- SLIDE-OUTS
- HAPPYJAC
- DOORS & SEALS
- KITCHEN & BATH
- FURNITURE & MATTRESS

A close-up photograph of a white RV slide-out mechanism. The slide-out is partially extended, showing a window with a black frame and a yellow highlight on the side panel. The background is a clear blue sky. The text "SLIDE-OUT ACCESSORIES & PARTS" is overlaid in white on a yellow rectangular background in the lower-left corner.

SLIDE-OUT ACCESSORIES & PARTS

FLEX GUARD

The patented Flex Guard is a heavy-duty, flexible rail that offers support and protection to vital slide-out plumbing, wiring and hoses under the slide room floor. The Flex Guard straightens out during extension and bends in an arc as it contracts. Its unique design prevents sagging during slide-out operation that could cause stress and lead to breakage.

QUICK FACTS

- Can be installed on any slide-out system that uses a 1/4" steel rod or swing arm for the same application
- Single, double and triple applications
- All kits come with 8" mounting post with washer and five Flex Guard clips

part no.	description
1346271	Single Flex Guard Kit
1346281	Double Flex Guard Kit
1346291	Triple Flex Guard Kit



Single Flex



Double Flex



Triple Flex

SLIDE-OUT SLICKER

Every time your slide room extends and retracts, it rubs your carpet just enough to create a worn-out spot over time. Slide-Out Slickers protect your carpet and keep it looking like new.

- Easy to install
- Comes in a two pack
- 40 inches long

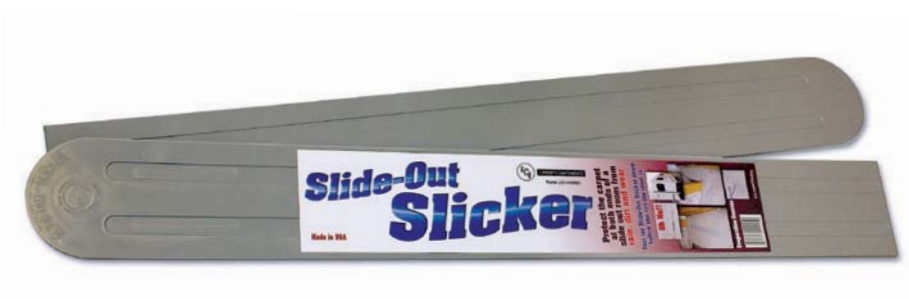

part no.	description
134993	Slide-Out Slicker (Pair)

ALIGNMENT,
SUSPENSION
& AXLES

LEVELING &
STABILIZATION

TOWING

CARGO,
SECURITY &
STORAGE

WASTE
MANAGEMENT

AWNINGS

STEPS

SLIDE-OUTS

HAPPYJAC

DOORS
& SEALS

KITCHEN
& BATH

FURNITURE &
MATTRESS

THROUGH-FRAME & ABOVE-FLOOR SLIDE-OUT MOTORS & ACTUATORS

If both motor and actuator need replaced, use 168956:

168956 Venture Actuator with High Speed Motor

Manufacturer Part No.: 8532-18HT

For use in:

LCI® Electric Through-Frame Slide-Outs 12VDC | 9,500 RPM | 30 Amps | 18:1 Gear Ratio



If actuator only needs replaced, use 145595:

145595 40" Venture Actuator only also works with Tuson Motors

For use in:

LCI Electric Through-Frame Slide-Outs



If only motor needs replaced, get specs from motor label and order accordingly

132682 Venture 18:1 Actuator Motor

For use in:

LCI Electric Through-Frame Slide-Outs 12VDC | 5,800 RPM | HP: 1/2 | 30 Amps 18:1 Gear Ratio | 7694597



136373 Venture 28:1 Actuator Motor

For use in:

LCI Electric Through-Frame Slide-Outs 12VDC | 5,800 RPM | 30 Amps | 28:1 Gear Ratio | 8532-08J



125802 Tuson High Speed 18:1 Motor

For use in:

LCI Electric Through-Frame Slide-Outs 12VDC | 9,000 RPM | 30 Amps | 18:1 Gear Ratio | 1-065-041-012



Additional slide-out motors

138449 D-300 Motor manufactured by Klauber

Manufacturer Part No.: K01285D300

For use in:

LCI 3 x 3 Through-Frame Electric Slides 12VDC | 12 RPM | 9 Amps | 3/4" Drive



130057 N-500 Motor manufactured by Klauber

Manufacturer Part No.: K01285N500

For use in:

LCI Electric Above-Floor Sofa & Bed Slides 12VDC | 10.5 RPM | HP: 1/15 | 7 Amps | 3/4" Drive



133612 Tuson Motor, Drive Shaft & Right Angle Gear Box

Manufacturer Part No.: 1A0650122401YC

For use in:

LCI Electric Above-Floor Sofa & Bed Slides 12VDC | 9,000 RPM | 18:1 Gear Ratio



Slide-Out Motors

part no.	description
168956	Venture Actuator & High Speed Motor
132682	Venture 18:1 Actuator Motor
136373	Venture 28:1 Actuator Motor
125802	Tuson High Speed Actuator Motor

part no.	description
138449	D-300 Motor
130057	N-500 Motor
133612	Tuson Right Angle Gear Box & Motor
145595	Actuator Rod Only; 40"

ALIGNMENT, SUSPENSION & AXLES
LEVELING & STABILIZATION
TOWING
CARGO, SECURITY & STORAGE
WASTE MANAGEMENT
AWNINGS
STEPS
SLIDE-OUTS
HAPPYJAC
DOORS & SEALS
KITCHEN & BATH
FURNITURE & MATTRESS

HYDRAULIC CYLINDERS & TRUNNIONS



125653



123603

Hydraulic Slides

part no.	bore	stroke	ext. length	ret. length	use
125653	1-1/2"	24"	63"	39"	2 x 2 Hydraulic Through-Frame Slides
123603	1-1/2"	38"	53"	91"	2.5 x 2.5 Hydraulic Through-Frame Slides



141111



177094



142927



138416



249363



113128



113131



141020

Hydraulic Cylinders

part no.	description
141111	Hydraulic Pump & Power Unit
177094	Hydac Cartridge Valve
142927	Nason Pressure Switch
138416	Hydraulic Hose End Fitting
249363	O-Ring Face Seal
113128	Fitting 6801-04-04; JIC To O-Ring 900 Elbow
113131	Fitting 6400-04-04; Straight Fitting
141020	Fitting 6809-04-04; 900 Swivel Elbow

ALIGNMENT,
SUSPENSION
& AXLES

LEVELING &
STABILIZATION

TOWING

CARGO,
SECURITY &
STORAGE

WASTE
MANAGEMENT

AWNINGS

STEPS

SLIDE-OUTS

HAPPYJAC

DOORS
& SEALS

KITCHEN
& BATH

FURNITURE &
MATTRESS

ALIGNMENT, SUSPENSION & AXLES
 LEVELING & STABILIZATION
 TOWING
 CARGO SECURITY & STORAGE
 WASTE MANAGEMENT
 AWNINGS
 STEPS
 SLIDE-OUTS
 HAPPYAC
 DOORS & SEALS
 KITCHEN & BATH
 FURNITURE & MATTRESS

ELECTRICAL PARTS

part no.	description
117461	White Slide-Out Switch Kit (switch, bezel & harness)
117460	Black Slide-Out Switch Kit (switch, bezel & harness)
135666	Slide-Out Controller 10665
118246	Trombetta Solenoid; Silver Posts



117461



117460



135666



118246

MISC. PARTS

part no.	description
281331	2 x 2 Slide-Out Gear Pack
324869	2.5 x 2.5 Standard Slide-Out Gear Pack
123356	2.5 x 2.5 Heavy-Duty Slide-Out Gear Pack
140409	2 x 3 & 3 x 3 Standard Slide-Out Gear Pack
116658	Crown Gear for LCI Slide-Outs
118353	Roller Bearing for Above Floor Slide-Outs
103480	Universal LCI™ Slide-Out Wear Pad
119226	Standard Manual Slide-Out & Landing Gear Crank Handle
122840	Standard Stop Can



281331



140409



123356



324869



116658



118353



119226



122840



103480

IN-WALL® SLIDE-OUT PARTS

Introduced in 2009, our In-Wall Slide-Out System has revolutionized the RV Industry. All motors and mechanics are located in the slide walls and the patented aircraft-quality worm rail provides smooth and efficient slide-out movement.

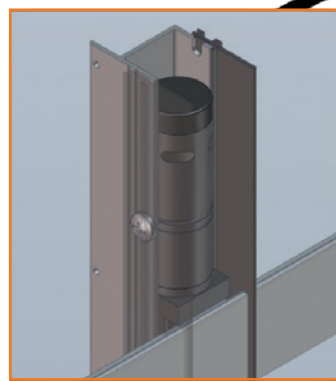
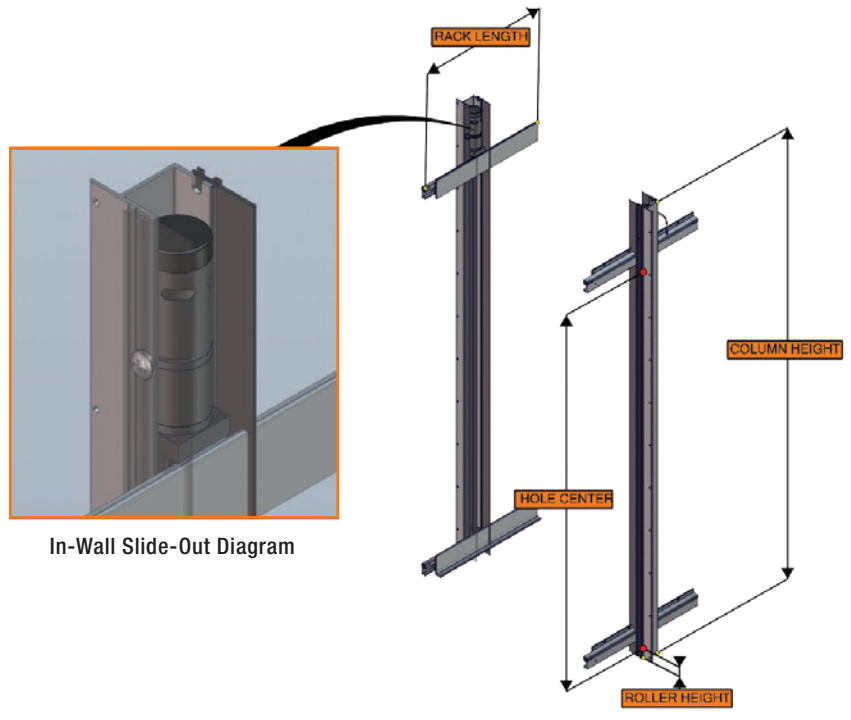

In-Wall Slide-Out Diagram

Slide-Out System

part no.	description
236575	In-Wall Slide Motor
211852	In-Wall Slide Controller V-Sync2
120639	Interior Switch & Plate
320500	J38 Roller for In-Wall Slide-Out

part no.	description
247768	15' Wiring Harness
229755	20' Wiring Harness
238991	25' Wiring Harness
229756	30' Wiring Harness
238992	35' Wiring Harness

ALIGNMENT, SUSPENSION & AXLES
 LEVELING & STABILIZATION
 TOWING
 CARGO, SECURITY & STORAGE
 WASTE MANAGEMENT
 AWNINGS
 STEPS
SLIDE-OUTS
 HAPPYJAC
 DOORS & SEALS
 KITCHEN & BATH
 FURNITURE & MATTRESS

SEALS

Every seasoned RVer knows its good practice to periodically inspect and replace RV seals to ensure water resistance and prevent leaks. When your customers need new seals, be ready with our complete line of premium, weather-resistant trim and seal solutions for roofs, windows, doors, slide-outs and more.



FEATURING SNAP-IN AND ADHESIVE-BACK TRIMS & SEALS FOR ALL RV NEEDS

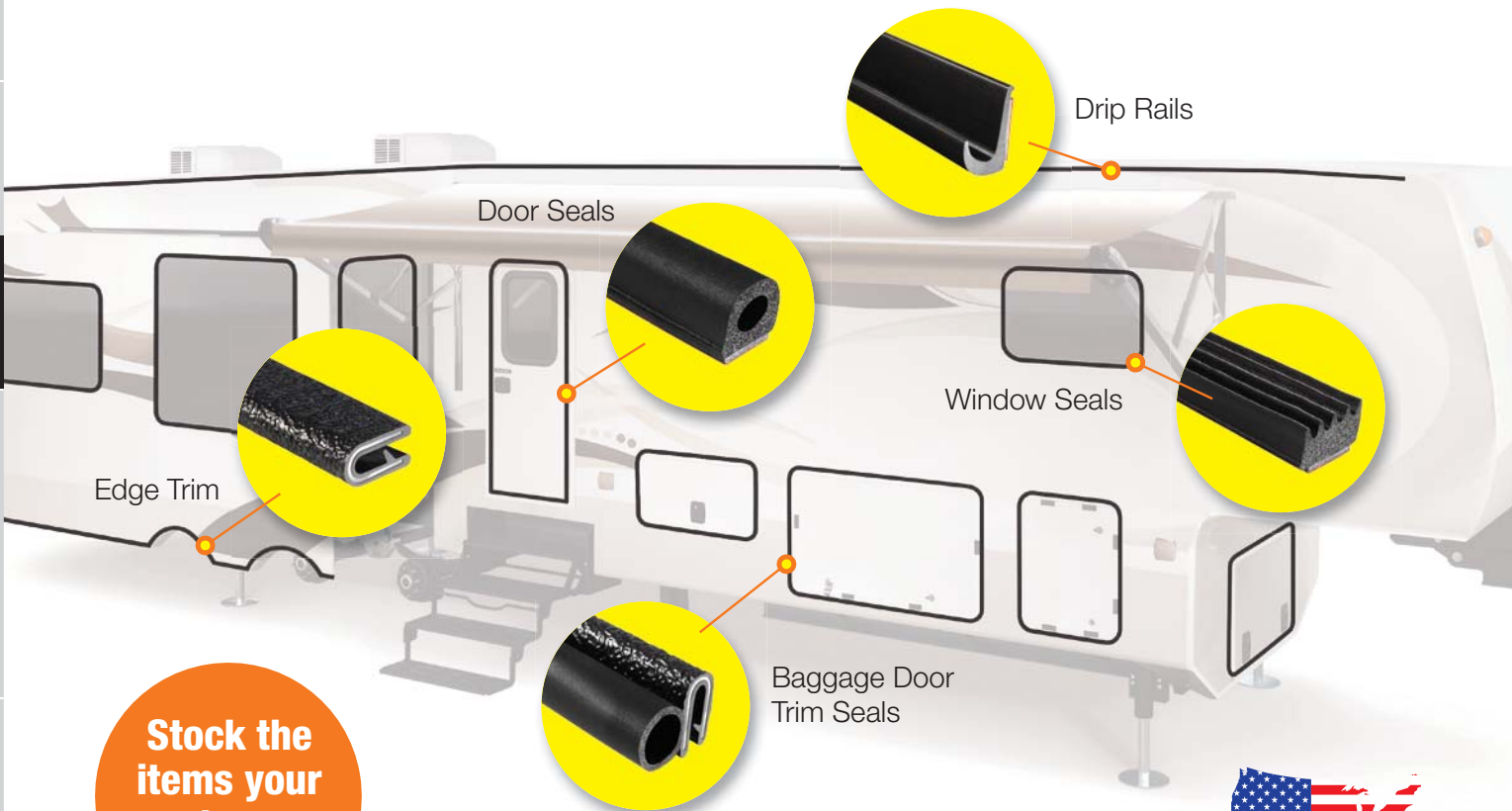

Stock the items your customers need



MADE IN USA

ALIGNMENT, SUSPENSION & AXLES
LEVELING & STABILIZATION
TOWING
CARGO SECURITY & STORAGE
WASTE MANAGEMENT
AWNINGS
STEPS
SLIDE-OUTS
HAPPYAC
DOORS & SEALS
KITCHEN & BATH
FURNITURE & MATTRESS

PRODUCTS

- Edge trim for roof vents, doors and other openings
- Door and window seals
- Baggage door seals
- Slide-out seal flaps
- Drip rail trim

part no.	description
SLIDE OUT FLAP WITH SCREWS	
388360	Slide Out Flap Seal, 20' (I11136)

BAGGAGE DOOR TRIM SEAL	
388361	Baggage Door Trim Seal, 25' (CP1330)
388362	Baggage Door Trim Seal, 25' (DD6126)
388363	Baggage Door Trim Seal, 25' (4100B3X1/8A)
388364	Baggage Door Trim Seal, 25' (6100B3X1/8A)

REGULAR TRIM	
388365	Edge Trim, 25' (62B3X1/16)
388366	Edge Trim, 25' (100B3X1/8)

RUBBER SEAL	
388367	Rubber Seal, 10' (X2828BT)
388368	Rubber Seal, 50' (X113BT)
388369	Rubber Seal, 50' (X1333BT)
388370	Rubber Seal, 25' (X103BT)
388371	Rubber Seal, 25' (X202BT)
388372	Rubber Seal, 25' (X109BT)
430486	Snap-In Seal 20' (I11302 - 1.310)

DRIP RAIL	
388373	Drip Rail White, 40' (DRW)
388374	Drip Rail Black, 40' (DRB)

SCREW CAP COVER	
388375	Screw Cap Cover White, 40' (I11021)

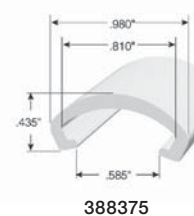
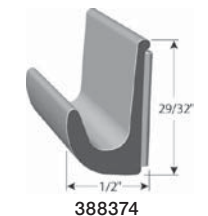
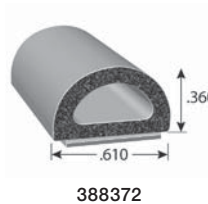
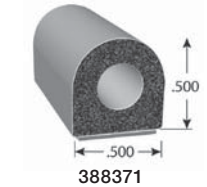
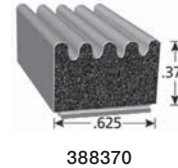
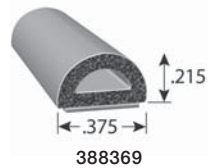
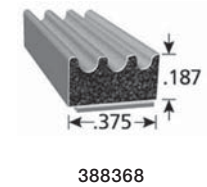
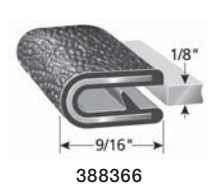
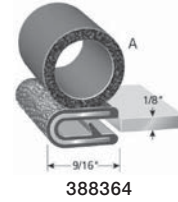
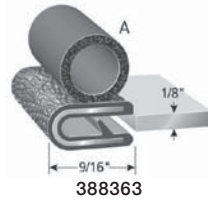
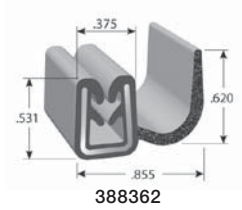
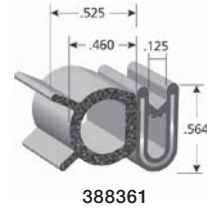
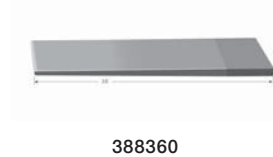

HAPPIJAC TRUCK CAMPER ACCESSORIES





QUICK FACTS

- 36.5" lift combined with 51" outer tube offers maximum clearance
- Easy-to-access manual override with full 360-degree cranking
- 2,800-pound load rating ideal for multi-slide truck campers
- Efficient, precision CAD design sustains quiet operation
- Plated and powder-coated outer tube resists corrosion
- Field serviceable with easy access to all components
- Wireless control kit available
- Low amp draw
- Each HappiJac Camper Jack has a high quality zinc and powder-coat finish.

4800 Jack

The innovative, heavy-duty 4800 Jack by HappiJac combines customer feedback, research and rigorous testing to provide a stronger, safer jack with an impressive 2,800-pound load rating. Ideal for multi-slide truck campers, the 4800 Jack boasts robust strength, stability and efficiency with a self-lubricating bronze nut, a polished screw and a large Torrington thrust bearing. Three extra inches of length yield maximum clearance and significantly improves lateral and structural support. Each HappiJac Camper Jack features attractive 2-inch square tubing that provides significantly more strength than round tubing.

**HappiJac jacks can easily be upgraded from manual, hand-crank jacks into a remote-controlled electric jack system with the purchase and simple installation of the wireless HappiJac motor drive assembly kit (600700) and wiring kit (600730).*



Jacks

part no.	description
308169	Single 4160 Acme Screw Jack (1,500 lbs.)
308170	Single 4560 Ball-Screw Jack (1,900 lbs.)
313774	Single 4800 Heavy-Duty Acme Jack (2,800 lbs.)

Electric Options

part no.	description	includes
182522	600700; Motor Drive Assembly w/ Wireless Remote	<ul style="list-style-type: none"> • 1 ea. wireless main logic board • 1 ea. remote coiled cable • 1 ea. wireless remote controller • 4 ea. motor drive heads
182524	600730; Wiring Kit for Electric Option	<ul style="list-style-type: none"> • 2 ea. 9' 12 AWG w/connector • 4 ea. junction boxes • 2 ea. 20' 12 AWG w/connector
183070	Wireless Remote Controller	
183069	Wireless Main Logic Board	
182515	Single Electric Motor Drive Head	
139315	Wireless Upgrade Kit (Remote Controller and Wireless Logic Board)	

Brackets & Accessories

part no.	description
182493	16" (Z) Mounting Bracket
182492	16" (L) Reinforcement Bracket (front)
182491	5" Lower Mounting Bracket (rear)
182436	Standard (4") Crank Handle
1824362	Long (8") Crank Handle
182496	Swing-Out Extension Brackets
182495	6" Lift Extenders (4 ea.)
182912	Hex Drive Adapter

QWIK-LOAD® TURNBUCKLES

ALIGNMENT, SUSPENSION & AXLES
LEVELING & STABILIZATION
TOWING
CARGO SECURITY & STORAGE
WASTE MANAGEMENT
AWNINGS
STEPS
SLIDE-OUTS
HAPPIJAC
DOORS & SEALS
KITCHEN & BATH
FURNITURE & MATTRESS



The strong and sturdy stainless steel Qwik-Load Turnbuckles feature fast lever action, are easy to install and can be adjusted after installation.



Qwik-load Turnbuckles

These strong, lever-action turnbuckles provide quick installation and feature a stainless steel barrel. There is no need to remove the turnbuckle to make tension adjustments. The FM-QLTB includes 2 front spring-loaded Qwik-Load turnbuckles with 11-inch hooks, 2 rear stress-guard Qwik-Load turnbuckles with 24-inch hooks, 4 removable handles and 4 locking pins.



Standard Turnbuckles

The kit includes 2 spring-loaded front turnbuckles and 2 stress-guard rear turnbuckles with stainless steel components.



Qwik-load Upgrade

This Qwik-Load upgrade kit comes with 4 Qwik-Load adapters, locking pins and 4 removable handles. It's compatible with any turnbuckles using a 1-inch threaded rod.



Long-action Turnbuckles

HappiJac now offers turnbuckles that reach below the side of the truck in 40-inch long action. The FM-QLLA kit includes 2 Qwik-Load lever-action, spring-loaded stainless steel turnbuckles. The FM-TBLA includes 2 spring-loaded, stainless steel turnbuckles.

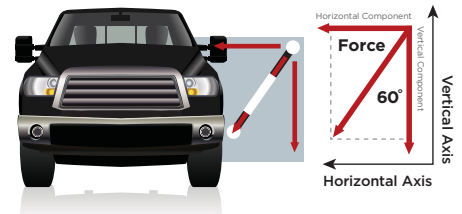

Fully Adjustable

Tension can be adjusted after installation for maximum stability

Turnbuckles

part no.	description
182895 FM-QLTB	Qwik-Load Stainless Steel Turnbuckle Set
standard turnbuckles	
182898 FM-TB	Stainless Steel Turnbuckle Set
182901 FM-TBS	Single Stainless Steel Front Turnbuckle
182900 FM-TBR	Single Stainless Steel Rear Turnbuckle
qwik-load upgrade kit	
182894 FM-QL	Qwik-Load Upgrade Kit
long-action turnbuckles	
191380 FM-QLLA	Qwik-Load Long Action
191431 FM-TBLA	Spring-Loaded Turnbuckle Set (Long Action)

HAPPIJAC® FRAME-MOUNT TIE-DOWN SYSTEMS SEALS



Hapjiac's innovative Frame-Mount Tie-Down System puts leverage to work for you. Its design combines frame strength and sound engineering principles to create an I-beam truss structure that makes your camper an integral part of the truck, providing unsurpassed strength and security. Its frame mount is strong and easy to use. While other tie-downs may "hold your camper down," only Hapjiac Tie-Downs prevent camper movement in all directions (up-down, side-to-side, and front-to-back).



QUICK FACTS

- Price is significantly less than other heavy-duty tie-down systems
- I-Beam truss creates a superior system by utilizing the truck frame, bed and tie-down components to form an I-beam truss structure
- Adds only 27 lbs. to the truck and eliminates ugly protrusions

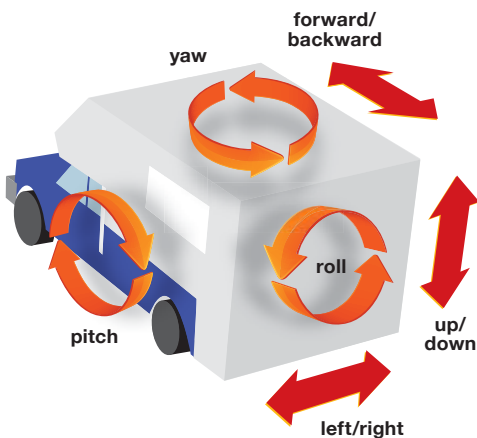

Controls Camper Movement

Only system that controls camper movement in all directions

- ALIGNMENT, SUSPENSION & AXLES
- LEVELING & STABILIZATION
- TOWING
- CARGO, SECURITY & STORAGE
- WASTE MANAGEMENT
- AWNINGS
- STEPS
- SLIDE-OUTS
- HAPPIJAC
- DOORS & SEALS
- KITCHEN & BATH
- FURNITURE & MATTRESS

HAPPIJAC® FRAME-MOUNT TIE-DOWN SYSTEMS & PARTS



Direct-to-Frame Tie-Down Components (A)

make	part no.	description
Chevrolet / GMC	FT-CG14 1 (350763)	2015 - 2017 Chevy/GMC Silverado/Sierra (all) 2014 Chevy/GMC Silverado/Sierra 1500 (with step bumper)
	FT-CG07S 1,3 (182905)	2007 - 2014 Chevy/GMC Silverado/Sierra (except extended cab & 2014 1500 Series)
	FT-CG07 1,3 (182904)	2007 - 2013 Chev/GMC Silverado/Sierra (extended cab only)
	FT-CG9 1 (182906)	1999 - 2007 Chevy Silverado Classic/GMC Sierra Classic
	FT-UT9 1 (182910)	1988- 2000 C/K Series (old body style)
Dodge	FT-DR10 5 (236326)	2010 - 2017 Ram 2500, 3500 (except "Ram Box" or short bed dually) 2009 - 2017 Ram 1500 (except "Ram Box" or short bed dually)
	FT-DR8 5 (205220)	2008 - 2009 Ram (w/ bed front panel vertical ribs only) (Including 2002 Ram 1500)
	FT-DR2 2 (182908)	2003 - 2008 Ram (w/ bed front panel vertical ribs only) (Including 2002 Ram 1500)
	FT-UT9 1 (182910)	1994 - 2002 Ram (except 2002 Ram 1500)
	FT-DR2 2 (182908)	2002 Ram 1500
Ford	FT-UT9 1 (182910)	2008 - 2016 F450 Super Duty 1997 - 2016 F250 Super Duty & F350 1980 - 1996 F Series (all)
Toyota	DF-TT07 4 (184089)	2007 - 2017 Tundra (6 ½' Bed ONLY)

FT Kit (now includes centering guides)



(FT-UT9 shown)

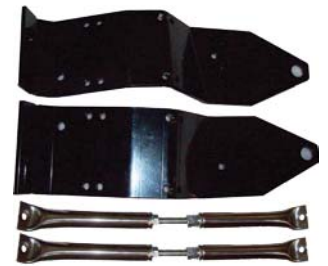

(DF-TT07 shown)

Turnbuckle Component (B)

part no.	description
FM-QLTB (182895)	Qwik-Load stainless steel turnbuckle set (2 FM-QLTBS & 2 FM-QLTBR)
FM-TB (182898)	Stainless steel turnbuckle set (2 FM-TBS & 2 FM-TBR)
FM-QL (182894)	Qwik-Load lever-action turnbuckle upgrade



FM-QLTB shown

Stabilizing Bar (C)

part no.	description
USB-010 (182971)	59.25" Stabilizing bar (use with FM/FT UT9 & CG9)
SB-020 (182928)	57.375" Stabilizing bar (use with FM/FT DR2)
SB-080 (205221)	56.875" Stabilizing bar (use with FT-DR8)
SB-150 (182930)	69" Stabilizing bar (use with CA-UT8: 1980 - 98 Ford)
SB-200 (182931)	66.75" Stabilizing bar (use with CA-DRL: 1994 - 2002 Dodge Ram)



USB-010 shown

1 If extended cab use FT-CG07. 2 Stabilizing Bar USB-010 Required, sold separately. 3 Stabilizing Bar SB-020 Required, sold separately. 4 Includes FM-CBB07. 5 Does not require Stabilizing Bar. 6 Stabilizing Bar SB-080 Required, sold separately

ALIGNMENT, SUSPENSION & AXLES
LEVELING & STABILIZATION
TOWING
CARGO SECURITY & STORAGE
WASTE MANAGEMENT
AWNINGS
STEPS
SLIDE-OUTS
HAPPIJAC
DOORS & SEALS
KITCHEN & BATH
FURNITURE & MATTRESS

HAPPIJAC® CAMPER ANCHOR TIE-DOWN SYSTEMS & PARTS

HappiJac Camper Anchor Tie-Downs provide maximum strength and eliminate leverage and stress forces on a truck. A removable rear tie-down coupler rotates to the direction of pull, eliminating undesirable torque. HappiJac Camper Anchor Tie Downs won't bend, twist or fail.

NOTE: With the exception of the CA-FD4 & CA-FD7, the older style "CA" prefix camper tie-downs listed below do not contain a frame mount component and were designed for use on older trucks or with campers under 2,500 pounds of dry weight. Whenever possible, an "FT" prefix model tie-down set is the best option and must be used on extended or crew cab trucks or campers over 2,500 pounds of dry weight.

Camper Anchor Tie-Downs

make	part no.	description
Chevrolet / GMC	CA-CG3 (182853)	1973 - 1987 C/K Series
	CA-FU (182862)	1967 - 1972 C/K Series
	CA-UR 7 (182866)	1973 - 2011 S-10, S-15, Canyon & Colorado
Dodge	CA-DRL 9 (182858)	1994 - 2002 Ram (Except 2002 Ram 1500)
	CA-FU 8 (182862)	1991 - 1993 Ram
	CA-FU (182862)	1972 - 1990 Ram
Ford	CA-FD4 (182860)	2004 - 2014 F150
	CA-FD7 (182861)	2004 - F150 Heritage 1997 - 2003 F150 & F250 under 8500 gvw (except crew cab)
	CA-FU (182862)	1966 - 1979 F-Series (except 1979 F350 w/ side tire)
	CA-UR 7 (182866)	2013 and earlier Ranger
Toyota	CA-UR 7 (182866)	1989 - 2017 Toyota (only with campers under 1,500 lbs.) (except Tundra)
	CA-MT (182864)	1988 and earlier Toyota
Isuzu	CA-UR 7 (182866)	1989 - 2008 Isuzu
	CA-MT (182864)	1988 and earlier Isuzu
Mazda	CA-UR 7 (182866)	1994 - 2008 Mazda
	CA-MT (182864)	1993 - and earlier Mazda
Nissan	CA-UR 7 (182866)	1998 - 2016 Nissan
	CA-MT (182864)	1997 - and earlier Nissan

7 Requires 4 ea, (sold individually). 8 Requires FK-DAK Fit Kit (sold separately) 9 Stabilizing Bar SB-200 recommended, sold separately

Parts, Fit Kits & Accessories

part no.	description
CA-UR (182866)	Universal Rear Anchor
CA-AB (182852)	Chrome Anchor Bolt (Including Hardware)
CA-TC (182865)	Chrome Coupler
FM-FGL9 (182892)	Front Centering Guide Locks (includes 2 rollers and 2 bumpers)
FA-UT9 (182876)	Front Anchor Plates (Set of 2)
FA-CG9 (182872)	Front Anchor Plates (Set of 2)
FA-CG07 (182870)	Front Anchor Plates (Set of 2)
FA-CG07S (182871)	Front Anchor Plates (Set of 2)
FK-DAK (182880)	Dodge Adapter Kit
FK-GBS (182883)	Centering Guide Lock Spacer Kit for 1999+ Ford with tail light - camper interference
FK-CG07 (182877)	Replacement Fit Kit for FT-CG07/CG07S
FK-UT9 (182884)	Replacement Fit Kit for FM / FT-UT9
FK-CG9 (182878)	Replacement Fit Kit for FM / FT-CG9
FM-BB08 (253561)	Bumper Brace (2008-2014) F350 & F350 Super Duty
FM-BB9 (182885)	Bumper Brace (1999 - 2007) F250 Super Duty & F350
FM-CBB07 (182887)	Bumper Brace (2007 - 2014) Chev/GMC
FM-QLTBS (182897)	Qwik-Load Front spring-loaded turnbuckle w/11" threaded hook (1 ea.)
FM-TBS (182901)	Front spring-loaded turnbuckle w/11" threaded hook (1 ea.)
FM-QLTBR (182896)	Qwik-Load Rear stress-guard turnbuckle w/24" threaded hook (1 ea.)
FM-TBR (182900)	Rear stress-guard turnbuckle w/24" threaded hook (1 ea.)
TBH-11 (149813)	11" threaded hook (zinc plated -1 ea.)
TBH-24 (149814)	24" threaded hook (zinc plated -1 ea.)



CA-FD7 shown



CA-FU shown



CA-UR (4 ea.) shown



CA-UR shown



FM-QLLA

ALIGNMENT, SUSPENSION & AXLES
LEVELING & STABILIZATION

TOWING

CARGO, SECURITY & STORAGE

WASTE MANAGEMENT

AWNINGS

STEPS

SLIDE-OUTS

HAPPIJAC

DOORS & SEALS

KITCHEN & BATH

FURNITURE & MATTRESS

DOORS & SEALS



RADIUS RV ENTRY DOORS

In just our first five years in the entry door market we brought 40+ never-before-seen product improvements and innovations, including three that are patent pending.

FEATURE	LCI	COMPETITION
Outer Frame Thickness	1/8"	1/16"
UV Stable Window	Standard	N/A
Hinge Size	9-1/2"	6-1/2" to 7-1/2"
Built-in Camber	Standard	N/A
Integrated Felt Seal	Standard	N/A
Screen Door Thickness	1"	1/2"
Screen Door Hinge	Stainless Steel	Aluminum

Upgrade package includes the following:

Friction Hinge

- Wind (up to 30 mph) will not blow entry door shut
- Replaces gas struts and plastic door catches that often break
- Seamless integration requires no additional parts
- Innovative engineering makes door more sturdy



Lighted Threshold

- Lighted threshold activated upon opening
- Takes the guesswork out of step location in the dark
- Durable and protective cover strong enough to withstand the heaviest traffic
- Delivered pre-wired, making it easy to install



Larger Window with Obscure Glass

- Allows more natural light inside with a 12" x 36" window (black frame)



QUICK FACTS

- Polar white skin
- White aluminum extrusion frame
- White window frame with obscure glass
- White handle and hardware
- Screen door included with oversized push-down latch (allows you to open screen door when panel is closed)

standard door part no.	description	upgraded door no.
V000042326	24" x 68" RH Radius Entry Door	V000240535
V000051931	24" x 72" RH Radius Entry Door	V000240534
V000040259	26" x 72" RH Radius Entry Door	V000240536
V000040165	28" x 72" RH Radius Entry Door	V000240537
V000228493	30" x 74" RH Radius Entry Door	V000240538

†Additional sizes available. Please call for special orders.

ALIGNMENT,
SUSPENSION
& AXLES

LEVELING &
STABILIZATION

TOWING

CARGO,
SECURITY &
STORAGE

WASTE
MANAGEMENT

AWNINGS

STEPS

SLIDE-OUTS

HAPPYJAC

DOORS
& SEALS

KITCHEN
& BATH

FURNITURE &
MATTRESS

SQUARE ENTRY DOORS

part no.	description	color
V000350931	24" x 68" RH Square Entry Door	Off White
V000310932	24" x 70" RH Square Entry Door	Off White
V000310933	24" x 72" RH Square Entry Door	Off White
V000350934	24" x 76" RH Square Entry Door	Off White
V000350943	26" x 68" RH Square Entry Door	Off White
V000350944	26" x 70" RH Square Entry Door	Off White
V000350945	26" x 72" RH Square Entry Door	Off White
V000350957	26" x 78" RH Square Entry Door	Off White
V000350951	28" x 72" RH Square Entry Door	Off White
V000350955	30" x 72" RH Square Entry Door	Off White
V000350948	32" x 72" RH Square Entry Door	Off White
V000042629	24" x 68" RH Square Entry Door	Polar White
V000042628	24" x 70" RH Square Entry Door	Polar White
V000042625	24" x 76" RH Square Entry Door	Polar White
V000213919	28" x 68" RH Square Entry Door	Polar White
V000149585	30" x 72" RH Square Entry Door	Polar White
V000156500	36" x 72" RH Square Entry Door	Polar White

†Additional sizes available. Please call for special orders.



MOTORHOME ENTRY DOORS

We have the only motorized entry door on the market that is completely certified FMVSS 206. Most door manufacturers only certify their hinges and latches. LCI has made sure that the entire door assembly holds up to the highest standards. Its interior super-substructure adds extra strength and stability.

part no.	description
V000145033	24" x 70" RH Radius Motorized Entry Door
V000145032	24" x 72" RH Radius Motorized Entry Door
V000145349	26" x 72" RH Radius Motorized Entry Door

†Additional sizes available. Please call for special orders.



ENTRY & BAGGAGE DOOR REPLACEMENT PARTS

Entry Door Replacement Parts

part no.	description
Windows & Glass	
363369	12" x 21" Inner & Outer Window Frame w/ Seal; White
363370	12" x 21" Inner & Outer Window Frame w/ Seal; Black
201495	12" x 21" Obscure Glass Only
Entry Door Latches & Hardware	
239632	Entry Door Latch Kit; White
239631	Entry Door Latch Kit; Black
346692	Entry Door Latch Kit; Chrome
Screen Door Parts	
201471	Screen Door Latch; RH
201472	Screen Door Latch; LH
198287	Screen Door Frame Striker
198252	Screen Door Outside Striker
201478	Screen Door Rubber Bumper
239061	Screen Door Slider Panel w/ Push Down Handle
239063	Screen Door Stationary Panel; 26"
234101	Motorhome Screen Door Bubble Panel; Clear
326191	76" Snap Trim Screw Cover; White (Cut to needed length)
326192	76" Snap Trim Screw Cover; Black (Cut to needed length)



Baggage Door Replacement Parts

part no.	description
Baggage Door Parts	
227214	Slam Latch Baggage Door Handle
227840	Slam Latch Mounting Plate
346693	Standard Baggage Door Latch Only; Black
227099	Standard Baggage Door Mounting Plate
314302	Standard Baggage Door Edge Cover; Latch Strike
314301	Standard Baggage Door Striker Plate
317649	Standard Baggage Door Latch Kit; Black (includes latch, striker, edge cover, 2 striker screws & 2 latch screws)
213114	7/8" Baggage Door Key Lock; Chrome
213109	1-1/8" Baggage Door Key Lock; Chrome
213116	1-3/8" Baggage Door Key Lock; Chrome
213112	7/8" Baggage Door Turn Latch; Chrome
213108	1-1/8" Baggage Door Turn Latch; Chrome
213117	1-3/8" Baggage Door Turn Latch; Chrome



ALIGNMENT, SUSPENSION & AXLES
 LEVELING & STABILIZATION
 TOWING
 CARGO, SECURITY & STORAGE
 WASTE MANAGEMENT
 AWNINGS
 STEPS
 SLIDE-OUTS
 HAPPYJAC
 DOORS & SEALS
 KITCHEN & BATH
 FURNITURE & MATTRESS

KITCHEN & BATH



BATH TUBS & SURROUNDS

The Better Bath name stands for quality, and our bath products have been the quality benchmark for more than 50 years. All our durable thermoformed bath products are made in America and designed to last. With multiple shapes, styles and backsplashes, we provide a shower or bath configuration that is sure to add timeless elegance to any home or RV.



by  Lippert Components®

ACRYLONITRILE BUTADIENE STYRENE (ABS)

- Weighs 20-25% less than fiberglass
- ABS is tougher and lasts longer than coated fiberglass

Bath Tubs

part no.	description	color
209369	24" x 36" Bathtub; Center Drain	Parchment
209648	24" x 36" Bathtub; Center Drain	White
209372	24" x 36" Bathtub; LH Drain	Parchment
209653	24" x 36" Bathtub; LH Drain	White
209376	24" x 36" Bathtub; RH Drain	Parchment
209658	24" x 36" Bathtub; RH Drain	White
209379	24" x 38" Bathtub; Center Drain	Parchment
209661	24" x 38" Bathtub; Center Drain	White
209385	24" x 40" Bathtub; Center Drain	Parchment
209669	24" x 40" Bathtub; Center Drain	White
209388	24" x 40" Bathtub; LH Drain	Parchment
209673	24" x 40" Bathtub; LH Drain	White
209392	24" x 40" Bathtub; RH Drain	Parchment
209678	24" x 40" Bathtub; RH Drain	White
209395	24" x 46" Bathtub; LH Drain	Parchment
209681	24" x 46" Bathtub; LH Drain	White
209397	24" x 46" Bathtub; RH Drain	Parchment
209683	24" x 46" Bathtub; RH Drain	White
208946	27" x 54" Bathtub; LH Drain	Almond
209712	27" x 54" Bathtub; LH Drain	White
208948	27" x 54" Bathtub; RH Drain	Almond
209716	27" x 54" Bathtub; RH Drain	White



209443
Parchment Rivets (ea)
210278
White Rivets (ea)

Bath Surrounds

part no.	description	color	finish
209461	24" x 36" x 59" Bath Surround	Parchment	Picture Frame
210305	24" x 36" x 59" Bath Surround	White	Picture Frame
210307	24" x 36" x 62" Bath Surround	White	Picture Frame
210303	24" x 36" x 56" Bath Surround	White	Picture Frame
209459	24" x 36" x 56" Bath Surround	Parchment	Picture Frame
210310	24" x 38" x 56" Bath Surround	White	Picture Frame
208361	24" x 38" x 56" Bath Surround	Parchment	Picture Frame
210314	24" x 40" x 56" Bath Surround	White	Picture Frame
209468	24" x 40" x 56" Bath Surround	Parchment	Picture Frame
306207	24" x 40" x 58" Bath Surround	White	Tile
306206	24" x 40" x 58" Bath Surround	Parchment	Tile
208008	24" x 46" x 59" Bath Surround	White	Tile
209513	24" x 46" x 59" Bath Surround	Parchment	Tile
210400	27" x 54" x 57" Bath Surround	White	Tile



ALIGNMENT, SUSPENSION & AXLES
LEVELING & STABILIZATION
TOWING
CARGO, SECURITY & STORAGE
WASTE MANAGEMENT
AWNINGS
STEPS
SLIDE-OUTS
HAPPYJAC
DOORS & SEALS
KITCHEN & BATH
FURNITURE & MATTRESS

SHOWER PANS



210371



209414



209742



209415



209744



301241



209795



301242



209797

part no.	description	color
210369	24" x 32" Shower Pan; LH Drain	White
210371	24" x 32" Shower Pan; RH Drain	White
210367	24" x 32" Shower Pan; Center Drain	White
209490	24" x 32" Shower Pan, LHC	Parchment
210375	24" x 36" Shower Pan, RHC	White
209496	24" x 36" Shower Pan, RHC	Parchment
210373	24" x 36" Shower Pan, LHC	White
342922	24" x 36" Shower Pan, LHC	Parchment
209500	24" x 40" Shower Pan, RHC	Parchment
210379	24" x 40" Shower Pan, RHC	White
209498	24" x 40" Shower Pan, LHC	Parchment
210377	24" x 40" Shower Pan, LHC	White
209484	24" x 46" Shower Pan, RHC	Parchment

part no.	description	color
210383	24" x 46" Shower Pan, RHC	White
209483	24" x 46" Shower Pan, LHC	Parchment
210381	24" x 46" Shower Pan, LHC	White
247188	27" x 27" Neo Angle Pan; Center Drain; 10" SPK	White
247189	27" x 27" Neo Angle Pan; Center Drain; 10" SPK	Parchment
209414	32" x 32" Neo Angle Pan; LH Drain; 5" SPK	Parchment
209742	32" x 32" Neo Angle Pan; LH Drain; 5" SPK	White
209415	32" x 32" Neo Angle Pan; RH Drain; 5" SPK	Parchment
209744	32" x 32" Neo Angle Pan; RH Drain; 5" SPK	White
301241	34" x 34" Neo Angle Pan; Center Drain; 5" SPK	Parchment
209795	34" x 34" Neo Angle Pan; Center Drain; 5" SPK	White
301242	34" x 34" Neo Angle Pan; Center Drain; 9.5" SPK	Parchment
209797	34" x 34" Neo Angle Pan; Center Drain; 9.5" SPK	White

ALIGNMENT, SUSPENSION & AXLES

LEVELING & STABILIZATION

TOWING

CARGO SECURITY & STORAGE

WASTE MANAGEMENT

AWNINGS

STEPS

SLIDE-OUTS

HAPPIJAC

DOORS & SEALS

KITCHEN & BATH

FURNITURE & MATTRESS

SHOWER SURROUNDS

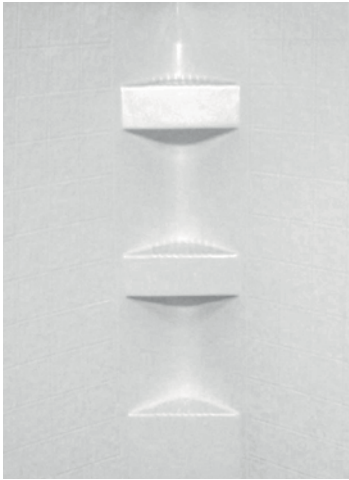

306205



306202



306203



210324

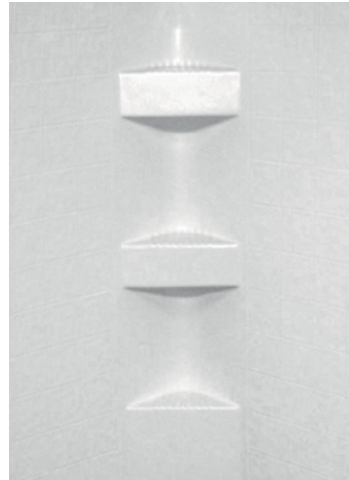

306204



306201

part no.	description	color	finish
342903	24" x 32" x 59" Shower Surround	Parchment	Tile
210390	24" x 32" x 62" Shower Surround	White	Tile
209506	24" x 32" x 62" Shower Surround	Parchment	Tile
210305	24" x 36" x 59" Shower Surround	White	Picture Frame
209461	24" x 36" x 59" Shower Surround	Parchment	Picture Frame
210307	24" x 36" x 62" Shower Surround	White	Picture Frame
209463	24" x 36" x 62" Shower Surround	Parchment	Picture Frame
210316	24" x 40" x 59" Shower Surround	White	Picture Frame
209470	24" x 40" x 59" Shower Surround	Parchment	Picture Frame
306207	24" x 40" x 58" Shower Surround	White	Tile
306206	24" x 40" x 58" Shower Surround	Parchment	Tile
210394	24" x 40" x 62" Shower Surround	White	Tile

part no.	description	color	finish
209512	24" x 40" x 62" Shower Surround	Parchment	Tile
210396	24" x 46" x 59" Shower Surround	White	Tile
209514	24" x 46" x 59" Shower Surround	Parchment	Tile
247190	27" x 27" x 65" Neo-Angle Shower Surround	White	Tile
247191	27" x 27" x 65" Neo-Angle Shower Surround	Parchment	Tile
210324	32" x 32" x 68" Neo Angle Shower Surround	White	Picture Frame
306202	34" x 34" x 64" Neo Angle Shower Surround	Parchment	Slate
306204	34" x 34" x 64" Neo Angle Shower Surround	White	Slate
306203	34" x 34" x 68" Neo Angle Shower Surround	Parchment	Slate
306201	34" x 34" x 68" Neo Angle Shower Surround	Parchment	Tile
306205	34" x 34" x 68" Neo Angle Shower Surround	White	Slate

ALIGNMENT,
SUSPENSION
& AXLES

LEVELING &
STABILIZATION

TOWING

CARGO,
SECURITY &
STORAGE

WASTE
MANAGEMENT

AWNINGS

STEPS

SLIDE-OUTS

HAPPYJAC

DOORS
& SEALS

KITCHEN
& BATH

FURNITURE &
MATTRESS

STAINLESS STEEL SINKS

Available in single bowl and double bowl varieties. Modern .3937" covered corners give a sleeker look than the standard .5" corners, but are easier to clean than zero radius corners. Stainless steel material makes for easy clean up and an updated appearance. Standard 3-1/2" drain opening is compatible with most garbage disposals and drain baskets. Channel grooves prevent sitting water in the sink bowl.

QUICK FACTS

- Premium quality at an affordable price
- Stylish modern design with square corners
- Made of extra thick, durable steel
- Modern .3937" covered corners give a sleeker look
- Standard 3-1/2" drain opening is compatible with most garbage disposals and drain baskets
- 20 gauge T-304 stainless steel meets or exceeds industry standards mandated by IAPMO



380067



380068

part no.	description	color
380067	27" x 16" x 8" Double Bowl Farmers Sink	Stainless Steel
380068	27" x 16" x 8" Single Bowl Farmers Sink	Stainless Steel
388412	27" x 16" x 7" Double Bowl Drawn Sink	Stainless Steel
389910	27" x 16" x 7" Double Bowl Farmers Sink	Stainless Steel
389911	25" x 15" x 7" Double Bowl Drawn Sink	Stainless Steel
388414	27" x 16" x 8" Single Bowl Farmers Sink	Stainless Steel
421572	25" x 15" x 7" Single Bowl Sink	Stainless Steel
388415	32" x 17" x 7" Double Bowl 60/40 Drawn Sink	Stainless Steel

ALIGNMENT,
SUSPENSION
& AXLES

LEVELING &
STABILIZATION

TOWING

CARGO
SECURITY &
STORAGE

WASTE
MANAGEMENT

AWNINGS

STEPS

SLIDE-OUTS

HAPPIJAC

DOORS
& SEALS

KITCHEN
& BATH

FURNITURE &
MATTRESS

SINKS & SINK COVERS



209401



209635 & 209358



209407 & 306192



209404, 306193 & 306194



209586, 307014 & 306197



209694, 306198 & 306199



209351



209630



209356

type	part no.	description	color	matching sink cover
Lavatory Sinks	209358	17" x 20" Oval Lavatory Sink	Parchment	
	209635	17" x 20" Oval Lavatory Sink	White	
Kitchen/ Galley Sinks	209401	25" x 17" Double Sink; 3 Holes	Parchment	
	209404	25" x 19" Double Sink; 3 Holes	Parchment	306193 (25" x 19" Two-Piece; Large) 306194 (25" x 19" Two-Piece; Small)
	209586	25" x 19" Double Sink; 3 Holes	Stainless Steel Color	307014 (25" x 19" Two-Piece; Large) 306197 (25" x 19" Two-Piece; Small)
	209694	25" x 19" Double Sink; 3 Holes	White	306198 (25" x 19" Two-Piece; Large) 306199 (25" x 19" Two-Piece; Small)
	209407	25" x 19" Single Sink; 3 Holes	Parchment	306192 (25" x 19" One-Piece)
Outdoor Kitchen/ Galley Sinks	209351	13" x 15" Square Galley/Kitchen Sink	Parchment	
	209630	13" x 15" Square Galley/Kitchen Sink	White	
	209356	15" x 15" Square Galley/Kitchen Sink	Parchment	

ALIGNMENT,
SUSPENSION
& AXLES

LEVELING &
STABILIZATION

TOWING

CARGO,
SECURITY &
STORAGE

WASTE
MANAGEMENT

AWNINGS

STEPS

SLIDE-OUTS

HAPPYJAC

DOORS
& SEALS

KITCHEN
& BATH

FURNITURE &
MATTRESS

FURNITURE & MATTRESS



THOMAS PAYNE® COLLECTION

Quality workmanship and unsurpassed comfort are the foundation upon which every piece of Thomas Payne® Collection furniture is built. Equally impressive is the high level of functionality this furniture offers. With six styles of furniture and multiple fabric options to choose from, we have all the seating and sleeping options to suit your needs.

THOMAS PAYNE®
COLLECTION



All fabrics are made of PolyHyde™ Euro Leather vinyl

To clean your Thomas Payne furniture, simply mix mild soap with warm water and dampen a clean rag or sponge to wipe away any dirt or spills.

ALIGNMENT,
SUSPENSION
& AXLES

LEVELING &
STABILIZATION

TOWING

CARGO,
SECURITY &
STORAGE

WASTE
MANAGEMENT

AWNINGS

STEPS

SLIDE-OUTS

HAPPYJAC

DOORS
& SEALS

KITCHEN
& BATH

FURNITURE &
MATTRESS

THOMAS PAYNE® COLLECTION

THOMAS PAYNE COLLECTION™

THEATER SEATING

Not only does Thomas Payne Collection Theater Seating feature plush, inviting and easy-to-clean PolyHyde™ upholstery, it also has an optional center console that provides a storage compartment and two recessed cup holders. This versatile and attractive modular theater seating features smoothly operating recliners and requires minimum wall clearance.



RIGHT ARM RECLINER

CENTER CONSOLE

LEFT ARM RECLINER
SHOWN IN JALECO CHOCOLATE

part no.	description
386637	Left Arm, Majestic Chocolate
386638	Right Arm, Majestic Chocolate
386639	Center Console, Majestic Chocolate
386640	Left Arm, Jaleco Chocolate
386642	Right Arm, Jaleco Chocolate
386643	Center Console, Jaleco Chocolate
386644	Left Arm, Grantland Doeskin
386645	Right Arm, Grantland Doeskin
386647	Center Console, Grantland Doeskin

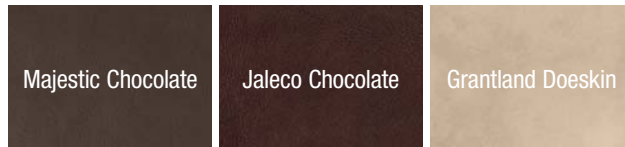

ALIGNMENT,
SUSPENSION
& AXLES

LEVELING &
STABILIZATION

TOWING

CARGO
SECURITY &
STORAGE

WASTE
MANAGEMENT

AWNINGS

STEPS

SLIDE-OUTS

HAPPIJAC

DOORS
& SEALS

KITCHEN
& BATH

FURNITURE &
MATTRESS

TRI-FOLD SOFA

Known for its versatile functionality and comfortable sleep surface, the Thomas Payne Collection Tri-Fold Sofa converts to a very supportive, high-density foam bed in four simple steps. Its sleek design maximizes space because it takes up about one foot less when extended than a traditional hide-a-bed. Durable PolyHyde™ upholstery resists stains better than leather or fabric.



SHOWN IN GRANTLAND DOESKIN

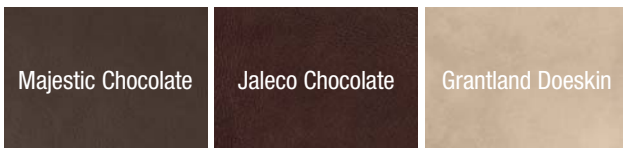

part no.	description
377706	60" Tri-Fold Sofa, Majestic Chocolate
380399	60" Tri-Fold Sofa, Jaleco Chocolate
379929	60" Tri-Fold Sofa, Grantland Doeskin
377708	68" Tri-Fold Sofa, Majestic Chocolate
380400	68" Tri-Fold Sofa, Jaleco Chocolate
379930	68" Tri-Fold Sofa, Grantland Doeskin

ALIGNMENT,
SUSPENSION
& AXLES

LEVELING &
STABILIZATION

TOWING

CARGO,
SECURITY &
STORAGE

WASTE
MANAGEMENT

AWNINGS

STEPS

SLIDE-OUTS

HAPPYJAC

DOORS
& SEALS

KITCHEN
& BATH

FURNITURE &
MATTRESS

THOMAS PAYNE® COLLECTION



SHOWN IN MAJESTIC CHOCOLATE

SWIVEL GLIDE RECLINER

Each attractive and supportive Swivel Glide Recliner is upholstered with luxurious easy-to-clean PolyHyde™ upholstery. This perfect addition to your trailer living room coordinates beautifully with sofas and Push Back Recliners. All Swivel Glide Recliners have heated seats and a side pocket for the remote.



part no.	description
377710	Swivel Glide Recliner, Majestic Chocolate
380401	Swivel Glide Recliner, Jaleco Chocolate
380402	Swivel Glide Recliner, Grantland Doeskin

PUSH BACK RECLINER

Enjoy total relaxation whether sitting upright or fully reclined in the classic Thomas Payne Collection Push Back Recliner. Choose from 3 elegant colors to match your trailer décor.



SHOWN IN JALECO CHOCOLATE

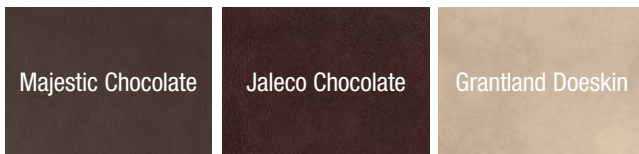

part no.	description
377054	Push Back Recliner, Majestic Chocolate
380396	Push Back Recliner, Jaleco Chocolate
380398	Push Back Recliner, Grantland Doeskin

ALIGNMENT, SUSPENSION & AXLES
LEVELING & STABILIZATION
TOWING
CARGO SECURITY & STORAGE
WASTE MANAGEMENT
AWNINGS
STEPS
SLIDE-OUTS
HAPPYAC
DOORS & SEALS
KITCHEN & BATH
FURNITURE & MATTRESS

JACK KNIFE SOFA

With one easy motion, the steel-framed Jackknife RV Sofa converts to a bed of high-density foam. The steel spring seat supports provide a sturdy base for relaxing or sleeping.



SHOWN IN BECKHAM TAN



part no.	description
364578	62" Jackknife Sofa, Beckham Tan
364579	62" Jackknife Sofa, Melody Walnut
389304	62" Jackknife Sofa, Pivot Harvest
389307	62" Jackknife Sofa, Poise Mahogany
389308	62" Jackknife Sofa, Poise Dark Chocolate

part no.	description
364580	68" Jackknife Sofa, Beckham Tan
364581	68" Jackknife Sofa, Melody Walnut
389309	68" Jackknife Sofa, Pivot Harvest
389310	68" Jackknife Sofa, Poise Mahogany
389311	68" Jackknife Sofa, Poise Dark Chocolate
364582	Jackknife Sofa Leg Kit

All jackknife sofas come with a kickboard. Leg kit also available, but must be ordered separately.

EURO RECLINER CHAIR

Relax after a long day of adventure in the comfortable and compact Thomas Payne Collection Euro Recliner Chair. This versatile seat is covered in attractive and durable PolyHyde™ upholstery and features a comfortable footrest.

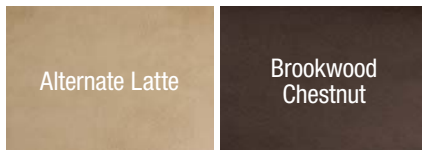

NEW PRODUCT!

XL 4" WIDER



SHOWN IN ALTERNATE LATTE

SHOWN IN BROOKWOOD CHESTNUT

part no.	description
3477221	Euro Recliner Chair, Alternate Latte
3477222	Euro Recliner Chair, Brookwood Chestnut
426797	Euro Recliner Chair XL, Alternate Latte
426798	Euro Recliner Chair XL, Brookwood Chestnut

DENVER MATTRESS® RV COLLECTION PROFIT PROGRAM

Offer your customers the luxurious comfort they want in the special RV sizes they need. The Denver Mattress RV Collection practically sells itself with quality mattresses and bedding, eye-catching branding and informative product displays.



Available Display Signage

A Aisle Header Panels

46" x 12" single or double panel

B Eco-Friendly Info Panel

12" x 46"* panel featuring the Denver Mattress RV Collection's eco-friendly manufacturing and fire prevention treatment processes



8-Foot Planogram

Make maximum visual impact with the Denver Mattress RV Collection planogram. Ready for display within any 8-foot planogram.

ALIGNMENT, SUSPENSION & AXLES
LEVELING & STABILIZATION
TOWING
CARGO SECURITY & STORAGE
WASTE MANAGEMENT
AWNINGS
STEPS
SLIDE-OUTS
HAPPIJAC
DOORS & SEALS
KITCHEN & BATH
FURNITURE & MATTRESS

DENVER MATTRESS® RV COLLECTION PROFIT PROGRAM

ALIGNMENT, SUSPENSION & AXLES
LEVELING & STABILIZATION
TOWING
CARGO, SECURITY & STORAGE
WASTE MANAGEMENT
AWNINGS
STEPS
SLIDE-OUTS
HAPPYJAC
DOORS & SEALS
KITCHEN & BATH
FURNITURE & MATTRESS

Included With Display



C Display Rack Inserts
23" x 14"* logo header insert and 24" x 3.5"* inserts for pillow and mattress sample display shelves

D Two Mattress Buns**

E Product Sample Rings
4" x 4" tags provide quality features, available sizes, available colors, and part numbers for accompanying mattress pad sample and microfiber, sateen, and adjustable sheet swatch samples.



Bedding Display Rack

Customers get hands-on product experience with the state-of-the-art Denver Mattress RV Collection bedding display rack. The display unit accommodates pillows**, sheets**, mattress samples, mini mattress pads, mini sheet swatches, a mattress pad sample, and microfiber and sateen fabric samples.

*Dimensions are subject to change. **Pillows and sheet sets are not included with display rack.

DENVER MATTRESS® RV COLLECTION



THE PERFECT COMBINATION OF COMFORT AND SUPPORT

Wake up relaxed and rejuvenated with the RV Supreme Euro Top all-foam Denver Mattress, featuring a high-quality foam core and euro top quilt for total support, luxurious comfort and long-lasting durability. The 1.8-lb, high-density foam in quilt layers supports your body to promote proper sleeping posture, relieve pressure points and reduce motion transfer between sleeping partners. Choose the RV Supreme Euro Top Denver Mattress to enjoy the comfort of home while on the road. posture, ensuring a better night's rest.

RV Supreme Euro Top Mattress – 11"

- 9" high-density foam core supports body to promote proper sleeping posture
- 2" euro top provides luxurious comfort and relieves pressure points
- 1.8-lb, high-density foam in quilt layers and plant-based foam provide long-lasting durability and comfort
- Luxury stretch knit cover is both soft and breathable
- All-foam construction prevents motion transfer and roll-together between sleeping partners
- Rigorously tested to ensure durability

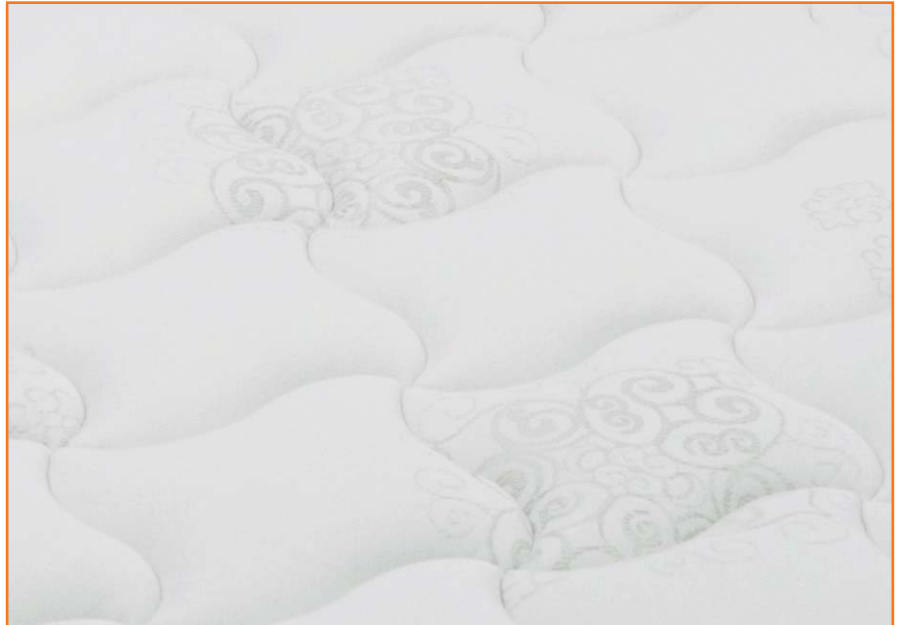

Shipping

Ships direct to your front door in a box measuring 16" x 16" x 62-78", depending on the size of mattress ordered. Free shipping within the continental United States

part no.	description	size	weight
326395	Short Queen	60" x 75" x 11"	60 lbs.
326394	Queen	60" x 80" x 11"	64 lbs.
326393	Narrow King	72" x 80" x 11"	78 lbs.
326388	King	76" x 80" x 11"	82 lbs.
326391	Short Queen - Radius Corners	60" x 75" x 11"	59 lbs.
326390	Queen - Radius	60" x 80" x 11"	63 lbs.
326389	Narrow King - Radius Corners	72" x 80" x 11"	77 lbs.
326392	King - Radius	76" x 80" x 11"	81 lbs.



ALIGNMENT, SUSPENSION & AXLES

LEVELING & STABILIZATION

TOWING

CARGO SECURITY & STORAGE

WASTE MANAGEMENT

AWNINGS

STEPS

SLIDE-OUTS

HAPPYAC

DOORS & SEALS

KITCHEN & BATH

FURNITURE & MATTRESS

DENVER MATTRESS® RV COLLECTION

Rest Easy Plush

- 4" high-density foam core offers support for proper sleeping posture
- 1.8-lb, high-density foam in quilt layers relieves pressure points
- Stretch knit cover is both soft and breathable



part no.	description	size	weight
360163	30 x 72 Bunk	30" x 72" x 5"	18 lbs.
360164	34 x 75 Bunk	34" x 75" x 5"	21 lbs.
360165	Twin	38" x 75" x 5"	23 lbs.
360167	Three Quarter	48" x 75" x 5"	28 lbs.
360168	Full	54" x 75" x 5"	31 lbs.
360170	Short Queen	60" x 75" x 5"	34 lbs.
360171	Queen	60" x 80" x 5"	35 lbs.



Rest Easy Euro Top

- 7" high-density foam core offers firm support for proper sleeping posture
- 2" euro top style quilt relieves pressure points
- Luxury stretch knit cover is both soft and breathable
- All-foam construction reduces motion transfer and roll-together between sleeping partners



part no.	description	size	weight
360172	Short Queen	60" x 75" x 9"	57 lbs.
360174	Queen	60" x 80" x 9"	57 lbs.
360173	Narrow King	72" x 80" x 9"	72 lbs.
360175	King	76" x 80" x 9"	74 lbs.



Rest Easy Supreme Latex

- 8" high-density foam core offers firm support for proper sleeping posture
- 3" high-quality latex foam provides a cool, refreshing sleep experience
- Luxury stretch knit cover is both soft and breathable
- All-foam construction reduces motion transfer and roll-together between sleeping partners



part no.	description	size	weight
360177	Short Queen	60" x 75" x 11"	63 lbs.
360180	Queen	60" x 80" x 11"	67 lbs.
360181	Narrow King	72" x 80" x 11"	81 lbs.
360182	King	76" x 80" x 11"	85 lbs.



ALIGNMENT, SUSPENSION & AXLES
LEVELING & STABILIZATION
TOWING
CARGO, SECURITY & STORAGE
WASTE MANAGEMENT
AWNINGS
STEPS
SLIDE-OUTS
HAPPYJAC
DOORS & SEALS
KITCHEN & BATH
FURNITURE & MATTRESS

DENVER MATTRESS® RV COLLECTION

Pillows

- 100% cotton, 350 thread count cover
- Hypoallergenic polyester down-alternative fill
- Machine washable and double stitched for durability

part no.	description	size
343490	Jumbo Soft Pillow	20" x 28"
343491	King Soft Pillow	20" x 36"
343492	Jumbo Firm Pillow	20" x 28"
343493	King Firm Pillow	20" x 36"



ALIGNMENT,
SUSPENSION
& AXLES

LEVELING &
STABILIZATION

TOWING

CARGO
SECURITY &
STORAGE

WASTE
MANAGEMENT

AWNINGS

STEPS

SLIDE-OUTS

HAPPYAC

DOORS
& SEALS

KITCHEN
& BATH

FURNITURE &
MATTRESS

DENVER MATTRESS® RV COLLECTION

Mattress Pads

- 100% cotton, 350 thread count cover
- Adds 2" of plush polyester down-alternative fill
- Heavy-duty elastic perimeter for stay-put fit
- Spandex skirt fits mattresses up to 16" deep

part no.	description	size
343494	Short Queen	60" x 75" x 2"
343495	Queen	60" x 80" x 2"
343496	Narrow King	72" x 80" x 2"
343497	King	76" x 80" x 2"



ALIGNMENT,
SUSPENSION
& AXLES

LEVELING &
STABILIZATION

TOWING

CARGO,
SECURITY &
STORAGE

WASTE
MANAGEMENT

AWNINGS

STEPS

SLIDE-OUTS

HAPPYJAC

DOORS
& SEALS

KITCHEN
& BATH

FURNITURE &
MATTRESS

DENVER MATTRESS® RV COLLECTION



Sheet Sets

- Set Includes: fitted sheet, top sheet and 2 pillow cases

SATEEN SHEET SETS

- 100% cotton, 300 thread count
- Luxurious sateen weave
- Extra-long top sheet
- Fits mattresses up to 14" deep
- Heavy-duty elastic perimeter for stay-put fit

part no.				description
Ivory	Sage	Latte	White	
343498	343507	343511	343503	Short Queen, 60" x 75"
n/a	343508	n/a	343504	Queen, 60" x 80"
343501	343509	343513	343505	Narrow King, 72" x 80"
343502	343510	343514	343506	King, 76" x 80"

MICROFIBER SHEET SETS

- Ultra-soft brushed microfiber
- Extra-long top sheet
- Fits mattresses up to 11" deep
- Heavy-duty elastic perimeter for stay-put fit

part no.			description
Ivory	Sage	Latte	
343515	343521	343526	Short Queen, 60" x 75"
343517	n/a	n/a	Queen, 60" x 80"
343518	343524	343528	Narrow King, 72" x 80"
343519	343525	343529	King, 76" x 80"

ADJUSTABLE SHEET SETS

- Ultra-soft brushed microfiber
- Extra-long top sheet
- Adjustable drawstring fits unique mattress sizes
- Fits mattresses up to 6" deep

part no.	description	size
Ivory		
343530	Bunk	30-34" x 70-75", best for cots and bunks
343531	Three Quarter	35-48" x 70-75", best for twin and 3/4 sizes
343532	Queen	49-60" x 75-80", best for full and queen sizes
343533	King	61-76" x 75-80", best for king sizes

Check out an excellent selection of rv awnings & shades we offer on our website.