

Electrical PGS. 4-14



Diagnostic PGS. 15-32



Airline Accessories PGS. 33-44



Suspension & Alignment PGS. 45-48



Hand Tools PGS. 49-54



Collision Repair PGS. 55-70



ALPHABETICAL TOOL INDEX

ITEM	PAGE	ITEM	PAGE	ITEM	PAGE	ITEM	PAGE	ITEM	PAGE
Abrasive Blaster	58	Computer Safe Circuit Testers	8, 9	Hammer Handles	57	Phenolic Backing Discs	44	Stopper, Fluid Line	52
Abrasives For Blasting	50, 58	Continuity Tester	10	Hammers, Body	56, 57, 59	Pick & Hook Sets	51, 53	Strut Alignment Level	46
Adapters For Caster/Camber Gage	48	Cotter Pin Pullers	51, 53	Handles For Windshield Cut-Out		Pick Hammers	57, 59	Strut Spring Compressors	46
Adapters For Diesel Testers	30-32	Crimper, Pneumatic Panel	40	Wire	66	Pneumatic Chisels	39-43	Strutter®, Coil Spring Tools	46
Adapters For Fuel Injection Testers	19, 25	Crimpers, Electrical Terminal	4-7	Handles, Hammer	57	Portable Work Stand	55	Stubby Drill Bit	62
Air Adjustment Valves	37, 44	Cup Brush	67	Hearing Protector	54	Power Steering Tester	27	Suction Cups	61
Air Blow Guns	38, 39	Current Indicator	14	Heat Gun	54	Pressure Testers, Engine	18-25	Surface Treatment	
Air Filter	37	Cut-Off Wheels	33	Heat Shrink Tubes	11	Protect-A-Terminal®	8, 9	Discs with Holding Pads	37
Air Hammer Chisels	39-43	Cut-Out Knives	66	High Impedance Circuit Testers	8, 9	Pry Bar, Rolling Head	53	Suspension Tools	45-48
Air Powered Caulking Gun	55	Cut-Out Wire	66	High-Low Circuit Tester	10	Pullers, Dent	60, 61		
Air Powered Cleaning Gun	38			Hinge Spring Tool	63	Pullers, Hub	45		
Air Regulators	37, 44	Dead Center Indicator	26	Holder For Body Files	65	Pulling Yoke	45	Tack Puller	68
Air Saw Blades	33	Dent Pullers	60, 61	Holding Pads For Surface Treatment		Pumps For Barrel and Pail	69	Tapper Dent Puller	61
Air Tool Oilers	36	Dent Pullers, Suction Cup	61	Discs	37	Punch Set, Body Forming	59	Terminal Crimping Tools	4-7
Alignment Tools	46-48	Deutsch Terminal Crimpers	4, 5	Hook and Pick Sets	51, 53	Punches, Brass	50	Terminal Release Tools, Deutsch	4, 5
Alternator-Generator-Starter Current Indicator	14	Deutsch Terminal Release Tools	4, 5	Hooker Tools	51			Test Leads	12, 13
Arbor For Cut-Off Wheels	33	Diaphragm Air Regulator	37	Hose Clamp Pliers	49	Quick Change Backing Pad	35	Testers, Compression	26, 29-32
Automatic Trans. Testers	27	Die Sets For Crimpers	6	Hose Cutter	50	Quick Change Chisel Retainers	44	Testers, Diesel	29-32
Axle and Hub Pullers	45	Diesel Compression Testing Sets	29	Hose Removal Tools	51, 53	Quick Change Crimping Kits	6	Testers, Engine	18-32
		Diesel Compression Test Adapters	29-32	Hot Air Heat Gun	54			Tie Rod End/Ball Joint Lifter	46
				Hub Pullers	45			Tie Rod Separator	40
Back Pressure Tester, Exhaust	28	Digital Circuit Tester	8			Radiator Hose Tools	51, 53	Tire Inflators	34, 38
Back Probes	13	Disc Brake Caliper Brush	50	IAC Test Lights	17	Ratchet Spinners	54	Tire Tread Depth Gage	35
Backing Discs	44	Disconnect Tool	22	Ignition Testers & Tools	10, 15-17	Ratcheting Terminal Crimpers	6	Tire Valve Core Removers	35
Backing Pads	35	Dollies	56, 59	Impact Driver Set	49	Razor Blades	49	Titanium Step Drill	62
Ball Joint Lifter	46	Door Aligner Tools	63	In-Line Ignition Spark Checkers	15-17	Reciprocating Air Saw Blades	33	Toe-In, Toe-Out Gages	48
Ball Joint Separator	40	Door Clip Removers	68	In-Line Oilers	36	Regulators, Air	37, 44	Top Dead Center Indicator	26
Barrel Pumps	69	Door Handle Removers	68	In-Line Water Separator	37	Release Tools, Deutsch	4, 5	Transmission Testers	27
Battery Filler	53	Door Skin Dolly	56	In-Line Blow Guns	39	Release Tool, Weather Pack	5	Trim Cutter	50
Beehive Spring Retainer	44	Door Skin Hammer	56, 57	Inflators, Tire	34, 38	Retain-It, Chisel Retainer	44	Trim Pad Removal Tool	68
Blades, Razor	49	Door Spring Tool	63	Inspection Sticker Scrapers	39	Retractable Test Leads	12, 13	Triton Engine Compression Test Adapter	26
Blades, Air Saw	33	Door Unlocking Tool	51			Reveal Molding Clip Tools	62	Riveting Tools	70
Blaster, Abrasive	50, 58	Double Flaring Tool Kit	52	Jigglers	62	Rolling Head Pry Bar	53	Rolling Head Pry Bar	53
Bleed-Off Kit	25	Double Pointed Scriber/Hook	53	Jumper Leads	12, 13	Rotary Spot Weld Cutter	62	Rotary Spot Weld Cutter	62
Blow Guns	38, 39	Drill Bits	62	Junior Slugger Dent Puller	61	Rubber Suction Cups	61	Rubber Suction Cups	61
Body Dollies	56, 59	Drum Faucet	69						
Body File Holder	65	Drum Pumps	69	Knee Pads	54	Safety Chuck Chisel Holder	44	Sanding Blocks	64
Body Files	65	Duby Wheel Aligning Gages	48	Knelling Pad	54	Sand Blaster	58	Sanding Boards	64
Body Forming Punch Set	59			Knob End Brush	67	Sand Backing Discs	44	Saw Blades, Reciprocating Air	33
Body Hammers	56, 57, 59	Ear Protector	54			Sanding Blocks	64	Scrapers	49
Body Panel Drill Bit	62	Easy Grip Brushes	65	Lady's Foot Pry Bar	53	Sanding Boards	64	Scratch Brush	67
Body Repair Kits	59	Economy Chisels	42	Leads, Test	12, 13	Saw Blades, Reciprocating Air	33	Scribers	53
Body Spoons	56, 58, 59	Economy Heat Gun	54	Light Slapping Spoon	56, 59	Scrapers	49	Scrub Brush	50
Bonnet Cleaning Tool	63	Economy Paint Brushes	67	Logic Probes	8, 9	Scraper	49	Seal Puller	49
Brake Pedal Depressor	47	Economy Slugger	60	Lubricators, Air Tool	36	Short Finders	14	Side Molding Cutter	50
Brass Air Regulator	44	Electrical Test Leads	12, 13			Side Molding Cutter	50	Siphon Gun	38
Brass Punches	50	Electrical Testers	8-10, 14	MacPherson Strut Spring		Skinner Brush	67	Skinner Brush	67
Brushes	50, 65, 67	End Brushes	67	Compressors	46	Skinner Brush Arbor	67	Slapping Spoon	56, 59
Brushes For Spray Guns	65	Engine Oil Pressure Testers	27	Magnetic Caster/Camber Gage	48	Slapping Spoon	56, 59	Slide Hammers	60, 61
Bubble Flaring Tool Kit	52	Exhaust Back Pressure Tester	28	Masking Kit, Weatherstrip	66	Slide Hammers	60, 61	Sling for Portable Work Stand	55
Buffing Bonnet Cleaning Tool	63			Metri Pack Terminal Crimper	4, 5	Slugging Slide Hammer Sets	60, 61	Slugger Slide Hammer Sets	60, 61
		Faucet For Drums	69	Mid-Weight Dent Puller	61	Spark Plug Cleaner	50	Spark Testers	10, 15-17
		File Holder	65	Mighty Cutter	50	Spin-A-Ratchets	54	Spoon Dolly	56
		Files, Body	64, 65	Mini Pick & Hook Set	53	Spoons, Body	56, 58, 59	Spot Weld Buster	62
		Files, Nib	64	Mini Tubing Cutter	52	Spot Weld Cutter	62	Spot Weld Cutter	62
		Finger Saver®	9	Molding Cutter	50	Spray Gun Cleaning Kits	65	Springs, Chisel Retainer	44
		Finishing Hammers	57, 59	Muffler Tools	41	Spring Compressors	46, 47, 63	Starting Tool For Windshield Cut-Out	
		Flared End Brush	67	Multi-Step Drill	62			Wire	66
		Flaring Tool Kits	52			Nib Files	64	Steering Wheel Holder	47
		Flexible Body Files	65			Noid Lights	17	Step Drill	62
		Flexible Sanding Board	64			Oil Pressure Testers	27	Stethoscope	28
		Fluid Line Stoppers	52			Oilers, Air Tool	36	Sticker Scrapers	49
		Front End Tools	40, 45-48			Open Barrel Crimping Tool	4, 5	Strippers, Wire	7
		Fuel Injection Testers	18-25			Pad Cleaning Tool	63		
		Fuel Line Disconnect Tool	22			Pail Pump	69		
		Fuel Pressure Testers	18-25			Paint Brushes	67		
		Fuel Pump Tester	28			Panel Crimper Tool	40		
						Parts Cleaning Brush	50		
		Gages, Engine Test	18, 20-24, 26-30			Pedal Depressor	47		
		Gages, Tire Inflator	34, 38			Perma-Coil® Jumper Leads	13		
		Gages, Wheel Alignment	46, 48						
		Grime Scrub Brush	50						

S & G Tool Aid keeps pace with technological changes in the automotive market. Improvements may result in products you receive that differ from the pictures in this catalog.

Not responsible for typographical errors.

Do you have an idea for a new tool? If so, it could be worth extra money!

NUMERICAL INDEX

CAT. NO.	PAGE	CAT. NO.	PAGE	CAT. NO.	PAGE	CAT. NO.	PAGE	CAT. NO.	PAGE	CAT. NO.	PAGE
13000	54	18880	5	33936	25	53800	21	87440	66	91350	40
13100	54	18890	5	33950	24	53850	19	87460	66	91400	41
13200	54	18900	6	33966	25	53865	21	87500	63	91450	40
13400	54	18910	5	33980	24	53900	20	87600	68	91500	40
13700	51	18920	6	34000	26	53903	19	87615	68	91550	40
13800	51	18930	6	34020	26	53904	19	87650	68	91600	40
13810	51	18950	7	34300	26	53908	19	87675	63	91625	40
13820	51	18960	6	34500	27	53950	20	87700	62	91650	41
13840	51	18980	6	34550	27	53980	20	87800	62	91700	40
13850	53	19000	7	34580	27	56200	21	87810	68	91800	41
13860	51	19100	7	34650	27	56250	21	87820	68	91850	41
13900	53	19200	70	34700	29	57200	19	87880	66	91900	41
13920	53	19300	55	34729	29	57230	19	87890	66	91950	41
13950	53	19330	55	34730	30	57260	19	87900	66	91975	41
14270	50	19400	70	34740	30	57280	19	87920	66	92100	43
14290	50	19700	52	34760	30	57350	19	87940	49	92125	43
14300	50	19701	52	34770	30	57650	19	87960	49	92150	43
14550	54	19702	52	34780	30	57660	19	87965	49	92175	43
14600	53	19703	52	34800	30	57670	19	87975	63	92225	43
14700	54	19704	52	34840	30	58000	18	88000	56	92250	43
14720	54	19750	49	34860	29	58009	19	88050	56	92300	43
14800	52	19780	49	34880	30	58010	19	88100	56	92325	43
14825	52	19790	49	34900	29	58012	19	88150	56	92350	43
14850	52	19791	49	34950	30	58040	19	88160	56	92500	39
14860	52	19792	49	35000	30	58600	19	88175	56	92600	39
14950	49	19800	70	35100	30	58625	19	89000	57	92700	39
15060	62	19820	70	35150	31	58650	19	89002	57	94000	44
15210	62	19830	70	35200	31	58670	19	89050	57	94100	44
15500	51	21000	10	35250	31	61500	48	89100	57	94200	44
16025	53	21250	9	35300	31	61600	48	89150	57	94300	44
17000	65	21300	10	35350	31	61800	46	89200	57	94400	44
17050	50	21700	9	35400	31	61900	46	89250	57	94450	44
17100	67	22400	10	35450	31	62000	47	89300	57	94500	44
17110	67	22700	10	35500	31	62200	47	89350	57	94520	37
17120	67	22800	12	35550	31	62400	47	89357	57	94530	37
17130	67	22810	12	35600	31	62500	47	89360	59	94540	37
17150	67	22820	12	35650	31	62900	46	89400	56	94560	37
17170	65	22830	12	35660	31	63000	46	89450	59	94600	38
17180	65	22840	12	35670	31	65000	35	89470	59	94700	44
17185	65	22900	13	35680	31	65100	34	89500	62	94710	44
17190	65	23000	12	35690	31	65110	34	89510	62	94720	44
17220	67	23100	13	35700	32	65120	34	89520	62	94730	44
17230	67	23150	13	35710	32	65130	34	89600	58	94740	44
17235	67	23210	11	35720	32	65140	35	89625	58	94750	44
17280	65	23250	11	35730	32	65150	35	89675	58	94760	44
17300	67	23500	13	35740	32	66000	48	89700	58	94790	35
17310	67	23900	16	35750	29	66160	48	89725	56	94820	35
17320	67	23920	16	36200	23	66170	48	89750	65	94860	33
17330	67	23950	16	36250	23	66180	48	89760	65	94870	33
17340	67	23970	15	36300	17	66200	48	89770	65	94890	33
17350	67	24600	14	36310	17	66300	45	89780	64	94890P	33
17360	67	25100	14	36330	17	66320	45	89790	64	94900	33
17370	65	25300	14	36350	17	66330	45	89800	64	94930	33
17380	50	26200	14	37200	25	66340	45	89810	64	94950	33
17390	50	27000	9	37230	25	66350	45	89890	64	94970	33
17500	69	27130	9	37250	22	66360	45	89900	64	94980	33
17550	69	27250	10	37260	25	66370	45	89910	64	98000	44
17560	69	27300	10	37350	25	66400	47	89920	64	98025	44
17580	69	28000	8	37400	25	80000	60	90000	33	98300	37
17650	69	28100	8	37650	25	81000	60	90010	33	98350	37
17800	58	28200	8	37660	25	81100	60	90020	33	98500	36
18000	62	28300	8	37670	25	81200	61	90030	33	98700	36
18025	62	31800	49	38000	22	81400	61	90040	33	98800	36
18050	62	32000	28	51150	42	81500	61	90050	33	99000	37
18500	50	33600	28	51250	42	81600	61	90060	33	99100	39
18520	50, 58	33650	26	51350	42	81810	61	91000	40	99150	39
18530	50, 58	33700	28	51400	42	82350	63	91025	40	99180	39
18540	50, 58	33770	22	51450	42	85800	55	91050	41	99190	39
18550	5	33785	25	51500	42	85850	55	91100	40	99210	38
18580	5	33800	23	51550	42	85880	55	91125	40	99220	38
18600	5	33850	25	51600	42	87250	54	91140	40	99230	38
18650	4	33865	23	52000	42	87360	61	91150	40	99240	38
18700	4	33875	25	53770	20	87370	61	91200	40	99500	38
18850	6	33900	24	53785	19	87425	66	91250	40	99510	38
18860	5	33907	25	53788	19	87435	66	91300	41	99520	38
18870	5										

Do you have an idea for a new tool? If so, it could be worth extra money!

18700

FROM T-2017A SUPP.



MASTER TERMINALS SERVICE KIT

- A complete 11 piece kit to crimp and release the most popular automotive specialized terminals found on cars, trucks, construction equipment, motorcycles, race cars, agricultural and marine equipment, heavy duty vehicles and other vehicles and equipment subject to excessive vibration and wherever an environmentally sealed connection is used
- For use on:
 - Deutsch open and closed barrel terminals
 - Weather Pack terminals
 - Metri Pack terminals
 - Molex terminals
 - Other open barrel terminals



Crimps Open Barrel Terminals



Crimps Weather Pack Terminals



Crimps Closed Barrel Deutsch Terminals



Releases Weather Pack Terminals



Releases Deutsch Terminals

Contains:

CAT. NO.	DESCRIPTION
18551	Deutsch Terminal Release Tool for 14-16 Gage Wire (Gold Handle)
18552	Deutsch Terminal Release Tool for 16-18 Gage Wire (Blue Handle)
18553	Deutsch Terminal Release Tool for 20-24 Gage Wire (Red Handle)
18560	Deutsch Terminal Release Tool for 6 Gage Wire (Green Handle)
18570	Deutsch Terminal Release Tool for 8 & 10 Gage Wire (Gray Handle)
18580	Release Tool for Weather Pack Terminals
18600	Open Barrel Crimping Tool
18860	Terminal Crimper for Deutsch 12 Gage Closed Barrel Terminals
18880	Terminal Crimper for Deutsch 14, 16 & 18 Gage Closed Barrel Terminals
18890	Terminal Crimper for Deutsch 20 & 22 Gage Closed Barrel Terminals
18910	Terminal Crimper for Weather Pack and Metri Pack Terminals

18650



DEUTSCH TERMINALS SERVICE KIT

- A complete six piece kit to crimp and release the Deutsch terminals found throughout the industry on trucks, construction equipment, motorcycles, race cars, agricultural and marine equipment, heavy duty vehicles and other vehicles and equipment subject to excessive vibration and wherever an environmentally sealed connection is used
- Crimps both:
 - Open Barrel Terminals
 - Closed Barrel Terminals
- Release Tools
 - Have stainless steel shafts and knurled aluminum handles
 - For three applications: 14-16, 16-18 and 20-24 gage wire
 - Color coded handles
- Crimping tools are steel construction with comfortable cushioned grip handles
- Supplied in a durable, plastic molded storage case
- Call out label has application information and instructions

Kit consists of six tools:

CAT. NO.	DESCRIPTION
18551	Deutsch Terminal Release Tool for 14-16 Gage Wire (Gold Handle)
18552	Deutsch Terminal Release Tool for 16-18 Gage Wire (Blue Handle)
18553	Deutsch Terminal Release Tool for 20-24 Gage Wire (Red Handle)
18600	Open Barrel Crimping Tool for 14-24 Gage Wire
18880	Terminal Crimper for Deutsch 14, 16 & 18 Gage Closed Barrel Terminals
18890	Terminal Crimper for Deutsch 20 & 22 Gage Closed Barrel Terminals

TERMINAL CRIMPERS FOR DEUTSCH CLOSED BARREL TERMINALS

- Crimps Deutsch closed barrel terminals found on motorcycles, trucks, construction equipment, race cars, agricultural equipment, heavy duty vehicles and other vehicles and equipment subject to excessive vibration
- Easy to use – Just insert terminal and wire, then squeeze handles tightly together to complete the crimp
- Ratcheting action provides perfect crimp
- Steel construction
- Comfortable cushioned grips

DISPLAY PACKAGED



FROM T-2017A SUPP.
18860
18880
18890

CAT. NO.	DESCRIPTION	CONTACT SIZE
18860	For use with 12 gage closed barrel terminals	12
18880	For use with 14, 16, & 18 gage closed barrel terminals	16
18890	For use with 20 & 22 gage closed barrel terminals	20

TERMINAL CRIMPER FOR WEATHER PACK & METRI PACK TERMINALS 18910

- Easily crimps 14-22 gage open barrel Weather Pack, 150 and 280 Series Metri Pack and Molex terminals and seals in two operations
- Has three wire crimping and two seal crimping positions
- Thin profile allows access to hard to reach areas
- Steel construction
- Comfortable cushioned grips

DISPLAY PACKAGED



FROM T-2017A SUPP.

OPEN BARREL CRIMPING TOOL 18600

- Crimps most open barrel terminals such as Deutsch, computer sensor and Weather Pack
- Handles wire sizes 14-24 gage
- Thin profile allows access to hard to reach areas
- Steel construction
- Comfortable cushioned grips

DISPLAY PACKAGED



18600

TERMINAL CRIMPER FOR DEUTSCH 6, 8 & 10 GAGE CLOSED BARREL TERMINALS 18870

- For use with larger diameter 6, 8 & 10 gage (Contact Sizes 4 & 8) closed barrel terminals
- To use, install the appropriate Die Set, next insert the terminal and wire between the jaws, then squeeze the handles together to complete the crimp
- Includes two Die Sets - one for 6 gage and the other for 8 & 10 gage wire
- Long handles for increased leverage
- All steel construction
- Comfortable handle grips
- 18" Overall length



FROM T-2017A SUPP.

RELEASE TOOL FOR WEATHER PACK TERMINALS 18580

- Quickly and easily depresses the terminal retention tabs to allow the terminal to be removed from the connector when repairing wiring harnesses
- Use with three sizes of Weather Pack terminals: 10-12 AWG, 14-16 AWG and 18-22 AWG
- Can also be used to restore the tabs to their original position
- Comfortable handle grip

DISPLAY PACKAGED



FROM T-2017A SUPP.

DEUTSCH TERMINALS RELEASE TOOL KIT 18550

- Use to release Deutsch terminals from connectors
- Provides coverage in three wire gage ranges: 14-16, 16-18 & 20-24
- Color coded for easy identification
- All metal construction with knurled anodized aluminum handles & stainless steel shafts
- Supplied in a pouch with hook and loop closure

Deutsch Terminal Release Tools are available individually bulk packed:

Cat. No.	Application	Handle Color
18551	14 - 16 Gage Wire	Gold
18552	6 - 18 Gage Wire	Blue
18553	20 - 24 Gage Wire	Red
18560*	6 Gage Wire	Green
18570*	8 & 10 Gage Wire	Gray



*Not included with Cat. No. 18550

18850
18920
18960
18980

RATCHETING TERMINAL CRIMPING KITS

- Includes Die Sets for the most popular automotive terminal crimping applications
- Crimping Tool has a steel frame with comfortable cushioned grips
- Ratcheting action ensures a perfect crimp every time
- Supplied in a durable plastic molded storage case with carrying handle

18850
NEW



18920



18960



18980



		18850	18920	18960	18980
Die Sets Included in Kit					
Die Set	Application				
18921	For insulated terminals 10-22 AWG		✓	✓	✓
18922	For non-insulated open barrel connectors 10-22 AWG including Weather Pack terminals		✓	✓	✓
18923	For fully insulated quick disconnect terminals with thinner wire barrels 10-22 AWG		✓	✓	✓
18924	For non-insulated terminals 8-22 AWG		✓	✓	✓
18925	For miniature insulated rings, spade and butt splices 16-26 AWG		✓	✓	✓
18928	For RG-6 and RG-59 coaxial cable			✓	✓
18929	For 8mm and 8.5mm spiral core spark plug wire . Strips the insulation, crimps the spiral core to the spark plug terminal and crimps the terminal to the spark plug wire insulation.			✓	✓
18937	For 18-30 AWG non-insulated open barrel terminals				✓
18938	For 14-22 AWG insulated flag terminals				✓
18940	For 18, 20 & 22 AWG Weather Pack terminals	✓			
18941	For 12, 14 & 16 AWG Weather Pack terminals	✓			
18942	For 8-22 AWG heat shrink terminals				
To Interchange Die Sets		Lever	Screw	Lever	Lever
Ratcheting Terminal Crimping Tool only (no Die Sets included)		18972	18926	18972	18972

NOTES:

- The Die Sets are interchangeable among the Cat. Nos. 18920, 18930, 18960 and 18980, but not with Cat. No. 18900
- Die Sets are changed in Cat. Nos. 18960 and 18980 by using a quick change lever, and in Cat. Nos. 18920 and 18930 by removing and replacing a screw
- All Die Sets are available individually
- Also included in the Cat. No. 18850 is the Cat. No. 18580, Release Tool for Weather Pack terminals

18930

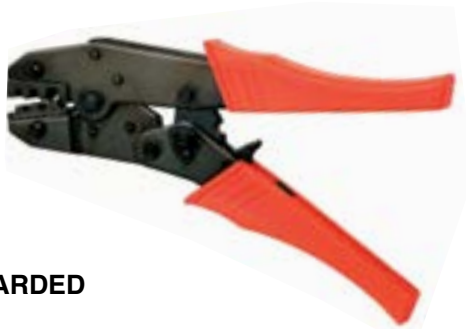

CARDED

RATCHETING TERMINAL CRIMPER FOR WEATHER PACK TERMINALS & OTHER OPEN BARREL TERMINALS

- For most Weather Pack terminals and non-insulated open barrel connectors 10-22 AWG.
- Ensures a perfect crimp every time.
- Crimping tool has a steel frame with contoured grips and can be used with all the Die Sets noted above.

18900



PROFESSIONAL RATCHETING TERMINAL CRIMPER

- Ratcheting action ensures a perfect crimp every time.
- Eliminates damaged or distorted terminals.
- Crimps 10-22 gage insulated terminals.
- Superior design and construction outperforms other crimpers.

(Die Set is fixed and not interchangeable with above Die Sets)

WIRE STRIPPER FOR RECESSED AREAS

19100

- Narrow profile can easily access limited and hard to reach areas
- Strips 12-22 gage single or multiple stranded conductor wire
- Automatically adjusts to wire size
- Adjustable strip length gage
- Built-in wire cutter
- Lightweight and easy to use

Easy to use:

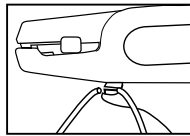

1. To cut wire, place wire to desired length between cutter blades and squeeze handles.

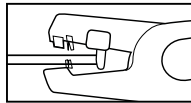

2. Place wire between jaws to desired strip length. Use either the adjustable gage or the scale for reference.

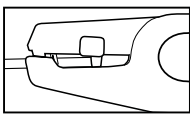

3. Squeeze handles tightly. Wire is held securely by the front jaws while the insulation is tightly cut by the stripping blades.

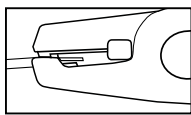

4. Close handles completely to operate a sliding action for the blades that removes insulation automatically, resulting in a clean, neatly stripped end.

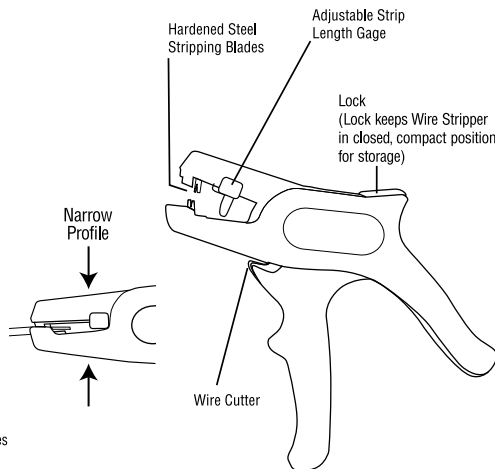

WIRE STRIPPER

19000

- Automatically adjusts to wire size.
- Cuts and strips solid or stranded 12-22 gage wire.
- Handles single or multiple conductor wire.
- Easy to use – yields clean, nick-free results every time.
- Not designed to strip teflon or similar insulations.



HEAVY DUTY AUTOMATIC WIRE STRIPPER

18950

- Three tools in one – strips, crimps and cuts.
- Automatically self-adjusts to strip solid or stranded 10-26 gage wires.
- Removes insulation without damaging the conductor.
- Has adjustable stripping tension.
- Crimps insulated and non-insulated terminals.
- Cuts wire fast, clean and smooth.
- Steel construction with insulated plastic handles.
- Easy to use with single hand action.



STRIPS



CRIMPS



CUTS

ALL ITEMS ON THIS PAGE CARDED

28300



FROM T-2017A SUPP.

CIRCUIT TESTER WITH DIGITAL DISPLAY

- Measures from 5.0 to 28.0 volts DC
- Quickly and easily checks voltage, power, ground and circuitry without the need to hook up complex equipment
- Tall, easy to read LCD display
- Red LED indicates power (+) and green LED indicates ground (-)
- Wire stretches up to 11 feet for use, then automatically retracts
- Computer safe - draws less than 10 milliamps at 12 volts (not for use in testing air bags)
- Heavy duty ground clip with insulator
- Super sharp stainless steel probe

28200



12/24/42 VOLT CIRCUIT TESTER

- For 12 and 24 volt; and 42 volt Hybrid systems
- Computer safe – draws 3 milliamps at 12 volts
- Has two LED's for easy voltage identification: blue for 12 and 24 volts and red for 42 volts
- Wire stretches to 10 feet for use, then automatically retracts
- Super sharp probe
- Heavy duty ground clip with insulator

28000

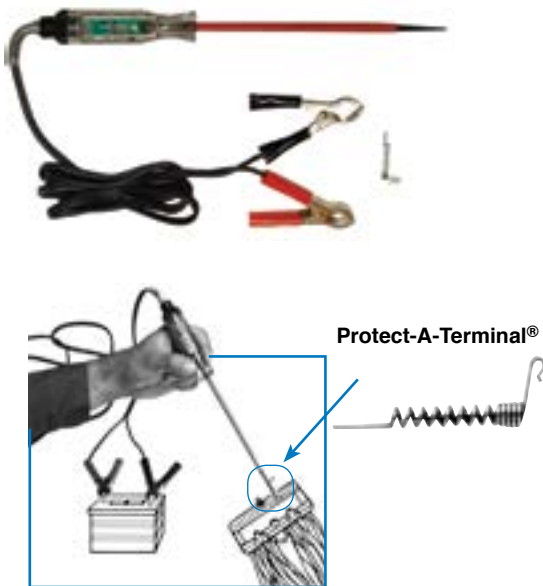

HEAVY DUTY AUTOMOTIVE LOGIC PROBE

28000 - A modern circuit tester with time tested durability. Quickly and safely tests high and low voltages (power and ground) on all vehicle circuits, including computerized engine and body controls.

Features include:

- Tests high and low voltages (power and ground) on 6, 12 and 24 volt systems.
- High impedance; current draw less than 18 milliamps to protect sensitive electronic sensors, microprocessors, electronic ignition components and air bags.
- Dual color LED indicates red for power (high) and green for ground (low).
- 6' of heavy duty, 18 gage dual leads with large battery clips for easy hook-up.
- Leads can be attached regardless of polarity.
- Extra long, 7" insulated probe tests hard-to-reach circuits.
- Includes Protect-A-Terminal[®], Probe Adapter to prevent damage to electrical connectors.
- Can be used as a standard, single lead circuit tester.
- Instructions included.

28100



COMPUTER SAFE AUTOMOTIVE LOGIC PROBE

28100 – High impedance - the current draw is less than 7 milliamps to protect all vehicle circuits including computerized engine and body controls, sensitive electronic sensors, microprocessors, electronic ignition components and air bags. A dual color LED indicates red for power (high) and green for ground (low). Leads can be attached regardless of polarity. Can be used as a standard, single lead circuit tester. Instructions included.

Features include:

- For 6, 12 and 24 volt systems.
- Insulated probe has an exposed length of 3³/₈".
- Includes Protect-A-Terminal[®], Probe Adapter to prevent damage to electrical connectors.
- Has 6 feet of heavy duty, 18 gage dual leads with large battery clips for easy hook-up.

"LIFETIME" HEAVY DUTY CIRCUIT TESTER

27000

27000 - The best quality electrical circuit tester available for checking 6 and 12 volt systems. Made to last longer than anyone's lifetime! Has heavy duty battery clip. 5' of tough, flexible, heavily insulated rubber wire is retained in spring supported strain relief designed to withstand the most rugged use. Bulb is easily replaced. Replacement Bulb Part No. 27010 (G.E. 1889 or equivalent).



EXTRA LONG HEAVY DUTY CIRCUIT TESTER

27130

Specially designed to enable technician to test hard to reach circuits that would not be accessible with standard Circuit Testers. Use to test around hot engine components and under the dashboard. Features extra long red insulated probe and 6' of tough, flexible wire covered with heavy rubber insulation. Over 7" of exposed probe length. Insulated probe eliminates accidental grounding. For 6 and 12 volt systems. Has heavy duty battery clip. Wire is retained in spring supported strain relief designed to withstand the most rugged use. Bulb is easily replaced. Replacement Bulb Part No. 27110 (G.E. 1889 or equivalent).



THE NEW CIRCUIT MASTER® AUTOMOTIVE CIRCUIT TESTER

21700

COMPUTER SAFE – WILL NOT HARM ON-BOARD COMPUTERS

21700 - Circuit Master® is the modern universal circuit tester for all vehicles. Use to test all primary electrical circuits plus any on-board computer systems.

Test computer circuits without fear of causing damage to expensive electronic components. Completely safe to use on microprocessor control modules.

Operating range from 3 –15 volts. Current draw is less than 21 milliamps at 12 volts D.C.

Long life LED glows when voltage is sensed at probe and indicates polarity:

Red = + (Positive)
Green = - (Negative)

Use to locate shorts, opens and intermittents. Made of high impact chemical resistant plastic. Supplied with 4 foot ground wire. All solid state construction.

Circuit Master® is supplied with Protect-A-Terminal®, Probe Adapter (Part No. 21713), which will not deform sensitive female terminals at computer connections.

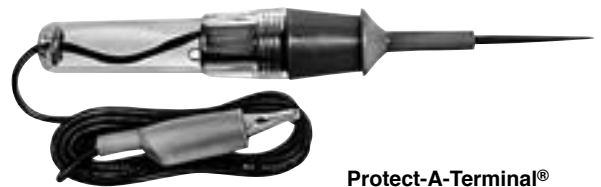

Tests Standard Primary Electrical Systems

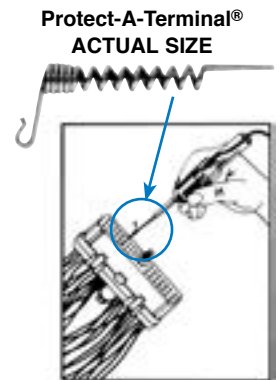

Tests Computer Controlled Electrical Systems

FINGER SAVER® WIRE PIERCING GUIDE

21250

21250 - Ingenious device prevents stabbing your finger! Quickly, easily and safely guides the pick point of most circuit testers into the center of all primary automotive electrical wire. Holds the circuit tester in position allowing technician to work with both hands free. A must for every technician. Impervious to gasoline, oil, thinners and other shop chemicals. Stores on ground wire of circuit tester.

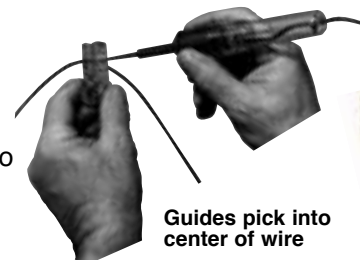

Guides pick into center of wire



ALL ITEMS ON THIS PAGE CARDED

27250



HEAVY DUTY CIRCUIT TESTERS WITH RETRACTABLE WIRE

These Circuit Testers feature an extra long wire that stretches up to 12 feet for use, then automatically retracts. Quickly and easily check electrical circuits and accessories on 6 and 12 volt systems. Great for use on cars, trucks, boats, trailers, motorcycles, airplanes and snowmobiles. Supersharpe probe. A heavy duty ground clip with insulator is on one end of the retractable wire and a spring supported strain relief is on the other. The bulb is easily replaced. Replacement Bulb No. 27303 (G.E. 1889 or equivalent).



27300



CAT. NO.	DESCRIPTION	EXPOSED PROBE LENGTH
27250	LONG, INSULATED PROBE	6½"
27300	STANDARD LENGTH PROBE	3¼"

21000



"CHECK POINT" CIRCUIT TESTER

21000 - By far the largest selling and most widely used automotive circuit tester. Quickly checks all 6 and 12 volt systems. Use with power on. Supplied with 48" ground wire. Use to locate shorts, grounds and open circuits. Replacement Bulb Part No. 21007.

22400



"DUALITE" HIGH AND LOW VOLTAGE TROUBLE SHOOTER

22400 - Two testers in one! Trouble shoot both primary and secondary circuits. Use as a primary circuit tester on 6 and 12 volt circuits. On secondary or high voltage circuits check out spark plugs. Pinpoint minute cracks in distributor caps. Supplied with 48" lead wire. Replacement Bulbs: Low Voltage - Part No. 22408; High Voltage - Part No. 22409.

22700

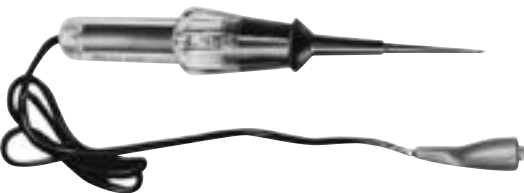

SELF POWERED ELECTRICAL CONTINUITY TESTER

22700 - Use to test for continuity with power disconnected. Excellent for use on marine, recreational and general automotive vehicles. Test appliances and other electrical circuits with power off. Supplied with 48" lead wire. Uses any AA 1.5 volt battery. Battery not supplied. Replacement Bulb Part No. 22707.

21300



HEAVY DUTY CIRCUIT TESTER FOR 18, 24 AND 36 VOLT SYSTEMS

21300 - Checks AC or DC wiring up to 36 volts. Use to check series-parallel switches and solenoids on tractor-trailer starter systems. An absolute must for the trucking, farm, heavy equipment and trailer industries. Supplied with 48" ground wire. Replacement Bulb Part No. 21307.

ALL ITEMS ON THIS PAGE CARDED

DOUBLE WALL ADHESIVE HEAT SHRINK TUBES ASSORTMENT

23210
NEW

FROM
T-2017A
SUPP.

- Adhesive lining provides an environmental seal to prevent moisture, dirt and chemicals from affecting electrical connections
- Excellent for automotive, marine, heavy duty, industrial, construction and home applications
- All tubes have a 3:1 shrink ratio and are weatherproof
- 60 black and red pieces in 5 sizes
- Forms a secure bond over smooth and irregular shapes
- Excellent for insulation, strain relief, abrasion shielding and corrosion protection
- Easily shrinks with our Cat. No. 87250 or equivalent Heat Gun or other heat source
- Shrink tubes made of polyolefin material

Inch Equivalent	Size (Metric)	Quantity	Length	Color
1/8"	3.2mm	7	6"	Black
1/8"	3.2mm	7	6"	Red
3/16"	4.8mm	8	6"	Black
3/16"	4.8mm	8	6"	Red
1/4"	6.4mm	7	6"	Black
1/4"	6.4mm	7	6"	Red
3/8"	9.5mm	4	6"	Black
3/8"	9.5mm	4	6"	Red
1/2"	12.7mm	4	6"	Black
1/2"	12.7mm	4	6"	Red



REPLACEMENT PACKAGES OF DOUBLE WALL ADHESIVE HEAT SHRINK TUBES

For those technicians wanting to replenish our #23210, Double Wall Adhesive Heat Shrink Tubes Assortment or just needing individual sizes, Replacement Tubes are available by diameter:

Cat. No.	Diameter		Quantity Per Poly Bag				Length
	Inch	Metric	Black	Red	Total		
23220	1/8"	3.2mm	10	10	20	6"	
23221	3/16"	4.8mm	10	10	20	6"	
23222	1/4"	6.4mm	10	10	20	6"	
23223	3/8"	9.5mm	5	5	10	6"	
23224	1/2"	12.7mm	5	5	10	6"	



23220
23221
23222
23223
23224
NEW

FROM
T-2017A
SUPP.

HEAT SHRINK TUBES ASSORTMENT

Assortment includes:

- Versatile heat shrink tubes for use in a wide variety of applications in automotive, marine, electrical, industrial, home and more
- 160 assorted pieces in 8 sizes and 5 colors
- Easily shrinks with a Heat Gun or other heat source
- Protects solder joints and wires
- Forms a secure bond over smooth and irregular shapes
- Excellent for insulation, strain relief, abrasion shielding and corrosion protection
- Shrink tubes made of polyolefin material
- Ideal for color coding and bundling
- 2:1 shrink ratio

DIAMETER	QUANTITY
3/32"	25
1/8"	35
3/16"	35
1/4"	35
3/8"	10
1/2"	10
5/8"	5
3/4"	5



23250

REPLACEMENT PACKAGES OF HEAT SHRINK TUBES

Heat Shrink Tubes are available by size in mixed colors per poly bag:

CAT. NO.	DIAMETER	QUANTITY PER POLY BAG
23260	3/32"	25
23261	1/8"	25
23262	3/16"	25
23263	1/4"	25
23264	3/8"	10
23265	1/2"	10
23266	5/8"	10
23267	3/4"	10



23260
23261
23262
23263
23264
23265
23266
23267

22800
22810
22820
22830
22840
NEW

FROM
 T-2017A
 SUPP.

RETRACTABLE TEST LEADS REELS

- A must for testing electrical circuits on cars, trucks, trailers, boats, equipment and more
- Easy to use - Pull out to required length. Leads will stay at desired length until rewound into protective case for storage
- 18 Gage copper wire with insulated alligator clips
- Different colored lead wires allow for easy identification when testing multiple circuits
- Specifications:
 - Maximum amperage rating is 10 amps fully unwound and 6 amps wound
 - Maximum voltage is 30 volts DC

Cat. No.	Description
22800	1 Lead x 30'
22810	2 Leads x 30'
22820	2 Leads x 30' with magnetic base
22830	3 Leads x 10'
22840	3 Leads x 10' with magnetic base



22800



22810



22820



22830



22840

CARDED

23000

AUTOMOTIVE TEST LEAD KIT

23000 - This is the ideal Test Lead Kit for your automotive electrical testing requirements. It contains all the necessary connectors and wire to use as jumper leads or to test a wide variety of automotive electrical and electronic circuits. Kit has 48" heavy duty, highly flexible test leads. Banana plugs will fit standard banana plug receptacles as found in multimeters. Stainless steel probes have 8-32 thread to accept most other female threaded test lead accessories. Supplied in a hangable plastic storage box. The kit includes:



DISPLAY PACKAGED

	QUANTITY			DESCRIPTION
	NEUTRAL	BLACK	RED	
		1	1	48" test lead with probe and banana plug
		1	1	Plunger hook clip with 8-32 female thread
		1	1	Spade connector with 8-32 female thread
		1	1	Probe insulator extension
2				Alligator clip with 8-32 female thread
		1	1	Insulator for alligator clip
		1	1	Insulated alligator clip with female banana plug connection

20 PIECE BACK PROBE KIT

23500

- Use to back probe harness connectors, fuel injectors and automotive sensors
- Straight, 45° & 90° stainless steel probes in .027" & .040" diameters
- Color coded for easy identification
- Insulated body for testing up to 30 volts
- Compatible with standard 4mm plug
- 12" Extension leads quickly plug in to permit testing in recessed areas
- Probes easily insert into automotive connectors
- Kit includes one each:



DESCRIPTION	COLOR	PIN DIA.	DESCRIPTION	COLOR	PIN DIA.
Straight Probe	Black	.040"	90° Probe	Black	.040"
	Blue	.040"		Blue	.040"
	Green	.027"		Green	.027"
	Red	.027"		Red	.027"
	Yellow	.027"		Yellow	.027"
45° Probe	Black	.040"	12" Lead Wire	Black	---
	Blue	.040"		Blue	---
	Green	.027"		Green	---
	Red	.027"		Red	---
	Yellow	.027"		Yellow	---



DISPLAY PACKAGED

PERMA-COIL® JUMPER LEADS

23150

23150 - Use these high quality retractile leads for all purpose circuit jumping and testing. Eliminates tangling. Fully extended length of 10 feet allows the technician to access almost every area of the vehicle. Retracted length is 2 feet. 18 gage wire with ultra flexible, tough insulation can handle stretch after stretch of rugged use. Heavy duty battery clips and alligator clips for strong easy attachment. Stores easily in toolbox. Includes one black lead and one red lead.



CARDED

EXTRA HEAVY DUTY TEST LEADS

23100

23100 - Two 48" test leads. Full flex wire, heavy insulation. Heavy duty jacketed alligator clips. A must when working on late model cars.



CARDED

"JUMPER TWINS" TEST LEADS

22900

22900 - Low cost and practical. Two 30" leads of highly insulated wire. Color coded – one lead black and one lead red.



CARDED

25100

CARDED

SHORT FINDER

25100 - Use to locate shorts quickly and inexpensively in 12 volt automotive circuits. Eliminates need to remove upholstery and floor coverings. Operates through metal parts, panels, fiber and plastic materials. Simply connect leads to posts of blown fuse. Induction type needle indicator pinpoints location of short. Schematic included with instructions. Furnished in clear storage box.

25300

CARDED

INTERMITTENT SHORT INDICATOR AND SHORT CIRCUIT FINDER

25300 - The number and complexity of electrical wiring systems in modern vehicles is growing. Intermittent short circuits are becoming more common and are the most difficult shorts to locate. Use this device **with audio signal** to indicate when intermittent short circuit occurs with vehicle at rest or on road test. After faulty system is indicated, use to find short location. Works on all 12 volt systems. Supplied in clear storage box.

24600

CARDED

ALTERNATOR-GENERATOR-STARTER CURRENT INDICATOR

24600 - Measure CHARGING RATE and STARTER CURRENT on one indicator. No need to purchase two separate tools. Induction type meter. Needs no hook up wires or cables. Hold meter over cable and read.

26200**WIRE AND CABLE TIES ASSORTMENT**

- Self locking, flexible, multi-purpose ties.
- Made from Nylon 6/6.
- Ideal for securing wires, harnesses, cables and components.
- UL approved.
- 750 Piece assortment includes the most popular lengths in different colors:
 - 400 - 4" 18 lbs. tensile strength (100 each white, black, yellow and red ties)
 - 300 - 8" 50 lbs. tensile strength (white ties)
 - 50 - 11" 50 lbs. tensile strength (white ties)

DISPLAY PACKAGED

**DO YOU HAVE AN IDEA FOR A NEW TOOL?
IF SO, IT COULD BE WORTH EXTRA MONEY!**

IN-LINE SPARK CHECKER KIT FOR RECESSED PLUGS

23970

- The one Ignition Spark Checker for troubleshooting virtually all domestic and imported cars, SUV's and trucks.
- A must for testing newer vehicles with recessed spark plugs.
- Can also be used to test conventional and coil-on plug ignition systems.
- Flashing bulb indicates ignition or fuel delivery problem.
- Provides information not available with OBD II code reading devices - pinpoints if there is a spark plug, plug wire, mechanical, fuel injection or electrical problem.
- Saves time and money as technician does not have to swap ignition coils.
- Shows a duplicate view of the ignition spark so technician can visually check condition of ignition system at each cylinder. Frequency and intensity of flash indicates whether there is an ignition system problem or fault in the fuel delivery system.
- Clear plastic body can withstand rough use and resists automotive chemicals.
- Flash can be seen in bright sunlight.
- Protected by mechanical strain relief.
- Safety orange color for easy visibility.
- Fast and easy to use.
- Replacement Bulb Part No. 23975.

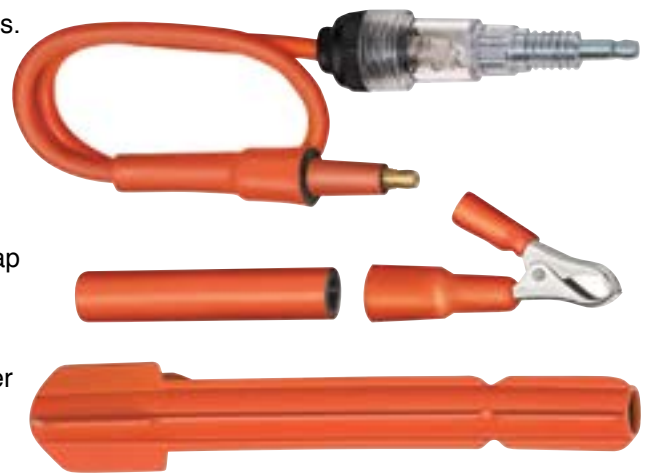

KIT INCLUDES:

- Coil Tester
- Female x Female Adapter for testing conventional ignition systems
- Battery Clip Adapter for testing directly to ground
- Extension for Coil Tester

U.S. Patent No. 7,129,705



Test vehicles with recessed spark plugs



Test coil directly to ground



Test conventional ignition systems

23900**IN-LINE IGNITION SPARK CHECKER**

23900 - Use to quickly troubleshoot ignition system. Device is “hands-free.” Connects in-line between spark plug and spark plug wire. Shows a duplicate view of the ignition spark. Technician can visually check condition of ignition system at each cylinder. Frequency and intensity of flash indicates whether there is an ignition system problem or a fault in the fuel delivery system. Flash can be seen in bright sunlight. Clear plastic body can withstand rough use and resists automotive chemicals. Protected by mechanical strain relief. Replacement Bulb Part No. 23904.

23920**IN-LINE SPARK CHECKER WITH 90° BOOT**

23920 - Features a 90° boot and longer wire to easily install and remove the In-Line Spark Checker between the spark plug and the ignition wire. Great for working in confined areas, such as “cab forward” designed vehicles, to overcome obstructions like shock towers, air conditioning tubing and exhaust headers. Use to quickly troubleshoot ignition system with “hands-free” operation. Shows a duplicate view of the ignition spark. Replacement Bulb Part No. 23924.

- Connects quickly.
- Technician can visually check condition of ignition system at each cylinder.
- Frequency and intensity of flash indicates whether there is an ignition system problem or a fault in the fuel delivery system.
- Flash can be seen in bright sunlight.
- Clear plastic body can withstand rough use and resists automotive chemicals.
- Protected by mechanical strain relief.

23950**COIL ON PLUG IGNITION SPARK CHECKER**

- A quick way to troubleshoot the contemporary “coil on plug” ignition systems found on General Motors, Chrysler, Ford and import vehicles.
- Flashing bulb indicates ignition or fuel delivery problem.
- Quickly plugs into boot on coil then clips to ground.
- Ground wire is 20” long.
- Shows a duplicate view of the ignition spark so technician can visually check condition of ignition system at each cylinder. Frequency and intensity of flash indicates whether there is an ignition system problem or fault in the fuel delivery system.
- Clear plastic body can withstand rough use and resists automotive chemicals.
- Flash can be seen in bright sunlight.
- Protected by mechanical strain relief.
- Replacement Bulb Part No. 23952.

IN-LINE SPARK CHECKER FOR RECESSED PLUGS, NOID LIGHTS AND IAC TEST LIGHTS KIT

36350

- Use to test spark plug circuits, electronic fuel injection signals and idle air control circuits.
- Includes:
 - Cat. No. 23970, In-Line Spark Checker Kit for Recessed Plugs. This is a must for testing newer vehicles with recessed spark plugs. Can also be used to test conventional and coil-on plug ignition systems.
 - 8 Noid Lights for checking GM PFI, Ford TBI, Geo TBI, Bosch PFI, GM TBI, GM SCPI, Bosch 2 and GM MULTEC 2
 - 2 IAC Test Lights for straight and 90° applications
- Quickly diagnose "no start" and engine misses conditions in the electrical fuel injection and spark plug circuits.
- Analyze rough running engines.
- Supplied with instructions in a durable, plastic molded storage case.



Shown testing vehicle with recessed spark plugs

U.S. Patent No. 7,129,705

NOID LIGHTS, IAC TEST LIGHTS & IGNITION SPARK TESTER KIT

36330

- Use to test electronic fuel injection signals, idle air control circuit and spark plug circuits.
- Includes:
 - 8 Noid Lights for checking GM PFI, Ford TBI, Geo TBI, Bosch PFI, GM TBI, GM SCPI, Bosch 2 and GM MULTEC 2
 - 2 IAC Test Lights for straight and 90° applications
 - Cat. No. 23900, In-Line Ignition Spark Checker
- Quickly diagnose "no start" and engine miss conditions in the electrical fuel injection and spark plug circuits.
- Analyze rough running engines.
- Supplied with instructions in a durable, plastic molded storage case.



NOID LIGHT SET

36300

36300 - Quickly, easily and economically test electronic fuel injection signals. Supplied with lights to check GM TBI, Bosch PFI, Ford TBI, GM PFI, Geo TBI and GM SCPI. Easy to use – just disconnect the wiring to the fuel injectors, install the Noid Light into the injector wiring harness and crank or start the engine. A flashing light indicates normal pulsing voltage. A steady light or no light indicates an electrical problem. Supplied with instructions in a durable, plastic molded storage case.



ELECTRONIC FUEL INJECTION AND IGNITION SPARK TESTER KIT

36310

36310 - Quickly diagnose "no start" and engine miss conditions in the electrical fuel injection and spark plug circuits. Analyze rough running engines. Contains Cat. No. 36300, Noid Light Set to test electronic fuel injection signals and the Cat. No. 23900, In-Line Ignition Spark Checker to troubleshoot the ignition system. In-Line Spark Checker shows a duplicate view of the ignition spark. Supplied with instructions in a durable, plastic molded storage case.

Noid Lights are supplied to check:

- Bosch PFI • Ford TBI • Geo TBI • GM PFI • GM SCPI • GM TBI



A FULL LINE OF QUICK COUPLING FUEL INJECTION PRODUCTS EASY TO USE - QUICK TO CONNECT

58000

UNIVERSAL MASTER FUEL INJECTION PRESSURE TEST KIT WITH 3 1/2" GAGE AND QUICK COUPLERS



With large 3 1/2" diameter gage having rubber boot and hang-up hook (Cat. No. 58040)























- The one kit for testing virtually all domestic and imported cars and trucks with gasoline fuel injection systems.
- For Multi-port, Throttle Body (TBI) and Continuous Injection Systems (CIS).
- Quick coupler fittings provide easy and fast hook-ups.
- Accurately and quickly diagnose fuel injection related problems.
- 4' hose provides more mobility while monitoring fuel injection pressure.
- Tests current and older vehicles.
- Supplied with two gages:
 - 0-100 PSI, 0-7 BAR and 0-700 kPa with rubber boot and hang-up hook.
 - 0-50 PSI and 0-3.5 BAR for accurate low pressure applications.
- Includes adapters, hoses and clamps.
- Blow molded case with numbered positions for storage and easy access of components.
- Bleed-off valve with 6 feet of translucent hose to safely depressurize system after completion of testing.
- Complete illustrated instruction manual included.
- Supplied in a durable, plastic storage case with carrying handle.

**Fuel Injection Testing products on this
page use quick coupling fittings**

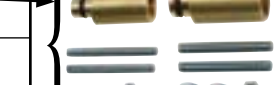
FUEL INJECTION PRESSURE ADAPTERS WITH QUICK COUPLERS

These adapters are for use with our Cat. Nos. 53770, 53800, 53865, 53900, 53950, 53980, 56200, 56250, 58000 & 58100.

CAT. NO.	DESCRIPTION	INFORMATION	
53785	Chrysler Throttle Body Adapter Set with Quick Coupler	Includes Double End Barbed Adapter, hoses and clamps.	
53788	Double End Barbed Adapter	Where vehicles require testing by splicing into 1/4", 5/16" or 3/8" fuel lines.	
53850	Small Schrader Valve Test Adapter for Ford	Ford Multi-port (EFI). For smaller Schrader valves.	
53903	Single End Barbed Adapter	For vehicles requiring end of line testing with 1/4", 5/16" or 3/8" fuel line hose.	
53904	48" Hose - 1/4" NPT Male x Quick Coupler Female	Provides more mobility while monitoring fuel injection pressure.	
53908	Large Schrader Valve Test Adapter for GM & Chrysler	For larger Schrader valves found on GM and Chrysler Multi-port vehicles with 7/16"-20 threaded test port.	
57200	Honda Fuel Injection Pressure Test Adapter	For vehicles with 6mm-1.00 Banjo Bolts found on Honda, Acura & Sterling Multi-port (PGM-FI).	
57230	Ford In-Line Spring Lock Fitting Adapter	For spring lock fittings. Ford EFI.	
57260	Ford In-Line 5/16" Hair Pin Adapter	For 5/16" hair pin connections. Ford CFI.	
57280	GM & Chrysler In-Line 3/8" Hair Pin Adapter	In-Line adapter for vehicles with 3/8" hair pins.	
57350	Banjo Bolt Adapter Kit	For vehicles with 8mm-1.00, 10mm-1.00, 12mm-1.25 & 12mm-1.50 Banjo Bolts found on Asian & European vehicles with Multi-port & Bosch AFC.	
57650	GM Throttle Body Injection (TBI) Fuel Pressure Adapter	In-Line Adapter – Replaces fuel filter with threads on both ends.	
57660	GM 2.2 Liter Fuel Injection Pressure Test Adapter	1992 & up such as Chevrolet Cavalier, Pontiac Sunbird, Buick Skylark & Quad 4 equipped Pontiac Grand Am (Non Multi-port).	
57670	GM 2.5 & 5.7 Liter Fuel Injection Pressure Test Adapter	For vehicles with quick connect fuel filters such as 2.5 Liter Oldsmobile Ciera 1989 & up; 5.7 Liter Chevrolet Caprice 1991 & up (Non Multi-port).	
58009	90° GM & Chrysler Swivel Adapter	90° Adapter. For multi-port vehicles having restricted access to larger Schrader valves.	
58010	90° Ford Swivel Adapter	90° Adapter. For vehicles having restricted access to smaller Schrader valves (EFI).	
58012	Volvo 14mm LH-Jetronic Adapter	For older Volvos .	
58040	3 1/2" Gage	0-100 PSI, 0-7 BAR and 0-700 kPa with rubber boot and hang-up hook	
58600	11mm & 16mm Fuel Rail Pressure Test Adapter Kit	Chrysler, Dodge, Hyundai, Infiniti, Kia, Lexus, Mitsubishi, Nissan & Plymouth	
58625	11mm Fuel Rail Pressure Test Adapter	Infiniti, Kia, Lexus & Nissan	
58650	16mm Fuel Rail Pressure Test Adapter	Chrysler, Dodge, Hyundai, Mitsubishi, & Plymouth	
58670	Honda Pulse Dampener Adapter	Honda Odessey and S2000	

Fuel Injection Testing products on this page use quick coupling fittings

53950

FUEL INJECTION PRESSURE TESTER WITH 2 GAGES AND QUICK COUPLERS

- Tests gasoline fuel pump pressure on most domestic and imported fuel injection equipped vehicles.
- Quick couplers provide for fast and easy hook-up.
- Kit contains everything to test all GM vehicles with Multi-port and some Throttle Body Injection (TBI). Tests all Chrysler cars with Multi-port turbos and some TBI. Use on most Ford TBI systems equipped with or without small Schrader test valve. Tests all Ford vehicles with Multi-port fuel injection systems.
- Includes two gages: 0-100 PSI (0-7.0 BAR) with hang-up hook and 0-50 PSI (0-3.5 BAR) for more detail.
- Full instructions included.
- Supplied in a durable vinyl pouch for store display and tool box storage.

53980

FUEL INJECTION PRESSURE TESTER WITH 2 GAGES AND QUICK COUPLERS IN STORAGE CASE

- Same product as Cat. No. 53950 above but supplied in a 11¼" x 7½" x 3" durable, plastic molded storage case with carrying handle. Case provides space to expand the kit.

53900

FUEL INJECTION PRESSURE TESTER WITH QUICK COUPLERS

- Works on GM and Chrysler vehicles same as Cat. No. 53950, but on Fords, limited to older TBI systems not equipped with small Schrader test valve. Includes only large gage with hang-up hook.
- Packaged in a durable vinyl pouch for store display and tool box storage.

53770

BASIC FUEL INJECTION PRESSURE TESTER WITH QUICK COUPLERS

- The perfect starter kit for the serious technician.
- Can easily be expanded to provide additional coverage using Tool Aid's quick coupler adapters (See Page 19) to create a custom kit.
- Includes Cat. No. 53908, Large Schrader Valve Test Adapter for GM and Chrysler.
- 2½" diameter gage with dual scale and hang-up hook measures 100 PSI and 7 BAR.
- Instructions provided.

Fuel Injection Testing products on this page use quick coupling fittings

MULTI-PORT FUEL INJECTION PRESSURE TESTER SYSTEM WITH QUICK COUPLERS FOR DOMESTIC AND FOREIGN VEHICLES 56200

- Tests the gasoline fuel pressure on virtually all domestic and foreign vehicles equipped with Multi-port fuel injection. Can also test Throttle Body Injection (TBI) systems on most Chrysler and Ford vehicles.
- Includes:
 - Adapter for large Schrader valves.
 - Adapter for Ford Multi-port (EFI) and throttle body systems.
 - Adapter for Honda vehicles.
 - 4 piece Banjo Bolt Adapter Set: 8mm-1.00, 10mm-1.00, 12mm-1.25 and 12mm-1.50 for testing Asian and European Multi-port vehicles.
 - Assorted hoses, fittings and clamps to test older vehicles.
 - 2 1/2" diameter gage with hang-up hook has dual scale – measures 100 PSI and 7 BAR.
 - Bleed-off valve and 6' hose to safely depressurize system after completion of test.



MULTI-PORT FUEL INJECTION PRESSURE TESTER SYSTEM FOR DOMESTIC AND FOREIGN VEHICLES, IN STORAGE CASE 56250

- Same product as Cat. No. 56200 but supplied in a durable, plastic molded storage case with carrying handle. Case measures 11 1/4" x 7 1/2" x 3" and has ample space for additional adapters and parts.



CIS K-JETRONIC FUEL INJECTION TESTER WITH QUICK COUPLERS 53800

Tests CIS (Continuous Injection System) found on European cars and Volkswagen models assembled in the U.S. These vehicles are equipped with Bosch CIS K-Jetronic Fuel Injection Systems. This is an in-line pressure tester which indicates problem sources – control pressure regulator, fuel distributors or other specific fuel injection components that may require replacing. Tests CIS Non-Electronic with metric threads, CIS/Lambda Electronic with metric threads and CIS E-Electronic with metric threads. Will not test other Bosch fuel injection systems. To test non-Bosch fuel injection systems, use our Cat. Nos. 56200, 56250 or 58000.

Gage measures 2 1/2" diameter and has dual scale: 100 PSI and 7 BAR. Gage has hang-up hook. Supplied with all adapters, adapter application chart, hook-up and parts schematic drawing and complete instructions. Packaged in clear pouch for store display and tool box storage.

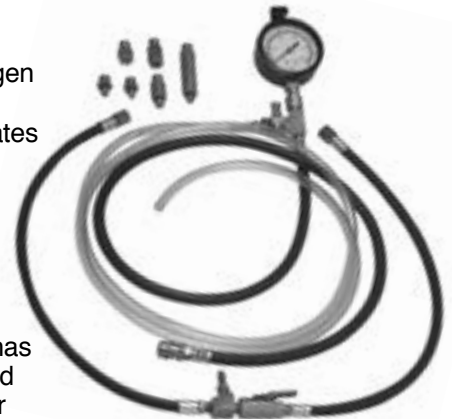

CIS K-JETRONIC FUEL INJECTION PRESSURE TESTER WITH QUICK COUPLERS IN STORAGE CASE 53865

Same as our Cat. No. 53800 above but packed in a durable, plastic molded storage case with carrying handle. Case measures 11 1/4" x 7 1/2" x 3" and has ample space for additional adapters and parts.



38000



Typical Hook-Up

COMPREHENSIVE FUEL INJECTION PRESSURE TEST KIT

38000 - A complete, master fuel injection pressure tester for cars and trucks.

- **COMPREHENSIVE** – Tests gasoline fuel injection pressure systems on virtually all domestic and imported cars and trucks.
- **VERSATILE** – For multi-port, throttle body and C.I.S. K-Jetronic Fuel Injection Systems.
- **TOP QUALITY** – Accurate and reliable.
- **AFFORDABLE** – A great value for automotive technicians.
- **EASY TO USE** – Complete illustrated instruction manual included.
- **UP TO DATE** – Tests current and older vehicles.
- **COMPACT** – 15" x 10" x 3¼" durable, plastic storage case with carrying handle easily stores in tool chest.

FEATURES

- Two gages with dual ranges:
0-100 PSI (0-7 BAR) with hang-up hook.
0-50 PSI (0-3.5 BAR) for accurate low pressure applications.
- Bleed off valve with 6 feet of translucent hose to safely depressurize system after completion of testing.
- Case is molded with numbered positions for all components to ensure proper operation and organization.
- Adapters for special applications.
- Assorted hoses, hose barb fittings and hose clamps to test older vehicles.
- All components connect together easily for fast hook-ups.

33770



BASIC FUEL INJECTION PRESSURE TESTER

33770 - The perfect starter kit for the serious technician. Use with other Tool Aid adapters (See Page 25) to create a custom kit or to expand as the need arises. Includes:

- Adapter for all Domestic, Asian and European vehicles equipped with a standard Schrader test port.
- 2½" diameter gage with dual scale and hang-up hook. Measures 100 PSI and 7 BAR.
- Complete instructions.

CARDED

37250



DISCONNECT TOOL FOR SPRING LOCK COUPLING ON FORD FUEL INJECTION AND AIR CONDITIONING SYSTEMS

37250 - This is a necessary tool used to disconnect the ½" spring lock coupling found on Ford fuel injection systems so that pressure tests can be made with Cat. Nos. 37230 and 57230. Spring lock fittings are found on Ford fuel line and air conditioning lines. This tool can be used on ⅜", ½", ⅝" and ¾" sizes.

Fuel Injection Testing products on this page use screw on fittings

MULTI-PORT FUEL INJECTION PRESSURE TESTER FOR DOMESTIC AND FOREIGN VEHICLES

36200

36200 - This kit can test the fuel pressure on virtually all domestic and foreign vehicles equipped with multi-port fuel injection. Can also test throttle body injection systems on most Chrysler and Ford vehicles.

Includes:

- Adapter for Domestic, Asian and European vehicles equipped with a standard Schrader test port.
- Adapter for Ford multi-port (EFI) and throttle body systems.
- Adapter for Honda vehicles.
- 4 piece adapter set: 8mm-1.00, 10mm-1.0, 12mm-1.25, and 12mm-1.50 to test most Asian and European multi-port vehicles.
- Assorted hoses, hose barb fittings and hose clamps to test older vehicles.
- 2½" diameter gage with dual scale – measures 100 PSI and 7 Bar and has a hang-up hook.
- Bleed-off valve and hose to safely de-pressurize system after completion of test.
- Packed with complete instructions in a durable vinyl pouch for store display and tool box storage.
- Not for diesel engines.



MULTI-PORT FUEL INJECTION PRESSURE TESTER FOR DOMESTIC AND FOREIGN VEHICLES IN MOLDED PLASTIC STORAGE CASE

36250

36250 - Same product as Cat. No. 36200 above but supplied in a durable, plastic molded storage case with carrying handle. Case measures 1 1¼" x 7½" x 3" and has ample space for additional adapters and parts.



C.I.S. K-JETRONIC FUEL INJECTION TESTER

33800

33800 - Test C.I.S. (Continuous Injection System) found on European cars and Volkswagen models assembled in the U.S. These vehicles are equipped with Bosch C.I.S. K-Jetronic Fuel Injection Systems. This is an in-line pressure tester which indicates problem sources – control pressure regulator, fuel distributors or other specific fuel injection components that may require replacing. Tests C.I.S. Non-Electronic with metric threads, C.I.S./Lambda Electronic with metric threads and C.I.S. E-Electronic with metric threads. Will not test other Bosch fuel injection systems. To test non-Bosch fuel injection systems use our Cat. Nos. 36200, 36250 or 38000.

Gage measures 2½" diameter and has dual scale: 100 PSI and 7 BAR. Gage has hang-up hook. Supplied with all adapters, adapter application chart, hook-up and parts schematic drawing and complete instructions. Packaged in clear pouch for store display and tool box storage.

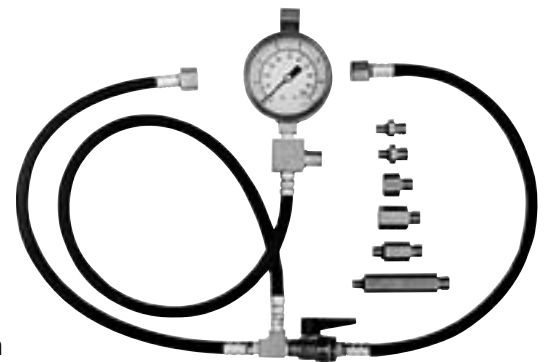

C.I.S. K-JETRONIC FUEL INJECTION TESTER IN MOLDED PLASTIC STORAGE CASE

33865

33865 - This is our complete Cat. No. 33800 packed in a durable, plastic molded storage case with carrying handle. Case measures 11¼" x 7½" x 3" and has ample space for additional adapters and parts.



Fuel Injection Testing products on this page use screw on fittings

33950

FUEL INJECTION PRESSURE TESTER WITH TWO GAGES

33950 - Test gasoline fuel pump pressure on most domestic and imported fuel injection equipped vehicles. Easy to hook up and read. Kit contains everything to test all GM vehicles with multi-port and some throttle body injection (TBI). Test all Chrysler cars with multi-port turbos and some TBI. Use on most Ford TBI systems equipped with or without small Schrader test valve. Test all Ford vehicles with multi-port fuel injection systems. Includes two gages for more accurate testing:

Large Gage - Calibrated from 0-100 PSI (0-7.0 BAR)

Small Gage - Calibrated from 0-50 PSI (0-3.5 BAR)

Large gage can be used for all applications and has hang-up hook. Small gage provides more detail when pressure will not exceed 50 PSI (0-3.5 BAR). Full instructions included. Supplied in durable vinyl pouch for store display and tool box storage.

33900

FUEL INJECTION PRESSURE TESTER

33900 - Works on GM and Chrysler vehicles same as Cat. No. 33950, but on Fords, limited to older TBI systems not equipped with small Schrader test valve. Supplied with large gage only. Gage equipped with hang-up hook.

SUPPLIED IN
STORAGE POUCH

33980

FUEL INJECTION PRESSURE TESTER WITH TWO GAGES IN MOLDED PLASTIC STORAGE CASE

33980 - Same product as Cat. No. 33950 above but supplied in a durable, plastic molded storage case with carrying handle. Case measures 11¼" x 7½" x 3" and has ample space for additional adapters and parts.

Fuel Injection Testing products on this page use screw on fittings

FUEL INJECTION PRESSURE TESTER ADAPTERS

The adapters below are for use with Cat. Nos. 33770, 33900, 33950, 33980, 36200, 36250 & 38000:

APPLICATION	DESCRIPTION	CAT. NO.
CHRYSLER Throttle Body	Throttle Body Adapter Set – Includes 1/4" & 5/16" hose barbs and hoses (Included with Cat. Nos. 33900, 33950, 33980, 36200, 36250 & 38000)	33785
FORD Multi-port (EFI) & Throttle Body	Ford Adapter for small Schrader test port (Included with Cat. Nos. 33950, 33980, 36200, 36250 & 38000)	33850
Low Pressure CFI	Ford In-Line Adapter with hair pins (Included with Cat. No. 38000)	37260
High Pressure EFI	Ford In-Line Adapter with spring lock fittings (Included with Cat. No. 38000)	37230
GENERAL MOTORS Throttle Body Injection (TBI)	GM In-Line Adapter – Replaces fuel filter with threads on both ends	37650
2.2 Liter	1992 & up such as Chevrolet Cavalier, Pontiac Sunbird, Buick Skylark, and Quad 4 equipped Pontiac Grand Am	37660
2.5 Liter & 5.7 Liter	For vehicles with quick connect fuel filters such as 2.5 liter Oldsmobile Ciera 1989 - up, and 5.7 liter Chevrolet Caprice 1991 - up.	37670
HONDA, ACURA & STERLING: Multi-port (PGM-FI)	Honda Adapter (Included with Cat. Nos. 36200, 36250 & 38000)	37200
ASIAN & EUROPEAN VEHICLES Multi-port & Bosch AFC	8mm-1.00, 10mm-1.00, 12mm-1.25, 12mm-1.50 Adapters (Included with Cat. Nos. 36200, 36250 & 38000) Not for Bosch C.I.S.	37350
ALL	0-100 PSI (0-7.5 BAR) Gage	33907
ALL	0-50 PSI (0-3.5 BAR) Gage (Included with Cat. Nos. 33950, 33980 & 38000)	33966
ALL	Pressure Bleed-off Kit – For use with Cat. Nos. 33770, 33800, 33865, 33900, 33950 & 33980. (Included with Cat. Nos. 36200, 36250 & 38000)	37400
ALL	Molded Plastic Storage Case – Neatly stores Tool Aid adapters and gages	33875
ALL	48" Hose for Fuel Injection Pressure Testing	33936

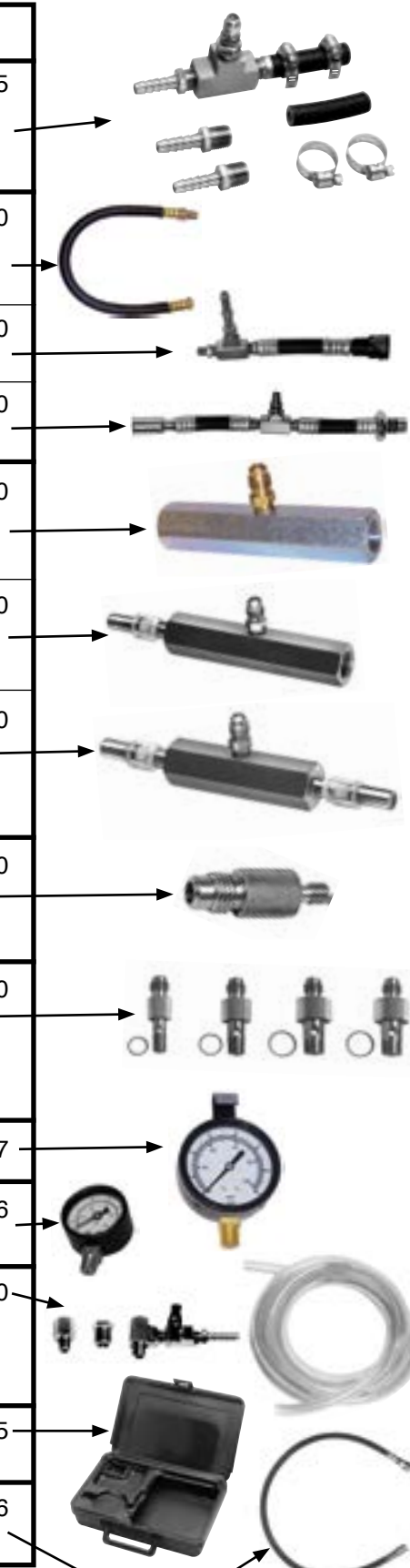

Fuel Injection Testing products on this page use screw on fittings

34000



UNIVERSAL COMPRESSION TESTER FOR GASOLINE ENGINES

34000 - Test compression on all domestic and foreign cars and most trucks. Adapters fit vehicles with 14mm and 18mm plugs including long reach and 5/8" hex plugs. Flex hose eliminates need to remove auxiliary equipment such as power brakes and steering, air conditioning and manifold. Screw-in adapters guarantee accuracy over push-in type testers. Quick side release valve permits retest without removal of adapters. Gage ranges 0-300 PSI and 0-21 BAR.

SUPPLIED IN STORAGE POUCH

34300



HEAVY DUTY COMPRESSION TESTER FOR GASOLINE ENGINES SUPPLIED IN MOLDED PLASTIC STORAGE CASE

34300 - Complete kit for testing compression of gasoline engines on domestic and foreign cars and trucks plus motorcycles, snow mobiles and lawn mowers. Adapters provided for 10mm, 12mm, 14mm and 18mm applications. Flex hose eliminates need to remove auxiliary equipment such as power brakes and steering, air conditioning and manifold. Screw-in adapters guarantee accuracy over push-in type testers. Quick disconnect for easy hook-ups. Quick side release valve permits retests without removal of adapters. Comes complete with repair kit that includes "O" rings, valve cores and installation tool. Gage ranges: 0-300 PSI and 0-21 BAR. Full instructions provided.

34020



12mm & 16mm COMPRESSION TEST ADAPTER FOR FORD TRITON ENGINES

- Dual threaded male end provides two adapters in one for testing compression at the spark plug ports on Ford Triton Engines:
 - Use the 16mm-1.50 male threads on 3 valve Triton engines 2004 through 2008 5.4L Ford F-150; and 2005 4.6L Ford Mustang
 - The 12mm-1.25 male threads are for use beginning with the model year 2009 Triton 4.6L, 5.4L and 6.8L engines
- Provided with a long reach flexible hose to access recesses & around obstructions
- Screws onto the 14mm-1.25 male thread at the end of the hose adapter for Cat. Nos. 34000 and 34300

33650



TOP DEAD CENTER INDICATOR

33650 - Tool whistles as the piston approaches Top Dead Center (TDC) on the compression stroke and stops whistling when the piston reaches TDC. Helps to eliminate the guesswork involved when diagnosing jumped timing belts and timing chains. Aids in valve adjustments and installation of distributors, timing belts and timing chains. 2-in-1 fitting threads into all 14mm and 18mm spark plug ports. 27" overall length. Not for use on diesel engines. Instructions included.

AUTOMATIC TRANSMISSION AND ENGINE OIL PRESSURE TESTER WITH TWO GAGES

34550

34550 - Check oil pressure in automatic transmissions and engines. Adapters provide coverage of most domestic and imported cars and light trucks including late models.

Supplied with two gages calibrated as follows:

Large Gage	Small Gage
0-600 PSI	0-50 PSI
0-4,000 kPa	0-3.5 BAR
0-40 BAR	

Large gage can be used for all applications and has a hang-up hook. Use small gage for more accurate reading of engine oil pressure where maximum oil pressure does not exceed 50 PSI (3.5 BAR). Includes 6 feet of oil proof hose and 10 assorted fittings. Supplied in durable vinyl pouch for store display and tool box storage. Full instructions provided.

Now includes an adapter with two grooves, Cat. No. 34573, for use on most Asian and some American and European vehicles. Thread size is 8mm-1.00 Male x 1/8" NPT Female.



NOTE: Do not use small gage to test automatic transmission pressure.

AUTOMATIC TRANSMISSION AND ENGINE OIL PRESSURE TESTER

34500

34500 - Same as Cat. No. 34550 but supplied with only one gage calibrated from 0-600 PSI, 0-4000 kPa and 0-40 BAR. Gage is equipped with hang-up hook.



SUPPLIED IN STORAGE POUCH

AUTOMATIC TRANSMISSION AND ENGINE OIL PRESSURE TESTER WITH TWO GAGES IN MOLDED PLASTIC STORAGE CASE

34580

34580 - Same product as Cat. No. 34550 above, but supplied in a durable, plastic molded storage case with carrying handle. Case measures 11 1/4" x 7 1/2" x 3" and has ample space for additional adapters and parts.



POWER STEERING TESTER IN MOLDED PLASTIC STORAGE CASE

34650

34650 - Gives fast, accurate power steering analysis. Test for defects in power steering pumps, gears and lines. Large heavy duty gage reads from 0-2,000 PSI and 0-140 BAR. Rule out power steering problems before expensive suspension or steering linkage problem is attacked. Supplied with thirteen adapters including connectors for all Fords with standard or Type I 3/8" tube fittings. Use to test power steering systems on most General Motors and Chrysler vehicles. Will also test some AMC, Jeep, Saab and Volkswagen models. Full instructions provided. Supplied in a durable, plastic molded storage case with carrying handle. Case measures 11 1/4" x 7 1/2" x 3" and has ample space for additional adapters and parts.



33600

PACKED IN
STORAGE
POUCH



EXHAUST BACK PRESSURE TESTER

33600 - Test for clogged or obstructed catalytic converters and mufflers. Fast and easy to use. Threads into Oxygen Sensor Port. Kit includes 12mm and 18mm adapters to fit most domestic and imported vehicles. Gage measures 2½" diameter and has dual scale: 15 PSI and 1.00 Kg/Cm². Hose is 41" long. No need to tap into exhaust system then reseal holes afterwards. Packed in a vinyl pouch for store display and tool box storage. Complete with instructions.

33700

PACKED IN
STORAGE POUCH



DELUXE VACUUM AND FUEL PUMP TESTER

33700 - Widely used in motor diagnostic work. Check for leaky intake manifold, clogged muffler and leaky, burnt or sticky valves. Diagnose incorrect timing. Determine accurate fuel pump pressure. Locate leaks in gas line. Readings shown and interpreted on face of multi-colored dial. 3½" gage has English and metric scales. Has range of 0-28 Inch (0-70 Cm) vacuum and 0-10 PSI (0-0.7 Kg/Cm²) pressure. Complete with hose, three fittings and operating instructions. Fuel pump specs by manufacturer and model supplied.

32000

CARDED



STETHOSCOPE

32000 - Excellent technician's aid designed to detect and locate sources of abnormal noise. Allows technician to quickly find and analyze the source of a problem in engines or other moving parts. Sound is transmitted and amplified through a sensitive diaphragm. Pinpoint worn or defective bearings. Locate cylinders with engine knocks. Determine if any fuel injectors are hung-up or inoperative. Suspected trouble spots can be reached with extension yielding 12" probe length.

**DO YOU HAVE AN IDEA FOR A NEW TOOL?
IF SO, IT COULD BE WORTH EXTRA MONEY!**

FORD POWER STROKE DIESEL COMPRESSION TESTING SET

35750
NEW

Dedicated kit for testing the popular Ford Power Stroke engines. Set consists of Cat. No. 34700 and three diesel tester adapters in a molded plastic storage case with carrying handle. Instructions for each adapter are included.

CAT. NO.	DESCRIPTION
34700	Diesel Compression Tester
35250	Diesel Tester Adapter for 7.3L Power Stroke Ford & Navistar
35450	Diesel Tester Adapter for Ford 6.7L
35650	Diesel Tester Adapter for Ford 6.0L



FROM
T-2017A
SUPP.

DIESEL ENGINE COMPRESSION TESTER SET

34900

34900 - Set consists of Cat. No. 34700 and five of the most popular diesel tester adapters as shown on pages 30-32. Presented in a molded plastic storage case with carrying handle. Instructions for each adapter are included.

CAT. NO.	DESCRIPTION
34700	Diesel Compression Tester
34730	Diesel Tester Adapter for GM Cars and 6.9L & 7.3 L Ford/International Engines
34740	Diesel Tester Adapter for Volkswagen, Volvo, Audi & others
34760	Diesel Tester Adapter for Small Cummins Engines
34770	Diesel Tester Adapter for Bacharach Adapters
34780	Diesel Tester Adapter for Mercedes Benz Cars



DIESEL TESTER SET FOR SMALL AND LARGER CUMMINS ENGINES

34860

34860 - Contains a complete adapter system for testing both smaller and larger Cummins engines. Packed with our Cat. No. 34700 in a molded plastic storage case with carrying handle. Instructions and application information included.

APPLICATIONS

Cummins Engines – V-185, V-210, V-225, V-555, VT-255, VT-555, NH, V-6, V-8, V-12



DIESEL COMPRESSION TESTER

34700

34700 - Measures cylinder pressure on diesel equipped cars and trucks. Records maximum pressure reached during engine test. Release valve allows for immediate venting and resets gage for repeat tests. Swivel end quick coupler is connected to any one of the adapters shown on pages 30-32. High pressure hose is 16 1/2" long. Gage is scaled from 0-1,000 PSI and 0-70 BAR.

NOTE: Adapters are not included with Cat. No. 34700 and must be ordered by individual Catalog Number.

CARDED



EXTENSION HOSE FOR DIESEL COMPRESSION TESTING

34729

- Makes for easier diesel compression testing in areas with restricted clearance.
- Attaches between Cat. No. 34700, Diesel Compression Tester and Tool Aid brand diesel test adapters.

















**DIESEL ENGINE COMPRESSION TEST ADAPTERS
FOR USE WITH CAT. NO. 34700**

	APPLICATION	ENGINE	TESTING PORT	THREAD	CAT. NO.
34730 	Allis Chalmers	6000, 7000, 10000 & 11000	Fuel Injector	N/A	34800
	Audi	All	Fuel Injector	24mm-2.00	34740
34740 	Bacharach	Allows a Bacharach brand adapter to be used with our tester, Catalog No. 34700	N/A	N/A	34770
	Bedford	200, 220, 300, 330, 466	Fuel Injector	N/A	34800
	BMW	2.4L	Glow Plug	12mm-1.25	34880*
34760 	Case, J. I.	Models not using pencil nozzle	Fuel Injector	N/A	34800
		70 Series, 188 & 207 C.I.D. pencil nozzle	Fuel Injector	N/A	35300
		8.3L	17mm Injector	N/A	35690
34770 	Caterpillar	"Capsule" type nozzles including models D-336, 1674, 1676, 3406, 3406B, 3408 & 3412	Fuel Injector	N/A	35200
		1100 & 3208 Series	Fuel Injector	N/A	35300
		3054, 3056	Injector	25mm-1.50	35730
34780 	Chevy Luv	1.8L & 2.2L	Glow Plug	10mm-1.25	34950
	Cummins	6 BT, 4.02" bore, 5.9L	Fuel Injector	24mm-2.00	34740
		V-185, V-210, V-225, V-555, VT-255 & VT-555	Fuel Injector	N/A	34760
34800 		These 5½" bore engines: NH (855 cubic inches), V-6, V-8 & V-12 & 903 V-8 Cylindrical PTB	Fuel Injector	N/A	34840
		5.9L 24 Valve electronic injection and 5.9L ISB, ISBE, ISC & QSB diesel engines	Fuel Injector	N/A	35600
		C Series 8.3L	17mm Injector	N/A	35690
		B Series 3.3L	17mm Injector	N/A	35700
34840 	Cummins/Case "B" Series	2.9L, 3.9L, 5.9L	Fuel Injector	24mm-1.50	35150
34880 	Deere, John	Early 300, 400 & 500 Series, 276, 404 & 531, C.I.D.	Fuel Injector	N/A	35300
		404, 466, 531, 619	21mm Injector	N/A	34800 or 35680
34950 	Detroit Diesel	53, 71, 92, 110, 149, V53, V71 with low or high clamp injector hold down	Fuel Injector	N/A	35100
		Series 40	Fuel Injector	N/A	35710
35000 	Deutz	Some Models	17mm Injector	N/A	35690
	Dodge/Cummins	5.9L	Fuel Injector	24mm-1.50	35150
	Fiat Allis	8035-02-300, 8035-02-301, 8035-02-302, 8045-02, 8045-03	Fuel Injector	N/A	34800
35100 	Ford Escort	2.0L	Glow Plug	10mm-1.25	35550

Continued on Page 31

Continued from Page 30

APPLICATION	ENGINE	TESTING PORT	THREAD	CAT. NO.	
Ford/Navistar	6.9L & 7.3L	Glow Plug	10mm-1.00	34730	 35150
	7.3L Turbo, Direct Injection (Power Stroke)	Glow Plug	10mm-1.00	35250	
	Power Stroke 6.0L & 6.4L engines found on F-250 through F-550 trucks and International VT 365	Glow Plug	14mm-1.25	35650	 35200
	2011 and up 6.7L Power Stroke V8 turbocharged engine found in F-Series vehicles	Glow Plug	8mm-1.00	35450	 35250
	6.6L, 7.8L, Bosch	21mm Injector	N/A	35680	 35300
	6.7L Super Duty Pickups from 2010 to current (F-250 & F-350), Medium duty trucks (F-450 & F-550)	Glow Plug	8mm-1.00	35740	 35350
Ford Tractor	All	Fuel Injector	N/A	34800	 35400
General Motors	4.3L & 5.7L	Glow Plug	10mm-1.00	34730	 35450
	4.3L, 5.7L & 6.2L & 6.5L Turbo	Glow Plug	10mm-1.00	35000	
	Duramax 6.6L (2001-2005)	Glow Plug	10mm-1.25	35550	 35500
	6.2L & 6.5L V8 True Diesel (1982 - 2002)	Glow Plug	10mm-1.00	35670	
	Duramax 6.6L (2005 and up)	Glow Plug	10mm-1.25	35660	 35550
	Duramax ID415	17mm Injector	N/A	35700	 35600
Hatz	Some models	17mm Injector	N/A	35700	 35650
Hummer H1	Optimizer 6500 V8 Turbo (1992 - 2004) & 6.2L V8	Glow Plug	10mm-1.00	35670	 35660
International Harvester	D/DT 361, D/DT 429, DV 462, DV/DVT 550, D/DT 407, DT/DVT 573	21mm Injector	N/A	34800 or 35680	 35670
Isuzu	1.8L & 2.2L	Glow Plug	10mm-1.25	34950	 35680
Jeep	Liberty 2.8L (2005)	Glow Plug	10mm-1.00	35670	 35690
Kubota	Various	Glow Plug	8mm-1.00	35500	
	Various	Glow Plug	10mm-1.25	35550	
	D722, D902, D950, D1105, V1505, V2203	Glow Plug	8mm-1.00	35720	35690
Lincoln Continental Mark VII	1984 & 1985 car models	Glow Plug	12mm-1.25	34880*	35690
Mack Truck	END 405, 457, 475, 510, 519, 605, 672, 673, 674, 711, 864 ENDT 673, 675, 676, 865, 866	Fuel Injector	N/A	34800	35670
Massey Ferguson	4.203, 4.236, 4.248, 6.354, 8.540	21mm Injector	N/A	35680	35680
Mercedes Benz	Cars & trucks with 24mm ports	Fuel Injector	24mm-2.00	34740	35690
	12mm is for Model 300 & 300 Turbo Diesel from 1978 and the 250 & 350 Turbo models. 18mm is for all regular Mercedes Benz engines & Model 300 prior to 1978.	Glow Plug	12mm-1.25 & 18mm-1.50 (Piggy-Back Style)	34780	35690
	2.7L	Glow Plug	10mm-1.00	35670	35690

Continued on Page 32

Continued from Page 31



35700



35710



35720



35730



35740

APPLICATION	ENGINE	TESTING PORT	THREAD	CAT. NO.
Mitsubishi	2 and 3 Cylinder	Glow Plug	10mm-1.25	35550
Mitsubishi-Fuso	Medium	21mm Injector	N/A	35680
Navistar	6.9L & 7.3L	Glow Plug	10mm-1.00	34730
	DT360, DT466, 9.0L, 312, 360, 414, 436 & 446 C.I.D.	Fuel Injector	N/A	35350
Navistar/ International	312, 360, 414, 436, 446, C.I.D. (1980's)	21mm Injector	N/A	35700
	7.6L DT466E (1994 - 2004), 8.7E DT530E	Injector	N/A	35710
Onan	DSL, MDSL	Fuel Injector	N/A	34800
Perkins	3.125, 4.203, 4.236, 4.248, 4.318, 6.354, 6.370, 8.540, 8.640, Phaser/1004, Phaser/1006	21mm Injector	N/A	35680
	1000 Series	21mm Injector	24mm-1.50	35730
Peugeot	For Peugeot diesel passenger cars having either 12mm-1.25 or glow plug 18mm-1.50 port holes	Glow Plug	12mm-1.25 & 18mm-1.50	34880* (Piggy-Back Style)
Scania	DN11, DS11	21mm Injector	N/A	35680
Sprinter (Mercedes/ Freightliner/ Dodge)	Inline 5 Cylinder 2.7L OM612/OM647 (2001-2006)	Glow Plug	10mm-1.00	35670
	V6 3.0L, OM642 (2006 to present)	Glow Plug	8mm-1.00	35740
Toyota	1.8L	Glow Plug	10mm-1.25	34950
	2.2L	Glow Plug	10mm-1.25	35550
Volkswagen	Older cars & trucks without TDI	Fuel Injector	24mm-2.00	34740
	TDI (ALH & BEW Series)	Glow Plug	10mm-1.00	35400
Volvo	All cars & trucks	Fuel Injector	24mm-2.00	34740
Volvo Penta	MD marine engines	17mm Injector	N/A	35690
Waukesha	180 DLC, 190 D, 195 D, 197 D	Fuel Injector	N/A	34800
	D155D	Fuel Injector	N/A	35300
Westerbeke	Marine engines	21mm Injector	N/A	35680
White Farm	66, 77, 88, 99, 166, 177, 188, 199, 550, 660, 770, 880, 950, 1550, 1555, 1600, 1650, 1655, 1750, 1755, 1800, D2000, 2300, 3000	21mm Injector	N/A	35680
Wisconsin	340, 350, 430, 660, 670, 750, 860, 1000	21mm Injector	N/A	35680
Yanmar	Some models	17mm Injector	N/A	35690

**DO YOU HAVE AN IDEA FOR A NEW TOOL?
IF SO, IT COULD BE WORTH EXTRA MONEY!**

CUT-OFF WHEELS

Abrasive reinforced wheels are ideal for automotive and autobody repair. Cut all ferrous materials with ease. Cut through clamps, hangars, sheet metal, angle iron, tubing, castings, mufflers and rusted bolts. Leaves clean edge. Easier and safer to control than a torch, faster and less effort than a hacksaw. Wheels comply with American National Standards Institute Code B7.1 (1968 Rev.) and OSHA. Rated at 25,000 RPM maximum speed. Pneumatic cutting tool should have safety guard. Always wear eye and face protection.



- 94860
- 94870
- 94890
- 94890P
- 94900
- 94930

CAT. NO.	OUTSIDE		CENTER HOLE		PACKAGING
	DIAMETER	THICKNESS	DIAMETER	HARDNESS	
94860	3"	1/16"	3/8"	X	5 per Card
94870	3"	1/16"	3/8"	X	50 per Box
94890	3"	1/16"	3/8"	X	100 per Box
94890P	3"	1/16"	3/8"	X	100 per Shelf Bin
94900	3"	1/32"	3/8"	T	5 per Card
94930	3"	1/32"	3/8"	T	100 per Box



FIVE 1/16" CUT-OFF WHEELS WITH ARBOR
FIVE 3/32" CUT-OFF WHEELS WITH ARBOR

A starter package of five 3" diameter Cut-Off Wheels and arbor (Cat. No. 94950).

CAT. NO.	CUT-OFF WHEEL THICKNESS	CENTER HOLE DIAMETER
94970	1/16"	3/8"
94980	1/32"	3/8"



- 94970
- 94980

CARDER

ARBOR FOR CUT-OFF WHEELS WITH
1/4" & 3/8" CENTER HOLES

94950 - Allows any die grinder or drill to be turned into a cut-off tool using either 1/4" or 3/8" I.D. Cut-Off Wheels. Cutting tools should have safety guard. Always wear eye and face protection.



- 94950

CARDER

RECIPROCATING AIR SAW BLADES



SCROLL



ALL PURPOSE

Use these high quality blades to cut through a variety of metals, fiberglass and plastic. Great for body work and exhaust work. These bi-metal blades contain cobalt for long lasting, shatterproof use. Fits Chicago Pneumatic, CIA, Florida Pneumatic, Ingersoll-Rand, Mac, Sears, Snap-on and any other air saw with dual set screw blade retention. Maximum speed is 10,000 strokes per minute. Always wear goggles when operating any air tool. Packed 5 blades per display pouch.

- 90000
- 90010
- 90020
- 90030
- 90040
- 90050
- 90060

CAT. NO.	BLADE LENGTH	TEETH PER INCH	BLADE TYPE	RECOMMENDED USE
90000	3"	18	Scroll	Fine cutting of material over 1/8" thick
90010	4"	18	All Purpose	General cutting of material over 1/8" thick
90020	3"	24	Scroll	Fine cutting of material 1/16" - 1/8" thick
90030	3"	32	Scroll	Fine cutting of material 1/16" and thinner
90040	4"	32	All Purpose	General cutting of material 1/16" and thinner
90050	Assortment - Contains one each of the 5 above blades			
90060	4"	24	All Purpose	Fine cutting of material 1/16" - 1/8" thick

DISPLAY POUCH



Our 24 tooth all purpose blade is the most popular pattern for general cutting requirements.

65130



TRUCK TIRE INFLATOR WITH DIAL GAGE

- Extra long reach 14" dual head chuck with internal lock on threads inflates in both straight and offset positions
- Easy to read, dual calibrated scales (0 - 160 PSI and 0 - 1100 kPa)
- Protective rubber boot surrounds dial gage
- Corrosion resistant brass pressure relief valve
- Ideal for use with heavy duty trucks, buses, RV's and motor homes
- 13" long hose with 360° swivel
- 1/4" Female NPT inlet

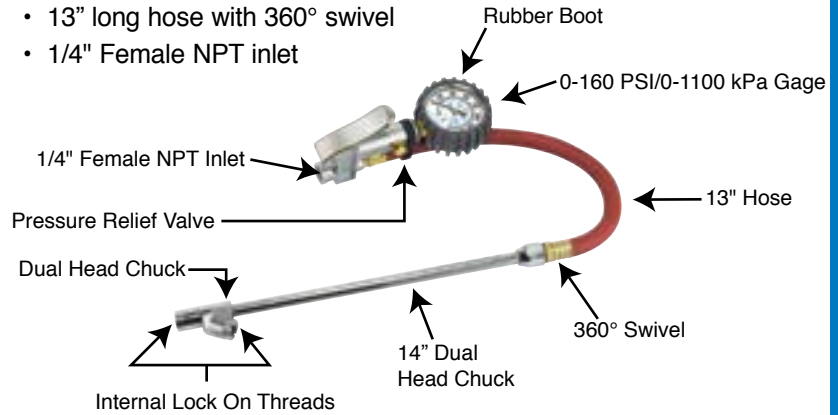

65110



TIRE INFLATOR WITH DIAL GAGE

- Easy to read, dual calibrated scales 0-120 PSI and 0-830 kPa
- 6" Dual head chuck
- Protective rubber boot surrounds dial gage
- Corrosion resistant brass pressure relief valve
- 13" Long hose with 360° swivel
- 1/4" Female NPT inlet

65120



TIRE INFLATOR WITH WINDOW GAGE

- Easy to read gage is calibrated from 10 – 120 PSI in 2 lb. increments
- Three function lever:
 - Inflates tire
 - Reads pressure
 - Releases air
- 6" Chrome plated dual head chuck
- Magnifying window lens
- 360° swivel between 15" air hose and 6" chrome plated dual head chuck
- Corrosion resistant brass valve
- Durable aluminum body construction
- 1/4" NPT Female air inlet

65100



TIRE INFLATOR WITH POP UP GAGE

- Easy to read nylon pop up gage measures from 10 to 120 PSI in 2 PSI increments
- Weatherproof body with corrosion resistant brass valve
- Chrome plated dual head chuck on 12" hose
- Hand lever control
- 1/4" NPT Female air inlet

TIRE TREAD DEPTH GAGE

65140

- Quickly and easily measures the remaining tread on a tire
- Use to detect unusual tire wear patterns
- Sliding gage measure in inches and millimeters (3 sides measures 0 - 1" in 1/32" increments and 3 sides measure 0 - 25mm in 1mm increments)
- Plated finish with handy pocket clip



TIRE VALVE CORE TOOL

65150

- Removes and installs tire valve cores
- Sure grip handle makes tool easy and comfortable to use
- Shaft extends 2" beyond handle
- 5½" overall length



“ZIPPIE” TIRE VALVE CORE REMOVER

65000

65000 - Slotted end for easy removal and quick replacement of tire valve cores. Tapered end has left hand threads to extract broken valve core.



MOLDED BACKING PAD

94790

Ideal for use on sanders, polishers and grinders requiring 5/8"- 11 threaded hole. Fully molded 7" diameter in a flexible construction. Pad is supplied with one 5/8"- 11 spindle nut.

CAT. NO.	MAX. RPM	APPLICATION	REPLACEMENT SPINDLE NUT PART NO.
94790	8,500	Use for grinding and sanding. Molded of polypropylene with ribbed center for higher speeds and extra strength.	94795



7" QUICK CHANGE BACKING PAD WITH HEX SPINDLE NUT

94820

94820 - Fits most vertical and angle polishers. Hex Spindle Nut specially designed to make installation and removal of Backing Pad fast and easy. Molded of flexible, durable rubber. 7" diameter pad supplied with 5/8"-11 hex spindle nut. Maximum speed 5,000 RPM. Replacement Spindle Nut Part No. 94823.



S & G TOOL AID'S OILERS GIVE POSITIVE PROTECTION TO EXPENSIVE PNEUMATIC TOOLS AND PUT AN END TO AIR LINE CONTAMINATION! PATENTED, DIRECT TO TOOL OILERS, END TOOL BURN OUT, STOP RUST AND INCREASE TORQUE

98500

THE OILER

Standard Model. High quality aircraft aluminum stem, precisely machined to 1/4" NPT. Oil reservoir is fabricated of high impact plastic. Technician always sees oil supply and oiling action. Holds three to four days supply of oil. With each use of the air tool, a fine mist of precisely metered oil enters the air stream. All internal moving parts are coated and lubricated. Use on all 3/8" and 1/2" air impact guns, air wrenches, body shop air tools and pneumatic hammers. 1/4" NPT Female inlet x 1/4" NPT Male outlet.

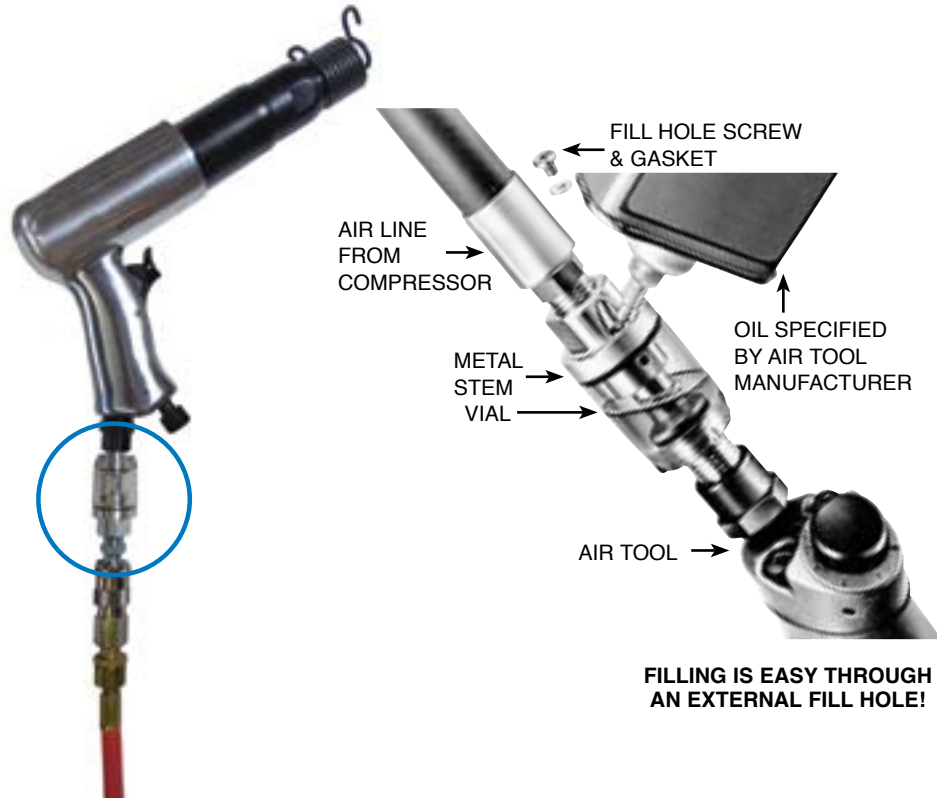

FILLING IS EASY THROUGH AN EXTERNAL FILL HOLE!

98700 98800

3/8" NPT LARGE OILER

98700 - A larger 3/8" NPT Oiler designed for use with 3/4" and 1" drive pneumatic tools. Will hold more than a week's supply of oil under average use. Same high quality construction and features as the Standard Oiler. Easily refilled through vented holes located on flange. Can be used in direct hook-up to tool or with whip hose. 3/8" NPT Female inlet x 3/8" NPT Male outlet.

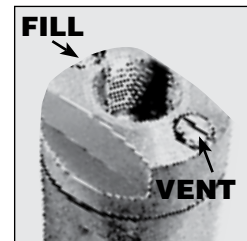
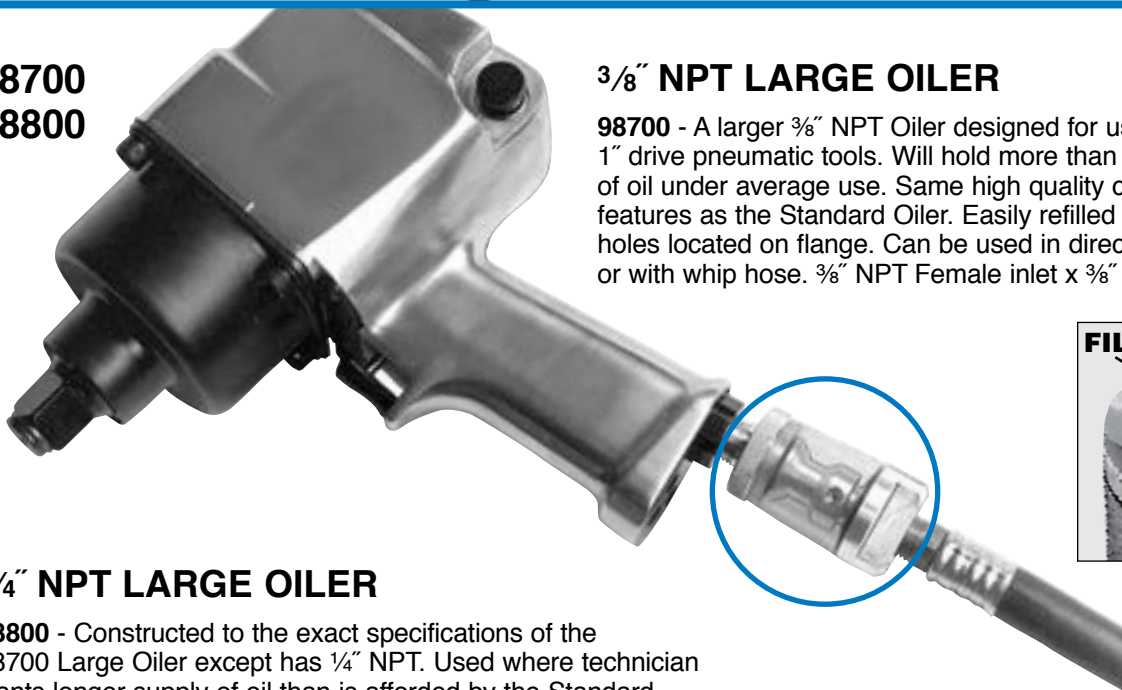

1/4" NPT LARGE OILER

98800 - Constructed to the exact specifications of the 98700 Large Oiler except has 1/4" NPT. Used where technician wants longer supply of oil than is afforded by the Standard Oiler. 1/4" NPT Female inlet x 1/4" NPT Male outlet.

DIAPHRAGM AIR REGULATOR

98350

- For precise air regulation at the spray gun.
- Delivers constant pressure.
- For use with all spray guns - conventional and HVLP.
- Small, lightweight and compact.
- Inlet: 1/4" NPT Male; Outlet: 1/4" NPT Female with swivel connector.
- 22 CFM capacity.
- True diaphragm regulator to prevent surges - not a cheater valve.
- Push/Pull lock to set pressure.
- Gage ranges: 0-160 PSI and 0-11 BAR.
- Glass lens.



CARDED

IN-LINE WATER SEPARATOR AND AIR FILTER

99000

99000 - Removes water and foreign particles from compressed air stream. Attaches directly to paint spray gun or air tool. Clear reservoir shows accumulated water taken out of air line. Button release valve allows for easy disposal. Filter can be removed and cleaned periodically. 1/4" NPT Male inlet x 1/4" NPT Female outlet.



CARDED

AIR ADJUSTMENT VALVE FOR PAINT SPRAYING

98300

98300 - Allows for fine regulation of air entering spray gun. Approximately 2 1/2 turns from fully opened to closed valve. Gage has dual scales - 160 PSI and 11 Kg/Cm². Inlet is 1/4" NPT Male. Outlet is 1/4" NPT Female and swivels.



CARDED

HOLDING PADS WITH FOUR SURFACE TREATMENT DISCS

94540

94560

- Use to clean and prep surfaces.
- Discs install and remove easily with a quick twisting action.
- Flexible, flanged rubber backer pad connects to 1/4" steel shaft.
- For use with air and electric tools.

CAT. NO.	SIZE	MAX. RPM	INCLUDES		
			HOLDING PAD	MEDIUM DISCS	COARSE DISCS
94540	2"	30,000	94520	2	2
94560	3"	20,000	94530	2	2



CARDED

Always wear eye, respiratory and face protection when using these products.

HOLDING PADS FOR SURFACE TREATMENT DISCS

94520

94530

- Holds the discs used for prepping surfaces.
- Discs install and remove easily with a quick twisting action.
- Flexible, flanged rubber backer pad connects to 1/4" steel shaft.
- For use with air and electric tools.
- Holding Pad can be used with most brands of surface treatment pads.

CAT. NO.	SIZE	MAX. RPM
94520	2"	30,000
94530	3"	20,000



DISPLAY PACKAGED

Always wear eye, respiratory and face protection when using these products.

99220
99230
99240



CARDED

99240 99230 99220

CAT. NO.	DESCRIPTION
99220	Turbo Blaster Blow Gun
99230	6" Turbo Blaster Blow Gun
99240	12" Turbo Blaster Blow Gun

TURBO BLASTER BLOW GUNS

- Quickly and effectively provides a high volume of air flow
- Ideal for cleaning applications
- Special nozzle uses side ports to increase air flow
- Ergonomically designed for better comfort & air control
- High impact, insulated plastic handle has hang up slot
- Satisfies OSHA standards
- Lightweight and lever action

Description	99220	99230	99240
Working Pressure	90 -120 PSI	90 -120 PSI	90 -120 PSI
Maximum Pressure	150 PSI	150 PSI	150 PSI
Sound Level	90.2 dBA	85.0 dBA	85.0 dBA
Outflow (@ 90 PSI)	16.5 CFM	16.1 CFM	16.1 CFM
Temperature Range	-4° - 158° F	-4° - 158° F	-4° - 158° F
Air Inlet, Brass (Female)	1/4" NPT	1/4" NPT	1/4" NPT

Satisfies OSHA requirements of special relief hole in nozzle which limits pressure to 30 PSI when dead ended in an air line with 150 PSI or less.
U.S. Patent Nos. 6,213,411 & D542,379 S

99500
99510
99520

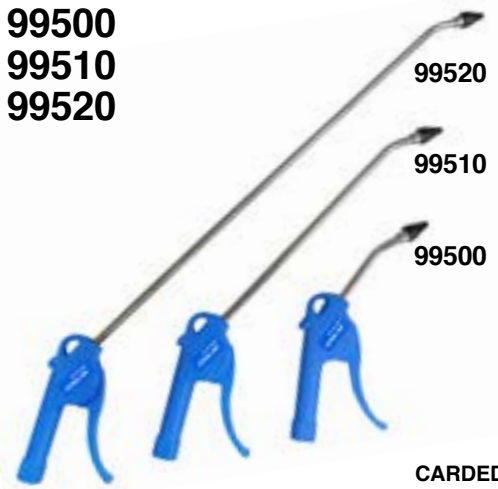

CARDED

LONG REACH ANGLED NOZZLE BLOW GUNS

- Specially designed angled nozzle accesses hard to reach places
- Ideal for cleaning applications
- Ergonomically designed for better comfort & air control
- High impact, insulated plastic handle has hang up slot
- Lightweight and lever action
- Rubber Nozzle prevents surface damage

Specifications:

- 85 - 125 PSI operating range
- -20° to 160° F (-29° to 71° C) temperature range
- Air consumption 9.8 CFM at 90 PSI using 1/4" hose
- 1/4" NPT Female brass air inlet

CAT. NO.	DESCRIPTION
99500	4-1/2" Long Reach Angled Nozzle Blow Gun
99510	10" Long Reach Angled Nozzle Blow Gun
99520	20" Long Reach Angled Nozzle Blow Gun

99210



CARDED

U.S. Patent No. 6,213,411

BLOW GUN & TIRE INFLATOR COMBINATION

- 2 in 1 blow gun
- Specially designed combination safety nozzle for tire inflation and general purpose air blowing
- High impact, plastic handle with hang up hooks
- Lever action
- Lightweight
- Specifications:
 - 90-120 PSI operating range
 - Air consumption at 90 PSI using 1/4" hose is 13 CFM and using 3/8" hose is 15 CFM
 - 1/4" NPT female brass air inlet
- To use as a tire inflator, a minimum of 90 PSI is required

94600



AIR POWERED CLEANING GUN

94600 - Powerful general purpose cleaning gun for shop and garage. Cleans machinery, engines, parts, floors and more. Use with detergent, solvent, kerosene or water. Adjusting control regulates amount of cleaning agent to be mixed with compressed air. Clear siphon tubing is 7 feet long with filter on end. Gun is 17" long - can clean hard to reach places. Weighs only 12 ounces. Air consumption is 5 CFM @ 90 PSI. Recommended operating pressure is 70-90 PSI. Maximum 90 PSI. 1/4" NPT Female air inlet. Instructions are included.

LEVER ACTION BLOW GUN WITH 5 NOZZLES

99150 - This kit includes a blow gun with 5 of the most popular interchangeable nozzles. The blow gun has a convenient hang up hook and is activated by smooth lever action. Use for blowing out tubes and pipes or directing a fine stream of air. A versatile kit for cleaning applications. Rubber tip provides a leak free seal and will not mar painted surfaces. Tapered nozzles concentrate air and permit access to confined areas. Chrome plated. Lever is vinyl covered for comfort and easy gripping. 1/4" NPT Female inlet.



LEVER ACTION BLOW GUN WITH A METAL AND A RUBBER NOZZLE

99100 - Smooth lever action design with hang up hook. Kit includes two interchangeable nozzles – one tapered and one rubber. Tapered nozzle directs fine stream of air. Rubber nozzle provides leak proof seal for blowing out tubes and pipes and will not mar painted surfaces. Excellent value for cleaning and drying surfaces. Chrome plated. Lever is vinyl covered for comfort and easy gripping. 1/4" NPT Female inlet.



IN-LINE BLOW GUNS

These ingenious In-Line Blow Guns are always there, ready to use. No need to keep on disconnecting an air tool to hook up a blow gun. Never gets lost or misplaced. Small, compact and easy to use. Fits permanently between air hose and coupler. Air stream nozzle has a natural angle for easy use. Lightweight and durable. Available with OSHA or rubber nozzle. 1/4" NPT Female x 1/4" NPT Female.

99180

99190



CAT. NO.	DESCRIPTION	APPLICATION INFORMATION
99180	In-Line Blow Gun with OSHA Nozzle	Meets OSHA requirements of special relief hole in nozzle which limits pressure to 30 PSI when dead ended in an air line with 150 PSI or less.
99190	In-Line Blow Gun with Rubber Tip	Has non-marring rubber tip. Can be used to make a tight seal for blowing out air lines. To meet OSHA requirements, air line pressure must be reduced to 30 PSI.



CARDED

92500



FOUR PIECE BODY SHOP CHISEL PAK

The most widely used pneumatic tool aids. Handy roll pack contains one each 91250 Claw Ripper, 91350 Double Panel Cutter, 91400 7" Chisel and 91600 #1 Body Man Cutter.

92600



FOUR PIECE FRONT END PNEUMATIC TOOL AID PAK

The essentials only. Contains one each of 91000 Tie Rod Tool, 91100 Bushing Remover, 91450 Tapered Punch and a 91400 7" Chisel. Supplied in handy roll pack.

92700



FOUR PIECE MUFFLER/TAI PIPE PNEUMATIC TOOL PAK

Roll Pak contains one each of 91050 Tail Pipe Cut-Off Tool, 91750 Inside/Outside Muffler Cutter, 91300 Muffler Cut-Off Tool and a 91400 7" Chisel.

92500
92600
92700

A QUALITY LINE OF HEAVY DUTY .401" PARKER SHANK TOOLS FOR BODY SHOP, FRONT END, AND MUFFLER/TAIL PIPE WORK

91125



BODY SHOP TOOLS

PNEUMATIC SMOOTHING HAMMERS

Designed for numerous automotive jobs. Use for body forming on fenders, hoods and panels against a body dolly. Excellent for any hammering operations such as ball joints and U-joints. Polished face is 1" diameter. Cat. No. 91140 has 7" overall length to access hard to reach areas.

91140



91150



WIDE CHISEL & SCRAPER

Special 1 1/8" blade for scraping and cutting in body shop work.

91250



CLAW RIPPER

Slotted for smooth edge panel cutting and ripping.

91350



DOUBLE EDGE CUTTER TOOL

Fast clean edge panel cutter **MILL EDGED** not just forged.

91500



RIVET BUSTER

Shears bolts and rivets. Cut bolts in body and machine shop.

91550



"V"SPOT WELD BREAKER

Vee slotted. Best for cutting welded spots. Doubles as rivet and moulding cutter.

91600



BODY MAN #1 CUTTER

The fastest panel cutter available. Cuts down time. Leaves cleanest edge possible. A body shop must.

91625



PNEUMATIC PANEL CRIMPER

For patching sheet metal panels uniformly and quickly. Forms a step around the area to be repaired. Patch is placed on flange of step, flush with original panel surface. Full grip handle provided for safety. A necessary tool for the professional body technician. 7" overall length.

FRONT END TOOLS

91000



TIE ROD TOOL

Break sleeve rust and corrosion on tie rod work.

91025



TIE ROD SEPARATOR TOOL

Made from a single piece of drop forged alloy steel. Jaw opening between tapered prongs is 2 1/32".

91100



BUSHING REMOVER

Especially designed to remove bushing in control arm work.

91200



BUSHING SPLITTER

For cutting idler arm bushing.

91450



TAPERED PUNCH

Drives out pins and rivets.

91700



BALL JOINT SEPARATOR

Designed to separate ball joints with reduced shock to assembly. Wedge opening 1 5/16".

MUFFLER AND TAIL PIPE TOOLS

TAIL PIPE CUTTER

For all pipe cutting.

CARDED



91050

MUFFLER AND TAIL PIPE CUTTER

Milled cutting edge yields better shear. Eliminates damage to inner section of muffler.

CARDED



91300

INSIDE MUFFLER CUTTER

Designed edges to fit inside of muffler. Convex cutter edge.

CARDED



91800

OUTSIDE MUFFLER CUTTER

Concave cutting edge for the outside muffler job.

CARDED



91850

GENERAL PURPOSE TOOLS AND ACCESSORIES

7" FLAT CHISEL

The Do-It-All Cutter for every technician.

CARDED



91400

EXTRA LONG FLAT CHISEL

A necessity for those hard to reach places in today's vehicles. Cuts nuts, bolts and frame members with ease. Forged to an overall length of 10½".

CARDED



91900

3/4" PNEUMATIC COLD CHISEL x 18" LONG

Extra long for hard to reach areas. Designed to cut nuts, bolts, exhaust brackets, angles and frame members.

DETAIL



91975

THE SCRAPE-IT

A special wide blade scraper for sludge, undercoat, paint and gaskets.

CARDED



91650

2" WIDE PNEUMATIC SCRAPER

Removes gaskets, rust, undercoating and paint. Blade has slight offset for easy use.

CARDED











91950

ALWAYS WEAR EYE AND FACE PROTECTION WHEN USING THESE PRODUCTS

ECONOMY CHISELS

Excellent Quality, Popularly Priced!

A great combination of the chisels most often used by automotive and autobody technicians. Made to exacting Tool Aid standards from alloy steel with .401" Parker shanks and covered by our "no questions asked" warranty. Packaged in see-through vinyl pouches. Priced to sell!

- 51150  WIDE CHISEL AND SCRAPER
- 51250  CLAW RIPPER (PANEL EDGER)
- 51350  DOUBLE EDGE PANEL CUTTER
- 51400  7" FLAT CHISEL
- 51450  TAPERED PUNCH
- 51500  RIVET CUTTER
- 51550  SPOT WELD BREAKER
- 51600  SINGLE EDGE CUTTER

52000

ECONOMY CHISEL COMBINATION PAK

52000 - Contains 8 of the most widely used pneumatic chisels for automotive and autobody repair. Each chisel made from alloy steel with .401" Parker shanks and covered by our "no questions asked" warranty. Packed in a durable vinyl pouch which can be hung up or rolled up and tied for storage in a tool box. Contains the following chisels:



CAT. NO.	DESCRIPTION
51150	Wide Chisel and Scraper
51250	Claw Ripper (Panel Edger)
51350	Double Edge Panel Cutter
51400	7" Flat Chisel
51450	Tapered Punch
51500	Rivet Cutter
51550	Spot Weld Breaker
51600	Single Edge Cutter

.498" PARKER SHANK PNEUMATIC TOOLS

Tool Aid presents a selection of the most popular pneumatic tools with .498" Parker Shanks. These quality, heavy duty tools are growing in use with volume shops, fleets, truck body rebuilders, front end shops, salvage and wrecking yards, and heavy-duty spring shops.

7" FLAT CHISEL



92100

RIVET AND BOLT CUTTER



92125

1 1/4" SMOOTHING HAMMER



92150

WIDE CUTTING CHISEL & SCRAPER



92175

BUSHING SPLITTER



92225

DOUBLE BLADE PANEL CUTTER



92250

STRAIGHT PUNCH



92300

TAPERED PUNCH



92325

UNIVERSAL JOINT AND TIE ROD TOOL



92350

94000



CARDED

QUICK CHANGE SPRING

94000 - Retains chisels with .401" shanks. Chisels can be installed and removed quickly. For the busy technician.

94100



CARDED

RETAIN-IT, CHISEL RETAINER

94100 - This is the best chisel retainer available. Two piece safety device for air hammers. Collar fits against stop on .401" chisel shanks for 100% contact. Heavy duty steel spring has remover lever. Two parts are available separately – Collar, Cat. No. 94200 and Spring, Cat. No. 94300.

94400



CARDED

QUICK CHANGE CHISEL RETAINER

94400 - Securely holds .401" shank chisels. Fits most popular air hammers. Safe to use, fast to change chisels. Just pull back collar to install or remove chisels. Retainer becomes part of tool eliminating need for other retainers.

94450



CARDED

QUICK CHANGE CHISEL RETAINER FOR IR 121, 132 & 772

- Securely holds .401" Parker shank chisels on IR 121, 132 & 772 Air Hammers
- Safe to use, fast to change chisels
- Just pull back collar to install and remove chisel
- Retainer becomes part of tool eliminating need for other retainers

94500



CARDED

SAFETY CHUCK CHISEL HOLDER

94500 - Retains .401" shank chisels firmly in place. Chisels can be changed quickly and easily...fits most popular hammers.

98000

98025



CARDED

AIR REGULATORS

Control air pressure as needed. Designed with four position on-off detent stops. Openings: 1/4" NPT Male x 1/4" NPT Female. Not a shut-off valve.

CAT. NO.	MATERIAL	FEATURE
98000	Aluminum	Lightweight
98025	Brass	Resists oxidation

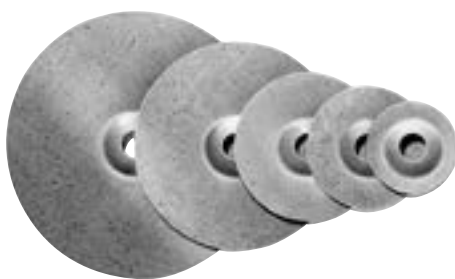

PHENOLIC BACKING DISCS

A complete size range of phenolic reinforced backing plates for sanding and grinding work. These discs are designed to be lightweight and provide desired flexibility for sanding. If additional rigidity is required, combine 2 or 3 together. Each plate has the same molded depressed center contour and

CAT. NO.	DIAMETER	MAX. RPM
94700	3"	25,000
94710	4"	25,000
94720	5"	20,000
94730	7"	15,000
94740	9"	15,000

3 together. Each plate has the same molded depressed center contour and 7/8" I.D. hole. Always wear safety eye and face protection for this type of work.

94750

94760



CARDED

PHENOLIC BACKING DISC COMBINATION PACKS

Different size combinations of phenolic reinforced backing plates for sanding and grinding work. Both sets are skin packaged for display. Each disc has the same molded depressed center contour and 7/8" I.D. hole. Always wear safety goggles for this type of work.

94750 - 3", 4" and 5" disc pack

94760 - 4", 5" and 7" disc pack

10 LB. SLIDE HAMMER & PULLERS FOR FRONT WHEEL HUBS AND REAR AXLES

66370

- Heavy duty 10 lb. Slide Hammer on Steel Shaft reduces effort, time and labor to make a tough job easy
- Pullers fit 4, 5 and 6 bolt patterns for use on most domestic and imported cars and light trucks
- Easily removes front wheel hubs and flange type rear axles
- Axle and Hub Pulling Adapter accepts other 5/8"-18 female threaded pulling attachments
- Components include our Cat. Nos.: 66320, Axle & Hub Pulling Adapter; 66330, Rear Axle Pulling Yoke; 66350, Front Wheel Hub Puller; 81001, Slide Hammer; 81002, Slide Shaft and 81007, Hand Grip
- Includes Forcing Screw and Hex Nut



FRONT WHEEL HUB PULLER FOR SMALL TO MIDSIZE LUG PATTERNS

66350

- Separates the front hub from the axle on front wheel drive cars
- Can be used with any slide hammer having a 5/8"-18 male thread or the included 5/8"-18 x 5 1/2" long Forcing Screw
- Hex Nut makes using with a standard slide hammer easy



FRONT WHEEL HUB PULLER FOR SMALL TO MIDSIZE LUG PATTERNS & 10 LB. SLIDE HAMMER

66360

- Use to separate the front hub from the axle on front wheel drive cars
- 10 lb. Slide Hammer on steel shaft
- Easy to use - just attach yoke to studs, then slide the hammer against end of shaft
- Vinyl hand grip for positive grip and shock cushioning
- Includes Forcing Screw and Hex Nut
- Slide Hammer specially designed for in-line impact and continued use without fatigue



PULLING YOKE

66330

66330 - Use with slide hammer to remove rear axles on popular cars and most trucks with flange type axles. The bolt circle range is 4 1/2" to 5 1/2". Slots permit use on axles with 4, 5 or 6 studs in the circle. Supplied with 5/8"-18 lock nut.



SLIDE HAMMER AXLE & HUB PULLER WITH YOKE

66340

66340 - Combination 10 lb. Slide Hammer and Hub Puller makes removing axles and hubs easy. Comes complete with flanged Pulling Yoke. Use to remove front and rear wheel drive axles. Can be used to remove flange type rear axles. The extra heavy 10 lb. weight reduces time and labor to make tough jobs easy. Vinyl handle provides for positive grip and shock cushioning. Slide weight specially designed for in-line impact and continued use without fatigue.



AXLE & HUB PULLER ADAPTER

66320

66320 - Convert your Cat. Nos. 80000, 81000 & 81100 to a Slide Hammer Axle & Hub Puller. Adapter accepts 5/8" - 18 female threaded pulling attachments. Thread onto Slugger shaft or any shaft having a 3/4" NPSM thread to pull axles and hubs with ease. Solid steel construction. This is same adapter supplied with Cat. No. 66340, 66360 and 66370. Replaceable bolt, nut and lock washer.



SLIDE HAMMER AXLE & HUB PULLER

66300

66300 - Same as our Cat. No. 66340 without Pulling Yoke.



62900



CARDED

"THE STRUTTER"[®], MacPHERSON STRUT COIL SPRING TOOL

Every shop, no matter how small, can do work on the MacPherson Strut assembly found on virtually all modern domestic and imported vehicles.

The S & G 62900 "Strutter" can be:

- Used with impact wrench or hand tool.
- Used ON or OFF the car!
- Sells for a fraction of other types.

Each set contains complete instructions and a safety kit. The one piece cold headed bolts are made of chromium-molybdenum alloy steel. The nuts are Grade 5.

Do not use on General Motors "A", "C", "J" or "X" Body cars.

Not for use on any unusually large MacPherson Strut springs which have a coil outside diameter of over 6" or a wire diameter larger than 5/8".

63000



**WITH
ACME
THREADS**

Easy to use
in 3 steps:

"THE STRUTTER"[®] 2, MacPHERSON STRUT COIL SPRING TOOL WITH ACME THREADS

- Now with acme threads and economically priced.
- Quickly and easily work on the MacPherson Struts found on virtually all modern domestic and imported vehicles.
- Features a one piece cold headed bolt made of chromium molybdenum alloy steel. The nuts are Grade 5.
- Use with impact wrench or hand tool ON or OFF the car.
- Contains complete instructions and safety kit.

Not for use on any unusually large MacPherson Strut springs which have a coil outside diameter of over 6" or a wire diameter larger than 5/8". Do not use on General Motors "A", "C", "J" or "X" Body cars.



1. Attach clamps to spring



2. Compress and remove cartridge



3. Complete repair or replacement

61800



STRUT ALIGNMENT LEVEL

Use this simple level to restore a vehicle's camber setting after strut repair or installation. Allows technician or customer to safely drive the vehicle before a more precise wheel alignment can be performed. More accurate than other methods. Also useful for repairs on CV joints, ball joints and tie rod ends.

Features include:

- Super strong magnet - mounts on brake rotor, spindle or steering knuckle.
- Easy to read, unbreakable bubble level.
- Camber settings from -3° to +3° for additional adjustment.
- Works on all vehicles equipped with MacPherson struts.
- Can remain on the vehicle during repair, or can be removed.
- Easy to use – 1. Simply place on rotor before repair and zero the level.
2. Tighten the wing nut. 3. After the repair, push or pull on the strut until the level returns to the zero position.

CARDED

61900



TIE ROD END / BALL JOINT LIFTER

This labor saving tool quickly separates tie rod ends and ball joints from suspension components. Eliminates broken grease reservoirs. No need for excessive hammering. Powerful lever action breaks loose even the most stubborn joints. Works on virtually all tie rod ends and compact car ball joints. Heavy duty, all metal construction. For use with hand tools only. Instructions included.

SINGLE ACTION COIL SPRING COMPRESSOR

62200 - Remove, install and compress coil springs that can be reached through the center of the coil. Smooth bearing action and finest quality heat treated steel makes for safe, quick compression. Single turning action on central shaft. Fit tool inside spring. Use with a hand operated ratchet wrench to pull arms closer together. A front end shop must!!!

SINGLE ACTION COIL SPRING COMPRESSOR FOR COMPACT AND SUB COMPACT VEHICLES

62400 - Similar in design to our longer Cat. No. 62200, but with shorter shaft for easy clearance on small cars.

SINGLE ACTION COIL SPRING COMPRESSOR KIT

62500 - Kit combines capabilities of Cat. Nos. 62200 and 62400 at almost half their combined price! Handles standard, compact and sub compact vehicles. Consists of standard Single Action tool plus shorter shaft for smaller vehicles.



ALL WITH ACME THREADS
62200 **62400** **62500**
 CARDED

NOTE: These tools should not be used on unusually large coil springs which have a coil outside diameter larger than 5 1/2" or a wire diameter exceeding 3/4".

COIL SPRING "CLAMP-IT" SET

62000 - The original tool for compressing coil springs on standard and compact vehicles. Consists of three hook/bolt assemblies which are applied to the outside of the coil spring. Can be used to compress spring into straight or slightly curved configuration as required. Allows for easy removal or installation where spring compression cannot be performed from inside the coil. Proper use of this set eliminates bulge or slip. Supplied with safety kit and illustrated instructions.



62000

STEERING WHEEL HOLDER AND PEDAL DEPRESSOR

- Holds the steering wheel, brake pedal, accelerator or clutch pedal in a desired position.
- Saves time and money by eliminating the need for two technicians to do one job.
- Easy to assemble, install and release – components slide into position.
- Fine adjustments can be made by using the hex adjuster.
- Locks in place by putting pressure against the seat.
- Virtually 100% coverage to fit all cars and trucks either between seat and steering wheel, or seat and pedal.
- Coated to prevent slipping and marring.
- Packaged in a blow-molded plastic case with a colorful point-of-purchase sleeve.
- Complete instructions included.



66400

APPLICATIONS	
<p>AS A STEERING WHEEL HOLDER, USE TO:</p> <ul style="list-style-type: none"> • Securely hold the steering wheel for toe-in/toe-out work • Center the steering wheel 	<p>AS A PEDAL DEPRESSOR, USE FOR:</p> <ul style="list-style-type: none"> • Tune-ups • Brake jobs • Fuel Injection cleaning • Alternator testing • Clutch work • Engine diagnosis • Setting RPM • Air conditioning work • Cylinder balance tests

U.S. Patent No. 6,607,180



66000



MAGNETIC CASTER/CAMBER GAGE

66000 - Quickly determine causes of erratic steering and excessive tire wear without tying up valuable floor space and working capital. Use this magnetic gage on all vehicles to check caster and camber in 5 minutes on a rack, pit or as a portable floor unit. Easy to use—direct reading—no special schooling required, no calculations necessary. Equipment requires no extra space. The low cost can be amortized quickly and yield profitable results immediately.

Multi pole Alnico Magnet has built in cutter teeth to remove burrs on wheel hub surface. Precision gage has level vials which are internally ground with evenly spaced permanent markings. Provides micrometer accuracy. Vials are recessed for protection. Gage is equipped with spring loaded centering plunger to pinpoint center of wheel. Readings are not affected by wheel runout, uneven rims or tire bulges. Supplied with full instructions. Packed in permanent protective metal storage box.

FUNCTION	SCALE RANGE
Camber	+8° to -8°, Numerically by degrees and in increments of 1/2°
Caster	+14° to -6°, Numerically by degrees and in increments of 1/2°
Kingpin	+20° to -20°, Numerically by degrees and in increments of 1/2°

66160



MAGNETIC TRANSFER ADAPTER

66160 - Use in conjunction with our Cat. No. 66000, Magnetic Caster/Camber Gage. This adapter is designed to fit on many vehicles, including General Motors A, J and X Body cars, Chrysler K Bodies and all Ford vehicles with standard wheels. Eliminates the need to remove the spindle nut. The adapter is placed over the spindle nut making direct contact with the hub. Adheres to the hub magnetically when the Caster/Camber Gage is applied.

66170



NO MAR RIM ADAPTER FOR MAGNETIC CASTER/CAMBER GAGE

66170 - Designed to fit onto wheels that have wheel hubs which are difficult to engage. Will not mar mags, aluminum or custom wheels. Adapter is attached to the outside of the wheel felloe eliminating any possible damage.

66180



LARGE WHEEL NO MAR RIM ADAPTER FOR MAGNETIC CASTER/CAMBER GAGE

- Designed for large wheels with 20" to 28" rims that have wheel hubs difficult to engage
- Makes it quick and easy to use a magnetic gage on truck aluminum or custom wheels
- Will not mar aluminum or custom wheels
- Adapter is attached to the outside of the wheel felloe eliminating any possible damage
- For use with our Cat. No. 66000, Magnetic Caster/Camber Gage

66200



WHEEL ALIGNMENT TURNTABLES (SET OF TWO)

66200 - A companion aid to Cat. No. 66000. Engineered for modern cars and light trucks. Designed to handle all types of tires. Provides full 100° caster swing. Designed to be used as portable floor units or on stands, racks or pits. These turntables indicate accurate toe-out on turn angle of each wheel allowing the bottom of the wheel to turn freely while alignment adjustments are made. Use for caster and steering axis inclination measurement. Large dials are easily read from any angle and can be adjusted to zero starting position at any time. Ball bearings are enclosed in precision ground surfaces to simulate actual road conditions and allow for freedom of movement in all directions. Tapered pins hold plates firmly locked while vehicle is being driven onto turntable. Pins are attached with chain to prevent loss. Jacks are not necessary as turntables have non-skid design to minimize sliding. Supports 5,000 lbs. per wheel. Top plate motion is 3". Sold as set of two units. Shipping weight is 63 lbs. per pair. Dimensions 11" x 15" x 2".

61500 61600



DUBY WHEEL ALIGNING GAGES

Instant and direct "toe-in, toe-out" reading for all vehicles. Inexpensive and easy to use. Simple instructions have metric conversion scale if required. Available in two sizes:

CAT NO.	APPLICATION	OPERATIONAL WIDTH RANGE
61500	Standard cars, trucks & buses	46" - 74"
61600	Standard & compact cars, light trucks	39" - 60"

HOSE CLAMP PIMPS PLIERS SET

19780

- Use to clamp fuel injection, brake, vacuum and cooling systems hoses
- Includes one each small, medium and large Hose Clamp Pliers in high visibility orange
- Smooth, rounded jaws prevent hose damage
- Lightweight and non-metallic
- Locks in closed position
- Fast and easy to use

Hose Clamp Pliers are available individually bulk packed:

CAT. NO.	DESCRIPTION	RANGE
19790	Small Hose Clamp Pliers	1/8" – 3/8"
19791	Medium Hose Clamp Pliers	1/2" – 7/8"
19792	Large Hose Clamp Pliers	3/4" – 2 1/4"



CARDED

HOSE CLAMP PLIERS SET

19750

- One cross slotted jaw pliers and one wide flat band hose clamp pliers.
- For most ring type and flat band type hose clamps.
- Jaws rotate to access hose clamps from any angle and to provide better gripping action.
- Ratcheting locking mechanism holds clamps in open position for easy removal and installation.
- Steel construction with handle grips.



CARDED

SEAL PULLER

31800

- Use to remove oil and grease seals on cars, SUV's and light trucks.
- Has 2 sizes of hook tips to fit most applications.
- Just insert the tip of the hook behind the seal and use leverage to remove.
- Heat treated, black oxide tips and chrome plated shaft.

Replacement Hook Part No. 31802



CARDED

IMPACT DRIVER SET

14950

- Use to loosen and tighten screws, nuts and bolts.
- Includes 3/8" square x 5/16" hex bit holder.
- Driver is easily reversible for tightening applications.
- Special handle reduces risk of injury when striking driver with hammer.
- Set includes eight standard and long length interchangeable bits:
 - #2 Phillips, 1 3/8" long 5/16" hex bit
 - #3 Phillips, 1 3/8" long 5/16" hex bit
 - 5/16" Slotted, 1 3/8" long 5/16" hex bit
 - 3/8" Slotted, 1 3/8" long 5/16" hex bit
 - #2 Phillips, 3 1/8" long 5/16" hex bit
 - #3 Phillips, 3 1/8" long 5/16" hex bit
 - 5/16" Slotted, 3 1/8" long 5/16" hex bit
 - 3/8" Slotted, 3 1/8" long 5/16" hex bit



PACKAGED IN CLAMSHELL

EXTRA LONG STICKER SCRAPER

87965

87965 - Specially designed to access steep, sloping windshields and other hard-to-reach places. Excellent for corners and on curved surfaces. Supplied with 5 standard steel razor blades and 1 plastic blade. Use the plastic blade on laminated windows and plastic bumpers. The blade in the holder can be reversed for storage. The other blades store in the handle. Heavy duty construction. 16" overall length.



CARDED

3 POSITION INSPECTION STICKER SCRAPER

87940

87940 - General purpose windshield and window scraper uses single edge razor blade. Can be used in three different lock positions to aid in cleaning windshields at corners and on curved surfaces. Blade section folds into handle and locks for safe storage. Supplied with blade.

Replacement Blade Part No. 87960.



CARDED

100 SINGLE EDGE RAZOR BLADES

87960

87960 - Durable razor blades for industrial use far surpass shaving blade quality. Keep handy for automotive and autobody application. Packed 100 per box.



14270



3 PIECE BRASS DRIFT PIN SET

- Contains 3 sizes of drift pin style brass punches 1/2" x 7", 5/8" x 7" and 3/4" x 8"
- Softer brass will not mar harder metal surfaces
- Non-sparking
- Knurled handles for better gripping
- Supplied in a durable, vinyl pouch.

Always wear eye and face protection when using this product.

14290



4 PIECE BRASS PIN PUNCH SET

- Contains 4 sizes of drift pin style brass punches 1/8" x 4", 3/16" x 4", 1/4" x 4" & 3/8" x 6"
- Softer brass will not mar harder metal surfaces
- Non-sparking
- Knurled handles for better gripping
- Supplied in a durable, vinyl pouch

Always wear eye and face protection when using this product.

14300



CARDED

MIGHTY CUTTER

14300 - Use in automotive, autobody, marine and aviation shops. Makes accurate, straight cuts with clean edges on rubber or plastic hose, PVC pipe and certain types of wire and wire cable. Easily handles up to 1 1/8" O.D. material. Tempered steel blade will cut:

- Heater hose
 - Fuel line hose
 - Air conditioning hose
 - Braided brake hose
 - Copper tractor trailer cable
 - Plastic side body molding trim
 - 12 Volt battery cable
- Replacement Blade Part No. 14303

18500



SPARK PLUG CLEANER

18500 - Cleans any size spark plug quickly and effortlessly with internally controlled abrasive blasting. Uses ordinary air line pressure. Compressed air flows through special venturi mixing with abrasive to thoroughly clean spark plugs like new. Lever valve on outside of unit allows for blasting with abrasive/air mix or pure air only. Abrasive material is included and is silica free. Recommended air line pressure is 70-80 PSI; maximum 90 PSI. Instructions provided.

18520 - Silica free abrasive packed 1/4 lb. per bag.

18530 - Silica free abrasive packed 1 1/2 lbs. per bag.

18540 - Silica free abrasive packed 5 lbs. per bag.

17390



CARDED

LACQUER RESISTANT DELUXE PARTS BRUSH

- Excellent for cleaning motors, machinery and metal parts
- For use with lacquer thinner
- Polyester bristles taper trimmed and joined to solid handle by a plated steel ferrule
- Overall length 11"
- Bristle length 2 3/4"
- Brush diameter 1 1/8"

17050



SOLD IN A DISPLAY BOX

GRIME SCRUB BRUSH

- Gentle and effective cleaning action quickly removes grime.
- Special row of stiff bristles cleans under fingernails.
- Contoured handle for firm gripping.
- Use in the shop or at home.
- Bristles molded firmly in place.
- Durable and lightweight.

(Each Display Box contains 24 Grime Scrub Brushes)

17380



CARDED

DISC BRAKE CALIPER BRUSH

- For removal of brake dust and dirt from caliper shaft
- For use on vehicles with disc brakes
- Thin profile accesses narrow crevices
- Plastic handle with hang-up hole
- Heavy duty steel bristles
- Angled brush head for better access
- Comfortable handle grip

THE HOOKER

13700 - Use to remove body clips, mouldings, windshield seals. Doubles as a cotter pin extractor. Use as a spring puller. Saves radiator hoses.



EXTRA LONG HOOKER

13800 - An extra long version of the famous Hooker made of tough, spring steel, heat treated, tempered and plated. Newer cars and trucks have more equipment packed under the hood. Extra Long Hooker provides necessary longer reach with 4⁷/₈" blade length. Remove radiator hoses from clamp. Pull cotter pins and other long reach jobs.



GREAT BIG HOOKER

13810

13810 – A “must” tool for accessing hard-to-reach places like lower radiator hoses. Extra long length. Special hook design makes cotter pin removal easy. Allows access where clearance is tight. Great for the removal of radiator hoses from inlets, outlets and clamps. Use to retrieve small parts; remove “O” rings, washers, body clips, moldings and windshield seals.



Features include:

- 15" Overall length
- Heat treated, nickel plated steel shaft
- 11" Exposed shaft length
- Use for pushing or pulling

BIG HOOKER SET

13820

13820 – Consists of Cat. No. 13800, Extra Long Hooker and Cat. No. 13810, Great Big Hooker. Two popular tools in one kit! Use independently or as a pair



The Hooker best suited for your job. Where clearance is more open, use the Cat. No. 13800; in tight, hard-to-reach places, use the Cat. No. 13810. Great for the

removal of radiator hoses from inlets, outlets and clamps. Excellent for cotter pin removal. Use on body clips, moldings and windshield seals. Retrieve small parts. Remove “O” rings and washers.

Features include:

- Heat treated and plated
- Use for pushing or pulling
- Provides extended reach

CAT. NO.	DESCRIPTION	EXPOSED SHAFT LENGTH	OVERALL LENGTH
13800	Extra Long Hooker	4 ¹ / ₂ "	9 ¹ / ₄ "
13810	Great Big Hooker	8 ³ / ₈ "	16"

GREAT BIG HOOKER, JR.

13840

- Special hook design for easy removal of cotter pins.
- Use for the removal of radiator hoses from inlets, outlets and clamps.
- Great for working in confined areas.
- Retrieve small parts. Remove “O” rings, washers, body clips, moldings and windshield seals.
- Use for pushing and pulling applications.
- Features include:
 - 11" overall length with 6" exposed shaft
 - Heat treated nickel plated shaft



HOSE REMOVAL TOOL

13860

- Great for the removal of rubber hoses from inlets, outlets and clamps
- Specially designed end makes hose removal easy
- Large, comfortable handle
- Hardened and plated shaft
- 8¹/₂" overall length with 4" exposed shaft



DOOR UNLOCKING TOOL

15500

15500 - For vehicles having lock mechanisms accessible via the opening between the top of the door and the window glass. Full instructions provided for wide range of vehicle models. Overall length 24".

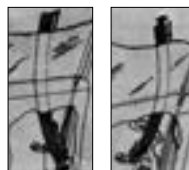

19700



Adjusts and locks to 3 positions

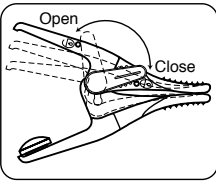

ADJUSTABLE 8 PIECE FLUID LINE STOPPER KIT

- Use to seal metal lines once disconnected
- Prevents fluid leaks and contamination during service
- For use on fuel, brake, A/C, banjo, power steering and transmission lines
- Supplied with two each of four Stoppers: Banjo Bolt, 5/16", 3/8" & 1/2"
- Use with all automotive fluids
- Adjusts and locks to 3 positions
- Installs in seconds

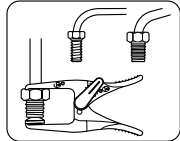

Flare Type Fuel, Brake, A/C Line

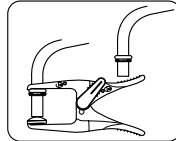

O" Ring Type AC Line

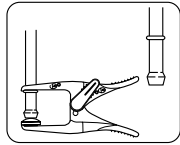

Fuel Line

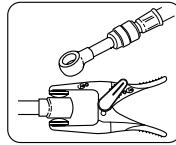

Banjo Fitting

Available individually:	
CAT. NO.	DESCRIPTION
19701	Banjo Bolt Fluid Line Stopper
19702	5/16" Fluid Line Stopper
19703	3/8" Fluid Line Stopper
19704	1/2" Fluid Line Stopper
19705	5/16" Replacement Tips (Package of 2)
19706	3/8" Replacement Tips (Package of 2)
19707	1/2" & Banjo Bolt Replacement Tips (Package of 2)

14800



DOUBLE FLARING TOOL KIT

- Flares 5 sizes of copper, aluminum, soft steel and brass tubing: 3/16", 1/4", 5/16", 3/8" and 1/2"
- Includes: Yoke with Sliding Handle, Bar Assembly and 5 Adapters
- For double or single flares up to 45°
- Full instructions provided
- Supplied in a durable, plastic molded storage case

14825



BUBBLE (I.S.O.) FLARING TOOL KIT IN PLASTIC CASE

- Forms the International Standards Organization (I.S.O.) bubble flare used on Japanese, European and domestic vehicles
- Works without having to remove the brake line from the vehicle
- For 4.75mm, 6mm, 8mm and 10mm automotive tubing
- Kit includes yoke with forcing screw and handle, four adapters, flaring bar and wrench with height gage
- Supplied in a durable, plastic molded storage case

14850



MINI TUBING CUTTER

- Cut thin-wall steel, plastic, copper and brass tubing from 1/8" – 5/8" O.D. (3-22mm).
- Produces smooth, clean cut.
- Compact size allows use in restricted areas.
- Cutter blade made from hardened steel.
- All metal construction.

CARDED

14860



TUBING BENDER

- Bend 3/16", 1/4", 5/16" and 3/8" O.D. tubing without kinking or collapsing
- Just place tubing in groove and pull the handle to the desired angle
- Contoured handle with grip

CARDED

LONG REACH PICK AND HOOK SET

- 8 piece set with special tip configurations for numerous applications
- 9½" Overall length
- Each stainless steel pick shaft will not rotate and is permanently staked into the handle
- Use to:
 - Install and remove "O" rings, seals and washers
 - Separate wires
 - Pierce
 - Pull small fuses
 - Retrieve small parts
 - Scribe
 - Align
- Compact design accesses tight areas
- Shafts are knurled and handles are grooved to prevent slippage
- Supplied in a folding pouch with individual pick pockets and a hook and loop closure

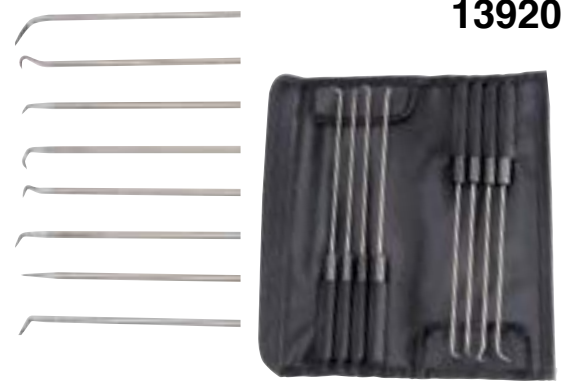

13920

UNIVERSAL HOOK & PICK SET

- Set has 7 different and distinct plated hooks and picks with high impact plastic handles
- Excellent general purpose set for installing and removing "O" rings, seals and washers; pulling small fuses; retrieving small parts; aligning; scribing; piercing; removing radiator hoses; removing body clips, mouldings and window seals; extracting cotter pins and more.
- Two lengths of general purpose picks. Longer picks are 8½" overall length and shorter picks are 5¼" overall length
- Supplied in a durable, plastic molded storage case



13850

MINI PICK, HOOK AND SCRIBE SET

13900 - Four piece set of handy technician's tools with many applications. Ideal for installing and removing "O" rings, seals and washers; pulling small fuses; retrieving small parts; aligning; scribing; piercing and more. Stainless steel blades have knurled area for better finger control. Overall length of tools is approximately 5". Packed in molded organizer tray; fits in technician's tool chest.



13900

CARDED

DOUBLE POINTED SCRIBER / HOOK

- Has straight and 90° angle points
- Heat treated, bright polished, high carbon needle steel points
- Can be used for marking in areas with restricted space
- 90° end can be used to retrieve small parts
- Knurled aluminum handle for sure grip



13950

ROLLING HEAD PRY BAR (LADY'S FOOT)

16025 - A useful pry bar for general automotive and autobody shops. Measures ½" round x 15½" long. Has long pointed taper. Forged from tool steel and plated.

CARDED



16025

BATTERY FILLER

14600 - Rubber bulb has 6 oz. capacity. Long spout. Designed for long life and dependable service. Lightweight and easy to use. Made to resist acid and retain shape. Features a built in hang up hole. Always wear eye and face protection when servicing batteries.



14600

DISPLAY PACKAGED

87250

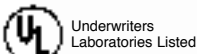

ECONOMY HEAT GUN

87250 - This is an inexpensive, high performance, hot air source that delivers concentrated, heated air to the job. Use in autobody, automotive, industrial, marine, home, farm and numerous other applications. Has two heat selections: 750°F and 1,000°F. Only weighs 1.2 pounds. Operates on 120 volts, 10 amps, 1,200 watts. Contains no asbestos. U.L. and CSA listed. Instructions provided. Special purpose nozzles are available for easy attachment.

ACCESSORY NOZZLES FOR ECONOMY HEAT GUN

PART NO.	DESCRIPTION	APPLICATIONS
87260	Pin Point Nozzle	Loosen rusted nuts and bolts. Heat gears and bearings. Bend plastic. Remove caulk.
87261	Flat Nose Nozzle	Remove automotive paint. Remove window putty.

14550



HEARING PROTECTOR

14550 - Effective protection against noise. Ultra light – weighs only 5 oz. Economical. Low profile cups minimize snags. Extra wide and soft cushions provide superior comfort and acoustic seal. Low headband force maximizes comfort and long term wear ability. Bright red earcups for high visibility. Earcups easily slide on headband to adjust for comfortable fit. Premium quality for long life. For over the head use.

Frequency in Hz	Mean Attenuation in dB	Standard Deviation in dB
125	15.4	2.7
250	19.2	2.4
500	27.8	2.3
1000	37.3	3.0
2000	35.0	2.5
3150	39.2	3.1
4000	37.2	3.0
6300	36.5	2.4
8000	36.6	2.6

NRR=24 dB Over The Head S3.19-1974

14700



KNEE PADS

14700 - Designed for the technician who must kneel at times to complete repair and service work. Thick foam padding takes the pain out of kneeling on hard surfaces. Lightweight and flexible, these knee pads provide comfort in a durable construction. Hard plastic caps make swiveling effortless and assure long life of pad. Easy to fasten with adjustable hook and loop straps. Sold as a set of two.

DISPLAY PACKAGED

14720



KNEELING PAD

14720 - Provides unrestrained knee comfort. Protects clothing. Perfect for all technicians, insurance estimators and service advisors. Also great as a creeper cushion and seat cushion.

- Measures 23" L x 11" W
- Generous 3/4" thick closed cell foam
- Tough, non-slip laminate surface.
- Impervious to water, oils and other liquids
- Convenient hang-up hole
- Easy to clean

13000

13100

13200

13400

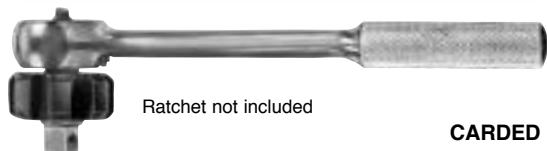

Ratchet not included

CARDED

SPIN-A-RATCHET

Use these fingertip spinners to pre-tighten nuts and bolts. Push into socket, spin to tighten position, put on ratchet and finish job. Cut labor time in ratcheting work. Available in 1/4", 3/8" and 1/2" square drive sizes and as three piece set.

CAT. NO.	SIZE
13000	1/4"
13100	3/8"
13200	1/2"
13400	(set of above)

PORTABLE WORK STAND

85800

Designed to hold large parts such as bumpers, hoods, doors, fenders and glass. Can be moved easily and adjusted to desired height or width. Made of strong tubular steel with thick foam padding to protect painted parts and glass from being scratched. Rubber boots on legs prevent sliding. Folds up for easy storage. Supplied unassembled in UPS-able carton.



CAT. NO. 85800	CAPACITY RATING 500 Lbs.	ADJUSTABLE HEIGHT 33"-44"	ADJUSTABLE WIDTH 15"-34"	FIXED LENGTH 40"	FOAM PROTECTOR PART NO. 85801	RUBBER LEG BOOT PART NO. 85804
--------------------------	------------------------------------	-------------------------------------	------------------------------------	----------------------------	---	--

MECHANIC'S PORTABLE WORK STAND WITH SLING

85850

85880

- Provides the strength of a work stand and the convenience of a parts tray all in one.
- Holds the tools, parts and fasteners used during assembly, disassembly and repair work
- Extremely portable and lightweight – take directly to the worksite
- Sling is easy to install – just wrap each hook and loop end around the foam protector of the work stand and secure
- Ideal for working on large parts such as bumpers, hoods, doors, fenders and glass
- Features strong tubular steel; adjustable height and width; thick foam padding, rubber boots on legs to prevent sliding and ability to fold for storage
- Supplied unassembled in UPS-able carton



CAT. NO.	DESCRIPTION	CAPACITY	
85850	Work Stand with Sling	500 lbs.	227 Kg
85880	Sling Only	75 lbs.	34 Kg

HEAVY DUTY CAULKING GUN

19300

19300 - Push rod design quickly and easily dispenses a smooth flow of sealants and compounds from 1/10 gallon cartridges. Completely empties cartridge. Quick release trigger removes pressure and stops material flow. Epoxy coated steel and die cast construction. Durable and dependable.



AIR POWERED CAULKING GUN

19330

19330 - Use this top quality air caulking gun to quickly and efficiently dispense a wide variety of caulking and sealants. The 8 1/2" long cylinder accommodates all standard caulking cartridges. The all metal body and rugged design ensure reliable, everyday operation. Instructions included. Air inlet size is 1/4" NPT Female. Air consumption is 4 CFM. Recommended operating pressure is 50-70 PSI. Caulking cartridge not included.



88000



UNIVERSAL (RAILROAD) DOLLY

88000 - Every body technician uses this dolly for bumping, straightening, dinging and finishing various portions of body, door panels and fenders. Good variety of curves and angles, with two beading and flanging lips. Made of drop-forged steel.

88050



TOE DOLLY

88050 - This large drop-forged steel model remains popular with body technicians. It has flat and low crown areas and is used in dinging flat surfaces and lower portions of hood. Good for close work.

88100



WEDGE (COMMA) DOLLY

88100 - A useful drop-forged steel dolly for work behind brackets, braces and other reinforcements on roof, body, fenders and panels. Advantageous in modern body design. Easy to hold in difficult areas.

88150



HEEL DOLLY

88150 - Popular for use in sharp corners and wide radii portions of panels and body. Made of drop-forged steel.

88160



DOOR SKIN DOLLY

88160 - Thick rubber encapsulates the dolly to absorb shock and provide cushioning effect. Works well on newer, thinner sheet metal. Great for applying door skins. Weighted hard rubber to match weight of hammer. Moves the metal rather than stretching it.

89400



DOOR SKIN TOOL KIT

89400 - Excellent combination kit to fold new door skins around the door frame. Cat. No. 88160, Rubber Heel Dolly absorbs shock and provides cushioning effect. Specially designed Cat. No. 89350, Door Skin Hammer easily folds the flange on door skins.

88175



SPOON DOLLY

88175 - The most popular body repair specialty tool. Combines all the contours and weight of a dolly with the reach and maneuverability of a spoon. Use for forming, prying and caulking in those hard to reach places.

89725



LIGHT SLAPPING SPOON

89725 - A handy aid for the body technician. Hit ridges directly or transfer blow with hammer. Flat surface absorbs and distributes blow evenly. Smooths out ridges uniformly without marring surface. Made of drop-forged steel.

IMPORTANT — FOR YOUR SAFETY

Our tools are of the best quality and should be used with confidence for the purposes intended and within their size ranges. **Always** keep hammer heads tight on their handles. **Never** strike cold chisels, punches or any other hardened objects with body hammers. **Always** wear safety eye and face protection when striking objects.

PICK AND FINISHING HAMMER

89000 - Most popular body shop hammer. Designed to provide excellent balance for close-in work and finishing. Flat, round face, 1¼" diam. Pencil point on 5¼" drop-forged steel body.



89000

MEDIUM BUMPING & FINISHING HAMMER

89050 - Good for close work and final finishing. Both faces flat. Round face 1⅜" diam. Square face 1⅜". Overall 4¼". Drop-forged steel.



89050

BLUNT POINT & FINISHING HAMMER

89100 - Use for small clearance jobs and low spots in high crown panels as well as general finishing work. Round flat face 1½" diam. Bullet point on 5¾" body. Drop-forged steel.



89100

HEAVY DUTY SHRINKING HAMMER

89150 - For all-around work and fast finishing. Will not stretch metal. Ideal for close quarters. Drop-forged steel body 5" overall. Round head has uniform serrated face 1⅝" diam. Square head is flat faced 1⅜".



89150

CHISEL & FINISHING HAMMER

89200 - This drop-forged steel hammer is a must for straight finishing and grooving jobs. Work on narrow fender beads with wedge shaped chisel cross peen. Round head has flat surface 1⅝" diam. 5½" overall length.



89200

HEAVY BUMPING & FINISHING HAMMER

89250 - Very popular, reliable, drop-forged steel unit. Excellent for heavy gage truck fenders and panels. Well balanced, hit with confidence! Flat, round face 1½" diam. Flat, square face 1½". Overall length 5".



89250

7" STRAIGHT PICK HAMMER

89300 - Drop-forged steel unit provides long reach to inaccessible or otherwise blocked areas. Has round, flat face 1⅝" diam. Pick finished to pencil point. Overall length is 8".



89300

DOOR SKIN HAMMER

89350 - For high crown work and finishing, this drop-forged hammer is specially designed to reduce the time needed to fold the flange on door skins. Can also be used to reach the inner panels on vehicles.



89350

HICKORY HAMMER HANDLES WITH WEDGES

89002 - Fits most body shop hammers with larger hole in head
89357 - Fits most body shop hammers with smaller hole in head



89002

89357

BODY SPOONS

A complete line of the most popular spoons used for autobody repair. All are made of high grade steel, drop-forged, heat treated and polished to high specifications. Equipped with our famous blue shock absorbing "Hang-It" soft cushion, vinyl grip with molded finger grasp and hole for hanging. Grip may be removed for end hitting.

89600



HEAVY DUTY INSIDE SPOON

89600 - Long gentle curve reaches behind inner construction between panels which are close together for removal of dents and bumps. Use for molding panels and beadings. 15" overall length.

89625



GENERAL PURPOSE SPOON

89625 - Use for slapping and surface metal finishing on fenders, quarter panels and trunk lids where blow is spread over full impact area. 15" overall length.

89675



HIGH CROWN SPOON

89675 - Use inside where maximum curvature of damaged sheet metal is to be repaired. Excellent for prying out dents in narrow, curved spaces. 15" overall length.

89700



PRY AND BUMPING SPOON

89700 - 3 Tools in 1! Combines high crown spoon with general purpose surface. Unique length provides leverage for prying and extra long reach. 27" overall length.

17800



CARDED

ABRASIVE BLASTER

17800 - Portable and efficient, this tool blasts off rust, scale, carbon, chemicals and paint with ease! Operates on standard compressed air. Has 1/4" NPT inlet. Supplied with 10 feet of hose and hardened steel nozzles - two with 13/64" I.D. and two with 1/4" I.D. Can also be used to blast plain air and/or liquids. Lightweight construction reduces fatigue. Produces a steady stream of abrasive without interruption regardless of height, distance and gravity. Operates with any grade of abrasive. Just place end of Pick-Up Tube in bag of abrasive. Requires 1.5 CFM up to 8 CFM of air at 60 to 150 PSI depending on nozzle size used.

PARTS

- | | |
|---------------------------------------|------------------------------------|
| 17804 — Jet Air Nozzle Adapter | 17808 — Blaster Pistol |
| 17805 — Hex Key Wrench | 17812 — 13/64" Steel Nozzle |
| 17806 — 10 Foot Hose | 17813 — 1/4" Steel Nozzle |
| 17807 — Pick-Up Tube | |

18540



SILICA FREE ABRASIVE (5 LBS.)

18540 - This 5 lb. bulk package of silica free 80 grit abrasive makes purchasing abrasive more economical. Excellent media for abrasive blasting and spark plug cleaning. Some applications include removing rust, carbon and paint; etching glass; texturing wood and cleaning concrete and castings. For use with our Cat. Nos. 17800 and 18500 and similar equipment. Other sizes of abrasive are also available:

CAT. NO.	DESCRIPTION
18520	Silica free abrasive packed 1/4 lb. per bag
18530	Silica free abrasive packed 1 1/2 lbs. per bag

ALWAYS WEAR EYE, RESPIRATORY AND BODY PROTECTION WHEN USING ABRASIVE BLASTING TOOLS. NEVER AIM BLASTING TOOLS AT ANYONE.

5 PC. BODY FORMING PUNCH SET

89360
NEW

- These punches fit where your hammer will not
- Use to form body panels in hard to reach areas
- Great for tight clearance spots, crevices and corners
- Polished and hardened surfaces to form sheet metal with precision
- 5 Profiles to fit the specific job
- The most popular needed profiles and shapes
- Use to form curves, contours and radiuses
- Reaches far into panels and structural members to form sheet metal
- 12" Overall length
- For use on:
 - Door panels
 - High crown panels
 - Interior parts of body panels
 - Fenders
 - Rear quarter panels
 - Trunk lids
 - Frames



• Contains:

Cat. No.	Description
89361	Round Body Forming Punch
89362	Square Body Forming Punch
89363	Bumping Body Forming Punch
89364	Offset Bumping Body Forming Punch
89365	Radial Chisel Body Forming Punch



Patent Pending

BODY REPAIR KITS

89450
89470
NEW

- Dedicated sets for aluminum body (Cat. No. 89450 = pieces painted red) and steel (Cat. No. 89470 = pieces painted blue) body repairs
- Forged steel
- Versatile design for a variety of applications
- Highly polished hammer heads and dollies
- Hickory hammer handles
- Supplied in blow molded case
- Includes:
 - Universal Dolly
 - Toe Dolly
 - Heel Dolly
 - Pick & Finishing Hammer
 - Chisel & Finishing Hammer
 - Heavy Bumping & Finishing Hammer
 - Door Skin Hammer
 - General Purpose Spoon
 - Light Slapping Spoon



89450 (Painted Red)



89470 (Painted Blue)

81000

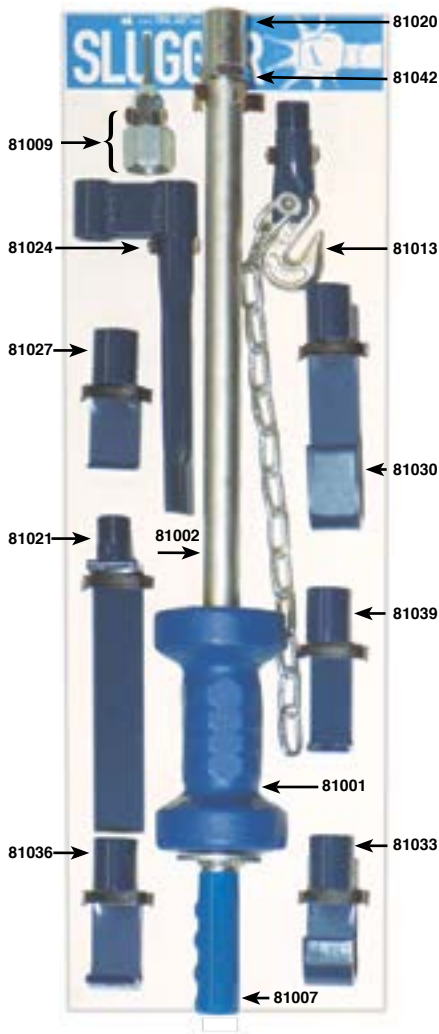

THE SLUGGER, HEAVY DUTY SLIDE HAMMER

...perfectly designed for the toughest repair applications.

8 BIG FEATURES

1. 10 lb. slide weight designed for in-line impact. Balanced for continued use without fatigue.
2. Special hand-fit weight for ease of work.
3. **The most complete set available!** 10 of the latest and most modern engineered body pulling and pushing attachments. Consists of 16 different parts.
4. Dual hammer action for reverse or direct reconstruction blows.
5. Quick assembly for applied hook-ups on fender edges, bumper ends, rocker panels, aligning doors and door edges, hoods and hood hinges, trunk and trunk hinges, headlights and many more applications.
6. Rubberized hand-hold for good grip and safety.
7. All parts easily stored on permanent board.
8. Supplied with exclusive lock nut to keep attachments from rotating.

PART NO.	DESCRIPTION	PART NO.	DESCRIPTION
81001	SLIDE HAMMER	81021	OFFSET BLADE
81002	SLIDE SHAFT	81024	PIPE BLADE ASSEMBLY
81007	HAND GRIP	81025	PIPE BLADE
81009	SCREW PULLER ASSEMBLY	81026	DOUBLE COUPLING
81010	ADAPTER	81027	THIN HOOK
81011	NOSE CONE	81030	LARGE HOOK
81012	SCREW	81033	SMALL HOOK
81013	CHAIN HOOK ASSEMBLY	81036	STRAIGHT HOOK
81015	HOOK HOLDER	81039	CLAW HOOK
81016	GRAB HOOK	81042	LOCK NUT
81017	CHAIN	81043	DISPLAY BOARD
81020	COUPLING		

81100



THE SLUGGER IN A TOOL BOX

81100 - An assortment of the most widely used Slugger parts packed in a handy metal tool box which can be locked for security.

PART NO.	DESCRIPTION	PART NO.	DESCRIPTION
81001	SLIDE HAMMER	81020	COUPLING
81002	SLIDE SHAFT	81021	OFFSET BLADE
81007	HAND GRIP	81027	THIN HOOK
81009	SCREW PULLER ASSEMBLY	81030	LARGE HOOK
81010	ADAPTER	81033	SMALL HOOK
81011	NOSE CONE	81039	CLAW HOOK
81012	SCREW	81042	LOCK NUT
81013	CHAIN HOOK ASSEMBLY	81132	METAL BOX & TRAY

80000



ECONOMY SLUGGER SET

80000 - A basic set of the most popular Slugger hooks supplied in a carton without board or metal box. Allows new technician to get started with a quality set at significant savings. Additional Slugger parts can be added to set in the future.

DENT PULLER AND SLIDE HAMMER

81400

81400 - The largest selling and most economical body shop dent puller in the industry. 3 lb. slide weight is mounted on 1/2" plated steel shaft. Famous blue vinyl hand grip over steel handle reduces sting on technician's hands and provides 100% grip. Broached hex in nose cone locks pulling screw in place... ends breakage. Supplied with two hardened pulling screws and "L" puller hook fabricated of aircraft quality steel. Nose cone and shaft threads are 1/2"-20.



JUNIOR SLUGGER SLIDE HAMMER DENT PULLER

81500

81500 - The finest shop engineered heavy duty slide hammer with 3 lb. slide weight. Features a soft vinyl "Hang-It" handle grip for easy storage and shock cushioning. Special wide aircraft steel body hook is used to pull curls and creases in quarter, rocker, back and door panels. "L" hook, broached nose cone, two jam nuts and two hardened pulling screws are supplied. Designed for the professional body technician - a LIFETIME tool. Total weight is 5 lbs. Nose cone and shaft threads are 1/2"-20.



MIDI-WEIGHT SLIDE HAMMER DENT PULLER

81200

81200 - Provides excellent balance with 5 lb. slide weight on plated, solid, 5/8" shaft. Exclusive soft cushion vinyl grip with "Hang-It" hole absorbs shock. Broached nose cone locks puller screw firmly in place. Supplied with body hook of heavy duty aircraft steel for pulling out curled and creased edges and panels. Helps in aligning hood and trunk hinges. Heavy duty puller screw is extra long. Designed for that in-between job where the 10 lb. Slugger slide weight is too heavy and the pullers with 3 lb. weights are too light. Nose cone and shaft threads are 5/8"-18.



THE TAPPER SLIDE HAMMER DENT PULLER

81600

81600 - The ideal body panel puller for the do-it-yourselfer. The 2 lb. weight slides on plated shaft. Spade handle makes it easy to rotate tool and turn puller screw into body panel. Broached nose cone prevents puller screw from turning. Nose cone and shaft threads are 3/8"-24.



CARDED

6" RUBBER SUCTION CUP

81810

81810 - Use to pull out sheet metal panel dents on doors, fenders and hoods. Steel handle and reinforced steel support plate allow for maximum pull. Release suction easily by lifting "lipped" edge.



LEVER ACTIVATED SINGLE SUCTION CUP

87360

- For windshield removal and replacement
- Use to pull out sheet metal panel dents on doors, fenders and hoods
- Easy to use – Just firmly set the suction cup and squeeze the handles together
- High impact plastic housing
- Suction Cup measures 4 5/8" diameter
- Safety orange for high visibility
- Capacity 80 lbs



LEVER ACTIVATED DOUBLE SUCTION CUP

87370

- For windshield removal and replacement
- Easy to use – Just firmly set the suction cup and press down on each lever
- High impact plastic housing
- Suction Cups measure 4 5/8" diameter and pivot for better gripping
- Safety orange for high visibility
- Capacity 154 lbs



15210



1/8" STUBBY BODY PANEL DRILL BIT WITH DOUBLE ENDS

Made of high speed steel for sheet metal. Have 135° split points for fast drilling without center punching. Double ended bit can easily be flipped in a drill for new drilling end. Packed ten drill bits in a hang-up plastic display vial.

15060



CARDED

TITANIUM MULTI-STEP DRILL

- For sheet metal and other thin materials up to 1/8" thick
- Has 13 hole sizes in 1/32" increments from 1/8" thru 1/2"
- Great for autobody repair
- High speed steel with titanium coating for longer life
- Double flute design for improved cutting action
- No-slip shank fits all 1/4" drills
- Automatically de-burrs drilled holes
- No center punch needed to start

18000



CARDED

3/8" ROTARY SPOT WELD CUTTER

18000 - Quickly removes spot welds holding sheet metal. Can also cut small access holes in sheet metal. Has double ended 3/8" blade and 1/4" arbor with retractable pilot. When one side of blade becomes dull turn blade 180° for fresh cutting surface. Blades interchange with other spot weld arbors. Arbor fits all 1/4" drills.

18025



REPLACEMENT BLADES FOR 3/8" ROTARY SPOT WELD CUTTER

18025 - Package of three 3/8" double ended cutting blades for Cat. No.18000.

18050



MAINTENANCE KIT FOR 3/8" ROTARY SPOT WELD CUTTER

18050 - Kit consists of three pilot pins and three springs for Cat. No. 18000.

89500



CARDED

SPOT WELD BUSTER SET

- Two piece set quickly separates spot welded panels without damage
- Easy to use – just drill out the spot weld, drive the blade between the panels and hit with a hammer
- Hardened steel
- Saves time
- Cushioned grip for comfort

Spot Weld Busters are available individually bulk packed:

CAT. NO.	DESCRIPTION
89510	Straight Spot Weld Buster
89520	90° Spot Weld Buster

87700

87800



CARDED

JIGGLER WINDSHIELD AND REAR WINDOW REVEAL MOLDING TOOLS

Remove clips holding windshield and rear window reveal molding. Double sided tool can be applied easily and allows for quick disengagement of molding clips. Rubber insert on tools protects glass from being scratched. Made from heat treated spring steel. A must for body and glass shops.

CAT. NO.	VEHICLE MAKE
87700	General Motors
87800	Ford Motor Co.

DOOR ALIGNER TOOL

82350

- Align car and truck doors with either bolted or welded hinges in seconds by using leverage
- Quickly and easily mounts in place with no special tools
- Patented feature pulls door against tool to prevent distorting the metal around latches
- Curved handle allows access in restricted areas
- Includes special pin for truck doors
- High quality all steel construction
- Painted safety orange for high visibility

U.S. Patent Nos. 5,331,837 and 7,040,135.

Easily used in 4 steps:

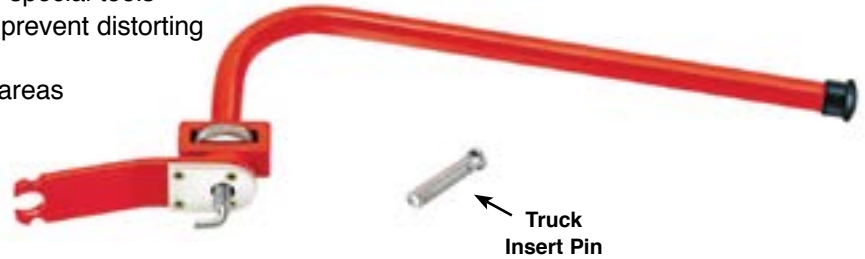

1. Install



2. Tighten



3. Position



4. Adjust



DOOR SPRING TOOL

87675

Use to remove and install the door hinge springs found on late model General Motors cars and light trucks (with larger diameter springs). Makes a hard job easy. Can be used with a 1/2" open end or ratcheting box wrench. Always wear eye and face protection.



CARDED

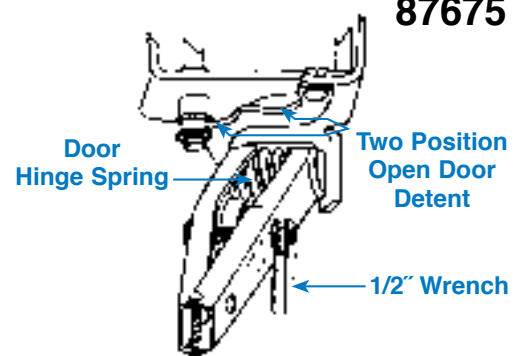

DOOR ALIGNER HINGE SPRINGER

87500

87500 - Repair sprung doors on domestic and foreign made vehicles with box type door hinges in deep or shallow wells. Knurled surface prevents slippage. Use on front and rear door hinges and trunk lids.



CARDED

BUFFING BONNET CLEANING TOOL

87975

87975 - Extends life of all buffing pads and bonnets without taking them off the polisher. Cleans and revitalizes in one operation. Removes glazed surface and fluffs packed wool. Brings pads and bonnets back to like new condition in seconds. Minimizes washing. Wear eye protection.



CARDED

89890



FLEXIBLE SANDING BOARD

- For sanding rounded or flat surfaces
- Smooth, hardwood handles are contoured for comfort and secured to flexible plastic base
- Uses standard cut abrasive paper, 2¾" x 17½"
- Lever style clamps hold paper firmly on cushioned base
- For wet or dry sanding

89900



SANDING BOARDS

The three most popular hand held sanding boards use standard size abrasive paper. Lever style clamps hold paper tightly in place. Smooth, hardwood handles are contoured for comfort and mounted on a sturdy rust-proof, aluminum base with cushioned bottom. Ideal for wet or dry sanding on any surface.

89910



89900 - Uses standard cut abrasive paper, 2¾" x 8"

89910 - Uses standard cut abrasive paper, 2¾" x 11"

89920



89920 - Uses standard cut abrasive paper, 2¾" x 17½"

89800



5" SANDING BLOCK

89800 - Uses standard 3" x 8" sandpaper. Easy to affix paper to steel spikes molded into block. Holds paper securely. Use with wet or dry sandpaper on flat or curved surface.

CARDED

89810



9" SANDING BLOCK

89810 - Same style as Cat. No. 89800, except uses standard 9" x 11" sandpaper cut in thirds.

CARDED

89780

89790



89780



89790

NIB FILES

Removes imperfections on paint jobs, such as dirt and runs, without respraying. Saves hours of labor. High quality, precision ground files assure uniform results without gouging. Easy to use – requires no special skill. Works on both primer coats and top coats. Use the coarse nib file for heavy imperfections. Use the fine nib file for tiny imperfections. For use on dry paint surfaces only.

CAT. NO.	DESCRIPTION
89780	Coarse Nib File
89790	Fine Nib File

CARDED



BUCKET OF EASY GRIP BRUSHES

17370

- Contains 12 each of the most popular brushes – brass, nylon and stainless steel bristles
- Economically priced right
- Excellent for all types of cleaning applications
- Each brush is 3 x 7 rows with a hang-up hole in the handle. 7" overall length
- For use with cleaning solvents, thinners and chemicals
- Use the brass and stainless steel brushes where aggressive action is needed. The nylon brush is used for milder cleaning action
- Polypropylene handles are molded for easy gripping
- Specially designed narrow head fits into hard to clean areas



EASY GRIP BRUSH SET

17170

17170 - Contains one each of the most popular brushes - brass, nylon and stainless steel bristles. Use the brass and stainless steel brushes where aggressive action is needed. The nylon brush is used for milder cleaning action. Polypropylene handles have been molded for easy gripping. Specially designed narrow head fits into hard to clean areas. Each brush is 3 x 7 rows and has a hang up hole in the handle. For use with cleaning solvents, thinners and chemicals. Excellent set for all types of cleaning applications. Overall length of each brush is 7".

Above brushes are also available individually:

CAT. NO.	DESCRIPTION
17180	Easy Grip Brass Brush
17185	Easy Grip Nylon Brush
17190	Easy Grip Stainless Steel Brush



CARDED

BRUSH SET FOR SPRAY GUN ORIFICES

17000

17000 - Specially designed brushes for cleaning the small air passages on air caps and fluid tips. Can also be used on small orifices found on engines, such as throttle bodies and carburetors.

Set includes:

- 5 brushes with the following diameters: .0625", .094", .125", .156" and .187"
- Durable nylon bristles for long lasting use
- Convenient wire ring holder keeps set intact



DISPLAY PACKAGED

SPRAY GUN CLEANING KIT

17280

17280 - Kit contains all necessary brushes and tools to effectively clean spray guns including new HVLP paint spray guns. Can also be used to clean gravity feed, siphon and undercoating guns. Safe to use with chemicals and solvents. Brushes are used to clean threads, air passages and recesses of gun body. Special pick probe is provided for cleaning air caps. Kit includes five different brushes, pick probe, five wooden picks and a container of gun lube.



CARDED

FLEXIBLE BODY FILES

89750

Use with file holder to remove and smooth metal and plastic body filler on flat and contoured surfaces. Heat treated for long life. Flexible and double sided with milled curved teeth. Has two mounting holes for use with file holder, Cat. No. 89770.

CAT. NO.	DESCRIPTION
89750	14" long, flat, 6 teeth per inch. For use with plastic body filler.
89760	14" long, flat, 9 teeth per inch. For use with plastic and metal body filler.

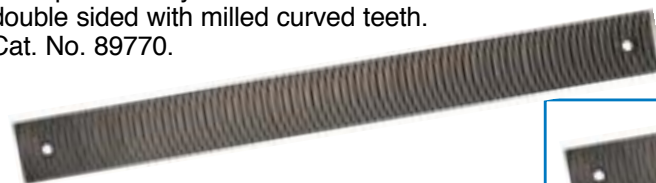

CARDED



ADJUSTABLE HOLDER FOR 14" FLEXIBLE BODY FILES

89770

89770 - Fits all 14" flexible body files. Aluminum and steel construction. Turnbuckle design allows body file to be curved concave or convex. Files mount quickly and easily on holder with two mounting screws. For right and left hand use.



87460

WINDSHIELD REMOVAL KIT

87460 - This kit contains the basic tools and wire needed for removing even the most modern windshields. Makes a difficult job easy – even on acutely angled windshields. Supplied in a durable, vinyl pouch for store display and tool box storage.

Contains the following:

CAT. NO.	DESCRIPTION
87425	Braided, Golden, Windshield Cut-Out Wire
87435	Starting Tool for Windshield Cut-Out Wire
87440	Handles for Windshield Cut-Out Wire (Set of 2)



87440

HANDLES FOR WINDSHIELD CUT-OUT WIRE (SET OF 2)

87440 - Securely and safely holds windshield cut-out wire up to .035" diameter. Comfortable, contoured handles eliminate discomfort caused by wrapping wire around hands or a makeshift holder. Holds braided or solid wire. These handles enable cut-out wire to be pulled through adhesive with greater control and ease. Wedge design securely holds wire in place. Wire installs quickly and can easily be adjusted to different lengths. Specially designed to keep wire away from your hands and fingers.



CARDED

87435

STARTING TOOL FOR WINDSHIELD CUT-OUT WIRE

87435 - This tool is designed to be extra long to push wire through the seal surrounding the new, modern windshields that are extremely sloped. Designed for today's acute angled windshields. Quickly pushes braided and solid windshield cut-out wire through the urethane seal. Easy to use – just insert the wire into the slot at the end of the tool and push through the urethane seal. The wire is now ready to cut the windshield away from the urethane seal. Great for use in vehicles where the urethane seal is recessed below the dash. Made from stainless spring steel. Slot in the tip keeps wire in place. Handle is contoured for comfortable gripping.



CARDED

87425

BRAIDED, GOLDEN, WINDSHIELD CUT-OUT WIRE

87425 - Braided design provides the fastest cutting action possible. Quickly slices through urethane and silicone windshield adhesives. Each braided helix of this wire acts like a cutting saw tooth. 72 feet per hank. Wear eye protection and work gloves when using cut-out wire.



CARDED

87900

WINDSHIELD REMOVING TOOL (COLD KNIFE)

87900 - Use to remove windshields, backlights and bonded backlights. Cuts the sealant around windows with specially designed tempered steel blade. **Extra blade supplied with each tool.** Pull handle provides additional leverage. Replacement Blade Part No. 87902.



CARDED

87880

URETHANE CUT-OUT KNIVES

87890

- Cuts the urethane bond holding windshield
- Light-weight, rigid aluminum shank with vinyl grip
- Use standard utility knife blade which is easily replaced
- Blade held firmly in place by a steel plate and pin
- Includes two blades (Replacement Blade Part No. 87884)

CAT. NO.	LENGTH	DESCRIPTION
87880	18"	Standard Length
87890	24"	Extra long for vehicles with extremely sloped windshields



87920

WEATHERSTRIP MASKING KIT

87920 - Lifts weatherstripping from metal surface to allow faster masking and preparation of the metal under the weatherstripping before painting. Eliminates paint lines. Prevents paint overspray. Makes painting and clean up easier. Kit includes a contoured installation tool with one 15' roll of 2mm plastic cord and one 15' roll of 4mm plastic cord. Complete instructions supplied.

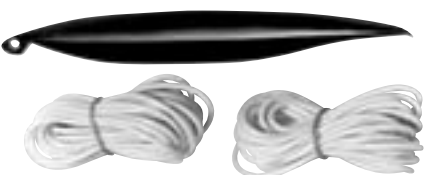

66

CARDED

87930 - One 15' roll of 2mm replacement plastic cord

87935 - One 15' roll of 4mm replacement plastic cord

AUTOBODY SKINNER BRUSH AND ARBOR

17220 - An excellent aid for all technicians. Wire bristles are encapsulated in a special material to extend brush life and promote aggressive brush action. Quickly gets down to bare metal. Great for use in confined areas and for removing paint before spot welding. Fits any 1/4" drill. Maximum safe speed 18,000 RPM. Always wear eye protection.

17230 - Replacement brush only

17235 - Arbor only

CARDED



17220

END BRUSHES

True technician's aids! Use to remove paint, carbon, rust, corrosion and weld scale. Excellent for body surface preparation. Made with 0.020" high fatigue resistant steel wire. 1/4" shank fits all portable drills. For best brushing results do not operate over 8,000 RPM. Maximum safe speed 20,000 RPM. Always wear safety eye protection.

CIRCULAR FLARED

17100 - For side cleaning action and close corner work. Will not score bottom of blind holes. Made of crimped steel wire.

CARDED



17100

SOLID END

17110 - Removes carbon from cylinder heads, valve ports and pistons quickly. Made of crimped steel wire.

CARDED



17110

HOLLOW END KNOT

17120 - Use in severe applications to remove deep rust, weld splatter, scale and heavy carbon deposits.

CARDED



17120

2 1/2" WIRE CUP BRUSH

17130 - Made of fatigue resistant, .014" crimped steel wire. This brush is used for numerous auto body and engine applications. Removes paint, carbon, rust and corrosion. Cleans pitted surfaces and gasket residue. Has 1/4" shank fits all portable drills. Maximum safe speed 5,000 RPM.

CARDED



17130

SCRATCH BRUSH

Use to remove paint, rust, dirt, scale, solder and chips. Made from 30 gauge, oil tempered steel wire and secured in smooth, hardwood handle curved to give best cleaning angle. Length 13 1/16".

STANDARD SCRATCH BRUSH

17150 - Most widely used model with 3 x 19 bristle rows. Bristle trim length 1 3/16".



17150

ALL PURPOSE ECONOMY PAINT BRUSHES

These brushes are made from pure hogs hair bristles held to a natural hardwood handle by a plated steel ferrule. Brushes are unaffected by chemicals, grease, oils and thinners found in garages and body shops. Excellent for application of compound, glues, fiberglass, undercoating, grease, oil, paint and paint removers. Also use for parts cleaning.

CAT. NO.	WIDTH
17300	1/2"
17310	1"
17320	1 1/2"
17330	2"
17340	2 1/2"
17350	3"
17360	4"



87820



TACK PULLER

87820 - Use to lift and remove upholstery and trim clips, staples, nails and brads. Comfortable, contoured handle. Rust resistant, zinc plated shaft. Rugged construction. 7¾" Overall length.

87810



UPHOLSTERY CLIP REMOVAL TOOL

87810 – It only takes a few seconds to easily and safely remove upholstery and trim clips on doors, dashboards and consoles. Does not mar panel surface. Universal design removes both plastic and metal clips of various shapes and sizes. Eliminates broken fasteners. For use on cars and trucks. Easy to use, just insert and pry.

Features include:

- Comfortable, contoured handle
- Rust resistant, zinc plated shaft
- 9" Overall length
- Rugged construction

87650



TRIM PAD REMOVAL TOOL

87650 - Remove the plastic trim pad fasteners used on General Motors cars since the early 1970's. Does not damage trim pad or fasteners. They can be fully reused. The tool reaches under the trim panel and pries against hidden surfaces without breakage or scratching paint. Works equally as well on metal trim pad fasteners used on Ford, Chrysler and other cars.

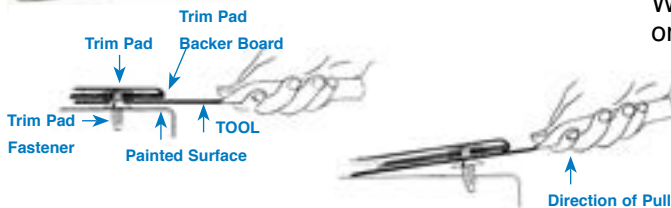

87600



EE-ZEE WINDOW REGULATOR AND DOOR HANDLE CLIP REMOVER

87600 - Instant removal of door handle and window regulator clips. End damage to upholstery and escutcheon plate. Standard for all Ford, General Motors and American Motors models.

87615



UNIVERSAL WINDOW REGULATOR AND DOOR HANDLE CLIP REMOVER

87615 - Quickly and easily removes window regulator arm and door handle on most vehicles. One end fits retaining clips on General Motors, Ford and American Motors. Other end is sized for Chrysler and some later American Motors models. Prevents damage to upholstery and escutcheon plate.

ALL ITEMS ON THIS PAGE CARDED

BARREL PUMPS

17580 ROTARY BARREL PUMP

- Fits 15, 30 & 55 gallon drums with 2" bung opening
- Dispenses approx. 8 gallons per 100 revolutions
- Curved discharge spout
- Handle swivels for easy cranking
- Made from polyphenylene sulfide (PPS) with fluorine rubber and Teflon® seals for use with:
 - Thinners
 - Acetone
 - DEF (Urea)
 - Gasoline
 - Water
 - Weak Acids
 - Windshield Washer Fluid
 - Anti-freeze
 - Diesel
 - Alkalines
 - Petroleum



17580



17560 LEVER BARREL PUMP

- Fits 15 – 55 gallon drums with 1½" or 2" bung openings
- For use with petroleum based non-corrosive fluids
- Curved discharge spout
- Long lasting Viton® seal
- Dispenses approximately 10 oz. per stroke
- Telescopic suction tube adjusts from 19" to 35"
- Zinc die cast head
- Cushioned hand grip
- Not for use with water



17550 LIFT ACTION BARREL PUMP

- Lift action handle dispenses approximately 1½" pints per complete stroke
- Use to transfer petroleum based fluids such as lubricants, anti-freeze, solvents, thinner and other non-corrosive liquids
- Teflon® seal
- Fully adjustable suction tube fits 15, 30 and 55 gallon drums
- Plated steel construction
- Curved discharge spout is removable
- Bung adapter fits all standard drums
- Not for use with water

PAIL PUMP

17500 - Fits all 5 and 6 gallon pails. Easily dispenses fluid with lift action. For use with all non-corrosive liquids. Teflon® seal designed for use with thinner. Fully plated, steel construction. Dependable and long lasting.

CARDED



17500

DRUM FAUCET

17650 - For use with all petroleum products, lacquers, varnishes, thinners, alcohol and auto anti-freeze. Push lever control. Drum faucet is ¾" NPT Male. Zinc plated inside and outside for improved corrosive resistance. Has nylon valve for longer life and better seal on thin liquids. Automatically self closing. Can be padlocked only in closed position. Not for use with trichlor ethylene and other chlorinated products or detergents and water solution chemicals.

CARDED



17650

19800

1/4" SUPER DUTY RIVETERS

- Easily sets five sizes of aluminum and steel rivets: 1/8" (3.2mm), 5/32" (4.0mm), 3/16" (4.8mm), 7/32" (6.0mm) and 1/4" (6.4mm)
- Versatile and easy to use
- Long handles for greater leverage
- Comfortable handle grips
- Metal construction and simple design with few moving parts to ensure years of service
- Lightweight plastic bottle catches rivet stems
- Nosepieces thread into handles for convenient storage

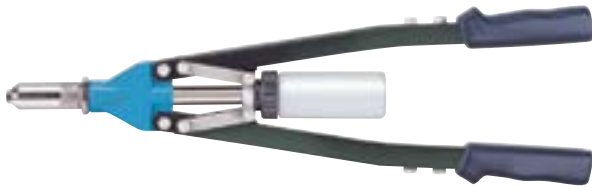

19830

CAT. NO.

DESCRIPTION

19800

2 1/4" nose reach for standard use

19830

5 3/4" nose reach to access deep recesses such as grills, bumpers and window regulators

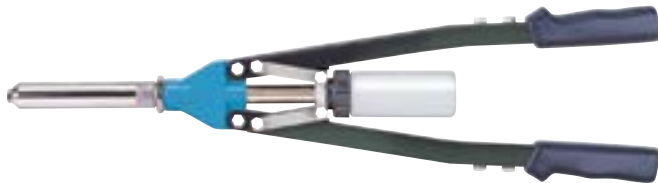

19820

EXTENDED NOSE KIT FOR CAT. NO. 19800

- Replaces the original nose on the Cat. No. 19800, Super Duty Riveter
- Installs quickly and easily
- With the new nose length of 5 3/4", the riveter easily reaches into recesses such as grills, bumpers and window regulators



19200

HEAVY DUTY HAND RIVETER KIT WITH 40 RIVETS

19200 - Use this heavy duty hand riveter to set 3/32", 1/8", 5/32" and 3/16" rivets quickly and easily. Sets up to 3/16" steel or aluminum rivets. Comes with 4 nosepieces which are mounted on the Heavy Duty Riveter. Nosepieces are easily interchangeable by using wrench provided with tool. Wrench stores in cushion molded handle grip. Riveted connections are strong and do not come loose with vibrations. Use rivets instead of screws and bolts, brazing, soldering and welding. A starter assortment consisting of 10 each 3/32", 1/8", 5/32" and 3/16" rivets is included. Durable and comfortable to use.

CARDED



19400

RIVET TOOL FOR PLASTIC RIVETS

- Sets most plastic rivets in one stroke without re-gripping
- Won't damage painted, plated or easily marred surfaces
- Long reach design accesses areas not accessible with lever type tools
- Sets all sizes using a single nosepiece
- Lightweight tool is designed for one hand operation
- All metal construction
- Not for use with metal rivets

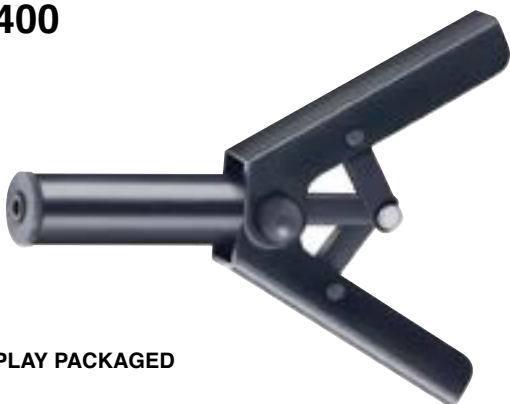

DISPLAY PACKAGED



18560
Deutsch Release Tool for 6 AWG
Page 5



18570
Deutsch Release Tool 8 & 10 AWG
Page 5



18650
Deutsch Terminal Service Kit
Page 4



18700
Master Terminals Service Kit
Page 4



18850
Weather Pack Terminals
Crimping Kit
Page 6



18860
Terminal Crimper for Deutsch
12 Gage Closed Barrel Terminals
Page 5



18870
Terminal Crimper for Deutsch
6, 8 & 10 Gage
Closed Barrel Terminals
Page 5



18910
Terminal Crimper for Weather
Pack & Metri Pack Terminals
Page 5



22800
Retractable Test Lead
Reel - 1 Lead x 30'
Page 12



22810
Retractable Test Leads
Reel - 2 Leads x 30'
Page 12



22820
Magnetic Retractable Test Leads
Reel - 2 Leads x 30'
Page 12



22830
Retractable Test Leads
Reel - 3 Leads x 10'
Page 12



22840
Magnetic Retractable Test
Leads Reel - 3 Leads x 10'
Page 12



23210
Double Wall Adhesive
Heat Shrink Tubes Assortment
Page 11



23220 - 23224
Replacement Packages of Double
Wall Adhesive Heat Shrink Tubes
Page 11

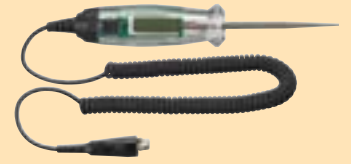

28300
Circuit Tester with Digital Display
Page 8



35750
Ford Power Stroke Diesel
Compression Testing Kit
Page 29



89360
5 Pc. Body Forming Punch Set
Page 59



89450
9 Pc. Aluminum Body Repair Kit
Page 59



89470
9 Pc. Body Repair Kit
Page 59



Electrical PGS. 4-14

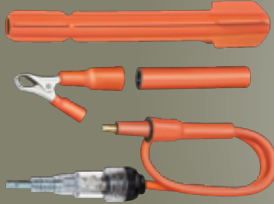

Diagnostic PGS. 15-32

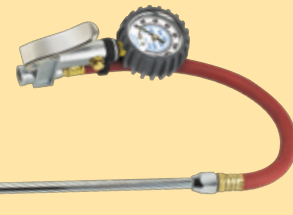

Airline Accessories PGS. 33-44

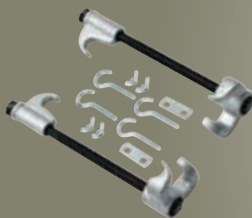

Suspension & Alignment PGS. 45-48



Hand Tools PGS. 49-54

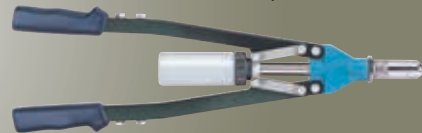

Collision Repair PGS. 55-70

NEW PRODUCTS CATALOG SUPPLEMENT

4 PIECE CLIP REMOVAL TOOL KIT

87850

- 4 Piece kit assists with the removal of plastic wheel house, rocker and door molding clips
- Prevents damage to clips
- Both the Right Angle and Offset Clip Removal Tools have an overall length of 21" to access hard to reach molding clips
- Clips can be reused
- Clip Removal Tools are designed for pulling and pushing

Consists of:

- Cat. No. 87830, Right Angle Clip Removal Tool
- Cat. No. 87840, Offset Angle Clip Removal Tool
- Cat. No. 87853, 3/4" Wide Multi-Function Pry Tool
- Cat. No. 87854, 1 1/2" Wide Multi-Function Pry Tool

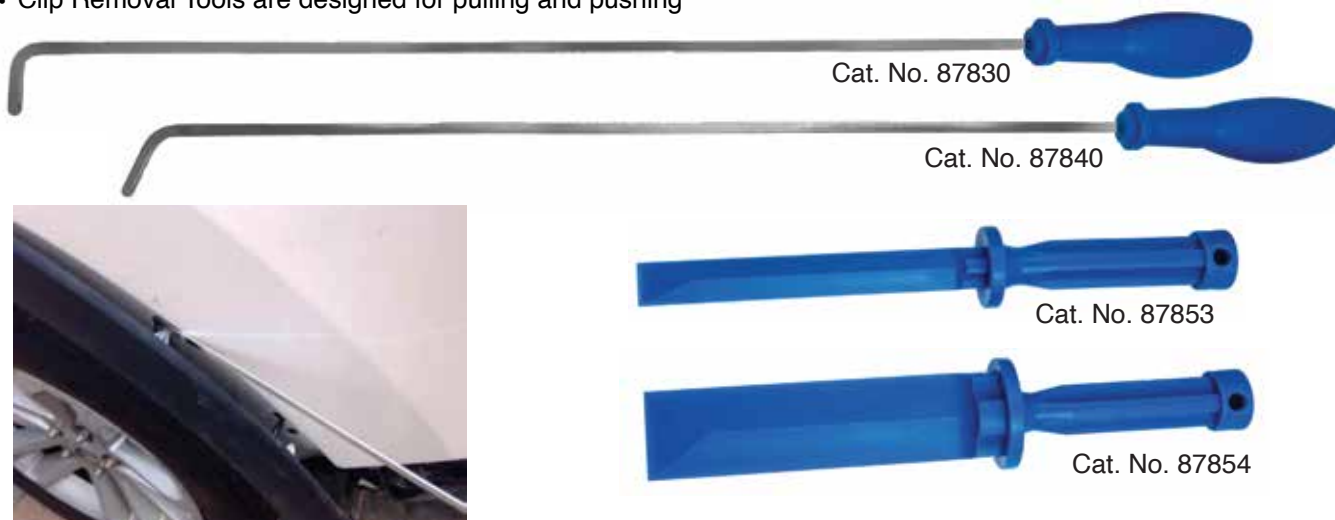

2 PIECE CLIP REMOVAL TOOL KIT

87860

- Same as Cat. No. 87850 above but does not include Cat. No. 87853 and Cat. No. 87854 for those technicians who may already have similar prying tools

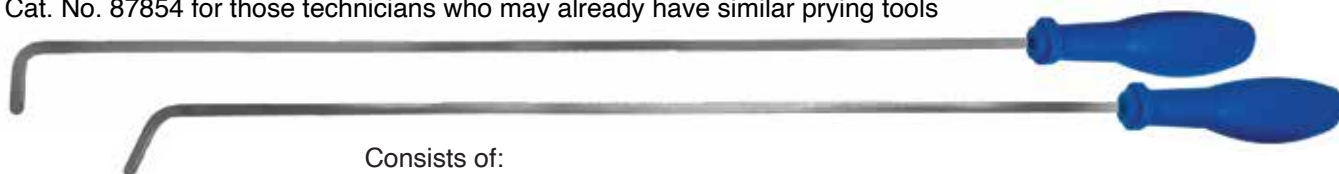

Consists of:

- Cat. No. 87830, Right Angle Clip Removal Tool
- Cat. No. 87840, Offset Angle Clip Removal Tool

MULTI-FUNCTION PRY TOOLS

- For use with the Cat. Nos. 87830 and 87840 above to put a slight tension between the molding and the panel during the removal of clips
- Can also be used to remove autobody side molding, emblems, gaskets, adhesives, trim, decals and stickers



Cat. No.	Description
87853	3/4" Wide Multi-Function Pry Tool
87854	1 1/2" Wide Multi-Function Pry Tool

23550



MASTER BACK PROBE KIT

- Use to back probe harness connectors, fuel injectors and automotive sensors
- Includes pin, flexible and curved style Back Probes
- For use in electrical and diagnostic testing
- Color coded for easy identification
- Compatible with standard 4mm plug
- Probes easily insert into automotive connectors
- Kit consists of one each:

DESCRIPTION	COLOR
Curved Probe with Lead Wire	Black
Curved Probe with Lead Wire	Red
Flexible Back Probe	Black
Flexible Back Probe	Red
Straight Probe, .040" Pin Diameter	Black
Straight Probe, .027" Pin Diameter	Red
45° Probe, .040" Pin Diameter	Black
45° Probe, .027" Pin Diameter	Red
90° Probe, .040" Pin Diameter	Black
90° Probe, .027" Pin Diameter	Red
12" Lead Wire	Black
12" Lead Wire	Red



DISPLAY PACKAGED

23535

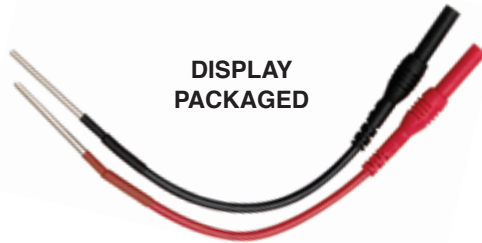

DISPLAY PACKAGED

CURVED BACK PROBE SET

- Excellent for testing round electrical connectors
- Compatible with standard 4mm plug
- For testing up to 25 volts
- Color coded for easy identification - one black and one red

23540



DISPLAY PACKAGED

FLEXIBLE BACK PROBES

- Silicone constructed back probes are bendable for accessing hard to reach places
- Makes testing at harness connectors and sensors easy
- Compatible with standard 4mm plug
- For testing up to 30 volts
- Color coded for easy identification - one black and one red

18610



CARDED

OPEN BARREL CRIMPING TOOL FOR 10-26 AWG TERMINALS

- Easily crimps 10-26 AWG non-insulated open barrel terminals in two operations
- Rolls the terminal tabs over the insulation and stripped wire
- Thin profile allows access to hard to reach areas
- Has 5 wire crimping positions
- Forms "B" crimp
- All steel construction with comfortable cushioned grips

TERMINAL CRIMPER WITH ROTATING DIE SET FOR 8 - 4/0 AWG UNINSULATED TERMINALS

18840

- Crimps popular 8 - 4/0 AWG copper electrical and battery terminals using stranded wire
- Rotating dies make hexagonal crimps and are always on tool
- Long handles for increased leverage
- Comfortable handle grips
- 26" Overall length
- Application settings chart is permanently mounted on the handle
- Heavy duty, all metal construction
- Instructions included



CABLE CUTTER

18830

- For cutting 8 - 2/0 AWG stranded copper wire
- Curved, cable gripping jaws
- All steel construction
- Thin profile
- Comfortable cushion grips
- 9 3/8" Overall length



TERMINAL CRIMPER FOR WEATHER PACK & METRI PACK TERMINALS 12 - 22 AWG

18915

- Easily crimps 12 - 22 AWG open barrel Weather Pack, Metri Pack and Molex terminals and seals in two operations
- Has 4 wire crimping and 2 seal crimping positions
- Thin profile
- Steel construction
- Comfortable cushion grips



CARDED

99350 AIR BLOW GUN KIT



- Great for general air blowing applications & air drying parts
- Accessories easily snap into place on nozzle tube
- Lever action, variable flow pistol grip blow gun
- Use for blowing out clogged tubing & pipes
- Includes special nozzle to provide a high volume of air flow
- Lightweight
- 1/4" NPT female inlet on pistol grip handle
- Supplied in a durable, plastic molded storage case

Includes:

- 4" angled nozzle blow gun with hang up slot
- Small rubber tapered nozzle - 15mm diameter
- Medium rubber tapered nozzle - 24mm diameter
- Large rubber tapered nozzle - 35mm diameter
- High volume venturi nozzle
- OSHA compliant safety nozzle
- Clear, plastic shield

