

3–6 ft. Adjustable Closet System

3H11

Rubbermaid® homefree
SERIES™

A Newell Rubbermaid Brand



L81801707E0

Tools Needed for Installation

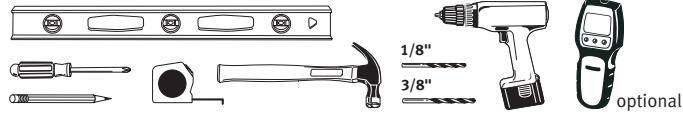

Please read through the instructions completely and check that you have all parts before beginning. Depending on the configuration you choose to install, you may not use all of the components.

Description	Part Number	Quantity	
36.25" Shelf (labeled A)	3G61	1	
36.25" Shelf (labeled B)	3J61	1	
26.25" Shelves (labeled A)	3G60	2	
26.25" Shelf (labeled B)	3J60	1	
47.5" Uprights	3G64	4	
Brackets	3G63	10	
36" Overlapping Hang Rails	3G66	2	
Clothes Rod Hangers	3G68	8	
36" Inner Clothes Rod	3G74	1	
36" Outer Clothes Rod	3G75	1	
26" Inner Clothes Rod	3G72	1	
26" Outer Clothes Rod	3G73	1	
22" Rail Covers	3J57	3	

The following parts are packed together in a hardware bag:

Screws with white tip	1603168	11	
0.5" Drywall Anchors	3J65	6	
Anchor Push Pin	3J66	1	
6" Rail Covers	3J56	2	
Clothes Rod End Caps	3G71	6	

1 Mount Overlapping Hang Rails

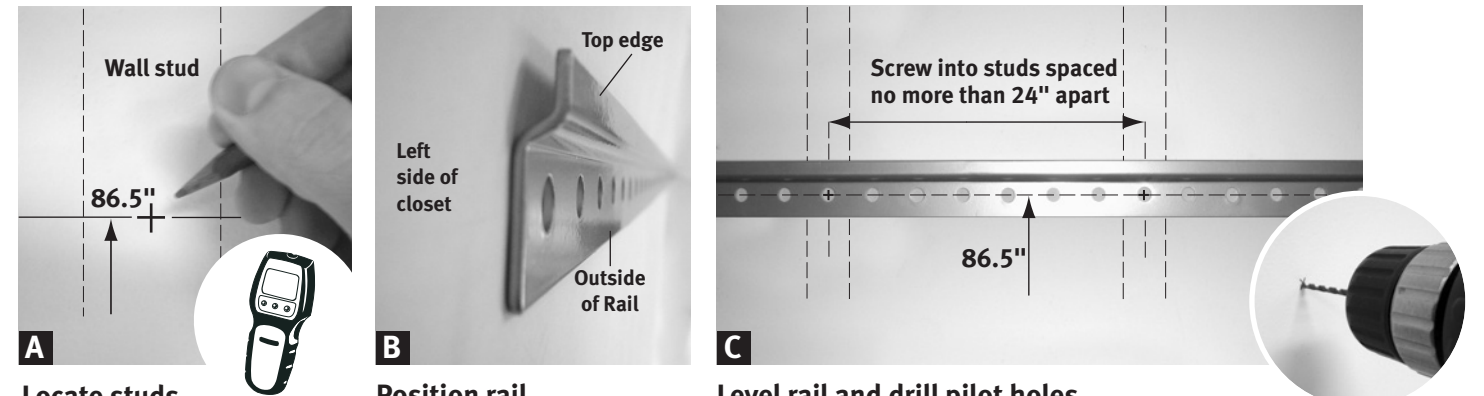

A Locate studs

On closet wall, locate all wall studs and mark them 86.5" above the floor. Using a stud finder can be useful (optional).

B Position rail

Position first hang rail so that the rail is touching the left side of your closet.

C Level rail and drill pilot holes

Level hang rail and mark holes 86.5" above floor that land on studs, then drill 1/8" pilot holes for screws.

►Hint: Draw a pencil line across your 86.5" mark to identify screw placement and ensure that the line is level.

Secure left end of rail

If there is a stud within 4" from the wall, skip steps D (1) and D (2).

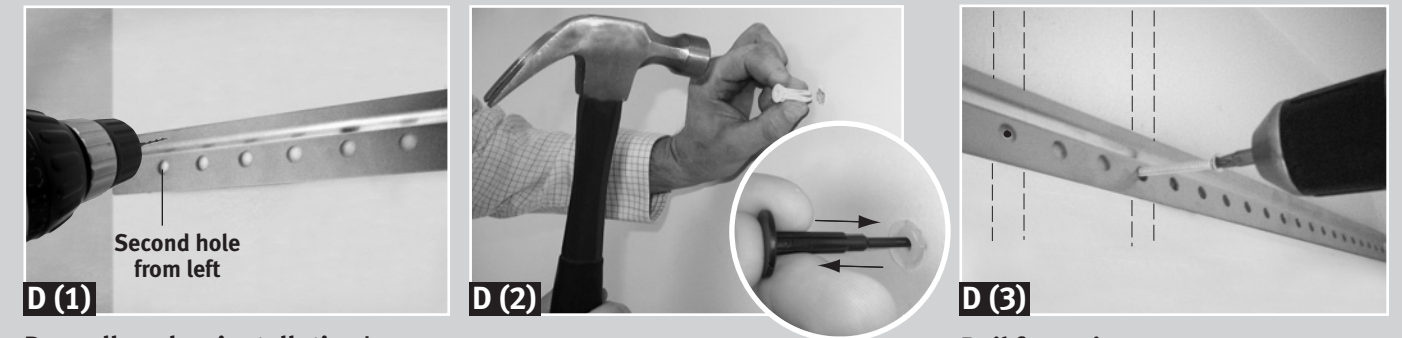

Drywall anchor installation*

Mark and drill a 3/8" hole (for a wall anchor) in the second hang rail hole from the left. To compress the anchor, fold the sides and bend. Hammer the wall anchor flush to wall in the drilled hole. Insert anchor push pin to engage anchor, then remove.

*Anchors for concrete, plaster or steel wall installation must be purchased separately.

Rail fastening

Starting at left side, fasten the first two screws into studs (or anchors). *Do not fasten remaining screws until after next step.*

Note: Screws need to be fastened through rail into each wall stud spaced no more than 24" apart.

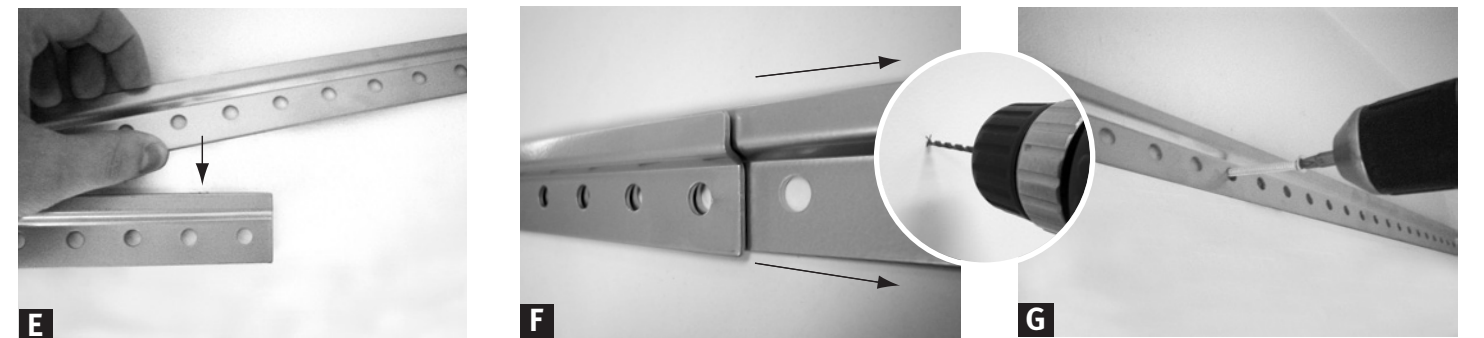

E Position second hang rail if closet space is wider than 3'

Slide second hang rail down behind the first from above.

F Extend second hang rail

Slide second hang rail as far right to the wall as possible while still maintaining hole alignment. Repeat step C to secure to the wall. If there is **not** a stud within 4" of the RIGHT end of the hang rail, repeat the **dry wall anchor installation** step above.

G Secure second rail from right side

Install screws into studs (or anchors) along rails. Secure rail in all studs.

2 Plan Your Layout

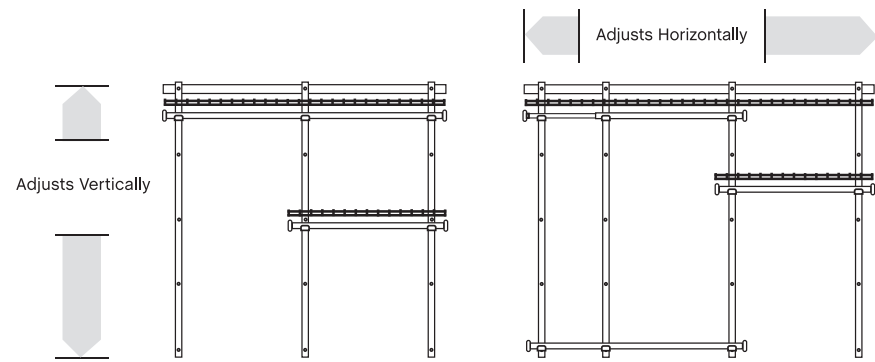

Before securing uprights, be sure to assess your storage needs. If you are using Homefree accessories, be sure to place your uprights at 22" apart and ensure drawers or sliding baskets have adequate space.

3 Hang Uprights



Hang uprights
Hang first two 47.5" uprights over the hang rail.

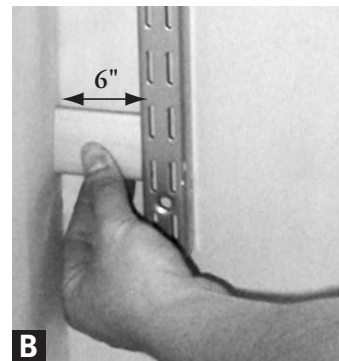

Position at 6"
Position both outside uprights 6" from the right and left corners by using the 6" rail cover for spacing.



Secure
Mark bottom hole of each upright. Drill 1/8" pilot hole into stud. (Use wall anchor and 3/8" bit if there is no stud.)

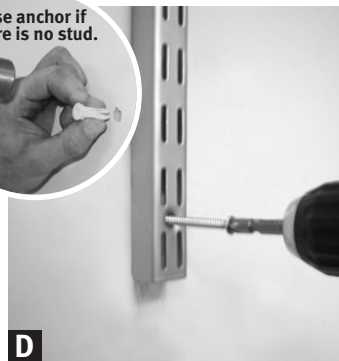

Fasten at bottom
Fasten screws into studs or wall anchors. Screws are needed only in bottom holes of uprights.

►Hint: If the left side of closet is more accessible, space the remaining uprights from left to right. If the right side of the closet is more accessible, space the remaining uprights from right to left.

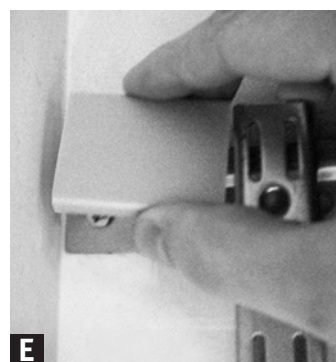

Attach 6" rail cover
Clip 6" rail cover over hang rail so uprights stay in place.

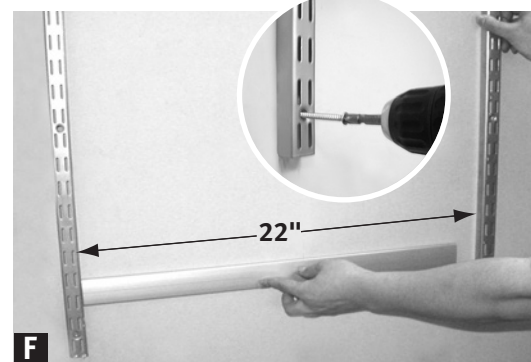

Use 22" rail cover for spacing
Hang another 47.5" upright on the rail and use one of the 22" rail covers to space over 22". Drill 1/8" pilot hole and fasten screws in bottom hole. (Use wall anchor and 3/8" bit if there is no stud.) Place 22" rail cover over rail between uprights. Repeat step F for additional upright (if space allows).



Attach 22" rail cover
If the space between the last uprights is less than 22", you may choose to cut rail cover with scissors to fit. **Note: Add-on accessories require uprights to be placed at 22" apart.**

►Hint: determine the placement of your shelves and hang rails. Start from the top and work your way down to ensure that you have enough room.

4 Install Brackets and Expanding Shelves



Insert brackets
Insert brackets into uprights at desired locations. **Note: Install brackets and shelving at the top first and work down. Brackets will not fit into upper two slots of each upright.**

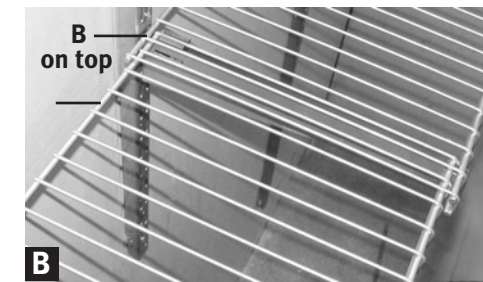

Overlapping shelves
Shelves are adjustable and require no cutting. To adjust width, overlap the shelves making sure the shelf labeled "A" is placed first on the brackets and the shelf labeled "B" is placed on top of "A".



Install shelves into brackets
Confirm that the bracket locks are unlocked and install shelving making sure that the "nose" of the bracket is projecting out through the front edge of the shelf. **Note: For maximum weight capacity, do not insert brackets into bottom slots of upright.**

►Hint: When overlapping sections of shelving, shelves labeled "A" must be placed onto brackets before shelves labeled "B".

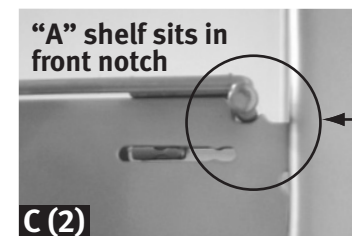

Place shelves onto brackets
Shelf labeled "A" sits in front notch of bracket. Shelf labeled "B" sits in back notch. Be sure each shelf slides back as far as possible before locking shelves into brackets. If overlapping three sections of shelving, use two "A" sections and one "B" section, placing "A" sections on the outside and spanning the gap with "B" sections. For four or more overlapping sections, continue alternating between "A" and "B" sections, placing "A" shelves on brackets before "B" shelves.

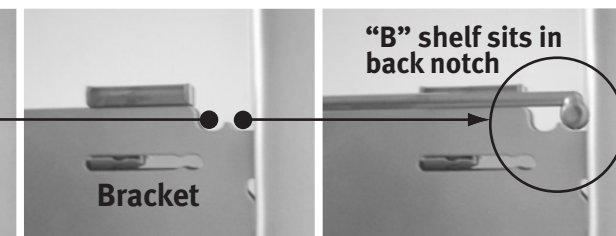

Secure shelves with bracket locks
After all shelves are positioned properly, lock shelves into brackets by sliding the plastic locking clip toward the back wall. It will "snap" into locked position.

►Hint: If shelves are installed in the incorrect notch, shelving weight capacity could be lessened.

5 Install Adjustable Clothes Rods

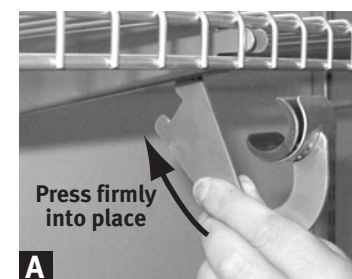

Install rod hanger
Install rod hanger into bottom of bracket by tilting it backward until it locks in place. **Note: Be sure to press rod hangers firmly into place for proper installation.**

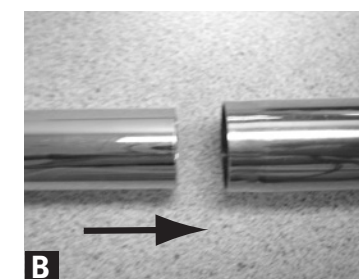

Adjust rod length
Rods can be used separately or telescoped together. 36" rods telescope up to 6' and 26" rods telescope up to 4'.

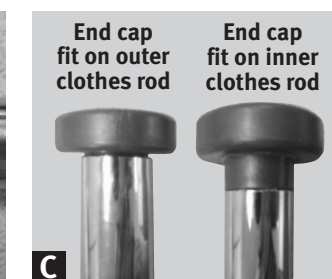

Add end caps
Place end caps on the end of each clothes rod. End caps will fit either diameter of rod (as shown above).

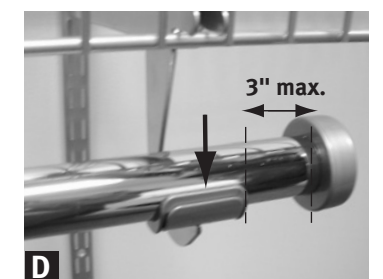

Secure rod and hanger
After expanding clothes rod to desired length, place into rod hangers and press down to snap into place. **Note: Do not extend more than 3" past rod hangers.**