

PYLE®

**Bluetooth Mini Blue Series Stereo Power Amplifier,
2 x 120 Watt, USB Charge Port, USB/SD Memory Card Readers,
RCA and AUX (3.5mm) Input Connector Jacks, Remote Control**

MODEL:PCAU48BT



PYLE®

718.535.1800 718.236.2400(fax)
1600 63rd Street, Brooklyn NY 11204

USER MANUAL

FOREWORD

Your New Pyle Amplifier gives you the power and versatility you need in a professional sound system. The amplifier's wide frequency response makes it suitable for amplifying music or vocal program material. It can be used in meeting halls, house, restaurant, schools, stores, or for paging systems.





PCAU48BT features a PAGER-MIXING function that offers the flexibility of using it at paging or musical events.

Please read this manual thoroughly before you attempt to set up and use the amplifier. It contains a range of installation suggestions as well as instructions to ensure safe usage.

Installed properly, you can expect years of trouble-free service from this product.

TABLE OF CONTENTS

1. Features and Controls
3. Caring for your Pyle Pro Amplifier
5. Limited warranty
6. Specifications

	CAUTION RISK OF ELECTRIC SHOCK DO NOT OPEN		WARNING: To reduce the risk of fire or shock hazard, do not expose this product to rain or moisture
CAUTION: TO REDUCE THE RISK OF ELECTRIC SHOCK, DO NOT REMOVE THE COVER OR BACK. NO USER-SERVICEABLE PARTS INSIDE. REFER SERVICING TO QUALIFIED PERSONNEL.			
	The lightning symbol is intended to alert you to the presence of uninsulated, dangerous voltage within this product's enclosure that might be of sufficient magnitude to constitute a risk of electric shock. Do not open the product's case.		
	The exclamation symbol is intended to inform you that important operating and maintenance instructions are included in the literature accompanying this product.		

FEATURES AND CONTORLS

FRONT PANEL

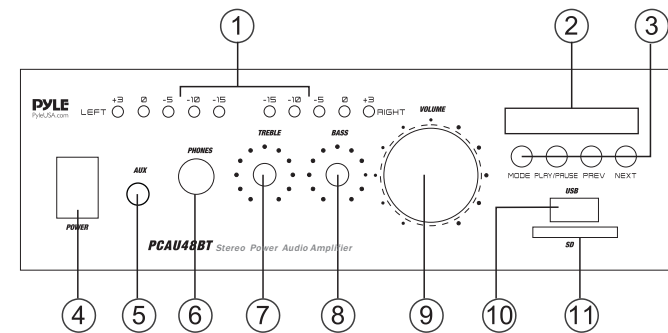

1. Blue LED Output Level Indicators
2. Blue LED Display Window for MP3/Bluetooth Function.
3. Buttons for Bluetooth/MP3(USB and SD) Function Control.
 - MODE Button: For audio selection like BLUETOOTH/USB/SD/LINE IN
 - PLAY/PAUSE Button: For play and pause control
 - Prev,/Next: For quick backward or next song
4. Main Power on Switch
 - The amplifier is switched ON or OFF by using this switch.
5. Line input. AUX CD IN
 - Lets you easily connect the computerized MP3 Device player sources such as PC CD ROM laptop walkman iPod and cell phone.
6. 1/4" PHONE JACK
 - Accepts headphones with 1/4" plug
7. 8. BASS AND TREBLE TONE CONTROL
 - Lets you boost or attenuate bass and treble for the desired sound.
9. Master Volume Control
 - Lets you adjust the overall sound level turn the knob clockwise to increase the volume.

BACK PANEL

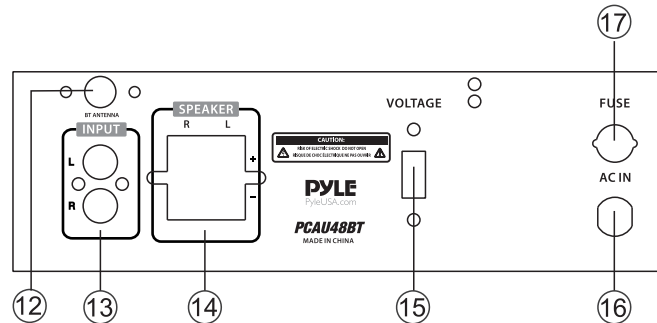

10.USB Charge Port & USB Reader Function

-USB port charges for smartphone and also for USB reader function.

11.SD/MMC Socket for playing SD/MMC cards.

12.Bluetooth Antenna

-The antenna is best receiving for Bluetooth operation.

13.RCA L/R LINE Input

-Let you connect to the desired LINE input sources.

14.Push Type Speaker L R Terminals

Let you easily connect the speakers' wires directly to the amplifier

15. 110V 220V Switch

According to power voltage push this button to the correct station of the 110V or 220V.

16. AC IN Power Cord

-Connect to AC 110V 60Hz or 220V 50Hz

17.Fuse

The amplifier uses a fuse for protection against surges and short circuit. If the amplifier suddenly turn off and will not turn on check the fuse. If necessary replace it with a 1 amp 250 volt fast acting 5x20mm fuse not supplied

REMOTE CONTROL FUNCTION

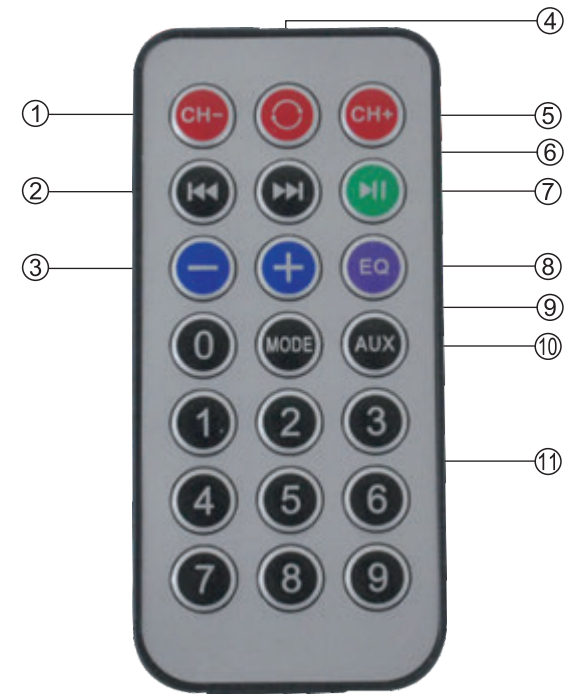

1. PREVIOUS STATION

2. Previous Song Button

3. Volume Buttons

4. REPEAT FUNCTION

5. NEXT STATION

6. Next Song Button

7. Play/Pause Button

8. Equalizer Button

9. Mode Menu Control Button

Press it for audio input selection like Bluetooth/USB/SD/LINE IN, etc.

10. AUX Input

11. Number Buttons for Song Selection

BLUETOOTH FUNCTION INSTRUCTION

External devices which have a built in Bluetooth feature can be connected to this amplifier wirelessly to play through the amplifier's speakers.

1. Be sure that the amplifier is powered on. And it's better to pull the Bluetooth Antenna on at the back of panel for better receiving. Press MODE button until the display screen displays the word bLUE. (The unit is automatically ready to pair with your device)
2. Turn on the Bluetooth function of your external device.
3. Search for available devices within range of your external Bluetooth device.
4. Wait for a while then find the "TD301-RY" on the paired devices list on your external device and select "TD301-RY" or find the "BT" on the paired devices list on your external device and select "BT".
5. Your amplifier will beep and the lights will flash once when pairing is a success.
6. You can now play music and other audio on your external device through your amplifier.
7. The amplifier will beep and the lights will flash once again when the external device is turned off or unpaired.

CARING FOR YOUR PYLE AMPLIFIER

Your Pyle Amplifier is an example of superior design and craftsmanship. The following suggestions will help you care for your amplifier so you can enjoy years of use :

- *Keep the amplifier dry. If it gets wet, wipe immediately.
- *Use the amplifier only in well-ventilated installations.
- *Handle the amplifier away from dust and dirt.
- *Wipe occasionally with a damp cloth to keep it looking new.

Do not use harsh chemical, solvents or detergents!

IMPORTANT

Replacing a fuse

This amplifier requires a fuse with the proper rating for protection from power surges and short circuits. If the amplifier suddenly turns off or will not turn on. the fuse is properly blown.

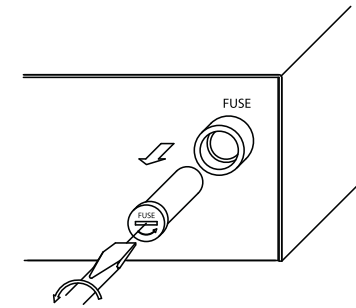

- *Let the amplifier cool down and see if it start again before you assume a fuse needs to be replaced.
- *Unplug the amplifier from the AC outlet.
- *Turn the fuse holder cap and pull out the cap.
- *Remove the old fuse and replace it with an identical one.

CAUTION : Never use a fuse with a higher rating.

TROUBLE SHOOTING

No power	The fuse might be blown.	Check the amplifier's fuse and replace it if necessary.
No sound	Sound source or speakers may not be connected properly.	Check all connections.
	Master volume control may be set to a minimum.	Adjust the volume control to a higher setting.
	The speaker's wire might be the wrong impedance.	Make sure that the speakers that you have connected to the amp are matching in impedance.
Feedback	The amplifier is shutting down or powering off	Turn the amplifier off and let it cool, make sure that the amplifier is properly ventilated, and then turn it back on.
	Microphone and speakers are too close together	Reposition the microphone and speakers