

**ParkPower**<sup>®</sup>  
by Marinco<sup>®</sup>

*Progressive  
Industries*

Detachable Power / DC Management / Surge Protection / Power Conversion / Ventilation



2022 PRODUCT CATALOG





For decades ParkPower, Progressive Industries, Blue Sea Systems, On Board Solutions, Marinco, and Mastervolt have worked independently to provide innovative electrical products. Now the six companies are working together to offer comprehensive electrical solutions for RV applications.

## Providing more than products. Providing Solutions.

This catalog represents the top offerings of each company designed for the rigors of the road.



AC Detachable Power, DC Power Connection, and Accessories



All of the company's products are designed to easily integrate into simple or comprehensive electrical systems. The world's leading RV manufacturers are recognizing the requirement for quality electrical systems and are specifying our products as original equipment.

The challenge, and our promise, is to leverage the deep product understanding in each of our companies with coordinated product development and industry-leading customer service and support.

Proud Members of:







# What makes ParkPower® different:

## Innovation & Engineering

ParkPower engineers and manufactures a range of high quality electrical solutions designed for the harsh environment. Every product meets exacting performance specifications and is designed to withstand extreme conditions.

## Selection

Over 200 electrical products are designed to work together as a system

## Fast Delivery

Products stocked in multiple global locations ensures rapid order fulfillment

## Worldwide Access to Product

A distribution network in over 45 countries provides access to products when they are needed

## Industry Standards

Industry involvement ensures products meet multiple standards

## Quality

Product quality is managed in a consistent manner with international standards

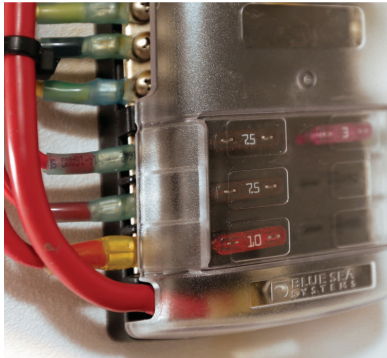



# NEW Products

*Progressive Industries*



37

## Portable Surge Protector Kits

Portable surge protector kits contain a separate receptacle tester to detect wiring faults at the pedestal and surge module to attach to the detachable power cord. Separating the two functions reduces the size of the product while increasing protection from inclement weather. Kit contains receptacle tester and surge module.



CBA-5015

41

## Resettable Circuit Breaker Adapter

50A RV male to (2) 15A female resettable circuit breaker adapter provides 2 resettable 15A receptacles from a 50A pedestal. This adapter is designed for 30A RV users that do not want to draw additional power from their 30A or 15A service which may trip breakers at the pedestal. Each 15A receptacle is wired independently to an illuminated circuit breaker making it the safest and easiest to use solution for additional 15A power. The compact design allows the electrical box to close and makes it optimal for use with power strips and extension cords.



37

## RV Receptacle Testers

Receptacle testers detect wiring faults at the pedestal, including open ground, open neutral, open hot, hot/neutral reversed and hot/ground reversed. Includes swivel handle for easy removal from the pedestal.



37

## RV Surge Modules

Surge modules attach to the detachable power cord to provide surge protection. The compact size increases protection from inclement weather. Contains surge protection indicator alerting user when depleted.

### Surge module ratings:

- 30A: 22,500A max spike / 1,100 joules
- 50A: 45,000A max spike / 2,030 joules





**ParkPower**  
by Marincó



13

TVHDMI6574.B

**TV & HDMI Inlet**

TV & HDMI Inlet provides HDMI and cable TV connectors in one housing, reducing space on the RV. This inlet is designed with all the same features common in ParkPower inlets, such as UV stabilized glass-filled polyester construction for long-lasting strength and a soft touch cover.

- Soft touch covers are designed to stay hinged open when the cover is lifted up. A soft touch unlocks it for closing.
- Extra large tab provides more area to simplify opening and closing

**MASTERVOLT**



66

**CombiMaster Inverter/Charger — CZone®/MasterBus Compatible**

The CombiMaster inverter/charger delivers pure sine wave inverter power and multi-chemistry battery charging plus the intelligent new design communicates seamlessly with NMEA 2000.

- 35512000 12/2000-100 120V
- 35513000 12/3000-160 120V

**Weekender**  
by ParkPower



503030YA

31

**Y Adapter**

50A Male To (2) 30A Female provides two female RV receptacles from a 50A RV power source. Heavy-duty STW cable for outdoor use with molded ends with handles on female end and male ends.



30153GPA

32

**Generator Pigtail Adapter**

30A Male To (3) 15A Female provides three 15A receptacles from a 30A generator receptacle. The clear, illuminated end provides visual feedback that power is present. Heavy-duty STW cable for outdoor use with molded ends with clear 15A end with LED indication on female end.



33

**Portable Surge Protectors**

Weekender portable surge protectors provide surge protection and detect wiring faults at the pedestal. The compact footprint and intuitive design simplify storage and usage.

- Open ground, open neutral & reverse polarity detection
- Mis-wired pedestal indication
- Surge failure indicator
- Brighter 3-color LED indicators
- Weekender pull handle
- Weather resistant /designed for outdoor use

**Surge ratings:**

- 30A: 22,500A max spike / 825 joules
- 50A: 45,000A max spike / 1,650 joule



# Table of Contents

## DETACHABLE POWER PARKPOWER®

Inlets	12
Cable TV / Internet	15
Conversion Kits	16
Cordsets	17
Locking Extension Cords	19
Cordset Accessories	20
Adapters	21
Replacement Plugs & Connectors	25
Plugs, Connectors & Accessories	26



## DETACHABLE POWER WEEKENDER®

Inlets	30
Detachable Power Cords	30
Extension Cords	30
Pigtail Adapters	31
Single Piece Adapters	32
Straight-Blade Adapters	32
Dogbone Adapters	33
Generator Adapters	34
Dead Front Receptacles	35
Portable Surge Protectors	35
Planogram Assortment	35

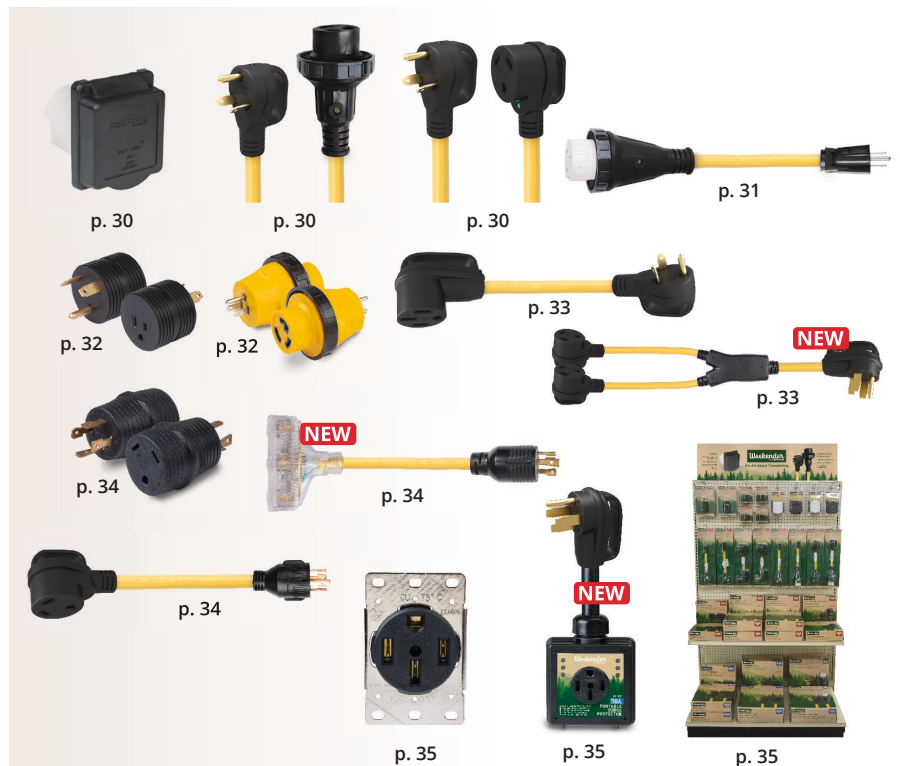

## SURGE PROTECTION

Surge Protector Selector Guide	38
Portable Surge Protector Testers & Modules	39
Portable Surge Protectors	40
Hardwired Surge Protectors	42
Accessories	43



## DC MANAGEMENT

Battery Switches	46
Automatic Charging Relays	49
BusBars	52
Connectors & Insulators	53
Battery Terminal Mount	54
Fuse Block & Kit	54
Fuses	55
Fuse Holders	56
Fuse Blocks	57
Circuit Breakers & Circuit Breaker Panels	60
4.8V Dual USB Chargers	61
DeckHand Dimmers	61
Mini OLED DC Voltmeter	61
12 Volt Accessories	62
ProSport Power Inverter	63



## POWER CONVERSION

Pure & Modified Inverters	66
CombiMaster Inverter/Charger	68



## VENTILATION

Ventilation Explained	73
Solar Vents	73



## INDEX

Part Number Index	74
-------------------	----



# DETACHABLE POWER

## Inlets



ParkPower Inlets are the industry standard. Offered in three styles, featuring robust construction and corrosion-resistant materials for long life in the harsh marine environment. All inlets have an IP56 rating.

## Conversion Kits



Includes everything needed to convert hard wired RV hook-up to detachable power. Available in 30A or 50A kits.

## Cordsets



All ParkPower cordsets are made of the highest quality, construction, and materials. They include innovative, ergonomic features that you will not find on other power cords.

## 15A Marine Grade Locking Extension Cords



15 Amp extension cords contain a universal slide locking mechanism to prevent cable disconnection. Available in 25' and 50' lengths.





# DETACHABLE POWER PARKPOWER®

## Cordset Accessories



18 ParkPower has the accessories you need to organize, store, and carry your RV detachable cordsets.

## Adapters

19

ParkPower detachable adapters allow you to use a variety of RV Park, storage, or home electrical service options.



## Replacement Plugs & Connectors

23



With tough glass filled nylon construction, our replacement plugs and connectors are designed for harsh environments. Wide grip handles allow easy and safe removal from outlets.

## Plugs, Connectors & Accessories

24



ParkPower provides a wide range of accessories to seal and weatherproof your detachable power components.





## Inlets

ParkPower® power inlets are the industry standard. Offered in three styles, they all feature robust construction and corrosion-resistant materials for long life in the harsh environments. Each has technical features that make them easy to install and a pleasure to use.

### 5 YEAR WARRANTY



#### Standard

ParkPower standard inlets feature UV stabilized glass-filled polyester construction for long-lasting strength.



#### Contoured

ParkPower contoured inlets feature UV stabilized glass-filled polyester construction for long-lasting strength.



#### Stainless Steel

ParkPower stainless steel inlets are solid cast marine grade 316 stainless steel and include a heavy duty cap strap for strength and durability.



Easy Lock™ Sealing Ring  
(sold separately)  
page 25

- 1 Easy Lock™—ParkPower’s exclusive Easy Lock™ System has been designed to connect the cordset (with an Easy Lock™ sealing ring installed) to the inlet and turn the locking ring less than a quarter turn. The tabs on the locking ring lock into the inlet for a positive watertight hook-up while eliminating any chance of cross threading. Easy Lock™ inlets have a threaded boss that will accept standard threaded cordsets as well.
- 2 The covers on all ParkPower inlets are designed to stay hinged open when the cover is lifted up. This allows the RV'er to connect their detachable power cord while the cover remains open and out of the way. A soft touch unlocks it for closing.
- 3 Blades are nickel plated brass for maximum corrosion resistance.
- 4 Interior hardware is high grade stainless steel.
- 5 **IMPROVED** Extra large tab provides more area to simplify opening and closing.
- 6 **IMPROVED** Rear Enclosure
  - Made of flame-resistant UL94V0 plastic
  - All rear enclosures are glass-filled polyester for strength
  - Integral strain relief
  - Multiple positions allow for maximum installation flexibility



Adjustable strain relief allows you to install cable extending straight out or at a 90 degree angle

side view

**30A**  
125V

**30 Amp 125V Power Inlets**



**Power Inlet**

- White with Stainless Steel Trim

301ELRV

301ELCB cap & bezel



**Power Inlet**

- Gray with Stainless Steel Trim

301ELRV.G



**Power Inlet**

- Black with Stainless Steel Trim

301ELRV.BLK



**Contour Power Inlet**

- White with Stainless Steel Trim

304EL-BRV



**Contour Power Inlet**

- Gray with Stainless Steel Trim

304EL-BRV.G



**Contour Power Inlet**

- Black with Stainless Steel Trim

304EL-BRV.BLK



**Stainless Steel Power Inlet**

- Cast 316 Stainless Steel

303SSEL-BRV



**Replacement Interior**

- Fits 303SSEL-BRV & 301EL-BRV inlets

305CRMB

**TECH TIP**

**Exclusive Perma-Lock™ Terminal Tightening**

As the screw goes down, the collar locks up: As the terminal screw tightens down on the contact tang, it compresses the wire underneath the tang, causing the screw to exert an upwards lift on the collar overleaf. This lifting action “locks up” the screw’s threads. Heat cycling and vibration cannot loosen the screw, and stress relief is virtually eliminated.

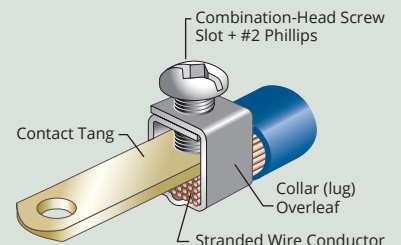



50A  
125/250V

## 50 Amp 125/250V Power Inlets

**Power Inlet**

- White with Stainless Steel Trim

6353ELRV  
6353ELCB

cap &amp; bezel

**Power Inlet**

- Gray with Stainless Steel Trim

6353ELRV.G

**Power Inlet**

- Black with Stainless Steel Trim

6353ELRV.BLK

**Contour Power Inlet**

- White with Stainless Steel Trim

6344EL-BRV

**Contour Power Inlet**

- Gray with Stainless Steel Trim

6344EL-BRV.G

**Contour Power Inlet**

- Black with Stainless Steel Trim

6344EL-BRV.BLK

**Stainless Steel Power Inlet**

- Cast 316 Stainless Steel

6373EL-BRV

**Replacement Interior**

- Fits 50A 125/250V Easy Lock 4-wire stainless steel or standard inlets manufactured after 8-1-93

6373ELMB

**TECH TIP****Exclusive Perma-Lock™ Terminal Tightening**

As the screw goes down, the collar locks up: As the terminal screw tightens down on the contact tang, it compresses the wire underneath the tang, causing the screw to exert an upwards lift on the collar overleaf. This lifting action "locks up" the screw's threads. Heat cycling and vibration cannot loosen the screw, and stress relief is virtually eliminated.

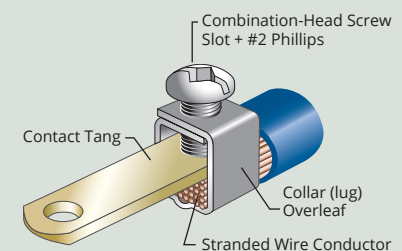

## 15 Amp & 20 Amp 125V Power Inlets



**15A**  
125V

### 15 Amp Power Inlet

- UV resistant housing and cap

150BBI.RV    black  
150BBIW.RV    white



15A 125V  
Straight Blade



**20A**  
125V

### 20 Amp Power Inlet

- UV resistant housing and cap

200BBI.RV    black  
200BBIW.RV    white



20A 125V  
Straight Blade

**5 YEAR WARRANTY**

Cable  
TV  
Internet

## Cable TV / Internet



### Cable TV / Internet Inlet

- Your choice of white or gray with stainless steel trim

TV6574.RV    white  
TV6574.RV.G    gray



### Dual Cable TV / Internet Inlet

- Your choice of white or gray with stainless steel trim

TV6574D.RV    white  
TV6574D.RV.G    gray



### TV & HDMI Inlet **NEW**

- black

TVHDMI6574.B



### Cable TV Outlet

- Spring-loaded lift cover
- Weatherproof closure
- Fits FS & FD boxes

TV97



### HDTV / Internet Cable

- 50 ft yellow cable
- 75 ohm, 3GHz RG6 Quad Shield cable
- Weatherproof F-type connections on both ends

TVHDRV





## Establishing a quick hook up

ParkPower® makes hooking up your RV's electrical service much easier. The ParkPower detachable power system uses the same rugged components developed for marine use. At the core is the ParkPower inlet and connector with weatherproof cover. After installing the inlet on the side of the RV, the original power cord that came with the RV can be modified by installing the connector and cover on the severed end. Detachable power allows you to use a variety of power cords and adapters to make hook-up easier. All components are of the highest quality construction and are built to give years of service. ParkPower stands behind our electrical products with a 5 year warranty. Easy to follow installation instructions make conversion to detachable power a snap.



**30A**  
125V

### 30 Amp Conversion Kit

Converts 30A hard wired RV power hook-up to detachable power hook-up.

- Includes everything needed to complete the conversion:
  - 304EL-BRV 30A contoured power inlet
  - 305CRV 30A female connector (installs to RV power cord)
  - 103RV comfort grip weatherproof cover with threaded ring
  - Mounting adapters and gaskets
  - Electrical box
- Easy to install
- Easy Lock™ system
- High quality corrosion resistant construction
- Circular metal ring covers the opening left by the removal of the access port door
- Strain relief
- Easy to follow installation instructions

30ARVKIT kit with white inlet  
30ARVKIT.BLK kit with black inlet and rings



**50A**  
125/250V

### 50 Amp Conversion Kit

Converts 50A hard wired RV power hook-up to detachable power hook-up.

- Includes everything needed to complete the conversion:
  - 6344EL-BRV 50A contoured power inlet
  - 6364CRV 50A female connector (installs to RV power cord)
  - 7715CRV weatherproof cover with threaded ring
  - Mounting adapters and gaskets
  - Electrical box
- Easy to install
- Easy Lock™ system
- High quality corrosion resistant construction
- Circular metal ring covers the opening left by the removal of the access port door
- Strain relief
- Easy to follow installation instructions

50ARVKIT kit with white inlet  
50ARVKIT.BLK kit with black inlet and rings

**5 YEAR**  
**WARRANTY**

## RV EEL Cordsets

One Hand. A simple twist. Full Power.

The RV EEL (Easily Engaged Lock) Detachable Cordset has a patented, industry first, jaw-clamp design that provides one-handed operation and a secure waterproof seal, eliminating the need for a locking ring. Built for the harshest environments, the RV EEL connection is UL listed. Best of all, it works with your current inlet. The plug end of the cord features a large grip handle that provides a safe connection and is movable so the electrical box can be closed. In addition to cordsets with RV EEL technology, ParkPower® also offers a full range of pigtail adapters featuring the new RV EEL technology.

### RV Connection End

- EEL Jaw clamp technology—Eliminates locking ring
- LED power indicator
- Secondary lock for added security
- Cord light
- Water-tight seal
- Works with your current inlet

### Power Connection End

- Large Grip Swivel handle allows box cover to close
- Keeps hand away from dangerous high voltage contacts
- Easier to insert and remove electrical plug
- Meets and exceeds rigorous UL testing standards
- 30 Amp and 50 Amp cordset models in 25' lengths
- RV EEL product line includes connectors, pigtail and straight adapters



Length	Color	Part #
<b>30 Amp 125V Cordsets</b>		
25'	yellow	CS30-25RV
<b>50 Amp 125/250V Cordsets</b>		
25'	yellow	CS504-25RV

### PARK SIDE

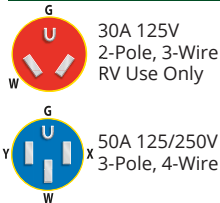

### RV SIDE

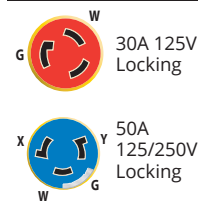

swivel handle



CS30-25RV



## Cordsets

All ParkPower® cordsets are made of the highest quality construction with features you won't find on other power cords.

- Watertight molded plug and connector for safety and durability
- Heavy duty, super flexible marine-grade cable (30 amp 10 gauge, 50 amp 6 gauge)
- All models include a standard threaded ring for hook-up to ordinary threaded inlets
- Durable, bend resistant contacts
- **Power Indicator Light:** RV side connector features a molded-in LED light. When it glows red, you know you have power to the RV.
- **Contour Grip with Thumbprint Locator:** Both plug and connector ends are molded to fit the contour of your hand. When the thumbprint is in the 11 o'clock position, the blades line up for easy connection.
- **Swivel Head Handle:** Large Grip Swivel handle allows box cover to close. Keeps hand away from dangerous high voltage contacts. Easier to insert and remove electrical plug. Meets and exceeds rigorous UL testing standards.
- **ParkPower's Easy Lock™ system:** quickly locks the cord set to the inlet in just 1/8 of a turn. The tabs on the locking ring lock into the inlet for a positive watertight hookup. The exclusive locking tabs engage slots built into all ParkPower inlets. (sold separately)



Length	Color	Pkg	Part #
<b>30 Amp Cordsets</b>			
25 ft	yellow	sleeve pack	25SPP.RV
25 ft	gray	sleeve pack	25SPPG.RV
30 ft	yellow	sleeve pack	30SPP.RV
30 ft	gray	sleeve pack	30SPPG.RV
36 ft	yellow	sleeve pack	36SPP.RV
36 ft	gray	sleeve pack	36SPPG.RV
50 ft	yellow	sleeve pack	50SPP.RV
50 ft	gray	sleeve pack	50SPPG.RV
<b>50 Amp Cordsets (4-Wire)</b>			
25 ft	yellow	box	6152SPPRV-25
25 ft	gray	box	6152SPPGRV-25
36 ft	yellow	box	6152SPPRV-35
36 ft	gray	box	6152SPPGRV-35
50 ft	yellow	box	6152SPPRV-50
50 ft	gray	box	6152SPPGRV-50



### Contoured Grip



### Easy Lock™ System



### PARK SIDE

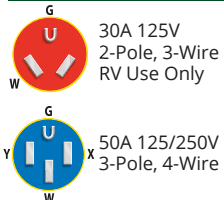

### RV SIDE

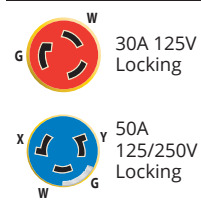

Easy Lock™ Sealing Ring  
(sold separately)  
page 25

## Generator Cordsets

All ParkPower® cordsets are made of the highest quality, marine grade construction with features you won't find on other power cords.

- 1 Watertight molded plug and connector for safety and durability
- 2 Heavy duty, super flexible marine grade cable (30 amp 10 gauge)
- 3 All models include a standard threaded ring for hook-up to ordinary threaded inlets
- 4 Corrosion resistant, nickel plated contacts
- 5 Power Indicator Light: RV side connector features a molded-in LED light. When it glows red, you know you have power to the RV.
- 6 Contour Grip with Thumbprint Locator: Both plug and connector ends are molded to fit the contour of your hand. When the thumbprint is in the 12 o'clock position, the blades line up for easy connection.
- 7 ParkPower's Easy Lock™ system: Quickly locks the cord set to the inlet in just 1/8 of a turn. The exclusive locking tabs engage slots built into all ParkPower inlets (sold separately).

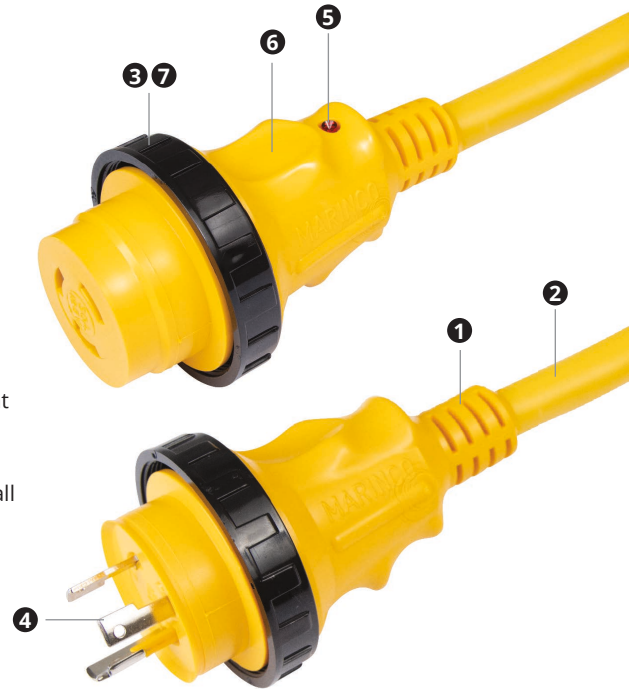

Length	Color	Pkg	Part #
<b>30 Amp Generator Cordsets</b>			
12 ft	yellow	sleeve pack	<b>12GENC</b>
25 ft	yellow	sleeve pack	<b>25GENC</b>
50 ft	yellow	sleeve pack	<b>50GENC</b>



RESISTANT



MORE FLEXIBLE



LIGHTER

**5 YEAR WARRANTY**



### TECH TIP

#### Power Cord Extension

ParkPower generator cordsets can also be used as a detachable power cord extension. Simply connect the male end of the generator cord to the female end of the detachable power cord using the included sealing collar. The generator cord connects between the inlet and female end of the detachable power cord.

Generator Cord

Detachable Power Cord



### Related Products



Generator Male Plug  
page 24

## 15A Marine Grade Extension Cords

- Marine grade SJTOW cable
- Clear ends with lighted female end for visual power indication on 14/3 models
- Female end contains slide button lock for protection against cable disconnection\*
- Slide button lock compatible with all other manufacturers' products\*
- ETL certified to UL standards

Cable	Length	Description	Part #
14/3	25'	Locking and Lighted	150025RV
	50'	Locking and Lighted	150050RV
12/3	25'	Heavy-duty	151225RV
	50'	Heavy-duty	151250RV

\*150025RV and 150050RV models only

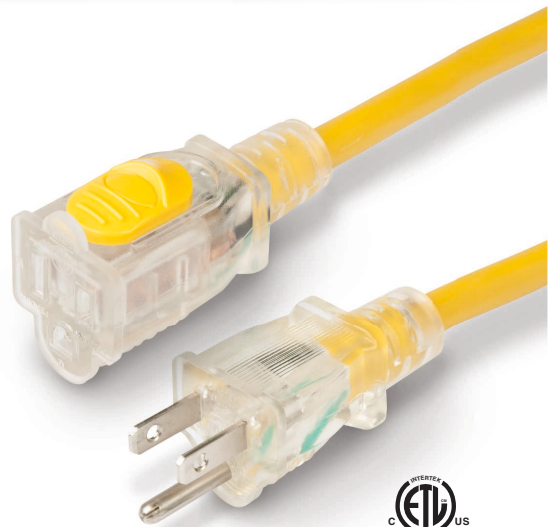



## Cordset Accessories



### Cordset Carrying Strap

Bundle and organize your power cables or hoses with this durable and flexible nylon carrying strap. The adjustable design fits around cord sets or hoses up to 9" in diameter, while the ergonomic, rubber handle makes carrying even larger 50 amp cord sets easy on your hand. A metal, reinforced grommet allows for hanging and storage.

STRAP



### Organizer Bag

- Heavy duty nylon zippered bag with handle
- Velcro® fasteners grip closure and mesh vents
- Ideal for storing cordsets and adapters
- Dimensions: 21"L x 14-1/2"H x 8-1/2"W

BAG.RV

Velcro® is a registered trademark of Velcro Industries, B.V., Netherlands

## 30 Amp Go Anywhere™ Kit

Kit containing two adapters that allow detachable power users the flexibility to connect to the most common power pedestals.

- 30A users can connect to 15A and 50A pedestals
- Includes 5030ARV straight-blade adapter and S15-30RV generator adapter

30GOA



## 50 Amp Go Anywhere™ Kit

Kit containing two adapters that allow detachable power users the flexibility to connect to the most common power pedestals.

- 50A users can connect to 15A and 30A pedestals.
- Includes 3050ARV straight-blade adapter and S15-50RV generator adapter

50GOA



## Adapters

No matter what your RV's power needs are, ParkPower® detachable adapters allow you to use a variety of RV park, storage or home electrical service options.

### CSA Approved

ParkPower is proud to announce CSA approval of power adapters for the RV industry. Long known for its breadth and quality of products, ParkPower has obtained approval in its range of 1-piece, pigtail and "Y" adapters for 30 Amp and 50 Amp applications. All approved products now display the CSA logo on the product and packaging.

### Waterproof Sealing Collars

Where indicated, a sealing collar provides maximum moisture protection between connector and cordset.









**5 YEAR WARRANTY**



## Pigtail Adapters

These adapters are equipped with covers and sealing collars (where indicated), and are for use in wet locations.

Part #

104SPPRV			LED Power-on indicator and thumbgrip locator
150SPPRV			LED Power-on indicator and thumbgrip locator
1PCMRV			
124ARV			LED Power-on indicator and thumbgrip locator
124ARV-25 (25 ft)			LED Power-on indicator and thumbgrip locator

### PARK SIDE

**MALE PLUG**  
Attaches to pedestal receptacle or cordset



### RV SIDE

**FEMALE CONNECTOR**  
Attaches to RV inlet or cordset





### RV EEL Pigtail Adapters

These adapters are equipped with sealing collars and are for use in wet locations.



**Part #**

P15-30RV



P15-504RV



P30-504RV-25



#### PARK SIDE

**MALE PLUG**

Attaches to pedestal receptacle or cordset



15A 125V  
Straight-Blade  
w/ Locking  
Screw



15A 125V  
Straight-Blade  
w/ Locking  
Screw



30A 125V  
2-Pole, 3-Wire  
RV Use Only

#### RV SIDE

**FEMALE CONNECTOR**

Attaches to RV inlet or cordset



30A 125V  
Locking



50A 125/250V  
3-Pole, 4-Wire  
Locking



50A 125/250V  
3-Pole, 4-Wire  
Locking

### One-Piece Twist-Lock Adapters

Not recommended for use in wet locations. Includes power LED.

**Part #**

S15-30RV



S15-504RV



S30-15RV



#### PARK SIDE

**MALE PLUG**

Attaches to pedestal receptacle or cordset



15A 125V  
Straight-Blade



15A 125V  
Straight-Blade



30A 125V  
Locking

#### RV SIDE

**FEMALE SIDE**

Attaches to RV inlet or cordset



30A 125V  
Locking



50A 125/250V  
Locking  
w/ Sealing  
Collar System



15 or 20A 125V  
Straight-Blade



## Generator Adapters

ParkPower® RV generator adapters allow you to connect a standard RV cordset to different types of electrical receptacles on portable generators. We offer a variety of RV generator adapters, so you can stay connected when power is needed most.

Part #	Image	PARK SIDE		RV SIDE	
		MALE PLUG Attaches to pedestal receptacle or cordset		FEMALE CONNECTOR Attaches to RV inlet or cordset	
126A		 20A 125V Straight-Blade		 30A 125V RV Use Only	
127A		 20A 125V Locking		 30A 125V RV Use Only	
128A		 20A 125V/250V 4-Prong Locking		 30A 125V RV Use Only	
125A		 30A 125V Locking		 30A 125V RV Use Only	
171ARV		 30A 125V Locking		 30A 125V RV Use Only	
172ARV		 30A 125V/250V Locking 4-Prong		 30A 125V RV Use Only	
173ARV		 30A 125V Locking RV Use Only		 50A 125V/250V RV Use Only	
174ARV		 30A 125V/250V Locking 4-Prong		 50A 125V/250V RV Use Only	

## "Y" Adapter

Part #	Image	PARK SIDE		RV SIDE	
		MALE PLUG Attaches to pedestal receptacle or cordset		FEMALE SIDE Attaches to RV inlet or cordset	
169AYRV		 50A 125V/250V 3-Pole, 4-Wire		 30A 125V 2-Pole, 3-Wire RV Use Only	



### Dogbone Adapters

Extra wide grip handle and 10/3 outdoor use hard-service cable.

Part #



#### PARK SIDE

**MALE PLUG**  
Attaches to pedestal receptacle or cordset

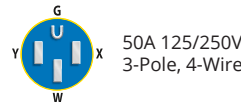

#### RV SIDE

**FEMALE CONNECTOR**  
Attaches to RV inlet or cordset



### Right Angle Cordsets and Adapters

Convert your existing 30A or 50A detachable power cord from a straight connection to a right angle connection. Right angle detachable connections provide minimal cordset protrusion from inlets for more clearance in tight RV spaces and reduces strain at the inlet connection. The GripLock handle design allows easy hook-up and correct blade alignment with the inlet, even in darkness.

Part #

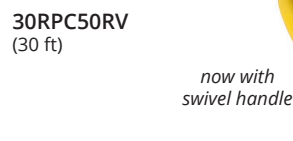

#### PARK SIDE

**MALE PLUG**  
Attaches to pedestal receptacle or cordset

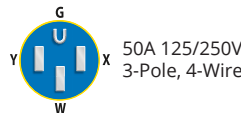

#### RV SIDE

**FEMALE CONNECTOR**  
Attaches to RV inlet or cordset



## Replacement Plugs & Connectors

**5 YEAR WARRANTY**



### Replacement Plug

- Designed for use with 10 gauge, 30 amp RV cable
- Meets NEMA standard TT-30P

30MPRV



### Replacement Connector

- Designed for use with 10 gauge, 30 amp RV cable
- Meets NEMA standard TT-30R

30FCRV



### Replacement Plug

- Designed for use with 6 gauge, 50 amp RV cable
- Meets NEMA standard 14-50P

50MPRV



### Replacement Connector

- Designed for use with 6 gauge, 50 amp RV cable
- Meets NEMA standard 14-50R

50FCRV





5 YEAR  
WARRANTY

## Plugs, Connectors & Accessories

15A  
125V

### Female Connector

- Straight blade

5269CR

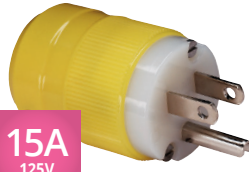
15A  
125V

### Male Plug

- Straight blade

5266CR

20A  
125V

### Female Connector

- Straight blade

5369CR

20A  
125V

### Male Plug

- Straight blade

5366CR

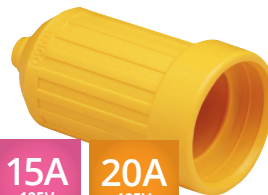
15A  
125V20A  
125V

### Connector Weatherproof Cover

- Use with 5369CR or 5269CR connectors

6018Y

15A  
125V20A  
125V

### Plug Weatherproof Cover

- Use with 5266CR and 5366CR plugs

6017Y

30A  
125V

### Female Connector

305CRV

30A  
125V

### Generator Male Plug

- Twist Lock

30AGENP

30A  
125V

### Connector Cover Kit

- Weather resistant cover

305CRV.VPK

30A  
125V

### Weatherproof Cover w/ Threaded Sealing Ring

- Use with 305CRV

103RV

30A  
125V

### Weatherproof Cover w/ Easy Lock™ Sealing Ring

- Use with 5266CR and 5366CR plugs

103ELRV

**5 YEAR WARRANTY**



**50A**  
125/250V

**Female Connector**

- 3 pole, 4 wire
- 6364CRV



**50A**  
125/250V

**Connector Cover Kit**

- Weather resistant cover
- 6364CRV.VPK



**50A**  
125/250V

**Weatherproof Cover w/  
Threaded Sealing Ring**

- Use with 6364CRV
- 7715CRV



**50A**  
125/250V

**Weatherproof Cover w/  
Easy Lock™ Sealing Ring**

- Use with 6364CRV
- 7715ELRV



**Easy Lock™ Sealing Ring**

- Use with 30 or 50 amp ParkPower inlets
- 100ELRV 30 amp  
500ELRV 50 amp



**Threaded Sealing Ring**

- Use with 30 or 50 amp systems
- 100R 30 amp  
500R 50 amp



**Sealing Collar w/  
Threaded Ring**

- Provides maximum moisture protection between cordset and adapter
- Use with 20, 30 & 50 amp locking systems

110R 20/30 amp  
510R 50 amp

**TECH TIP**

**Weatherproof Protection**

ParkPower® recommends using a weatherproof cover when replacing any male plug or female connector. A weatherproof cover protects the cord and the plug or connector from moisture and other environmental hazards. This increases the longevity of the cord while also allowing a threaded ring to be used with the female connector. The threaded ring on the female connector ensures a weatherproof connection to the inlet for a safe, secure connection to the RV.



# DETACHABLE POWER

## Inlets

28



Weekender® by ParkPower Inlets are the industry standard. ParkPower® OEM grade quality. They feature robust construction, corrosion resistant, UV stable materials for a long life in harsh environments. They include features that make them simple to install and use.

## Detachable Power Cords

28



Connect between an inlet and a power source to provide power to the RV. Extra wide grip handles, LED indicator lights and outdoor use hard-service cable for quality, durability, and UV resistance. The included locking ring creates a watertight seal between the power cord and the inlet.

## Extension Cords

28



Connect between a power cord and a power source to extend existing power cords. Extra wide grip handles, LED indicator lights and outdoor use hard-service cable for quality, durability, and UV resistance.

## Pigtail Adapters

29



Connect between an inlet and a power cord to resolve power incompatibility issues. Extra wide grip handles, LED indicator lights and outdoor use hard-service cable for quality, durability, and UV resistance. The included locking ring creates a watertight seal between the adapter and the inlet.

**Weekender®**  
by ParkPower®

## It's All About Connecting

Wherever the road takes you, from a cross country journey to a casual getaway, when it comes to detachable power, we have what you need. ParkPower® is the industry leader in ultra-premium, feature rich cordsets and adapters. Weekender® by ParkPower products are built to offer outstanding value and the uncompromised quality ParkPower has been known for since 2004.



# DETACHABLE POWER WEEKENDER®

## Single Piece Adapters

30

NEW

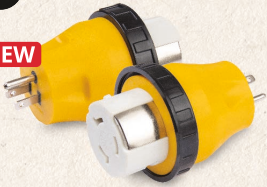

Connect between an inlet and a power cord to resolve power incompatibility issues. Durable PVC housing. Locking ring for weatherproof connection to RV inlet.

## Straight-Blade Adapters

30



Connect between a power cord and a power source to resolve power incompatibility issues. They feature heavy-duty weather resistant, UV stable construction in a compact, unbreakable PVC housing.

## Dogbone Adapters

31

NEW



Connect between a power cord and a power source to resolve power incompatibility issues. Extra wide grip handles, LED indicator lights and outdoor use hard-service cable for quality, durability and UV resistance.

## Portable Surge Protectors

35

NEW



Weekender portable surge protectors provide surge protection and detect wiring faults at the pedestal. The compact footprint and intuitive design simplify storage and usage.

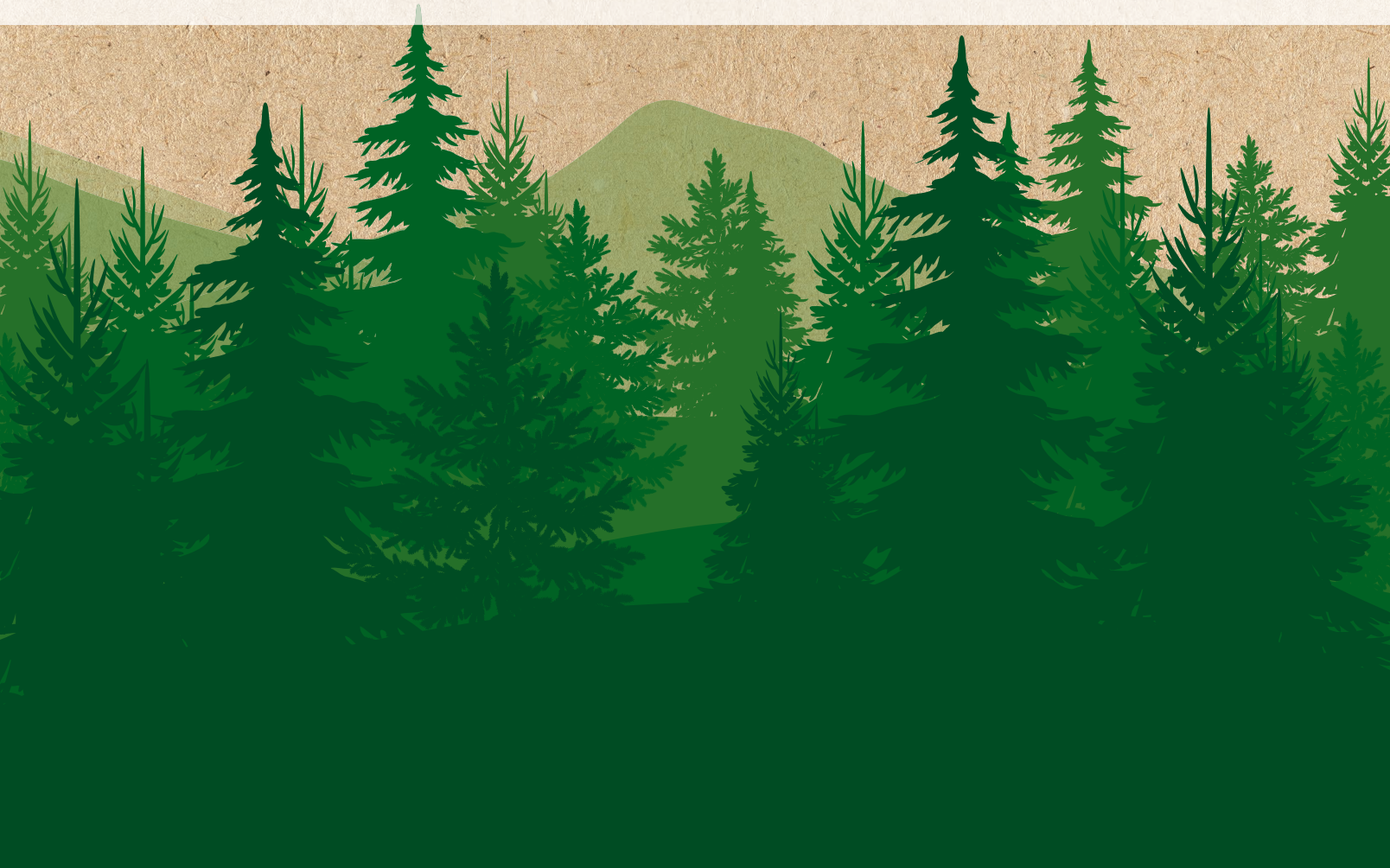



### Inlets

Weekender<sup>®</sup> by ParkPower Inlets are the industry standard. ParkPower<sup>®</sup> OEM grade quality. They feature robust construction, corrosion resistant, UV stable materials for a long life in harsh environments. They include features that make them simple to install and use.



30ARVIB

30ARVIW

50ARVIB

50ARVIW

### Detachable Power Cords

Connect between an inlet and a power source to provide power to the RV. Extra wide grip handles, LED indicator lights and outdoor use hard-service cable for quality, durability, and UV resistance. The included locking ring creates a watertight seal between the power cord and the inlet.



30ARVD25 25 ft  
30ARVD30 30 ft  
30ARVD36 36 ft

50ARVD25 25 ft  
50ARVD36 36 ft

### Extension Cords

Connect between a power cord and a power source to extend existing power cords. Extra wide grip handles, LED indicator lights and outdoor use hard-service cable for quality, durability, and UV resistance.

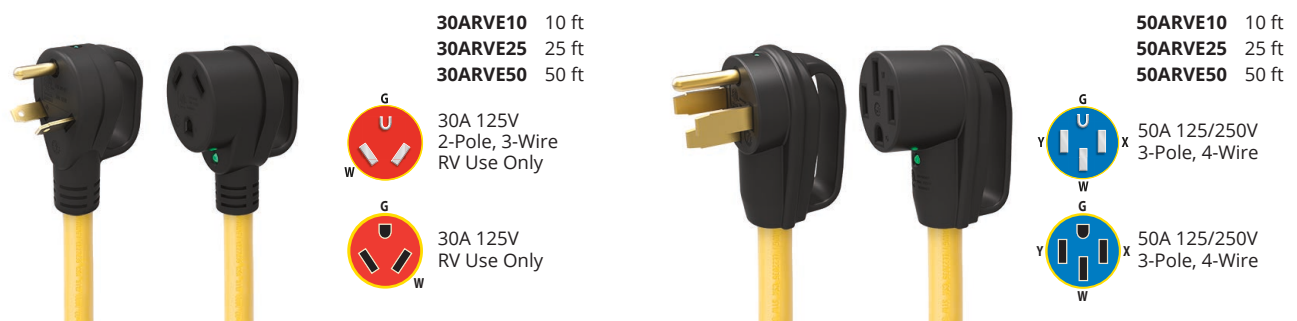

30ARVE10 10 ft  
30ARVE25 25 ft  
30ARVE50 50 ft

50ARVE10 10 ft  
50ARVE25 25 ft  
50ARVE50 50 ft

## TECH TIP

ParkPower is committed to providing the safest, most reliable detachable power solutions, including adapters for a wide variety of applications. Since different adapter types are used for different purposes, the following information is helpful in determining which adapter is best suited for your application.

### Adapter Types Explained

**Pigtail Adapters** connect between the RV inlet and the female end of a cord. The locking ring on the female end of the adapter provides a watertight seal between the inlet and the adapter. Pigtail adapters contain power indicator LEDs to ensure power is flowing through the adapter.

ParkPower, pg 19. Weekender, pg 29.

**One-Piece Twist-Lock Adapters** also connect between the RV inlet and the female end of a cord. They are identical to pigtail adapters in function, but are not recommended for use in wet locations since they do contain locking rings. One-Piece twist lock adapters contain power indicator LEDs to ensure power is flowing through the adapter.

ParkPower, pg 20.

**Generator Adapters** connect between the male end of a cord and the power source. Generator adapters are available with and without cords for maximum application flexibility.

ParkPower, pg 21. Weekender, pg 32.

**Dogbone Adapters** also connect between the male end of a cord and the power source. ParkPower and Weekender dogbone adapters are designed with a handle for one handed use while allowing the power source enclosure to close properly.

ParkPower, pg 22. Weekender, pg 31.

**Straight-Blade Adapters** also connect between the male end of a cord and the power source. They are identical to dogbone adapters in function, but provide a more compact solution.

Weekender, pg 30.

## Pigtail Adapters

Connect between an inlet and a power cord to resolve power incompatibility issues. Extra wide grip handles, LED indicator lights and outdoor use hard-service cable for quality, durability, and UV resistance. The included locking ring creates a watertight seal between the adapter and the inlet.

3 YEAR WARRANTY





## Single Piece Adapters

Durable PVC housing. Locking ring for weatherproof connection to RV inlet.

3 YEAR WARRANTY



## Straight-Blade Adapters

Connect between a power cord and a power source to resolve power incompatibility issues. They feature heavy-duty weather resistant, UV stable construction in a compact, unbreakable PVC housing.

3 YEAR WARRANTY



## Dogbone Adapters

Connect between a power cord and a power source to resolve power incompatibility issues. Extra wide grip handles, LED indicator lights and outdoor use hard-service cable for quality, durability and UV resistance.

3 YEAR WARRANTY

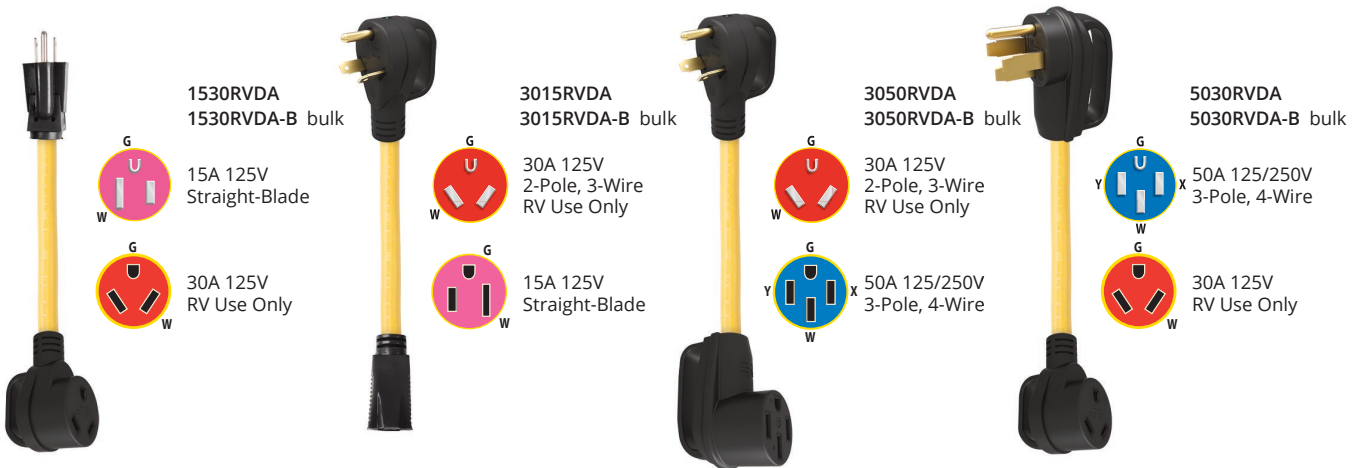

## Y Adapter **NEW**

50A Male To (2) 30A Female provides two female RV receptacles from a 50A RV power source. Heavy-duty STW cable for outdoor use with molded ends with handles on female end and male ends.

503030YA

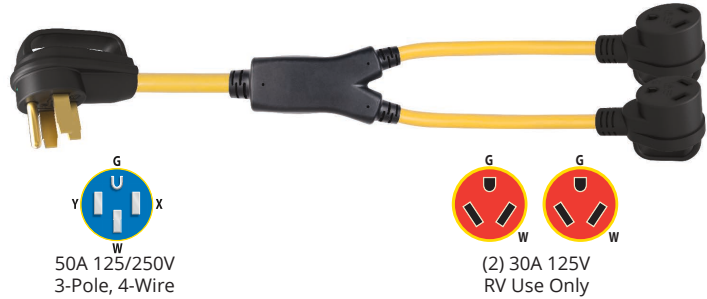

## Generator Adapters

Connect between a power cord and a generator power source to resolve power incompatibility issues. They feature heavy-duty weather resistant construction in a compact, unbreakable PVC housing.

3 YEAR WARRANTY

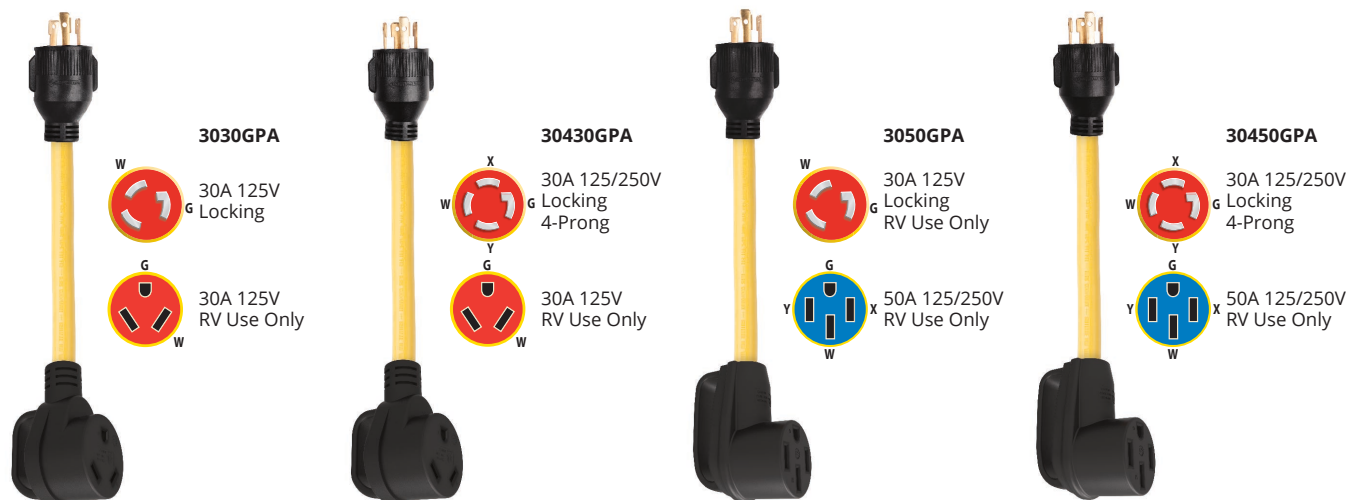

### 30A Generator Plug to (3) 15A Receptacles Pigtail Adapter **NEW**

30A Male To (3) 15A Female provides three 15A receptacles from a 30A generator receptacle. The clear, illuminated end provides visual feedback that power is present. Heavy-duty STW cable for outdoor use with molded ends with clear 15A end with LED indication on female end.

30153GPA

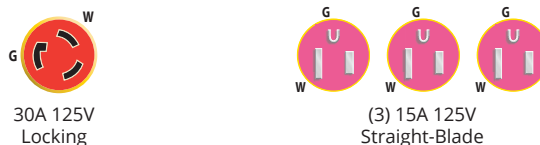



## Portable Surge Protectors **NEW**

Weekender portable surge protectors provide surge protection and detect wiring faults at the pedestal. The compact footprint and intuitive design simplify storage and usage.

- Open ground, open neutral & reverse polarity detection
- Mis-wired pedestal indication
- Surge failure indicator
- Brighter 3-color LED indicators
- Weekender pull handle
- Weather resistant / designed for outdoor use

Ratings	Surge Protection	Dimensions (LxWxD)	Operating Temps	Part #
120V / 3,600W	3-mode / 825J / 22,500A	5" x 3" x 13-1/2"	40°C to +105°C	30PSP
120/240V / 12,000W	5-mode / 1,650J / 45,000A	5" x 3" x 13-1/2"	40°C to +105°C	50PSP



30PSP

50PSP

## Dead Front Receptacles

Ideal for new installations or replacing worn out receptacles. Made of high heat, impact-resistant plastic and heavy-duty, high conductive metal contacts. Traditional design makes installation straightforward and easy.

- Wall mounted receptacles for 30A or 50A power
- cULus listed



30ARVREC

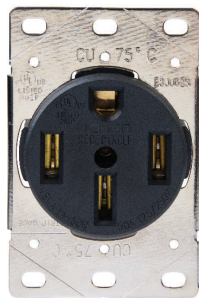

50ARVREC

30ARVREC for 50 amp RV power  
50ARVREC for 30 amp RV power

## Weekender Planogram Assortment

- Standard packaging footprints
- Easy store transition
- Easy to mix and match with ParkPower

### Includes:

- 4 Inlets
- 2 Detachable Power Cords
- 4 Extension Cords
- 8 Corded Adapters
- 4 Straight Adapters

### WKN48POG

Item	Qty	Description
3050RVSA	2	30AM-50AF Adapter Plug
5030RVSA	2	50AM-30AF Adapter Plug
1530RVSA	8	15AM-30AF Adapter Plug
3015RVSA	2	30AM-15AF Adapter Plug
30ARVIB	1	30A Power Inlet, Black
30ARVIW	1	30A Power Inlet, White
50ARVIB	1	50A Power Inlet, Black
50ARVIW	1	50A Power Inlet, White
1530RVDA	2	15AM-30AF Adapter, 12"
3015RVDA	2	30AM-15AF Adapter Cord w/Handle, 12"
3050RVDA	2	30AM-50AF Adapter Cord w/Handle, 12"
5030RVDA	2	50AM-30AF Adapter Cord w/Handle, 12"
1530PA	2	15AM-30AF Detachable Cord Adapter, 12"
1550PA	2	15AM-50AF Detachable Cord Adapter, 12"
3030PA	2	30AM-30AF Detachable Cord Adapter w/Handle, 12"
3050PA	2	30AM-50AF Detachable Adapter Cord w/Handle, 12"
30ARVE25	6	30A Extension Cord w/Handle, 25'
30ARVD25	2	30A Detach Power Cord w/Handle, 25'
50ARVE25	2	50A Extension Cord w/Handle, 25'
50ARVD25	2	50A Detach Power Cord w/Handle, 25'
50ARVE10	3	50A Extension Cord w/Handle, 10'
30ARVE10	2	30A Extension Cord w/Hdl, 10'



# SURGE PROTECTION

## Portable Surge Protector Kits



Portable surge protector kits contain a separate receptacle tester to detect wiring faults at the pedestal and a surge module to attach to the detachable power cord. Separating the two functions reduces the size of the product while increasing protection from inclement weather. Kit contains receptacle tester and surge module.

## Portable Surge Protectors

38

Cost effective solutions to protect RV's and its contents from common electrical and surge protection problems.



## EMS Portable Surge Protectors

39

Protects your RV against voltage fluctuations, power surges and incorrectly wired shore power.



## EMS Hardwired Surge Protectors

40



Provides full RV protection against all adverse power conditions.

*Progressive Industries*

## A little about Progressive Industries

The Progressive Industries story began in 1997 when a full-time RV-er determined there had to be a better way to provide electrical protection to the new generation of RV's that now included high-end electronic equipment. That vision led him to several products that offer state-of-the-art, reliable electrical and surge protection for today's RV-ers. The company has grown and expanded its product line to include high quality, innovative electrical adapters and connectors for RV's.



# SURGE PROTECTION

## EMS Bypass Switch Kit

40

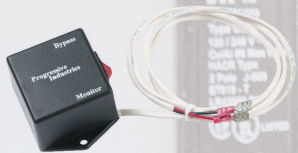

Enables users of EMS-LCHW units to go into bypass mode without opening the unit.

## Extra EMS-Remote Digital Display

40



Allows users of EMS-HW units the option to add an additional digital remote.

## RV 50 Amp Extension Plug

41



New 50 Amp pedestal receptacle Extension Plug allows your surge protector to hang vertically when plugged in to the pedestal.

## Replacement Ends

41



Made with heavy-duty, high conductive metal contacts. Perfect for replacing worn, damaged ends on extension cords.

SITE E4

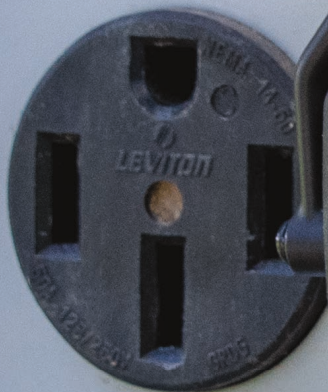

TURN OFF  
CIRCUIT  
BEFORE  
PLUG. PL  
INSERTED

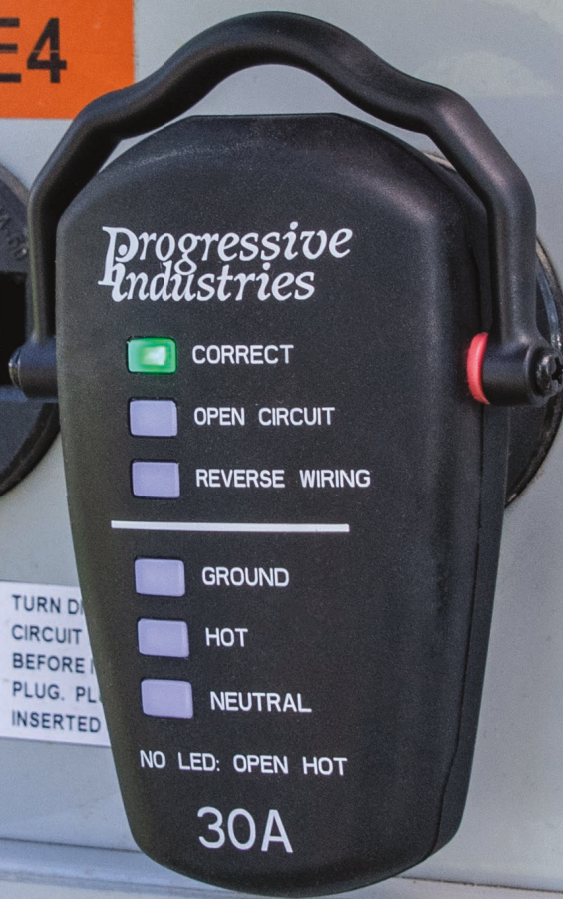

Progressive Industries

- CORRECT
- OPEN CIRCUIT
- REVERSE WIRING

---

- GROUND
- HOT
- NEUTRAL

NO LED: OPEN HOT

30A



TEST MONTHLY  
TEST MENUEL

RESET  
REARM

TEST MONTHLY  
TEST MENUEL

RESET  
REARM

TEST MONTHLY  
TEST MENUEL

RESET  
REARM

TEST MONTHLY  
TEST MENUEL

RESET  
REARM

TEST MONTHLY  
TEST MENUEL

RESET  
REARM

TEST MONTHLY  
TEST MENUEL

RESET  
REARM

TEST MONTHLY  
TEST MENUEL

RESET  
REARM

TEST MONTHLY  
TEST MENUEL

RESET  
REARM

WR

TEST MONTHLY  
TEST MENUEL

RESET  
REARM

TEST MONTHLY  
TEST MENUEL

RESET  
REARM

TEST MONTHLY  
TEST MENUEL

RESET  
REARM

TEST MONTHLY  
TEST MENUEL

RESET  
REARM

TEST MONTHLY  
TEST MENUEL

RESET  
REARM

TEST MONTHLY  
TEST MENUEL

RESET  
REARM

TEST MONTHLY  
TEST MENUEL

RESET  
REARM

**WARNING**  
Hazardous Voltage  
Contact may cause injury or property damage.  
Only authorized personnel may service this equipment.  
Turn off power before applying the equipment.  
Safety is the priority.

PERSONS CONTACTING THIS EQUIPMENT ARE NOT PROTECTED FROM ELECTRICAL SHOCK.  
TO RESTORE POWER, PRESS THE RESET BUTTON.  
TO ASSURE PROPER OPERATION, TEST THE RECEPTACLE MONTHLY. TO TEST, PRESS THE TEST BUTTON, THEN FOLLOWED BY THE RESET BUTTON.



## Which Progressive Industries product is best for your Recreational Vehicle?

Benefits and Features	Portable						Portable EMS		Hardwired EMS			
	PSK-30	PSK-50	SSP-30X	SSP-50X	SSP-30XL	SSP-50XL	EMS-PT30X	EMS-PT50X	EMS-HW30C	EMS-HW50C	EMS-LCHW30	EMS-LCHW50
Over/under Voltage Protection							✓	✓	✓	✓	✓	✓
Open Ground, Open Neutral & Reverse Polarity Detection	✓	✓	✓	✓	✓	✓	✓	✓	✓	✓	✓	✓
Open Ground, Open Neutral & Reverse Polarity Protection							✓	✓	✓	✓	✓	✓
Accidental 240V Protection							✓	✓	✓	✓	✓	✓
Miswired Pedestal Indication	✓	✓	✓	✓	✓	✓	✓	✓	✓	✓	✓	✓
Surge Failure Indicator	✓	✓	✓	✓	✓	✓	✓	✓	✓	✓	✓	✓
Current Indication							✓	✓	✓	✓	✓	✓
Previous Error Code							✓	✓	✓	✓	✓	✓
A/C Frequency Protection							✓	✓	✓	✓	✓	✓
Time Delay							✓	✓	✓	✓	✓	✓
Adjustable Time Delay									✓	✓	✓	✓
Built-in Display							✓	✓			✓	✓
Remote Display									✓	✓		
Field Serviceable									✓	✓	✓	✓
Weather Resistant	✓	✓	✓	✓	✓	✓	✓	✓				
Brighter 3-color LED Indicators	✓	✓	✓	✓	✓	✓						
Locking Bracket					✓	✓	✓	✓				
Rugged Pull Handle	✓	✓	✓	✓	✓	✓	✓	✓				
Tough Lexan Housing					✓	✓	✓	✓				
All Weather Shield Assembly					✓	✓	✓	✓				
Designed for Outdoor Use	✓	✓	✓	✓	✓	✓	✓	✓				
UL Certified					✓	✓			✓	✓	✓	✓
Meets CSA standards					✓	✓			✓	✓	✓	✓
Electrical Rating	120V, 30A 3,600W	120/240V, 50A 12,000W	120V 3,600W	120/240V 12,000W	120V 3,600W	120/240V 12,000W	120V, 30A 3,600W	240V, 50A 12,000W	120V, 30A 3,600W	240V, 50A 12,000W	120V, 30A 3,600W	240V, 50A 12,000W
Surge Suppression Joules	1,100J	2,030J	825J	1,650J	825J	1,650J	1,790J	3,580J	1,790J	3,580J	1,790J	3,580J
Lifetime Warranty	✓	✓	✓	✓	✓	✓	✓	✓	✓	✓	✓	✓

A few other things you should know...

- Progressive Industries surge protection products are intended for Recreational Vehicles use only.
- Product Comparisons are provided for informational purposes only. Although every reasonable effort has been made to represent current and accurate data Progressive Industries make no guarantee of any kind and cannot be held liable for any outdated or incorrect information. Data current as of 1/1/2017 v2.

## Portable Surge Protector Kits **NEW**

Portable surge protector kits contain a separate receptacle tester to detect wiring faults at the pedestal and surge module to attach to the detachable power cord. Separating the two functions reduces the size of the product while increasing protection from inclement weather.

- Kit contains Receptacle Tester and Surge Module (components available separately)
- Tests the following with a single indicator:
  - Open Ground, Open Neutral, Open Hot
  - Hot/Neutral Reversed, Hot/Ground Reversed
- Surge module ratings:
  - 30A: 22,500A max spike / 1,100 joules
  - 50A: 45,000A max spike / 2,030 joules
- Surge module contains surge protection indicator alerting user when depleted

PSK-30 30A  
PSK-50 50A



30A  
RRT-30

30A  
RRT-50



30A  
RSM-30

50A  
RSM-50

## RV Receptacle Testers **NEW**

Receptacle testers detect wiring faults at the pedestal, including open ground, open neutral, open hot, hot/neutral reversed and hot/ground reversed.

- Tests the following with a single indicator:
  - Open Ground, Open Neutral, Open Hot
  - Hot/Neutral Reversed, Hot/Ground Reversed
- Includes swivel handle for easy removal from the pedestal

RRT-30 30A  
RRT-50 50A

## RV Surge Modules **NEW**

Surge modules attach to the detachable power cord to provide surge protection. The compact size increases protection from inclement weather.

- Surge module ratings:
  - 30A: 22,500A max spike / 1,100 joules
  - 50A: 45,000A max spike / 2,030 joules
- Contains surge protection indicator alerting user when depleted

RSM-30 30A  
RSM-50 50A

## Portable Surge Protectors

Progressive Industries' portable Smart Surge Protectors (SSP) offer a cost effective solution to detect and protect customers from poor and/or unsafe electrical conditions such as: open ground, open neutral and reverse polarity. In addition, SSP's are designed to protect RV electronics from power surges by absorbing the surge and indicating the product has been compromised. Green LED indicator light off indicates a warning that product service is required.

### Product features

- Open ground, open neutral & reverse polarity detection
- Mis-wired pedestal indication
- Surge failure indicator
- Brighter 3-color LED indicators
- Rugged pull handle
- Weather resistant/designed for outdoor use
- Lifetime warranty\*



SSP-30X



SSP-50X

## Portable Surge Protectors with Splash-up Guard

Same great features as our standard portable surge protectors (above) but with protective cover and other additional features.

### Product features

- Tough Lexan housing
- Cable splash-up guard
- Higher rated wire (6 AWG (SSP-50XL models only))
- UL certified
- Meets CSA standards
- Security locking bracket
- All weather shield assembly
- Open ground, open neutral & reverse polarity detection
- Mis-wired pedestal indication
- Surge failure indicator
- Brighter 3-color LED indicators
- Rugged pull handle
- Weather resistant/designed for outdoor use
- Lifetime warranty\*



SSP-30XL



SSP-50XL



Ratings	Surge Protection	Dimensions (LxWxD)	Operating Temps	Part #	Part # w/ Splash-up Guard
120V / 3,600W	3-mode / 825J / 22,500A	5" x 3" x 13-1/2"	40°C to +105°C	SSP-30X	SSP-30XL
120/240V / 12,000W	5-mode / 1,650J / 45,000A	5" x 3" x 13-1/2"	40°C to +105°C	SSP-50X	SSP-50XL



\*Lifetime Warranty does not include All Weather Shield Assembly



## EMS Portable Surge Protectors

Progressive Industries' portable Electrical Management System (EMS) protects your RV from incorrectly wired shore power, voltage fluctuations and numerous other problems that can cause damage to RV electronics.

### Product features

- Over/under voltage protection
- Open ground, open neutral & reverse polarity detection and protection
- Surge failure indicator
- Current indication
- Previous error code (PE)
- A/C frequency protection
- Time delay (136 seconds)
- Built-in scrolling digital display
- Weather resistant/ designed for outdoor use
- 7-days a week customer service
- Lifetime warranty\*

### New Features Include:

- All weather shield assembly
- Rugged pull handle
- Security locking bracket
- Tough Lexan housing
- Higher rated wire 6 AWG (SSP-50XL models only)



EMS-PT30X

EMS-PT50X

Ratings	Surge Protection	Dimensions (LxWxD)	Operating Temps	Part #
120V	1,790J	18-1/4" x 6-1/4" x 6-1/8"	40°C to +105°C	EMS-PT30X
120/240V	3,580J	18-1/4" x 6-1/4" x 6-1/8"	40°C to +105°C	EMS-PT50X

\*Lifetime Warranty does not include All Weather Shield Assembly



## TECH TIP

### Do you have Hot Skin?

Hot skin condition is what causes a tingle when you touch the doorknob or metal steps of an RV while standing on the ground. To avoid this condition you need to make sure the frame and body of your RV is never electrified due to poor maintenance, bad connections or a hot ground in a power plug. This can happen when a campsite pedestal outlet is defective (unbeknownst to you) or if you're using an improperly wired extension cord. A sure fire way to prevent Hot Skin and protect your RV is to use a Progressive Industries RV Surge and Electrical Protector. Call us and we'll help you find the right one for your RV.



## EMS Hardwired Surge Protectors

Progressive Industries' Hardwired Electrical Management Systems (EMS) provide full RV protection against all adverse power conditions. You will feel secure with multi-mode surge, voltage, polarity and lost/open neutral protection. Each unit includes a digital display, scrolling continuously through the power source information: Voltage(s), current, frequency, error code, and previous error code (if applicable). Replacement parts are simply plug-and-play, making repairs quick and easy. As with our portable models, the computer is driven by state of the art microprocessors.

### Product features

- Over/Under voltage protection
- Open ground, open neutral & reverse polarity protection
- High and low voltage protection (Low <104, High 132>)
- Mis-wired pedestal indication
- Surge failure indicator
- Current indication
- Previous error code
- A/C frequency protection
- (2) Adjustable time delay settings
- Remote digital display (HW50C & HW30C models only)
- Built-in digital display (LCHW50 & LCHW30 models only)
- Field serviceable
- UL certified
- Meets CSA standards
- 7-days a week customer service
- Lifetime warranty



### Remote Digital Display



EMS-HW50C



EMS-HW30C

### Built-in Digital Display



EMS-LCHW50



EMS-LCHW30

The EMS-HW & LCHW units are shipped with remote digital display, cable & extra hardware are tucked **INSIDE** the unit for safe shipping. Simply remove the lid to find other components.



Ratings	Surge Protection	Dimensions (LxWxD)	Operating Temps	Built-in Digital Display	Remote Digital Display
120V / 30A / 3,600W	3-mode / 1,790J / 44,000A	9" x 5" x 3"	40°C to +105°C	EMS-LCHW30	EMS-HW30C
240V / 50A / 12,000W	5-mode / 3,580J / 88,000A	9" x 5" x 4"	40°C to +105°C	EMS-LCHW50	EMS-HW50C



## EMS Bypass Switch Kit

The Progressive Industries EMS Bypass Switch enables users to go in to Bypass mode without opening the unit. For use with EMS-LCHW units only.

- Dimensions: 2-7/8" x 2-1/4" x 1-1/2"
- Cable: 44"
- Some installation required

RBPSK



## Extra EMS-Remote Digital Display

The Progressive Industries EMS-RDS allows user the option to add an additional digital remote. For EMS-HW units only.

- 14' & 3' data link cables included
- Lifetime warranty

EMS-RDS





## Accessories



## Replacement Ends

Progressive Industries' replacement ends are made with heavy-duty, high conductive metal contacts making the replacement better suited to handle the heat created by heavy loads as opposed to molded-on varieties. These are perfect for replacing worn, damaged ends on extension cords and the sleek, compact designs makes installation straightforward and easy.

- Nickel-plated contacts
- Made of high heat, impact-resistant Valox plastic
- User attachable
- Designed for outdoor use
- 1-year warranty

Part #	Ratings	Wire Size
TT-30R	120V / 30A / 3,600W	10/3 STW
TT-30P	120V / 30A / 3,600W	10/3 STW
RV 14-50R	240V / 50A / 12,000W	8/4 or 6/4 SRDT
RV 14-50P	240V / 50A / 12,000W	8/4 or 6/4 SRDT



## RV 50 Amp Extension Plug

Progressive Industries' 50 Amp pedestal receptacle Extension Plug allows your surge protector to hang vertically when plugged in to the pedestal.

- Nickel-plated contacts
- Made of high heat, impact-resistant Valox plastic
- User attachable
- Designed for outdoor use
- 1-year warranty

50AXP



## Resettable Circuit Breaker Adapter **NEW**

50A RV male to (2) 15A female resettable circuit breaker adapter provides 2 resettable 15A receptacles from a 50A pedestal. This adapter is designed for 30A RV users that do not want to draw additional power from their 30A or 15A service which may trip breakers at the pedestal. Each 15A receptacle is wired independently to an illuminated circuit breaker making it the safest and easiest to use solution for additional 15A power. The compact design allows the electrical box to close and makes it optimal for use with power strips and extension cords.

CBA-5015





# DC MANAGEMENT

## Manual Battery Switches

44



Commonly used on vehicles where the batteries are located near the operator, allowing the high amperage switching and the control of the switch to be the same location.

## Low Voltage Disconnect

45



Senses low battery voltage and disconnects non-critical loads to save power for engine starting.

## Remote Battery Switches

47



Used when there is not an easily accessible location near the batteries to mount the battery switch.

## Automatic Charging Relays

47



Automatically combines two battery banks during charging and isolates batteries when discharging and optionally when starting the engine.



Blue Sea Systems was founded in 1992 based on a commitment to create innovative, high quality electrical products to improve the safety, simplicity, and reliability of equipment. Since that time the range of product has expanded to over 1,000 items and distributed to customers in over 50 countries to Marine, RV, Industrial and Specialty Vehicles markets. The company is committed to offering quality products that are engineered for harsh environments, built to last, with a guarantee of satisfaction and industry leading technical support.



# DC MANAGEMENT

## Bus Bars & Connectors

50



BusBars distribute positive wires or collect negative returns. BusBars range in capacity with a variety of terminal stud configurations. PowerPost connectors terminate multiple large conductors.

## Fuses & Fuse Blocks

53



Fuse blocks mount to a solid surface and may contain one or multiple fuses. Fuses are available in a wide variety of amperages to protect DC circuits.

## 12V Plugs & Accessories

59



A wide range of receptacles, plugs, and meters for connecting, USB charging, and battery monitoring. These products are designed specifically for harsh environments.

## Cup Holder Power Inverter

61



Perfect for the on-the-road active user who needs to convert 12 Volt battery power to 110V AC. While in your RV or car, provide instant AC power for laptops, cell phone chargers, radios, portable TV's, lighting, small power tools and more.





## M Series Battery Switches

### 300 Amps continuous rating

- Tin-plated copper studs for maximum conductivity and corrosion resistance
- Studs accept 3/8" (M10) ring terminals
- 7/8" (22 mm) stud length accepts multiple cable terminals
- Blue Sea Systems one-piece terminal stud design never loosens over time
- One-piece stainless flange nuts ensure safe and secure connections
- Isolating cover with three snap-in side pieces protects rear contacts and allows wire access in any direction
- Rear, front, or surface mounted
- 6 circuit label set included
- Icon Circuit Identification Label Kit available—sold separately

### Specifications

	6006-BSS	6007-BSS
	6006200-BSS	6007200-BSS
Cranking Rating: 30 sec	900A	900A
Intermittent Rating: 5 min	500A	500A
Continuous Rating	300A	300A
Voltage Max Operating	48V DC	32V DC

### Regulatory

CE marked, ISO 8846, UL Listed—UL 1107 electric power switches  
Meets UL 1500 and SAE J1171 external ignition protection requirements  
IP66—protected against powerful water jets

Part #	Description	Color
6006-BSS	Single Circuit ON-OFF	Red
6006200-BSS	Single Circuit ON-OFF	Black
6007-BSS	Selector 4 Position	Red
6007200-BSS	Selector 4 Position	Black

## E Series Battery Switches

### 350 Amps continuous rating

- Tin-plated copper studs for maximum conductivity and corrosion resistance
- Accepts up to 4/0 AWG (120 mm<sup>2</sup>) battery cables
- Studs accept 3/8" (M10) ring terminals
- 7/8" (22 mm) stud length accepts multiple cable terminals
- Blue Sea Systems one-piece terminal stud design never loosens over time
- One-piece stainless flange nuts ensure safe and secure connections
- Fits most standard Perko and Guest battery switch hole patterns
- Tactile indicator conveys knob position by feel
- Rear or front mounted
- Icon Circuit Identification Label Kit available—sold separately

### Specifications

	9003E-BSS	9001E-BSS
Cranking Rating: 30 sec	1,200A	1,200A
Intermittent Rating: 5 min	600A	600A
Continuous Rating	350A	350A
Voltage Max Operating	48V DC	32V DC

### Regulatory

CE marked, ISO 8846, UL Listed—UL 1107 electric power switches  
Meets UL 1500 and SAE J1171 external ignition protection requirements  
IP66—protected against powerful water jets

Part #	Description
9001E-BSS	Selector 4 Position
9003E-BSS	Single Circuit ON-OFF

### Single Circuit ON-OFF

Switches a single battery to a single load group



6006-BSS

### Selector 4 Position

Switches isolated battery banks to all loads or combines battery banks to all loads



6007-BSS

### Single Circuit ON-OFF

Switches a single battery to a single load group



9003E-BSS

### Selector 4 Position

Switches isolated battery banks to all loads or combines battery banks to all loads



9001E-BSS



## HD Series Battery Switches

Up to 600 Amps continuous

- Tin-plated copper studs for maximum conductivity and corrosion resistance
- Accepts up to 4/0 AWG (120 mm<sup>2</sup>) battery cables
- Studs accept 1/2" (M12) ring terminals
- 7/8" (22 mm) stud length accepts multiple cable terminals
- Blue Sea Systems one-piece terminal stud design never loosens over time
- One-piece stainless flange nuts ensure safe and secure connections
- Fits most Perko and Guest low amperage battery switch hole patterns
- Case design allows surface or rear mounting options
- Tactile indicator conveys knob position by feel
- Rear or front mounted
- Icon Circuit Identification Label Kit available—sold separately

### Specifications

	3000-BSS	3002-BSS
Cranking Rating: 30 sec	1,750A	1,600A
Cranking Rating: 1 min	1,325A	1,150A
Intermittent Rating: 5 min	900A	700A
Continuous Rating	600A	500A
Voltage Max Operating	32V DC	32V DC

### Regulatory

CE marked, ISO 8846, UL Listed—UL 1107 electric power switches  
Meets UL 1500 and SAE J1171 external ignition protection requirements  
IP66—protected against powerful water jets

Part #	Description
3000-BSS	Single Circuit ON-OFF
3002-BSS	Selector 4 Position

### Single Circuit ON-OFF

Switches a single battery to a single load group



3000-BSS

### Selector 4 Position

Switches isolated battery banks to all loads or combines battery banks to all loads



3002-BSS

## M LVD Low Voltage Disconnect

Senses low battery voltage and disconnects non-critical loads to save power for engine starting

- Status light in both m-LVD and Remote Control Switch provides visual warning of low voltage state prior to disconnect
- Alarm output for audible warning of low voltage state prior to disconnect (optional alarm required)
- One-piece stainless flange nuts ensure safe and secure connections
- Remote Control Switch functions:
  - Sets desired disconnect voltage
  - Temporarily delays circuit disconnect for 10 minutes
  - Temporarily disconnects circuits until voltage rises
  - Silences alarm (optional alarm required)
- Includes Remote Control Switch

### Specifications

Intermittent Rating: 5 min	115A
Continuous Rating	65A
Nominal Voltage	12V DC
Cable Size (to meet current ratings)	6 AWG (16mm <sup>2</sup> )
Terminal Stud Size	1/4"-20 (M6)
Disconnect Voltage	11.3V-12.1V Adjustable
Reconnect Voltage	13V DC
Remote Control Switch	Type: SPDT Action: (ON)-OFF-(ON) ( ) = momentary

### Regulatory

Meets ISO 8846 and SAE J1171 external ignition protection requirements

Part #	Description
7635-BSS	M LVD Low Voltage Disconnect



### System Diagram

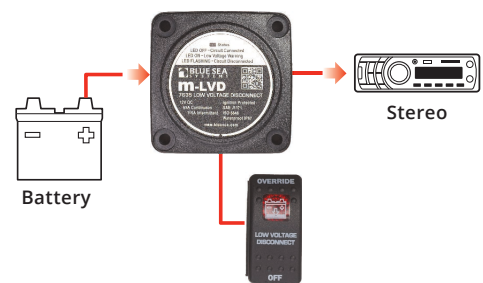

## Battery Master Switches

Unique to the Chassis and House Battery Master Switches is the patented contour lock system, allowing the switches to be used as stand alone units, or locked together with other switches. The switches also feature a control knob which cannot be removed while in the ON or OFF position, but it can be removed by switching to an anti-clockwise 45° position. The switches also feature removable side plates on 4 sides for access of up to 1/0 cables plus a rear cover insulating the rear terminals against any short circuits.

701CHRV Chassis battery  
701HBRV House battery

### Specifications

- Continuous Rating: 275A DC
- Intermittent Rating: 455A DC
- Cranking Rating: 1250A DC
- Voltage Rating: 48V DC
- Operation: On / Off
- Recessed or Surface Mount
- Ignition Protected
- Termination Stud Size: 3/8" (2 x 10 mm)
- Dimensions: 2.75 x 2.75 x 3" H (69 x 69 x 75 mm H)
- Tin plated copper studs and nuts

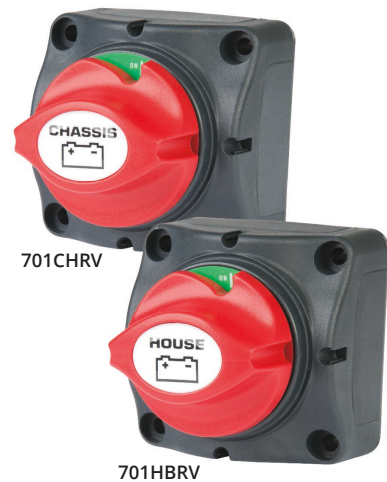

## Easyfit™ Battery Switch

ParkPower® has listened to its customers and has responded to feedback concerning some installations where switches need to be recessed through varying thicknesses of panels. The 700RV Easyfit switch achieves this through an easily removable threaded ring allowing for panel thicknesses up to 3/4" (19 mm). This durable switch is designed with a removable key 45° past the off position, labeled handle and a removable back cover covering exposed terminals. The switch can also be surface mounted offering a unique style compared to other switches available on the market. The 700RV Easyfit can easily be retrofitted in place of most European post and lever type switches.

700RV

### Specifications

- Continuous Rating: 275A DC
- Intermittent Rating: 455A DC
- Cranking Rating: 1250A DC
- Voltage Rating: 48V DC
- Operation: On/Off
- Mounting: Recessed via 7/8" hole or Surface
- Termination Stud Size: 3/8" (2 x 10 mm)
- Tin plated copper studs and nuts
- Ignition protected



## Contour Heavy-Duty Master Switch

The Contour Heavy Duty Master switch is rated at 600 amps continuous and 2500 amps cranking, it is well suited for higher power loads. The 720RV can be recessed or surface mounted. The 720RV also includes the same style removable side plates and back plate as the 701RV series.

720RV

### Specifications

- Continuous Rating: 600A DC
- Intermittent Rating: 800A DC
- Cranking Rating: 2500A DC
- Voltage Rating: 48V DC
- Operation: On / Off
- Recessed or Surface Mount
- Ignition Protected
- Termination Stud Size: 1/2" (2 x 12 mm)
- Dimensions: 1 x 2.75 x 3" H (102 x 102 x 90 mm H)
- Tin plated copper studs and nuts





## ML Series Remote Battery Switch

500 Amp magnetic latching switch provides high amperage switching under load, manually or from remote locations

- Silver alloy contacts provide high reliability for switching live loads
- LED output to remotely indicate switch state—requires optional LED
- 3/8"-16 tin-plated copper studs for maximum conductivity and corrosion resistance
- One-piece stainless flange nuts ensure safe and secure connections
- Label recesses for circuit identification
- Includes a Remote Control Contura Switch

### Specifications

Control Circuit Connection	Tinned Wire
Mounting	#10 or M5
Terminal Stud Size	3/8"-16 (M10)
Maximum Terminal Stud Torque	140 in-lb (15.8 N•m)
Cable Size to Meet Rating	4/0 AWG (120mm <sup>2</sup> )
Terminal Ring Diameter Clearance	1.12" (28.4 mm)
Control Circuit Voltage	9-16V DC

### Regulatory

CE marked, Meets ISO 8846 and SAE J1171 external ignition protection requirements  
IP66—protected against powerful water jets

Part #	Nominal Voltage	Cable End	Manual Control
7700-BSS	12V DC	Stripped Wire	Yes



Remote Control Contura Switch  
Action: (ON)-OFF-(ON)



### Wire Size and Current Ratings for ML RBS 7700 and ML ACR 7622

Wire Size	Cranking 30 sec	Intermittent 5 min (UL 1107)	Continuous (UL 1107)
2/0 AWG (70 mm <sup>2</sup> )	1,000A	400A	225A
4/0 AWG (120 mm <sup>2</sup> )	1,100A	400A	300A
2x 4/0 AWG (2x 120 mm <sup>2</sup> )	1,450A	700A	500A

## ML Series Automatic Charging Relay

500 Amp magnetic latching (bi-stable) relay automatically combines batteries during charging and isolates batteries when discharging and when starting engine

- Magnetic Latching (ML) relay draws very low current in the ON state
- Start Isolation (SI) can be configured for temporary isolation of House loads from Engine circuit during engine cranking to protect sensitive electronics
- Manual override knob provides an added level of safety allowing control with or without power and offering LOCKED OFF capability for servicing
- Senses charging on two battery banks
- LED output to remotely indicate switch state—requires optional LED or Remote Control Contura Switch with integrated LED (included in retail package)
- 3/8"-16 tin-plated copper studs for maximum conductivity and corrosion resistance
- 7/8" (22 mm) stud length accepts multiple cable terminals
- One-piece stainless flange nuts ensure safe and secure connections
- Label recesses for circuit identification
- Silver alloy contacts provide high reliability for live switching
- Includes Remote Control Contura Switch

### Regulatory

CE marked, Meets ISO 8846 and SAE J1171 external ignition protection requirements IP66-protected against powerful water jets

Part #	Coil Volts	Cable End	Manual Control
7622-BSS	12V DC	Stripped Wire	Yes



Remote Control Contura Switch  
Action: ON-OFF-ON



## BatteryLink® ACR Automatic Charging Relay with optional Auxiliary Battery Priority

Automatically shares single source of charge with Auxiliary Battery

- 120A continuous rating to support high output alternators
- 12V/24V DC auto ranging voltage input
- Senses charging on two battery banks
- Side and bottom knockouts for cable connections
- Clip-on cover insulates terminal connections
- Studs accept multiple cable terminals
- One-piece stainless flange nuts ensure safe and secure connections
- Integrated LED indicates ACR status
- Quick connect terminals for ground and optional features

### Optional Features

- Optional Auxiliary Battery Priority connection shares the alternator charge with the Auxiliary battery longer when the engine is running to allow the use of auxiliary loads for an extended period of time
- Remote LED remotely indicates ACR states—requires optional LED

### Specifications

Intermittent Rating: 5 min	210A
Continuous Rating	120A
(Combine) Amperage Operating Current	175mA
(Open) Amperage Operating Current	15mA
Nominal Voltage	12V / 24V DC
Cable Size to Meet Ratings	1 AWG (50mm <sup>2</sup> )
Maximum Cable Size	1/0 AWG (50mm <sup>2</sup> )
Terminal Stud Size	3/8"-16 (M10)
Maximum Battery Size	850 CCA

Relay Contact Position	12V DC	24V DC
Combine (30 sec)	13.6V DC	27.2V DC
(2 min)	13.0V DC	26.0V DC
Open Low (30 sec)	12.75V DC	25.5V DC
Over Voltage Lockout	16.0V DC	--

### Auxiliary Priority - Optional Feature

Open Low (30 sec)	12.25V DC	24.5V DC
-------------------	-----------	----------

### Regulatory

CE marked, ISO 8846

Meets UL 1500 and SAE J1171 external ignition protection requirements

IP67—protected against immersion up to 1 meter for 30 minutes

**IGNITION  
PROTECTED**

Part #	Description
7611-BSS	BatteryLink® ACR

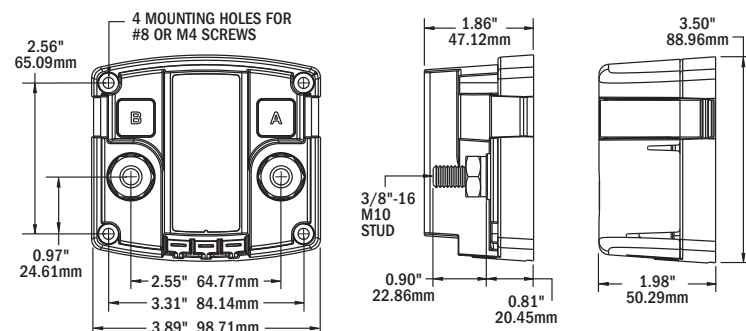



## ATD Automatic Timer Disconnect

Select from 4 methods to manage your batteries: Timer Disconnect, Low Voltage Disconnect, Automatic Charging Relay, or Solenoid

### Timer Disconnect

- 12V signal triggers relay to connect battery power to devices
- When signal is removed the timer is activated and will disconnect devices after a preset time
- Timer ranges from 15 minutes to 4 hours
- Optional charge sense can be used instead of 12V signal to reduce wiring
- Test mode disconnects devices after 5 seconds to confirm relay and timer are operational

### Low Voltage Disconnect

- Senses low battery voltage and automatically disconnects devices to save power
- Adjustable voltage setting at 11.0V, 11.5V, or 12.0V
- Low voltage setting can be used in conjunction with timer disconnect. Low voltage will disconnect devices prior to preset time to preserve battery power.

### Automatic Charging Relay

- Automatically combines two battery banks for charging off a single charging source (i.e. alternator)
- Isolates batteries when charging source is not present or discharging
- Single side sensing design only monitors the voltage of the start battery
- Ideal for auxiliary batteries that are AGM or larger than the start battery

### Solenoid

- 12V signal will connect or disconnect relay without any time delay

### Specifications

Nominal Voltage	12V DC
Input Voltage Range	9.5-16V
Continuous Rating	120A
Intermittent Rating: 5 min.	210A
(Combine) Amperage Operating Current	175mA
(Open) Amperage Operating Current	4mA
Cable Size to Meet Current Ratings	1 AWG (50mm <sup>2</sup> )
Maximum Cable Size	1/0 AWG (50mm <sup>2</sup> )
Terminal Stud Size	3/8"-16 (M10)
Terminal Stud Torque	140 in-lb (15.82Nm)
Time Range	15 Minutes - 4 Hours

### Regulatory

CE marked, Meets ISO 8846 and SAE J1171 external ignition protection requirements  
 IP67-protected against immersion up to 1 meter for 30 minutes

**IGNITION PROTECTED**



cover off

Part #	Description
7615-BSS	Automatic Timer Disconnect

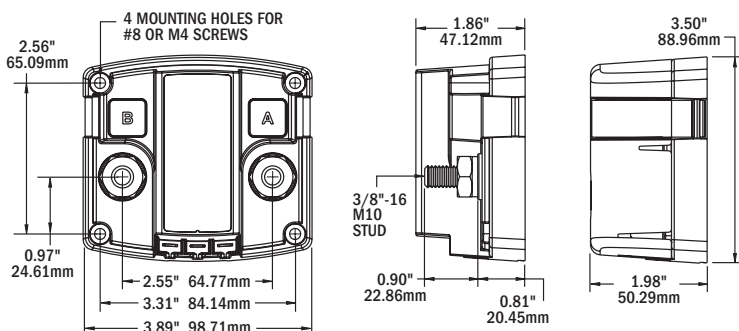

## 150A Common BusBars

Insert-molded stainless steel studs eliminate the need for securing nuts and allow high torquing for excellent electrical contact

- For positive distribution and for the collection of negative or AC ground circuits
- One-piece serrated flange nut ensures correct and secure connections

### Specifications

Continuous Rating	130A AC/150A DC
Voltage Max Operating	300V AC/48V DC
Mounting Holes	Accepts #10 (M5) Screws
Bus Material	Tin-Plated Copper C11000

### Regulatory

CE Certified

Part #	Cover	Terminal Screw	Terminal Stud
2300-BSS	Yes	10 × #8-32	2 × 1/4"-20
2312-BSS	Yes	20 × #8-32	2 × 1/4"-20
2307-BSS	Yes	--	4 × 1/4"-20

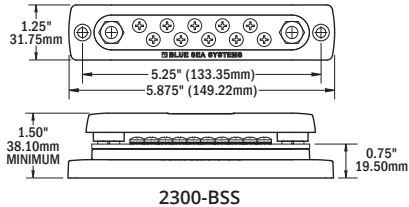

2300-BSS

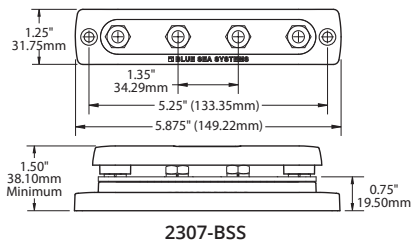

2307-BSS

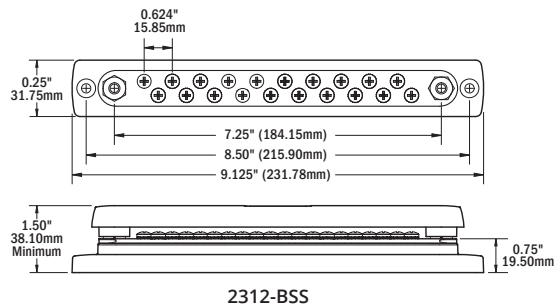

2312-BSS



2300-BSS



2307-BSS



2312-BSS





## PowerPost Cable Connectors

Insulated single stainless steel stud terminates multiple large conductors

- One-piece serrated flange nuts ensure correct and secure connections

### Specifications

Continuous Rating

Not rated—amperage flows between terminals stacked on post and is determined by wire and terminals used  
48V DC  
Accepts 1/4" Screws

Voltage Max Operating  
Mounting Holes

### Regulatory

CE Certified

Part #	Terminal Stud
2001-BSS	1/4"-20 × 1-1/16"
2002-BSS	5/16"-18 × 7/8"
2003-BSS	3/8"-16 × 7/8"

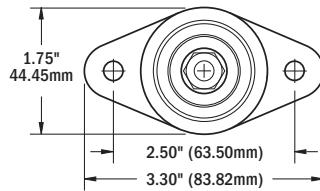

2001-BSS-2003-BSS



2001-BSS



2002-BSS



2003-BSS

## Rotating CableCap Insulators

Insulates battery terminals which have integral wing nut posts

- Top rotates 360 degrees to allow cable entry from any angle

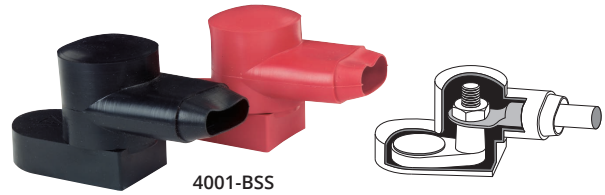

4001-BSS

Part #	Cable Size (AWG)	Color	Package
4001-BSS	All	Red/Black	Pair/Retail

## Standard CableCap Insulators

Insulates battery terminals which have added adapter terminals

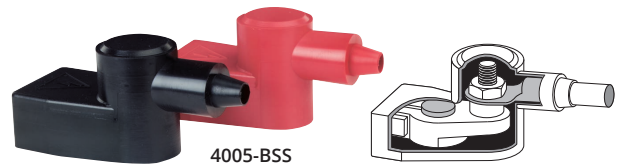

4005-BSS

Part #	Cable Size (AWG)	Color	Package
4005-BSS	4, 2, 1	Red/Black	Pair/Retail
4006-BSS	1/0, 2/0	Red/Black	Pair/Retail

## Stud CableCap Insulators

Insulates single stud on alternators, starters, windlasses and high amperage termination points

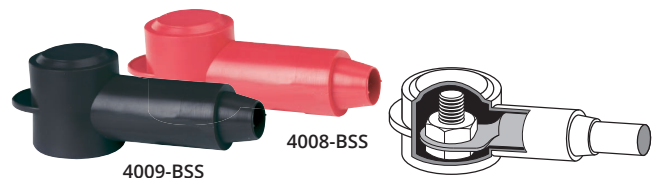

4009-BSS

Part #	Cable Size (AWG)	Color	Package
4008-BSS	18-10	Red	Retail/3
4009-BSS	18-10	Black	Retail/3
4010-BSS	8-4	Red	Retail/2
4011-BSS	8-4	Black	Retail/2
4012-BSS	2-2/0	Red	Retail/1
4013-BSS	2-2/0	Black	Retail/1
4014-BSS	3/0-4/0	Red	Retail/1
4015-BSS	3/0-4/0	Black	Retail/1

## ST Blade Battery Terminal Mount Fuse Block

Easily add 4 fused circuits to the terminal of a battery. Provides power to new accessories in your boat or vehicle.



- Mounts on the battery terminal stud
- Screw terminals for securing wires
- Nylon insulated ring terminals included for each screw terminal
- Accepts small format circuit labels
- Ignition Protected—for use in a gasoline engine compartment
- Includes write-on circuit labels
- Includes four 16–14 AWG and four 12–10 AWG Nylon insulated ring terminals
- Fuses sold separately (page 53)

### Specifications

Voltage Max Operating	32V DC
Amperage Max Operating	30A per circuit
Amperage Max Operating	100A per block
Fuse Type	ATO® or ATC® Fuses
Bus Material	Tin-Plated Copper C11000
Mounting Thru-hole	Clearance for 3/8" [M10] stud
Screw Terminal	#8–32 Screws with captive star lock washer

### Regulatory

Meets ISO 8846 and SAE J1171 external ignition protection requirements

Part #	Description
5023-BSS	ST-Blade Battery Terminal Mount Fuse Block

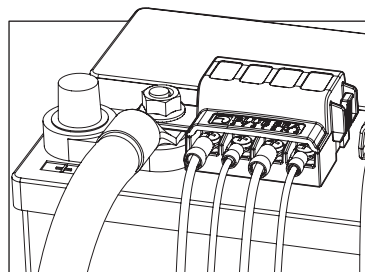

## Battery Terminal Mount BusBars

Easily add positive and negative busbars to the battery terminals



- Easily add positive and negative busbars directly to a threaded-post battery terminal
- Tin-plated pure electrical copper for maximum conductivity
- Screw terminals for securing wires
- Includes four 16–14 AWG and four 12–10 AWG nylon Insulated ring terminals

### Specifications

Continuous Rating	100A DC
Voltage Max Operating	32V DC
Bus Material	Tin-Plated Copper C11000
Mounting Thru-hole	Clearance for 3/8" [M10] stud
Screw Terminal	#8–32 Screws with captive star lock washer

Part #	Description
2340-BSS	Positive + Negative

## ST Blade Battery Terminal Mount Fuse Block Kit

Easily add 4 fused circuits to the terminal of a battery. Provides power to new accessories in your boat or vehicle.



5024-BSS ST-Blade Terminal Mount Fuse Block Kit installed on a sealed battery

Part #	Description
5024-BSS	ST-Blade Battery Terminal Mount Fuse Block Kit



## AGC® Fuses

Fast-acting glass fuses

- Visible indication of blown condition



### Specifications

Voltage Max Operating 32V DC / See table for AC  
Blow Time Delay

Part #	Amps	Volts	Retail Pack
5201-BSS	.25A	250V AC	5
5202-BSS	.5A	250V AC	5
5204-BSS	1A	250V AC	5
5205-BSS	1.5A	250V AC	5
5206-BSS	2A	250V AC	5
5207-BSS	2.5A	250V AC	5
5208-BSS	3A	250V AC	5
5209-BSS	4A	250V AC	5
5210-BSS	5A	250V AC	5
5211-BSS	6A	250V AC	5
5212-BSS	7A	250V AC	5
5213-BSS	7.5A	250V AC	5
5215-BSS	10A	250V AC	5
5217-BSS	15A	--	5
5218-BSS	20A	--	5
5219-BSS	25A	--	5
5220-BSS	30A	--	5
5288-BSS	1A, 3A, 5A, 10A, 15A		5
5289-BSS	4 each 1A, 2A, 3A, 5A, 7.5A, 10A, 15A, 20A, 25A, 30A		40

## ATM® Fuses

Mini blade-type fuse

- Color-coded for easy identification
- Visible indication of blown condition
- Tin-plated connector blades for corrosion resistance



### Specifications

Interrupting Capacity 1,000A  
Voltage Max. Operating 32V DC  
Blow Time Delay

Part #	Amps	Retail Pack
5261	2A	2
5262	3A	2
5263	4A	2
5270	5A	2
5264	7.5A	2
5271	10A	2
5272	15A	2
5273	20A	2
5265	25A	2
5274	30A	2
5286	5A, 10A, 15A, 20A, 30A	5

## easyID™ ATC® Fuses

Fast-acting easyID™ illuminated blade fuses use Light Emitting Diode (LED) technology to show when a fuse has blown.



- Color-coded for easy identification
- Visible indication of blown condition
- Tin-plated connector blades for corrosion resistance

### Specifications

Interrupting Capacity 1,000A  
Voltage Max Operating 32V DC  
Blow Time Delay

Part #	Amps	Retail Pack	Part #	Amps	Retail Pack
5291-BSS	3A	2	5298-BSS	30A	2
5292-BSS	5A	2	5299-BSS	40A	2
5293-BSS	7.5A	2			
5294-BSS	10A	2	5290-BSS	3x 3A, 3x 5A, 3x 7.5A, 3x 10A, 6x 15A, 3x 20A, 3x 25A, 3x 30A, 3x 40A	30
5295-BSS	15A	2			
5296-BSS	20A	2			
5297-BSS	25A	2			

## ATO® or ATC® Fuses

Fast-acting blade fuse

- Color-coded for easy identification
- Visible indication of blown condition
- Tin-plated connector blades for corrosion resistance



### Specifications

Interrupting Capacity 1,000A  
Voltage Max Operating 32V DC  
Blow Time Delay

Part #	Amps	Retail Pack	Part #	Amps	Retail Pack
5235-BSS	1A	2	5243-BSS	20A	2
5236-BSS	2A	2	5244-BSS	25A	2
5237-BSS	3A	2	5245-BSS	30A	2
5238-BSS	4A	2	5246-BSS	40A	2
5239-BSS	5A	2	5287-BSS	5A, 10A, 15A, 20A, 25A, 30A	6
5240-BSS	7.5A	2			
5241-BSS	10A	2			
5242-BSS	15A	2			

## ATO® or ATC® In-Line Fuse Holders

In-Line

- Supplied with 12 AWG pigtails
- 30A Max fuse amperage
- Fuse sold separately (page 53)



Waterproof In-Line

- Supplied with 12 AWG pigtails
- 30A Max fuse amperage
- Fuse sold separately (page 53)



## ANL Fuses

For 35A to 750A  
circuit protection

- Silver-plated connector blades for corrosion resistance
- Visible indication of blown condition

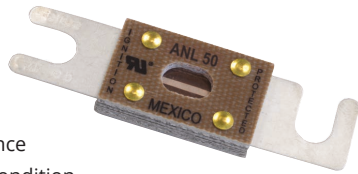

### Specifications

Interrupting Capacity 6,000A @ 32V DC  
Voltage Maximum Operating 32V DC  
Trip Time Delay

### Regulatory

35-500A ONLY—Meets SAE J1171 external ignition protection requirements

Part #	Amps	Retail Pack
5164-BSS	35A	1
5165-BSS	40A	1
5122-BSS	50A	1
5123-BSS	60A	1
5124-BSS	80A	1
5125-BSS	100A	1
5126-BSS	130A	1
5127-BSS	150A	1
5128-BSS	175A	1
5129-BSS	200A	1
5131-BSS	250A	1
5133-BSS	300A	1
5135-BSS	350A	1
5136-BSS	400A	1
5137-BSS	500A	1
5161-BSS	600A	1
5163-BSS	750A	1

## Class T Fuses

High interrupt capacity for  
large battery banks including  
Lithium-Ion and TPPL batteries

- Extremely fast short-circuit response
- Recommended by most inverter manufacturers



### Specifications

Interrupting Capacity 20,000A @ 160V DC  
Voltage Max Operating 160V DC  
Trip Time Delay

### Regulatory

UL listed to standard 248-15

Part #	Amps	Retail Pack
5117-BSS	225A	1
5118-BSS	250A	1
5119-BSS	300A	1
5120-BSS	350A	1
5121-BSS	400A	1

## AGC® In-Line Fuse Holders

### Crimpable In-Line

- Accepts 12–16 AWG wire
- 30A Max fuse amperage
- Fuse sold separately (page 53)



5060-BSS

### Waterproof In-Line

- Accepts 12–18 AWG wire
- 30A Max fuse amperage
- Fuse sold separately (page 53)



5061-BSS

### Heavy Duty In-Line

- Supplied with tinned copper
- 12 AWG pigtails
- 30A Max fuse amperage
- Fuse sold separately (page 53)



5063-BSS

## Terminal Fuses

### MRBF—Marine Rated Battery Fuse

Space-saving ignition protected fuse  
for 30 to 300 Amp loads. Must use  
with Terminal Fuse Block (page 55)

- Color-coded for easy identification
- Visible indication of blown condition



### Specifications

Interrupting Capacity 10,000A @ 14V DC  
5,000A @ 32V DC  
2,000A @ 58V DC  
Voltage Max Operating 58V DC  
Fuse Hole Opening M8 (5/16")  
Trip Time Delay

### Regulatory

Meets SAE J1171 external ignition protection requirements  
IP66—protected against powerful water jets

ABYC E-11.10.1.1.1. Overcurrent Protection Device Location—  
Ungrounded conductors shall be provided with overcurrent protection  
within a distance of seven inches (175mm) of the point at which the  
conductor is connected to the source of power measured along the  
conductor

Part #	Amps	Color	Retail Pack
5175-BSS	30A	LT Green	1
5176-BSS	40A	LT Blue	1
5177-BSS	50A	Red	1
5178-BSS	60A	Gold	1
5180-BSS	75A	Brown	1
5181-BSS	80A	Lime	1
5182-BSS	90A	Purple	1
5183-BSS	100A	Yellow	1
5184-BSS	125A	Green	1
5185-BSS	150A	Orange	1
5186-BSS	175A	White	1
5187-BSS	200A	Blue	1
5189-BSS	250A	Pink	1
5190-BSS	300A	Gray	1



## ST Glass Fuse Blocks

Innovative design allows for labeling, spare fuse storage, and easy fuse removal



- Can be used for 24-hour circuits
- Screw terminals for securing wires
- Integrated fuse ejector levers
- Clear insulating cover accepts large format labels, and provides storage for spare fuses
- Tin-plated phosphor bronze fuse clips cannot be sprung
- One-piece stainless flange nuts ensure safe and secure connections
- Fuses sold separately (page 53)

### Specifications

Voltage Max Operating	32V DC
Amperage Max Operating	30A per circuit
Amperage Max Operating	100A per block
Fuse Type	AGC® or MDL® Fuses
Screw Terminal	#8-32 with captive star lock washer
Mounting	#8 Screw (M4)

Part #	Circuits	Tin-plated copper negative bus
5015-BSS	6	#10-32 stud

## Terminal Fuse Blocks

Designed to mount on a 3/8" battery post, battery switch, or bus bar

- Appropriate for DC Main and inverter circuit protection applications
- Weatherproof—ideal for towables or anywhere there may be partial exposure to the elements
- Insulating cap prevents accidental shorts
- Fuses sold separately (page 54)



### Specifications

Voltage Max Operating	58V DC
Amperage Max Operating	300A
Terminal Fuses Available	30-300 Amps

### Regulatory

Meets SAE J1171 external ignition protection requirements

Part #	Terminal Stud Size	Mounting Hole	Fuses
5191-BSS	M8 (5/16"-18)	3/8"	1
2151-BSS	M8 (5/16"-18)	3/8"	2

## Class T Fuse Block

Allows use of Class T fuses for fast acting circuit protection of inverters

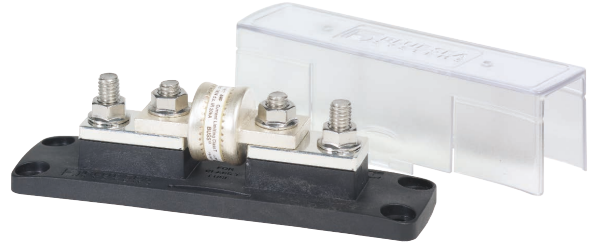

- Four stud design provides ample access around connecting stud to install large cable lugs without obstruction from the fuse
- Accepts 3/8" (M10) ring terminals
- Clear insulating cover breakouts allow wire access in any direction
- Insert molded studs ensure secure fuse mounting
- Stainless steel studs provide resistance to corrosion and high torque
- One-piece stainless flange nuts ensure safe and secure connections
- UL 94-V0 base resists high heat
- Fuse sold separately (page 54)

### Specifications

Voltage Max Operating	160V DC
Amperage Max Operating	400A
Cable Size	Up to 4/0AWG (120 mm <sup>2</sup> )
Fuse Mounting Blocks	Tin-Plated Copper
Class T Fuses available	225-400 Amps

Part #	Terminal Stud	Mounting
5502-BSS	3/8"-16 (M10)	1/4" (M6) Screws

## ANL® Fuse Blocks

Accepts a wide range of ANL fuse amperages for versatile fusing



- Swing out design allows replacement of the fuse without removing fasteners
- Accepts 5/16" (M8) ring terminals
- Clear insulating cover breakouts allow wire access in any direction
- Insert molded studs ensure secure fuse mounting
- Stainless steel studs provide resistance to corrosion and high torque
- One-piece stainless flange nuts ensure safe and secure connections
- UL 94-V0 base resists high heat
- Fuse sold separately (page 54)

### Specifications

Voltage Max Operating	32V DC
Amperage Max Operating	750A
Terminal Stud Size	5/16"-18 (M8)
Cable Size	Up to 4/0 AWG
Fuse Mounting Blocks	Tin-Plated Copper
ANL Fuses Available	35-750 Amps

Part #	Terminal Stud	Mounting
5503-BSS	5/16"-18 (M8)	1/4" (M6) Screws

## ST Blade Compact Fuse Blocks

Provides surface mount circuit protection for ATO®/ATC® Fuses in a compact footprint. The single side design allows wire entry from one side to maximize space.

- Common source fuse block
- Accepts ATO and ATC fast acting blade fuses
- Single side entry wiring
- Ignition Protected—meets ISO 8846 and SAE J1171 for use in a gasoline engine compartment
- Clear insulating cover accepts small format labels
- Tin-plated copper buses and fuse clips
- Accepts ring or snap fork type terminals
- Fuses sold separately (page 53)

### Specifications

Voltage Max Operating	32V DC
Amperage Max Operating	30A per circuit
Amperage Max Operating	100A per block
Fuse Type	ATO or ATC Fuses
Screw Terminal	#8-32 Screws with captive star lock washer
Mounting	#8 Screw (M4)



5045-BSS



5046-BSS

Part #	Circuits
5045-BSS	4
5046-BSS	8

## ST Blade Split Bus Fuse Block

For use when a mix of switched and 24-hour circuits are desired in the same block

- Common and/or independent source fuse block
- Provides two isolated groups of six ATO/ATC circuits
- For use with either two isolated batteries or with a single battery providing a mix of 24-hour and switched circuits
- Clear insulating cover with provision to store two spare fuses
- Accepts ring terminals
- Easy to open, push button latch provides easy access to fuses
- Tin-plated copper buses and fuse clips
- Includes 20 write-on circuit labels
- Includes fuse puller
- Fuses sold separately (page 53)

### Specifications

Voltage Max Operating	32V DC
Amperage Max Operating	30A per circuit
Amperage Max Operating	100A total (not to exceed 80A per load group)
Fuse Type	ATO or ATC Fuses
Screw Terminal	#8-32 Screws with captive star lock washer
Mounting	#8 Screw (M4)
Recommended Wire Size	Positive Feed: 4-6 AWG (25-16 mm <sup>2</sup> ) Branch Circuits: 10-16 AWG (6-15 mm <sup>2</sup> )
Recommended Torque	#10 Stud: 24 in-lb (2.71 N-m) #8 Screw: 18 in-lb (2.03 N-m)



### Application Diagram

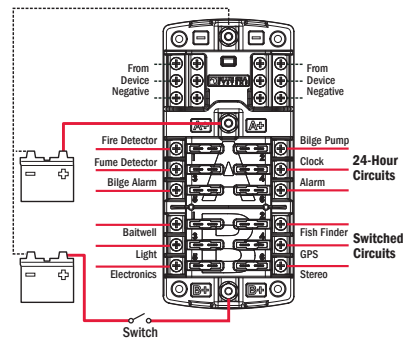

Part #	Circuits	Negative Bus	Positive Bus
5032-BSS	12	#10-32 stud	#10-32 stud



# ST Blade Fuse Blocks

Fuse block consolidates branch circuits and in-line fuses

- Common source fuse block
- Screw terminals for securing wires accept ring terminals
- One-piece stainless flange nuts ensure safe and secure connections
- Clear insulating cover with provision to store two spare fuses
- Easy to open, push button latch for easy access to fuses
- Tin-plated copper buses and fuse clips
- Fuse blocks with covers include 20 write-on circuit labels small format standard and custom labels available
- Fuses sold separately (page 53)

## Specifications

Voltage Max Operating	32V DC
Amperage Max Operating	30A per circuit
Amperage Max Operating	100A per block
Fuse Type	ATO® or ATC® Fuses
Screw Terminal	#8-32 Screws with captive star lock washer
Mounting	#8 Screw (M4)

## Application Diagram

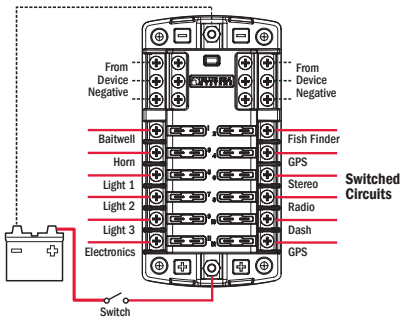

Part #	Circuits	Cover	Negative Bus	Positive Bus
5025-BSS	6	Yes	#10-32 stud	#10-32 stud
5028-BSS	6	Yes	--	#10-32 stud
5026-BSS	12	Yes	#10-32 stud	#10-32 stud
5029-BSS	12	Yes	--	#10-32 stud



5028-BSS



5025-BSS



5029-BSS



5026-BSS

## Circuit Breaker Panels

Circuit breakers with integrated and illuminated on indication

- Molded panel frame will stand up to UV and salt air
- Low profile makes it easy to install in tight spaces
- Red "ON" indicating LEDs for safe operation in low light conditions
- Panel surface is UV-stabilized, flame retardant, and will not corrode
- Integrated bus bars eliminate wire harnesses and clutter behind the panel
- Two-wire connection for powering all panels is simple and requires #10 ring terminals. Terminals screw to bus bars for secure connections.
- Set of 15 square format circuit labels are included

### Specifications

Operating Voltage	12V DC Nominal
Max Total Continuous	45A
Circuit Breaker Rating	15A
Required Ring Terminal	M5 (#10)
Circuit Breaker Positive Load Terminal	.25" Male quick connect
Maximum Terminal Stud Torque	2.25 N-m (20 in-lb)
Maximum Mounting Screw Torque	1.13 N-m (10 in-lb)

Part #	Description
4350-BSS	4 Position
4352-BSS	6 Position
4351-BSS	4 Position with 12V Sockets



4350-BSS



4351-BSS



4352-BSS

## 285 Series Circuit Breakers

When switching and circuit protection are both required

- Visible yellow reset lever shows open condition
- Trip-free design cannot be held closed after trip
- Surface mount

### Specifications

Interrupting Capacity	3,000A @ 48V DC
Voltage Max Operating	48V DC
Type	Thermal
Class	Type III—Switchable Manual Reset—Trip Free
Terminal Stud	M6 (accepts 1/4" Ring Terminal)
Terminal Stud Torque	50 in-lb (7.9 Nm)
Mounting Hole	Accepts 1/4" screw (M6)

### Regulatory

CE marked, Meets SAE J1171 external ignition protection requirements  
IP67—protected against immersion up to 1 meter for 30 minutes



7187-BSS

Part #	Amps
7180-BSS	25A DC
7181-BSS	30A DC
7182-BSS	40A DC
7183-BSS	50A DC
7184-BSS	60A DC
7185-BSS	70A DC
7186-BSS	80A DC
7187-BSS	100A DC
7188-BSS	120A DC
7189-BSS	150A DC



## Water-Resistant USB Accessory Panel

Easy to install accessory panel includes a 15A circuit breaker switch and pre-wired harness.

- Pre-wired harness included with panel for easy installation
- Silicone breaker boots and gasket protects against water ingress
- Illuminated Carling Technologies 15A circuit breaker switch allows the ability to shut off panel preventing parasitic draw
- Polycarbonate/ABS panel face is UV-stabilized, flame retardant, and will not corrode
- 12V DC only

### Regulatory

CE Certified, IP66—protected against powerful water jets



Part #	Description
4363-BSS	12V DC Receptacle & Dual USB Charger Panel

## 12/24V Dual USB 4.8A Chargers

Intelligent device recognition allows rapid charging of phones, tablets, or other mobile devices



1039-BSS



1045-BSS

- Maximizes charge rate with intelligent device recognition
- Reduced electronic interference with additional filtering
- Over temperature protection
- Protective dust cap keeps debris and moisture out
- Engineered for the harsh marine environment
- 1039 Mounts in an existing contura switch aperture
- 1045 Mounts in a common 1-1/8" hole

### Specifications

Maximum Output Current	4.8A DC (total)
Output Voltage	5V DC ±5%
Port Configuration	Intelligent Device Recognition
Parasitic Current Draw	1mA
Thermal Overload Protection	Yes
Short Circuit Protection	Yes
Reverse Polarity Protection	Yes
USB	2.0, Type A
Cutout Dimensions in (mm)	1039—1.45" × 0.83" (36.83 × 21.08 mm) 1045—1-1/8" (29 mm) diameter

### Regulatory

RoHS, CE Certified

Part #	Input Voltage	Input Voltage Range	Description
1039-BSS	12V / 24V DC	9V-32V DC	4.8A Switch Mount Charger
1045-BSS	12V / 24V DC	9V-32V DC	4.8A Socket Mount Charger

## DeckHand™ Dimmers

Digitally controls dimming of non-regulated LED, incandescent, and halogen lights



7508-BSS



8216-BSS  
Pole/Throw: SPDT  
Action: (ON)-OFF-(ON)

- Illuminated exit with adjustable time delay
- Supports multiple switch locations
- Memory for last dimmer setting
- Bulb saver prevents bulb aging while batteries are being charged
- Provides continuous voltage control from 0 to 100% of input voltage
- Offset mounting tabs allow dimmers to be mounted close together
- Retail package includes momentary (ON)-OFF-(ON) switch

### Specifications

Maximum Parasitic Current	<2mA
Temperature Rating	-40°C to 85°C

### Regulatory

CE marked

Meets ISO 8846 and SAE J1171 external ignition protection requirements

Part #	Amps	Volts	Operating Range	Width in (mm)	Height in (mm)	Depth in (mm)
7506-BSS	6A	12V DC	9V-16V	3.23 (82.0)	3.47 (88.1)	1.30 (33.0)
7507-BSS	12A	12V DC	9V-16V	3.23 (82.0)	3.47 (88.1)	1.30 (33.0)
7508-BSS	25A	12V DC	9V-16V	3.23 (82.0)	3.47 (88.1)	1.30 (33.0)

## Mini OLED DC Voltmeter

Monitors DC voltage on a bright, waterproof, daylight readable OLED screen

- Compact size enables mounting in any convenient location
- IP66 waterproof
- Reverse polarity protected
- Mounts in a common 1-1/8" in hole



### Specifications

Nominal Voltage	12V / 24V DC
Voltage Accuracy	± 1.0%
Voltage Range	8V-36V DC
Maximum Operating Current	15mA
Resolution	0.01V DC
Cutout Dimensions in (mm)	1-1/8" (29 mm) diameter

### Regulatory

IP66—protected against powerful water jets

Part #	Description
1733-BSS	Mini OLED DC Voltmeter

## The importance of a quality DC electrical system

The ParkPower® 12 volt family of products are manufactured from corrosion resistant marine grade materials. Exclusive to ParkPower is a unique interconnecting system that securely locks the plug into the receptacle resulting in a positive and moisture resistant connection. The plug and receptacle feature optimized metal connection points for maximum conductivity.

**5 YEAR WARRANTY**

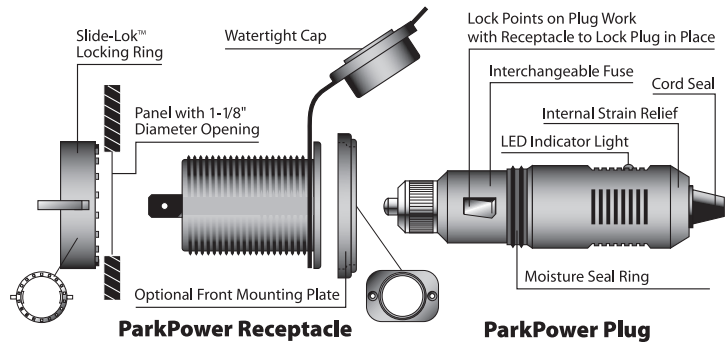

### Deluxe 12V Receptacle

- Watertight sealing cap
- Easy to install, with supplied mounting plate for front panel installation, or locking ring for rear access installation
- Compatible with standard 12V plugs

12VRCRV



### Deluxe 12V Plug

- Moisture proof sealing ring
- LED power indicator light
- Interchangeable 10A fuse
- Internal strain relief and cord seal
- Compatible with standard 12V receptacles
- Maximum rating is 10 amps

12VPGRV



### Deluxe 12V Receptacle & Plug

- 12VRC and 12VPG packaged together

12VPKRV



### Deluxe 12V Extension Cord

- Heavy duty 18 gauge wire, extends to over 6 feet
- Watertight cap
- Plug features an LED indicator light, moisture proof sealing ring, strain relief and built-in 10A fuse
- Locking system
- Works with any standard 12V plug and receptacle

12VXTRV



### Deluxe 12V Dual Outlet Cord

- Heavy duty 18 gauge wire, extends to over 1 foot
- Watertight caps
- Plug features an LED indicator light, moisture proof sealing ring, strain relief and built-in 10A fuse
- Locking system
- Works with any standard 12V plug and receptacle

12VADRV



### Deluxe Dual USB Charger Receptacle

- 12V to 24V DC input
- 5V, 2.1 amp total output
- LED power indicator light for USB
- Water resistant cover protects against dust and water
- Insulated terminals included

12VDUSBRV



### Deluxe Dual USB Charger & 12V Receptacle

- 12V DC input
- Dual USB has 5V, 2.1 amp total output
- LED power indicator light for USB
- Receptacle has 12V DC output, rated up to 20 amps
- Water resistant covers protects against dust and water
- Insulated terminals included

12VCOMBORV

**5 YEAR WARRANTY**

## ProMariner™ Cup Holder Power Inverter

Converts 12 Volt Power to 110V AC up to 150 Watts

Perfect for the on-board or on-the-road active user who needs to convert 12 Volt battery power to 110V AC. While on the water or in your car, provide instant AC power for laptops, cell phone chargers, radios, portable TV's, lighting, fax machines, camcorders, small power tools and more.

- Recharge and Power Portable Electronics—Power devices from your car, RV, camper and more
- On the Road Power—Use with digital cameras, MP3 players, game consoles portable DVD players, laptops, TVs and more
- Extruded Aluminum Case
- Universal Cupholder Design
- High Surge Capacity
- Power / Status LED Indicators
- Standard 110V AC Receptacle
- Output Short & Input Polarity Protection
- Low Battery Shutdown
- Over Temperature and Overload Protection

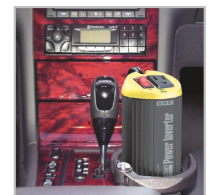

Fits in your cupholder

Model	Part #	Surge Capability	Input	Output	Frequency	Size (LxWxH)	Cable Length
ProSport Power Inverter	79018	250 W	12V DC	110V AC	60 Hz	2.625"x 2.625"x6"	3 ft



# POWER CONVERSION

## ***On Board Solutions***

*A ProMariner Company*

On Board Solutions is the RV/Industrial side of ProMariner and leverages the 30+ years of knowledge to design, test and manufacture innovative and reliable power conversion products for the RV user. The products are designed for ease of use, including communication of information and performance levels. Vigorous testing is done to ensure products exceed performance requirements in tough environment conditions. Products are tested throughout the manufacturing process to verify quality levels are met and the products coming off the end of the line are ready for use.



# POWER CONVERSION

**TruePower Plus  
Pure Sine Wave Inverter**

64



**TruePower Plus  
Modified Sine Wave Inverter**

64



**CombiMaster Inverter/Charger —  
CZone®/MasterBus Compatible**

66



Our next generation of TruePower Plus inverters are available in both Modified Sine Wave (MS) and Pure Sine Wave (PS) models. Designed to convert 12V DC battery power to 115V AC and will automatically pass through AC Inlet power when present.

The CombiMaster inverter/charger delivers pure sine wave inverter power and multi-chemistry battery charging plus the intelligent new design communicates seamlessly with NMEA 2000.



## TruePower Plus Series Heavy Duty Marine, Mobile and Industrial Grade Inverters

Our next generation of TruePower Plus Inverters are available in both Modified Sine Wave (MS) and Pure Sine Wave (PS) models. Designed to convert 12V DC battery power to 115V AC and will automatically pass through AC Inlet power when present. TruePower Plus is rich with features including; Innovative dual color digital LCD message center, dual color gauges for AC power output and battery DC input, USB power port, GFCI convenience outlets, DC cable covers, and separate on/off remote. Our integrated AC cable strain reliefs and front screw connection terminal blocks allow for quick and easy installation without the added need for ring terminals for AC power connections.

Designed with soft start noise filtered technology and x2 surge capability for powering demanding loads. Shock resistant construction with internal conformal coated electronics for protection in harsh environments.

The TruePower Plus PS Series has all the features of our MS series but provides a Pure Sine 115V AC output ideal for high fidelity audio visual systems in addition to appliances with hysteresis and variable motor speed controls like washing machines and refrigeration etc.

- Intuitive dual color digital LCD message center
- Dual color gauges for AC power output and battery DC input
- Internal 30 amp AC transfer switch will automatically pass through AC inlet power when present
- USB power port and GFCI convenience outlets
- Compact and lightweight design
- Soft start noise filtered technology with x2 surge capability
- On/Off remote with 9 foot cable and DC cable covers Included
- Integrated AC power cable strain reliefs for ease of installation
- Built-in safety with overload, over temperature, short circuit and reverse polarity protection
- Audible alarm and shut down for low and high DC voltage, overload and over temperature conditions.
- Shock resistant construction with internal conformal coated electronics
- 2 year warranty



Pure Sine Wave  
TECHNOLOGY



Modified Sine Wave



Intuitive Dual Color Display and LCD Message Center



USB 5V DC/2.1 Amp Port GFCI Protected Outlets



Integrated AC Power Strain Reliefs with Front Screws



DC Cable Covers Black (-) and Red (+)



Conforms to:  
UL STD. 485  
CSA STD. C22.2 No. 107.2  
FCC Class B

Designed and  
Constructed to:  
ABYC-A-31  
Setting Standards for Safer Boating





Model	TruePower Plus 1000ps	TruePower Plus 2000ps*	TruePower Plus 1200ms	TruePower Plus 1500ms	TruePower Plus 2000ms*
Part #	07100	07200	06120	06150	06200
Wattage	1000 Watts	2000 Watts	1200 Watts	1500 Watts	2000 Watts
Surge Rating	2000 Watts	4000 Watts	2400 Watts	3000 Watts	4000 Watts
Sine Wave	Pure	Pure	Modified	Modified	Modified
Efficiency (optimum)	>90%	>90%	>90%	>90%	>90%
AC Output	115V AC 60Hz	115V AC 60Hz	115V AC 60Hz	115V AC 60Hz	115V AC 60Hz
Internal AC Transfer Switch	30 Amps	30 Amps	30 Amps	30 Amps	30 Amps
AC Crossover Time	<30 ms	<30 ms	<30 ms	<30 ms	<30 ms
DC Input	11-15V DC	11-15V DC	11-15V DC	11-15V DC	11-15V DC
Inverter Off DC Amp Draw	4 mA	4 mA	4 mA	4 mA	4 mA
Size	4" x 9.9" x 11.5"	4.5" x 10.6" x 11.5"	4" x 9.9" x 11.5"	4" x 9.9" x 11.5"	4.5" x 10.6" x 11.5"
Weight	7.3 lbs	9.0 lbs	7.3 lbs	7.3 lbs	9.0 lbs

\*Available Q2 2017



### TruePower Plus Remote (included)

- On/Off control
- Input power source LED indicators
- Check fault LED indicator
- Remote mounting screws and 9 ft. cable included



### TruePower Plus Display Functions

#### DC to AC Output Gauge

Indicates percentage of AC power being used versus output rating. The scale turns red when output demand exceeds output rating.

#### Input Power

Indicates if power is coming from DC (batteries) or AC inlet power.

#### DC Input Level Gauge

Indicates the battery DC voltage level. The scale turns red when battery voltage drops below 11.0 volts.

#### System Status

Dual color LCD with full system normal and fault condition messaging (no codes).

#### Check

Illuminates when a fault condition is present with LCD message.

### Application Guide

35W Smartphone / Tablet	100W Can Opener / Coffee Grinder	150W 32"-55" Flat Screen TV	175W Laptop Computer	300W Portable Ice Maker	500W Vacuum	550W Washing Machine	600W Blender / Food Processor	700W Portable Dishwasher	750W Full Size Fridge & Freezer	800W Small Coffee Maker	900W Toaster	1000W Small Microwave	1200W Coffee Maker	1500W Electric Grill	1800W Toaster Oven	2000W Large Air Conditioner
TruePowerPlus1000ps													TruePowerPlus1200ms			
TruePowerPlus1500ms													TruePowerPlus2000ps			
TruePowerPlus2000ms																

The items listed above are intended for reference only. Appliance specifications may vary. Certain appliances and tools require a higher surge power in order to start up. To compute the actual wattage of a device, determine the amperage rating, and multiply by the AC voltage (A x V = W). For example: 10 Amps x 115 Volts = 1150 Watts.

### TECH TIP

#### Pure Sine vs Modified Sine

Modified and Pure Sine Wave Inverters are intended for different applications. Pure Sine Wave inverters can be used anywhere that the Modified Sine Wave inverters are used, as well as additional applications.

**Modified Sine Wave** is primarily for resistive loads like coffee makers, toasters, grills, and more.

**Pure Sine Wave** is primarily for active loads like air conditioners, refrigerators, microwaves and more.

See chart on left for more applications by inverter type and size.

## CombiMaster

### The most compact, lightweight inverter/charger on the market today

Introducing the new CombiMaster Inverter / Charger from Mastervolt. CombiMaster is the coming together of sophisticated industrial design, and groundbreaking technology to deliver pure sine wave inverter power and multi-chemistry battery charging plus the ability to integrate into a power conversion system. All in a small, space-saving footprint!

#### Integration

CombiMaster is designed to easily integrate into network systems. Its intelligent design communicates seamlessly with NMEA 2000, CZone, and MasterBus networks. This allows full system functionality and communication between devices. It also enables critical functions and configurations to be managed from MFDs or CZone displays.

#### Performance

With the widest DC input voltage ranges 10–18V DC and flat battery support at 25% under 10V. The new CombiMaster ensures fast, safe, and efficient charging of your Flooded, AGM, Gel, Li-on batteries.

Wide AC input range (90–135V) insures functionality of AC devices even with adverse input power conditions.

#### Durability

The new CombiMaster was designed and built to work in the harsh marine environment with ignition protection.

Innovative microprocessor functionality delivers true rated output even at elevated temperatures up to 104°F (40°C).

Highest efficiency rating of any inverter/charger on the market (93%).

#### Simplification

The construction of CombiMaster inverter/charger allows both vertical and horizontal mounting orientations, while maintaining access to the cables and LEDs. This simplifies placement and installation of the unit.

#### Intuitive Design

Easily accessible connectors simplify installation. Bright, easy-to-read LEDs provide real time performance status and functionality.



**Conforms to:**  
UL STD. 485  
CSA STD. C22.2 No. 107.2  
FCC Class B

**Designed and Constructed to:**  
ABYC A-31



Certifications pending.





## Specifications

Model	12/2000-100	12/3000-160
Part #	35512000	35513000
Continuous Power Rating 104°F/40°C	2000W	3000W
Surge Power (200%)	4000W	6000W
AC Voltage/Frequency	120V-60Hz	120V-60Hz
Technology	HF - Pure sine wave	HF - Pure sine wave
Idle Power Full	34 W	34 W
Efficiency - CEC	93%	93%
DC Input Voltage (nominal)	12V	12V
DC Output (full power)	10-15V	10-15V
Flat Battery Support (min charging)	Yes*	Yes*
Continuous Battery Charge Output	100A DC @ 14.25V	160A DC @ 14.25V
Min Battery Voltage for Charging	0.0V DC	0.0V DC
Power Factor	0.98	0.98
Full load -Max AC Input Current	16.5A	25A
Battery Chemistry	Flooded, AGM, Gel, Li-on	Flooded, AGM, Gel, Li-on
Transfer (time)	30A (10ms)	30A (10ms)
Indication	LEDs	LEDs
Communication	CZONE / NMEA 2000 / MasterBus	
Operating Temp Range	-13-140°F (-25-60°C)* (Derating ≥ 104°F/40°C, Shutdown at 140°F/60°C, auto recover after cooling down)	
Derate	power/ 33.8°F (1°C)	power/ 33.8°F (1°C)
Protections	IP23/IP21 Indoor use depending on mounting orientation. PCB protected against dust and moisture by conformal coating.	
Input Protection	Over/Under Voltage, Reverse Polarity (Internal Fuse)	
Unit Dimensions	17.63" x 11.30" x 6.10"	17.63" x 11.30" x 6.10"
Weight	16.7 lbs	18.7 lbs
Warranty	2 year	2 year

\*Below 10V @ 25% power.

## Accessories

for CZone and MasterBus communication network

Part #	
77060050	Mastervolt CZone-MasterBus Drop Cable 0.5m
77060100	Mastervolt CZone-MasterBus Drop Cable 1m
77060200	Mastervolt CZone-MasterBus Drop Cable 2m
77060300	Mastervolt CZone-MasterBus Drop Cable 3m
77060500	Mastervolt CZone-MasterBus Drop Cable 5m
77040020	Mastervolt MasterBus cable 0.2m
77040050	Mastervolt MasterBus cable 0.5m
77040100	Mastervolt MasterBus cable 1m
77040300	Mastervolt MasterBus cable 3m
77040600	Mastervolt MasterBus cable 6m
77041000	Mastervolt MasterBus cable 10m
77041500	Mastervolt MasterBus cable 15m
77042500	Mastervolt MasterBus cable 25m



77010500

## SmartRemote

Plug and Play remote for Mastervolt devices

- Plug and play and easy to install
- 1 display per device
- 2.8" TFT IPS full color display with 3 buttons
- Simple control and indication
- Dimensioning in line with BSS 360 panels, as well as DIN specs
- High end and robust look & feel
- CZone/NMEA and MasterBus communication



# VENTILATION





# VENTILATION

## Day/Night Solar Vent

71



Day/Night solar vents offers 24 hour ventilation in a compact footprint. The new design can be removed from the surface and features LED lights and additional controls that are accessed from the interior.

## Mini Vent 1000

71



The MiniVent 1000 is the smallest and most economical solar vent in the Maringo® line. At just 7" in diameter and approximately 1-3/4" high, the MiniVent 1000 is compact yet effective. This solar powered model is an exhaust vent only.





## TECH TIP

### Ventilation Explained

#### Maintenance Ventilation

In most climates, RVs that have been closed for a period of time will become “stuffy.” The temperature differential that develops between the RV cabin and the outdoor environment will cause the humidity level inside the RV cabin to rise. When the humidity level in the closed cabin rises, moisture forms, resulting in mold, mildew and musty air. In these conditions, fabrics and/or RV electronics can be damaged. By consistently replacing trapped, stale air in the closed RV with fresh outside air, the humidity equalizes from inside to outside, resulting in effective maintenance ventilation.

#### Comfort Ventilation

Combining different types of vents, with one vent providing “intake” air flow while another vent provides “exhaust” air flow, creates cross-flow ventilation. A cross-flow ventilation system will make the interior cabin more comfortable and pleasurable because air is constantly moving throughout the cabin. No matter what your RV size or cabin configuration is, you can increase your RVing enjoyment with the addition of ventilation.

#### Safety Ventilation

Most RVers are unaware of the hazards that exist in the RV environment. Any number of serious ventilation problems can occur when an RV is left unattended. And even if you are on the road, these problems don't go away. Fumes and gasses, ranging from carbon monoxide to hydrogen gas from battery charging, to gasoline, propane, or solvents are unpleasant, and can sometimes be dangerous. Also, any open flame devices in the cabin require proper ventilation. Ventilation helps to eliminate these hazards by providing constant air circulation resulting in effective safety ventilation.

#### How Much Ventilation Is Required For Your RV?

Ideally, the air in the interior of a RV should be circulated once every hour. A typical 30-foot RV contains approximately 800 cubic feet of air. As you will see, our solar powered models can move between 600 and 1,000 cubic feet of air every hour. The general guidelines for providing maintenance ventilation are as follows:

RV Length	Recommended Ventilation
Up to 24 ft.	1 Exhaust Vent*
24 to 40 ft.	1 Exhaust Vent & 1 Intake Vent

\* For effective maintenance ventilation, one vent assumes there will be access for air to get into the cabin (i.e., fan vent, clamshell vent or louvered panel)

It is important to evaluate the cabin layout of your RV to determine optimal locations for both intake and exhaust ventilation. These illustrations suggest placement for Marincosolar powered vents and Marincopassive vents.

**Note how the placement of the vents creates cross flow ventilation.**

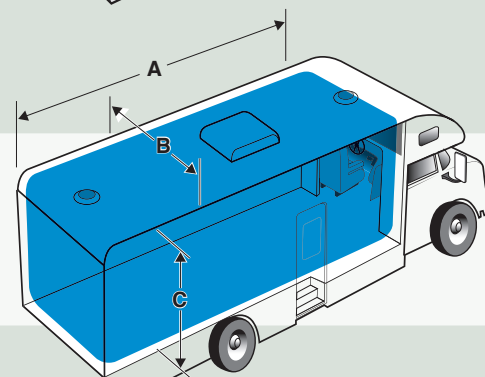
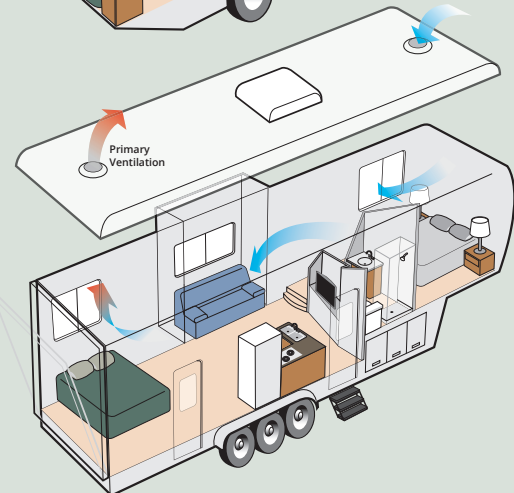

To specifically calculate your RV's air volume, use this simple formula:

$$A \times B \times C \times 70\% = \text{RV Interior Volume}$$

**A** Dimension is the interior length (excluding cockpit)

**B** Dimension is the RV width

**C** Dimension is the average interior height

## Day/Night Solar Vent

- Circulates fresh air in RV cabin eliminating mold, mildew and musty air
- Moves 1,000 cubic feet of air/hour or 24,000 cubic feet of air/day (4" model)
- Rechargeable battery allows for 24-hour continuous operation
- Whisper quiet fan operation
- No wiring required
- Built-in on/off fan switch, LED lights and intake/exhaust switch
- High capacity NiMH battery operates vent for up to 24-hours without sunlight on a full charge
- Threads into included deck plate and can be removed from outside without tools
- Complete air and green water shut-off from below
- All Day/Night Plus models come complete with white plastic interior trim ring, insect screen, mounting hardware and an easy-to-understand installation manual
- **Replaces NICRO 3" & 4" snap-in deck plates (fits existing holes once snap-in deck plates are removed)**

3" White	Part #	N20803W
3" Stainless Steel	Part #	N20803S
4" White	Part #	N20804W
4" Stainless Steel	Part #	N20804S



CE  
2 YEAR WARRANTY

## Mini Vent 1000

The MiniVent 1000 is the smallest and most economical solar vent in the Marincos® line. At just 7" in diameter and approximately 1-3/4" high, the MiniVent 1000 is compact yet effective. This solar powered model is an exhaust vent only. It will keep the RV cabin cool when you need it most, during the hot sunlight hours. Under solar power, the Mini Vent 1000 will move 700 cubic feet of air an hour. At night, even a light breeze will continue to ventilate the RV passively.

Built-in shut-off damper prevents water intrusion in foul weather. Fits a 3-3/4" diameter installation hole. The vent can be retrofitted to an existing hole of up to 6" in diameter. Available in white ABS plastic or stainless steel. Optional stainless steel cover is also available separately.

- Solar powered exhaust ventilation during daylight and passive exhaust at night
- No batteries or wiring required
- Whisper-quiet fan operation
- Durable white ABS construction
- Shut-off damper to prevent water intrusion in foul weather
- Dimensions: 7" diameter X 1-3/4" high
- All MiniVent 1000 models come complete with white plastic interior trim ring, mounting hardware and an easy-to-understand installation manual

3" White	Part #	N20020
3" Stainless Steel	Part #	N20030



CE  
2 YEAR WARRANTY



Part #	Page	Part #	Page	Part #	Page	Part #	Page	Part #	Page
100ELRV	27	1530PA	31	3002-BSS	47	30FCRV	25	5023-BSS	54
100R	27	1530PA-B	31	30153GPA	34	30GOA	20	5024-BSS	54
1039-BSS	61	1530RVDA	33	3015ARV	24	30MPRV	25	5025-BSS	59
103ELRV	26	1530RVDA-B	33	3015RVDA	33	30PSP	35	5026-BSS	59
103RV	26	1550ARV	24	3015RVDA-B	33	30RPC50RV	24	5028-BSS	59
1045-BSS	61	1550PA	31	301ELCB	13	30RPCRV	24	5029-BSS	59
104SPPRV	21	1550PA-B	31	301ELRV	13	30SPP.RV	18	503030YA	33
110R	27	169AYRV	23	301ELRV.BLK	13	30SPPG.RV	18	5030ARV	24
124ARV	21	171ARV	23	301ELRV.G	13	35512000	69	5030RVDA	33
124ARV-25	21	172ARV	23	3030PA	31	35513000	69	5030RVDA-B	33
125A	23	1733-BSS	61	3030PA-B	31	36SPP.RV	18	5032-BSS	58
126A	23	173ARV	23	303SSEL-BRV	13	36SPPG.RV	18	5045-BSS	58
127A	23	174ARV	23	304EL-BRV	13	4001-BSS	53	5046-BSS	58
128A	23	1PCMRV	21	304EL-BRV.BLK	13	4005-BSS	53	5060-BSS	56
12GENC	19	1RPC50RV	24	304EL-BRV.G	13	4006-BSS	53	5061-BSS	56
12VADRV	62	1RPCRV	24	3050ARV	24	4008-BSS	53	5063-BSS	56
12VCOMBORV	63	2001-BSS	53	3050PA	31	4009-BSS	53	5064-BSS	55
12VDUSBRV	63	2002-BSS	53	3050PA-25	31	4010-BSS	53	5065-BSS	55
12VPGRV	62	2003-BSS	53	3050PA-B	31	4011-BSS	53	50ARVIB	30
12VPKRV	62	200BBI.RV	15	3050RVDA	33	4012-BSS	53	50ARVIW	30
12VRCRV	62	200BBIW.RV	15	3050RVDA-B	33	4013-BSS	53	50ARVKIT	16
12VXTRV	62	2151-BSS	57	305CRMB	13	4014-BSS	53	50ARVKIT.BLK	16
150025RV	19	2300-BSS	52	305CRV	26	4015-BSS	53	50ARVREC	35
150050RV	19	2307-BSS	52	305CRV.VPK	26	4350-BSS	60	50AXP	43
150BBI.RV	15	2312-BSS	52	30AGENP	26	4351-BSS	60	50FCRV	25
150BBIW.RV	15	2340-BSS	54	30ARVIB	30	4352-BSS	60	50GENC	19
150SPPRV	21	25GENC	19	30ARVIW	30	4363-BSS	61	50GOA	20
151225RV	19	25SPP.RV	18	30ARVKIT	16	500ELRV	27	50MPRV	25
151250RV	19	25SPPG.RV	18	30ARVKIT.BLK	16	500R	27	50PSP	35
1530ARV	24	3000-BSS	47	30ARVREC	35	5015-BSS	57	50SPP.RV	18

Part #	Page	Part #	Page	Part #	Page	Part #	Page	Part #	Page
50SPPG.RV	18	5182-BSS	56	5238-BSS	55	5295-BSS	55	6353ELRV.G	14
510R	27	5183-BSS	56	5239-BSS	55	5296-BSS	55	6364CRV	27
5117-BSS	56	5184-BSS	56	5240-BSS	55	5297-BSS	55	6364CRV.VPK	27
5118-BSS	56	5185-BSS	56	5241-BSS	55	5298-BSS	55	6373EL-BRV	14
5119-BSS	56	5186-BSS	56	5242-BSS	55	5299-BSS	55	6373ELMB	14
5120-BSS	56	5187-BSS	56	5243-BSS	55	5366CR	26	700RV	48
5121-BSS	56	5189-BSS	56	5244-BSS	55	5369CR	26	701CHRV	48
5122-BSS	56	5190-BSS	56	5245-BSS	55	5502-BSS	57	701HBRV	48
5123-BSS	56	5191-BSS	57	5246-BSS	55	5503-BSS	57	7100	67
5124-BSS	56	5191-BSS	57	5261	55	6006-BSS	46	7180-BSS	60
5125-BSS	56	5201-BSS	55	5262	55	6006200-BSS	46	7181-BSS	60
5126-BSS	56	5202-BSS	55	5263	55	6007-BSS	46	7182-BSS	60
5127-BSS	56	5204-BSS	55	5264	55	6007200-BSS	46	7183-BSS	60
5128-BSS	56	5205-BSS	55	5265	55	6017Y	26	7184-BSS	60
5129-BSS	56	5206-BSS	55	5266CR	26	6018Y	26	7185-BSS	60
5131-BSS	56	5207-BSS	55	5269CR	26	6120	67	7186-BSS	60
5133-BSS	56	5208-BSS	55	5270	55	6150	67	7187-BSS	60
5135-BSS	56	5209-BSS	55	5271	55	6152SPGRV-25	18	7188-BSS	60
5136-BSS	56	5210-BSS	55	5272	55	6152SPGRV-35	18	7189-BSS	60
5137-BSS	56	5211-BSS	55	5273	55	6152SPGRV-50	18	7200	67
5161-BSS	56	5212-BSS	55	5274	55	6152SPRV-25	18	720RV	48
5163-BSS	56	5213-BSS	55	5286	55	6152SPRV-35	18	7506-BSS	61
5164-BSS	56	5215-BSS	55	5287-BSS	55	6152SPRV-50	18	7507-BSS	61
5165-BSS	56	5217-BSS	55	5288-BSS	55	6200	67	7508-BSS	61
5175-BSS	56	5218-BSS	55	5289-BSS	55	6344EL-BRV	14	7611-BSS	50
5176-BSS	56	5219-BSS	55	5290-BSS	55	6344EL-BRV.BLK	14	7615-BSS	51
5177-BSS	56	5220-BSS	55	5291-BSS	55	6344EL-BRV.G	14	7622-BSS	49
5178-BSS	56	5235-BSS	55	5292-BSS	55	6353ELCB	14	7635-BSS	47
5180-BSS	56	5236-BSS	55	5293-BSS	55	6353ELRV	14	7700-BSS	49
5181-BSS	56	5237-BSS	55	5294-BSS	55	6353ELRV.BLK	14	77010500	69



Part #	Page	Part #	Page	Part #	Page
77040020	69	N20020	73	TV6574D.RV	15
77040050	69	N20030	73	TV6574D.RV.G	15
77040100	69	N20803S	73	TV97	15
77040300	69	N20803W	73	TVHDMI6574.B	15
77040600	69	N20804S	73	TVHDRV	15
77041000	69	N20804W	73	WKN48POG	35
77041500	69	P15-30RV	22		
77042500	69	P15-504RV	22		
77060050	69	P30-504RV-25	22		
77060100	69	PSK-30	39		
77060200	69	PSK-50	39		
77060300	69	RBPSK	42		
77060500	69	RRT-30	39		
7715CRV	27	RRT-50	39		
7715ELRV	27	RSM-30	39		
79018	63	RSM-50	39		
8216-BSS	61	RV 14-50P	43		
9001E-BSS	46	RV 14-50R	43		
9003E-BSS	46	S15-30RV	22		
BAG.RV	20	S15-504RV	22		
CBA-5015	43	S30-15RV	22		
CS30-25RV	17	SSP-30X	40		
CS504-25RV	17	SSP-30XL	40		
EMS-HW30C	42	SSP-50X	40		
EMS-HW50C	42	SSP-50XL	40		
EMS-LCHW30	42	STRAP	20		
EMS-LCHW50	42	TT-30P	43		
EMS-PT30X	41	TT-30R	43		
EMS-PT50X	41	TV6574.RV	15		
EMS-RDS	42	TV6574.RV.G	15		