

Optimate 6

12V 6A / 24V 3A

INSTRUCTIONS FOR USE
IMPORTANT: Read completely
before charging.

EN

**MODEL: TM380 / TM381
TM382**

~ **AC: 100 – 240VAC 50-60Hz**
0.36A @ 240VAC 0.92A @ 100VAC

≡ **DC: 72W → 12V ≡ 6A / 24V ≡ 3A**
Thermally adjusted



1 x 12V : 6 - 240Ah
1 x 24V : 3 - 120AH
STD / AGM-MF / GEL / Ca-Ca
(max. Ah rating based on 48 hour charge).

Automatic charger for 12V & 24V lead-acid batteries

LEDs / SELECT

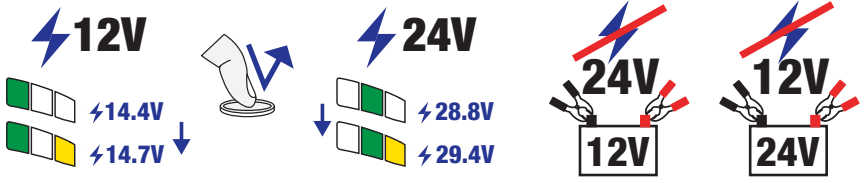

ERROR!

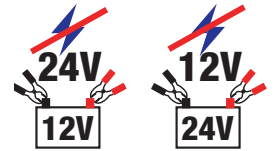
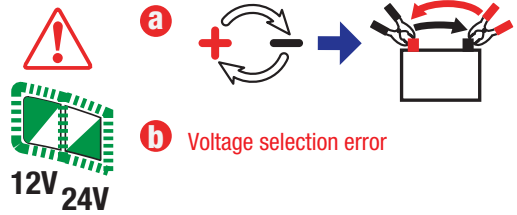

State of Health / S.O.H.

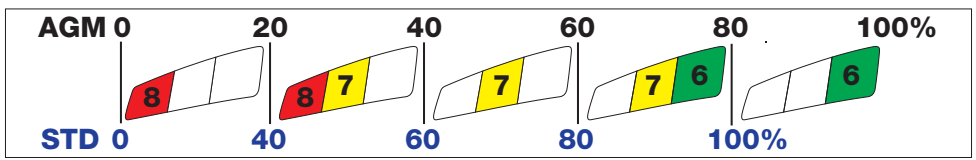

SAVE THESE INSTRUCTIONS. THIS PORTION OF THE MANUAL CONTAINS IMPORTANT SAFETY INSTRUCTIONS FOR THE OPTIMATE 6 12V-24V BATTERY CHARGER. IT IS OF THE UTMOST IMPORTANCE THAT EACH TIME, BEFORE USING THE CHARGER, YOU READ AND EXACTLY FOLLOW THESE INSTRUCTIONS.

EN

Automatic charger for 12 & 24V lead-acid batteries

DO NOT USE FOR NiCd, NiMH, Li-Ion OR NON-RECHARGEABLE BATTERIES.

1. CAUTION : DO NOT CONNECT TO GROUND.
2. Do not expose charger to rain or snow.
3. Use of an attachment not recommended or sold by the battery charger manufacturer may result in a risk of fire, electric shock, or injury to persons.
4. To reduce risk of damage to electric plug and cord, pull by plug rather than cord when disconnecting charger.
5. An extension cord should not be used unless absolutely necessary. Use of improper extension cord could result in a risk of fire and electric shock. If extension cord must be used make sure that :
 - a) pins on plug of extension cord are the same number, size and shape as those of plug on charger.
 - b) the extension cord is properly wired and in good electrical condition, and
 - c) the conductor wire size is large enough for the AC ampere rating of the charger as specified in the table below.

AC INPUT RATING IN AMPERES Equal to or greater than But less than		LENGTH OF CORD, FEET (m)	AWG SIZE OF CORD
2A	3A	25 (17.6) 50 (15.2) 100 (30.5)	18 18 14

6. Do not operate charger with damaged cord or plug – replace the cord or plug immediately.
7. Do not operate charger if it has received a sharp blow, been dropped, or otherwise damaged in any way; take it to a qualified serviceman.
8. Do not disassemble charger; take it to a qualified serviceman when service or repair is required. Incorrect reassembly may result in a risk of electric shock or fire.
9. To reduce risk of electric shock, unplug the charger from outlet before attempting any maintenance or cleaning. Turning off controls will not reduce this risk. Clean only with slightly moist, not wet, cloth. Do not use solvents.
10. WARNING - RISK OF EXPLOSIVE GASES.
 - a) WORKING IN VICINITY OF A LEAD-ACID BATTERY IS DANGEROUS. BATTERIES GENERATE EXPLOSIVE GASES DURING NORMAL BATTERY OPERATION. FOR THIS REASON, IT IS OF UTMOST IMPORTANCE THAT YOU FOLLOW THE INSTRUCTIONS EACH TIME YOU USE THE CHARGER.
 - b) To reduce risk of battery explosion, follow these instructions and those published by the battery manufacturer and manufacturer of any equipment you intend to use in vicinity of the battery. Review cautionary marking on these products and on engine.

11. PERSONAL PRECAUTIONS.

- a) Someone should be within range of your voice OR close enough to come to your aid when you work near a lead-acid battery.
- b) Have plenty of fresh water and soap nearby in case battery acid contacts skin, clothing or eyes.
- c) Wear complete eye protection and clothing protection. Avoid touching eyes while working near battery.
- d) If battery acid contacts or enters eye, flood eye with cold running water for at least 10 minutes and get medical attention immediately. If battery acid contacts skin or clothing, wash immediately with soap and water. If acid enters an eye, immediately flood eye with running cold water for at least 10 minutes and get medical attention immediately.
- e) NEVER smoke or allow a spark or flame in vicinity of battery or engine.
- f) Be extra cautious to reduce risk of dropping a metal tool onto battery. It might spark or short-circuit battery or other electrical part that may cause explosion.
- g) Remove personal metal items such as rings, bracelets, necklaces, and watches when working with a lead-acid battery. A lead-acid battery can produce a short-circuit current high enough to weld a ring or the like to metal, causing a severe burn.
- i) NEVER charge a frozen battery.

SAFETY US & CAN

12. PREPARING TO CHARGE

- a) If necessary to remove battery from vehicle to charge, always remove grounded terminal from battery first. Make sure all accessories in the vehicle are off, so as not to cause an arc.
- b) Be sure area around battery is well ventilated while battery is being charged. Gas can be forcefully blown away by using a piece of cardboard or other non-metallic material as a fan.**
- c) Clean battery terminals. Be careful to keep corrosion from coming in contact with eyes.
- d) Add distilled water in each cell until battery acid reaches level specified by battery manufacturer. This helps purge excessive gas from cells. Do not overfill. For a battery without cell caps, such as valve regulated lead acid (VRLA) or absorbed glass mat (AGM) batteries, carefully follow manufacturer's recharging instructions.
- e) Study all battery manufacturer's specific precautions such as removing or not removing cell caps while charging and recommended rates of charge.
- f) Determine voltage of battery by referring to vehicle or other user's manual and BEFORE MAKING THE BATTERY CONNECTIONS, MAKE SURE THAT THE VOLTAGE OF THE BATTERY YOU ARE GOING TO CHARGE MATCHES THE OUTPUT VOLTAGE OF THE CHARGER. NOTE: This charger has an automatic safety feature that will not allow charging if battery voltage exceeds 15V when 12V charging mode is selected or battery voltage is below 18V if 24V charging is selected.**

13. CHARGER LOCATION.

- a) Locate charger as far away from battery as DC cables permit.
- b) Never place charger directly above battery being charged; gases from battery will corrode and damage the charger.
- c) Never allow battery acid to drip on charger when reading gravity or filling battery. Do not operate charger in a closed-in area or restrict ventilation in any way.
- d) Do not set a battery on top of charger. **IMPORTANT** : Place charger on a hard flat surface or mount onto a vertical surface. Do not place on plastic, leather or textile surface.

14. DC CONNECTION PRECAUTIONS

- a) Connect and disconnect DC output clips only after setting any charger switches to off position and removing AC cord from electric outlet. Never allow clips to touch each other. However, should this happen, no damage will result to the charger circuit & the automatic charging programme will just reset to «start».
- b) Attach clips to battery and chassis as indicated in 15(e), 15(f), and 16(b) through 16(d).

NOTE : This battery charger has an automatic safety feature that will prevent it from operating if the battery has been inversely connected. Set charger switches to off position and/or remove AC cord from electrical outlet, disconnect the battery clips, then reconnect correctly according to the instructions below.

15. FOLLOW THESE STEPS WHEN BATTERY IS INSTALLED IN VEHICLE. A SPARK NEAR A BATTERY MAY CAUSE BATTERY EXPLOSION. TO REDUCE RISK OF A SPARK NEAR BATTERY :

- a) Position AC and DC cords so as to reduce risk of damage by hood, door or moving engine part.
- b) Stay clear of fan -blades, belts, pulleys, and other parts that can cause injury to persons.
- c) Check polarity of battery posts. POSITIVE (POS, P, +) battery post usually has larger diameter than NEGATIVE (NEG, N, -) post.
- d) Determine which post of battery is grounded (connected) to the chassis. If negative post is grounded to chassis (as in most vehicles), see (e). If positive post is grounded to the chassis, see (f).
- e) For negative-grounded vehicle, connect POSITIVE (RED) clip from battery charger to POSITIVE (POS, P, +) ungrounded post of battery. Connect NEGATIVE (BLACK) clip to vehicle chassis or engine block away from battery. Do not connect clip to carburetor, fuel lines, or sheet-metal body parts. Connect to a heavy gage metal part of the frame or engine block.
- f) For positive-grounded vehicle, connect NEGATIVE (BLACK) clip from battery charger to NEGATIVE (NEG, N, -) ungrounded post of battery. Connect POSITIVE (RED) clip to vehicle chassis or engine block away from battery. Do not connect clip to carburetor, fuel lines, or sheet-metal body parts. Connect to a heavy gage metal part of the frame or engine block.
- g) When disconnecting charger, turn switches to off, disconnect AC cord, remove clip from vehicle chassis, and then remove clip from battery terminal.
- h) See operating instructions for length of charge information.

16. FOLLOW THESE STEPS WHEN BATTERY IS OUTSIDE VEHICLE. A SPARK NEAR THE BATTERY MAY CAUSE BATTERY EXPLOSION. TO REDUCE RISK OF A SPARK NEAR BATTERY :

- a) Check polarity of battery posts. POSITIVE (POS, P, +) battery post usually has a larger diameter than NEGATIVE (NEG, N, -) post.
- b) This battery charger has an automatic safety feature that will prevent it from operating if the battery has been inversely connected. The charger does not allow charge current unless a voltage of at least 2V is sensed for a 12V battery and 4V for a 24V battery.**
- c) Connect POSITIVE (RED) charger clip to POSITIVE (POS, P, +) post of battery.
- d) Position yourself and free end of cables as far away from battery as possible. Then connect NEGATIVE (BLACK) charger clip to NEGATIVE (NEG, N, -) battery post of the battery.
- e) Do not face battery when making final connection.
- f) When disconnecting charger, always do so in reverse sequence of connecting procedure & break first connection while as far away from battery as practical.
- g) A marine (boat) battery must be removed & charged on shore. To charge it on board requires equipment specially designed for marine use.

Optimate 6

12V 6A / 24V 3A

DO NOT USE FOR NiCd, NiMH, Li-Ion OR NON-RECHARGEABLE BATTERIES.

IMPORTANT: READ THE FOLLOWING INSTRUCTIONS BEFORE USING THE CHARGER

EN

This appliance can be used by children aged from 8 years and above and persons with reduced physical, sensory or mental capabilities or lack of experience and knowledge if they have been given supervision or instruction concerning use of the appliance in a safe way and understand the hazards involved. Children shall not play with the appliance. Cleaning and user maintenance shall not be made by children without supervision.

SAFETY WARNING AND NOTES: Batteries emit **EXPLOSIVE GASES** - prevent flame or sparks near batteries. Disconnect AC power supply before making or breaking DC/battery connections. Battery acid is highly corrosive. Wear protective clothing and eyewear and avoid contact. In case of accidental contact, wash immediately with soap and water. Check that the battery posts are not loose; if so, have the battery professionally assessed. If the battery posts are corroded, clean with a copper wire brush; if greasy or dirty, clean with a rag dampened in detergent. **Use the charger only if the input and output leads and connectors are in good, undamaged condition. If the input cable is damaged, it is essential to have it replaced without delay by the manufacturer, his authorised service agent or a qualified workshop, to avoid danger.** Protect your charger from acid and acid fumes and from damp and humid conditions both during use and in storage. Damage resulting from corrosion, oxidation or internal electrical short-circuiting is not covered by warranty. Distance the charger from the battery during charging to avoid contamination by or exposure to acid or acidic vapours. If using it in the horizontal orientation, place the charger on a hard, flat surface, but NOT on plastic, textile or leather. Use the fixing holes provided in the enclosure base to attach the charger to any convenient, sound vertical surface.

EXPOSURE TO LIQUIDS: This charger is designed to withstand exposure to liquids accidentally spilled or splashed onto the casing from above, or to light rainfall. Prolonged exposure to falling rain is inadvisable and longer service life will be obtained by minimizing such exposure. Failure of the charger due to oxidation resulting from the eventual penetration of liquid into the electronic components, connectors or plugs, is not covered by warranty.

CONNECTING THE CHARGER TO THE BATTERY

- 1. Disconnect AC power supply before making or breaking DC / battery connections.**
- If charging a battery in the vehicle or craft with the battery clips, before making connections, first check that the battery clips can be safely and securely positioned clear from surrounding wiring, metal tubing or the chassis. Make connections in the following order:
First connect to the battery terminal not connected to the chassis (normally positive), then connect the other battery clip (normally negative) to the chassis well away from the battery and fuel line. Always disconnect in reverse sequence.
- When charging a battery out of the vehicle or craft with the battery clips, place it in a well ventilated area. Connect the charger to the battery: RED clamp to POSITIVE (POS, P or +) terminal and BLACK clamp to NEGATIVE (NEG, N or -) terminal. Make sure the connections are firm and secure. Good contact is important.
- If the battery is deeply discharged (and possibly sulphated), remove from the vehicle or craft and inspect the battery before connecting the charger for a recovery attempt.** Visually check the battery for mechanical defects such as a bulging or cracked casing, or signs of electrolyte leakage. If the battery has filler caps and the plates within the cells can be seen from the outside, examine the battery carefully to try to determine if any cells seem different to the others (for example, with white matter between the plates, plates touching). If mechanical defects are apparent do not attempt to charge the battery, have the battery professionally assessed.
- If the battery is new,** before connecting the charger read the battery manufacturer's safety and operational instructions carefully. If applicable, carefully and exactly follow acid filling instructions.

OPERATING INSTRUCTIONS

PROCEEDING TO CHARGE







CHARGING TIME

Charge time on a flat but otherwise undamaged battery: a 100Ah 12V / 50Ah 24V battery should take no more than about 24 hours to progress to the self-discharge check.

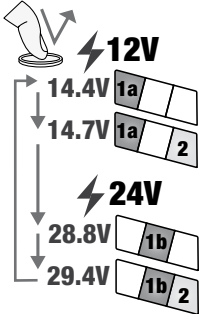
Deep-discharged batteries may take significantly longer, a full charge may not be achieved within the 72 hour charge safety limit.

°C : The charge voltage is inversely regulated according to ambient temperature i.e. voltage is increased at lower temperature, decreased at higher temperature. Adjustment: -0.004V / cell / °C above or below 20°C (68°F).

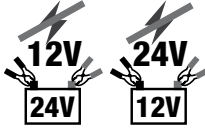
If voltage selection in STEP 1 matches the expected battery voltage and there are no connection errors as described in STEP 2, then fully automatic operation starts from STEP 3.

<p>STEP 1 Voltage Selection</p> <ol style="list-style-type: none"> 1. Disconnect battery. 2. Select charge voltage. 3. Wait until LEDs #3, #4, #5, #6, #7 & #8 flash twice, confirming selection is in memory. 4. Reconnect battery. <p>NOTE: Selection remains even if AC power is lost.</p>	<p>LED #1a => 12V LED #1b => 24V</p> <p>LED #1a / 1b : Confirms AC power supply to the charger</p> <p>LED #2 =>  - Lights together with LED #1a or #1b when a higher charge voltage is selected.</p> 	<p>Changing voltage selection: Push and release the pushbutton switch. The mode selection changes when the button is released. SAVE (#3), CHARGE (#4), OPTIMIZE(#5) and TEST (#6, 7, 8) LEDs flash twice to confirm selection is in memory, confirming your battery can now be connected.  : There are 2 different charge voltages for 12V / 24V lead-acid batteries.</p> <p>LED #2 OFF: 14.4V / 28.8V (2.4V / cell) - the standard charging voltage suitable and safest for all lead-acid battery types. <i>TIP: If you are not sure of your battery's charging requirements, choose this mode to avoid overcharging the battery.</i></p> <p>LED #2 ON: 14.7V / 29.4V (2.45V / cell) - higher charging voltage suitable only for specific sealed AGM (absorbed glass mat) flat plate or spiral cell batteries.</p> <p>IMPORTANT: Selecting 14.7V (for 12V batteries) or 29.4V (for 24V batteries) elevates charge voltage in STEP 5 & 6. Confirm battery charge voltage requirement before selecting a higher charge voltage. Incorrect selection can lead to overcharging and electrolyte loss through gassing and can cause permanent damage.</p> <p>Proceeding to charge: If the battery's voltage matches the voltage selection the charge mode automatically activates and proceeds to STEP 3. If it does not proceed, see STEP 2.</p>
<p>STEP 2 Protection</p>	<p>LED #1a / #1b flashing ON/OFF</p>   	<p>REVERSE POLARITY / incorrect battery connection (LED #1a and #1b flashing together) : The charger is electronically protected so no damage will result, and the output will remain disabled until the connections are corrected.</p> <p>VOLTAGE SAFETY CHECK:</p> <p>12V (#1a) flashing: a battery with voltage exceeding 16V is connected / battery may be 24V.</p> <p>24V (#1b) flashing: a battery with voltage below 18V is connected; battery may be 12V or it may be a deep discharged 24V battery.</p> <p>Action: Physically check battery. If nominal voltage is 12V, disconnect battery and select 12V.</p> <p>If nominal voltage is 24V, push and hold pushbutton switch. After 3 seconds program will proceed to STEP 3.</p>
<p>STEP 3 Preparing to charge</p>	<p>Immediately following connection to a battery there may be a 1-2 second delay before charging progresses, during which time battery State Of Charge and ambient temperature is measured to determine charge requirement and duration of the State Of Health test in STEP 7.</p>	
<p>STEP 4 SAVE State of charge: less than 50%</p>	<p>LED #3 : RED</p>  	<p>The SAVE mode engages if the battery state of charge was less than 50% or the battery was diagnosed as sulphated. Charge time: Minimum 15 minutes, maximum 2 hours.</p> <p>A recondition charge is applied; current is delivered in pulses to prepare the battery to accept normal charge and increase state of charge above 50%.</p>

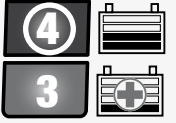
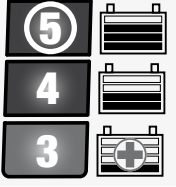
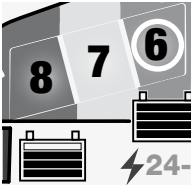
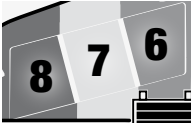
<p>STEP 5 CHARGE</p> <p>State of Charge: 50% - 75%</p>	<p>LED #4 : BLUE</p> 	<p>The CHARGE mode engages if the battery state of charge was 50% or higher or once the battery has been sufficiently recovered during STEP 4.</p> <p>The ampmatic™ charge current monitoring and control program automatically determines the most efficient rate of charge current for the connected battery, according to its state of charge, state of health, and electrical storage capacity.</p> <p>Maximum charge current: 12V battery => 6A 24V battery => 3A.</p>
<p>STEP 6 OPTIMIZE (pulsed absorption / final charge)</p> <p>State of charge: 75% - 100%</p>	<p>LED #5 : BLUE</p> 	<p>Engages when the voltage has reached 14.4V / 28.8V (AGM: 14.7V/29.4V) for the first time during STEP 5.</p> <p>The ampmatic™ current control program now delivers pulses of current to equalise the individual cells within the battery and optimizes charge level.</p> <p>Charge time during this step varies between 10 and 120 minutes, influenced by initial battery State Of Charge and health as measured in STEP 3, and current draw by connected circuitry.</p> <p>For safety reasons there is an overall charge time limit of 72 hours for STEP 4, 5 and 6.</p>
<p>STEP 7 TEST after charge</p>	<p>LED #6 : GREEN</p> 	<p>Delivery of current to the battery is interrupted for 30 minutes** to allow the program to determine the battery's ability to retain charge.</p> <p>** IF charging started in SAVE mode (LED #3) the voltage retention test is extended to 12 hours to confirm battery health.</p> <p>LED #6 (green) will remain on for batteries able to hold 90% or higher state of charge (SOC%), otherwise the TEST result is adjusted lower (LED #7, LED #8) in real time according to the measured battery voltage. Consult the table on page 2 to match TEST LED indication to an estimated state of charge percentage (SOC%).</p> <p>Also read section "NOTES ON TEST RESULTS" below.</p>
<p>STEP 8 OptiMATE smart MAINTAIN</p>	<p>LED #6 / 7 / 8 ON</p>  <p>For batteries with a good state of health LED #6 (green) will remain on.</p> <p><i>Exception:</i> STD wet cell batteries with filler caps have a lower fully charged voltage: LED #6 remains on together with LED #7.</p>	<p>MAINTENANCE CHARGE: LED #6 / 7 / 8 steady on according to final voltage measured at termination of STEP 7.</p> <p>Float voltage setting: For 12V batteries: 13.6V nominal at 20°C (68°F), For 24V batteries: 27.2V nominal at 20°C (68°F). The float voltage is inversely regulated according to ambient temperature; i.e., voltage is increased at lower temperature, decreased at higher temperature.</p> <p>Adjustment: -0.004V / cell / °C above or below 20°C (68°F).</p> <p>Continuous float maintenance charge will be applied to the battery if the charger sensed that connected circuitry has a current draw exceeding 200mA, otherwise the charger proceeds with the standard maintenance mode. Standard maintenance mode consists of 30 minute float charge periods followed by and alternating with 30 minute 'rest' periods, during which there is no charge delivered. This "50% duty cycle" prevents loss of electrolyte in sealed batteries and minimizes gradual loss of water from the electrolyte in batteries with filler caps, and thereby contributes significantly to optimizing the service life of irregularly or seasonally used batteries.</p> <p>During "float charge" a continuous LOW CURRENT PULSE IS DELIVERED TO PREVENT SULFATION, further extending battery power and life.</p> <p>If the OptiMate senses the battery has lost charge the program will revert back to STEP 5.</p>

MAINTAINING A BATTERY FOR EXTENDED PERIODS: For accurate temperature regulated charging and long term maintenance place OptiMate as close as possible to the battery under charge. For example, if the battery is within a vehicle or craft stored outside in direct sun or cold, place the OptiMate inside the vehicle or craft (or its battery compartment) so that charge voltage is adjusted according to the same environment temperature that the battery would experience.

The OptiMate will maintain a battery whos basic condition is good, for months at a time. At least once every two weeks, check that the connections between the charger and battery are secure, and, in the case of batteries with filler caps on each cell, disconnect the battery from the charger, check the level of the electrolyte and if necessary, top up the cells (with distilled water, NOT acid), then reconnect. When handling batteries or in their vicinity, always take care to observe the SAFETY WARNINGS above.

VERY FLAT NEGLECTED BATTERIES: If the battery is deeply discharged (and possibly sulfated), remove from the vehicle or equipment and inspect the battery before connecting the charger for a recovery attempt. The charger's recovery mode may not engage if it senses that the battery is still connected to a circuit which effectively offers a lower electrical resistance than the battery on its own. However, if the deep-discharged battery is not removed for recovery, neither battery nor vehicle or equipment electronics will be damaged. **Pay particularly close attention to the following** A battery left deep-discharged for an extended period may develop permanent damage in one or more cells. Such batteries may heat up excessively during high current charging.

Monitor the battery temperature during the first hour, then hourly there-after. Check for unusual signs, such as bubbling or leaking electrolyte, heightened activity in one cell compared to others, or hissing sounds. If at any time the battery is uncomfortably hot to touch or you notice any unusual signs, DISCONNECT THE CHARGER IMMEDIATELY.

NOTES ON TEST RESULTS:

- 1.** For any test result other than green #6 (or green #6 and yellow #7 together if the battery is a STD type with filler caps), disconnect the battery from the electrical system it supports, and reconnect the OptiMate. If a better test result is now obtained, this suggests that the power losses are partly due to an electrical problem in the electrical system and not in the battery itself.
- 2.** If the red LED #8 alone, or the yellow #7 and red LED #8 indicate together, or yellow #7 LED alone for a sealed battery, a significant problem exists. The battery is unable to retain sufficient charge or is losing charge very fast due to connected circuitry. A sudden load being switched on while the charger is connected can also cause the battery voltage to dip significantly.
- 3.** GOOD TEST RESULT, but the battery cannot deliver sufficient power: Degraded inter-cell connections or poor external connection at battery posts may cause severe voltage drop when high current is demanded from the battery. Check external battery connections or have battery professionally assessed (load tested).

ECO POWER SAVING MODE WHEN THE CHARGER IS CONNECTED TO AC SUPPLY:

The power converter switches to ECO mode when the charger is not connected to a battery resulting in a very low power draw of less than 0.5W, equivalent to power consumption of 0.012 kWh per day. When a battery is connected to the charger power consumption depends on the current demand of the battery and its connected vehicle / electronic circuitry. After the battery has been charged and the charger is in long term maintenance charge mode (to keep the battery at 100% charge) the total power consumption is estimated to be 0.024kWh or less per day.

MOUNTING NOTICE

4x
Ø 3.5mm

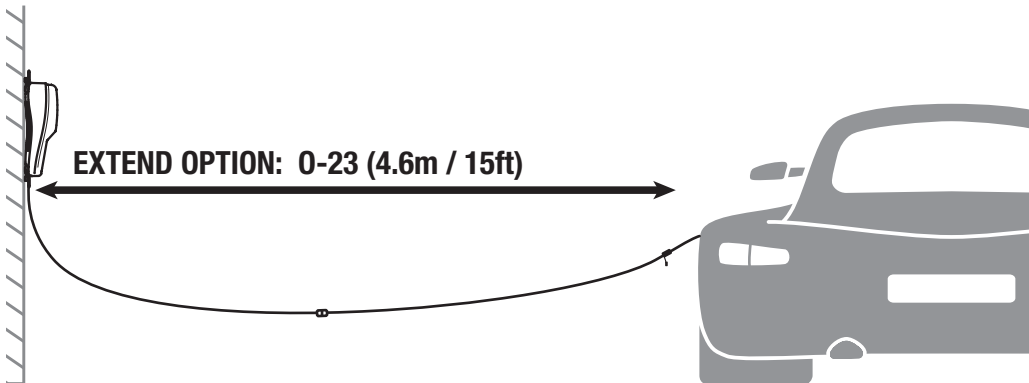
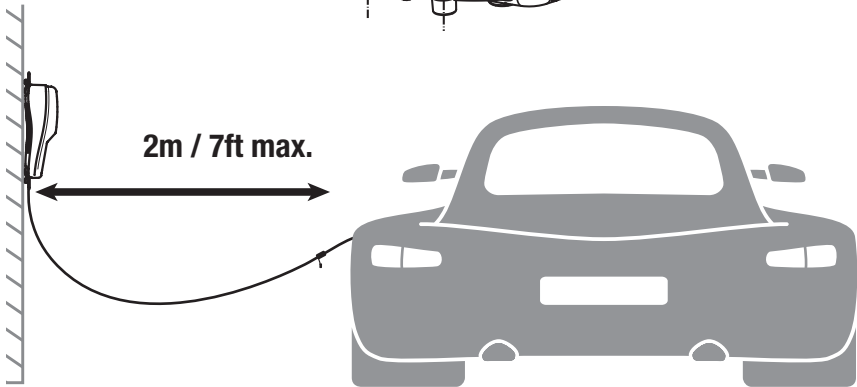
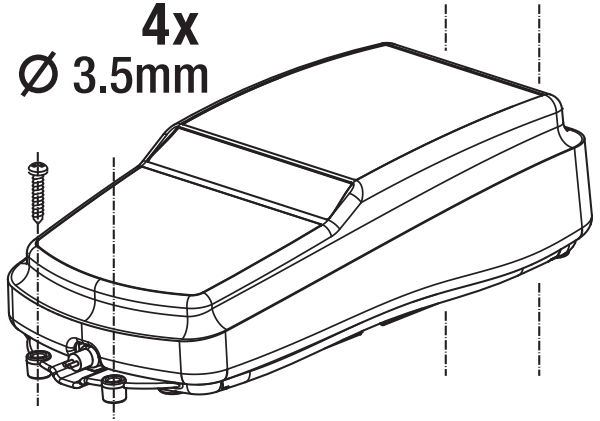

Learn more about battery chargers and jump starters we have.