

*Nippon America Group*



*2020*  
**CATALOG**



*2020 Catalog*



01	BLISTER	001
02	HDMI	019
03	VIDEO & AUDIO	033
04	TELEPHONE ACCESSORIES	085
05	GOLD SERIES	088
06	ISTUFF	096
07	COMPUTER ACCESSORIES	108
08	XXX	121
09	AUDIODRIFT	128
10	PIPEDREAM	137
11	INSTALLATION	154
12	AUDIO	285
13	AUDIOPIPE PRO DJ	335
14	PRO AUDIO CABLES	367
15	ZEBRA	382
16	STUDIO Z	385
17	MUSICAL EQUIPMENT	413
18	MICROPHONES	450
19	DISCO LIGHT	459
20	POWER PRODUCTS	474
21	HOME SECURITY	523

**BLISTER**





**BL-AC-006**

- POWER CORD
- Frequency Response: 20 - 20kHz
  - Impedance: 32 Ohms
  - Sensitivity: 105dB
  - 6'



**BL-HD-315-6**

- COMPONENT CABLE
- VGA to RGB Component Cable
  - Flat Pin Universal Cheater Cords for Tape Players
  - 6'

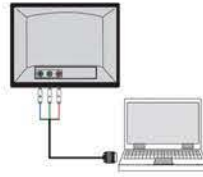

**BL-N-3535-6GB**

- 3.5mm STEREO AUDIO CABLE
- 6'
  - Black
  - Gold Connectors



**BL-N-3535-6GW**

- 3.5MM STEREO AUDIO CABLE
- 6'
  - White
  - Gold Connectors



**BL-V-175G**

- RCA STEREO AUDIO/VIDEO CABLE
- Oxygen-Free
  - Fully Molded
  - Shielded Color Coded Wires
  - Gold-Plated RCA Connectors
  - 6'
  - Heavy Duty



**BL-V-275G**

- RCA STEREO AUDIO/VIDEO CABLE
- Oxygen-Free
  - Fully Molded
  - Shielded Color Coded Wires
  - Gold-Plated RCA Connectors
  - Heavy-Duty
  - 6'



**BL-IP-35-USB6**

- 3.5mm STEREO PLUG TO USB CABLE
- 6'
  - White
  - Gold Connector



**BL-IP-35-USB6FM**

- 3.5 MM STEREO PLUG TO USB FEMALE
- 6'
  - White
- Connects to Stereo/USB Equipment such as Car Radios to Stereo Receivers, Cassette Decks, CD Players, Etc.



**BL-N-203-6G**

- STEREO AUDIO CABLE
- 2 RCA to 2 RCA
  - Gold-Plated Connectors
  - Shielded Color Coded Wires
  - 6'



**BL-N-211P-6G**

- STEREO AUDIO CABLE
- 3.5mm to 2 RCA
  - Gold-Plated Connectors
  - Shielded Color Coded Wires
  - 6'

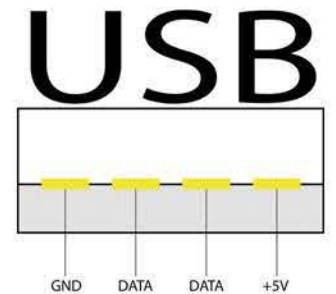



**BL-USB-30B30A**

USB 3.0 AM TO MICRO BM CABLE

- Super Speed USB (USB 3.0) has a 5 Gbps Signalling Rate Offering 10x Performance Increase Over Hi-Speed USB
- Super Speed USB (USB 3.0) is a Sync-N-Go Technology that Minimizes User Wait-Time
- Super Speed USB (USB 3.0) will Provide Optimized Power Efficiency. No Device Polling and Lower Activate and Idle Power Requirements
- Super Speed USB (USB 3.0) is Backwards Compatible with USB 2.0 Devices Interoperate with USB 2.0 Platforms



**BL-USB-MICROU-3 / BL-USB-MICROU-6**

USB AM (Male) TO MICRO-USB (Male) CABLE

- PVC Cable Jacket Material
- OD: Ø3.8mm
- Available in 3', 6'

Connect a Portable Device such as Cell Phone, PDA or Digital Camera with a USB Micro B Connection to your Computer or other USB Device.



**BL-USB-8MUSB-6**

USB 2.0 A MALE TO MINI USB 8-PIN MALE CABLE

- Nickel-Plated Connectors
- Connectors: USB Type A Male to Type B Mini 8-Pin Male
- Make Plug and Play Connections with Cellular Phones, MP3 Players, Digital Cameras and PDAs
- Transfer Rates up to 480Mbps Depending on USB Version
- Foil and Braid Shielding Reduces EMI / RFI Interference thus Ensuring High-Speed, Error-Free Data Transmission



**BL-USBF-MIOTG**

OTG CABLE (USB 2.0 FEMALE TO MICRO USB 5 PIN MALE CABLE)

- Length: 11cm
- High Quality OTG Cable Adapter
- Suitable for Table PCs and Mobile Phones with Micro USB Port
- Easy to Use, Plug and Play
- Ability to Connect USB Mouse or Keyboard with your Table PC or Mobile Phone for Easy Operation
- Allows your Device to Connect with U-disk and Card Reader for Data Transmission



**BL-USBF-MIMAD**

USB 2.0 A FEMALE TO MINI USB 5 PIN MALE ADAPTOR

- Compatible with USB 1.1 & USB 2.0
- Supports High Speed Data Rates up to 480Mbps

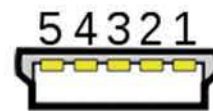

Mini-B



**BL-NF-56G**

F CONNECTOR FOR COAXIAL CABLE

- For Coaxial Cable with 6.5mm



**BL-F-81G**

FEMALE SPLICE CONNECTOR W/NUT

- For Coaxial Cable
- Gold



**BL-NF-1G**

F QUICK MALE TO F FEMALE CONNECTOR

- For Coaxial Cable
- Gold



**BL-F-29AG**

INDOOR TV ANTENNA

- Panasonic® Type Dual Antenna
- 5 Section Row with Gold Push on F Connector
- Built-In 3' Coaxial Cable



**BL-F-33AG**

INDOOR TV ANTENNA

- 31" Extended, Dual Chrome 4 Section Rod Antenna
- "F" Type Connector
- Chromed Double Loop Rings for Better Reception
- UHF/VHF Antenna with Coaxial Cable and Gold "F" Type Quick Connect Plug



**BL-N-380**

"F" TYPE CONNECTOR

- 300 Ω to 75 Ω Balun Transformer



**BL-N-919G**

MATCHING TRANSFORMER

- Weather Resistant, Rubber Boot & Spade Terminal Included
- VHF/UHF Outdoor
- Gold Tips





**BL-IBM-205-6**

USB CABLE AM (MALE) TO USB CABLE AF (FEMALE)

- Interfaces High-Speed USB 2.0 Compliant Devices
- 6'



**BL-IBM-205-12**

USB CABLE AM (MALE) TO USB CABLE AF (FEMALE)

- Interfaces High-Speed USB 2.0 Compliant Devices
- 12'



**BL-IBM-425-3**

PATCH CORD

- Booted
- Stranded
- UL
- 50u Gold
- RJ45 Plugs
- 3'



**BL-IBM-425-6**

PATCH CORD

- Booted
- Stranded
- UL
- 50u Gold
- RJ45 Rings
- 6'



**BL-IBM-A-B-6**

USB CABLE AM (MALE) TO BM (MALE)

- PVC Cable Jacket Material
- OD: Ø4.5mm
- 6'



**BL-IBM-ABMIN-10**

USB CABLE AM (MALE) TO MINI 5 PIN (MALE)

- Interfaces High-Speed USB 2.0 Compliant Devices
- Making Easy Plug & Play Connections
- 10'



**BL-IBF-BMINI-6**

USB 2.0 A FEMALE TO MINI USB MALE CABLE

- Nickel-Plated Connectors
- 6' Length
- USB 2.0 Version Cable for Charging and Data Transmission



**BL-IBM-MOS300**

Optical Wheel Mouse

- Windows and Mac
- Ergonomic Design
- Operating Distance: 15 Meters



**BL-IBM-WLRMOUSE**

2.4G OPTICAL WIRELESS MOUSE

- Windows and Mac
- Ergonomic Design
- Operating Distance: 10 Meters



**BL-IBM-AFAF200**

A TYPE FEMALE COUPLER

- Platinum-Plated Connectors



**BL-IBM-104USB**

USB 4-PORT HUB

- Includes Hub and USB Cable
- Suitable for Notebooks



**BL-IBM-USB35-HM**

INTEGRATED 2CH USB AUDIO CONTROLLER

- Supports 3D Sounds (AC-3) and Virtual 5.1 Surround Sound Track
- The Best Entertainment for Listening to DVD, CD's and General Online Content
- Plug and Play, No Software Required
- Eliminate the Need for a Traditional Sound Card with this USB to Audio Adapter. Real USB Plug & Play Upgrade any On-Board Sound Card to 5.1 Digital
- Surround Sound without any Hardware Installation
- Connect a Speaker or Headphone Directly



**BL-IBM-KB370**

SLIM DESIGN USB KEYBOARD

- Comfortable to Use
- High-Quality Membrane Key Switch
- Key Stroke Life Time: 10,000,000 Cycles
- USB Interface
- Compatible with Windows Vista 7 and Windows 8
- Slim Design



**KEYBOARD**



**SLIM**

**BL-IBM-KM700**

WIRELESS KEYBOARD + MOUSE COMBO

MOUSE FEATURES:

- High Precision Optical Sensor 1200PI
- Precision Scroll Wheel
- Nano Receiver Receptacle
- Auto Standby Mode
- On/Off Switch
- Requires (2) AAA Batteries, Not Included

KEYBOARD FEATURES:

- Unique Slim Design, Stylish Configuration, Comfortable Feeling
- Compatible with all Operating Systems
- Requires (1) AA Battery, Not Included

ADVANCED WIRELESS:

- Advanced 2.4 GHz RF Wireless Technology, Provides up to a 10 Meter Multi-Directional Range and Practicality Interface Free Use

**wireless**

**12M, 360°**  
Transmission



**KEYBOARD and Mouse**

**BL-IBM-WKB-400**

WIRED WASHABLE KEYBOARD

- Key: 103K, Port: USB
- Conductive Silver Paste
- Laser Etching Font
- Switch Life More than 5,000,000 Times
- Can be Washed Easily, Submersible up to Depths of 1/30cm
- Drain Hole of Backside can Make Keyboard Dry Faster



**WASHABLE**



**KEYBOARD**



**BL-P-101TG**

AUDIO CONNECTOR

- 1/4" Mono Plug, Gold Metal Body and Tail



**BL-P-106MG**

AUDIO CONNECTOR

- 3.5mm Gold Mono Plugs, Metal Body



**BL-P-106SG**

AUDIO CONNECTOR

- 3.5mm Gold Stereo Plugs, Metal Body

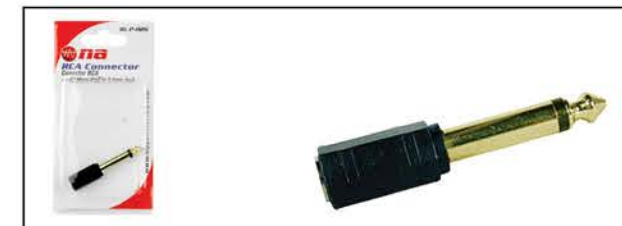

**BL-P-112G**

RCA CONNECTOR

- 1/4" Gold Mono Plug to 3.5mm Jack



**BL-P-119G**

RCA SPLICE CONNECTOR

- Molded Adapter, Jack to Jack
- Gold

**BL-P-120G**

RCA SPLICE CONNECTOR

- Molded Adapter Plug to Plug
- Gold





**BL-DSL-F200**

DSL SPLITTER

- Filters Out DSL Signals to Allow Simultaneous Use of Telephone and DSL Service
- Includes a Pass-Through Jack for Modem, Eliminating the Need for a Double Adaptor
- Superior Design Ensures Compatibility with Cordless Phones



**BL-KR-128**

CORD UNTANGLER

- Prevents Tangles Cords
- Does Not Affect Sound Quality
- Automatically Rotates to Eliminate Twisted Telephone Cords



**BL-KR-200**

TELEPHONE ADAPTER

- Modular In-Line Coupler



**BL-KR-202**

TELEPHONE ADAPTER

- Modular Double Adapter



**BL-KR-203**

TELEPHONE ADAPTER

- Modular Triplex Adapter



**BL-KR-209-15IV0**

**BL-KR-209-25IV0**

TELEPHONE CORD

- Modular Handset Coiled Cord
- 15" - 25"
- Ivory



**BL-KR-425-15**

**BL-KR-425-25**

**BL-KR-425-50**

TELEPHONE CORD

- Modular Straight Line Cord
- 4 Pin Plug to 4 Pin Plug
- 15", 25", 50"
- Ivory



**BL-KR-468**

TELEPHONE JACK

- 4 Pin Modular Surface Jack with Screws & Stick-On Pad



**BL-KR-468D**

TELEPHONE DUAL JACK

- 4 Pin Modular Surface Jack with Screws & Stick-On Pad



**HMBL-2002-6**

**HMBL-2002-12**

1.4 HDMI CABLE

- 24K Gold-Plated Connector
- 1080p Triple Shielded Oxygen-Free with Filter
- Blister Packing



**HMBL-2005-6**

**HMBL-2005-12**

1.4 HDMI CABLE

- 24K Gold-Plated Connector
- 1080p Triple Shielded Oxygen-Free Filter
- Blister Packing



**HMBL-2009**

HDMI 19 PIN MALE TO HDMI 19 PIN FEMALE RIGHT ANGLE ADAPTER

- 24K Gold-Plated
- RoHS Compliant
- Blister Packing



**HMBL-2012**

HDMI FEMALE ADAPTER

- In-Line Coupler
- Allows you to Link Two HDMI Cables
- Blister Packing





**HM-2002-6RA**

HDMI CABLE A MALE TO A MALE (Right Angle)

- 1.4 Version (High Speed with Ethernet)
- Gold-Plated
- 1.4 HDMI Cable
- It can Work for all Previous HDMI 1.3 Devices, also Supports HDMI Ethernet Channel, Audio Return Channel, 3D, 4K Content Types, Deep Color and x.v.Color
- 6'



**HM-2002-12RA**

HDMI CABLE A MALE TO A MALE (Right Angle)

- 1.4 Version (High Speed with Ethernet)
- Gold-Plated
- 1.4 HDMI Cable
- It can Work for all Previous HDMI 1.3 Devices, also Supports HDMI Ethernet Channel, Audio Return Channel, 3D, 4K Content Types, Deep Color and x.v.Color
- 12'



**HM-2002-6SWL**

180° SWIVEL TYPE, HDMI CABLE  
A MALE TO A MALE

- 1.4 Version (High Speed with Ethernet)
- Gold-Plated
- 1.4 HDMI Cable
- It can Work for All Previous HDMI 1.3 Devices, also Supports HDMI Ethernet Channel, Audio Return Channel, 3D, 4K Content Types, Deep Color and x.v.Color
- 6"



**HM-2002-12SWL**

180° SWIVEL TYPE, HDMI CABLE  
A MALE TO A MALE

- 1.4 Version (High Speed with Ethernet)
- Gold-Plated
- 1.4 HDMI Cable
- It can Work for All Previous HDMI 1.3 Devices, also Supports HDMI Ethernet Channel, Audio Return Channel, 3D, 4K Content Types, Deep Color and x.v.Color
- 12"



**HMC-HM-005-6 / HMC-HM-005-12**

HDMI MALE TO MICRO-HDMI MALE

- Available in 6', 12'
- Connect a Portable Device such as a Cell Phone, PDA, or Digital Camera with a USB Micro B Connection to your Computer or other USB Device



**BL-VGA-M-M-6G**

VGA MALE TO VGA MALE CABLE

- Ideal for High-Resolution Monitors (1024 x 768 and Above)
- Triple-Coaxial + Twisted-Pair Wire for Crystal Clear Images
- Impedance Matched @ 75 Ohms for Full Brightness and Vibrant Picture Color
- 6'



**BL-VGA-M-M-12G**

VGA MALE TO VGA MALE CABLE

- Ideal for High-Resolution Monitors (1024 x 768 and Above)
- Triple-Coaxial + Twisted-Pair Wire for Crystal Clear Images
- Impedance Matched @ 75 Ohms for Full Brightness and Vibrant Picture Color
- 12'





**BL-P-510**  
ADAPTER  
• Flat Pin Plug to Round Socket



**BL-P-514**  
GROUND ADAPTER  
• 3 Prong Plug to Two Prong Outlet, Permits "U" Ground



**BL-P-517G**  
MULTI-ADAPTER  
• Adapts to the Plug of your Electronic Product for Use in North America and most South America Outlets  
• Does Not Convert Power



**14-512**  
3 OUTLET GROUNDED WALL SOCKET  
• For Indoor Use Only  
• Use in Dry Conditions  
• 110V



**14-516**  
6 OUTLET WALL TAP SURGE PROTECTOR  
• For Indoor Use Only  
• Use in Dry Conditions  
• 400V



**13-414**  
6 OUTLET AC POWER STRIP  
• High Impact, Fire-Retardant Plastic Housing  
• Outlets: 6 "U" Ground  
• Power Supply: 14AWG x 3C SJT  
• Length: 3'  
• Switch: Lighted Approach Switch  
• Max Rating: 15A/120V AC/60Hz/1800 Watts  
• **90 JOULES** Surge Suppressor to Protect Sensitive Electronic Equipment  
• For Indoor Use and Dry Locations



**13-6400**  
6 OUTLET AC POWER STRIP  
• High Impact, Fire-Retardant Plastic Housing  
• Outlets: 6 "U" Ground  
• Power Supply: 14AWG x 3C SJT  
• Length: 2'  
• Switch: Lighted Approach Switch  
• Max. Rating: 15A/120V AC/60Hz/1800 Watts  
• **400 JOULES** Surge Suppressor to Protect Sensitive Electronic Equipment  
• For Indoor Use and Dry Locations



**14-519**  
3 OUTLET SWIVELING GROUNDED WALL SOCKET  
• For Indoor Use Only  
• Use in Dry Conditions  
• 110V



**16-516S**  
6 OUTLET WALL SOCKET  
• High Impact, Fire-Retardant Plastic Housing  
• Outlets: 6 "U" Ground  
• Max Rating: 15A / 125V AC/60Hz/1875W  
• 1000 Joules Surge Suppressor to Protect Sensitive Electronic Equipment  
• For Indoor Use Only and Dry Locations  
• Can Swivel to Redirect Power and Safely Slide all your Furniture Back  
• Creates Extra Space Where you Need it Most





**20-115-21U**

- 1 AC OUTLET & DUAL USB PORTS  
WALL OUTLET CHARGING CENTER  
FOR USB ELECTRONICS
- AC 125V, 15A, 1875W, 60Hz
  - Converts 1 AC Outlet to 1 AC Outlet and Dual USB Port
  - ABS Resistance Burning (94V-0) Housing
  - 2 Ports USB Total 2.1A
  - ETL Approved



**20-3245-21U**

WALL OUTLET CHARGING CENTER FOR  
USB ELECTRONICS

- AC Rating: 15A/125V/1875W
- Max. Spike Voltage: 550V
- Clamping Voltage: 550V
- 245J Surge Suppressor to Protect Sensitive Electronic Equipment
- USB 1.1A + 1.0A



**BL-IBM-104USBC**

4 PORTS USB 2.0 HI-SPEED HUB

- 1 Upstream and 4 Downstream USB Port Included, Fully Compliant with USB Specification Version 2.0
- Hot Plug & Play USB Device
- Half-Transparent Design with Blue LED Power Indicator
- Interface: USB 2.0, Compatible with USB 1.1
- Data Transfer Rate: 1.5Mbps / 12Mbps / up to 480Mbps
- Bus-Power Limit Current Protection: 500mA



**20-6450-31U**

POWER STRIP CHARGING CENTER FOR USB ELECTRONICS

- AC Rating: 15A/125V/1875W
- Max. Spike Voltage: 550V
- Clamping Voltage: 550V
- 450J Surge Suppressor to Protect Sensitive Electronic Equipment
- Length: 3'
- USB 2.1A + 1.0A
- For Indoor Use and Dry Locations
- Use for Portable Electronics, Video Game Console



**22-6450-31U**

WALL OUTLET CHARGING CENTER FOR USB ELECTRONICS

- AC Rating: 15A/125V/1875W
- Max. Spike Voltage: 550V
- Clamping Voltage: 550V
- 450J Surge Suppressor to Protect Sensitive Electronic Equipment
- USB 2.1A + 1.0A



**17-81803U**

8 OUTLETS AC POWER STRIP WITH TRIPLE USB PORTS  
APPLICATION

- Suitable for General Electronics, Computers, and Hi Fi Receivers

OVERVIEW

- Housing Material: PC/ABS
- Color: White

INPUT

- Max Current: 15A
- Max Voltage: 125V
- Max Power: 1825W
- Nominal Voltage: 110V
- Nominal Frequency: 60Hz
- Resettable Circuit Breaker: 15A
- With ON/OFF Switch

ENVIRONMENTAL

- Operating Temperature: <45°
- Operating Relative Humidity: <99%
- Storage Temperature: <45°

SURGE PROTECTION

- Energy Absorption: 1800 Joules
- Clamping Voltage: 400V
- Maximum Spike Current: 36000A

USB CHARGER

- Allows you to Charge iPhone/iPod and Other Mini Appliance/ iPhone/ iPod
- Output: DC 5V/3.1A





**HD-0102-4**

1 X 2 MINI SPLITTER

- Power: 5V DC@1A, 50/60Hz, 5W
- Output Video: HDMI Signal
- Video Amplifier Bandwidth: 3.4Gbps/340MHz
- Interlaced Resolutions (50/60Hz): 480i, 576i, 1080i
- Progressive Resolutions (50/60Hz): 480p, 576p, 720p, 1080p, 4K@30Hz
- Size: 3" x 2" x 0.6" (75 x 48 x 15mm)



**HD-0104-4**

1 X 4 SPLITTER

- Supports Full 3D and 4K@30Hz Resolution
- Supports 340MHz/3.4Gbps Per Channel (10.2Gbps All Channels)
- Supports 12bit Per Channel (36bit All Channels) Deep Color
- Supports HDCP 1.4
- Supports Uncompressed Audio such as LPCM7.1
- Support Compressed Audio such as DTS, Dolby Digital (Including DTS-HD Master Audio™ and Dolby TrueHD).



**HDMI SERIES**

**HD-0204-4**

2 x 4 Switcher/Splitter

- Support HDMI1.4b
- Support 3D
- Support Highest Video Resolution 3840 x 2160/30Hz
- Support 3Gbps Data Rate for TMDS Clock up to 300MHz
- Support 8/10/12bit Deep Color
- Support AWG26 HDMI Standard Cable: when the Resolution is 1080p and Below, Input up to 15 Meters, Output to 15 Meters; when the Resolution is 4K, Input up to 8 meters, Output up to 8 Meters
- Support Single High Definition Display for Multiple Sources, such as DVD Players and Stellite Receivers, Digital Projectors, A/V Receivers, Set Top Boxes



**HD-0208-4**

2 X 8 SWITCHER/SPLITTER

- Support HDMI 1.4b /Capacidad para HDMI 1.4b
- Support 3D /Capacidad para 3D
- Support Highest Video Resolution 3840 x 2160/30HZ
- Support 3Gbps Data Rate for TMDS Clock up to 300MHz
- Support 8/10/12 bit Deep Color
- Support Standard AWG26 Cable: When the Resolution is 1080p and Below, Input up to 10 Meters, Output up to 15 Meters; When the Resolution is 4K, Input up to 5 Meters, Output up to 10 Meters
- Support Single High Definition Display and Multiple Output HD Signal Sources, such as DVD Players, A/V Receivers and Set-Top Box





### HDM-0301

#### HDMI MINI SWITCHER

- Supports 12-Bit Deep Color, Full 1080p
- Multifunctional on Switching: Intelligent or Mechanical
- Support with HDMI 1.3b
- High Performance up to 2.5Gbps
- Maintains High Resolution Video - Beautiful, Sharp HDTV Resolutions up to 1080p, 2k, 1440p S\Graphics and Computer Resolution up to 1920 x 1200 are Easily Achieved



### HD-0301R-4

#### 3 X 1 SPLITTER

- Multi-Functional on Switching: Manual Switching, Remote Switching or Automatic Switching
- HDCP Pass-Through
- High Definition Resolution 4K@30Hz, 1080p and 3D
- 300MHz/3.0Gbps Per Channel Bandwidth
- 12bit Per Channel (36bit All Channels) Deep Color
- Consumer Electronics Control
- Uncompressed Audio such as LPCM
- Compressed Audio such as DTS, Dolby Digital® (Including DTS-HD Master Audio™ and Dolby TrueHD®)



### HD-4K0401R-4

#### SWITCHER 4 IN 1 OUT

- HDMI Version: HDMI 1.4b
- Support: 4Kx2K (3840x2160), HDCP1.4, 3D, CEC, Blue-Ray 24/50/60fs/
- HD-DVD/xvYCC, Signal Retiming
- HDMI Resolution; 24/25/30Hz/2160P, 24/50/60Hz 1080p/1080i/720p
- Supports Video Color Format: 24bit/Deep Color 30bit, 36bit, 48bit
- Supports Audio Format: DTS-HD/Dolby-TrueHD/LPCM7.1/DTS/ Dolby-AC3/SDS HD(HBR)
- Power Adapter Format: Input: AC (50Hz, 60Hz), 100V-240V;
- Max Bandwidth: 340MHz
- Max Band Rate: 10.2Gbps
- Input/Output TMDS Signal: 0.5~1.5 Volts p-p (TTL)
- Input/Output DDC Signal: 5 Volts p-p (TTL)
- Max Working Current: 1000mA
- Output: DC 5V/1A
- Operating Temperature Range: (-15°C ~ 55°C)



### HDC-VRCA01

#### HDMI CONVERTER

- Composite Aideo or S-Video + R/L Audio to HDMI
- Input DDC Signal: 5 Volts p-p (TTL)
- External Power Supply: 5V DC @ 2A
- Output Video: HDMI 1.3b
- Vertical Frequency Range: 50/60Hz
- Max. Power Consumption: 5W
- Multi-Voltage: 100-240V, 50-60Hz, 0.5A



### HD-0401R-4

#### 4 X 1 SWITCHER WITH PIP

- Support HDMI 1.4
- Support 3.0Gbps Per Channel Bandwidth
- Video Resolutions up to 4K x 2K@30Hz, 1080p@120Hz and 1080p 3D @60Hz
- CEC Pass-Through
- PIP (Picture in Picture) Mode Support Highest Video Resolution 1080p 3D@60Hz
- Multifunctional on Switching: Intelligent or Mechanical



### MTV-310

#### 1 IN 4 OUT 4K HDMI SIGNAL SPLITTER

- Input/Output: 1/4
- Frequency Range: 47-870MHz
- Gain: 28dB (Max)
- Noise Figure: < 2dB
- Power Supply: INPUT: 100-240V 50/90Hz 0.15A OUTPUT: 5.0V = 1000mA



### VGA-SPLT-1X4

#### 1 X 4 VGA SPLITTER WITH AUDIO

- Input Video Signal: 1.2Volt p-p
- Maximum Single Link Range: 1920x1200, 1080p
- Vertical Frequency Range: 30-170Hz
- Video Amplifier Bandwidth: 500MHz
- Input: VGA 15pin Male
- Output: VGA 15pin Female
- Size: 165x92x45mm
- Net Weight: 450g
- External Power Supply: 5V DC @ 2A
- Max. Power Consumption: 5W



### VGA-VASPL-1004

#### VGA SPLITTER 1X4 WITH AUDIO

- Easy to Use: Install in Seconds, No Need of Setting
- Connects VGA Source to Four Displays at a Time
- Connects Stereo Audio Source to Four Audio Receivers at a Time
- Supports Highest Video Resolution up to 1920 x 1200 and 1080p
- Supports Highest Video Amplifier Bandwidth to 500MHz



### HMA-HF-HM

HDMI SOCKET TO HDMI M-MINI PLUG

- Commonly Used for TVs and Digital Camcorders to Convert HDMI Cable Ends into a HDMI Mini Connector
- F Adaptor



### HMA-H-HMF

HDMI M-MINI SOCKET TO HDMI

- Commonly Used for TVs and Digital Camcorders to Convert HDMI Mini Cable Ends into an HDMI Connector
- F Adaptor

### HM-2000R

HDMI REPEATER

- Actual Bandwidth: 1.6 GHz
- Input Video Signal: 1.2 Volts p-p
- Input DDC Signal: 5 Volts
- Power Supply: External 5V DC
- HDMI Amplifier Bandwidth: 1.65 GHz
- Amplifies Signal Between Linked HDMI Cables
- HDMI Input/Output Connector: 15 Watts



### HM-2013

DVI-D MALE TO HDMI FEMALE ADAPTER

- High Definition Multimedia Interface for HDTV & Home Theater
- 24Kt Gold Plated Connectors for Optimum Signal Transfer
- Dual Link 24 + 1 Pin (DVI-D) to 19 Pin (HDMI) Digital Connectors



### HM-2012

HDMI FEMALE ADAPTER

- Cable Coupler
- Allows you to Link Two HDMI Cables



### HMBL-2012

HDMI FEMALE ADAPTER

- Cable Coupler
- Allows you to Link Two HDMI Cables
- Blister Packing



### HM-2009

HDMI ADAPTER

- HDMI 19 pin male to HDMI 19 Pin Female Right Angle
- 24K Gold-Plated
- RoHS Compliant



### HMBL-2009

HDMI ADAPTER

- HDMI 19 pin male to HDMI 19 Pin Female Right Angle
- 24K Gold-Plated
- RoHS Compliant
- Blister Packing



### HMF-2002-6

HDMI MALE TO HDMI FEMALE

- 6' / 12'
- with Filter



### HMM-1005-6

MINI HDMI MALE TO HDMI MALE

- 6' / 12'



### HMMM-1105-6

MINI HDMI MALE TO MINI HDMI MALE

- 6'
- with Filter



### VGA-M-M-6

VGA MALE TO VGA MALE CABLE

- Ideal for High Resolution Monitors (1024x768 and Above)
- Triple-Coaxial + Twisted-Pair Wire for Crystal Clear Images
- Impedance Matched @ 75 Ohms for Full Brightness and Vibrant Picture Color
- 6'



### VGA-M-M-12

VGA MALE TO VGA MALE CABLE

- Ideal for High Resolution Monitors (1024x768 and Above)
- Triple-Coaxial + Twisted-Pair Wire for Crystal Clear Images
- Impedance Matched @ 75 Ohms for Full Brightness and Vibrant Picture Color
- 12'



### VGA-M-M-25

VGA MALE TO VGA MALE CABLE

- Ideal for High Resolution Monitors (1024 x 768 and Above)
- Triple-Coaxial + Twisted-Pair Wire for Crystal Clear Images
- Impedance Matched @ 75 Ohms for Full Brightness and Vibrant Picture Color
- 25'

This cable is used to extend out a VGA monitor which is connected into a desktop PC.



### VGA-M-M-50

VGA MALE TO VGA MALE CABLE

- Ideal for High Resolution Monitors (1024 x 768 and Above)
- Triple-Coaxial + Twisted-Pair Wire for Crystal Clear Images
- Impedance Matched @ 75 Ohms for Full Brightness and Vibrant Picture Color
- 50'

This Cable is Used to Extend out a VGA Monitor which is Connected into a Desktop PC.



### VGA-M-M-100

VGA MALE TO VGA MALE CABLE

- Ideal for High Resolution Monitors (1024x768 and Above)
- Triple-Coaxial + Twisted-Pair Wire for Crystal Clear Images
- Impedance Matched @75 Ohms for Full Brightness and Vibrant Picture Color
- Ferrite Core Eliminates EMI Interference
- Molded Connector Ends with Strain Relief
- 100'



**VGA-F-F**  
 FEMALE TO FEMALE ADAPTOR  
 • Adapts VGA Cables, Projectors, and Monitors to the Connections you Need  
 • Screw-Down Terminals Create Secure, Trouble-Free Connections  
 • Gold-Plated Contacts Ensure Solid Signal Transfer



**VGA-F-M-6**  
 VGA FEMALE TO VGA MALE CABLE  
 • Ideal for High Resolution Monitors (1024x768 and Above)  
 • Triple-Coaxial + Twisted-Pair Wire for Crystal Clear Images  
 • Impedance Matched @ 75 Ohms for Full Brightness & Vibrant Picture Color  
 • 6'



**VGA-F-M-12**  
 VGA FEMALE TO VGA MALE CABLE  
 • Ideal for High Resolution Monitors (1024x768 and Above)  
 • Triple-Coaxial + Twisted-Pair Wire for Crystal Clear Images  
 • Impedance Matched @ 75 Ohms for Full Brightness and Vibrant Picture Color  
 • 12'

**VGA-M-2F**

VGA MALE TO 2 VGA FEMALE CABLE  
 • Ideal for High Resolution Monitors (1024x768 and Above)  
 • Ferrite Core Eliminates EMI Interference  
 • Molded Connector Ends with Strain Relief  
 • 12"



**VGA-M-RJ45F**

VGA TO RJ45 ADAPTER  
 • VGA Male / RJ45 Ethernet Port Female  
 • Computer, DVR, Media Center, Game Consoles



**CV-NAHMGV**

HDMI TO VGA CONVERTER  
 • Allows Existing VGA Output of your Monitor to Connect with other Devices Via an HDMI Port



**HDCBL-0102**

HDMI MALE TO 2-FEMALE SPLITTER CABLE  
 • 7.9" (20cm)  
 • Home Theater Interconnects  
 • Digital Interface HDMI Audio & Video Cable  
 • High Definition Multimedia Interface is a New Digital, which will Bring you the Purest Picture and Sound  
 • Delivers Best High-Frequency Response for Optical Resolution Using Silver-Plated Conductor  
 • Maintains Stronger Signal that Yield Superior Sonic and Video Accuracy with Precision Formulated, Polyethylene Dielectric Material  
 • Isolated from Outside Noise for Superior Clarity with Quad-Shielding  
 • Reduces Cross Talk and Interference Using Impedance-Matched, Twisted-Pair Construction  
 • Protects against Wire Damage for Consistently High-Quality Audio & Video with Integrated Strain Relief



**HM-2002-6CL**

HDMI CABLE  
 • 24K Gold Plated Connector  
 • 1080p Triple Shielded Oxygen-Free  
 • Ferrite Core Filter  
 • Clam Shell Packing  
 • 1.4V  
 • 6'



**HM-2002-6**

**HM-2002-12**

**HM-2002-12-4K**

**HM-2002-25**

**HM-2002-25-4K**

HDMI CABLE WITH FTR  
 • Gold Connectors  
 • Available in 6', 12', 25' and 50'  
 • 1.4V



**HM-2005-3**

**HM-2005-3-4K**

**HM-2005-6**

**HM-2005-6-4K**

**HM-2005-9**

**HM-2005-9-4K**

**HM-2005-12**

**HM-2005-12-4K**

**HM-2005-25-4K**

**HM-2005-50**

HDMI CABLE  
 • Gold Connectors  
 • Available in 3', 6', 9', 12', 25' and 50'  
 • 1.4V



**HMBL-2002-6**

**HMBL-2002-12**

**HMBL-2002-12-4K**

HDMI CABLE WITH FTR  
 • Gold Connectors  
 • Available in 6' and 12'  
 • 1.4V



**HMBL-2005-6**

**HMBL-2005-12**

HDMI CABLE WITH FTR  
 • Gold Connectors  
 • Available in 6' and 12'  
 • 1.4V



**HM-2007-6**

HDMI TO DVI CABLE  
 • 6'  
 • 1.4V



**HM-0005-6 (6')**

**HM-0005-12 (12')**  
 HDMI CABLE  
 • 1.4V

### CV-HMVGA

#### HDMI TO VGA CONVERTER

- Allows Users with Existing Monitors with VGA to Connect their Devices Via Micro HDMI Port. Besides Extracting Audio Out, it can also get Extra Power for Devices through Micro USB Port



### CV-MHMVGA

#### MICRO HDMI TO VGA CONVERTER

- Allows Monitors with VGA to Connect Devices Via Micro HDMI Port



### CV-MUSBER

#### MICRO USB TO ETHERNET PORT ADAPTER

- Micro USB 2.0 Male to RJ45 Female Ethernet 10/100 Mbps Network LAN Adapter Cable for Apple MacBook, Lenovo, ThinkPad, Dell, Sony, Samsung, Acer, Asus, and other Laptop Brands



### CV-MUSBVGA

#### MICRO USB TO VGA CONVERTER

- Allows Users with Existing Monitors with VGA to Connect their Devices Via Micro USB Port. Besides Extracting Audio Out, it can also get Extra Power for Devices through Micro USB Port



### CV-TCHMUS

#### USB TYPE C TO USB 3.0 + HDMI + USB TYPE C ADAPTER

- This Adapter is Compliant with TYPE C PD2.0 5Gbps USB3.1 Gen. 1 Standard; it has USB TYPE C Male Input, and Three Outputs: USB 3.0 A Female, HDMI A Female, USB TYPE C Female



### HDB-HDMI-VRCA

#### MINI HDMI TO AV CONVERTER

- Hardware Conversion, Plug and Play, No Software Drivers
- Compatible HDMI 1.3
- Support NTSC and PAL Output Formats
- One HDMI Input, AV Output
- A. Input Terminal: HDMI x 1 Input
- B. Video Output terminal: VIDEO x 1 Output
- C. Analog Audio Output Terminals: L / R x 1 Output
- AV Video Output: 480i, 576i (Optional)
- Audio Output: Left and Right Channels (L / R)

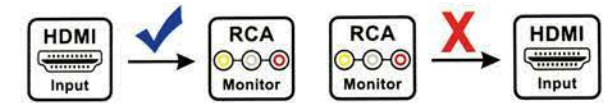

### HDB-VRCA-HDMI

#### HDMI CONVERTER

This Mini Converter Composite Signal and L/R Audio Signal to HDMI Upscale to 1080p Output, Making the Image more Stable and Vivid

- Upscale Composite Video to Full HD 1080p
- HDMI Output is Optional at 720p 50/60Hz or 1080p 50/60Hz
- Settings of Input Signal and Output Resolution is Auto-Store when Power On Again
- Long Press 720p/1080p Button for 3 Seconds to Switch Between 4:3 and 16:9 Mode
- Input: Composite x 1, L/R Stereo Audio x 1
- Output: HDMI x 1, DC x 1
- Dimensions: 76x56x22mm
- Weight: 47g



### HDW-HDMI-VRCA

#### HDMI TO AUDIO VIDEO CONVERTER

- HDMI to AV Converter Connect devices with HDMI output to older devices with Composite/AV connector.
- Supports HDMI up to 1080p@60Hz and HDMI 1.3; It does not support 4k devices.
- HDMI to AV Converter can be switch output standard NTSC/PAL two common formats.
- Compatible for Blu-Ray, HD-DVD, DVD player, HDTV box, HD PVRs, HD DVRs, HD recorder, PS3, Xbox 360, Wii, PC, HD camera.
- Does NOT support 3D. Can not be used as a RCA to HDMI Converter.

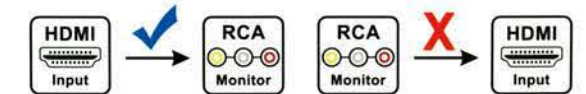

### OFC-3 (3")

### OFC-6 (6")

### OFC-12 (12")

### OFC-25 (25")

#### OPTICAL FIBER CABLE





### CV-MDPHDM

This is a Mini DisplayPort to HDMI Cable Adapter for Interfacing Display-Port Based PC and Notebook Computers with High-Def Displays. The Converter Facilitates the Transition by Offering Seamless Connectivity Between New DisplayPort PC and the Installed.

base HDMI Monitors and Projectors.

- Mini DP Male to HDMI Female Adapter
- Connect your iPod, Macbook
- Gold Plated Connector
- Support 3D/1080p
- 100% Triple Shield



### CV-MDPVGA

MINI DISPLAY TO VGA ADAPTER

• Connect your Mac, or other Mini Display Port Equipped Computer, Directly to your VGA Equipped Display with this Mini Display Port to VGA Adapter

- Supports Display Port 1.1 Input and VGA Output
- Supports PC Resolutions up to 1920x1200 and HDTV Resolutions up to 1080p
- Easy to Use Adapter, No Software Required
- Powered from Mini Display Port Source
- No External Power Needed
- Output Video: RGB Analog Video
- Complies with Display Port 1.1 Standard



### CV-MUSBC5

USB 2.0 Male to RJ45 Female Ethernet 10/100 Mbps Network LAN Adapter Cable for Apple MacBook, Lenovo, ThinkPad, Dell, Sony, Samsung, Acer, Asus, and other Laptop Brands

- USB 2.0 A to Ethernet Port Adapter
- Enables Internet Connection Via USB Port
- Powered by USB Port, No External Power Adapter Required
- Half/Full Duplex 10/100 Mbps Operation
- Self-Adapting 10 Mbps or 100 Mbps Network Adapter
- Compliant to USB Interface Version 1.0/1.1/2.0
- Compatible with Windows 98SE ME/2000/2003/XP/Vista/Windows7



### PCTV-U-HDMI

USB TO HDMI CONVERTER UP TO 1080P

- 3.5mm Audio Output
- Dimensions(L x W x H): 16.5x52x80mm
- Powered by USB
- HDMI Output
- Output Resolution: UP to 1080p
- Weight: 78.5g
- USB to HDMI HD Video Leader



### PCTV-VGA-CMPS

PC TO PC CONVERTER

- Supported VGA Resolution: 640x480@60/72/75/85Hz, 800x600@60/75Hz, 1024x768@60Hz/75Hz
- Simultaneous Output of VGA, Video and S-VIDEO Signals
- Synchronous Display of Pictures on Both the Computer Monitor and the TV Display
- Power Supply from the USB Port (and Power Transformer can be Used when Current is Not Enough from USB Ports)
- Both PC and MAC Machines Supported
- Both PAL System and NTSC System Supported
- Light, Thin Short, Small for Good Portability



### PCTV-VGAU-RCASA

PC TO TV CONVERTER

- Input: 1xVGA
- Loop-Through Outputs: 1xVGA, 1xComposite Video, 1XS-Video
- VGA Resolution: 640x480(60/75Hz), 800x600(60/75Hz), 1024x768(60/75Hz), 1280x768(60Hz), 1280x1024(60Hz)
- Output Signal: CVBS(1.0Vpp),S-Video (Y:1.0pp, C:0.03Vpp)
- Output Signal Impedance: 75Ω
- Power: DC 5V 1A
- Working Temperature: 25~75°C
- Working Humidity: 10%~65%



### HDC-VGA35

HDMI CONVERTER

- VGA + R/L Audio to HDMI
- Input Video Signal: 0.5-1 Volts p-p
- External Power Supply: 5V DC @ 2A
- Output Video: HDMI 1.2a
- Vertical Frequency Range: 50/60Hz
- Max. Power Consumption: 5W
- Multi-Voltage: 100-240V, 50-60Hz, 0.5A



### HDC-HDMI35

HD VIDEO AUDIO CONVERTER

- No Need to Install Drivers
- Portable, Flexible, Plug and Play
- Low Power No Need for a Power Supply
- Output the Audio Synchronized with Video
- High Output Bandwidth, Capable of Supporting 3840 x 2160 @ 30Hz



### HD-DIGI-ANA

HD VIDEO PROCESSING

- Converts S/PDIF or Optical (Toslink) to Analog R/L Audio Signal
- Supports 2 Channels LPCM Digital Audio Only
- Supports Sampling Rate at 32, 44.1, 48 and 96KHz
- Input: S/PDIF x 1, Toslink x 1
- Output: L/R Audio x 1, 3.5mm Audio x 1
- Dimensions: 76 x 56 x 22mm
- Weight: 47g



### HD-DIGI-ANAD

DIGITAL TO ANALOG CONVERTER

- Converts S/PDIF or Optical (Toslink) to Analog R/L Audio Signal
- Supports 2 Channels LPCM Digital Audio Only
- Supports Sampling Rate at 32, 44.1, 48 and 96KHz
- Input: S/PDIF x 1, Toslink x 1
- Output: L/R Audio x 1, 3.5mm Audio x 1
- Dimensions: 76 x 56 x 22mm (2.99" x 2.20" x 0.87")
- Weight: 47g (0.1 Lbs)
- Built-In Conversion Module for Movies with Enhanced Sound Programming



### HDC-VGA01

HDMI CONVERTER

- Input Video Signal: 0.5-1.0 Volts p-p
- External Power Supply: 5V DC@2A
- Output Video: HDMI 1.2a
- Vertical Frequency Range: 50/60Hz
- Power Consumption Max: 5W

# HDMI SERIES

## ACCESSORIES

### APTOS-OF6

### APTOS-OF12

DIGITAL TOSLINK AUDIO CABLE

- Fiber Optic Cable
- Connect your Audio System to your HDTV
- Premium Toslink Audio
- 24K Gold-Plated Connector
- Braided Nylon Jacket
- PMMA Fiber Core
- 6FT. & 12FT. Length



# HDMI SERIES

## HDMI IP DIAGRAM



### ROUTER CONNECTION

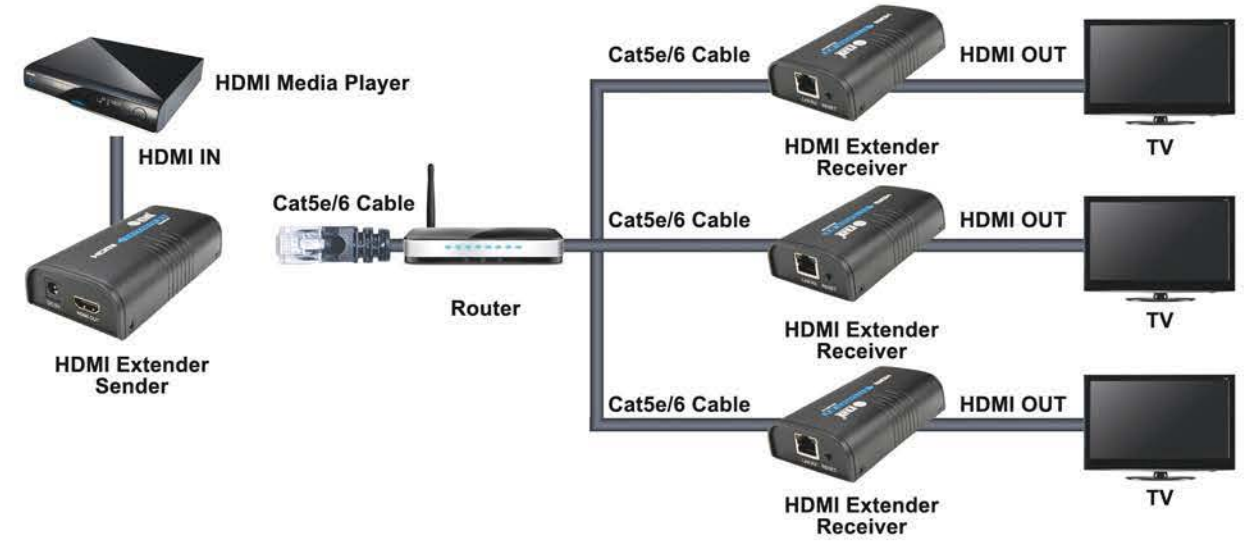

### LAN CONNECTION

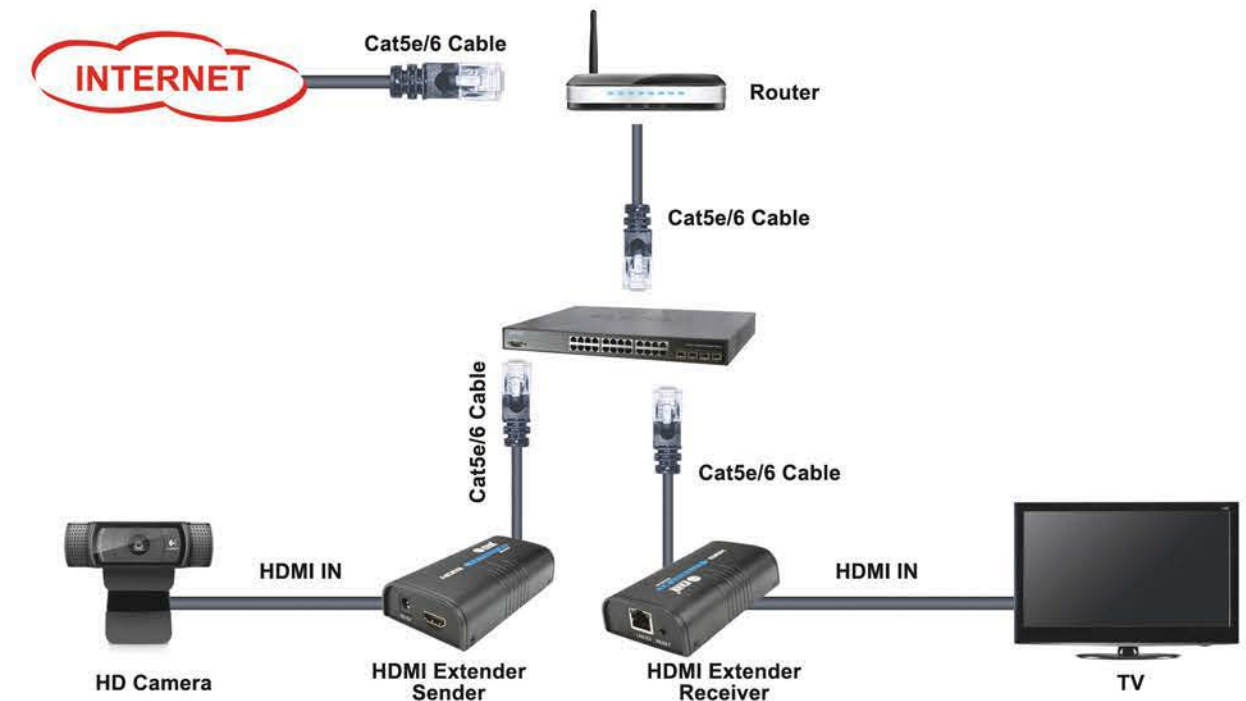

### HDM-3D14RP-75

HDMI CABLE WITH BOOSTER

- Copper
- 75 Ft.



### HDM-3D14RP-100

HDMI CABLE WITH BOOSTER

- Copper
- 100 Ft.

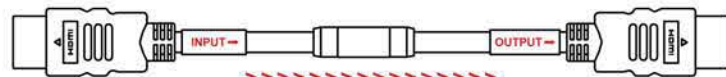

This HDMI Cable is directional, Please Note "INPUT" & "OUTPUT" Plug

## HD-EX120RR

HDMI IP EXTENDER OVER SINGLE CAT5E/6

- Power Supply: 2x 5V DC/1A
- Supports Resolutions: 480i/60Hz, 480p/60Hz, 576i/50Hz, 560p/50Hz, 720p/50/60Hz, 1080i/50/60Hz, 1080p/50/60Hz
- Working Temperature: -10°C-60°C
- Link Connector (Sender/Receiver): UTP/STP CAT5e/6
- Power Consumption: 3W (Max) Each
- Relative Humidity: 20%-90%
- Dimensions: 4.3"x2.3"x1.0" (110x58x26mm)
- Weight: 0.53 Lbs (0.239Kg)



## HD-EX120SS

HDMI IP EXTENDER OVER SINGLE CAT5E/6

- Round Glass Lens Size: 5 Inch
- Optical Power: 3D
- Super Bright 60 Ultra-Efficient SMD LEDs
- Low Power Consumption: 8W
- Adjustable Arm
- Arm Lengths: 16"
- Voltage: AC 110-120V/60Hz
- Luminous Flux: 760 Lumen
- 60Pcs SMD LEDs, 8W



## HD-EX200SR

HDMI IP EXTENDER OVER SINGLE CAT5E/6

**EXTRA LONG RANGE AND POWER REGULATOR**

- Power Supply: 2x 5V DC/1A
- Supports Resolutions: 480i/60Hz, 480p/60Hz, 576i/50Hz, 560p/50Hz, 720p/50/60Hz, 1080i/50/60Hz, 1080p/50/60Hz
- Working Temperature: -10°C-60°C
- Link Connector (Sender/Receiver): UTP/STP CAT5e/6
- Power Consumption: 3W (Max) Each
- Relative Humidity: 20%-90%
- Dimensions: 4.3"x2.3"x1.0" (110x58x26mm)
- Weight: 0.53Lbs (0.239Kg)



SENDER / RECEIVER

## HD-EX250SR

HDMI IP EXTENDER OVER SINGLE CAT5E/6

- Power Supply: 2x 5V DC/1A
- Supports Resolutions: 480i/60Hz, 480p/60Hz, 576i/50Hz, 560p/50Hz, 720p/50/60Hz, 1080i/50/60Hz, 1080p/50/60Hz
- Working Temperature: -10°C-60°C
- Link Connector (Sender/Receiver): UTP/STP CAT5e/6
- Power Consumption: 3W (Max) Each
- Relative Humidity: 20%-90%
- Dimensions: 4.3"x2.3"x1.0" (110x58x26mm)
- Weight: 0.53Lbs (0.239Kg)



SENDER / RECEIVER

## HMWP-HDHDM

2 PORT HDMI WALL PLATE

- Supports 4K, 3D, ARC
- Supports all HDMI Functions Including High Dynamic Range (HDR) Video, 4K, UHD, 3D, 48-Bit Deep Color and Audio Return Channel (ARC)

- DUAL PORT: 2 HDMI Ports with



## HMWP-HDRCA

HDMI + 3RCA WALL PLATE

- 4K Ultra HD UHD 1080P Full HD Compatible & Gold Plated RCA Component
- HDMI 3 RCA Audio Video Wall Face Plate will help you Wire your House Clearly and Efficiently for Audio/Video without Resorting to Letting your Cables Hang Out of an Unsightly Hole in the Wall
- Eliminate that Cluster of Wires and Hide them Behind a Wall; Install Cables Behind your Flat Panel TV or other Audio/Video Devices, Flush to the Wall Surface; Be Neat and Organized!



VIDEO &amp; AUDIO



- HP-27**  
STEREO EARPHONES - BLACK
- Driver Unit: 15mm Mylar Speaker
  - Frequency Response: 20-20kHz
  - Impedance: 32 Ohms
  - Sensitivity: 100dB (at 1kHz)
  - Input Connection: 3.5mm Stereo Plug



- HP-67WH**  
STEREO EARPHONES - WHITE
- Driver Unit: 15mm Neodymium Speaker
  - Frequency Response: 20-20kHz
  - Impedance: 32 Ohms
  - Sensitivity: 102dB (at 1kHz)
  - Input Connection: 3.5mm Stereo Plug



- HD-170MCP**  
HEADPHONE MICROPHONE COMPUTER SET - BLACK
- Speaker Type: Ø27mm Dynamic
  - Frequency Response: 20-20kHz
  - Impedance: 32 Ohms
  - Sensitivity: 100dB
  - Max. Input Power: 1KmW
  - Plug: Ø3.5mm (5/32")
  - Microphone: Condenser



- HD-180MBK**  
HEADPHONE MICROPHONE COMPUTER SET - BLACK
- Speaker Type: Ø30mm Dynamic
  - Frequency Response: 20-20kHz
  - Impedance: 32 Ohms
  - Sensitivity: 100dB
  - Max. Input Power: 1KmW
  - Plug: Ø3.5mm (5/32")
  - Microphone: Condenser
  - For use with Internet



- HD-180MCP**  
HEADPHONE MICROPHONE COMPUTER SET - IVORY
- Speaker Type: Ø30mm Dynamic
  - Frequency Response: 20-180kHz
  - Impedance: 32 Ohms
  - Sensitivity: 101dB

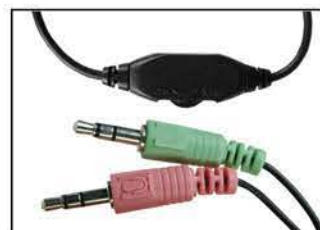

- HD-300VBK**  
HEADPHONE MICROPHONE COMPUTER SET - BLACK
- Speaker Type: Ø40mm Dynamic
  - Frequency Response: 20-20kHz
  - Impedance: 32 Ohms
  - Sensitivity: 115dB



- CD-3500**  
DELUXE HI-FI HEADPHONES
- Speaker Type: Ø40mm Anisotropic
  - Frequency Response: 20-20kHz
  - Impedance: 32 Ohms
  - Sensitivity: 105dB
  - Max. Input Power: 100mW
  - Cord Length: 2.7M
  - Plug: Ø6.3mm (1/4") Gold Adapter
  - Digital



Full Ear Style



- HP-150**  
DELUXE HI-FI HEADPHONES
- Speaker: 40mm
  - Driver Unit: 15mm Mylar Speaker
  - Frequency Response: 20-20kHz
  - Impedance: 32 Ohms
  - Sensitivity: 100dB
  - Max Input Power: 1000mW
  - Plug: 6.3mm



- HP-150V**  
DELUXE HI-FI HEADPHONES
- Speaker: 40mm
  - Driver Unit: 15mm Mylar Speaker
  - Frequency Response: 20-20kHz
  - Impedance: 32 Ohms
  - Sensitivity: 105dB
  - Max Input Power: 1000mW
  - Plug: 6.3mm



- QE5N-BT-BLK**  
WIRELESS STEREO HEADSET
- Unique Ring-Necked Design
  - Opening up a New Era of Bluetooth
  - Ultralight Elastic Memory Material,
  - High-Fidelity Stereo Sound Audio Earphones for Total Entertainment
  - Intelligent Noise Reduction
  - Long Standby (360 Hours)
  - Less than 2.5 Hours Recharge Time
  - Weighting only 32 Grams



**MT-209SL**

PANEL LENGTH 30"~42" TV

- Maximum TV Weight: 75 Kgs – 165 lbs
- Color: Black
- Anti-Theft and Anti-Tamper Lock Positions
- Level Gauge Built-In for easy One Step Install
- Tilt

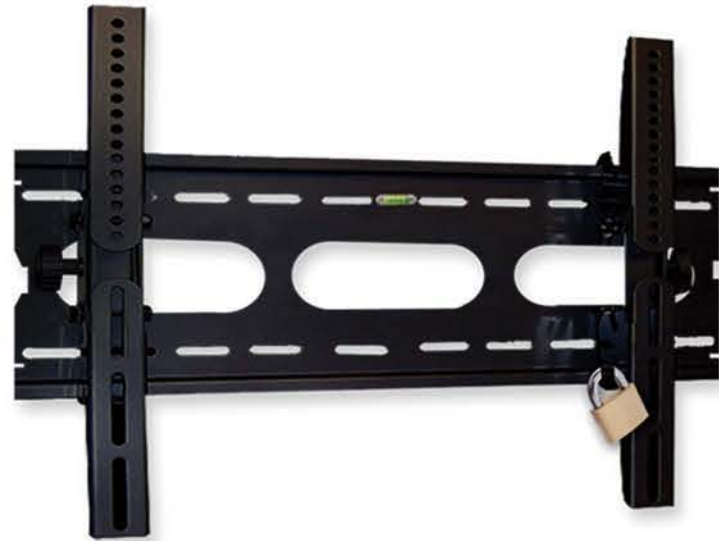

**MT-209XL**

PANEL LENGTH 42"~63" TV

- Maximum TV Weight: 75 Kgs – 165 lbs
- Color: Black
- Anti-Theft and Anti-Tamper Lock Positions
- Level Gauge Built-In for Easy One Step Install
- Tilt

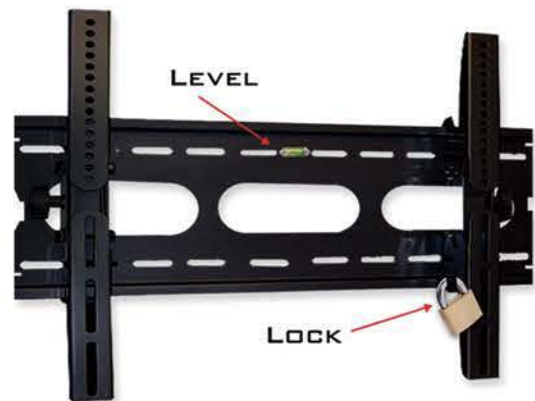

**MMT-3763**

MULTIMEDIA MONITOR MOUNT FOR DIGITAL MENU BOARD

- Fixed LCD/ Plasma Mount
- Profile/TV to Wall Distance: 70mm(2.8")
- Max Mount Pattern: 400x800mm(15.7x31.5")
- Tilt: -15°~+5°
- Supports up to 45Kg (99Lbs)
- For Plasma/LCD TV from 37"~63"
- Easy to Install
- Mounting Hardware Included
- Color: Black
- Weight: 17.2lbs (7.8Kg)

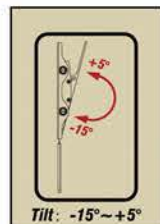
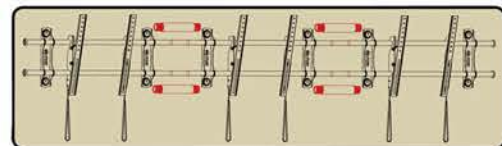

**MCM-4275**

TV LCD/LED BRACKET

- Fixed LCD/LED Wall Mount
- Width Adjustable to hold TV's from 42"-75"
- Pan: 360°
- Tilt: ±15° Up and Down
- Max Pattern: 31.5" x 19.7" (800x500mm)
- Variable Drop-Pole: up to 80cm (31.5") of Adjustment
- Solid, Heavy Gauge Cold Rolling Steel Construction
- Supports up to 65Kgs (143lbs)
- Color: Black
- Easy to Install Mounting Hardware Included

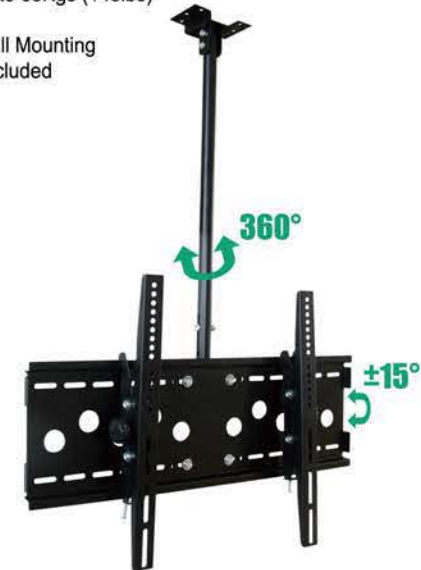

**MFLR-3770 A&B**

PUBLIC MOBILE TV CART

- Fixed LCD/Plasma Mount
- Width Adjustable to hold TV's from 37" to 70"
- With Four Wheels
- Supports up to 40Kg (88Lbs)
- Easy to Install
- Mounting Hardware Included
- Color: Black

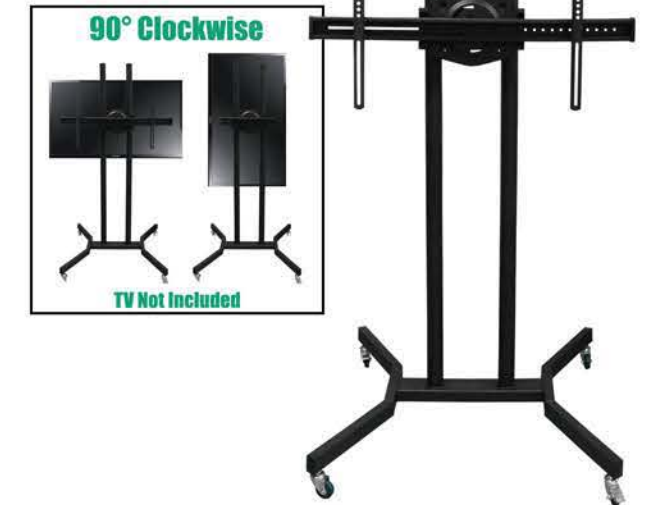

**MFLMS-3770**

PORTABLE TRIPOD TV LCD/LED MOUNT

- For Flat Panel Televisions (37"~70")
- Solid, Heavy Gauge Steel Construction
- Supports up to 35kgs (77Lbs)
- Tilt: -8°~0°
- Range of Height: 48.8"~74" (1240~1880mm)
- Easy to Install
- Mounting Hardware Included



**MFLRE-3770S**

TV FLOOR STAND

- Fixed LCD / Plasma Mount
- Max Mount Pattern: 400 x 600mm (15.7" x 23.6")
- With Four Wheels
- Tilt: ±10°
- Supports up to 40Kg (88Lbs)
- For Plasma/LCD TV 37"~70"
- Easy to Install
- Mounting Hardware Included
- Color: Black



MSE-1442F

ECONOMY FLAT TV MOUNT

- Fixed LCD/LED Wall Mount
- Maximum TV Weight: 66lbs
- Mounting Profile: 27mm
- Width Adjustable to hold TV's from 14" to 42"
- VESA Standard: 75 X 75, 100 X 100, 200 X 100, 200 X 200
- Easy to Install

14"-42"



MSE-3260F

FIXED LCD/LED WALL MOUNT

- Maximum TV Weight: 88 Lbs
- Mounting Profile: 27mm
- Width Adjustable to hold TV's from 32" to 60"
- VESA Standard: 200x200, 400x200, 300x300, 400x400
- Easy to Install

32"-60"  
for TV

FLAT



MSE-60100F

TV LCD/LED BRACKET

- Fixed TV LCD/LED Mount
- For Flat Panel Televisions (60" ~ 100")
- Solid, Heavy Gauge Steel Construction
- Supports up to 75kgs (165 lbs)
- Easy to Install
- Mounting Hardware Included

FLAT

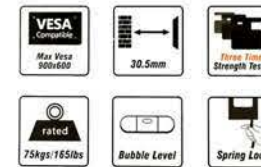

MSF-3270

FIXED LCD/LED WALL MOUNT

- Vertical Inclination Adjustable: +/-15°
- Maximum TV Weight: 50Kgs (110lbs)
- Color: Black
- Width Adjustable to hold TV's from 32" to 70"
- Solid, Heavy Gauge Steel Construction
- Tilt Left/Right
- Easy to Install

FLAT



32"-70"  
for TV

MSE-3770F

FIXED LCD/LED WALL MOUNT

- Maximum TV Weight: 40Kgs (88lbs)
- Mounting Profile: 27mm
- Width Adjustable to hold TV's from 37" to 70"
- VESA Standard: 75x75, 100x100, 200x200
- Easy to Install

FLAT

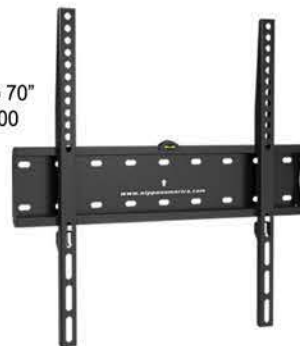

MTE-2555CR

TV LCD/LED CORNER MOUNT

- Articulated LED/LCD TV Wall Mount
- For Flat Panel Televisions (25"-55")
- Supports up to 66 Lbs (30Kg)
- Solid, Heavy Gauge Steel Construction
- Level Gauge Built-In for Easy One Step Install
- Up-Down Inclination Adjustable: ±15°
- Swivels from Left/Right to Right/Left for Viewing from Horizontal 120°
- Hinged Arm Extends TV 110mm to 485mm of Wall
- Color: Black



MTE-1442T

TV LCD/LED BRACKET

- Fixed LCD/LED Wall Mount
- Maximum TV Weight: 66lbs
- Mounting Profile: 53mm
- 12° ~ -12° Tilting
- Width Adjustable to hold TV's from 14" to 42"
- VESA Standard: 75 x 75, 100 x 100, 200 x 100, 200 x 200
- Easy to Install

TILT



MTE-3260T

FIXED LCD/LED WALL MOUNT

- Maximum TV Weight: 88lbs
- Mounting Profile: 53mm
- 12° ~ -12° Tilting
- Easy to Install
- Width Adjustable to hold TV's from 32" to 60"
- VESA Standard: 200x200, 400x200, 300x300, 400x400

TILT

32"-60"  
for TV



MT-2070

FIXED LCD/LED WALL MOUNT

- Width Adjustable to hold TV's from 20" to 70"
- Maximum TV Weight: 60Kgs (132 lbs)
- Low Profile Design, only 2.36" (60mm) against Wall
- Mounting Holes up to 24.40" (620mm) x 16.14"(410mm)
- Free Bubble Level System
- Solid, Heavy Gauge Steel Construction

FLAT

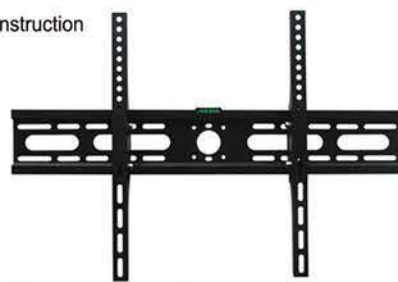

**MRE-1342DRT**

ECONOMY STEEL FULL-MOTION TV WALL MOUNT

- Freely Tilting Allows Easy TV Angle Adjustment
- Swiveling Arm Offer Maximum Viewing Flexibility
- Built-In Level Adjustment Ensures Perfect Positioning
- Cable Clips keep Cables Organized and Protected
- Direction Indicator Assures Correct Installation
- Separate VESA Plate Design Enables Easy Installation



**ROTATING**

**MSE-2360DRT**

TV WALL BRACKET

- Width Adjustable to hold TV's from 23" to 60"
- Maximum TV Weight: 66lbs
- Pan: +/- 90°
- Tilt: +/- 20°
- Profile: 3.5" ~ 15.7"
- Cable Management, Rotatable Mount
- Color: Black



**ROTATING**

**MSE-1323AR**

FIXED LCD/LED WALL MOUNT

- Maximum TV Weight: 20Kgs (44lbs)
- Width Adjustable to hold TV's from 13" to 23"
- Max VESA 100x100
- Aluminum
- 360° Swivel
- Mounting Profile: 85-240mm
- Easy to Install



**ROTATING**

**MAE-1323AR**

FIXED LCD/LED WALL MOUNT

- Maximum TV Weight: 20Kgs (44lbs)
- Width Adjustable to hold TV's from 13" to 23"
- Max VESA 100x100
- Aluminum
- 360° Swivel
- Mounting Profile: 85-385mm
- Easy to Install



**ROTATING**

**MRE-1460SART**

TV WALL BRACKET

- Width Adjustable to hold TV from 14"~60"
- Maximum TV Weight: 66 Lbs
- Swivel: 270°
- Tilt: 30°
- Profile: 10.2" (260mm)
- Cable Management, Rotatable Mount
- Color: Black

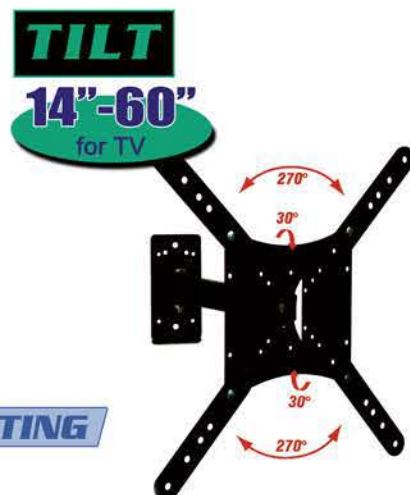

**ROTATING**

**MSE-2360SART**

TV WALL BRACKET

- Pan: +/- 45°
- Tilt: +/- 20°
- Maximum TV Weight: 66lbs
- Mounting Profile: 3.5" ~ 7.9"
- Cable Management, Rotatable Mount
- Width Adjustable to hold TV's from 32" to 60"
- Color: Black



**ROTATING**

**MRE-1343RT**

FIXED LCD/LED WALL MOUNT

- Maximum TV Weight: 20Kgs (44lbs)
- Width Adjustable to hold TV's from 13" to 43"
- VESA Standard: 75x75, 100x100, 200x200
- +5°~-12° tilt, +90°~-90° Swivel, +3°~-3° Level Adjustment
- Mounting Profile: 60~190mm
- Easy to Install



**ROTATING**

**MTE-3625DVD**

FIXED UNIVERSAL DVD WALL MOUNT

- Tempered Black Glass Shelf
- Glass Dimensions: 14.2" x 9.8" x 0.2" (360x250x5mm)
- Supports up to 17.6Lbs (8 Kgs)
- Cable Board for Hiding Wires
- Assemble Guide Included



**WM-SB-850**

SOUNDBAR BRACKET

- Material: Aluminum
- Speaker Hole Dimension: M4, M5, M6, 1/4"
- Profile: 15mm



MA-2342

- FIXED LCD/PLASMA MOUNT
- Width Adjustable to hold TV's from 23" to 42"
  - Solid, Heavy Gauge Steel Construction
  - Color: Black
  - Easy to Install
  - Maximum TV Weight: 50Kgs (110lbs)

ROTATING



MA-3063

- FIXED LCD/PLASMA MOUNT
- Width Adjustable to hold TV's from 30" to 60"
  - Solid, Heavy Gauge Steel Construction
  - Color: Black
  - Easy to Install
  - Adjustable Width between 110 and 450mm
  - Vertical Inclination Adjustable +/- 10°
  - Maximum TV Weight: 60Kgs (132lbs)

ROTATING



MTE-2560CR

- TV LCD/LED CORNER MOUNT
- Articulated LED/LCD TV Wall Mount
  - For Flat Panel Televisions (25"~60")
  - Supports up to 66 Lbs
  - Solid, Heavy Gauge Steel Construction
  - Level Gauge Built-In for Easy One Step Install
  - Up-Down Inclination Adjustable: 15°
  - Swivels from Left/Right for Viewing from Horizontal 120°
  - Hinged Arm Extends TV 110MM TO 485mm of Wall
  - Color: Black

ROTATING



MON-CLR1327-SN

- MONITOR DESK MOUNT
- Fit Screen Size: 13"~27"
  - Weight Capacity: 22 lbs (10kg)
  - VESA Compatible: 75 x 75, 100 x 100
  - Tilt Range: +45°~-45°
  - Swivel Range: +45°~-45°
  - Screen Rotation: +180°~-180°
  - Installation: Grommet, Clamp
  - Suggested Desktop Thickness: Clamp: 10~88mm; Grommet: 10~80mm
  - Cable Management: Yes

13"-27" For Monitor



MON-CLR1327-DB

- DUAL MONITOR DESK MOUNT
- Fit Screen Size: 13"~27"
  - Weight Capacity (per screen): 22 lbs
  - VESA Compatible: 75x75, 100x100
  - Tilt Range: +45°~-45°
  - Swivel Range: +15°~-15°
  - Screen Rotation: +180°~-180°
  - Installation: Grommet, Clamp
  - Suggested Desktop Thickness: Clamp: 10~88mm; Grommet: 10~80mm
  - Cable Management: Yes

13"-27" For Monitor

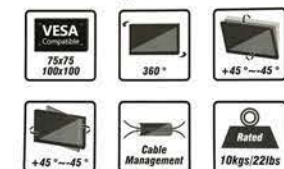

MAE-1955

- RETRACTABLE TV/LCD/LED BRACKET
- Fixed LCD/LED Wall Mount
  - Maximum TV Weight: 88lbs
  - Mounting Profile: 35mm
  - Width Adjustable to hold TV's from 19" to 55"
  - VESA Standard: Max.400 x 400

19"-55"



MAE-1960

- TV LCD/LED BRACKET
- Fixed LCD/LED Wall Mount
  - Maximum TV Weight: 77 lbs
  - Mounting Profile: 63-427mm
  - Width Adjustable to hold TV's from 32" to 60"
  - VESA Standard: 200x200, 300x300, 400x200, 400x400
  - Easy to Install

19"-60"



MAE-3270

- TV LCD/LED BRACKET
- Retractable Non-Tilting LCD/LED Wall Mount
  - Maximum TV Weight: 40Kgs (88lbs)
  - Mounting Profile: 75-470mm
  - Width Adjustable to hold TV's from 32" to 70"
  - VESA Standard: Max. 600 x 400
  - Easy to Install

32"-70"



MAE-3770CRV

- CURVED TV LCD/LED BRACKET
- Fixed LCD/LED Wall Mount
  - Maximum TV Weight: 35Kgs (77lbs)
  - Mounting Profile: 63-427mm
  - Width Adjustable to hold TV's from 37" to 70"
  - VESA Standard: 200x200, 300x300, 400x200, 400x400, 600x400
  - Easy to Install

ROTATING

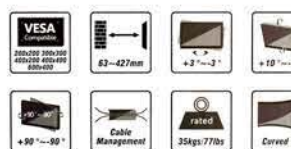

CURVED TV LCD/LED BRACKET

37"-70"





## VIDEO & AUDIO

### TV BRACKETS

#### MCPJ-912T

##### PROJECTOR CEILING AND WALL MOUNT

- Weight Capacity: 44 lbs
- Profile: 16.9" - 25.6"
- Tilt Range: +15° ~ -15°
- Swivel Range: +8° ~ -8°
- The Maximum Distance between any Two Holes is 12"
- The Minimum Distance between any Two Holes is 9"
- The Mounting Holes on Projector must be between 9" - 12"
- Easy to Install

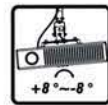

**9"-12"**  
Distance between the mounting holes



#### MLETT-1370-L

##### TABLETOP TV STAND

- Fixed LCD / Plasma Mount
- VESA Compatibility: 75 x 75mm~800 x 400mm (3" x 3"~31.5" x 15.7")
- Supports up to 50Kg (110Lbs)
- For Plasma/LCD Flat Screen TV 13"~70"
- Easy to Install
- Mounting Hardware Included
- Color: Black

**13"-70"**



#### MLETT-3255-S

##### TABLETOP TV STAND

- Fixed LCD / Plasma Mount
- Max Mount Pattern: 400 x 400mm (15.7" x 15.7")
- Cable Management
- Supports up to 30Kg (66Lbs)
- For Plasma/LCD TV 32"~55"
- Easy to Install
- Mounting Hardware Included
- Color: Black

**32"-55"**



#### MLETT-3760-L

##### TABLETOP TV STAND

- Fixed LCD / Plasma Mount
- Max Mount Pattern: 600 x 400mm (23.6" x 15.7")
- Cable Management
- Supports up to 30Kg (66Lbs)
- For Plasma/LCD TV 37"~60"
- Easy to Install
- Mounting Hardware Included
- Color: Black

**37"-60"**



## VIDEO & AUDIO

### UNIVERSAL REMOTE CONTROLS



#### RCN-503

##### TV REMOTE CONTROL 3 WAY

- Consolidates up to 3 Remotes
- Compatible with Today's Most Popular Brands of TV, Satellite, VCD & DVD



#### RCN-504

##### TV REMOTE CONTROL 4 WAY

- Consolidates up to 4 Remotes
- Compatible with Today's Most Popular Brands of TV, Satellite, VCD & DVD



#### RCN-506

##### TV REMOTE CONTROL 6 WAY

- Consolidates up to 6 Remotes
- Compatible with Today's Most Popular Brands of TV, Satellite, VCD & DVD



#### RCN-906

##### BIG REMOTE CONTROL 6 WAY

- Consolidates up to 6 AV Devices
- Compatible with Today's Most Popular Brands of TV, Satellite, VCD & DVD
- Replace all your Existing Remote Controls
- Requires 2 AA Batteries
- Easy Viewing & Navigation



#### ZNA-110BL

##### UNIVERSAL REMOTE

- TV Only
- Advanced DVD and Satellite Functions
- Sleep Timer, Closed Caption
- Input Source Selector
- Blister Retail Packing
- Available in Bulk
- Poly Bag Packing



#### ZNA-110

- Available in Bulk
- Poly Bag Packing

#### ZNA-410BL

##### UNIVERSAL REMOTE CONTROL

- 4 WAY IN 1 BLIST
- Advanced DVD and Satellite Functions
- Sleep Timer
- Closed Caption
- Input Source Selector
- 4 Device: TV, VCR, DVD & CBL



## VIDEO & AUDIO

### UNIVERSAL REMOTE CONTROLS

#### RCN-C931BL

##### ONE WIPE REMOTE

- Ideal for Hospitals, Schools & Hotels
- Easy Setup with Auto Code Search
- Security Cover for Batteries
- Close Caption & Sleep Button
- Consolidates up to 3 Remotes
- Compatible with Today's Most Popular Brands



**ONE  
WIPE  
REMOTE**



**The Ultra Smooth  
Surface of this Remote  
Allows you to Clean and  
Sanitize in just 1 Wipe!**

#### RCN-SB906BL

##### 6 IN 1 UNIVERSAL REMOTE

- 6 in 1, for TV1, TV2, Cable, Satellite, VCR, AUX
- Consolidates up to 6 Remotes
- Compatible with Today's Most Popular Brands



**STREAMING PLAYER + SOUND BAR COMPATIBLE!**

#### APTOS-OF6

##### APTOS-OF12

##### DIGITAL TOSLINK AUDIO CABLE

- Fiber Optic Cable
- Connect your Audio System to your HDTV
- Premium Toslink Audio
- 24K Gold-Plated Connector
- Braided Nylon Jacket
- PMMA Fiber Core
- 6FT. & 12FT. Length



**24KT  
Gold-Plated  
RCA Connectors**

## VIDEO & AUDIO

### VIDEO ACCESSORIES



#### KF-235

- Gain Control
- FM Trap/ 24DB Cable Amplifier
- NA Boosters



#### MTV-196

- Distribution Amplifier
- Low Noise
- High Output Power
- 2 Way Output
- Gain Control
- 54-550MHz
- 30dB Gain



#### NB-810 (110V)

- 4 Way Amplifier
- 10dB Gain
- 50-400MHz Bandwidth



#### MTV-310

##### 1 IN 4 OUT - 4K HD SIGNAL SPLITTER

- Input/Output: 1/4
- Frequency Range: 47-870MHz
- Gain: 28dB (Max)
- Noise Figure: < 2dB
- Power Supply:  
INPUT: 100-240V 50/90Hz 0.15A  
OUTPUT: 5.0V = 1000mA



#### N64-100

- AUDIO/VIDEO CABLE
- For Nintendo 64



#### PSX-300

- AUDIO/VIDEO CABLE
- For Playstation

**HD-ATSC-4**

- DIGITAL TV CONVERTER
- Converts Over-the-Air Digital Television Signals for Use with Standard TVs
  - Receives Free Over-the-Air Digital TV Signals
  - Record Live TV
  - Full HD 1080P / 1080i / 720p / 480p
  - Aspect Ratio: 16:9 & 4:3
  - AV, HD Outputs
  - USB Multimedia Player
  - Cable Loop Through
  - On-Screen Electronic Program Guide Support
  - Favorite Channel List
  - Parental Control Function
  - Supports Closed Caption
  - Full Function Remote Control



**RSS-1045-IR**

- WIRELESS IR REMOTE EXTENDER REPEATER  
TRANSMITTER RECEIVER BLASTER EMITTER  
RECEIVER(RX):
- Transmission Frequency: 433.92MHz±200KHz Superherodyne
  - IR Signal Transmitting: ≤5m
  - Powe Input: DC5V/100mA, or Two Batteries of AA LR6 1.5V(Not Included)
  - Horizontal Barrier-Free Transmission Distance between the Transmitter and Receiver: ≤200m
- TRANSMITTER (TX):
- Transmission Frequency: 433.92MHz±500KHz Superherodyne
  - Carrier Frequency: 38KHz/56KHz
  - IR Signal Transmitting: ≤10m
  - Powe Input: DC5V/100mA, or Two Batteries of AA LR6 1.5V(Not Included)



**F-29**

- ANTENNA
- Universal Rabbit Ear Design
  - Dual
  - 10" Collapsed
  - 31" Extended
  - Nickel Finish



**F-29S**

- PANASONIC TV ANTENNA
- Universal Rabbit Ear Design
  - Dual
  - 10" Collapsed
  - 31" Extended
  - "F" Push On



**GTS-090-8**

- Converts A/V RCA Signal to "F" Type Coaxial 75 Ohm Signal
- RF Modulator
- Converts "RCA" type output to "F" Type Output, to be used for TV's without "RCA" Type Inputs



**GTS-090-20**

- AUTO TV SWITCH AV > RF
- RF Modulator
  - Automatically Switch from AV Device to Home TV when AV Device System is Turned On
  - Shielded Coaxial Cables for a Clear Picture, Free from Outside Signal Interference



**GTS-090-10**

- VERTICAL OR HORIZONTAL DESIGN WITH REMOVABLE BASE
- Auto Selection for A/V or Antenna Inputs
  - RF Converter
  - Converts "RCA" Type Output to "F" Type Output, to be used for TV's without "RCA" Type Inputs

**F-29A**

- F TYPE ANTENNA
- Universal Rabbit Ear Design
  - Dual
  - 10" Collapsed
  - 31" Extended
  - "F" Push On



**F-32**

- INDOOR ANTENNA
- VHF/UHF
  - Dual
  - 10" Collapsed
  - 31" Extended



**GTS-1003**

- PAL TO NTSC CONVERTER,
- AV Input & Output, Converter Allows Conversion PAL Inputs NTSC 3.58 Output Signal

**BL-HD-MIMAD**

- MHL HDTV SMART ADAPTER
- Connect your MHL-Enabled Phone to your High Definition TV or Computer Monitor
  - Requires Standard HDMI Cable and Micro USB Charging Cable
  - Simply Add Plug between MHL Adapter and your Device as shown
  - 5-pin to 11pin Adapter Plug allows you to use your MHL Smart Adapter with the Latest Galaxy and MHL Compatible Devices



**F-32N**

- INDOOR ANTENNA
- VHF/UHF
  - Dual
  - 10" Collapsed
  - 31" Extended
  - Nickel Finish



**F-33N**

- RABBIT EAR ANTENNA
- VHF/UHF
  - Dual
  - 10" Collapsed
  - 31" Extended
  - Nickel Finish



ANTENNAS



- F-33A**  
ANTENNA
- Universal Rabbit Ear Design
  - Dual
  - 10" Collapsed
  - 31" Extended
  - Nickel Finish
  - "F" Push On N-223 Type Cable



- F-33N81**  
ANTENNA
- Universal Rabbit Ear Design
  - Dual
  - 10" Collapsed
  - 31" Extended
  - Nickel Finish
  - "F" Type Female Mounted on Base
  - VHF/UHF
  - W / F 81 Connection



- KF-112HD**  
INDOOR UHF/VHF/FM ANTENNA
- Enhances Local TV Channels Reception, Perfect for Satellite/Cable Backup & Digital TV Signal
  - Adjustable Super-Long 38" Chrome-Plated Antenna Mast
  - Telescopic Dipoles w/Brass UHF LOOP
  - Coaxial Cable Connection to any TV Brands
  - Clearly Receives all Local Channels
  - Superior Signal Reception



- KF-3002HD**  
INDOOR HDTV ANTENNA AMPLIFIED
- Improves VHF/UHF/FM Reception
  - LED Power On Indicator
  - On/Off Amplifier Knob with Variable Signal Gain Control
  - Super Efficient Noise Reduction Circuitry
  - Tilt Adjustment



- KF-7000HD**  
AMPLIFIED INDOOR TV ANTENNA
- Improves VHF/UHF/FM Reception
  - LED Power On Indicator
  - On/Off Amplifier Knob with Variable Signal Gain Control
  - Tilt Adjustment



- ST-802**  
HDTV ANTENNA
- 6 Position Picture Switch
  - 4 Section
  - 32" Extended

ANTENNAS



- KF-1204**  
HDTV INDOOR ANTENNA
- Gain: VHF -4 ~ 0dBi; UHF 1 ~ 3dBi
  - Operation Frequency: VHF 174 ~ 230MHz; UHF 470 ~ 810MHz
  - Output Impedance: 75 Ohm
  - Standing Wave Ratio: 1.5 : 1



- KF-1309-HD**  
HDTV INDOOR ANTENNA
- Innovative Flat, Paper-Thin Antenna Design
  - High Gain/Low Noise Digital TV Signal Reception
  - Multi-Directional Signal Reception
  - Easy Installation, No Tools and No Assembly Required



- KF-1109HD**  
HD DIGITAL TV INDOOR ANTENNA
- Frequency Range: VHF 47-240MHz; UHF 470-862MHz
  - Gain: 4dBi (Max)
  - Impedance: 75Ω
  - Noise Figure: ≤ 2dB
  - Connector Type: F-male/IEC
  - Dimensions: 10 3/4" x 3"



- KF-1335-HD**  
HD DIGITAL ANTENNA
- Working Frequency: VHF 47~240MHz, UHF 470~862MHz
  - V.S.W.R.: ≤2.0
  - Typical Antenna Gain: 5 dBi
  - Polarization: Linear
  - Impedance: 75 Ohm
  - Material of Coaxial Cable: RG 2.5C2V, L=10 Feet
  - USB Cable: 0.8M
  - Connector Type: F Male
  - Reception Range: 35 Miles
  - Size: 300 x 280 x 1.1 mm

- KF-1500A-HD**  
HD DIGITAL ANTENNA WITH BOOSTER
- Working Frequency: VHF 47~240MHz, UHF 470~862MHz
  - V.S.W.R.: ≤2.0
  - Typical Antenna Gain: 5 dBi
  - Polarization: Linear
  - Impedance: 75 Ohm
  - Material of Coaxial Cable: RG 2.5C2V, L=10 Feet
  - USB Cable: 0.8M
  - Connector Type: F Male
  - Reception Range: 35 Miles
  - Size: 300 x 280 x 1.1 mm
  - Signal Amplifier Booster



- KF-1650A-HD**  
OUTDOOR HD DIGITAL TV ANTENNA AMPLIFIER KIT (with Signal Amplifier Booster)
- VHF 47~240 MHz, UHF 470~862 MHz
  - V.S.W.R.: ≤ 2
  - Typical Antenna Gain: 30dBi with Amplifier
  - Impedance: 75 Ohm
  - RG6 Coax Cable: Cu 1.5C - 2V, L=10M
  - Connector Type: F Male
  - Reception Range: 60 Miles
  - Size: 22.2" x 11" x 0.8" (565 x 280 x 20mm)



**W-15-259**

**HIGH GAIN SIGNAL AMPLIFIER**

- Amplifies HDTV, VHF, UHF, and FM Signals
- Gain Control Gives you the Ability to Fine-Tune Reception for Each Station
- On/Off FM Trap Cuts FM Interference so it doesn't Disrupt Television Reception
- Dual Outputs for Connecting up to Two Separate TV or Receivers
- Gold-Plated Connectors Help Improve Signal and Reduce Interference
- Frequency: 54-806 MHz
- FM trap: > 20dB @ 100 MHz
- Gain: 15dB at Outdoor Amplifier; Up to 6dB at Indoor Amplifier
- Gain Control: 0-10dB



**W-3000**

**HIGH GAIN AND LOW NOISE INLINE AMPLIFIER KIT**

- When your TV Picture Freezes or Appears Blotchy, it is usually Caused by a Weak Signal, our Signal Amplifier can Improve Poor Picture Quality Caused by Weak Signals
- Less than 25dB, Power by DC 5V 500mA, Enhances the Performance of Passive Antennas in Challenging Areas of Reception
- Noise Figure: Less than 2dB, Preserves Signal Purity with Extremely Low-Noise (ELN) Circuitry



**WVSR-2000**

**WIRELESS A/V TRANSMITTER & RECEIVER**

- Uses a 2.4GHz ISM Frequency Band, Support 4 Groups of Channels
- Uses 2.4GHz ISM Frequency Band, Supports 8 Groups of Channels
- Wireless Transmission is Suitable for One-Floor or Two-Floors
- Uses Set Top Box, CCD Camera, DVD, DVR & PC to Transmit to TV

**AutoVoltage**  
**100-240V**

**1000 mA**  
**DC 5V**



**WV-870**

**TV REMOTE CONTROLLED ROTATABLE ANTENNA**

- Infrared Remote Control for Long Distance Reception and Anti-Interference
- Receives VHF-UHF Channels
- Rotation: Max 360°
- Frequency: 45-910 MHz
- VHF Gain: 18dB
- UHF Gain: 28dB
- Standard Wave: <4
- Impedance: 75Ω
- Power: 3W
- Working Voltage: 110V/60Hz
- Rotation Speed: 4r/m
- Built-In Low Noise Circuit
- Built-In High Gain Booster



**WM-4**  
**ANTENNA WALL MOUNT**  
• 4"



**WM-6**  
**ANTENNA WALL MOUNT**  
• 8"

**WM-CH-418**

**ANTENNA BRACKET CHIMNEY MOUNT**

- Y" Type Configuration
- Provides 4-inch Clearance from Chimney
- Stainless Steel Straps
- Includes two 18-foot Stainless Steel Straps ideal for Chimneys up to 12 Linear Feet around
- Use this to Mount 1" to 1-1/4" O.D. Masts
- Two Mounts per Kit - Made of 1-1/4" Wide X 12 Gauge Galvanized Steel



*Includes 18 Feet of Galvanized Straps to Wrap around your Chimney for mounting your TV Antenna Mast (Masts from 1.00 to 1.25 inch O.D.) through two straight bolt clamps. Hardware included as shown. Professional Grade, Sturdy. (Mast not Included)*



**WM-19**

**DIGITAL ANTENNA J-POLE MOUNT**

- 180° Adjustability
- Color: Black
- Pipe Diameter: Φ 1" (25mm)
- Pipe Thickness: 0.06" (1.5mm)
- Net Weight: 1Kg (2.2lbs)



**STA-150C**

**VHF/UHF/FM ANTENNA**

- With Booster



**MST-516**

**ANTENNA MAST**

- 5', 16 Gauge

**TRI-3137**

**ANTENNA TRIPOD**



**UVV633**

VHF/UHF ANTENNA

- Channels: 2-69, 4-7dB VHF Gain, 3-5dB UHF Gain
- 75/300 Ohm
- 12 Elements



**UVV1342**

VHF/UHF ANTENNA

- Channels: 2-69, 7-11dB VHF Gain, 6-9dB UHF Gain
- 75/300 Ohm
- 19 Elements

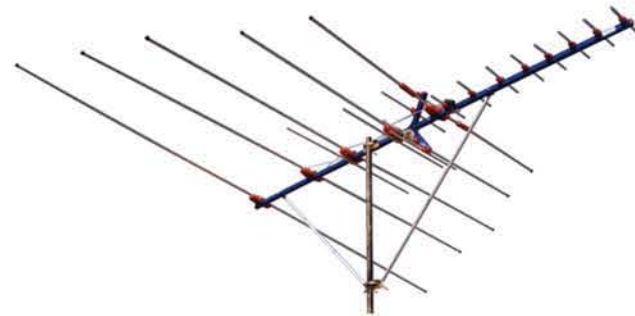

**UVV922**

VHF/UHF ANTENNA

- Channels: 2-69, 4-7dB VHF Gain, 3-5dB UHF Gain
- 75/300 Ohm
- 15 Elements



**UVV933**

VHF/UHF ANTENNA

- Channels 2-69, 8-14dB VHF Gain, 3-5dB UHF Gain
- 75/300 Ohm
- 15 Elements



**43UX**

UHF HD OUTDOOR ANTENNA

- Channels: 21 to 69
- 75/300 Ohm
- 43 Elements



**U-W19**

HIGH DEFINITION SIGNAL ANTENNA

- Terrestrial HDTV - Broadcast Compatible
- Reception Channel 13-62
- Impedance 75 Ohms



**U-W25**

HIGH DEFINITION SIGNAL ANTENNA

- Terrestrial HDTV - Broadcast Compatible
- Reception Channel 13-62
- Impedance 75 Ohms



**UWV-HD600**

SUPER HIGH GAIN UHF/VHF TV ANTENNA

- Reception Channel Ech 2-69
- Impedance: 75 Ω
- Terrestrial HDTV Broadcast Compatible
- Double Packed for UPS Shipping



Easy  
Installation



**F-90**

• FM Dipole Indoor Antenna

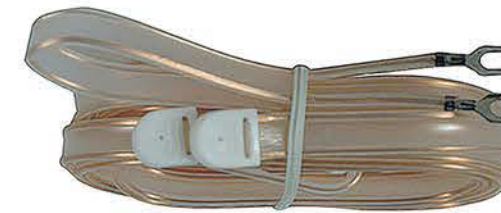
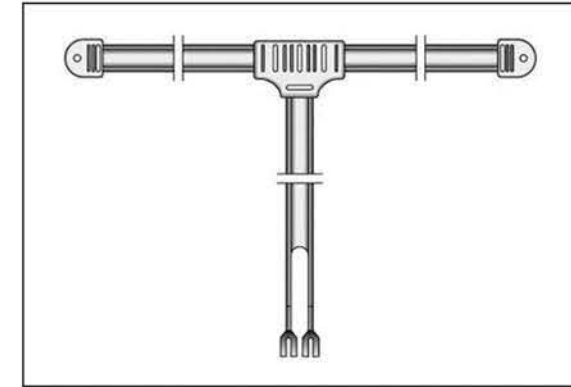

**F-21A (3 Section)**

• 11" Knocked Down and 30" Extended

**F-21B (4 Section)**

• 8" Knocked Down and 24" Extended

**F-21C (4 Section)**

• 11" Knocked Down and 37" Extended



**UWV-HD1300**

SUPER HIGH GAIN UHF/VHF TV ANTENNA

- VHF Channels 2-13
- UHF Channels 14-69
- Frequency Range: 174-603 MHz
- Range: 65 Miles
- Double Packed for UPS Shipping

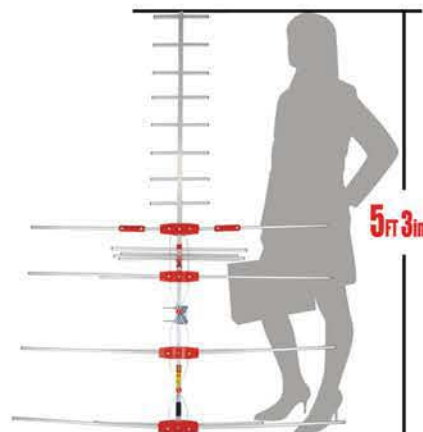

**65 MILE RANGE**

**TERRESTRIAL HDTV BROADCAST COMPATIBLE**

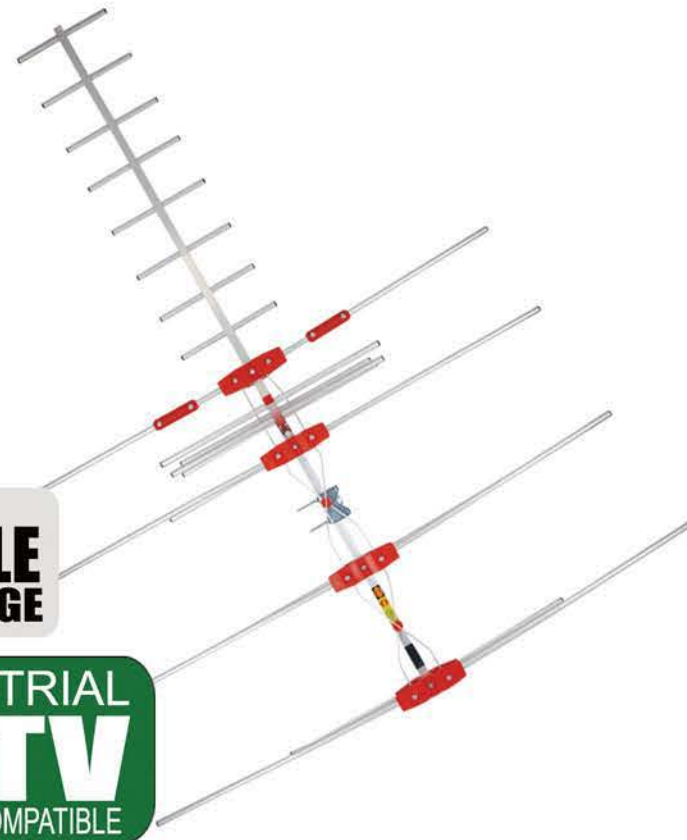

**W-6000**

VHF/UHF COLOR TV BOOSTER

- High Power: 135dB
- Dual Impedance: 75Ohm
- Dual Voltage Input: AC 110V/220V Switchable
- Power Consumption: 5.5 Watts Max.
- Outdoor Antenna Booster



**W-7000**

VHF/UHF COLOR TV ANTENNA BOOSTER

- High Power: 135dB
- Gain Control: 0-10dB Variable
- Dual Impedance: 75Ohm, F Connector
- Dual Voltage Input: AC 110V/220V Switchable
- Power Consumption: 5.5 Watts Max.
- Outdoor Antenna Booster

With F Type Inputs for a More Secure Connection!



**N-375**  
COAXIAL CABLE WALL PLATE WITH SINGLE CONNECTOR  
• 300-75 Ohm  
• Aluminum



**N-380**  
F TYPE "PUSH-ON" CONNECTOR  
• 300-75 Ohm



**N-1000 (Zinc)**  
**N-1000G (Gold)**  
SPLITTER  
• 2 Way  
• 5-1,000MHz 75 Ohm CATV Signal "F" Splitter  
• 750Hm Input, 75 Ohm UHF/VHF Output



**N-1001 (Zinc)**  
**N-1001G (Gold)**  
SPLITTER  
• Mini 2 Way  
• 5-1,000MHz 75 Ohm CATV Signal "F" Splitter  
• 750Hm Input, 75 Ohm UHF/VHF Output



**N-1003 (Zinc)**  
**N-1003G (Gold)**  
SPLITTER  
• 3 Way  
• 5-1,000MHz with Screws  
• 750Hm Input, 75 Ohm UHF/VHF Output

**N-919**  
OUTDOOR VHF/UHF TRANSFORMER  
• Weather Resistant with Rubber Boot & Spade Terminals



**N-919A**  
OUTDOOR VHF/UHF TRANSFORMER  
• Weather Resistant with Rubber Boot



**N-267**  
INTERIOR VHF/UHF TRANSFORMER  
• 75 Ohm Input  
• Twin Lead  
• 300 Ohm Output



**N-1004**  
SPLITTER  
• 4 Way  
• 0-1,000MHz  
• 750Hm Input, 75 Ohm UHF/VHF Output  
• Metal with Screws



**N-1005 (Zinc)**  
**N-1005G (Gold)**  
SPLITTER  
• 4 Way  
• 5-1,000MHz  
• With Screws  
• Gold



**N-1006 (Gold)**  
SPLITTER  
• 6 Way  
• 5-900MHz  
• With Screws  
• Gold

**NB-420**  
8 WAY SPLITTER  
• 5-1,000MHz  
• Zinc  
• Die Cast with Screws  
• 8 Way Splitter

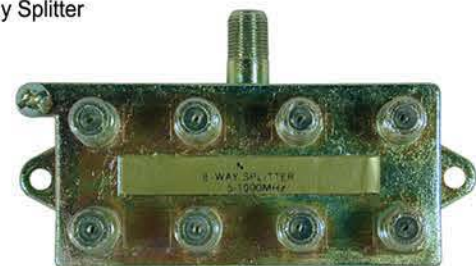

**FSP10-230**  
• F-Type Lighting Surge Protector Male to Female  
• Insertion Loss: MAX-4.5dB  
• Bandwidth from DC to 3 GHz  
• Connectors: F Male to F Female



**KL-812A**  
2-WAY SPLITTER  
• 5 - 2,400 MHz  
• Power Pass to all Ports  
• Silver



**KL-813A**  
3-WAY SPLITTER  
• 5 - 2,400 MHz  
• Power Pass to all Ports  
• Silver



**KL-814A**  
4-WAY SPLITTER  
• 5 - 2,400 MHz  
• Power Pass to all Ports  
• Silver



VIDEO ACCESSORIES



**F-56**  
TWIST-ON CONNECTOR  
• with Separated Ferrule for RG-6



**F-56AL**  
• Connector for RG-6 with Attached Ferrule



**F-56ALW**  
• Connector for RG-6 with Attached Ferrule  
• Wide Grip



**F-59**  
TWIST-ON CONNECTOR  
• with Separated Ferrule for RG-59



**F-59AL**  
• Connector for RG-59 with Attached Ferrule



**F-71**  
• All Channel Terminator (Min QT)



**F-71B**  
• Twist-on Male to Male "F" Universal Coupler



**NF-3**  
• Female to RCA Female to "F" Adapter



**NF-4**  
• Female to RCA Male to "F" Adapter



**NF-18**  
• Twist-on Angled Male to "F" to Female Adapter

**NF-35**  
• Male to RCA Female to "F" Adapter



**NF-56**      **NF-6G (Gold)**  
**NF-56G (Gold)**  
• Twist-on Connector for RG-6  
• Twist on Connector for RG-59



**NF-104**  
• Female to 35mm Male Adapter



SPLITTERS

**F-56CMP BLU (Blue)**  
**F-56CMP BLK (Black)**  
**F-56CMP RED (Red)**  
• F Type Compression Connector for RG-6 Cable

**F-59CMP BL (Blue)**  
**F-59CMP BK (Black)**  
**F-59CMP RD (Red)**  
**F-59CMP-GR (Green)**  
• F Type Compression Connector for RG-59 Cable

**FCP-56CMP**  
• F Compressor Connector Copper

**FLM-56CP**  
• Twist-On Self Locking Connector  
• X 50 Locking Mechanism



**F-56SO**  
• RG-6 Connector with Sealant and O-Ring



**F-56CP**  
• F Connector Copper



**F-11**  
• For RG-11U with Separate 1/5" Ferrule



**F-61**  
• Universal Chassis Connector with Nut & Washer



**F-81 / F-81G (Gold)**  
• Female Splice Connector with Nut & Washer  
• Available in Gold



**F-82**  
• 3 Way "F" Type Adapter  
• 2 Females & 1 Male



**F-83**  
• Female RCA Chassis Connector for Coaxial Cable with Teflon



**F-85**  
• 3 Way "F" Type Adapter  
• 3 Females



**F-87**  
• 4 Way "F" Type Adapter  
• 4 Females

**NF-81**  
**NF-81G (Gold)**  
• Female Splice Connector for Coaxial Cable



**PAL-911**  
• PAL Male to "F" Female





**WB-1**  
• Weather Boot



**F-62**  
• Female Chassis Mount  
• UHF Connectors



**NF-12**  
• Double Female Adapter  
• UHF



**NF-48**  
• Male  
• Crimp Type  
• For RG-58  
• UHF



**NF-72**  
• "F" Female to Male  
• UHF



**PL-258**  
• Coaxial Plug Reduced for  
RG-58  
• UHF



**PL-259**  
• Coaxial Plug  
• UHF



**PL-259D**  
• Deluxe Silver Plated Coaxial  
Plug with Heat Resistant  
Gold Tip & White Teflon Core



**NF-2**  
• Male to "F" Female  
• BNC Connectors



**NF-29**  
• 2 Piece Male crimp  
• For RG-5  
• BNC Connectors



**NF-32 (for RG-6)**  
• Twist-On Male  
• BNC Connectors



**NF-33**  
• Male Twist-On  
• For RG-58  
• BNC Connectors



**NF-34**  
• Twist-On Male  
• For RG-58  
• BNC Connectors



**NF-52**  
• Female to "F" Male  
• BNC Connectors



**NF-54**  
• 3 Piece Male Solder  
• For RG-58  
• BNC Connectors



**NF-56W**  
• Twist-On  
• For RG-6  
• F Connectors



**NF-58**  
• 3 Piece Male Crimp  
• For RG-58  
• BNC Connectors



**NF-59**  
• 3 Piece Male Crimp  
• For RG-59  
• BNC Connectors



**UG-175 (RG-58)**  
• Coaxial Adapter for PL-259



**NF-19**  
 • Double Female Adapter  
 • BNC Connectors

**NF-32CMP BK** (Black)  
**NF-32CMP BLU** (Blue)  
**NF-32CMP RD** (Red)  
 • Twist-On Male  
 • BNC Type Compression Connector for RG-6 Cable



**NF-33CMP BK** (Black)  
**NF-33CMP BLU** (Blue)  
**NF-33CMP RD** (Red)  
 • Twist-On Male  
 • F Type Compression Connector for RG-59 Cable



**NF-34CMP BL** (Blue)  
**NF-34CMP RD** (Red)  
 • Twist-On Male  
 • F Type Compression Connector for RG-58 Cable



**NF-53**  
 • Female to "F" Female  
 • BNC Connectors



**NF-75**  
 • Double male Adapter  
 • BNC Connectors



**NF-239F**  
**BNC TO SO ADAPTER**  
 Allows use of Antenna Cables with a PL-259 Connector to fit into Radios Requiring a BNC. Great for Radio Scanners, Handheld CB's & Amateur Equipment



**NF-259L**  
**PL-259 RIGHT ( L ) ANGLE ADAPTER**  
 Connect UHF Male to UHF Female, Compatible with all UHF Connectors. Commonly used in RF Applications, Antennas, Wireless LAN Devices , Coaxial Cable, Wi-Fi Radios External Antenna



**NF-1**  
 • Push-On Male to Female Adapter  
 • Push-On F male to F Female Adaptor



**NF-6** (Gold)  
 • Twist-On Connector for RG-59



**NF-7**  
 • Push-On Connector for RG-59



**NF-8**  
 • Male to RCA Female  
 • BNC Connectors



**NF-14**  
 • Male to Double Female "T" Connector  
 • BNC Connectors



**NF-16**  
 • Female to RCA Male  
 • BNC Connectors



**NF-65**  
**BNC TO UHF ADAPTER**



**NF-66**  
 • 3 Piece Male Crimp Plug for RG-6  
 • BNC Connectors



**NF-69**  
 • For RG-11U with Separate 1/5" Ferrule



**NF-73**  
 • 3 Female "T" Adapter  
 • BNC Connectors



**NF-74**  
 • 3 Male "T" Adapter  
 • BNC Connectors



**NF-78**  
 • Double Female Chasis Mount  
 • BNC Connectors



P-100T (Mono)  
P-102T (Stereo)  
• 1/4" Plug



P-101T  
P-101T-G (Gold)  
• 1/4" Mono Plug  
• Metal Body



P-101TRA  
1/4" RIGHT ANGLE PLUG  
For: Speaker Cable (12 Gauge & UP)  
Microphone Cable ( All )



J-236 (2.1 TO 5.5mm)  
• DC Power Jack



J-238 (2.5 TO 5.5mm)  
• DC Power Jack



P-193  
• 1/4" Female  
• Stereo



P-103T  
• 1/4" Stereo Plug  
• Metal Body



P-103T-G (Gold)  
• 1/4" Stereo Plug  
• Metal Body



P-104T (Mono)  
P-105T (Stereo)  
• 3.5mm Plug



P-195  
• 1/4" Female Stereo  
• Silver  
• Chassis Mount



P-229  
• Subminiature Plug to 1/4"  
Stereo Jack



PY-243MN  
• "Y" Adapter for RCA plug 1/4"  
• Mono



P-107TS  
• 3.5mm Stereo Gold Tip



P-107VTN  
• 3.5mm Video Plug



P-222L  
1/4" RIGHT ANGLE MONO PLUG  
ADAPTER TO RCA FEMALE  
• Nickel-Plated Metal Housing  
• Solder Type



PY-243ST  
• "Y" Adapter for RCA Plug 1/4"  
• Stereo



P-264  
• Metal 1/4" Coupler



P-265  
• Metal 3.5mm Coupler

PLUGS/JACKS



P-106M (Mono)  
P-106S (Stereo)  
P-106S-G (Stereo - Gold)  
• 3.5mm Stereo Plug



P-108  
• 1/4" Stereo Plug to 3.5mm Mono Jacks Left and Right



P-109 (Stereo to Mono)  
P-114 (Mono to Stereo)  
• 3.5mm Stereo Plug 1/4" Jack



P-110  
P-110G (Gold)  
• 3.5mm Stereo Plug 1/4" Jack



P-111 (Stereo)  
P-112 (Mono)  
• 1/4" Plug 3.5mm Jack



P-117 (3.5mm Mono)  
P-117S (3.5mm Stereo)  
P-118 (1/4" Mono)  
P-118S (1/4" Stereo)  
• In-Line Jack

P-180 BLU  
P-180 RED  
• Professional 1/4" Color Coded



P-181 BLK  
P-181 BLU  
P-181 RED  
• Professional 1/4" Color Coded  
• All Colors have Gold Tip



PLUGS/JACKS



P-217  
• 3.5mm Stereo to RCA Plug



P-218  
• 3.5mm Mono to RCA Plug



P-220  
• RCA Jack to Double RCA Jack



P-230 (Mono to Stereo)  
P-231 (Mono to Mono)  
• 3.5mm Plug to 1/4" Jack

P-234 (3.8 x 1mm)  
P-235 (3.45 x 1.3mm)  
P-236 (5.5 x 2.1mm)  
P-237 (5 x 5 x 2.1mm)  
P-238 (5 x 5 x 2.5mm)  
P-239 (5.5 x 2.9mm)  
P-240 (4.35 x 3.3mm)  
• DC Power Plug



P-246  
• 1/4" Stereo Plug to 3.5mm Stereo Double Jack



P-248 (Mono)  
P-249 (Stereo)  
• 1/4" Plug to Double 1/4" Jacks



P-250  
• 3.5mm Stereo Plug to 3.5mm Stereo Double Jack



P-251  
• 3.5mm Stereo Plug to 1/4" Stereo Double Jack

PLUGS/JACKS



**P-221**  
• RCA Plug to Double RCA Jack



**P-221G**  
• RCA Plug to Double RCA Jack  
• Gold Tips



**P-222**  
• 1/4" Mono Plug to RCA Jack



**P-222C**  
• 1/4" to RCA Jack Adaptor



**P-223**  
• 3.5mm Mono Plug to RCA Jack



**GM-101 (Mono)**  
• 1/4" Shielded Right Angle Plug



**P-227 (Mono)**  
**P-228 (Stereo)**  
3.5 mm FEMALE TO RCA MALE



**P-113**  
• RCA Female to Double RCA Male



**P-115 BLK**  
**P-115 RED**  
• RCA Plug



**P-116B**  
**P-116R**  
• RCA Jack



**P-119**  
• Molded Adapter  
• RCA Jack to RCA Jack



**P-119G**  
• Molded Adapter  
• RCA Jack to RCA Jack  
• Gold Ends

RCA



**P-120G**  
RCA Plug to RCA Plug  
• Gold & Black Finish



**P-125 BLK**  
RCA PLUG WITH TAIL  
• Black Color



**P-125 RED**  
MONO RCA PLUG WITH TAIL  
• Red Color



**P-126 BLK**  
**P-126 RED**  
• RCA Jack



**P-127**  
**P-127G (Gold)**  
• RCA Plug Metal Type



**P-192**  
• 2 RCA Jack to 2 RCA Jack



**P-242**  
• 3.5mm Stereo Plug to RCA Jack



**P-243 (Stereo)**  
**P-247 (Mono)**  
• 1/4" Plug to Double RCA Jack



**P-244**  
• 3.5mm Stereo Plug to RCA Double Jack



**P-119BL**  
• Molded Adapter  
• RCA Jack to RCA Jack



**P-275**  
2 RCA TO 2 RCA COUPLER WITH S VIDEO COUPLER  
• Plastic Handle



**P-276**  
3 RCA TO 3 RCA COUPLER  
• Plastic Handle

# VIDEO & AUDIO

## RCA/DIN



**P-245**  
• 3.5mm Mono Plug to Double RCA Jack



**P-253**  
• RCA Plug to 3.5mm Mono Double Jack



**P-255**  
• RCA Jack to 1/4" Mono Double Jack



**Q-119**  
• Jack to Jack  
• RCA Coupler  
• Gold



**Q-120**  
• Plug to Plug  
• RCA Coupler  
• Gold



**Q-121**  
• Right Angle Plug to Jack  
• RCA Coupler  
• Gold



**DIN-P5**  
• 5 Pin Plug



**DIN-J6**  
• 6 Pin Jack



**ZP-RCA-PG**  
GOLD-PLATED RCA PLUG  
• Set of Two



**DIN-P8**  
• 8 Pin Plug

# VIDEO & AUDIO

## ACCESSORIES



**LP-M**  
• Mono  
• L Pads  
• 8 Ohms



**CC-5** (for RG-59)  
**CC-6 BLK** (for RG-6)  
• Nylon Clip



**TG-300R-1235G**  
• DVD Motor  
• CW  
• ≤ 105 mA  
• 2900 ± 105 rpm



**NB-317** (Mono)  
• 1/4" Jack  
• (2P~8P)  
• 1/4" Phone Jack



**NB-403**  
• 1/4" Mono Jack  
• Open Circuit



**NB-404**  
• 1/4" Mono Jack  
• Closed Circuit



**NB-405**  
• 1/4" Stereo Jack  
• Closed Circuit



**NB-406**  
• 1/4" Stereo Jack  
• Open Circuit



**NB-407**  
• 1/4" Jack, 3 Conductor  
• Closed Circuit



**NB-408**  
• 1/4" Jack, 3 Conductor  
• Open Circuit



**NB-411BLK** (Gold)  
**NB-411RED** (Gold)  
• RCA Chassis Mount

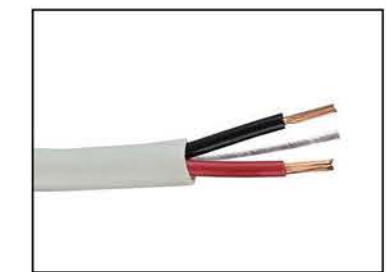

**CPW-100M**  
• Power Cable  
• 328 Ft (100m)  
• 14/16 Gauge

ACCESSORIES

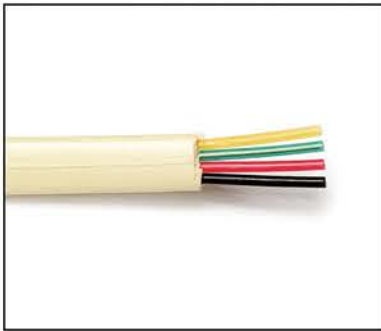

**KR-220 (Ivory)**  
FLAT TELEPHONE CABLE  
• 4 Conductors  
• Flat Type  
• Color Coded  
• 20 GA  
• 1000' Spool



**KR-502**  
TELEPHONE CABLE  
• 2 Pairs  
• Round Type  
• Color Coded  
• 1000'

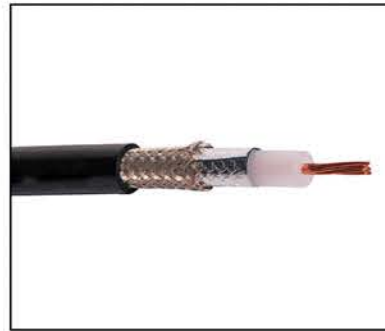

**RG-6DK**  
USA Standard Coaxial Cable  
• 1000 Feet  
• White  
• Aluminum Braid and Foil

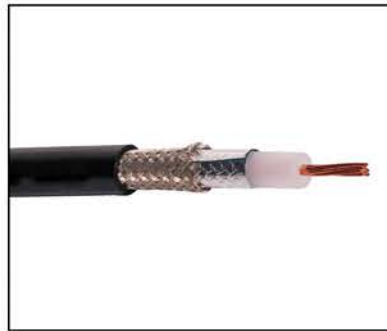

**RG-6 BLK**  
**RG-6 WHT**  
• Coaxial Cable 1000'

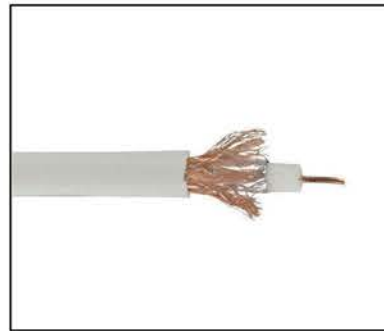

**RG-58 (Copper Braid)**  
**RG-59 BLK**  
**RG-59 WHT**  
• Coaxial Cable 1000'



**RG-59AL-BLK**  
**RG-59AL-WHT**  
• Coaxial Cable 1000'  
• Aluminium Braid



**CABLE 12CL2-500**  
IN-WALL SPEAKER CABLE  
• 2 x 12 AWG  
• Copper Clad Aluminum Conductors  
• White PVC  
• CL2 Rated for In-Wall Installation  
• Length: 500'



**CABLE 14CL2-500**  
IN-WALL SPEAKER CABLE  
• 2 x 14 AWG  
• Copper Clad Aluminum Conductors  
• White PVC  
• CL2 Rated for In-Wall Installation  
• Length: 500'



**CABLE 16CL2-500**  
IN-WALL SPEAKER CABLE  
• 2 x 16 AWG  
• Copper Clad Aluminum Conductors  
• White PVC  
• CL2 Rated for In-Wall Installation  
• Length: 500'

• Connect your Speakers to your A/V Receiver or Amplifier with this 2-Conductor Speaker Wire  
• Pair with Banana Plugs, Spade Tips, or Bent Pin Connectors for Professional Custom Installations  
• Tough, yet Flexible White Insulated Jacket is Color Coded for Polarity  
• Rated CL2 for In-Wall Use

SPEAKER CABLES

CABLE#10	Clear 25'	10 Gauge Clear
CABLE#10	Clear 50'	10 Gauge Clear
CABLE#10	Clear 100'	10 Gauge Clear
CABLE#10	Black 100'	10 Gauge Black
CABLE#10	Black 300'	10 Gauge Black
CABLE#10	Clear 300'	10 Gauge Clear
CABLE#12	Black 500'	12 Gauge Clear
CABLE#12	Clear 500'	12 Gauge Clear
CABLE#12	Clear 25'	12 Gauge Clear
CABLE#12	Clear 50'	12 Gauge Clear
CABLE#12	Clear 100'	12 Gauge Clear
CABLE#12	Black 100'	12 Gauge Black
CABLE#14	Clear 25'	14 Gauge Clear
CABLE#14	Clear 50'	14 Gauge Clear
CABLE#14	Clear 100'	14 Gauge Clear
CABLE#14	Clear 500'	14 Gauge Clear
CABLE#14	Black 500'	14 Gauge Black
CABLE#16	Clear 50'	16 Gauge Clear
CABLE#16	Clear 100'	16 Gauge Clear
CABLE#16	Clear 1000'	16 Gauge Clear
CABLE#16	Black 1000'	16 Gauge Black
CABLE#18	Clear 25'	18 Gauge Clear
CABLE#18	Clear 50'	18 Gauge Clear
CABLE#18	Clear 100'	18 Gauge Clear
CABLE#18	Clear 1000'	18 Gauge Clear
CABLE#18	Black 1000'	18 Gauge Black and Red
CABLE#20	Clear 1000'	20 Gauge Clear
CABLE#20	Black 1000'	20 Gauge Black and Red
CABLE#22	Clear 1000'	22 Gauge Clear
CABLE#22	Black 1000'	22 Gauge Black and Red



**N-320**  
FLAT TWIN LEAD FOAM CABLE  
• 300 Ohm  
• 1000'



**CABLE-14-100CPR**  
SPEAKER CABLE  
• 14 Gauge  
• 100 Ft. (30.5 Meters)  
• 100% Copper



**CABLE-16-100CPR**  
SPEAKER CABLE  
• 16 Gauge  
• 100 Ft. (30.5 Meters)  
• 100% Copper





**SPEAKER CABLES**

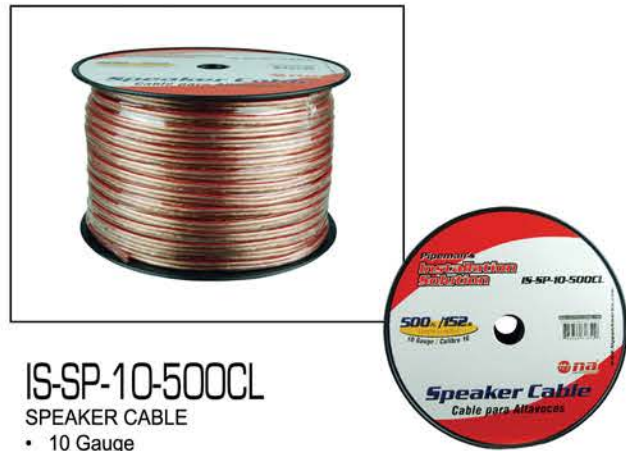

**IS-SP-10-500CL**  
SPEAKER CABLE  
• 10 Gauge  
• 500 Ft.



**IS-SP-12-500CL**  
SPEAKER CABLE  
• 12 Gauge  
• 500 Ft.



**IS-SP-14-1000CL**  
SPEAKER CABLE  
• 14 Gauge  
• 1000 Ft.



**IS-SP-16-1000CL**  
SPEAKER CABLE  
• 16 Gauge  
• 1000 Ft.



**IS-SP-18-1000CL**  
SPEAKER CABLE  
• 18 Gauge  
• 1000 Ft.



**CPW-RVW-152-300**  
RVV CABLE  
• 2 x 14 AWG  
• Copper Clad Aluminum Conductors  
• Black PVC  
• Rated Voltage 300/500V  
• Length: 300'

**SPEAKER CABLES**



**IS-SP-14-1000BR**  
SPEAKER CABLE  
• 14 Gauge  
• 1000 Ft.  
• 305 M.



**IS-SP-16-1000BR**  
SPEAKER CABLE  
• 16 Gauge  
• 1000 Ft.  
• 305 M.



**IS-SP-18-1000BR**  
SPEAKER CABLE  
• 18 Gauge  
• 1000 Ft.  
• 305 M.



**IS-SP-20-1000BR**  
SPEAKER CABLE  
• 20 Gauge  
• 1000 Ft.  
• 305 M.



**CAOD-16-500DB-UV**  
OUTDOOR UV DIRECT BURIAL  
SPEAKER WIRE  
• 16 Gauge  
• 500 Ft.  
• 152.4 M.

THE WHITE JACKET IS THE HARD PLASTIC WHICH ALLOWS THIS CABLE TO BE BURIED AND PROTECTED.

**OUTDOOR**



**CAOD-16-502DB-UV**  
OUTDOOR UV DIRECT BURIAL  
SPEAKER WIRE  
• 16 Gauge  
• 500 Ft.  
• 152.4 M.

THE WHITE JACKET IS THE HARD PLASTIC WHICH ALLOWS THIS CABLE TO BE BURIED AND PROTECTED.

**OUTDOOR**

# VIDEO & AUDIO

## SPEAKER CABLES

N-214-6GB  
N-214-12GB  
N-214-25GB  
N-214-50GB  
N-214-75GB  
N-214-100GB

- RG-6
- Black
- Gold Tips
- Twist-On Connector Ends



N-214-6GW  
N-214-12GW  
N-214-25GW  
N-214-50GW  
N-214-75GW  
N-214-100GW

- RG-6
- White
- Gold Tips
- Twist-On Connector Ends



# VIDEO & AUDIO

## VIDEO CABLES



N-214-6B  
N-214-12B  
F TO F CONNECTORS  
• Available in 3', 6', 12' & in Black or White



N-215  
RCA TO RCA CONNECTORS  
• 6'  
• Black

N-223-3GB  
N-223-6GB

- RG-6
- Black
- Gold Tips
- Push-On Connector Ends



N-223-3GW  
N-223-6GW  
N-223-25GW  
N-223-50GW  
N-223-100GW

- RG-6
- White
- Gold Tips
- Push-On Connector Ends



N-215G  
RCA TO RCA CONNECTORS  
• 6'  
• Black  
• Gold Tips



N-217  
BNC TO BNC CONNECTORS  
• 6'  
• Black

RCA-500

- Audio Cable
- Mono
- 500 Ft.



RCA-503

- Video & Audio Cable
- Stereo
- 500 Ft.



N-223-3B  
N-223-6B  
F TO F QUICK CONNECTORS  
• Available in 3' or 6' in White & 3', 6' or 12' in Black



NS-81  
S-VIDEO ADAPTOR  
• Coupler



VIDEO CABLES

**V-075-6**

3 RCA TO 3 RCA CABLE

- 6' Nickel-Plated RCA Connectors
- Audio/Video
- Stereo
- Fully Molded
- Low-Loss
- Shielded



**V-175**

6' NICKEL PLATED RCA CONNECTORS

- Audio/Video
- Stereo
- Fully Molded
- Low-Loss
- Shielded
- Color Coded



**V-275-3 (3")**

**V-275-6 (6")**

**V-275-12 (12")**

**V-275-25 (25")**

**V-275-50 (50")**

**V-277 (12")**

AUDIO/VIDEO STEREO

- RG-6 Video Cable
- Gold-Plated RCA Connectors
- Fully Molded
- Low-Loss
- Shielded
- Color Coded



**V-250**

AUDIO/VIDEO MONO

- Fully Molded
- Low-Loss
- Shielded
- Color Coded
- Gold-Plated RCA Connectors
- 6'



**V-35-275F**

AUDIO/VIDEO CABLE

- 6"



**IS-35V35V**

3.5MM AUDIO/VIDEO CABLE

- Features Dual Color-Coded 3.5mm Silver Connectors



CABLES



**HD-315-6 (6")**

**HD-315-12 (12")**

- Component Cable
- VGA to RGB Component Cable

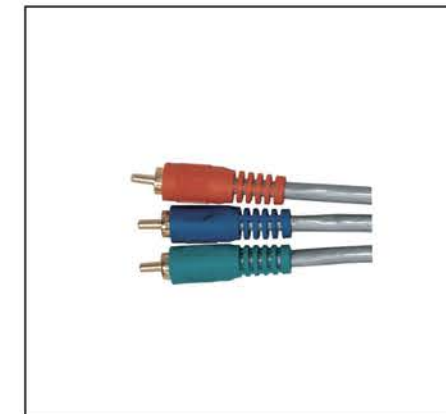

**V-306 (6")**

**V-312 (12")**

- Video Only
- RGB Component Video Cable
- Connect DVD to High-End TV
- Provide the Best Picture Transfer Available



**SV-6G**

- High-Grade SVideo Cable
- 6'
- Gold Tips



**OFC-3 (3")**

**OFC-6 (6")**

**OFC-12 (12")**

**OFC-25 (25")**

OPTICAL FIBER CABLE



VIDEO CABLES



**N-202**  
DIN CABLE  
• 5 Pin DIN to 5 Pin DIN  
• 6'

- N-203-3
- N-203-6
- N-203-12
- N-203-25
- N-203-50

- Stereo
- 2 RCA Plugs to 2 RCA Plugs
- Color Coded
- With Gold Connectors



**N-203-4**  
• Stereo  
• 4 RCA to 4 RCA Color Coded  
• 6'

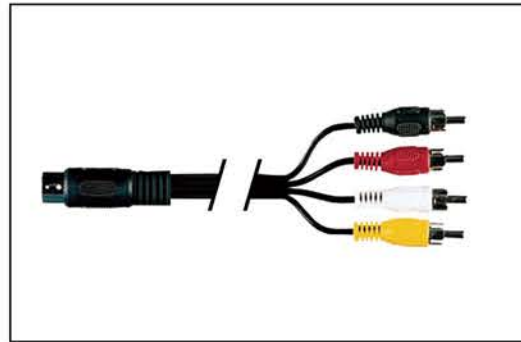

**N-206P**  
• 5 Pin DIN to 4 RCA Plugs  
• Shielded  
• 6'



**N-207J**  
• 1/4" Mono Plug to 2 RCA Jacks



**N-207P**  
• 1/4" Mono Plug to 2 RCA Jacks



**N-208**  
• 1/4" Mono Plug to 2 RCA Jacks

CABLES

**N-209**  
• 1/4" to 1 RCA Plug & 1 RCA Jack



**N-211J (Stereo)**  
**N-212J (Mono)**  
• 3.5mm to 2 RCA Jacks



**N-213 (6" Inches)**  
• 3.5mm to RCA Plugs



**N-216-3 (3' Feet)**  
**N-216-6 (6' Feet)**  
**N-216G (6' Feet)**  
**N-216-3G (3' Feet)**  
• Stereo  
• 3.5mm Plug to 3.5mm Plug  
• 6'



**N-221 (6" Inches)**  
**N-221-6 (6' Feet)**  
• Stereo  
• 3.5mm Plug to 2 3.5mm Jacks



**N-311P-5**  
• 3.5mm Stereo/ Video Plug to 3 RCA Cable



**N-199S (Stereo)**  
• Headphone Extension  
• 3.5mm  
• 20'



**N-D103TV**  
10 PIN DIN PLUG TO RCA 4 WAY PLUG  
• Connection Type Features: 3-Male to 10-Pin RCA Composite Audio-Video Cable  
• Perfect Audio Video Cable that Eliminates Unwanted Noise/Feedback for Pure, Clear Audio-Video; Minimal Signal Loss for Reliably Consistent Video  
• Cable Length: 5 Feet (1.3 Meters)



CABLES

P.A. EQUIPMENT



**N-211P** (6" Inches)  
**N-211P-6** (6' Feet)  
**N-211P-6G** (6' Feet gold)  
**N-211P-12G** (12' Feet Gold)  
 • 3.5mm to 2 RCA Plugs

**N-218**

• RCA Plug to 2 RCA Plugs



**N-234-6** (6")  
**N-234-12** (12")

• Black  
 • 3.5mm to 1/4"



**N-219** (6" Inches)  
**N-219-6** (6' Feet)  
**N-219G** (6" Inches Gold)  
 • RCA Plug to 2 RCA Jacks



**IS-SERIES**  
 OXYGEN FREE RCA CABLE

**IS-3** (3 Feet)  
**IS-6** (6 Feet)  
**IS-17** (17 Feet)  
**IS-Y-M-2F** (1 Feet)



**N-350S-6**  
 • 3.5 ST Plug to 3.5 ST Jack  
 • 6'

**N-350S-6G**  
 • 3.5 ST Plug to 3.5 ST Jack  
 • Gold  
 • 6'

**N-350S-12**  
 • 3.5 ST Plug to 3.5 ST Jack  
 • 12'



**PA-10ZC**

P.A. EQUIPMENT ZONE CONTROLLER

- Power Source: 110V/60Hz
- 10 Partitions Controller
- Power Off Memory for Each Partition
- Dual Input/Output available for Each Partition
- High Power Device with 10A available for Each Partition
- Dimension: 19" x 13.7" x 3.5" (480x350x90mm)
- Net Weight: 14.9 Lbs (6.75 Kg)



**PA-1000BT**

P.A. AMPLIFIER WITH BLUETOOTH

- Power Source: 110V/60Hz
- Power Consumption: 960W
- RMS Power: 480W
- Max. Power: 720W
- Frequency Response: 100Hz-16KHz+3dB
- THD: <0.1%@1KHz, 1/3 Rated Output Power
- Output: 8Ω, 70V, 110V
- Aux Output: 600Ω 1V (0dBV)
- Input: Mic: 1,2,3: 600Ω, 6mV (-55dBV) Aux: 1,2: 10KΩ, 250mV (-17dBV)
- S/N Ratio: Mic: 1,2,3: >66dB Aux: 1,2: >70dB
- Tone Control: Bass: ±10dB @ 100Hz Treble: ±10dB @ 10KHz
- Protection: AC Fuse, DC Voltage, Overload and Short Circuit
- Muting Function: 0~-30dB
- Includes an MP3, USB and SD Card
- Dimension: 17" x 15" x 3.5" (430x388x88mm)
- Net Weight: 37.3Lbs (16.9KG)



**PA-500BT**

P.A. AMPLIFIER WITH BLUETOOTH

- Power Source: 110V/60Hz
- Power Consumption: 480W
- RMS Power: 240W
- Max. Power: 360W
- Frequency Response: 100Hz-16KHz+3dB
- THD: <0.1%@1KHz, 1/3 Rated Output Power
- Output: 8Ω, 70V, 110V
- Aux Output: 600Ω 1V (0dBV)
- Input: Mic: 1,2,3: 600Ω, 6mV (-55dBV) Aux: 1,2: 10KΩ, 250mV (-17dBV)
- S/N Ratio: Mic: 1,2,3: >66dB Aux: 1,2: >70dB
- Tone Control: Bass: ±10dB @ 100Hz Treble: ±10dB @ 10KHz
- Protection: AC Fuse, DC Voltage, Overload and Short Circuit
- Muting Function: 0~-30dB
- Includes an MP3, USB and SD Card
- Dimension: 17" x 10" x 3.5" (430x260x88mm)
- Net Weight: 325.7Lbs (11.68KG)



**PA-6-2600UBT**

6 ZONE PA AMPLIFIER WITH USB AND BT

- With Built-In USB / Bluetooth / Tuner/ TF Card
- With 3 MIC Inputs, 2 AUX Inputs and 1 Line Output
- 100V, 70V and 4-16 Ohms Transformer Isolated Speaker Outputs
- Independent Gain Control for Each Zone
- Separate BASS and TREBLE Control
- Power Requirement: 110-220V AC, 50/60 Hz
- Power and Level Indicators
- Gain Control and Power Switch



CABLES



**KR-205-15 / KR-205-25**  
 MODULAR SINGLE JACK  
 • Extension Cord  
 • Ivory Color  
 • Available in 15 Ft and 25 Ft.



**KR-206**  
 MODULAR DOUBLE JACK  
 • 25 Ft. Extension Cord  
 • Ivory Color



**KR-209-7-BLK**  
**KR-209-7-IVR**  
**KR-209-15-BLK**

**KR-209-15-IVR**  
**KR-209-15-WHT**  
**KR-209-25-BLK**  
**KR-209-25-IVR**  
**KR-209-25-WHT**  
 MODULAR HANDSET  
 • Coiled Cord Made of Elastic Tinsel Material  
 • Available in 7', 15' & 25' in Black, Ivory & White

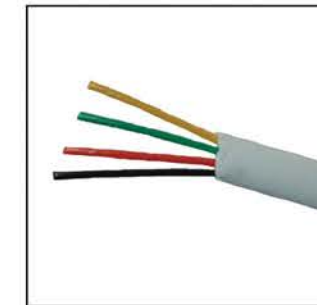

**KR-220**  
 FLAT TELEPHONE CABLE  
 • 4 Conductors, Flat Type  
 • Color Coded  
 • 20 Gauge  
 • 1000' Spool

**KR-425-7**  
**KR-425-15**  
**KR-425-25**  
**KR-425-25-BLK**  
**KR-425-25-WHT**  
**KR-425-50**  
**KR-425-100**

MODULAR STRAIGHT LINE CORD  
 • Four Pin Plug to Four Pin Plug  
 • Available in 9", 7', 15', 50' & 100'

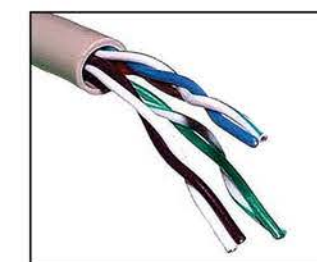

**KR-502**  
 ROUND TELEPHONE CABLE  
 • 1000 Ft. Roll  
 • 2 Pairs  
 • Solid Core

# TELEPHONE ACCESSORIES

**KR-127**  
 MODULAR JACK ASSEMBLY  
 • 5 Outlet  
 • Plastic Casing  
 • White Color



**KR-468**  
 MODULAR SURFACE JACK  
 • 4 Pin Modular Surface Jack with Screws  
 • Stick-On Pad, Dual Jack  
 • Ivory Color



**KR-200**  
 MODULAR IN-LINE COUPLER  
 • Plastic Casing  
 • Ivory Color  
 • Single Jack



**KR-201**  
 TRIPLEX ADAPTER  
 • Plastic Casing  
 • Ivory Color  
 • 2 Jacks



**KR-202**  
 MODULAR DOUBLE ADAPTER  
 • Plastic Casing  
 • Ivory Color  
 • 2 Jacks

**KR-468D**  
 DOUBLE MODULAR SURFACE JACK  
 • 4 Pin Modular Surface Jack with Screws  
 • Stick-on Pad, Dual Jack  
 • Ivory Color



**KR-468M**  
 MINI MODULAR SURFACE JACK  
 • Mini Modular Surface Jack  
 • Ivory Color



**KR-175**  
 TELEPHONES/VIDEO OUTPUT JACK  
 • Ivory Color  
 • Plastic Casing



**KR-216 (IVORY)**  
**KR-216W**  
 TELEPHONE SINGLE WALL JACK PLATE  
 • Flush Mount  
 • Available in Ivory and White Color



**KR-217**  
 DUAL WALL JACK PLATE  
 • Flush Mount  
 • Available in Ivory & White



**KR-203**  
 MODULAR TRIPLE ADAPTER  
 • 2 Line T-Junction  
 • 3 Jacks  
 • 1 Plug  
 • Ivory Color

**DSL-F200**  
 DSL SPLITTER  
 The In-Line Adapter Connects between the Wall Jack and Voice Device (e.g. Phone, Fax, Answering Machine, Caller ID) Providing both an Unfiltered DSL Jack for DSL Connection and a Filtered Jack for a Single Line of Voice Device Communications. Eliminates all Erratic Impedance from Telephone Equipment that Interfere with DSL Communications.

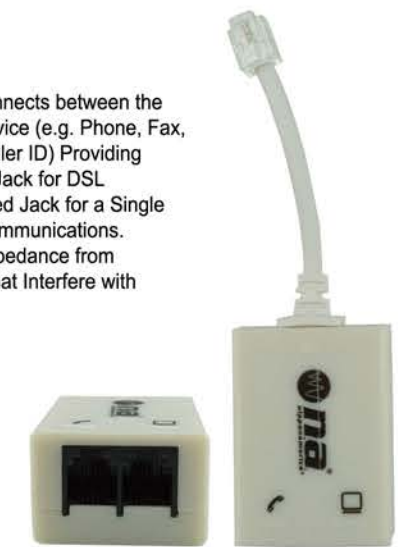

**KR-783**  
 FLASHER/RINGER  
 • Plastic Casing  
 • Ivory Color



**GTS-524**  
 INTERCOM SYSTEM (PAIR)  
 • 110V  
 • Plastic Casing



**KR-204L**  
 MODULAR OUTLET PLUG FOR HANDSET / 4 - PIN  
 • 1000 x Pack

**KR-208L**  
 MODULAR OUTLET PLUG FOR HANDSET / 2 - PIN  
 • 100 x Pack



**KR-128**  
 HANDSET UNTANGLER ADAPTER  
 • Prevents Tangled Cords  
 • Does not Affect Sound Quality  
 • Automatically Rotates to Eliminate Twisted Telephone Cords

SPLITTERS



**N-1000G**  
 2-WAY "F" SPLITTER  
 WITH SCREWS  
 • Bandwidth: 5-900MHz  
 • Impedance: 75 Ohms  
 • CATV Signal  
 • Gold  
 • Connects Two TVs from One Antenna



**N-1001G**  
 MINI 2-WAY "F" SPLITTER  
 WITH SCREWS  
 • Bandwidth: 5-900MHz  
 • Impedance: 75 Ohms  
 • CATV Signal  
 • Gold  
 • Connect Two TVs from One Antenna



**N-1003G**  
 3-WAY "F" SPLITTER  
 WITH SCREWS  
 • Bandwidth: 5-900MHz  
 • Impedance: 75 Ohms  
 • CATV Signal  
 • Gold



**N-1005G**  
 4-WAY "F" SPLITTER  
 WITH SCREWS  
 • Bandwidth: 5-900MHz  
 • Impedance: 75 Ohms  
 • CATV Signal  
 • Gold



**F-81G**  
 FEMALE SPLICE CONNECTOR  
 FOR COAXIAL CABLE WITH NUT  
 AND WASHER  
 • Set of Two  
 • Gold



**NF-81G**  
 FEMALE SPLICE CONNECTOR FOR  
 COAXIAL CABLE  
 • Set of Two  
 • Gold



GOLD SERIES





**NF-6G**  
TWIST-ON CONNECTORS FOR  
RG-59 CABLE  
• Set of Two  
• Gold



**NF-56G**  
TWIST-ON CONNECTORS FOR  
RG-6 CABLE  
• Set of Two  
• Gold



**P-101T-G**  
1/4" MONO PLUG WITH TAIL  
• Metal Body  
• Gold



**P-103T-G**  
1/4" STEREO PLUG WITH TAIL  
• Metal Body  
• Gold



**P-106S-G**  
3.5MM STEREO PLUG  
• Set of Two  
• Gold



**P-110G**  
3.5MM STEREO PLUG TO 1/4" JACK  
• Set of Two  
• Gold



**P-119G**  
MOLDED ADAPTER  
• RCA Jack to RCA Jack  
• Set of Two  
• Gold



**P-119BL**  
MOLDED ADAPTER  
• RCA Jack to RCA Jack  
• Set of Two  
• Gold



**P-120G**  
RCA MALE TO RCA MALE  
• Set of Two  
• Gold



**P-121BL**  
RCA GOLD RIGHT  
ANGLE RCA JACK  
• Set of Two  
• Gold



**P-127G**  
RCA PLUG  
• Set of Two  
• Metal Body  
• Gold



**P-219G**  
3.5MM STEREO COUPLER  
• Set of Two  
• Gold



**P-221G**  
RCA PLUG TO DOUBLE JACK  
• Gold Connectors

**P-311SG**  
3.5MM TO 1/4" STEREO GOLD PLUG  
• Sold by Pairs





**SV-6G (6') / SV-12G (12')**  
HIGH GRADE S VIDEO CABLE  
• Gold-Plated Connectors



**V-306 (6') / V-312 (12')**  
RGB COMPONENT VIDEO CABLE  
• Connect DVD Player to High-End TV  
• Provides the Best Picture Transfer Available  
• Gold-Plated RCA Connectors



AUDIO/VIDEO STEREO CABLES  
• Fully Molded  
• Low-Loss Signal  
• Shielded Color Coded Wires  
• Gold-Plated RCA Connectors

**V-275-3 (3')**  
**V-275-6 (6')**  
**V-275-12 (12')**  
**V-275-25 (25')**  
**V-275-50 (50')**



**V-250**  
AUDIO/VIDEO MONO CABLE  
• Fully Molded  
• Low-Loss Signal  
• Shielded Color Coded Wires  
• Gold-Plated RCA Connectors  
• 6'



**V-506 (6') / V-524 (24')**  
RCA COMPONENT VIDEO/STEREO CABLE  
• Connect DVD Player to High-End TV  
• Provides the Best Picture Transfer Available  
• Gold-Plated RCA Connectors



**BL-KOD-1002**  
DIGITAL 2-WAY SPLITTER

- 5-2,300MHz
- Power Pass to All Ports
- Splits One Digital Coaxial Cable Signal into Two

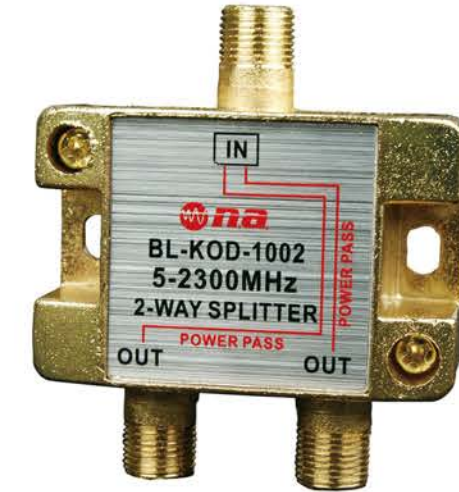

**Outdoor Use**

**BL-KOD-1003**  
DIGITAL 3-WAY SPLITTER

- 5-2,300MHz Bandwidth
- Power Pass to All Ports
- Silver



**Outdoor Use**



**N-203-3G / N-203-6G**  
**N-203-12G / N-203-25G**  
 STEREO CABLE  
 • 2 RCA to 2 RCA  
 • Color Coded Wires  
 • Available in 3', 6', 12', 25'  
 • Gold Tips



**N-216-3G (3')**  
 3.5MM TO 3.5MM  
 STEREO AUDIO CABLE  
 • Gold Tips



**N-216G (6')**  
 3.5MM TO 3.5MM  
 STEREO AUDIO CABLE  
 • Gold Tips



**N-219G**  
 RCA STEREO PLUG TO  
 2 RCA STEREO JACKS  
 • Gold Tips



**N-350S-6G**  
 3.5MM STEREO PLUG TO  
 3.5MM STEREO JACK  
 • 6'  
 • Gold Tips



**N-211P-6G (6 IN.)**  
**N-211P-12G (12 IN.)**  
 STEREO PLUG  
 • 3.5mm Stereo Plug to 2 RCA Plugs  
 • Gold Tips



**N-215G**  
 RCA TO RCA CONNECTORS  
 • 6'  
 • Gold Tips



**N-213G**  
 3.5MM JACK TO 2 RCA PLUGS  
 • Gold Tips



VIDEO CABLES



N-214-6GB  
 N-214-25GB  
 N-214-50GB  
 N-214-75GB  
 N-214-100GB

- VIDEO CABLE
- RG-6 Coaxial Cable
  - Black
  - Gold Tips
  - Screw-On Connectors



N-214-6GW  
 N-214-25GW  
 N-214-50GW  
 N-214-75GW  
 N-214-100GW

- VIDEO CABLE
- RG-6 Coaxial Cable
  - White
  - Gold Tips
  - Screw-On Connectors



N-223-3GB  
 N-223-6GB

- VIDEO CABLE
- RG-6 Coaxial Cable
  - Black
  - Gold Tips
  - Push-On Connectors



N-223-3GW  
 N-223-6GW  
 N-223-25GW

- VIDEO CABLE
- RG-6 Coaxial Cable
  - White
  - Gold Tips
  - Push-On Connectors



**ISTUFF**



**IMULTI-CHARGE**

3 IN 1 USB HYBRID CHARGER  
TRAVEL CHARGER

- Input AC: 110V ~ 240V (50/60Hz)
  - Output DV: 5.0V ~ 5.5V 800mA
- CAR CHARGER
- Input DC: 12V ~ 24V
  - Output DC: 5.0V ~ 5.5V 800mA



**IPOWER-SAM-FC**

FAST CHARGING USB WALL CHARGER

- New OEM Fast Adaptive Wall Charger
- Input 100-240VAC
- Output 5V / 2A; 9V / 1.67A
- Adaptive Fast Charging Powers your Phone at High Speed!!!



**IW-05**

3.5mm ADAPTOR TO RCA CABLE

- 3.5mm Female Plug to Dual RCA Plugs
- Silver-Plated Plug
- Blister Card Packing



**IWS-SAM-RS**

REVERSIBLE USB 2.0A MALE  
TO MICRO USB CABLE

- High Speed USB 2.0
- Compatible with Smart Phone
- Charging and Data Transmission
- Nickel-Plated Connectors
- Both Connectors are Reversible



**IP-35-6**

3.5 STEREO RCA CABLE 6'

- Perfect for Outdoor Usage
- Perfect for Marine and all Terrain Vehicles



**IPLUG**

3.5MM EARBUD SPLITTER

- Music Always Sounds Better when you have Someone to Share it with. IPLUG makes Sharing Simple, Anytime and Anyplace

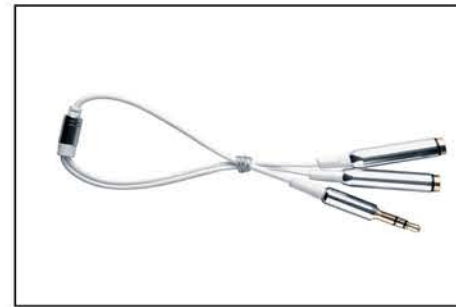

**IPLUG-TH**

3.5MM MALE JACK PLUG TO DUAL 3.5MM  
FEMALE PLUG

- Audio Cable USB to Computers, Laptops, Headphones, Smart Phones and MP3 Players
- Gold-Plated
- 7.8" / 0.2m



**BL-IP-35-USB6**

3.5MM AUDIO/VIDEO STEREO PLUG TO  
USB CABLE

- 6 Ft.
- White Color



**IC-100**

CASSETTE ADAPTER

- for CD Player, MP3 Player and Mini Disc
- Usage: This Product Enables any Portable CD, MP3 Player(s) with a Headphone Jack Built-In, to be Heard through the Speakers of any Cassette Playback System. This Includes Automobile or Portable Cassette Players



**ICABLE-020**

3.5MM PLUG TO 3.5MM PLUG  
with Small Heads  
1 Meter Long  
All White



**IW-04**

iPod Retractable 3.5mm Connection Cable

- 3.5mm DC to DC Stereo Cable Connects Media Device to Stereo Input
- Retractable Wire, Easy to Use
- Blister Card Packing



**N-3514-6**

3.5MM PLUG TO 1/4" PLUG CABLE  
• 6'



**N-3535-06**

ADAPTER 3.5MM PLUG  
TO 3.5MM PLUG  
• 6'



**IW-35D35**  
 EARPHONE SPLITTER  
 • 3.5mm Stereo Plug to Two 3.5mm Jacks



**IW-35D35-6**  
 3.5MM EARPHONE SPLITTER  
 • 6' Cable



**IWS-02MIB**  
 MINI USB TO USB CABLE  
 • High Speed USB 2.0  
 • Compatible with Mobile Phone, MP3, MP4 & Camera  
 • Charging and Data Transmission  
 • 3.3' / 1m



**IWS-02MOB**  
 MICRO USB TO USB CABLE  
 • High Speed USB 2.0  
 • Compatible with Android Smart Phones  
 • Charging and Data Transmission  
 • 3.3' / 1m



**IWS-20SMT**  
 CHARGING CABLE FOR SAMSUNG TABLET  
 • High Speed USB 2.0  
 • Compatible with Samsung Tablet PC  
 • Charging and Data Transmission  
 • 3.3' / 1m



**IWS-03UTC**  
 USB 3.0 A MALE TO USB TYPE-C™ MALE CABLE  
 (Compatible with MacBook Air and other USB Type-C™ Compatible Devices)  
 • Connects USB Type-C™ Device to a USB-A Port on a USB-A Device, such as USB Charger or Computer  
 • Power Output up to 3A  
 • Data Transfer up to 5Gbps



**BL-HD-MIMAD**  
 MHL TO HDMI ADAPTOR  
 • Connect your MHL-Enabled Phone to your High Definition TV or Computer Monitor  
 • Requires Standard HDMI Cable and Micro USB Charging Cable  
 • Simply Add Plug between MHL Adapter and your Device as Shown  
 • 5-Pin to 11-Pin Adapter Plug Allows you to use your MHL Smart Adapter with the Latest Galaxy and MHL Compatible Devices

**ICL-TWOU-B**

DUAL USB CAR CIGARETTE LIGHTER ADAPTER  
 • Output: 12~24V  
 • Charges iPod, iPhone, iPad other Smartphones, MP3 and MP4 Players, and Cameras Via USB Port  
 • Smart Fuse for Surge Protection



**2 Ports**

**ICL-THREEU-B**

TRIPLE USB CAR CIGARETTE LIGHTER ADAPTER  
 • Output: 12~24V  
 • Charges iPod, iPhone, iPad other Smartphones, MP3 and MP4 Players, and Cameras Via USB Port  
 • Smart Fuse for Surge Protection



**3 Ports**

**ICL-200U-SLV**

DUAL USB CAR CIGARETTE LIGHTER ADAPTER  
 • Input: 12~24V  
 • Output: 5V-2.4A  
 • Can Quickly Recharge any Smartphone, Tablet, or other USB Powered Devices Directly from your Car's DC Power Socket  
 • Built-In Over-Current Protection  
 • Automatic Short Circuit Protection Function  
 • The IC Includes an Over Temperature Protection Inside. The Maximum Working Voltage could Reach 40V and it could Prevent the High Voltage of Cigarette Lighter from Damaging the Production  
 • The LED will Change to Blue when the Car Charger is put in the Cigarette Lighter  
 • Material: ABS Housing+Aluminum Housing



**2 Ports**

**ICL-300U-SLV**

TRIPLE USB CAR CIGARETTE LIGHTER ADAPTER  
 • Input: 12~24V  
 • Output: 5V-3.4A  
 • Can Quickly Recharge any Smartphone, Tablet, or other USB Powered Devices Directly from your Car's DC Power Socket  
 • Built-In Over-Current Protection  
 • Automatic Short Circuit Protection Function  
 • The IC Includes an Over Temperature Protection Inside. The Maximum Working Voltage could Reach 40V and it could Prevent the High Voltage of Cigarette Lighter from Damaging the Production  
 • The LED will Change to Blue when the Car Charger is put in the Cigarette Lighter  
 • Material: ABS Housing+Aluminum Housing



**3 Ports**

ICC-3535-BLK6

ICC-3535-RED6

ICC-3535-WHT6

CABLE AUDIO/VIDEO/TELEPHONE

- The Soft Material and Configuration Ensure that Cable is Easy to Pack & Use
- The Coiled Audio Cable is more Suitable for your Multimedia Devices to Connect Freely and Easily
- It can Help you to Share your Favorite Music with other People by Connecting your DVD, CD, Mp3 and Mp4 Players or other Multimedia Devices to Multimedia Speakers



IHD-300-RD6

IHD-300-BLU6

IHD-300-GRN6

IHD-300-GRY6

HDMI ETHERNET CHANNEL

- Transports Audio and Video Signals in One Cable
- 3D: Defines Input/Output Protocols for Major 3D Video Formats, Paving the Way for True 3D Gaming and 3D Home Theater Applications
- High Speed Bandwidth up to 340MHz (10.2Gbps)
- Audio Return Channel 0
- Supports 8-Channel Digital Audio and New Lossless Audio Format: Dolby TrueHD and DTS-HD Master Audio
- 4K: Enables Video Resolutions up to 4 Times of 1080p, 3840 x 2160@24Hz/25Hz/30Hz, 4060x2160@24Hz
- Deep Color from 24-bit up to 30-bit, 36-bit, 48-bit (sYCC601 Color, Adobe RGB Color or Adobe YCC601) Color Depths



IRC-3535-GLD6 (GOLD COLOR)

3.5MM STEREO CABLE

- The Soft Material and Configuration Ensure the Cable is Easy to Pack & Use
- This Pocket Cable is more Suitable for your Multimedia Devices to Connect Freely and Easily
- It can Help you to Share your Favorite Music with other Peoples by Connecting your DVD, CD, Mp3 and Mp4 Players or other Multimedia Devices to Multimedia Speakers
- 6' / 1.8m



IRC-3535-GRY6 (GRAY COLOR)

3.5MM STEREO CABLE

- The Soft Material and Configuration Ensure the Cable is Easy to Pack & Use
- This Pocket Cable is more Suitable for your Multimedia Devices to Connect Freely and Easily
- It can Help you to Share your Favorite Music with other Peoples by Connecting your DVD, CD, Mp3 and Mp4 Players or other Multimedia Devices to Multimedia Speakers
- 6' / 1.8m



IRC-3535-ORG6 (ORANGE COLOR)

3.5MM STEREO CABLE

- The Soft Material and Configuration Ensure the Cable is Easy to Pack & Use
- This Pocket Cable is more Suitable for your Multimedia Devices to Connect Freely and Easily
- It can Help you to Share your Favorite Music with other Peoples by Connecting your DVD, CD, Mp3 and Mp4 Players or other Multimedia Devices to Multimedia Speakers
- 6' / 1.8m



IRC-3535-SLV6 (SILVER COLOR)

3.5MM STEREO CABLE

- The Soft Material and Configuration Ensure the Cable is Easy to Pack & Use
- This Pocket Cable is more Suitable for your Multimedia Devices to Connect Freely and Easily
- It can Help you to Share your Favorite Music with other Peoples by Connecting your DVD, CD, Mp3 and Mp4 Players or other Multimedia Devices to Multimedia Speakers
- 6' / 1.8m

IFUA-3MU-GRN

USB TO MICRO USB CABLE COMPATIBLE WITH SAMSUNG, BLACKBERRY

- Flat Design with very Flexible TPE Jacket
- 100% Gold-Plated USB Port
- Color: Green

IFUA-3MU-GRY

USB TO MICRO USB CABLE COMPATIBLE WITH SAMSUNG, BLACKBERRY

- Flat Design with very Flexible TPE jacket
- 100% Gold-Plated USB Port
- Color: Gray

IFUA-3MU-ORG

USB TO MICRO USB CABLE COMPATIBLE WITH SAMSUNG, BLACKBERRY

- Flat Design with very Flexible TPE jacket
- 100% Gold-Plated USB Port
- Color: Orange

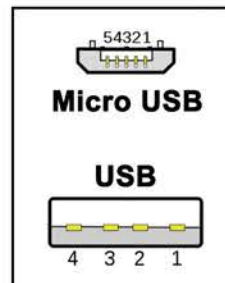

IRC-3535-RED6 (RED COLOR)

3.5MM STEREO CABLE

- The Soft Material and Configuration Ensure the Cable is Easy to Pack & Use
- This Pocket Cable is more Suitable for your Multimedia Devices to Connect Freely and Easily
- It can Help you to Share your Favorite Music with other Peoples by Connecting your DVD, CD, Mp3 and Mp4 Players or other Multimedia Devices to Multimedia Speakers
- 6' / 1.8m



IFC-6MUM-GY (0.6' / 0.2m)

IFC-6MUM-WH (0.6' / 0.2m)

USB TO MICRO USB CABLE

- 100% Gold-Plated USB Port
- Flat Design with very Flexible TPE Jacket
- Up to 30% Faster Charging than Conventional Cables
- Compatible with Smartphone, Table PC, Mobile Phone, MP3 Player, Game Pad

**IPOWER-01-USB**

USB CHARGER POWER ADAPTER

- Input: 100~240V, 50/60Hz
- Output: 5V / 2.1A
- Charges Most Multimedia Devices such as Tablets, Smartphones, MP3/MP4 Players and Cameras VIA USB Port

**5V/2.1A**



**IPOWER-02-USB**

USB CHARGER POWER ADAPTER

- Input: 100~240V, 50/60Hz
- Output: 5V / 2.1A
- Charges Most Multimedia Devices such as Tablets, Smartphones, MP3/MP4 Players and Cameras VIA USB Port

**2 Ports**

**5V/2.1A**



**IPOWER-107WRG**

DUAL USB CAR CHARGER - 2.1A

- Compatible with: iPad®, iPad®2, iPhone® 3G/3GS/4G, Samsung, Huawei & any Devices needing USB Cable for Power
- Plug into Car Cigarette Lighter Jack to become a Powered USB Port
- Compact Design
- Input: DC 12V-24V
- Output: DC 5V 2.1A & 5V 1A



**IPOWER-EUR2-USB**

DUAL USB TRAVEL CHARGER PLUG

- Input: 100~240V, 50/60Hz
- Output: 5V / 2.0A
- Charges most multimedia devices such as tablets, smartphones, MP3 & MP4 players, and cameras via USB port

**5V/2.0A**

**2 Ports**



**IFUA-3LGT-GR**

LIGHTNING TO USB

- USB to iPhone5, iPhone5s, iPad mini, iPad4
- Flat design with very flexible TPE jacket
- 100% Gold Plated USB Port
- Color: Green



**IFUA-3LGT-OR**

LIGHTNING TO USB

- USB to iPhone5, iPhone5s, iPad mini, iPad4
- Flat design with very flexible TPE jacket
- 100% Gold Plated USB Port
- Color: Orange



**QE5N-BT-BLK**

WIRELESS STEREO HEADSET

- Ultralight Elastic Memory Material, Easy to Carry
- Vibrates to Remind you not to Miss any Incoming Calls
- Simultaneously Connect Multiple Device to Easily Switch Calls Entertainment
- High-Fidelity Stereo Sound Audio Earphones for Total Entertainment
- Intelligent Noise Reduction Allows for Clearer Calls
- Long Standby (360 Hours), Talk Time (10 Hours)



**IS-CMT-VT-2**

UNIVERSAL VENT MOUNT

- Three Sets of Vent Clips for any Vent Configuration
- Compatible with Devices up to 82mm Width
- Wide-Range Compatibility (50mm-82mm)



**IS-CMT-AR-6**

UNIVERSAL DASHBOARD/WINDSHIELD SMARTPHONE MOUNT

- Works on the Windshield or Dashboard of the Car
- Compatible with Devices up to 82mm Width
- Quick Release Device with a Tap of your Finger



**IMPM-355**

MOBILE PHONE CAR MOUNT

- Innovative and Stylish Design
- East installation; Mount the Device with One Hand
- Suitable for all Hand-Held Devices
- 360 Degree Rotation; Horizontal or Vertical Positioning
- Strong Magnetic Force, Ensures the Safety of your Equipment



**NP-7001T2U**

BLUETOOTH CAR CHARGER

- LED Display
- Dual USB Charging (QC3.0+5V/1A)
- FM Transmitter 87.5-108.0MHZ
- Supports U-Disk
- Supports MP3 Music Formats
- Automatic Power-Off Memory Function
- Car Cigarette Power Supply
- Bluetooth V4.2
- Bluetooth Hands-Free Calling
- Bluetooth Stereo Music Play w/ DSP Technology
- Car Accumulator Voltage Detection
- Automatic Bluetooth Reconnection



**NP-9D01T2U**

BLUETOOTH CAR CHARGER

- SNR: >60dB
- Frequency Response: 20Hz-20Khz
- Effective Distance: 0.5-2 M
- FM Frequency: 87.5 - 108MHz
- FM Transmission Distance: 2M
- TF Card Capacity: 1G-32G



**NP-5000BT**

BT STREAMING AUDIO KIT + FM TRANSMITTER + 3.4A CAR CHARGER

- BT Version/Version de BT: V2.1
- Frequency Range/Rango de Frecuencia: 87.6~107.9MHZ
- Frequency Stability/Estabilidad de la Frecuencia: ±10ppml
- Input/Entrada: 12~24V
- Music Format/Formato de la Música: Mp3, WMA
- Micro SD Card (Max Capacity)/Micro Tarjeta SD (Máxima Capacidad): 32GB
- USB Disk (Max Capacity)/Disco USB (Máxima Capacidad): 32GB



**NP-7935USB**

CAR FM TRANSMITTER

- 1.4" Large LCD Screen can Display the Frequency and Song Number
- Supports USB Disc & SD/MMC Card
- Line-In Function
- Supports MP3/WMA Format Files
- 206 Channels Optional: 87.6-108MHz
- Supports Folder Switch & 4 Loop Mode
- Supports 6 EQs
- Fully Adjustable Arm for Multi Angle Viewing
- With Wireless Full Function Remote Control
- Transmit Distance: 3-5M
- Input: DC 12-24V
- Supports up to 32G USB Memory Pen Drive



**NP-8635USR**

CAR MP3 FM TRANSMITTER

- With LCD Screen, Display the No.
- 206 Channels Optional: 87.5~108MHz
- Supports 4 Loop Modes
- Memorizes the Last Played Frequency, Song & Volume
- Supports USB Disk & SD/MMC Card
- Supports 12~24 Voltage
- Switch the Folder by Remote Directly



**NP-9025UBTEL**

WIRELESS FM TRANSMITTER & CAR CHARGER

- Wirelessly Transmit Phone Call & Music from Wireless Mobile Phone to the Car FM Stereo System
- Power from the Cigarette Socket in the Car (DC 12V/24V)
- USB Output to Charge External Devices (DC 5V/1A)
- With LCD Screen to Display Numbers.
- 206 Channels optional from 87.5-108.0MHz.
- Detects the Voltage of Car Battery when Power On
- Wireless Version: V2.1, Support A2DP, AVRCP, HFP
- Wireless Version: JL 2.1
- Wireless Protocol: HFP, A2DP, AVRCP
- Screen: LCD Display



**NP-9935USBT**

2 IN 1 CAR FM TRANSMITTER + 2.1A DUAL USB CAR CHARGER

- 1" Large LCD Screen can Display the Frequency and Song Number
- Dual USB Charging Port for Charging iPad, iPhone and other Rechargeable Devices
- Supports USB Disc & SD Card
- Line-In Function
- Supports MP3/WMA Format Files
- 206 Channels Optional
- Supports Folder Switch & 4 Loop Mode
- With Wireless full Function Remote Control
- Transmit Distance: about 10M
- Input: DC 12-24V
- Output: 5V/2.1A
- Supports up to 32G USB Memory Pen Drive



**NP-9950UB TEL**

WIRELESS CAR FM TRANSMITTER WITH 2.1A DUAL USB CAR CHARGER

- Wirelessly Transmit Phone Call from Wireless Mobile Phone to the Car FM Stereo System
- Switch to Hands-Free Mode Automatically from Music Playing Status when Receiving Calls
- Supports Music Play Back from USB and SB Card
- Built-In Microphone
- 3.5mm Aux Jack to Support Play Back from External Audition Devices
- Dual USB Output to Charge for Mobile Phones and other Devices
- Strong and Elegant Design with LCD Frequency Display
- With Remote Control
- With Voice Prompts



**Q-SIG10-BK**

BLUETOOTH RECEIVER

- Version: 2.1
- Rechargeable Battery: 350mAh
- Power Consumption: 5V, 1A
- Charging Time: 2Hrs
- Battery Life: 5~7Hrs
- Ports: 3.5mm Audio Output, Mini USB for Charging
- Range: 10M
- LED Indicators for Charge and Connection
- Package Content: 1 x Bluetooth Receiver, 1 x 3.5mm Cable, 1 x Mini USB Cable
- Weight: 0.05LB (21g)
- Dimensions: 2.4" x 1.4" x 0.6" (6x3.6x1.5cm)

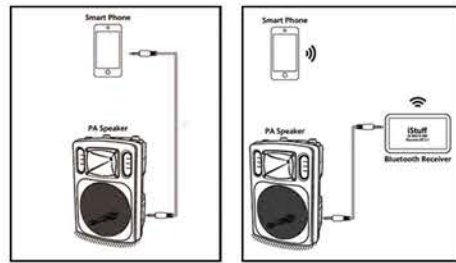

CONVERTS ANY WIRED AUDIO INPUT TO A WIRELESS INPUT



**Q-SERE10-BLK**

Wireless Audio Receiver/Transmitter

- Supported Protocol: A2DP, AVRCP
- Wireless Distance: > 10M
- Built-In Battery: 600MA
- Playing Time: > 8H
- Charging Time: About 2H
- Charging Input Voltage: DC 5V
- Input/Output Connecting Mode: 3.5MM Stereo Audio Port
- Compatibility: Compatible with Phones and PAD of Android/IOS System, and all Wireless Audio Devices

**Your audio transmission Master**  
Used for all audio interface device, like TV, PC, CD Player, iPad, iP one etc. Real-time low latency and high-quality audio transmission

**Receive Mode**  
Easily Connected via wireless, transmit sound to devices with audio interface.

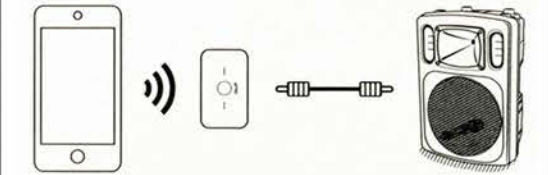

**Transmit Mode**  
Transmit the audio of CD player, TV, PC, online games and other devices to the wireless headset, making you freely enjoying the music.

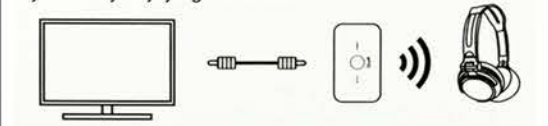

**10M Range**



**Q-SIG4U**

USB BT DONGLE

- BT V4.0
- BT Low Energy Wireless USB Adapter
- Dual-Mode BT Transmission
- Supports BT Voice and Data
- Supports Multi-Language
- Wireless Local Area Network Share Interface
- Supports Network, Dial-Up, Fax, LAN Access
- Sensible Rate: -86dB
- Transmission Distance: 65.6' (20m)
- Interface: USB 2.0
- BT Driver: CSR Harmony Wireless Software Stack
- Available OS: Windows XP/Vista/7/8

(For Mobile Phone, Laptop, PDA, Headphone, etc.)

\*Broadcast Audio from One Device to Another



**Q-U-BSIG-30**

USB BT DONGLE

- For Mobile Phone, Laptop, PDA, Headphone, etc.
- Once Successfully Paired, your Audio from your Source Unit will be Streamed Via the Q-U-BSIG-30
- V2.1
- 8-10M Distance



**Q-U-BSIG-35C**

WIRELESS MUSIC RECEIVER

- Support A2DP V1.2
- Powered by 5V DC
- Transmission Rate: 3 (Mbps)
- Transmission Distance: ≥10 M
- Power Supply Mode: USB-POWER



PLUG THIS WIRELESS MUSIC RECEIVER INTO ANY SPEAKER VIA USB PORT AND CONNECT WITH ANY SMARTPHONE DEVICE FOR WIRELESS MUSIC STREAMING.



**E2**

USB 2.0 CONNECTOR

- 3.5mm Wire Control Cable Allows Audio to be Played through your PC, Notebook, DVD Player and Cell Phones
- Requires no External Batteries



**E2N**

USB 2.0 CONNECTOR

- 3.5mm Wire Control Cable Allows Audio to be Played through your PC, Notebook, DVD Player and Cell Phones
- Requires no External Batteries

CABLES/ACCESSORIES



DVU-DC55-21

POWER DEVICES FROM A USB PORT

- For Small Electronics and Devices which
- Provides 5V DC from USB
- Type A Male USB Plug to 5.5mm (Outer), 2.1mm (Inner) Male Coaxial/Barrel Plug with Positive Center Pin



IBM-205-6/ IBM-205-12 /IBM-205-25GOLD

USB A MALE TO USB A FEMALE CABLE

- 6'/12'/ 25'
- Extends USB Connection to Computer, for use with Printers, Cameras, Mouse, Keyboards and other USB Computer Peripheral



IBM-312MAMB

USB MALE TYPE A TO USB MALE TYPE B MALE

- 12 Ft.
- Makes Plug-and-Play Connections for Devices such as Modems, Printers and other USB Peripherals



IBM-425-3 (3')

IBM-425-6 (6')

IBM-425-10 (10')

IBM-425-15 (15')

IBM-425-25 (25')

IBM-425-50 (50')

IBM-425-75 (75')

IBM-425-100 (100')

CAT5 PATCH CORD

- RJ45 plugs
- Booted
- Stranded
- Available in Ivory
- UL Approved

IBM-A-B-6

USB A MALE TO B MALE CABLE

- 6 Ft.
- Commonly used for Printers, Scanners and other Devices

IBM-A-B-12

USB A MALE TO B MALE CABLE

- 12 Ft.
- Commonly used for Printers, Scanners and other Devices



COMPUTER ACCESSORIES



**IBM-USB-MB**  
 USB TO MINI B USB ADAPTER  
 • Allows Easy Conversion of Cables  
 Commonly used for Digital Cameras



**IBM-USBF-MIN5**  
 USB FEMALE TO MINI 5PIN  
 • Allows Easy Conversion of Cables  
 Commonly used for Digital Cameras



**BL-IBM-AFAF200**  
 USB A TYPE FEMALE COUPLER  
 • Platinum-Plated Connectors



**IBM-RJ45**  
 RJ45 PLUGS  
 • Wire Insert  
 • 8p8c  
 • 5Gu Gold  
 • For use with Solid and Stranded Cables



**VGA-M-RJ45F**  
 VGA TO RJ45  
 Adapter



**IBM-A-BMINI-10**  
 USB A TO MINI B USB CABLE  
 • Commonly used for Digital Cameras,  
 Cell Phones, MP3 Players, PDA Devices  
 • 10'

**VGA-VASPL-1004**

- VGA SPLITTER 1X4 WITH AUDIO
- Easy to Use: Install in Seconds, no need of Setting
  - Connects VGA Source to Four Displays at the Time
  - Connects Stereo Audio Source to Four Audio Receivers at the time
  - Supports Highest Video Resolution up to 1920 x 1200 and 1080p
  - Supports Highest Video Amplifier Bandwidth to 500MHz



**BL-IBM-104USB**

- USB 4-PORT HUB  
 • Includes Hub and USB Cable  
 • Suitable for Notebooks



**BL-IBM-USB35-HM**

- INTEGRATED 2CH USB AUDIO CONTROLLER  
 • Supports 3D Sounds (AC-3) and Virtual 5.1 Surround Soundtrack  
 • The Best Entertainment for Listening to DVD, CD's and General Online Content  
 • Plug and Play, no Software Required  
 • Eliminate the Need for a Traditional Sound Card with this USB to Audio Adapter. Real USB Plug & Play to Upgrade any On-Board Sound Card to 5.1 Digital  
 • Surround Sound without any Hardware Installation  
 • Connect a Speaker or Headphone Directly



**BL-IBM-MOS300**

- USB OPTICAL WHEEL MOUSE  
 • High-Precision Mouse  
 • Plug and Play no Driver Required  
 • Ergonomic Design



**BL-IBM-104USBC**

- FOUR PORT USB 2.0 HI-SPEED HUB  
 • 1 Upstream and 4 Downstream USB Port Included, Fully Compliant with USB Specification Version 2.0 Hot Plug & Play USB Device  
 • Half-Transparent Design with Blue LED Power Indicator  
 • Interface: USB 2.0, Compatible with USB 1.1  
 • Data Transfer Rate: 1.5Mbps / 12Mbps / up to 480Mbps  
 • Bus-Power Limit Current Protection: 500mA

USB 2.0



**DLPT-TYC-45**

- UNIVERSAL DEVICE TYPE C CHARGER  
 • Input: 110V~240V, 50/60Hz, 1.1A  
 • Output: 5V/2A, 9V/2A, 12V/2A, 14.5V/2A, 15V/3A, 20V/2.25A  
 • Widely Compatible with USB-C Enabled Smart Phones, Tablets, Laptops and Computers. Works with Macbook 2016, New Macbook Pro 2016, Dell XPS 13, HP Spectre and more USB-C Laptops



**BL-IBM-KM700**

WIRELESS KEYBOARD + MOUSE COMBO  
MOUSE FEATURES:

- High Precision Optical Sensor 1200PI
- Precision Scroll Wheel
- Nano Receiver Receptacle
- Auto Standby Mode
- On/Off Switch
- Requires (2) AAA Batteries, Not Included

KEYBOARD FEATURES:

- Unique Slim Design, Stylish Configuration, Comfortable Feeling
- Compatible with all Operating Systems
- Requires (1) AA Battery, Not Included

ADVANCED WIRELESS:

- Advanced 2.4 GHz RF Wireless Technology, Provides up to a 10 Meter Multi Directional Range and Practicality Interface Free Use

wireless

12M, 360°  
Transmission



**BL-IBM-KB370**

SLIM DESIGN USB KEYBOARD

- Comfortable to Use
- High-Quality Membrane Key Switch
- Key Stroke Life Time: 10,000,000 Cycles
- USB Interface
- Compatible with Windows Vista 7 and Windows 8
- Slim Design



KEYBOARD



SLIM

**BL-IBM-WKB-400**

WIRED WASHABLE KEYBOARD

- Key: 103K, Port: USB
- Conductive Silver Paste
- Laser Etching Font
- Switch Life more than 5,000,000 Times
- Can be Washed Easily, Submersible up to Depths of 1/30cm
- Drain Hole of Backside can make Keyboard Dry Faster



WASHABLE



KEYBOARD

**CD-116**

LASER LENS CLEANER

- For Conventional CD Players
- Load the Cleaner into the Carrier on the CD Players with the Side Printed up
- Press "Play" to Run the Cleaner
- Operate as Voice Guide Instructs
- Restore the Cleaner in its Case after use



**CD-128**

LASER LENS CLEANER

- For Conventional CD Players
- Load the Cleaner into the Carrier on the CD Players with the Side Printed up
- Press "Play" to Run the Cleaner
- Operate as Voice Guide Instructs
- Restore the Cleaner in its Case after Use



**CSC-200CL**

LCD SCREEN CLEANING KIT

- Powerful Cleaning Solution Removes Dust, Dirt and Oily Fingerprints
- Includes a High-Tech Reusable Microfiber Cloth that Cleans Screens without Scratching
- Cleans TVs, Camcorders, Camera Lenses, HD Monitors and other Video Displays



**IBM-200**  
RJ-45 ADAPTER  
• Coupler



**IBM-468**  
CAT5 SINGLE SURFACE MOUNT BOX  
• Loaded  
• 110IDC  
• Non-Shielded  
• Pre-Mounted on PC Board



**AC-400**  
6' COMPUTER AC POWER CORD  
• AWG 18  
• 3 Conductor  
• Black Jacket



**IBM-RJ-CAT6**  
RJ-45 ADAPTER  
• Plug for CAT6



**PINS#8**    **PINS#24**  
**PINS#14**    **PINS#28**  
**PINS#16**    **PINS#40**  
**PINS#20**    I.C. SOCKETS  
I.C. SOCKETS

CATEGORY 5  
CATEGORY 5 BLUE  
CATEGORY 6

- 1000' CAT5 UTP CABLE
- 4 Pairs of Gauge Wire Inside
  - Solid Strand
  - Pull Box



CATEGORY 5 UL  
1000' CAT5 LAN CABLE

- Solid Strand
- UL Approved



IBM-FAN-200

NOTEBOOK COOLING PAD

- Three Color Fan Cooling System Pulls Heat Away from the Laptop and Prevents the CPU from Overheating During Use
- Powered through USB Port
- Great Ergonomic Shape for Easy Typing
- Plug and Play for USB Devices
- Centralized Fan Blade for Quiet Operation
- Material: Acrylic
- Fan Size: 6 x 6 x 1.5 cm



SPLICES USB PORT

CAT5E-2-UTP4G

- INDOOR LAN CABLE
- 0.51±0.01MM, 24AWG
  - 4 Solid Twisted Pairs
  - CCA

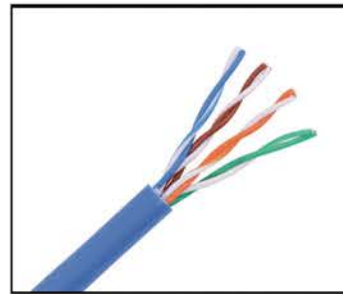

CAT6-2-UTP4G

- INDOOR LAN CABLE
- 0.57±0.01MM, 23AWG
  - 4 Solid Twisted Pairs
  - CCA

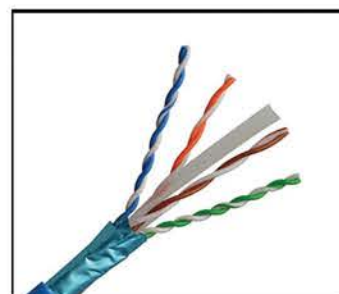

CAT5E-OD2-UTP4

- OUTDOOR LAN CABLE
- 0.51±0.01MM, 23AWG
  - 4 Solid Twisted Pairs
  - CCA

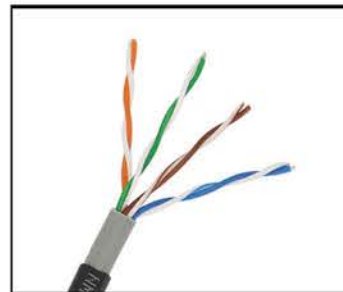

CAT6-OD2-UTP4

- OUTDOOR LAN CABLE
- 0.57±0.01MM, 23AWG
  - 4 Solid Twisted Pairs
  - CCA



CAT5EFT-2-UTP4G

- OUTDOOR LAN CABLE
- 0.51±0.01MM, 24AWG
  - 4 Solid Twisted Pairs
  - CCA

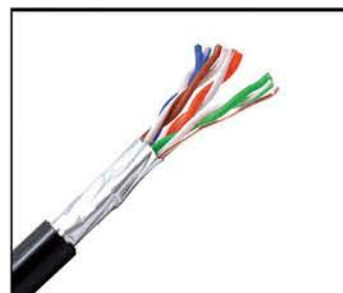

CAT6FT-2-UTP4G

- OUTDOOR LAN CABLE
- 0.57±0.01MM, 23AWG
  - 4 Solid Twisted Pairs
  - CCA

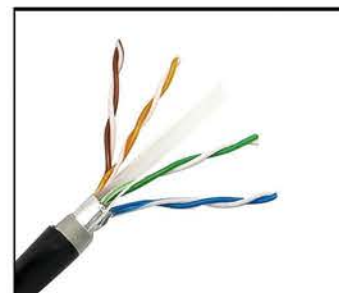

IBM-FAN-275R

NOTEBOOK COOLING PAD

- Silent 140mm Fan with Great Cooling Performance
- Blue LED Shines through the Center Mesh
- Large Metal Mesh for Superior Airflow
- Two Height Settings for Ideal Viewing and Typing Angle
- USB Pass-Through Connector Preserves Laptop USB Connector
- Overall Dimensions: 330 x 250 x 22mm
- Fan Dimensions: Ø140mm x 15mm
- Fan Speed: 1000 rpm ±10%
- Power: DC 5V



Super Slim Design Easy to Carry

IBM-FAN-300X

NOTEBOOK COOLING PAD

- Silent 120mm Fan with Great Cooling Performance
- Blue LED Shines through the Center Mesh
- Large Metal Mesh for Superior Airflow
- Two Height Settings for the Ideal Viewing and Typing Angle
- USB Port x 2
- Overall Dimensions: 345 x 275 x 54mm
- Fan Dimensions: Ø120mm
- Fan Speed: 1500 rpm ±10%
- Power: DC 5V



DLPT-451

AUTOMATIC UNIVERSAL TABLET AC ADAPTER

- Input: AC 100~240V, 50/60Hz
- Output: 19, 19.5, 20V, 45W Max
- Compatible with Acer, Asus, Benq, Dell, Gateway, Hp, Lenovo, Samsung, Sony, Toshiba



Type /Tipo	Output /Salida	Connector Size /Tamaño del Conector	Laptop Brand /Marca del Ordenador Portátil
H1	19V/Max45W	5.5x3.0mm	For Samsung 19V, 2.1A
H2	19V/Max45W	4.0x1.35mm	For Asus 19V, 1.75A~2.37A
H3	19V/Max45W	5.5x2.5mm	For Toshiba/Benq/Gateway 19V, 1.58A/19V, 2.1A/19V, 2.37A
H5D	19.5V/Max45W	4.5x3.0mm	For Dell 19.5V 2.31A
H6	19.5V/Max45W	4.5x3.0mm	For Hp 19.5V 2.31A
H7	19V/Max45W	3.0x1.0mm	For Samsung 19V2.1A /For Asus 19V2.37A
H8	19V/Max45W	2.5x0.7mm	For Asus 19V, 1.58~2.1A
H10	19V/Max45W	5.5x1.7mm	For Acer 19V, 1.58~2.15A
H11	19.5V/Max45W	6.5x4.4mm	For Sony 19.5V 2A
H12	20V/Max45W	USB Type	For Lenovo 20V 2.25A

DLPT-902LUSB

90W AUTOMATIC UNIVERSAL AC ADAPTER FOR LAPTOP

- USB Port Charges for Smart Phone, MP3, MP4, iPad, iPhone, Tablet PC, PDA and Other Related Devices with Standard USB Output
- Multiple Types of Interchangeable Connectors
- Safe and Reliable, Variable Voltages Range from 9.5V~24V
- Multi Country Ready (100V~240V)
- High Grade ABS Housing
- Fire Retardant Case
- Incorporates EMC and EMI Technology, for Absorbing Current Burst and Controlling the Circuitry



Type	Output	Connector Size	Laptop Brand
15.0V/M1	15.0V/Ma x 90W	6.3 x 3.0mm	Toshiba
16.0V/M2	16.0V/Ma x 90W	5.5 x 2.5mm	IBM, Lenovo
16.0V/M3	16.0V/Ma x 90W	6.5 x 1.4mm	Sony, Fujitsu
18.5V/M4	18.0V/Ma x 90W	4.8 x 1.7mm	Compaq, HP
19.0V/M5	19.0V/Ma x 90W	5.5 x 2.5mm	Acer, Compaq, Delta, HP, Fujitsu, Gateway, Toshiba, Liteon
19.0V/M6	19.0V/Ma x 90W	5.0 x 3.0mm	Samsung
19.0V/M7	19.0V/Ma x 90W	5.5 x 2.1mm	Acer, Compaq, Delta, HP, Fujitsu, Gateway, Toshiba, Liteon
19.5V/M8	19.5V/Ma x 90W	6.5 x 1.4mm	Sony
19.5V/M9	19.5V/Ma x 90W	7.4 x 5.0mm	Dell
20.0V/M10	20.0V/Ma x 90W	3 Pin Connector	Dell
20.0V/M11	20.0V/Ma x 90W	7.9 x 5.4mm	IBM, Lenovo
18.5V/M12	18.5V/Ma x 90W	7.4 x 5.0mm	HP, Compaq



DLPT-909USB

AUTOMATIC UNIVERSAL AC ADAPTER (90W)

Compatible with: Samsung, Toshiba, Lenovo, Dell, HP, Acer, Sony, ASUS.



Type /Tipo	Output /Salida	Connector Size /Tamaño del Conector	Laptop Brand /Marca del Ordenador Portátil
H1	19V/Max 90W	5.5 x 3.0mm	Samsung: 19V/3.16A, 19V/4.22A, 19V/4.74A
H3	19V/Max 90W	5.5 x 2.5mm	Toshiba/Lenovo/Asus: 19V/3.42A, 19V/3.95A, 19V/4.74A 20V/3.25A, 20V/4.5A
H5D	19.5V/Max 90W	4.5 x 3.0mm	Dell: 19.5V/3.34A, 19.5V/4.62A
H6H	19.5V/Max 90W	4.5 x 3.0mm	HP: 19.5V/3.33A, 19.5V/4.62A
H10	19V/Max 90W	5.5 x 1.7mm	Acer: 19V/3.42A, 19V/3.95A, 19V/4.74A
H11	19.5V/Max 90W	6.5 x 4.4mm	Sony: 19.5V/3.33A, 19.5V/3.9A, 19.5V/4.7A
H12	20V/Max 90W	USB TYPE	IBM/Lenovo: 20V/3.25A, 20V/4.5A
H13D	19.5V/Max 90W	7.4 x 5.0mm	Dell: 19.5V/3.34A, 19.5V/4.62A
H14H	18.5V/Max 90W	7.4 x 5.0mm	HP: 18.5V/3.5A, 19.5V/3.33A, 19V/4.74A

90Watts



DLPT-909

AUTOMATIC UNIVERSAL AC ADAPTER (90W)

- Input: AC 100 ~ 240V, 1.8A, 50/60Hz (Max)
- Output: DC 18.5V ~ 20V, 4.74A (Max)
- Power: 90W
- Charges for Laptop, Tablet, Smart Phone, Digital Camera, MP3, & MP4 Player
- Connector Size: 5.7" x 2.7" x 0.6" (144 x 69 x 16mm)

Type /Tipo	Output /Salida	Connector Size /Tamaño del Conector	Laptop Brand /Marca del Ordenador Portátil
H1	19V/Max 90W	5.5 x 3.0mm	Samsung: 19V/3.16A, 19V/4.22A, 19V/4.74A
H3	19V/Max 90W	5.5 x 2.5mm	Toshiba/Lenovo/Asus: 19V/3.42A, 19V/3.95A, 19V/4.74A 20V/3.25A, 20V/4.5A
H5D	19.5V/Max 90W	4.5 x 3.0mm	Dell: 19.5V/3.34A, 19.5V/4.62A
H6H	19.5V/Max 90W	4.5 x 3.0mm	HP: 19.5V/3.33A, 19.5V/4.62A
H10	19V/Max 90W	5.5 x 1.7mm	Acer: 19V/3.42A, 19V/3.95A, 19V/4.74A
H11	19.5V/Max 90W	6.5 x 4.4mm	Sony: 19.5V/3.33A, 19.5V/3.9A, 19.5V/4.7A
H12	20V/Max 90W	USB TYPE	IBM/Lenovo: 20V/3.25A, 20V/4.5A
H13D	19.5V/Max 90W	7.4 x 5.0mm	Dell: 19.5V/3.34A, 19.5V/4.62A
H14H	18.5V/Max 90W	7.4 x 5.0mm	HP: 18.5V/3.5A, 19.5V/3.33A, 19V/4.74A



Newly added connector covers latest HP models!



DLPT-1208-USB

AUTOMATIC UNIVERSAL CAR/HOME CHARGING (120W)  
Charge your Notebook with this Compact 120W Universal AC/DC Power Supply and Charger!

This Charger Provides up to 120 Watts of Power, and included 8 Power Tips that are Compatible with Most Popular Laptops and Portable Devices



ACER COMPAQ DELL HP

IBM SONY TOSHIBA LENOVO FUJITSU



120Watts



### DLPT-1015-LUB

SLIM UNIVERSAL AC ADAPTER

- Input/Entrada: AC 100~240V, 50/60Hz
- Output/Salida: 15, 16, 18.5, 19, 19.5, 20V, 100W Max
- Compatible with/Compatible con: Acer, Asus, Dell, Hp, Lenovo, Samsung, Vivo, Toshiba

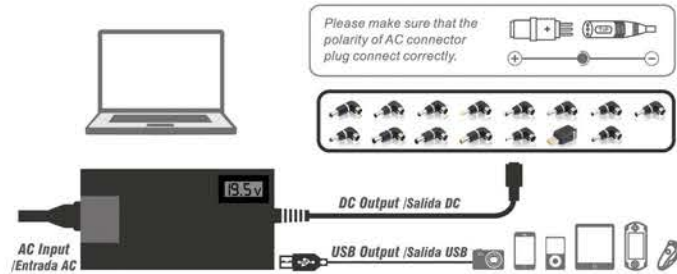

### DLPT-NTB-65

UNIVERSAL NETBOOK ADAPTER

- Input: 110V~240V, 50/60Hz, 1.6A
- Output Power: 19V/19.5V/20V, 65W Max
- Power: Smart 45W-65W
- Type: AC-DC



MULTIPLE DC TIPS & WIDE VOLTAGE RANGE  
Works for Lots of Brand Model Laptops.

Multiple DC Tips:  
This Set of Tips are Compatible with most HP, Dell, Toshiba, Lenovo, Acer, Asus, Samsung, Sony, Fujitsu, Gateway and other Brand Laptop Models which Tips and Voltage are Included.

### DLPT-UNI-16

SMART UNIVERSAL POWER ADAPTER

- Input: 110V~240V, 50/60Hz, 1.5A
- Output: 5.25V, 3A



Type/Tipo	Output/Salida	Connector Size/Tamaño del conector
A	5V/Max 16W	USB Type-C/USB Tipo-C
S	5V/Max 16W	Micro USB/USB Micro
C	5V/Max 16W	5.5 x 2.5mm
F	5V/Max 16W	4.8 x 1.7mm
G	5V/Max 16W	4.0 x 1.7mm
H	5V/Max 16W	3.5 x 1.35mm
I	5V/Max 16W	2.5 x 0.7mm
L	5V/Max 16W	3.0 x 1.0mm



### CV-30USB-KT

5 DETACHABLE USB CONNECTORS, CAN PLUG AND PLAY PC AND MAC

- USB 3.0
- Cable Type: USB 5 in 1
- Cable Length: 6' (1.8m)
- Blue Color

Connectors used for:

- A. USB A Female: Extending the Length of USB Cables
- B. USB B Male: Printers, Scanners, Enclosure, External Drives
- C. USB B Female: Connect with USB B Male Connector
- D. Micro B Male/Mini 10-Pin Male: Cell Phones, Digital Cameras, PDA's

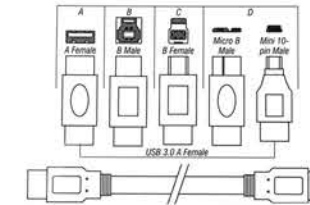

### CV-MUSBVGA

MICRO USB TO VGA CONVERTER

- Allows Users with Existing Monitors with VGA to Connect their Devices Via Micro USB Port. Besides Extracting Audio Out, it can also get Extra Power for Devices through Micro USB Port.



### CV-MDPHDM

This is a Mini DisplayPort to HDMI Cable Adapter for Interfacing Display-Port Based PC and Notebook Computers with High Definition Displays. The Converter Facilitates the Transition by Offering Seamless Connectivity between new DisplayPort PC and the Installed Base HDMI Monitors and Projectors.

- Mini DP Male to HDMI Female Adaptor
- Connect your iPod, Macbook
- Gold Plated Connector
- Support 3D/1080p
- 100% Triple Shield



### CV-MDPVGA

MINI DISPLAY TO VGA ADAPTER

- Connect your Mac, or other Mini Display Port Equipped Computer, Directly to your VGA Equipped Display with this Mini Display Port to VGA Adapter

- Supports Display Port 1.1 Input and VGA Output
- Supports PC Resolutions up to 1920x1200 and HDTV Resolutions up to 1080p
- Easy to use Adapter, No Software Required
- Powered from Mini Display Port Source
- No External Power needed
- Output Video: RGB Analog Video
- Complies with Display Port 1.1 Standard



### CV-USBVGA3

USB 3.0 FEMALE TO VGA CONVERTER

- Used to Connect a USB-Enabled Device (such as a Laptop or Desktop) with VGA-Enabled Device (Such as Monitor, Projector, or TV) for Multi Monitor Solution, Extend Working Space with Split, Screen, Mirroring Display, Etc.
- Supports Windows 10, 8.1, 8, 7, XP, Etc.
- USB 3.0 Supports: 1920 x 1080 (Max), USB 2.0 Supports: 800 x 600.





### IBM-WR400ANT

WIRELESS REPEATER

- Frequency Range: 2.412-2.4835 GHz
- The Wireless Power: 15-18 dBm
- Receiver Sensitivity:
  - 300M: -68 dBm @ 10% PER
  - 270M: -68 dBm @ 10% PER
  - 130M: -68 dBm @ 10% PER
  - 108M: -68 dBm @ 10% PER
  - 54M: -68 dBm @ 10% PER
  - 11M: -85 dBm @ 8% PER
  - 6M: -88 dBm @ 10% PER
  - 1M: -90 dBm @ 8% PER
- Antenna: 2 x 5 dBi Antennas
- Power: Input 100-240V AC; 50/60Hz
- Use Environment:
  - Work Temperature: 0 °C ~ 40 °C
  - Work Humidity: 10% ~90% RH Non-Condensing
  - Storage Temperature: -40 °C ~ 70 °C
  - Storage Humidity: 5%~90% RH Non-Condensing

**300**Mbps  
100V-240V

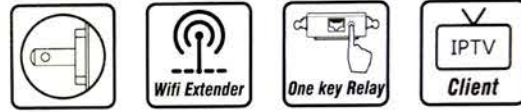

### MAR-LT200

LAPTOP BRACKET

- Black Spray-Painted Iron
- Height & Width Adjustable
- Fix with Screwed Clamp



Clamps for DJ Flight Case



Base for DJ Table



### IBM-AWR3002.4

WIRELESS ROUTER

- Power: 5V 1A
- 300Mbps Wireless Speed Ideal for Interruption Sensitive Applications like HD Video Streaming
- Two Antennas Greatly Increase the Wireless Robustness and Stability

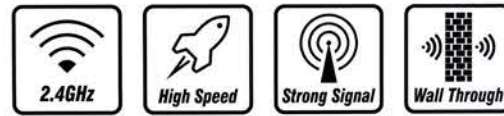

**300**Mbps  
100V-240V



### WRK-STND3724

SIT/STAND COMPUTER WORK STATION

- Desktop Size: 950 x 615mm (37" x 24")
- Desktop Thickness: 15mm (0.6")
- Max. Load Capacity: 15Kg (33Lbs)
- Desktop Height Adjustment Range: 4.3" - 19.9"
- Material: MDF+PVC, Steel, Plastic

**HEIGHT RANGE**  
**4.3" - 19.9"**



### IBM-WR800-2.4G

300Mbps Ceiling AP 802.11b/g/n Wireless Access Point POE Coverage Router Long Range wifi Repeater Antenna for Hotel/Home WIFI

- Ceiling-Mount Design Blends into Environments
- 500mw High Power Design to Boost your Signal Coverage and Link Speed
- 24V Power over Ethernet for 70 Meters Flexible Deployment
- Gateway/AP/Repeater/WDS/WISP Mode Supported



**BOOST YOUR PRODUCTIVITY:**  
Don't be chained to your chair – you can choose to sit, stand and give your body the movement it craves while you continue working in perfect ergonomic comfort.

POWER PRODUCTS



- XCAP-2000**  
POWER CAPACITOR 2 FARAD
- VCD: 20 Max, 24V Surge
  - ESR: 0.002  $\Omega$  or Less
  - Terminals: 1/4-28 Thread
  - Digital Display & Status Indicator
  - Digital Electronic Protection



- XCAP-3500**  
POWER CAPACITOR 3.5 FARAD
- VDC: 20 Max, 24V Surge
  - ESR: 0.002 W or Less
  - Terminals: 1/4 - 28 Thread
  - Digital Display & Status Indicator
  - Digital Electronic Protection



- XTM-200**  
2 CHANNEL IC AMPLIFIER
- Power: 200W Max @ 4 $\Omega$  Mono
  - Frequency Response: 20Hz~20KHz
  - Variable Bass Boost: 0~12dB @ 45Hz
  - Channel Separation: 60dB
  - Signal Noise Ratio: 90dB
  - Input Impedance: 22K $\Omega$
  - Input Sensitivity: 200mV~6V
  - THD: <0.05%
  - Dimensions: 4.3" x 5.9" x 2"(110x150x50mm)



- XTM-400**  
4 CHANNEL IC AMPLIFIER
- Power: 400W Max @ 4 $\Omega$  Stereo
  - Frequency Response: 20Hz~20KHz
  - Selectable Crossover: LPF, FULL
  - Channel Separation: 60dB
  - Signal Noise Ratio: 90dB
  - Input Impedance: 22K $\Omega$
  - Input Sensitivity: 200mV~6V
  - THD: <0.05%
  - Dimensions: 4.3" x 5.9" x 2"(110x150x50mm)

- XMOTO-200**  
2 CHANNEL MINI AMPLIFIER
- Max. Power: 200W Max
  - RMS Power: 2 x 25W @ 4 $\Omega$
  - Frequency Response: 20Hz~20KHz
  - Signal Noise Ratio: 90dB
  - Output Impedance: 4 $\Omega$
  - DC Power: 211.5~14.4V
  - THD: <1.3%
  - Dimensions: 4.3" x 3.1" x 1.6" (110 x 80 x 40mm)
  - RCA Input/High Input
  - Remote Turn On/Off
  - Easy to Connect
  - 3.5mm Plug Input



XXX



**XGT-1402**

- 4" 2-WAY IMPP
- Cone Coaxial Car Speaker
  - Output Power: 100Watts (P.M.P.O.)  
50Watts (R.M.S.)
  - Frequency Response: 80Hz~18KHz
  - Sensitivity: 88dB / W(1M)
  - Impedance: 4 Ohms



**XGT-1502**

- 5.25" 2-WAY IMPP
- Cone Coaxial Car Speaker
  - Output Power: 200Watts (P.M.P.O.)  
100Watts (R.M.S.)
  - Frequency Response: 75Hz~18KHz
  - Sensitivity: 88dB / W(1M)
  - Impedance : 4 Ohms



**XGT-1600**

- 6" DUAL CONE IMPP
- Cone Car Speaker
  - Output Power: 150Watts (P.M.P.O.)  
75Watts (R.M.S.)
  - Frequency Response: 70Hz~15KHz
  - Sensitivity: 89dB / W(1M)
  - Impedance : 4 Ohms



**XGT-1605**

- 6" DUAL CONE PAPER
- Cone Car Speaker
  - Output Power : 60Watts (P.M.P.O.)  
30Watts (R.M.S.)
  - Frequency Response : 150Hz ~ 12KHz
  - Sensitivity: 90dB / W(1M)
  - Impedance : 4 Ohms



**XGT-6803**

- 6" x 8" 3-WAY IMPP
- Cone Triaxial Car Speakers
  - Output Power: 350Watts (P.M.P.O.)  
175Watts (R.M.S.)
  - Frequency Response: 70Hz~20KHz
  - Sensitivity: 89dB / W(1M)
  - Impedance: 4 Ohms



**XGT-1602**

- 6" 2-WAY IMPP
- Cone Coaxial Car Speaker
  - Output Power : 300Watts (P.M.P.O.)  
150Watts (R.M.S.)
  - Frequency Response: 70Hz ~ 18KHz
  - Sensitivity: 89dB / W(1M)
  - Impedance : 4 Ohms



**XGT-1603**

- 6" 3-WAY IMPP
- Cone Triaxial Car Speakers
  - Output Power: 350Watts (P.M.P.O.)  
175Watts (R.M.S.)
  - Frequency Response: 70Hz ~ 18KHz
  - Sensitivity: 89dB / W(1M)
  - Impedance: 4 Ohms



**XGT-6903**

- 6" 3-WAY IMPP
- Cone Coaxial Car Speaker
  - Output Power : 400Watts (P.M.P.O.)  
200Watts (R.M.S.)
  - Frequency Response: 70Hz ~ 18KHz
  - Sensitivity: 89dB / W(1M)
  - Impedance : 4 Ohms



**XGT-6904**

- 6" 4-WAY IMPP
- Cone Quadaxial Car Speakers
  - Output Power: 500Watts (P.M.P.O.)  
250Watts (R.M.S.)
  - Frequency Response: 70Hz ~ 18KHz
  - Sensitivity: 89dB / W(1M)
  - Impedance: 4 Ohms

**XFG-1603**

6" 3-WAY IMPP

- Cone Triaxial Car Speaker
- Output Power: 300Watts (P.M.P.O.)  
150Watts (R.M.S.)
- Frequency Response: 90Hz~18KHz
- Sensitivity: 86dB/W(1M)
- Impedance: 4 Ohms
- Grill and Hardware Included

**KIC-80**

8" WOOFERS (2 Pcs.)

- 2" x 5" Piezo Tweeters (2 Pcs.)
- Carpet Finish
- Impedance: 4 Ohms
- Frequency Response: 45Hz-20KHz
- Sensitivity: 88dB (1W/ 1M)
- Size: 11-3/5" x 27-1/2" x 7-1/2"
- Weight: 17.5 lbs.
- Peak Power: 250 Watt

**KIC-100**

10" WOOFERS (2 Pcs.)

- 2" x 5" Piezo Tweeters (2 Pcs.)
- Carpet Finish
- Impedance: 4 Ohms
- Frequency Response: 40Hz-20KHz
- Sensitivity: 89dB (1W/ 1M)
- Size: 12-3/5" x 29-1/2" x 8"
- Weight: 36 lbs.
- Peak Power: 250 Watt

**XFG-6903**

6"x9" 3-WAY IMPP

- Cone Triaxial Car Speaker
- Output Power: 350Watts (P.M.P.O.)  
175Watts (R.M.S.)
- Frequency Response: 55Hz~18KHz
- Sensitivity: 87dB/W(1M)
- Impedance: 4 Ohms
- Grill and Hardware Included

**KIC-120**

12" WOOFERS (2 Pcs.)

- 2" x 5" Piezo Tweeters (2 Pcs.)
- Carpet Finish
- Impedance: 4 Ohms
- Frequency Response: 35Hz-20KHz
- Sensitivity: 88dB (1W/ 1M)
- Size: 15-1/8" x 33" x 8"
- Weight: 28.5 lbs.
- Peak Power: 500 Watt

**CSB-69**

6" x 9" 3 WAY SPEAKER

- with 1" Aluminum Voice Coil & 20 Oz. Magnet
- Carpet Finish
- Impedance: 4 Ohms
- Frequency Response: 40Hz~20KHz
- Sensitivity: 90dB (1W/ 1M)
- Size: 12" x 6 3/4" x 8"
- Weight: 12 lbs
- Comes in Pairs

**XFG-6904**

6"x 9" 4-WAY IMPP

- Cone Quadaxial Car Speaker
- Output Power: 450Watts (P.M.P.O.)  
225Watts (R.M.S.)
- Frequency Response: 55Hz~18KHz
- Sensitivity: 88dB/W(1M)
- Impedance: 4 Ohms
- Grill and Hardware Included

**XBX-1000B**

10" SUBWOOFER

- 30 Oz. Magnet
- 88 dB/W(1M)
- 2 Channel Amplifier
- Maximum Output Power: 1000 Watts

AMPLIFIER & WIRE KIT INCLUDED



**XTC-3300**

SUPER HIGH-FREQUENCY MINI TWEETER

- 500 Watts
- Sensitivity: 97dB
- Frequency Response: 5KHz~20KHz
- Output Power: 160Watts



**XTC-5500**

SUPER HIGH-FREQUENCY MINI TWEETER

- 500 Watts
- Sensitivity: 100dB
- Frequency Response: 5KHz~20KHz
- Output Power: 120Watts



**XEQ-700**

SLIM MOUNT EQUALIZER

- Frequency Response: 20Hz~20KHz
- Pre Graphic Frequency: 40Hz, 200Hz, 200Hz, 2KHz, 20KHz
- Total Harmonic Distortion(TDH): 0.05%
- Signal-to-Noise Ratio: >80dB
- Inputs: Switchable to Ratio or Aux
- Equalization Boost/Cut: ±12dB
- Subwoofer Crossover Frequency: Selectable 80 or 120Hz
- Channel Separation: 70dB
- Maximum Output Voltage: 9V RMS
- Power Supply: 11~15V Negative Ground
- Fuse: 1A(AGC type)
- Dimensions: Chassis 6.75" x 1.125" x 4.25"
- Mounting Depth: 4.5"(Including RCA Jacks)



**XTC-7700**

SUPER HIGH-FREQUENCY MINI TWEETER

- 600 Watts
- Sensitivity: 100dB
- Frequency Response: 5KHz~20KHz
- Impedance: 4Ω

INCLUDES CAPACITORS



**AUDIODRIFT**

**KP-1737BT**

WMA/MP3/FM/USB/SD PLAYER WITH RADIO RECEIVER

- Fix Panel
- FM Receiver
- USB/SD/MMC Slot
- ESP Electronic System
- Preset EQ (JAZZ/ POP/ ROCK/ CLASS)
- 18 Preset Memory (18FM)
- Last Memory/Preset Scan
- Power Output 50W x 4
- Digital Clock Display
- Full Function Remote Control
- Accept/Decline Option Radio Button



**KP-1757IBT**

WMA/MP3/FM/USB/SD PLAYER WITH RADIO RECEIVER

- Fix Panel
- FM Receiver
- USB/SD/MMC Slot
- ESP Electronic System
- Preset EQ (JAZZ/ POP/ ROCK/ CLASS)
- 18 Preset Memory (18FM)
- Last Memory/Present Scan
- Power Output 50W x 4
- Digital Clock Display
- Full Function Remote Control
- Accept/Decline Option Radio Button
- Multi-Color Illumination

**Multi-Color illumination**



**KP-1757DFB**

SINGLE DIN MULTIMEDIA PLAYER W/ DETACHABLE FACE

- Detachable Face
- With BT Function
- Fix Panel
- AM/FM Receiver
- USB Slot
- ESP Electronic System
- Preset EQ (JAZZ/ POP/ ROCK/ CLASS/ FLAT)
- 30 Presets Memory (18FM, 12AM)
- Last Memory/Preset Scan
- Power Output 50W x 4
- Digital Clock Display
- Full Function Remote Control



### KPD-1935BT

CAR CD PLAYER WITH WIRELESS STREAM/USB/SD/MMC AND AM/FM TUNER

- Compatible CD / HDCD / CD-R / CD-RM / CD / MP3 / MP4 Multiple Format
- Electronic Audio Control (VOL / BAS / TRE / BAL / FAD)
- Electronic Turning Stereo FM Radio Turner, 18 FM Channels
- USB / SD / MMC Slot
- Front/Rear AUX In
- RCA Line Out
- Multiple Preset EQ ROCK/POP/CLASSIC
- Supports Pause / Preview / Repeat / Random Play
- Supports Breakpoint and ID3 Play
- Digital Clock Display
- Charge Function for Mobile Phone or other USB Devices
- Wireless Remote Control
- Super Machine Anti-Shock Technique (ESP Electronic System)
- Power Output: 50W X 4
- Built-In Wireless Music Stream
- 12 AM / 18FM Channels



**NOW WITH DVD PLAYER**



### KPD-1957IBT

CAR CD PLAYER WITH WIRELESS STREAM/USB/SD/MMC AND AM/FM TUNER

- Compatible CD / HDCD / CD-R / CD-RM / CD / MP3 / MP4 Multiple Format
- Electronic Audio Control (VOL / BAS / TRE / BAL / FAD)
- Electronic Turning Stereo FM Radio Turner, 18 FM Channels
- USB / SD / MMC Slot
- Front/Rear AUX In
- RCA Line Out
- Multiple Preset EQ ROCK/POP/CLASSIC
- Supports Pause / Preview / Repeat / Random Play
- Supports Breakpoint and ID3 Play
- Digital Clock Display
- Charge Function for Mobile Phone or other USB Devices
- Wireless Remote Control
- Super Machine Anti-Shock Technique (ESP Electronic System)
- Power Output: 50W X 4
- Built-In Wireless Music Stream
- 12 AM / 18FM Channels
- Multi-Color Illumination



### KDC-6050A

CAPACITIVE SCREEN MULTIMEDIA PLAYER (FITS STANDARD AMERICAN DASH CAR KITS)

- Screen Dimension: 6.2" TFT Full Touch Screen
- Multi-Color Illumination
- Screen Resolution: 800 x 480 High Definition
- Supports 1080P High Resolution Video
- Compatible with DVD/DVD-R/DVD-RW/DIVX(MPEG4) VCD/MP3/CD/CD-R/CD-RW
- Electronic Tuning Stereo FM Radio Tuner, 18 FM Channels
- 12 AM Channels
- SD Card/Big USB Port/Front Aux-In
- Supports Audio/Video Input/Output
- Wireless Hands Free Function (A2DP)
- Electronic Encoder Audio Control: Volume/Bass/Treble/Balance/Fader
- Multiple Preset EQ JAZE/ROCK/POP/CLASSIC
- Steering Wheel Control
- RCA Rear View Camera Input
- Super Machine Anti-Shock Technique (ESP Electronic System)
- Charge Function for Mobile Phone or other USB Devices
- Wireless Remote Control
- Power Output: 50W X 4
- Supports Mirror Link Function



### KDC-6241D

CAPACITIVE SCREEN CAR DVD/MP4 PLAYER WITH WIRELESS/USB/SD/MMC/AM/FM

- 2 Din Multimedia Receiver with Motorised Full Touch Screen 6.2" TFT Panel with Dynamic Graphic User Interface
- DVD/DIVX/VCD/WMA/MP3(ID3 Tag)/CD/R/RW Compatible with Electronic Anti-Skip Protection
- PLL Synthesized Electronic Tuning Stereo AM/FM.
- Presets 30FM, Station Seek, Preset Scan
- SD Card/Mini USB Port (USB Adapter Cable supplied)
- Wireless Hands Free Function
- Full Function Wireless Infrared Remote Control
- TFT Screen Supporting True Color with 1440 x 234 High Resolution
- Electronic Encoder Audio (Volume/Bass/Treble/Balance/Fader) Control
- Selectable EQ Curves • Pop, Rock, Classic, Jazz & User
- Front Aux-Input for Connection to any Portable Device
- 45 Watts (Max) 4 Channel High Output Power

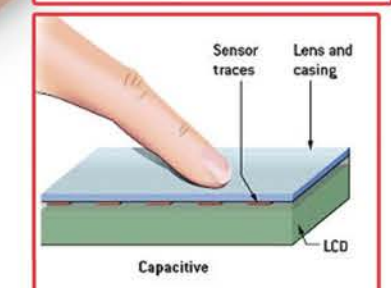
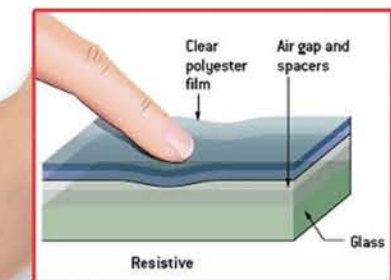

### KDC-6245AM

#### CAPACITIVE SCREEN MULTIMEDIA PLAYER

- 2 Din Multimedia Receiver with Motorized Full Touch Screen 6.2"
- TFT panel with Dynamic Graphic user Interface
- CD/DIVX/VCD/WMA/MP3(ID3 Tag)/R/RW Compatible with Electronic Anti-skip Protection
- PLL Synthesized Electronic Tuning Stereo AM/FM.
- Presets 30FM, Station Seek, Preset Scan
- SD Card/Mini USB port (USB Adapter Cable supplied)
- Wireless Hands Free Function
- Full Function Wireless Infrared Remote Control
- TFT screen supporting True Color with 1440 x 234 High Resolution
- Electronic Encoder Audio Control: (Volume/Bass/Treble/Balance /Fader)
- Selectable EQ Curves • Pop, Rock, Classic, Jazz & User
- Front Aux-input for connection to any portable device
- 45 Watts (max) 4 Channel High Output Power
- Supports high resolution video.
- Supports Mirrorlink.



### KD-6750CP

#### 2 DIN UNIVERSAL MULTIMEDIA ENTERTAINMENT SYSTEM

- 6.2' Digital LCD with Capacitive Touch Screen
- Built-In DVD Player, Car Specification Slot-In Mechanism, Compatible with DVD-R, DVD-RW, DVD+R, DVD+RW, CD-R, CD-RW, CD-DA,HDCD, SVCD, VCD
- Built-In FM/AM Tuner
- USB Compatible with MP3,WMA,AAC Low Complexity Profile,AVI,MP4, JPEG
- SD Compatible with MP3,WMA,AAC Low Complexity Profile,AVI,MP4, JPEG
- Bluetooth - Hands-Free, Phonebook, Recent Calls (Dialed, Missed, Received) Synchronize, Caller ID and Audio Streaming (BT music)
- Built-In 40WX4CH (Peak Power) Power Amplifier
- Volt Pre-Out (2V) with 4.1 Channel Output
- Reverse Detection, Rear Camera Ready
- AUX IN (Front) Connect and Playing Function
- Rear AV-IN 1xCH
- Rear Video-Out 2xCH
- Steering Wheel Control □Learning Type□
- Remote Control
- Built-In Calendar
- Support Wallpaper Settings
- Car Brand LOGO Settings for Start up LOGO
- Smartphone Link (Support iPhone Control and Display on the Radio, Support Siri Voice Control)



REMOTE INCLUDED



### KP-4435BMP

#### 4" SCREEN MP5/MP4/MP3 MULTIMEDIA PLAYER

- 4" TFT Screen
- Fix Type Panel
- MP5 / JPEG / RMVB / AVI / MKV / MOV Format Compatible
- Mp3 Playback with ID3 Tag Wireless Music Stream 2.1 Hands-Free A2DP
- AM / FM PLL Radio with 30 Preset Stations
- Auto Memory Store
- Preset EQ (POP / Rock / Classic)
- Encoder Volume (Treble / BASS / Fader / BALANCE)
- Front USB / TF Port
- Front Aux Input
- Clock
- 4 x 25W Output Power
- Remote Control
- Built In ISO Female Connector
- ISO Male Connector Included
- Video Output
- Video Input
- Reverse Camera Input
- Audio Output x 2 Pairs (RCA)



### KM-7108P

#### 7" MECHLESS DOUBLE DIN WITH DIGITAL TOUCH SCREEN

- Screen Resolution: 800 x 480 High Definition
- Compatible with RMVB / RM / FLV / 3GP / MPEG / DIVX / XVID / DAT / VOB / AVI / MP4 / MP3 / WMA / WAV
- Electronic Tuning Stereo FM Radio Tuner, 18 FM Channels
- Built-In Aux Input
- SD/MMC Slot and Standard USB Interface
- Multiple Preset EQ JAZZ / ROCK / POP / CLASSIC
- Supports Rear View Camera Input Function
- Super Machine Anti-Shock Technique (ESP Electronic System)
- Charge Fuction for Mobile Phone or other USB Devices
- Wireless Remote Control
- Power Output: 50W x 4
- Wireless Hands-Free Function (A2DP)
- 12 AM / 18FM Channels







**DS-A1673LE**

- 6.5" 3-WAY SPEAKER WITH LED
- 330W Max Power
  - 1" ASV Voice Coil
  - 13mm Neo Tweeter, Piezo Tweeter
  - Black PP Cone
  - Shiny Black Basket
  - White T-Yoke 3mm, Washer 3mm
  - LED on Tweeter
  - 80x40x15 Magnet
  - Impedance: 4 Ohms



**DS-A1073S**

- 4" FLUSH-MOUNT CAR SPEAKER
- 3-Way IMPP Cone Car Speaker
  - Output Power: 200 Watts (P.M.P.O.)  
100 Watts (R.M.S.)
  - Frequency Response: 75Hz - 18KHz
  - Sensitivity: 88dB/W(1)
  - Impedance: 4 Ohms



**DS-A6993LE**

- 6 X 9" 3-WAY SPEAKER WITH LED
- 400W Max Power
  - 1" ASV Voice Coil
  - 13mm Midrange
  - Black PP Cone
  - Shiny Black Basket
  - White T-Yoke 3mm, Washer 4mm
  - LED on Tweeter
  - 100x60x20 Magnet
  - Impedance: 4 Ohms



**DS-A1373S**

- FLUSH-MOUNT CAR SPEAKER
- 3-Way IMPP Cone Car Speaker
  - Output Power: 200 Watts (P.M.P.O.)  
100 Watts (R.M.S.)
  - Frequency Response: 75Hz - 18KHz
  - Sensitivity: 88dB/W(1)
  - Impedance: 4 Ohms
  - 5-1/4" Coaxial 3-Way

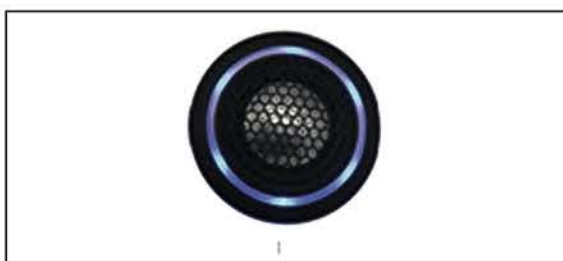

**DS-T250LE**

- TWEETER
- LED on Tweeter
  - ALU Diaphragm
  - 25mm Voice Coil
  - Neo Magnet
  - Including Grill
  - Screws
  - Cardboard Packing, Giftbox



**ADS-250**

- TWEETER PIEZO ELECTRONIC
- Frequency Range: 5-20KHz
  - Sensitivity: 105dB(1W/1M)
  - Power: 500W Max
  - Impedance: 4-8 Ohms
  - Size: Φ45 x 24mm



**DS-A1683S**

- 6-1/2" 4-WAY CONE CAR SPEAKERS
- Flush-Mount Car Speakers
  - 4-Way IMPP Cone Car Speaker
  - Output Power: 350 Watts (P.M.P.O.) / 175 Watts (R.M.S.)
  - Frequency Response: 70Hz - 20KHz
  - Sensitivity: 90dB/W(1)
  - Impedance: 4 Ohms
  - 6-1/2" Coaxial 4-Way



**DS-A6873S**

6"x 8" IMPP CONE TRIAXIAL CAR SPEAKERS

- 3-Way Speaker
- Output Power: 350 Watts (P.M.P.O.)  
175 Watts (R.M.S.)
- Frequency Response: 70 Hz - 20 KHz
- Sensitivity: 89dB / W(1M)
- Impedance: 4 Ohms



**DS-A6993S**

6 x 9" 4-WAY

- Injection Cone Woofer with Rubber Edge
- 55mm Paper Midrange and 20mm Piezo Tweeter and 13mm Piezo Tweeter
- 1" ASV Coil
- 20 Oz. Magnet
- 4 Ohm Impedance
- 200W Max Power



**DS-A620**

6" 2-WAY CAR SPEAKER

- 30 Watts RMS Power
- Impedance: 4Ω ± 15% (at 100Hz)
- Frequency Response: 80 ~ 20k Hz
- Total Weight: 0.42kg
- Black Steel Frame



**DS-A6902**

6 X 9" 2-WAY CAR SPEAKER

- 40 Watts RMS Power
- Impedance: 4Ω ± 15% (at 100Hz)
- Frequency Response: 50 ~ 18k Hz
- Total Weight: 0.76kg
- Black Steel Frame

**DEQ-500**

4-BAND GRAPHIC EQUALIZER WITH SUBWOOFER OUTPUT

- Independent Adjustable Input Gain Controls on Radio and CD Channels
- 0-18 dB Boost/Cut at Center Frequencies: 40 Hz (Low), 150 Hz (Low-Mid), 1 kHz (Mid) and 20 kHz (High)
- EQ Center Frequencies: 40Hz • 150Hz • 1kHz • 20kHz
- Equalization Range: +/- 18dB (Boost/Cut)
- Frequency Response: 20Hz-20kHz
- Subwoofer Crossover Frequency: Variable 30-250Hz
- Signal-to-Noise Ratio: 105dB
- EQ THD: < 0.05%
- Subwoofer Channel THD: < 0.05%
- Channel Separation: 60dB
- Power Supply: 10-16V Negative Ground
- Output Voltage: 7V
- Dimensions (W x D x H): 173 x 108 x 28mm (6.8" x 4.25" x 1.1")



**ADS-TW-55**

SUPER HIGH FREQUENCY MINI TWEETER

- Output Power: 500 Watts
- Plastic Grill Allows for all Weather Use



**KD-MIC01**

MICROPHONE FOR KD

- Sensitivity -35, -32, -29 dB
- Impedance: 2.2 Ω
- Signal to Noise Ratio: 60 dB
- Current Consumption: 500 μ A



**PIPEDREAM**

**NL-LBRT-45-20W**

LED LIGHT

- Power: 45W
- LED type: 15PCS x 3W Epistar
- Beam: Hi/lo Beam
- Working Voltage: 10V-30V
- Lumen: 3375LM
- Waterproof: IP68
- Color Temperature: 6000K-7000K
- Material: Diecast Aluminum Housing
- Lens Material: PC
- Operating Temperature: -40°C ~ +80°C
- Lifespan: over 50,000 Hours Life

**15**  
Super  
Bright  
LEDs

**IP68**  
WaterProof

**Over**  
**50K**  
Hours  
Life



**NL-ACKT116LM**

AC/DC LED Flexible Strip Kit with Remote

- Input: 100~240V
- 1.2cm Wide, 0.3cm High
- LED Quantity (1M): 60 LED's
- IP Class: IP65
- Color: RGB
- Size: 16.4'/5M
- AC/DC Adaptor Included
- Can be Cut every 3 LED's which is Equivalent to 2"
- Use it for Underbody Lighting, Engine Bay Lighting or Interior Lighting
- Will hold up in all Weather Conditions, Indoors/Outdoors
- So Flexible, it can Achieve 90 Degree Angle Bends

**16.4'**  
RGB



NL-H-9005-36W

LED HEADLIGHT

S1 LED Headlight-9005

- Power: 36 Watts per piece
- Voltage: 9-32V (fits 12V/24V vehicles)
- Lumen: 3600 LM
- Ideal for High Beam Reflector headlights
- Easy and click Installation
- Secure temperature range up to 6500K
- With LED CSP beam
- Constant brightness output at all times



NL-H-H1-36W

NL-H-H4-36W

NL-H-H7-36W

LED HEADLIGHTS

- Power: L/36W, H/36W
- Voltage: 9V-32V DC
- Working Temperature: -40°C~ +85°C
- LED Type: CSP x 6 PCS (SINGLE BEAM), CSP x 12PCS(DOUBLE BEAM)
- Lumens: 4000LM
- Cooling System: Aviation Aluminum 6063
- Color Temperature: 6000K
- Waterproof: IP67
- Beam Angle: 360°
- Material: Aluminum Alloy
- Lifespan: 50,000hrs



NL-H-9006-36W

LED HEADLIGHT

S1 LED Headlight-9006

- Power: 36 Watts per piece
- Voltage: 9-32V (fits 12V/24V vehicles)
- Lumen: 3600 LM
- Enhanced light efficiency
- Easy and click Installation
- Secure temperature range up to 6500K
- With LED CSP beam



IP67  
WaterProof

Over  
50K  
Hours  
Life



NL-H-9007-36W

LED HEADLIGHT

S1 LED Headlight-9007

- Power: 36 Watts per piece
- Voltage: 9-32V (fits 12V/24V vehicles)
- Lumen: 3600 LM
- Easy and click Installation
- Secure temperature range up to 6500K
- With LED CSP beam



NL-H-H11-36W

LED HEADLIGHTS

S1 LED Headlight-H11

- Power: 36 Watts per piece
- Voltage: 9-32V (fits 12V/24V vehicles)
- Lumen: 3600 LM
- Secure temperature range up to 6500K
- With LED CSP beam
- Ideal for replacing low and high beams, fog lights and motorcycle H11 headlight bulbs
- Consistent brightness output



LBS-400-BL  
LBS-400-RED  
LBS-400-WH-BT  
SNAKE EYES

- Customize your Vehicle, Motorcycle or Boat
- Can be Installed Under Seats, Dashboards, under your Hood or anywhere imaginable.
- Easy to Install
- 4 LED's are Included Per Pack



NL-SC710

LED SCANNER

- With 7 Blue Micro Flashing LEDs
- Long Lasting Super Bright LEDs
- Over 100,000 Hours Life
- Low Power Consumption, no Heat Build-Up
- Can be used to Conjunction with your Security Alarm as a Warning Light
- Install with or without Car Alarm
- Can change between 7 different Patterns, and 3 Colors by Pressing Pinhole Button on Front of Scanner

7  
Super  
Bright  
LEDs



Adhesive strip included for installation

Over  
100K  
Hours  
Life

Sold Individually\*



- Can change between 7 different patterns, and 3 colors by pressing pinhole button on front of scanner

NL-F1010CW-BL  
NL-F1010CW-WH  
LED FLEXIBLE STRIP

- 0.7cm wide, 1.25cm Height
- Size: 10"/25cm
- Use it for Underbody Lighting, Engine Bay Lighting, Marine Lighting and Exterior Lighting
- Easily takes to Shapes and installs around Areas with Curves and odd Shapes where LED Rods can't
- Can be cut every Three LED's to ensure a Perfect Fit
- Flexible PVC Cover ensures the LED's are Water Resistant, making it a suited Product for Marine use



NL-F1020CW-BL  
NL-F1020CW-WH  
LED FLEXIBLE STRIP

- 0.7cm wide, 1.25cm Height
- Size: 20"/50cm
- Use it for Underbody Lighting, Engine Bay Lighting, Marine Lighting and Exterior Lighting
- Easily takes to Shapes and installs around Areas with Curves and odd Shapes where LED Rods can't
- Can be cut every Three LED's to ensure a Perfect Fit
- Flexible PVC Cover ensures the LED's are Water Resistant, making it a suited Product for Marine use



NL-F512CB-BLU  
NL-F512CB-GR  
NL-F512CB-OR  
NL-F512CB-PR  
NL-F512CB-RED  
NL-F512CB-WH  
LED FLEXIBLE STRIP

- 1cm Wide, 0.2cm Height
- Size: 12"/30cm
- Can be Cut every 3 LED's which is Equivalent to 1"
- Use it for Underbody Lighting, Engine Bay Lighting, or Interior Lighting
- Will hold up in All Weather Conditions, Indoors or Outside
- So Flexible, it can Achieve 90° Angle Bends



NL-F524CB-BL  
NL-F524CB-GR  
NL-F524CB-OR  
NL-F524CB-RD  
NL-F524CB-WH  
LED FLEXIBLE STRIP

- 1cm Wide, 0.2cm Height
- Size: 24"/60cm
- Can be Cut every 3 LED's which is Equivalent to 2"
- Use it for Underbody Lighting, Engine Bay Lighting, or Interior Lighting
- Will hold up in All Weather Conditions, Indoors or Outside
- So Flexible, it can Achieve 90° Angle Bends



NL-3012MULTI  
LED TWIN RODS

7 COLOR ACCESSORY KIT FOR ALL YOUR LIGHTING NEEDS!

- Light up your: Car, Truck, Motorcycle, Room, Etc.
- Colors: Red, Yellow, Green, White, Aqua, Blue, Purple
- Built-In Memory Chip to Resume Current Setting
- Accent your Car, Truck, Motorcycle or Boat
- 12"



12"



MLD-F424WK  
7 COLOR LED MARINE DECK KIT

- Color: 7 Color
- Size: 24"/61cm x 4 pcs
- Easy Installation
- Selectable Color
- Multiple Changing Patterns
- Illuminates your Deck or Cabin

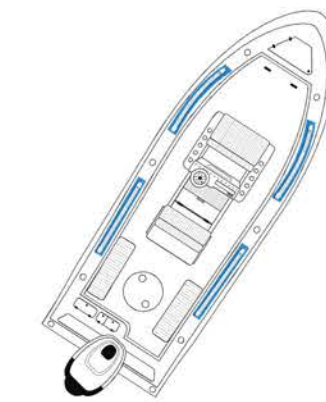

NL-K216C BLU  
 NL-K216C GRN  
 NL-K216C ORG  
 NL-K216C PRL  
 NL-K216C RED  
 NL-K216C WHT

LED STRIP KIT

- Includes Hardware for Four Extensions
- Cutable
- LED Qty: 60 LED s/m
- LED Type: SMD 3528
- Packing: 5 M/Roll
- Voltage: 12V DC
- Colors: Blue, Green, Orange, Purple, Red and White



16"

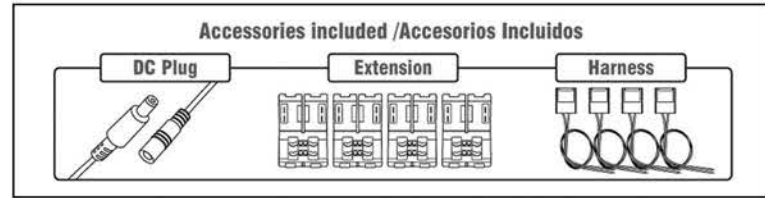

NL-464-BTK

WIRELESS STREAM RGB LED CONTROLLER

- One RGB LED APP Controller with 4 Outputs with Connectors and Remote in Turn on Wire
- Extra 6" Extension Cables x 4
- Voltage: 12V DC, Current: 10A



*The controller uses advanced PWM (Pulse Width Modulation) digital control technology for precise and accurate color management. The controller can ONLY be operated using the LED phone app. This app is available for both IOS and Android.*

NL-ADPT-2A12

POWER ADAPTOR

- Compatible with all 12V LED's
- Input: 100-240VAC
- Output: DC 12V
- 2000mA Max



NL-412BT

WHEEL-WELL KIT

- One RGB LED APP Controller with 4 Outputs with Connectors and Remote in Turn on Wire
- 4 x 4 RGB LED Module Lights
- 4 x 48" Male to Female Extension Cable
- Voltage: 12V DC, Current: 10A



NL-KT116LEDM

7-COLOR LED FLEXIBLE STRIP

- 0.8cm Wide, 0.2cm Height
- Color: 7 Color
- Size: 16' / 480cm

EASY TO USE:

- A Clearly Marked Line Shows Exactly Where to Cut
- 24 Key Super Thin IR Remote Controller Allows User to Conveniently Set Colors and Control Patterns
- Create a Stunning Light Show on your Motorcycle, Car, Truck, Boat- just about anything



Accesorios Incluidos

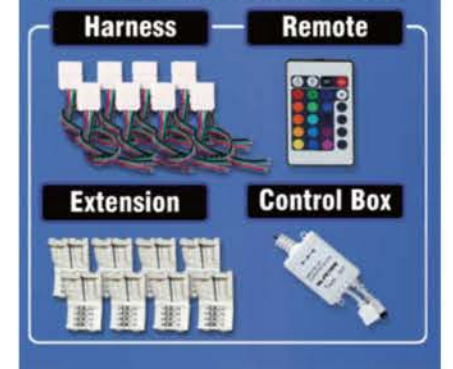

NL-KT216LEDM

16FT X 2 / 7-COLOR LED FLEXIBLE STRIP

- 0.8cm Wide, 0.2cm Height
- Color: 7 Color
- Size: 16' / 480cm

EASY TO USE:

- A Clearly Marked Line Shows Exactly Where to Cut
- 24 Key Super Thin IR Remote Controller Allows User to Conveniently Set Colors and Control Patterns
- Create a Stunning Light Show on your Motorcycle, Car, Truck, Boat- just about anything



NLTB-4860

LED TRUCK TAILGATE LIGHT

48"

- 4 Pin Trailer Style Connector
- Also Lights up when Integrated with your Truck's Reverse Lights
- Self-Adhesive Mounting Pads for Easy Installation
- Includes Mounting Hardware



NLTB-6060

LED TRUCK TAILGATE LIGHT

60"

- 4 Pin Trailer Style Connector
- Also Lights up when Integrated with your Truck's Reverse Lights
- Self-Adhesive Mounting Pads for Easy Installation
- Includes Mounting Hardware



**STRB-500**

- LED STROBE LIGHT
- 11-30VDC
  - Waterproof
  - 15 Flashing Patterns
  - EZ-Switch Control
  - Auto-Recall Function
  - LED Flash Pattern Indicator
  - Brightness Control Option
  - Option (Car Alarm Warning)



**NL-FK200R**

- LED REMOTE CONTROL BOX
- LED (RGB) Control Box with Harness
  - Compatible with most 16' RGB LED Strips



**MLD-G4-06**

**MLD-G4-09**

- LED REPLACEMENT BULB
- Low Power Consumption
  - Low Temperature
  - Shock Proof
  - Current-Regulated Driver Technology
  - Super High Lumen Output
  - Lasts Longer, Reduces Heat and Saves Energy
  - Replaces G4 BI-PIN Bulbs in Common Low-Voltage Reading Light and Downlights



**APNL-LST-EXT10**

- EXTENSION CABLE 10 FT
- Compatible with:  
APNL-408CNT  
APNL-FLX8MULTI  
APNL-FLX16MULTI



**NLD-100**

- DIGITAL VOLTAGE METER
- Range: 11.1-15.9V
  - 3-Digit Display W/Turn-On Circuit



**NLD-300CLUBL**

- VOLTAGE METER WITH USB CHARGER
- Voltage Meter: Monitor your Electrical Performance
  - USB Charger: 1000 mA Quick Charger for Phone and Portable Devices
  - 12V Plug: Standard Size to Work with all Vehicles



**MLDPC-6BL (6")**

**MLDPC-6RD (6")**

**MLDPC-6WH (6")**

**MLDPC-12BL (12")**

**MLDPC-12RD (12")**

**MLDPC-12WH (12")**

ADVANCED MARINE APPLICATION LED

- Waterproof IP 68
- 12-Volt DC Power Only
- This LED Lights are Polarity Sensitive
- It is Important the Power and Ground are Connected Properly
- Red Wire=Positive /Black Wire=Negative



**MLDPC-24BL (24")**

**MLDPC-24RD (24")**

**MLDPC-24WH (24")**

ADVANCED MARINE APPLICATION LED

- Waterproof IP 68
- 12-Volt DC Power Only
- This LED Lights are Polarity Sensitive
- It is Important the Power and Ground are Connected Properly
- Red Wire=Positive /Black Wire=Negative



**NL-3006MULTI-BT (6 IN.)**

**NL-3009MULTI (9 IN.)**

- LED TWIN RODS
- Flashes to the Beat
  - Choose your Favorite Color, Steady on
  - Cycle through all 7 Colors, Adjustable Speed
  - 7 Color Effect
  - Built-In Memory Chip to Resume Current Settings
  - Accent your Car, Truck, Motorcycle or Boat



**LED-100BLU**

- LED SCANNER
- With 7 Blue Micro Flashing LED's & 10 Different Selectable Patterns
  - Super Bright LEDs, Long Lasting Shock
  - Over 100,000 Hours Life
  - Low Power Consumption, No Heat Build-Up
  - Can be used in Conjunction with your Security Alarm as a Warning Light
  - Installs with or without Car Alarm



NL-F424WK

7-COLOR LED FENDER TRIM LIGHT

- Color: 7 Colors
- Size: 24"/61cm x 4 Pcs
- Dances to the Beat of the Music
- Easy Installation
- Selectable Color
- Multiple Changing Patterns
- Illuminates the Wheel Well
- Flexible



NL-7LEDX

7 COLOR ACCESSORY KIT FOR ALL YOUR LIGHTING NEEDS

- Light up your: Car, Truck, Motorcycle, Room
- Colors: Red, Yellow, Green, White, Aqua, Blue, Purple
- Built-In Memory Chip to Resume Current Setting
- Accent your Car, Truck, Motorcycle or Boat
- Remote Control



NL-S3648FLT

FLEXIBLE SLIMLINE MULTICOLOR UNDERCAR LED KIT

- Add an Animated LED Glow to your Car. Can't Decide on a Color? Why Choose when this Kit has 7 Colors and 12 Lighting Sequences including Sound Activation Mode
- A Great Kit for a Novice or Pro!  
The Kit includes Two 48" and Two 36" LED Tubes



**Contents**  
 2 x 48" LED Tubes  
 2 x 36" LED Tubes  
 1 x LED Controller Module

1 x Control Board  
 1 x Remote Board  
 All Mounting Hardware

**Remote**  
 Control all lighting sequences from your key chain remote!



**Controller Module**  
 Control all lighting sequences from the control unit or remote!



**Distribution Block**  
 Easy connection block for wiring the system



**Tough Tubes**  
 The LED tubes encapsulated in impact and water resistant tubing. 36" tubes have 81 LED's and 48" tubes have 108 LED's.



**Slight Flex**  
 The softer flexible tube allows you to mount the under a uneven chassis with ease



NL-R18050 RGB

8.5" LED SPEAKER RINGS

- Durable Acrylic 12mm Thickness
- Handle all Outdoor Weather Environments
- LED's are Pre-Mounted and Ready to Install
- Rings are Supplied with a Weather-Proof Connector
- Outer Edges are Frosted for a Consistent Glow Effect
- Made to Fit APSW-8032 8" Coaxial Marine Speakers



SPEAKER NOT INCLUDED

SPEAKER NOT INCLUDED

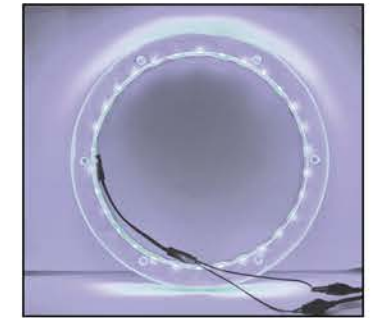
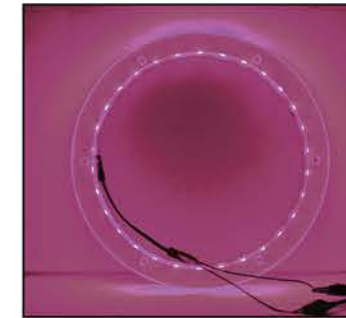

NL-R16550-RGB

6.5" LED SPEAKER RINGS

- Durable Acrylic 12mm Thickness
- Handle all Outdoor Weather Environments
- LED's are Pre-Mounted and Ready to Install
- Rings are Supplied with a Weather-Proof Connector
- Outer Edges are Frosted for a Consistent Glow Effect
- Made to Fit APSW-6032 6.5" Coaxial Marine Speaker

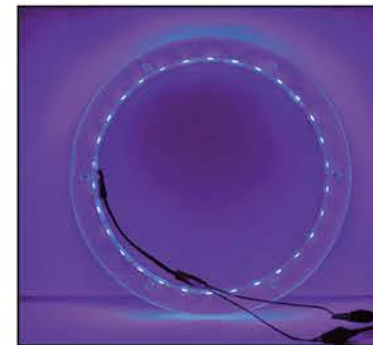

SPEAKER NOT INCLUDED

NL-R11050-RGB

10.5" LED SPEAKER RINGS

- Durable Acrylic 12mm Thickness
- Handle all Outdoor Weather Environments
- LED's are Pre-Mounted and Ready to Install
- Rings are Supplied with a Weather-Proof Connector
- Outer Edges are Frosted for a Consistent Glow Effect
- Made to Fit APSW-6032 6.5" Coaxial Marine Speaker

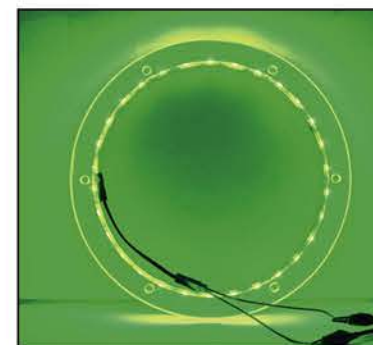

SPEAKER NOT INCLUDED



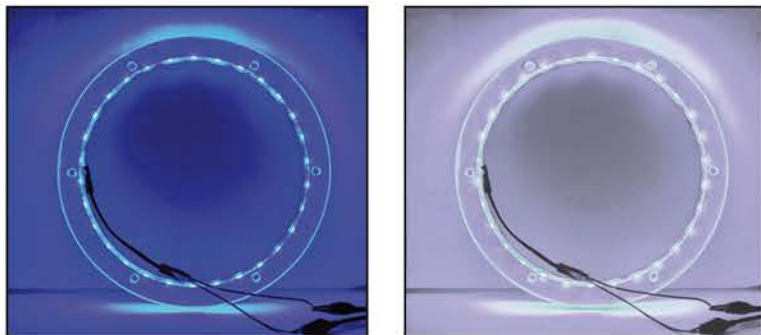

**NL-R18850 BLU / NL-R18850 WHT**

8.8" BLUE LED SPEAKER RINGS

- Durable Acrylic 12mm Thickness
- Handle All Outdoor Weather Environments
- LED's are Pre-Mounted and Ready to Install
- Rings are Supplied with a Weather-Proof Connector
- Outer Edges are Frosted for a Consistent Glow Effect
- Made to Fit: MX880-CCX-CG-WH (JL AUDIO)



SPEAKER NOT INCLUDED

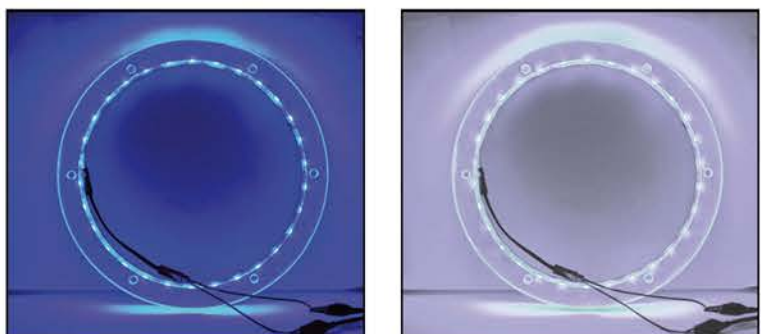

**NL-R11000 BLU / NL-R11000 WHT**

10" BLUE LED SPEAKER RINGS

- Durable Acrylic 12mm Thickness
- Handle All Outdoor Weather Environments
- LED's are Pre-Mounted and Ready to Install
- Rings are Supplied with a Weather-Proof Connector
- Outer Edges are Frosted for a Consistent Glow Effect
- Made to Fit JL Audio MX101B3-SG-WH



SPEAKER NOT INCLUDED

**NL-RIAPMB-6 BL**

6" BLUE LED SPEAKER RINGS

- UV protection
- Durable acrylic 12mm thickness
- Handles all outdoor weather environments
- LED's are pre-mounted and ready to install
- Rings are supplied with a weather proof connector
- Outer edges are frosted for a consistent glow effect
- Ring inner dimension: 5.75"
- Ring outer dimension: 7"

Compatible with  
APMB 6" Series



SPEAKER NOT  
INCLUDED

INCLUDES  
TWO rings



**NL-RIAPMB-6 WH**

6" WHITE LED SPEAKER RINGS

- UV protection
- Durable acrylic 12mm thickness
- Handles all outdoor weather environments
- LED's are pre-mounted and ready to install
- Rings are supplied with a weather proof connector
- Outer edges are frosted for a consistent glow effect
- Ring inner dimension: 5.75"
- Ring outer dimension: 7"

Compatible with  
APMB 6" Series



SPEAKER NOT  
INCLUDED

INCLUDES  
TWO rings



**NL-RIAPMB-8 BL**

6" BLUE LED SPEAKER RINGS

- UV protection
- Durable acrylic 12mm thickness
- Handles all outdoor weather environments
- LED's are pre-mounted and ready to install
- Rings are supplied with a weather proof connector
- Outer edges are frosted for a consistent glow effect
- Ring inner dimension: 7.75"
- Ring outer dimension: 9"

Compatible with  
APMB 8" Series



SPEAKER NOT  
INCLUDED

INCLUDES  
TWO rings



**NL-RIAPMB-8 WH**

6" WHITE LED SPEAKER RINGS

- UV protection
- Durable acrylic 12mm thickness
- Handles all outdoor weather environments
- LED's are pre-mounted and ready to install
- Rings are supplied with a weather proof connector
- Outer edges are frosted for a consistent glow effect
- Ring inner dimension: 7.75"
- Ring outer dimension: 9"

Compatible with  
APMB 8" Series



SPEAKER NOT  
INCLUDED

INCLUDES  
TWO rings





**NL-LBR317-72W**

17" LED LIGHT BAR

- Beam: Spot-Flood Combo
- Operating Voltage: DC 10-30V
- Power: 72W (24 x 3W/pcs High Density LEDs)
- Color Temperature: 6000K
- Lumen: 22000LM
- Lifespan: >30,000 Hours
- Waterproof Rate: IP 67
- Lens Material: PC
- Housing Material: Diecast Aluminum
- Includes Installation Hardware



This Led Light Bar can be used on any vehicle, ATV, SUV, mining boat excavators, Jeep truck tractor and other heavy equipment. It uses the latest LED technology, supplying superior light output and will not drain your battery, saving more energy.



**NL-LBR325-120W**

25" LED LIGHT BAR

- Beam: Spot-Flood Combo
- Operating Voltage: DC 10-30V
- Power: 120W (40 x 3W/pcs High Density LEDs)
- Color Temperature: 6000K
- Lumen: 22000LM
- Lifespan: >30,000 Hours
- Waterproof Rate: IP 67
- Lens Material: PC
- Housing Material: Diecast Aluminum
- Includes Installation Hardware



This Led Light Bar can be used on any vehicle, ATV, SUV, mining boat excavators, Jeep truck tractor and other heavy equipment. It uses the latest LED technology, supplying superior light output and will not drain your battery, saving more energy.



**NL-LBR355-300W**

55" LED LIGHT BAR

- Beam: Spot-Flood Combo
- Operating Voltage: DC 10-30V
- Power: 300W (100 x 3W/pcs High Density LEDs)
- Color Temperature: 6000K
- Lumen: 22000LM
- Lifespan: >30,000 Hours
- Waterproof Rate: IP 67
- Lens Material: PC
- Housing Material: Diecast Aluminum
- Includes Installation Hardware



This Led Light Bar can be used on any vehicle, ATV, SUV, mining boat excavators, Jeep truck tractor and other heavy equipment. It uses the latest LED technology, supplying superior light output and will not drain your battery, saving more energy.



**NL-LBC352**

52" CURVED LED LIGHT BAR

- Beam: Spot-Flood Combo
- Operating Voltage: DC 10-30V
- Power: 288W (96 x 3W/pcs High Density LEDs)
- Color Temperature: 6000K
- Lumen: 22000LM
- Lifespan: >30,000 Hours
- Waterproof Rate: IP 67
- Lens Material: PC
- Housing Material: Diecast Aluminum
- Includes Installation Hardware



This Led Light Bar can be used on any vehicle, ATV, SUV, mining boat excavators, Jeep truck tractor and other heavy equipment. It uses the latest LED technology, supplying superior light output and will not drain your battery, saving more energy.



**NL-LBR333-180W**

33" LED LIGHT BAR

- Beam: Spot-Flood Combo
- Operating Voltage: DC 10-30V
- Power: 180W (60 x 3W/pcs High Density LEDs)
- Color Temperature: 6000K
- Lumen: 22000LM
- Lifespan: >30,000 Hours
- Waterproof Rate: IP 67
- Lens Material: PC
- Housing Material: Diecast Aluminum
- Includes Installation Hardware



This Led Light Bar can be used on any vehicle, ATV, SUV, mining boat excavators, Jeep truck tractor and other heavy equipment. It uses the latest LED technology, supplying superior light output and will not drain your battery, saving more energy.

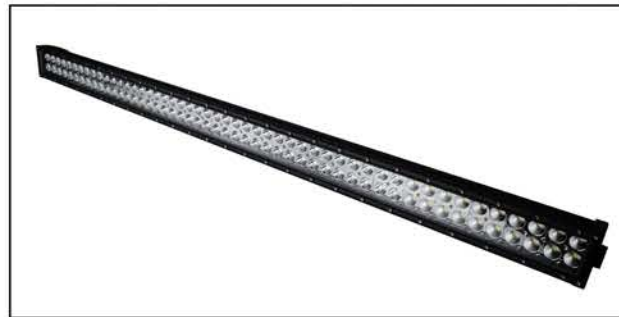

**NL-LBR353-288W**

53" LED LIGHT BAR

- Beam: Spot-Flood Combo
- Operating Voltage: DC 10-30V
- Power: 288W (96 x 3W/pcs High Density LEDs)
- Color Temperature: 6000K
- Lumen: 22000LM
- Lifespan: >30,000 Hours
- Waterproof Rate: IP 67
- Lens Material: PC
- Housing Material: Diecast Aluminum
- Includes Installation Hardware



This Led Light Bar can be used on any vehicle, ATV, SUV, mining boat excavators, Jeep truck tractor and other heavy equipment. It uses the latest LED technology, supplying superior light output and will not drain your battery, saving more energy.



**NL-LBC354**

54" CURVED LED LIGHT BAR

- Beam: Spot-Flood Combo
- Operating Voltage: DC 10-30V
- Power: 300W (100 x 3W/pcs High Density LEDs)
- Color Temperature: 6000K
- Lumen: 22000LM
- Lifespan: >30,000 Hours
- Waterproof Rate: IP 67
- Lens Material: PC
- Housing Material: Diecast Aluminum
- Includes Installation Hardware



This Led Light Bar can be used on any vehicle, ATV, SUV, mining boat excavators, Jeep truck tractor and other heavy equipment. It uses the latest LED technology, supplying superior light output and will not drain your battery, saving more energy.



**NL-LBS326-72W**

26" 72W LED LIGHT BAR

- Voltage: DC 10-30V
- Power: 72W (24pcs x 3W High Intensity LEDs)
- Luminous Flux: 1530 LM
- Color Temperature: 6000K
- Service Life: 50000h
- Waterproof Rate: IP67
- Material: Aluminum Alloy



**INSTALLATION  
HARDWARE INCLUDED**

This Led Light Bar can be used on any vehicle, ATV, SUV, mining boat excavators, Jeep truck tractor and other heavy equipment. It uses the latest LED technology, supplying superior light output and will not drain your battery, saving more energy.

NL-LB303-18W

- 3" 12W CREE LED LIGHT BAR
- Description: Cree LED Light Bar
  - Operation Voltage: 10-30V DC
  - LED Module: 3W/pcs Cree LEDs
  - LENS Material: Tempered Glass
  - Beam: Spot, Flood, Combo
  - Waterproof Level: IP67
  - Color Temp.: 6000K-6500K
  - Housing Material: Aluminum
  - Life Span: >30,000 Hours

**SOLD IN PAIRS**



NL-LBS36-18W

- 6" 18W LED LIGHT BAR
- Voltage: DC 10-30V
  - Power: 18W (6pcs x 3W High Intensity LEDs)
  - Luminous Flux: 1530 LM
  - Color Temperature: 6000K
  - Service Life: 50000h
  - Waterproof Rate: IP67
  - Material: Aluminum Alloy

**INSTALLATION  
HARDWARE INCLUDED**



NL-LBRO-07-51W

- 51W WORK LIGHT
- Power: 51W
  - Voltage: 9-32V
  - Color Temperature: 6500K
  - Lumen: 4000LM
  - Beam: Spot/Flood Epistar



NL-LBOV-43-20W

- 20W LED WORK LIGHT
- Power: 20W
  - Voltage: 9-32V
  - Color Temperature: 6500K
  - Lumen: 1400LM
  - Beam: Spot/Flood



NL-LBSQ-14-27W

- 4" 27W LED LIGHT BAR
- Power: 27W (9pcs x 3W High Intensity LEDs)
  - Lumen: 1980lm
  - Voltage: 9V-36V
  - Color Temperature: 6000K
  - Material: Aluminum
  - Lens: PC
  - Waterproof Rate: IP67
  - Bracket: Stainless Steel Bracket
  - Thickness: 35mm
  - Size: 108mm x 108mm x 35mm



NL-LBMX382-25W

- TRIPLE ROW 4D OFF-ROAD LED LIGHT
- Voltage: 25W
  - Waterproof: 10-30V DC
  - LED Chips: 0.9W Epistar
  - Color Temperature: 6000K
  - Beam: Spot
  - Span Life: >30000 Hours



NL-LBSQ-15-27W

- 5" 27W LED LIGHT BAR
- Voltage: DC 10-30V
  - Power: 27W (9pcs x 3W High Intensity LEDs)
  - Luminous Flux: 1800 LM
  - Color Temperature: 6000K
  - Service Life: 30000h
  - Waterproof Rate: IP67
  - Material: Aluminum Alloy
  - Thickness: 30mm
  - Size: 115mm x 115mm x 30mm



NL-LBSQ-33-10W

- 10W LED WORK LIGHT
- Power: 10W
  - Voltage: 10-30V DC
  - Waterproof Rate: IP 67
  - LED Chips: 2.5W Cree
  - Color Temperature: 6000K
  - Lumen: 880 LM
  - Beam: Spot / Flood
  - Span Life: 50000 Hours



NL-LBSQ874D-10W

- 10W LED WORK LIGHT
- Power: 10W
  - Voltage: 10-30V DC
  - Waterproof Rate: IP 67
  - LED Chips: 2.5W Cree
  - Color Temperature: 6000K
  - Lumen: 880 LM
  - Beam: Spot / Flood
  - Span Life: 50000 Hours



NL-LBSTRQ-15-27W

- 5" 27W LED LIGHT BAR
- Voltage: DC 10-30V
  - Power: 27W (9pcs x 3W High Intensity LEDs)
  - Luminous Flux: 1800 LM
  - Color Temperature: 6000K
  - Service Life: 30000h
  - Waterproof Rate: IP67
  - Material: Aluminum Alloy
  - Thickness: 45mm
  - Size: 115mm x 115mm x 45mm



MLD-1200

- MARINE DECK FLOOD LIGHT
- Voltage: 12 to 24 VDC
  - Current: 900ma @ 12VDC; 450ma @ 24VDC
  - High Intensity White LED Lighting
  - 80% Less Consumption than a Halogen Bulb
  - Die Cast Aluminum Housing with Complete Mounting Hardware
  - Casing is Completely Sealed IP67 Compliant



12V/24V  
DC Voltages

Ultimate  
Corrosion  
Resistance

CHEMICAL & CLEANER SPRAYS

# INSTALLATION

## 402A-285G

### SUPER DUSTER 134 PLUS

- 10 Oz. Super Duster
- Removes Microscopic Dust, Lint and Foreign Particles. Cleans Computers and Keyboards, Photographic and Audio-Video Equipment, Coin Counters, Printers Timing Devices, Cash Machines, Optical Equipment, Fax Machines and other Electro Mechanical Instruments. High Rate of Flow Delivery Systems for Increased Performance



## 403A-285G

### SUPER COLD 134 PLUS

- 10 Oz. Chemical Spray
- Locates Thermal Intermittent Electrical Components
- Protects Heat-Sensitive Components During Soldering
- Freezes Gums and Adhesives for Easy Removal
- Chills to -51°C (-60°F). Chills to -51°C (-60°F).



## 409B-140G

### ELECTROSOLVE CONTACT CLEANER / ZERO RESIDUE

- 5 Oz. Electrosolve Contact Cleaner
- Cleans Connectors, Contacts, LED's, PCB's, Components, Circuits and Microprocessors

Contains Isohexane. Use when a Zero Residue Contact Cleaner is Required. An Effective and Powerful Cleaner that Quickly Penetrates and Dissolves Most Soil Types. For Use on Most Electronic Parts and Equipment Including Connectors, Contacts, LED's, PCB's, Components, Circuit Breakers, Tuners and Microprocessors



## 419C-340G

### ROSIN CORED SOLDER WIRE

- 12 Oz. Acrylic Lacquer Conformal Coating
- Provides an All-Around Protective Coating for Printed Circuit Boards against Moisture, Corrosion, and Thermal Shock
- Protects and Insulates Electrical and Electronic Components and Assemblies, Including Generators, Motors, Transformers, Relays, and Solenoid Coils
- Clear Tough Protective Coating
- Protects Against Static Discharge
- Service Temperature Limits: 105°C
- Solids by Volume: 18%
- Solids by Weight: 25%
- Viscosity: 50-55, 20-25 Sec.s NBR
- Easy to Repair



## INSTALLATION

### ACCESSORIES

#### MV-30V

DIGITAL VOLTMETER

- Product Size: 48\*29\*21mm.
- Mounting Cutout: 45.5 \* 26.5 mm.
- Voltage Test Range: 4.5-30V



#### MVA-100V

DC 100V 100A VOLTAGE VOLTMETER AMMETER 2 IN 1  
VOLT AMP DUAL DISPLAY PANEL METER WITH CURRENT SHUNT

- Size: 48mm x 29mm x 21mm
- Mounting Cutout: 45.5mm x 26.5mm
- Display Color: Red & Blue LED (Dual Display)
- Display: 0.28" LED Digital
- Operating Voltage: DC 4.5 ~ 30V
- Measure Voltage: DC 0 ~ 100V
- Minimum Resolution (V): 0.1V
- Refresh Rate: ≥500ms / times
- Measure Accuracy: 1% (± 1 Digit)
- Minimum Resolution (A): 0.01A
- Operating Current: <20mA
- Measure Current: 100A (with Current Shunt)
- Operating Temperature: -10 to 65°C
- Operating Humidity: 10 to 80% (Non-Condensing)



#### MVT-230C

DIGITAL THERMOMETER (CELSIUS)

- LCD Size: 1.4" x 0.6" (36x16mm)
- Power Source: 2 x LR44
- Cable Length: 3'/1M
- Meter Size: 1.9" x 1.1" x 0.6" (47.8 x 28.5 x 14.3mm)
- Mounting Cutout: 1.8" x 1.1" (46.2 x 26.7mm)
- Temperature Measurement Range: -5°C~110°C
- Operating Temperature: -5°C~50°C



*Digital thermometer equipped with a waterproof probe that can test both outer and inner temperatures of various electronic equipment.*



**EXTRA BATTERIES INCLUDED (QTY. 4)**

#### MVT-230F

DIGITAL THERMOMETER (FAHRENHEIT)

- LCD Size: 1.4" x 0.6" (36x16mm)
- Power Source: 2 x LR44
- Cable Length: 3'/1M
- Meter Size: 1.9" x 1.1" x 0.6" (47.8 x 28.5 x 14.3mm)
- Mounting Cutout: 1.8" x 1.1" (46.2 x 26.7mm)
- Temperature Measurement Range: -58°F~166°F
- Operating Temperature: 23°F~122°F



*Digital thermometer equipped with a waterproof probe, can test the temperature of both outdoor and indoor places, such as refrigerator, fish tank or even the water temperature and body temperature.*



**EXTRA BATTERIES INCLUDED (QTY. 4)**

## INSTALLATION

### SOLDERING IRON PENS



#### 77B20-100W

PENCIL SOLDERING IRON

- 100W Industrial Soldering Iron Pen
- 110V
- Wooden Handle
- Common Tip



#### 77B20-150W

PENCIL SOLDERING IRON

- 150W
- 110V
- Wooden Handle
- Common Tip
- Works for Household Electrical Appliances
- This 150W Soldering Iron is Ideal for Soldering Copper and Steel



#### 76B40W-LED

PENCIL SOLDERING IRON

- 40Watts
- 110V
- Common Tip
- Stainless Steel Tube
- Copper Welding Head

LED Lights  
CE RoHS



#### 78B40 (40Watts)

#### 78B60 (60Watts)

#### 78B80 (80Watts)

PENCIL SOLDERING IRON

- 110V
- CE Approved
- Long Life Tip



#### KTB-30 (30 Watts)

#### KTB-40W (40 Watts)

#### KTB-60 (60 Watts)

PENCIL SOLDERING IRON

- 110V
- Common Tip
- Radio Controls, Hobbies, Crafts and Small Electrical Parts



**79B20-200W**

- PENCIL SOLDERING IRON
- 110V
  - 200 Watts
  - Work for House Appliances
  - Long Life Tip



**79B21-30W**

- PENCIL SOLDERING IRON
- 110V
  - 30 Watts
  - Radio Controls, Hobbies and Crafts, Small Electrical Parts
  - Long Life Tip



**71B30KT**

- PENCIL SOLDERING IRON
- For Welding a Wide Variety of Materials
  - AC Operated
  - 30W / 110V
  - Common Tip
  - For Electronics and Electrical Applications
  - Base Includes Security for the Metallic End



**74B30**

- PENCIL SOLDERING IRON
- 30W
  - 110V
  - 4mm Diameter
  - Slim Design
  - Common Tip
  - Radio Controls, Hobbies and Crafts, Small Electrical Parts



**79B65-30W (30 Watts)**

**79B65-40W (40 Watts)**

**79B65-60W (60 Watts)**

- PENCIL SOLDERING IRON
- 110V
  - Slim Design
  - Radio Controls, Hobbies and Crafts, Small Electrical Parts
  - Long Life Tip



**79B65-40W-220V (40 Watts)**

**79B65-60W-220V (60 Watts)**

- PENCIL SOLDERING IRON
- Industrial Soldering Iron Pen
  - 220V
  - Wooden Handle
  - Long Life Tip



**74B55**

- PENCIL SOLDERING IRON
- 30W
  - 110V
  - 4mm Diameter
  - Common Tip
  - Radio Controls, Hobbies and Crafts, Small Electrical Parts



**74B70**

- PENCIL SOLDERING IRON
- 40W
  - 110V
  - 4m Diameter
  - Long Life Tip
  - Radio Controls, Hobbies and Crafts, Small Electrical Parts, Household Electrical Appliances, Capacitors, etc.

# INSTALLATION

## SOLDERING IRON PENS

# INSTALLATION

## SOLDERING ACCESSORIES



### 74B70-60W

PENCIL SOLDERING IRON

- 60W Soldering Iron Pen
  - 110V
  - 4m Diameter
  - Long Life Tip
- Radio Controls, Hobbies and Crafts, Small Electrical Parts, Household Electrical Appliances, Capacitors, Etc.



### 76D12-40W

12V PORTABLE 40WATT SOLDER IRON

- Ultra-Slim Textured Handle for Added Grip and Comfort
- 12V / 40W
- Long Life Tip



### 77B20-30W

PENCIL SOLDERING IRON

- 4mm Diameter
  - Slim Design
  - 30W / 110V
  - Common Tip
- Radio Controls, Hobbies and Crafts, Small Electrical Parts



### 77B20-40W

PENCIL SOLDERING IRON

- 40W Industrial Soldering Iron Pencil
  - 110V
  - Wooden Handle
  - Common Tip
- Radio Controls, Hobbies and Crafts, Small Electrical Parts, Household Electrical Appliances, Capacitors, Etc.



### 77B20-60W

PENCIL SOLDERING IRON

- 60W Industrial Soldering Iron Pencil
  - 110V
  - Wooden Handle
  - Common Tip
- Radio Controls, Hobbies and Crafts, Small Electrical Parts, Household Electrical Appliances, Capacitors, Etc.



### KD-55

- Replacement Tip for 74B55
- Common Tip



### KD-70

- Replacement Tip for 74B70
- Long Life Tip

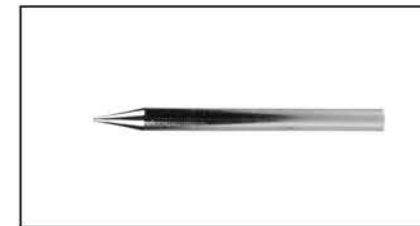

### KD-KTB-60

- Replacement Tip for KTB-60
- Common Tip



### KD-KTB-3040

- Replacement Tip for KTB-30, KTB-40
- Common Tip



### KD-100SS

- Replacement for 79B100SS, 74B70 30W, 74B70 40W
- High-Quality Tip



### P-654

- Replacement Solder Tip for 79B65-30W, 79B65-40W
- Long Life Tip



### P-656

- Replacement Solder Tip for 79B65-60W
- Long Life Tip

### P-1 (for 74B30)

- Common Tip

### P-720 (for 77B20)

- Common Tip

### P-750 (for 77B50)

- Common Tip

### P-791 (for 79B21-30W)

- Long Life Tip

### P-795 (for 77B95)

- Long Life Tip



# INSTALLATION

## SOLDERING ACCESSORIES



### 6AS-WRST5

#### ANTI-STATIC WRIST STRAP

- Anti-Static Wrist Strap
- Current Limiting Resistor  $1M\Omega \pm 5\%$
- Electro-Scattering Time: 0.1 Sec
- Adjustable Grounding
- Suitable for Use in Electronic Repair Shops



### 74B23 (110V)

#### SOLDERING HEAVY DUTY 100W / Common Tip

Uses Weller "Closed Loop" Method of Controlling Maximum Tip Temperature. Portable Line Voltage Iron - No Base Station Required  
Stainless Steel Modular Plug-In Heater, Greater Efficiency & Versatility  
Temperature is Controlled by Tip (600° F, 700° F & 800° F Tips)  
Nominal Heat-Up Time with 700° F Tip is 110 Seconds



### 76B8-PRT

#### PORTABLE SOLDERING IRON

- Super Fast Heat-Up: Heats Up to Working Temperatures in less than 15 Seconds
- Cordless for Ultimate Field Portability
- Tip Reaches Up to 900°F to Handle Standard Duty Applications
- Kit Includes: Safety Cap, Lead-Free Solder and Tip tool
- Long Life Tip



### 79B100SS

#### SOLDERING IRON STATION

- Adjustable Soldering Iron Station 110-130V
- Variable Temperature Control 100°C-450°C
- Sturdy Compact Design
- On-Off Switch with Power-On Indicator Light
- Safety Guard Iron Holder
- High-Quality Tip



### MAT-7400

#### TECHNICIANS REPAIR WORK MAT

Anti-Static Mat  
Protect your Electronic Devices. Transfers Static Charges from Work Surface to Ground



### HH-1

#### DUAL HELPING HANDS

- Holds Work in any Position Leaving Hands-Free for Soldering

# INSTALLATION

## SOLDERING ACCESSORIES



### HH-2

#### SOLDERING STAND

- Acid-Free
- Non-Toxic Cellulose Tip Cleaning Sponge



### HH-3MG

#### THIRD HAND TOOL WITH SOLDER STAND

- Third-Hand Tool with Magnifying Glass
- Holding Clamps Adjustable in Many Ways
- Sturdy Stand



### HH-4DS

#### SOLDERING STAND & HOLDER

- Soldering Iron Stand and Holder
- With Solder Feeder and Sponge
- Safety Outer Metal Holder
- Holds up to 2 lb. Roll of Soldering Wire
- Tip Cleaning Special Sponge



### KD-100

REPLACEMENT TIP FOR NBW-100



### KD-200

REPLACEMENT TIPS FOR NBW-200



### KD-33

REPLACEMENT TIP FOR 74B33



### KD-40

REPLACEMENT TIP FOR NBW-74



# INSTALLATION

## SOLDERING ACCESSORIES



**KD-50**  
REPLACEMENT TIP FOR NBW-50

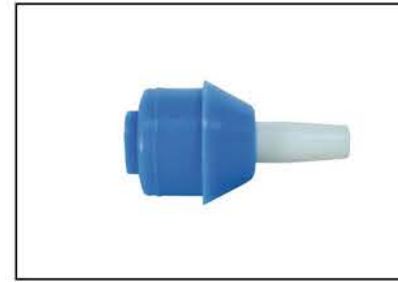

**KD-85**  
REPLACEMENT TIP FOR NBW-85



**SP-10** (10 grams)  
SOLDER PASTE 10 GRAMS  
• In Plastic Case

**SP-50** (50 grams)  
SOLDER PASTE 50 GRAMS  
• In Plastic Case



**SP-15**  
SOLDER PASTE 15 GRAMS W/P



**W-1**  
DESOLDERING WIRE 5'

**40/60 1LB**  
**60/40 1LB**  
• Rosin Core Solder Wire  
• 1 lb. Spool  
• 0.8 Diameter



**60-40 1.0MM**  
• 60% Rosin Core  
• 40% Lead  
• Diameter: 1.0mm  
• Net Weight: 1lb



**60/40/06**  
• Rosin Core Solder Wire  
• 1 lb. Spool  
• Ø 0.6 mm

**60/40/12**  
• Rosin Core Solder Wire  
• 1 lb. Spool  
• Ø 1.2 mm



**40/60 1/2LB**  
**60/40 1/2LB**  
• Rosin Core Solder Wire  
• 1/2 lb. Spool  
• 0.8 Diameter

**60/40 PEN**  
**40/60 PEN**  
• Rosin Core Solder Wire  
• Pen Type  
• 0.8 Diameter



# INSTALLATION

## SOLDERING ACCESSORIES



**NBW-50**  
DESOLDERING SUCKER TOOL  
• Plastic Desoldering Pump  
• 7.5"  
• Changeable Teflon Tip



**NBW-74**  
DESOLDERING SUCKER TOOL  
• Metal Desoldering Pump  
• 7.5"  
• Changeable Teflon Tip

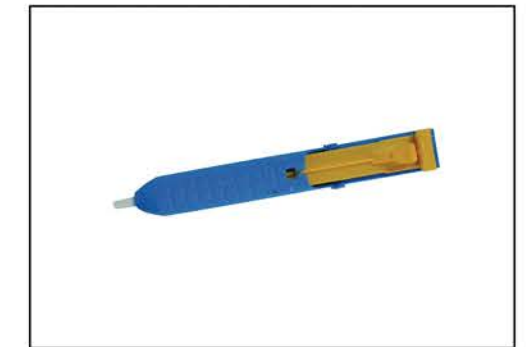

**NBW-85**  
LARGE DESOLDERING SUCKER TOOL  
• Large Desoldering Pump  
• 8"  
• Changeable Teflon Tip

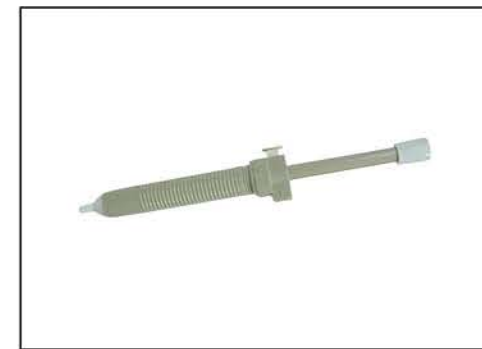

**NBW-100**  
LARGE DESOLDERING SUCKER TOOL  
• 10"  
• Changeable Teflon Tip

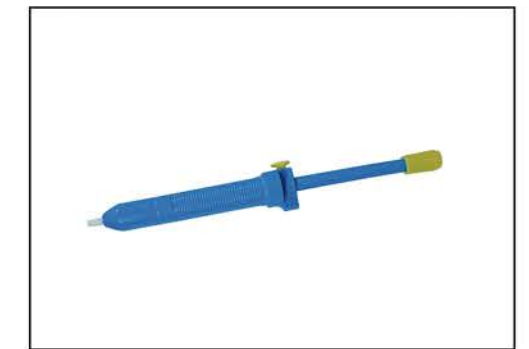

**NBW-200**  
EXTRA LARGE DESOLDERING SUCKER TOOL  
• 13"  
• Changeable Teflon Tip

# INSTALLATION

## ACCESSORIES



**IDCR-132**  
T-TAP NYLON TERMINAL  
• 18-14 Gauge  
• Yellow  
• Package of 100



**IMPU-175**  
TELESCOPING 6.5  
• Magnetic Pick Up Tool 6 1/2

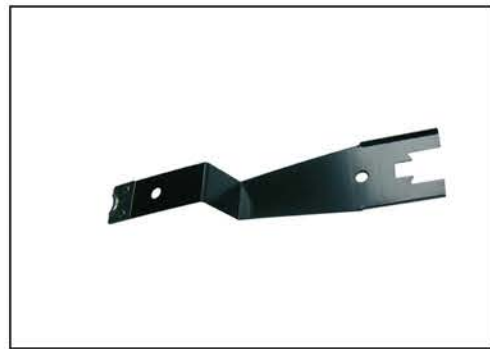

**IWCR-095**  
MANUAL WINDOW CRANK CLIP REMOVER  
• Manual Window Crank Clip Remover

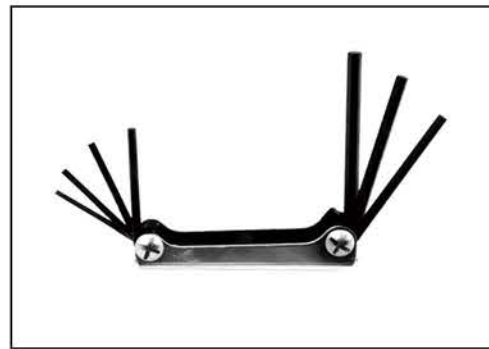

**IHKM-307**  
FOLDING HEX KEY SET  
• 7 Piece Folding Hex Key Set  
• 1.5, 2, 2.5, 3, 4, 5, 6mm Sizes

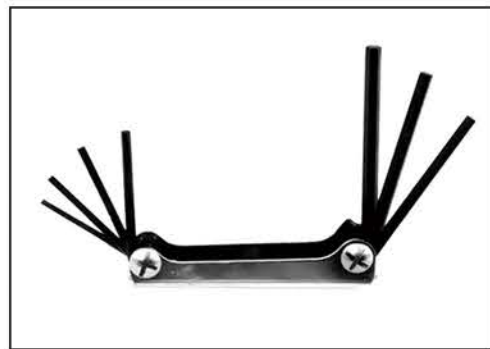

**IHKS-307**  
FOLDING HEX KEY SET  
• 7 Piece Folding Hex Key Set  
• 1/16", 5/64", 3/32", 1/8", 5/32", 3/16", 7/32" Sizes



**IHPM-307**  
7 PCS FOLDING HEX KEY SET  
1.5, 2, 2.5, 3, 4, 5, 6mm

# INSTALLATION

## DIGITAL MULTIMETERS



**IS-HHM95**  
• DCV: 0-2-20-200-1000V (1M $\Omega$ )  $\pm$  0.5%  
• ACV: 0-200m-2-20-200-750V (450K $\Omega$ )  $\pm$  1.2%  
• DCA: 2m-20m-200m-20A  $\pm$  (0.8% + 3)  
• ACA: 2m-20m-200m-20A  $\pm$  (0.8% + 10)  
• Impedance: 10m $\Omega$   
• Continuity Beep  
• Indicated Over Range  
• Diode Test



**IS-HHM95TF**  
• DCV: 0-2-20-200-1000V (1M $\Omega$ )  $\pm$  0.5%  
• ACV: 0-200m-2-20-200-750V (450K $\Omega$ )  $\pm$  1.2%  
• DCA: 2m-20m-200m-20A  
• ACA: 2m-20m-200m-20A  
• Impedance: 10m $\Omega$   
• Temperature Test: -40°C - 1000°C  
• Continuity Beep  
• Indicated Over Range  
• Does Not Include Battery



**IS-HHM5708**  
Digital Auto Range Multimeter  
• DCV: 0-500V $\pm$  (1%+2)  
• ACV: 0-500V $\pm$  (1%+3)  
• DCA: 0-10A  $\pm$  (2%+3)  
• ACA: 0-10A  $\pm$  (1.2%+3)  
• OHM: 0-20M  $\Omega$   $\pm$  (2%+3)  
• Continuity Beep  
• Auto Range & Power Off  
• Diode Test  
• Data Hold  
• Maximum Display: 1999  
• Power: 3V



• Dimensions: 4.3" x 2.4" x 0.5"  
• Weight: Approx 0.13 lb  
(60 g included Battery)



**IS-HHM300**  
Handheld Multimeter  
• DCV: 2-500V $\pm$  (0.5%+1)  
• ACV: 2-500V $\pm$  (1.2%+10)  
• DCA: 0-200mA  $\pm$  (2%+2)  
• OHM: 2-2000 K $\Omega$   $\pm$  (1%+2)  
• Continuity Beep  
• Diode Test  
• Power: 12V  
• Dimensions: 2.8" x 4.7" x 0.7"  
• Weight: Approx 0.24 lb (110 g included Battery)



**IS-HHM-16DCI**  
• DCV: 0-1000V  $\pm$  (1%+1)  
• ACV: 0-750V  $\pm$  (2%+3)  
• DCA: 0-200A  $\pm$  (2%+3)  
• ACA: 0-200A  $\pm$  (2.5%+3)  
• OHM: 0-40m $\Omega$   $\pm$  (1.5%+2)  
• Continuity Beep  
• Frequency Test  
• Capacitance Test  
• Diode Test



**IS-HHM26ACI**  
Digital Multimeter with AC Clamp Meter  
• DCV: 0-1000V  $\pm$  (0.5% + 1)  
• ACV: 0-750V  $\pm$  (1% + 4)  
• ACA: 0-1000A  $\pm$  (2% + 5)  
• OHM: 200-20K $\Omega$   $\pm$  (2% + 2)  
• Continuity Beep  
• Maximum Display: 1999  
• Does Not Include Battery



**1999**  
Maximum display

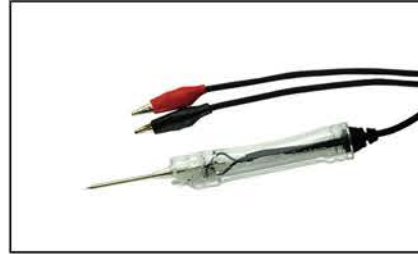

**IS-ICTL-1224V**

12/24V CIRCUIT TESTER

- Ergonomic Grip Design with 6 Ft. Test Leads
- Bright White LED Illuminates Troubleshooting Area
- Transparent Handle Shows Bright LED's to Identify Connections
- Blue = Ground Present
- Red = Voltage Present
- Helps to Quickly Identify if there is Voltage Present on Wiring and Circuits



**ICT-112**

HEAVY DUTY CIRCUIT TESTER

- Heavy Duty Circuit Tester
- Checks 6, 12, & 24 Volt Circuits
- Supplied with 60" Cable



**ICT-115LED**

LED Circuit Tester

- Quickly checks all 6 & 12 Volts Systems
- Supplied with Long 47" / 1.2M Cable
- Strong Alligator Lead Clip
- Test Short / Open Circuit
- With Red LED



**NT-PHASE**

SPEAKER PHASE FOR SPEAKER

- This Polarity/Phase Tester Utilizes State of the Art Signal Processing to Accurately Determine Absolute Polarity, which is Unimpaired by Passive Crossovers or Signal Waveform Distortions Produced by the Device Under Test. It Works with Tweeters, Midranges and Woofers, Subwoofer Speakers and Cabinets, plus Equalizers, Amplifiers and Crossovers



**NT-TONEG**

tone GENERATOR FOR TESTING SPEAKERS

- This Compact Tone Generator is Great for General Tests and Troubleshooting of Virtually any Audio Installation including Automotive, Residential and Distributed Commercial Systems. Line Level Audio Output is High Enough to Drive Home Theatre, Auto Sound and Pro Sound Inputs, and Speaker Level Output Delivers over 1W Signal



**ST-7**

MINI TYPE CAPACITOR MULTIMETER

- DCV: 0-2.5-10-50-250-500V
- ACV: 0-10-50-250-500-1000V
- DEC: -10 to +25dB
- Battery: 1.5V

**D-266**

DIGITAL CLAMP TYPE MULTIMETER

- DCV: 1000V ± (0.5% + 1)
- ACV: 750V ± (1% + 4)
- ACA: 200A-1000A ± (2% + 5)
- OHM: 200-20KW ± (2% + 2)
- Insulation Test
- Data Hold



**ST-385**

STANDARD CAPACITOR MULTIMETER

- DCV: 0-0.1-0.5-2.5-10-50-250-1000V
- ACV: 0-10-50-250-1000V
- DEC: -8 to +62dB
- Battery: 1.5V x 2, 9V x 1



**ST-5077**

DIGITAL MULTIMETER

- DCV: 200m-1000V
- ACV: 200-750-1000V
- DCA: 200µA-10A
- OHM: 200-2000K Ohms
- Battery: 9V

**ST-902**

AC VOLTAGE TESTER

- Sound and Light Instructions
- Adjustable Sensitivity
- Setting the Default Sensitivity
- Wireless AC Voltage Tester
- Designed to International Safety Standard: EN61010-1/ 600V CAT III
- Battery: AAA





ST-4068CT

- Digital Multimeter
- DCV: 200mV-500V ± (0.5% + 2)
- ACV: 200V-500V ± (1.2% + 10)
- DCA: 2000uA-10A ± (1% + 2)
- OHM: 200W-2mW ± (0.8% + 2)
- Continuity Buzzer
- Diode Test
- Data Hold for Easy Reading



ST-4300CT

- Digital Multimeter
- DCV: 200mV-1000mV ± (0.5%+1)
- ACV: 2V-750V ± (0.8%+3)
- DCA: 2mA-20A ± (1.0%+5)
- ACA: 200mA-20A ± (1.5%+5)
- OHM: 200W-20mW ± (0.8%+3)
- Continuity Buzzer
- Diode Test
- Transistor Test



ST-5505

- Digital Multitester
- DCV: 200m-2-20-200-1000V
- ACV: 2-20-200-700V
- DCA: 2m-20m-200m-20A
- ACA: 200m-20A
- OHM: 200-2K-20K-200K-2M-20M Ohm
- Large LCD Display



IS-HHM53L

- DCV: 200mV-2-20-200-600V
- ACV: 200-600V
- DCA: 200µA-2mA-20-200mA-10A
- Resistance: 200Ω-2k-20k-200k-2MΩ
- Transistor Test
- Diode Test
- Data Hold for Easy Reading
- Does Not Include Battery



IS-HHM75

- DCV: 200mV-2-20-200-1000V
- ACV: 200mV-2-20-200-700V
- DCA: 20µ-200µ-200m-20A
- ACA: 2m-20m-20m-200m-2-10A
- Resistance: 200-2k-20k-200k-2M-200MΩ
- Continuity Buzzer
- Auto Power OFF
- Automatic Over Range Indication
- Does Not Include Battery



IS-HHM-95TF

DIGITAL MULTIMETER W/ TEMPERATURE SENSOR

- DCV: 0-2-20-200-1000V (1MΩ) ± 0.5%
- ACV: 0-200m-2-20-200-750V (450KΩ) ± 1.2%
- DCA: 2m-20m-200m-20A
- ACA: 20m-200m-20A
- Impedance: 10mΩ
- Temperature Test: -40°C~ 1000°C
- Continuity Buzzer
- Indicated Over Range
- Diode Test
- Capacitance Test
- Transistor Test
- Battery Not Included



ST-PC23-CPR

PROTOTYPING PCB PRINTED CIRCUIT BOARD

- Material : FR-4
- Size of Board: 5X7.5cm (2X3")
- Thickness: 1.5mm
- QTY: Each Bag Includes 5pcs

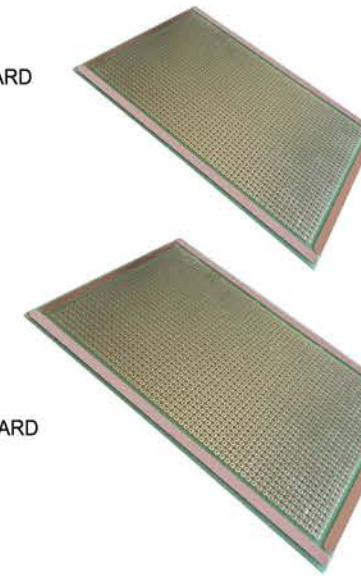

ST-PC46-CPR

PROTOTYPING PCB PRINTED CIRCUIT BOARD

- Material : FR-4
- Size of Board: 10X15cm (4X6")
- Thickness: 1.5mm
- QTY: Each Bag Includes 5pcs

EPB-64

SOLDERLESS BREADBOARD PROTOTYPE

- Material: ABS

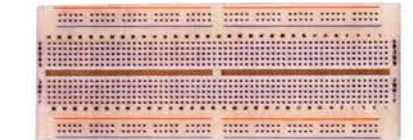

ST-SB32-ABS

SOLDERLESS BREADBOARD PROTOTYPE

- Material: ABS
- 1pc Terminal Strip, Tie-Point 630
- 2pcs Distribution Strips, Tie-Point 100
- Binding Post: None
- Board: 5X7.5cm (2X3")
- Thickness: 0.85cm
- Metal Plate: None



ST-SB73-ABS

SOLDERLESS BREADBOARD PROTOTYPE

- Material: ABS
- 2pcs Terminal Strips, Tie-Point 1260
- 1pc Distribution Strip, Tie-Point 100
- 2pcs Binding Posts
- Board: 16.6\*7.95cm(7X3")
- Thickness: 0.85cm
- Metal Plate: 21.3\*10.5\*0.12cm



ST-SB74-ABS

SOLDERLESS BREADBOARD PROTOTYPE

- Material: ABS
- 2pcs Terminal Strips, Tie-Point 1260
- 3pcs Distribution Strips, Tie-Point 300
- 3pc Binding Posts
- Size of Board: 16.6\*9.85 (7X4")
- Thickness: 0.85cm
- Metal Plate: 21.3\*13\*0.12cm

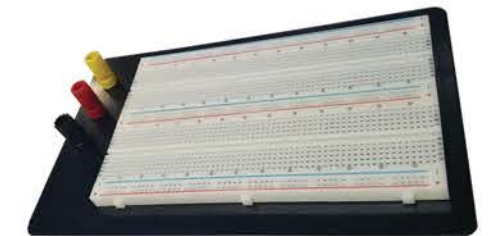

ST-BB23-CPR

SOLDERABLE COPPER PCB BOARD

- 0.042" hole diameter
- 0.1" spacing
- Copper clad
- Size: 2" wide x 3" long x 1/16" thick
- 5 pcs per unit

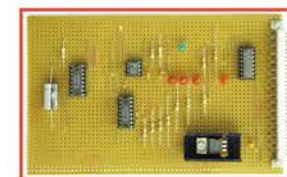

COPPER  
504 - POINT



1UNIT=5PCS

ST-BB46-CPR

SOLDERABLE COPPER PCB BOARD

- 0.042" hole diameter
- 0.1" spacing
- Copper clad
- Size: 4" wide x 6" long x 1/16" thick
- 5 pcs per unit

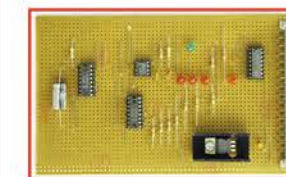

COPPER  
2,204 - POINT

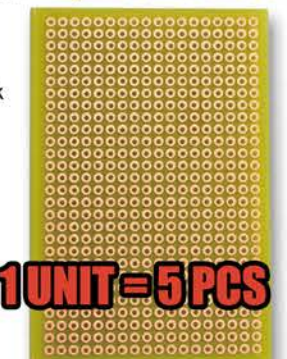

1UNIT=5PCS

A PCB (Printed Circuit Board) is a board used to electrically connect and mechanically support components using pads, conductive tracks and several other features etched from sheets of copper laminated onto non-conductive substrates. They are perfect for electronics projects that require a small circuit board. On one side of the board there are copper rings around each hole for temporary circuit testing

# INSTALLATION

## LED LIGHTS

### LED-5M-B4K-3BR

Blue: VF: 3.0-3.2 WL:460-465 MCD: 3000-4000  
 Red: VF: 1.8-2.0 WL:620-625 MCD: 1000-2000  
 • Bag: 100 Pcs

### LED-5M-3H-3BLU

Blue: VF: 3.0-3.4 WL:460-465 MCD: 200-300  
 • Bag: 100 Pcs

### LED-5M-4K-3GRN

Green: VF: 3.0-3.4 WL:520-525 MCD: 3000-4000  
 • Bag: 100 Pcs

### LED-5M-2H-3RED

Red: VF: 1.8-2.2 WL:620-625 MCD: 100-200  
 • Bag: 100 Pcs

### LED-5M-4H-3YLW

Yellow: VF: 1.8-2.2 WL:586-590 MCD: 300-400  
 • Bag: 100 Pcs

### LED-5M-14K-3WHT

White: VF: 3..2-3.4 MCD: 12000-14000  
 • Bag: 100 Pcs

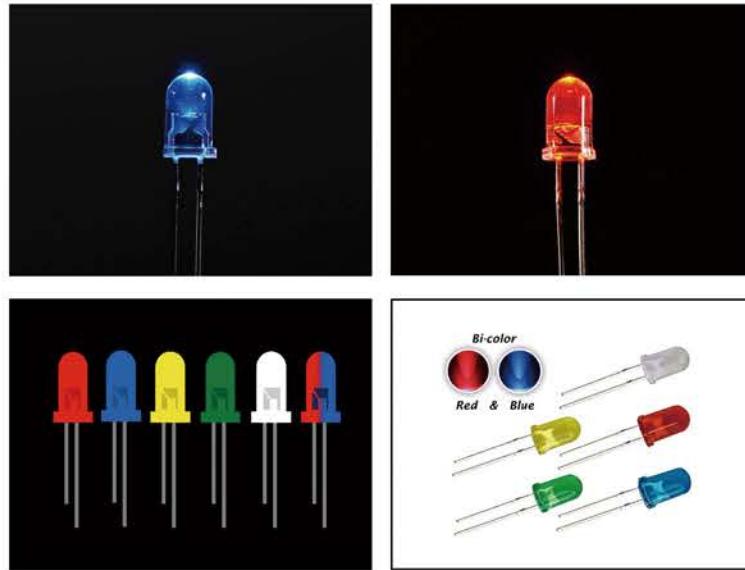

### ST-JW65MM

140PCS OF 22AWG SOLID WIRES  
 • Pre-Cut, Pre-Stripped and Pre-Formed on Each End  
 • Various Colors  
 • Completely Reusable  
 • 14 Length / 10 Pcs Each  
 (2.5/5.1/7.7/10.3/12.7/15.3/17.8/20.1  
 22.8/25.4/51.3/76.3/101.3/126.3mm)

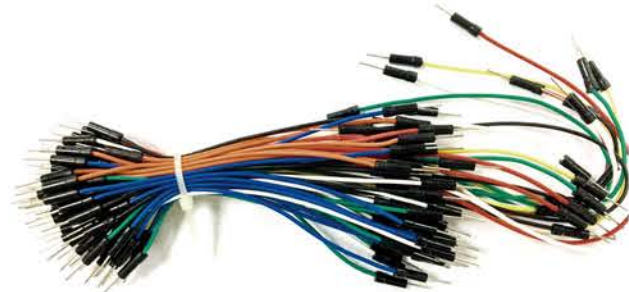

### BUZ-324-82DB

ELECTRIC BUZZER WITH WIRE  
 • Maximum input Voltage: 3-24VDC  
 • Operating Temperature Range: -20 °C ~ +60°C  
 • Storage Temperature Range: -30 °C ~ +70°C  
 • Sound Pressure Level: 82dB at 12vdc/30mm  
 • Resonant Frequency: 3.7±0.5KHz  
 • Max. Rated Current: 100mA at 12VDC  
 • Tone Nature: Continuous



### BUZ-324-85

ELECTRIC BUZZER WITH WIRE  
 • Maximum input Voltage: 3-24VDC  
 • Operating Temperature Range: -20°C ~ +60°C  
 • Storage Temperature: -30°C ~ +70°C  
 • Sound Pressure Level: 82dB at 12VDC/30mm  
 • Resonant Frequency: 3.7 ± 0.5KHz  
 • Max Rated Current: 100mA at 12VDC  
 • Tone Nature: Continuous



# INSTALLATION

## POLYOLEFIN HEAT SHRINK TUBING



### HTSK-2422

1/8" POLYOLEFIN HEAT SHRINK TUBING (8 Pieces)  
 • 24-22 Gauge  
 • 2:1 Shrink Ratio  
 • I.D. Shrinks 1/8" to 1/16" Recovered  
 • Flame Retardant, VW-1  
 • Shrink Temp: 70°C (158°F)  
 • Operating Temp: -55°C thru 125°C (-67°F thru 257°F)



### HTSK-2826

3/32" POLYOLEFIN HEAT SHRINK TUBING (8 Pieces)  
 • 16-12 Gauge  
 • 2:1 Shrink Ratio  
 • I.D. Shrinks 3/32" to 3/64" Recovered  
 • Flame Retardant, VW-1  
 • Shrink Temp: 70°C (158°F)  
 • Operating Temp: -55°C thru 125°C (-67°F thru 257°F)

### HTSK-2422-RL100

I.S. 100' ROLL POLYOLEFIN HEAT SHRINK TUBING  
 • 24-22 Gauge  
 • 2:1 Shrink Ratio  
 • I.D. Shrinks 1/8" to 1/16" Recovered  
 • Flame Retardant, VW-1  
 • Shrink Temp: 70°C (158°F)  
 • Operating Temp: -55°C thru 125°C (-67°F thru 257°F)



### HTSK-2826-RL100

I.S. 100' ROLL POLYOLEFIN HEAT SHRINK TUBING  
 • 28-26 Gauge  
 • 2:1 Shrink Ratio  
 • I.D. Shrinks 3/32" to 3/64" Recovered  
 • Flame Retardant, VW-1  
 • Shrink Temp: 70°C (158°F)  
 • Operating Temp: -55°C thru 125°C (-67°F thru 257°F)



# INSTALLATION

## POLYOLEFIN HEAT SHRINK TUBING



### HTSK-1612

- 1/4" POLYOLEFIN HEAT SHRINK TUBING (8 Pieces)
- 16-12 Gauge
  - 2:1 Shrink Ratio
  - I.D. Shrinks 1/4" to 1/8" Recovered
  - Flame Retardant, VW-1
  - Shrink Temp: 70°C (158°F)
  - Operating Temp: -55°C thru 125°C (-67°F thru 257°F)



### HTSK-2018

- 3/16" POLYOLEFIN HEAT SHRINK TUBING (8 Pieces)
- 20-18 Gauge
  - 2:1 Shrink Ratio
  - I.D. Shrinks 3/16" to 3/32" Recovered
  - Flame Retardant, VW-1
  - Shrink Temp: 70°C (158°F)
  - Operating Temp: -55°C thru 125°C (-67°F thru 257°F)



### HTSK-100CL

HEAT SHRINK TUBE VALUE PACK

Size/Tamaño	Color	Quantity/Cantidad	Length/Largo
Φ1.5mm	Black / Negro	30	100mm
Φ2.5mm	Yellow / Amarillo	30	
Φ4.0mm	Red / Rojo	20	
Φ6.0mm	Green / Verde	10	
Φ10mm	Blue / Azul	6	
Φ13mm	White / Blanco	4	

### HTSK-1612-RL100

- 1/4" POLYOLEFIN HEAT SHRINK TUBING
- 16-12 Gauge
  - 2:1 Shrink Ratio
  - I.D. Shrinks 1/4" to 1/8" Recovered
  - Flame Retardant, VW-1
  - Shrink Temp: 70°C (158°F)
  - Operating Temp: -55°C - 125°C (-67°F - 257°F)
  - 100 Ft. / 30.48 Meters



### HTSK-2018-RL100

- 3/16" POLYOLEFIN HEAT SHRINK TUBING
- 20-18 Gauge
  - 2:1 Shrink Ratio
  - I.D. Shrinks 3/16" to 3/32" Recovered
  - Flame Retardant, VW-1
  - Shrink Temp: 70°C (158°F)
  - Operating Temp: -55°C - 125°C (-67°F - 257°F)
  - 100 Ft. / 30.48 Meters



### HTSK-0400

- 13mm POLYOLEFIN HEAT SHRINK TUBING (8 Pieces)
- 4-0 Gauge
  - 2:1 Shrink Ratio
  - I.D. Shrinks 1/4" to 1/8" Recovered
  - Flame Retardant, VW-1
  - Shrink Temp: 70°C (158°F)
  - Operating Temp: -55°C thru 125°C (-67°F thru 257°F)



### HTSK-0400-RL50

- I.S. 50' POLYOLEFIN HEAT SHRINK TUBING
- 4-0 Gauge
  - 2:1 Shrink Ratio
  - I.D. Shrinks 1/4" to 1/8" Recovered
  - Flame Retardant, VW-1
  - Shrink Temp: 70°C (158°F)
  - Operating Temp: -55°C thru 125°C (-67°F thru 257°F)

# INSTALLATION

## CABLE TIES



- IS-CT-4 (4", 18 lbs.)
- IS-CT-6 (6", 18 lbs.)
- IS-CT-8 (8", 40 lbs.)
- IS-CT-10 (10", 40 lbs.)
- IS-CT-12 (12", 50 lbs.)
- IS-CT-14 (14", 50 lbs.)
- IS-CT-16 (16", 50 lbs.)
- IS-CT-18 (18", 50 lbs.)

- NYLON CABLE TIES
- (100 Pieces)
  - White



- IS-CT-4BUV (4", 18 lbs.)
- IS-CT-6BUV (6", 18 lbs.)
- IS-CT-8BUV (8", 40 lbs.)
- IS-CT-10BUV (10", 40 lbs.)
- IS-CT-12BUV (12", 40 lbs.)
- IS-CT-14BUV (14", 50 lbs.)
- IS-CT-16BUV (16", 55 lbs.)
- IS-CT-20BUV (20", 65 lbs.)

- NYLON CABLE TIES
- (100 Pieces)
  - UV Resistant
  - Black



- IS-CT-518RU (5 3/4")
- REUSABLE CABLE TIES
- Nylon
  - Black

- IS-CT-718RU (7")
- REUSABLE CABLE TIES
- Nylon
  - Black

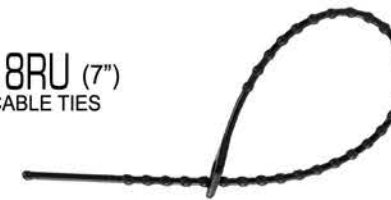

- IS-CTR-8BUV (8", 40 lbs.)
- CABLE TIES WITH MOUNTING RING
- Nylon
  - Black



- IS-VLR-6BLK (5 3/4")
- 6" ADJUSTABLE VELCRO STRAPS
- Package of 10



- CC-1
- WALL FEED
- for RG-59 Cable



- CC-5 / CC-6 BLK
- NYLON CLIPS
- for RG-6 Cable

**LM-1-100 BLK**  
PROTECTIVE LOOM  
• 1" Diameter Black  
• 100 Feet  
• Flexible & Durable

**LM-12-100 BLK**  
PROTECTIVE LOOM  
• 1/2" Diameter Black  
• 100 Feet  
• Flexible & Durable

**LM-115-100 BLK**  
PROTECTIVE LOOM  
• 1.5" Diameter Black  
• 100 Feet  
• Flexible & Durable

**LM-38-100 BLK**  
PROTECTIVE LOOM  
• 3/8" Diameter Black  
• 100 Feet  
• Flexible & Durable

**LM-1-20 BLK**  
PROTECTIVE LOOM  
• 1/2" Diameter Black  
• 20 Feet  
• Flexible & Durable

**LM-14-100 BLK**  
PROTECTIVE LOOM  
• 1/4" Diameter Black  
• 100 Feet  
• Flexible & Durable

**LM-34-100 BLK**  
PROTECTIVE LOOM  
• 3/4" Diameter Black  
• 100 Feet  
• Flexible & Durable

**Used to protect electrical wiring  
in automotive, marine and hydraulic  
applications**



**SBL-1-50BLK**  
1" SELF-WRAPPING BRAIDED  
SPLIT LOOM  
• Semi-Rigid Braided Construction  
• Accommodate a Wide Variety  
of Bundling Requirements  
• Length: 50 Ft / 15.2 Meters  
• Colors: Black

**SBL-34-50BLK**  
3/4" SELF-WRAPPING BRAIDED  
SPLIT LOOM  
• Semi-Rigid Braided Construction  
• Accommodate a Wide Variety  
of Bundling Requirements  
• Length: 50 Ft / 15.2 Meters  
• Colors: Black

**SBL-12-50BLK**  
1/2" SELF-WRAPPING BRAIDED  
SPLIT LOOM  
• Semi-Rigid Braided Construction  
• Accommodate a Wide Variety  
of Bundling Requirements  
• Length: 50 Ft / 15.2 Meters  
• Colors: Black



**IS-BR6M-100BLK** ●  
**IS-BR6M-100BLU** ●  
**IS-BR6M-100GR** ●  
**IS-BR6M-100RD** ●  
**IS-BR6M-100WH** ○  
**IS-BR6M-100YL** ●

- Expandable Braided Sleeve
- Diameter:  $\Phi$  1/4" / 6mm
- Length: 100 FT / 30.48 Meters
- Colors: Black, Blue & Red

**IS-BR10M-100BLK** ●  
**IS-BR10M-100BL** ●  
**IS-BR10M-100GR** ●  
**IS-BR10M-100RD** ●  
**IS-BR10M-100WH** ○  
**IS-BR10M-100YL** ●

- Expandable Braided Sleeve
- Diameter:  $\Phi$  3/8" / 10mm
- Length: 100 FT / 30.48 Meters
- Colors: Black, Blue & Red

**IS-BR19M-100BLK** ●  
**IS-BR19M-100BL** ●  
**IS-BR19M-100GR** ●  
**IS-BR19M-100RD** ●  
**IS-BR19M-100WH** ○  
**IS-BR19M-100YL** ●

- Expandable Braided Sleeve
- Diameter:  $\Phi$  3/4" / 19mm
- Length: 100 FT / 30.48 Meters
- Colors: Black, Blue & Red





**GG-833F**

MINI HOT MELT GLUE GUN  
 • 10 Watts  
 • 110V, 60Hz

For:

- Toys and Models
- Artificial Flowers
- Woodworking
- Furniture & Decorations



**GS-610**

GLUE STICKS (48 Pieces)  
 • 1 lb.  
 • For GG-839 Large Glue Gun  
 • 10 cm  
 • Diameter: 1/2"

**GS-675**

GLUE STICKS (135 Pieces)  
 • 1 lb.  
 • For GG-833 Small Glue Gun  
 • 10 cm  
 • Diameter: 1/4"



**GG-839F (Large)**

LARGE HOT MELT GLUE GUN

- 80 Watts
- 120V, 60Hz
- Quick, Easy, Versatile Tool
- Electronic Heating System
- Automatic Trigger Action
- Non-Slip Pad on Grip

For:

- Toys and Models
- Artificial Flowers
- Woodworking
- Furniture & Decorations

**NST-012B (1/2")**

**NST-034B (3/4")**

- Black Self-Tap Truss Head Screw (1000 Pieces)



**NST-012S (1/2")**

**NST-034S (3/4")**

- Silver Self-Tap Truss Head Screw (1000 Pieces)



**NSCP-012 (1/2")**

**NSCP-01 (1")**

- Medium Thread Pan Head Screw



**NSCW-012 (1/2")**

**NSCW-01 (1")**

- Deep Thread Wafer Head Screw



**NSCO-014**

- 1/2" Medium #8 Thread Countersink Head Screw



**GS-1120BL**

GLUE STICKS (6 Pieces)  
 • 10 cm  
 • For Large Glue Gun  
 • Diameter: 1/2"  
 • Blister Packing



**GS-720BL**

GLUE STICKS (6 Pieces)  
 • 10 cm  
 • Diameter: 1/4"  
 • Blister Packing  
 • for Standard Glue Gun



IS-EPXY-20G

- EPOXY ADHESIVE
- N.W. 0.7 Oz. (20g)
  - Transparent
  - Excellent Bonding
  - High Strength
  - Waterproof
  - BEST USE:  
Metal, Steel, Wood, Concrete, Ceramic, Glass, Plastic, Etc.



IS-SPGT-25G

- 3 MINUTE EPOXY
- Cures Quicker
  - Holds Stronger
  - Resealable Syringe



TGP-450-20G

- WHITE HEATSINK PASTE THERMAL CONDUCTIVE
- 2.15w/m-k 20g
  - Quick Cooling
  - Non-Toxic, Environmental Protection
  - Good Heat Dissipation
  - Stable Performance



TGPH-550-20G

- GREY COMPUTER HEATSINK PASTE THERMAL CONDUCTIVE
- 2.7w/m-k 20g Tube Packing with OEM Label
  - Quick Cooling
  - Non-Toxic, Environmental Protection
  - Good Heat Dissipation
  - Stable Performance



- ET-5 (12')
- ELECTRICAL TAPE
- 3/4" x 12 Ft.
  - Suitable for Use up to 176°F (80°C) and 600V
  - Black



- ET-11 (60')
- 7 MIL ELECTRICAL TAPE
- 3/4" x 60 Ft.
  - Suitable for Use up to 176°F (80°C) and 600V
  - Black



- ET-20 MULTI
- 7MIL ELECTRICAL TAPE (10 Pack)
- 3/4" x 60 Ft.
  - Suitable for Use up to 176°F (80°C) and 600V
  - Multi-Color: Red, Yellow, Blue, Green and White

- ET-12
- 7 MIL ELECTRICAL TAPE
- 3/4" x 60 Ft.
  - Suitable for Use up to 176°F (80°C) and 600V
  - Color: Blue

- ET-17
- 7 MIL ELECTRICAL TAPE
- 3/4" x 60 Ft.
  - Suitable for Use up to 176°F (80°C) and 600V
  - Color: Grey

- ET-13
- 7 MIL ELECTRICAL TAPE
- 3/4" x 60 Ft.
  - Suitable for Use up to 176°F (80°C) and 600V
  - Color: Red

- ET-18
- 7 MIL ELECTRICAL TAPE
- 3/4" x 60 Ft.
  - Suitable for Use up to 176°F (80°C) and 600V
  - Color: White

- ET-14
- 7 MIL ELECTRICAL TAPE
- 3/4" x 60 Ft.
  - Suitable for Use up to 176°F (80°C) and 600V
  - Color: Green

- ET-19
- ELECTRICAL TAPE
- 7mil x 3/4" x 60 Ft.
  - Suitable for Use up to 176°F (80°C) and 600V
  - Color: Orange

- ET-15
- 7 MIL ELECTRICAL TAPE
- 3/4" x 60 Ft.
  - Suitable for Use up to 176°F (80°C) and 600V
  - Color: Yellow

- ET-16
- 7 MIL ELECTRICAL TAPE
- 3/4" x 60 Ft.
  - Suitable for Use up to 176°F (80°C) and 600V
  - Color: Brown



# INSTALLATION

## TAPES/HOOK & LOOP

### ET-1060-DST

DOUBLE SIDED FOAM TAPE

- Works on Many Surfaces Including Metal, Glass and Plastic
- Holds up to 5 lbs. One Inch Holds a Quarter Pound Four Inches Hold One Pound
- Weather Resistant and Highly Conformable
- Great for Indoor and Outdoor Use
- Make Sure All Surfaces are Clean and Dry
- Cut 4 Inches of Tape for every 1 Pound Do Not Remove Protective Liner Yet
- Apply Tape to Back of Object-Press Firmly on Liner for Good Adhesive Contact
- Remove Liner and Press Object Firmly Onto Wall
- 1" Double Sided Tape
- Length 60"



### ET-1260-DST

DOUBLE SIDED FOAM TAPE

- Works on Many Surfaces Including Metal, Glass and Plastic
- Holds up to 5 lbs. One Inch Holds a Quarter Pound Four Inches Hold One Pound
- Weather Resistant and Highly Conformable
- Great for Indoor and Outdoor Use
- Make Sure All Surfaces are Clean and Dry
- Cut 4 Inches of Tape for every 1 Pound Do Not Remove Protective Liner Yet
- Apply Tape to Back of Object-Press Firmly on Liner for Good Adhesive Contact
- Remove Liner and Press Object Firmly Onto a Wall
- 1/2" Double Sided Tape
- Length 60"



### ET-0834-DSF

3/4" X 8' WEATHER STRIPPING TAPE

- Ideal for Home, Auto, Marine and Various other Applications
- Self-Adhesive, Waterproof and Stops Vibrations
- 0.75" Wide x 8' Long (19 x 2400mm)



### IS-FAST1

1" WIDE HOOK AND LOOP FASTENING SYSTEM - BLACK

- Self Adhering
- Nylon Hooks Mesh with Pliable Loops for Fast, Secure Closure
- Maximum Convenience - Just Press to Close and Peel to Open
- Adhesive Backing Adheres Instantly to Many Surfaces



### IS-FAST2

2" WIDE HOOK AND LOOP FASTENING SYSTEM - BLACK

- Self Adhering
- Nylon Hooks Mesh with Pliable Loops for Fast, Secure Closure
- Maximum Convenience - Just Press to Close and Peel to Open
- Adhesive Backing Adheres Instantly to Many Surfaces



# INSTALLATION

## COPPER RING TONGUE TERMINAL



### IS-PTRC-0-8

CRIMP TYPE - COPPER RING TONGUE TERMINAL

- 0 Gauge
- Stud Size #1/4"
- Insulated
- Black



### IS-PTRC-0-10

CRIMP TYPE - COPPER RING TONGUE TERMINAL

- 0 Gauge
- Stud Size #5/16"
- Insulated
- Black



### IS-PTRC-4-8

CRIMP TYPE - COPPER RING TONGUE TERMINAL

- 4 Gauge
- Stud Size #1/4"
- Insulated
- Black



### IS-PTRC-4-10

CRIMP TYPE - COPPER RING TONGUE TERMINAL

- 4 Gauge
- Stud Size #5/16"
- Insulated
- Black



### IS-PTRC-8-8

CRIMP TYPE - COPPER RING TONGUE TERMINAL

- 8 Gauge
- Stud Size #14"
- Insulated
- Black



# INSTALLATION

## RING TONGUE TERMINAL



**IS-PTRCST-008**  
COPPER SEALED RING TERMINAL

- 0 Gauge
- Stud Size #1/4"
- 2 per Pack



Heat Shrink included



**IS-PTRCST-010**  
COPPER SEALED RING TERMINAL

- 0 Gauge
- Stud Size #5/16"
- 2 per Pack



Heat Shrink included



**IS-PTRCST-408**  
COPPER SEALED RING TERMINAL

- 4 Gauge
- Stud Size #1/4"
- 2 per Pack



Heat Shrink included



**IS-PTRCST-410**  
COPPER SEALED RING TERMINAL

- 4 Gauge
- Stud Size #5/16"
- 2 per Pack



Heat Shrink included



**IS-PTRCST-808**  
COPPER SEALED RING TERMINAL

- 8 Gauge
- Stud Size #1/4"
- 2 per Pack



Heat Shrink included

**IS-RT-HD0-3/8**  
HEAVY DUTY RING TONGUE TERMINAL

- Pack of 50
- 0 Gauge
- Stud Size #3/8"



**IS-RT-HD4-5/16**  
HEAVY DUTY RING TONGUE TERMINAL

- Pack of 50
- 4 Gauge
- Stud Size #5/16"



# INSTALLATION

## IS ACCESSORIES



**IS-119-5G**  
RCA F-F GOLD

- 5 Pcs (RED)
- 5 Pcs (BLACK)



**IS-119-5SL**  
RCA F-F SILVER

- 5 Pcs (RED)
- 5 Pcs (BLACK)



**IS-120-5G**  
RCA M-M GOLD

- 5 Pcs (RED)
- 5 Pcs (BLACK)



**IS-120-5SL**  
RCA M-M SILVER

- 5 Pcs (RED)
- 5 Pcs (BLACK)

# INSTALLATION

## CRIMP CAPS/SPLICE ADAPTERS/T-TAP NYLON TERMINALS



**IS-CC-2214N**  
 NYLON CRIMP CAP  
 • 22-14 Gauge  
 • Long Barrel  
 • Natural  
 • Package of 100



**IS-CC-2214B**  
 NYLON CRIMP CAP  
 • 22-14 Gauge  
 • Long Barrel  
 • Black  
 • Package of 100



**IS-CC1416**  
 NYLON CRIMP CAP  
 • 14-16 Gauge  
 • Long Barrel  
 • Natural  
 • Package of 100



**IS-QS-1210**  
 QUICK SPLICE ADAPTER  
 • 12-10 Gauge  
 • Yellow  
 • Package of 100



**IS-QS-1614**  
 QUICK SPLICE ADAPTER  
 • 16-14 Gauge  
 • Blue  
 • Package of 100



**IS-QS-2218**  
 QUICK SPLICE ADAPTER  
 • 22-18 Gauge  
 • Red  
 • Package of 100



**IS-TT-1814**  
 T-TAP SPLICE CONNECTOR  
 • 18-14 Gauge  
 • Red  
 • Package of 100



**IS-TT-2016**  
 T-TAP SPLICE CONNECTOR  
 • 20-16 Gauge  
 • Blue  
 • Package of 100



**IS-TT-2218**  
 T-TAP SPLICE CONNECTOR  
 • 22-18 Gauge  
 • Yellow  
 • Package of 100

# INSTALLATION

## RING TERMINALS

**PBTR-0**  
 POWER RING TERMINALS  
 • 0 Gauge  
 • Red  
 • Blister Packing

**PBTR-4**  
 POWER RING TERMINALS  
 • 4 Gauge  
 • Red  
 • Blister Packing

**PBTR-8**  
 POWER RING TERMINALS  
 • 8 Gauge  
 • Red  
 • Blister Packing

**PBTR-10**  
 POWER RING TERMINALS  
 • 10 Gauge  
 • Red  
 • Blister Packing



**PTR-0T-RED**  
 RING TERMINAL AMERICAN 0 AWG RED  
 • 0 AWG  
 • Red  
 • Blister Packing

**PTR-0T-BLK**  
 RING TERMINAL AMERICAN 0 AWG RED  
 • 0 AWG  
 • Black  
 • Blister Packing





**PBTS-4**  
POWER SPADE TERMINAL  
• Pack of 4  
• 4 Gauge  
• Blister Packing

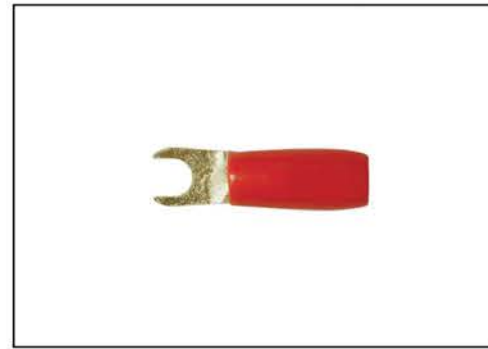

**PBTS-8**  
POWER SPADE TERMINAL  
• Pack of 8  
• 8 Gauge  
• Blister Packing



**PTR-6 BLK**  
RING TONGUE TERMINAL BULK PACK  
• 6 Gauge  
• Pack of 50  
• 3/8  
• Black



**PTR-6 RED**  
RING TONGUE TERMINAL BULK PACK  
• 6 Gauge  
• Pack of 50  
• 3/8  
• Red



**PTR-0 RED**  
RING TONGUE TERMINAL BULK PACK  
• 0 Gauge  
• Pack of 50  
• 3/8  
• Red



**PTR-0 BLK**  
RING TONGUE TERMINAL BULK PACK  
• 0 Gauge  
• Pack of 50  
• 3/8  
• Black



**PTR-4 BLK**  
RING TONGUE TERMINAL BULK PACK  
• 4 Gauge  
• Pack of 50  
• 3/8  
• Black



**PTR-4 RED**  
RING TONGUE TERMINAL BULK PACK  
• 4 Gauge  
• Pack of 50  
• 3/8  
• Red



**PTR-8 BLK**  
RING TONGUE TERMINAL BULK PACK  
• 8 Gauge  
• Pack of 50  
• 3/8  
• Black



**PTR-8 RED**  
RING TONGUE TERMINAL BULK PACK  
• 8 Gauge  
• Pack of 50  
• 3/8  
• Red

**INSTALLATION**

RING TONGUES/QUICK DISCONNECT

**INSTALLATION**

QUICK DISCONNECT



**PTR-10 BLK**

- RING TONGUE TERMINAL BULK PACK
- 10 Gauge
- Pack of 50
- 3/8
- Black



**PTR-10 RED**

- RING TONGUE TERMINAL BULK PACK
- 10 Gauge
- Pack of 50
- 3/8
- Red



**PTD-16 BLK**

- FEMALE TERMINALS BULK PACK
- 16 Gauge
- Pack of 50
- Female Quick Disconnect
- Black



**PTD-16 RED**

- FEMALE TERMINALS BULK PACK
- 16 Gauge
- Pack of 50
- Female Quick Disconnect
- Red



**PTD-10 BLK**

- FEMALE TERMINALS BULK PACK
- 10 Gauge
- Pack of 50
- Female Quick Disconnect
- Black



**PTD-10 RED**

- FEMALE TERMINALS BULK PACK
- 10 Gauge
- Pack of 50
- Female Quick Disconnect
- Red



**PTD-18 BLK**

- FEMALE TERMINALS BULK PACK
- 18 Gauge
- Pack of 50
- Female Quick Disconnect
- Black



**PTD-18 RED**

- FEMALE TERMINALS BULK PACK
- 18 Gauge
- Pack of 50
- Female Quick Disconnect
- Red

# INSTALLATION

## SPADE TONGUES



**PTS-4 BLK**  
SPADE TERMINAL  
• Pack of 50  
• 4 Gauge  
• Black



**PTS-4 RED**  
SPADE TERMINAL  
• Pack of 50  
• 4 Gauge  
• Red

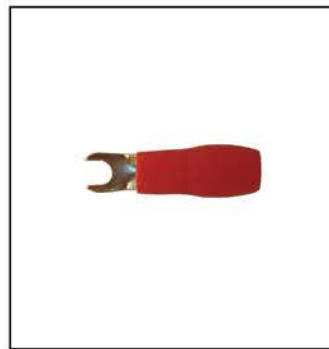

**PTS-6 RED**  
SPADE TERMINAL  
• Pack of 50  
• 6 Gauge  
• Red



**PTS-8 BLK**  
SPADE TERMINAL  
• Pack of 50  
• 8 Gauge  
• Black

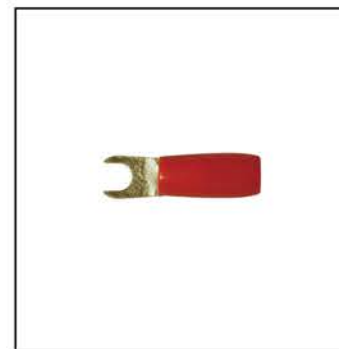

**PTS-8 RED**  
SPADE TERMINAL  
• Pack of 50  
• 8 Gauge  
• Red

# INSTALLATION

## SPADE TONGUES/TERMINALS



**PTS-10 BLK**  
SPADE TERMINAL  
• Pack of 50  
• 10 Gauge  
• Black

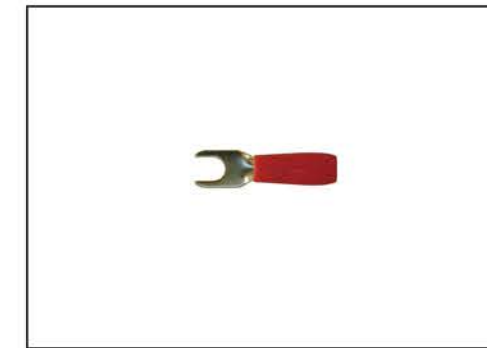

**PTS-10 RED**  
SPADE TERMINAL  
• Pack of 50  
• 10 Gauge  
• Red



**PTS-14 BLK**  
SPADE TERMINAL  
• Pack of 50  
• 14 Gauge  
• Black

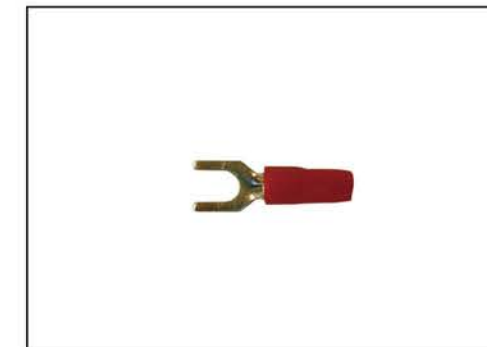

**PTS-14 RED**  
SPADE TERMINAL  
• Pack of 50  
• 14 Gauge  
• Red

## BMS-AMP1

### I.S. AMPLIFIER DRESS-UP KIT

- Gold Ring Terminal Red Color
- Gold Ring Terminal Black Color
- Gold Plated Spade Terminal Black Color
- Gold Plated Spade Terminal Red Color
- 6 Assorted Cable Ties

**CORRECT  
INSTALLATION**



**INCORRECT  
INSTALLATION**



## GRK-110

### 175 PIECE TERMINALS KIT

- Solderless Terminals and Connectors Kit
- Includes: Spade Terminals, Ring Terminals, Male Push-On, Female Push-On, Bullet, Hook, Butt Connector



# INSTALLATION

## TERMINALS



**IS-BLM-1614**  
VINYL MALE BULLET CONNECTOR

- Pack of 100
- 16-14 Gauge
- Insulated
- Blue

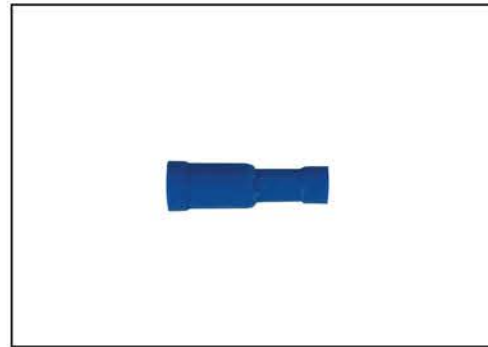

**IS-BLF-1614**  
VINYL FEMALE BULLET CONNECTOR

- Pack of 100
- 16-14 Gauge
- Insulated .156
- Blue



**IS-TB-2216**  
TAB CONNECTOR

- Pack of 100
- 22-16 Gauge
- Insulated
- Red



**IS-RT-1210-1/4**  
VINYL RING TONGUE TERMINAL

- Pack of 100
- 12-10 Gauge
- Stud Size #1/4
- Insulated
- Yellow



**IS-RT-1210-10**  
VINYL RING TONGUE TERMINAL

- Pack of 100
- 12-10 Gauge
- Stud Size #10
- Insulated
- Yellow



**IS-RT-1210-3/8**  
VINYL RING TONGUE TERMINAL

- Pack of 100
- 12-10 Gauge
- Stud Size #3/8
- Insulated
- Yellow



**IS-RT-1210-516**  
VINYL RING TONGUE TERMINAL

- Pack of 100
- 12-10 Gauge
- Stud Size #5/16
- Insulated
- Yellow

# INSTALLATION

## RING TONGUES

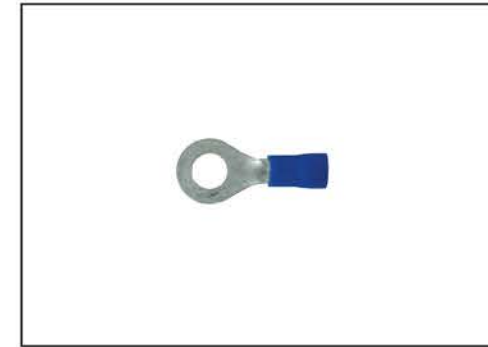

**IS-RT-1614-1/4**  
VINYL RING TONGUE TERMINAL

- Pack of 100
- 16-14 Gauge
- Stud Size #1/4
- Insulated
- Blue

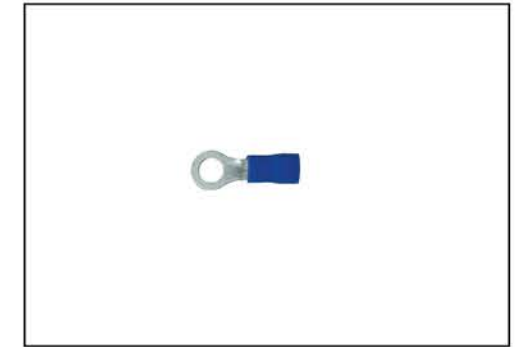

**IS-RT-1614-10**  
VINYL RING TONGUE TERMINAL

- Pack of 100
- 16-14 Gauge
- Stud Size #10
- Insulated
- Blue



**IS-RT-1614-3/8**  
VINYL RING TONGUE TERMINAL

- Pack of 100
- 16-14 Gauge
- Stud Size #3/8
- Insulated
- Blue



**IS-RT-1614-516**  
VINYL RING TONGUE TERMINAL

- Pack of 100
- 16-14 Gauge
- Stud Size #5/16
- Insulated
- Blue



**IS-RT-2218-1/4**  
VINYL RING TONGUE TERMINAL

- Pack of 100
- 22-18 Gauge
- Stud Size #1/4
- Insulated
- Red

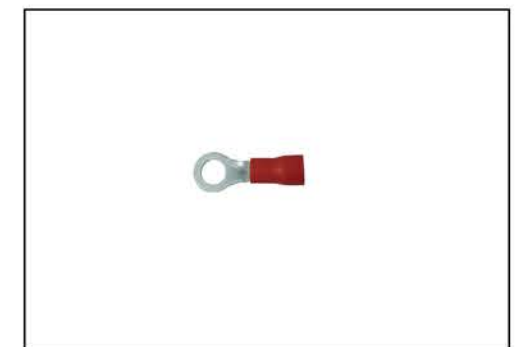

**IS-RT-2218-10**  
VINYL RING TONGUE TERMINAL

- Pack of 100
- 22-18 Gauge
- Stud Size #10
- Insulated
- Red



# INSTALLATION

## RING TONGUES/BUTT CONNECTORS



**IS-BT-1210**  
VINYL BUTT CONNECTOR

- Pack of 100
- Full Insulated
- 12-10 Gauge
- Yellow

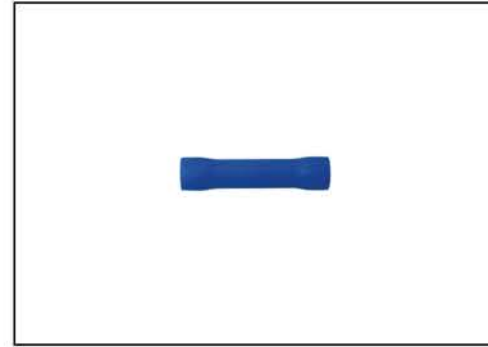

**IS-BT-1614**  
VINYL BUTT CONNECTOR

- Pack of 100
- Full Insulated
- 16-14 Gauge
- Blue



**IS-BT-2218**  
VINYL BUTT CONNECTOR

- Pack of 100
- Full Insulated
- 22-18 Gauge
- Red



**IS-SP-1210-10**  
VINYL SPADE TERMINAL

- Pack of 100
- Insulated
- 12-10 Gauge
- # 10 Stud Size
- Yellow

**IS-SP-1614-10**  
VINYL SPADE TERMINAL

- Pack of 100
- 16-14 Gauge
- # 10 Stud Size
- Insulated
- Red



# INSTALLATION

## TERMINALS/CONNECTORS

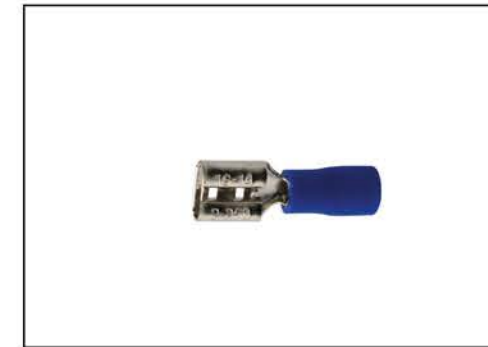

**IS-QD-1614**  
FEMALE QUICK DISCONNECT TERMINAL

- Pack of 100
- 22-18 Gauge
- Insulated: 187
- Female Quick Disconnect
- Red



**IS-QD-2218-110**  
FEMALE QUICK DISCONNECT TERMINAL

- Pack of 100
- 22-18 Gauge
- Insulated: 110
- Female Quick Disconnect
- Red

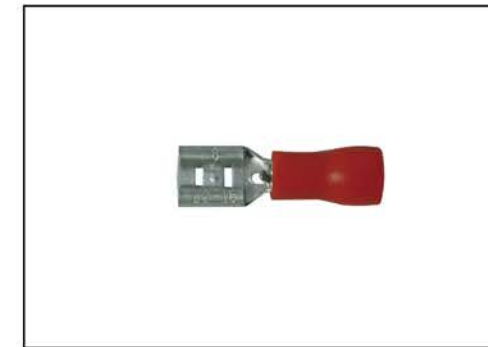

**IS-QD-2218-187**  
FEMALE QUICK DISCONNECT TERMINAL

- Pack of 100
- 22-18 Gauge
- Insulated: 187
- Female Quick Disconnect
- Red



**IS-QD-2218-250**  
FEMALE QUICK DISCONNECT TERMINAL

- Pack of 100
- 22-18 Gauge
- Insulated: 250
- Female Quick Disconnect
- Red

**IS-BT-8**  
BUTT CONNECTOR

- Pack of 100
- 8 Gauge
- Yellow
- Fully Insulated



**IS-BT-8NL**  
NYLON BUTT CONNECTOR

- Pack of 100
- 8 Gauge
- Yellow
- Fully Insulated



**IS-BT-1614NL**  
NYLON BUTT CONNECTOR

- Pack of 100
- 16-14 Gauge
- Blue
- Fully Insulated



**IS-BT-2218NL**  
NYLON BUTT CONNECTOR

- Pack of 100
- 22-18 Gauge
- Red
- Fully Insulated



# INSTALLATION

## QUICK CONNECTORS

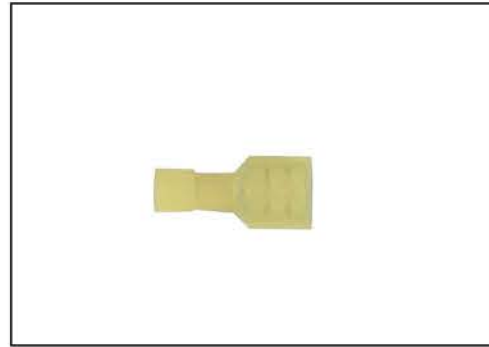

### IS-IQF-1210NL

- NYLON FEMALE QUICK DISCONNECT
- 12-10 Gauge
  - Pack of 100
  - Fully Insulated .250
  - Quick Disconnect
  - Yellow

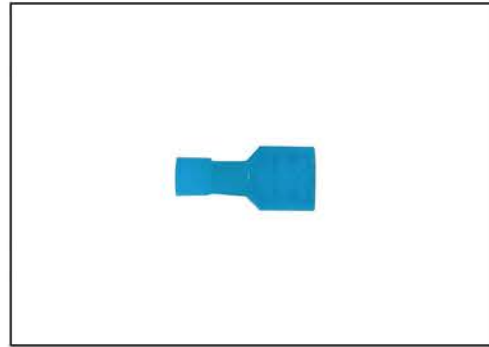

### IS-IQF-1614NL

- NYLON FEMALE QUICK DISCONNECT
- 16-14 Gauge
  - Pack of 100
  - Fully Insulated .250
  - Quick Disconnect
  - Blue



### IS-IQF-2218NL

- NYLON FEMALE QUICK DISCONNECT
- 22-18 Gauge
  - Pack of 100
  - Fully Insulated .250
  - Quick Disconnect
  - Red



### IS-IQM-1210NL

- NYLON FEMALE QUICK DISCONNECT
- 12-10 Gauge
  - Pack of 100
  - Fully Insulated .250
  - Quick Disconnect
  - Yellow



### IS-IQM-1614NL

- NYLON MALE FULLY INSULATED TAB CONNECTOR
- 16-14 Gauge
  - Pack of 100
  - Fully Insulated .250
  - Quick Disconnect
  - Blue

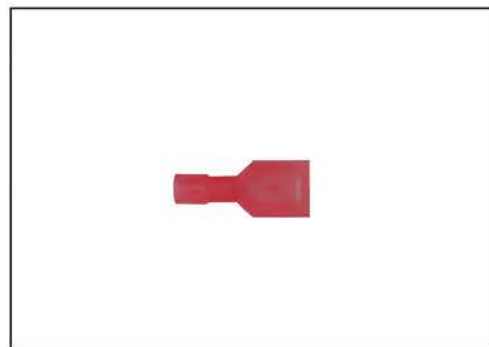

### IS-IQM-2218NL

- NYLON MALE FULLY INSULATED TAB CONNECTOR
- 22-18 Gauge
  - Pack of 100
  - Fully Insulated .250
  - Quick Disconnect
  - Red

# INSTALLATION

## CONNECTORS



### MBT-1210HS

- MARINE HEAT SHRINK BUTT CONNECTOR
- 12-10 Gauge
  - Color: Yellow
  - Package of 100



### MBT-1614HS

- MARINE HEAT SHRINK BUTT CONNECTOR
- 16-14 Gauge
  - Color: Blue
  - Package of 100



### MBT-2218HS

- MARINE HEAT SHRINK BUTT CONNECTOR
- 22-18 Gauge
  - Color: Pink
  - Package of 100



### MQD-1210-250HS

- MARINE HEAT SHRINK BUTT DISCONNECT-CONNECTOR
- 12-10 Gauge
  - Color: Yellow
  - Package of 100



### MQD-1614-250HS

- MARINE HEAT SHRINK BUTT DISCONNECT-CONNECTOR
- 16-14 Gauge
  - Color: Blue
  - Package of 100



### MQD-2218-250HS

- MARINE HEAT SHRINK BUTT DISCONNECT-CONNECTOR
- 22-18 Gauge
  - Color: Pink
  - Package of 100



### MRT-1210-8HS

- MARINE HEAT RING TERMINAL CONNECTOR
- 12-10 Gauge
  - Color: Yellow
  - Package of 100



### MRT-1614-6HS

- MARINE HEAT RING TERMINAL CONNECTOR
- 16-14 Gauge
  - Color: Blue
  - Package of 100



### MRT-2218-4HS

- MARINE HEAT RING TERMINAL CONNECTOR
- 22-18 Gauge
  - Color: Pink
  - Package of 100

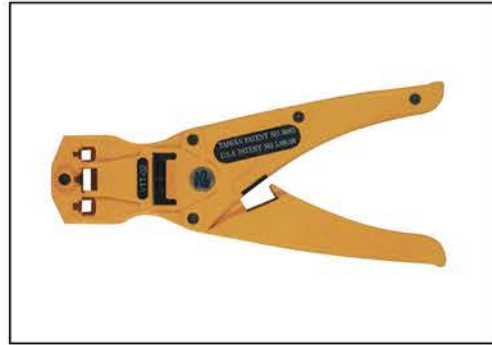

**KR-219S**

CRIMPING TOOL

- Multi-Use Modular Connector
- For 4P, 6P & 8P



**NTK-56CMP**

PROFESSIONAL WATERPROOF CONNECTOR

- Crimping Tools with Adjustment for Crimping Different Length of "F", "BNC", "RCA" Connectors



**GHT-323**

UNIVERSAL STRIPPER TOOL

- Stripping Range: 22 AWG
- 9.50mm(3/8")
- For Round Cable, Stranded Wire
- Multi-Conductor Cable & Irregular Out Shape Cable



**GHT-325**

UNIVERSAL COAXIAL WIRE STRIPPING TOOL

- Use on Coaxial Cable RG59, RG6, RG7 and RG11 Round Networking Cable and Telephone Cable



**NTK-56LCM**

COMPRESSION CRIMPER

- For All Compression Terminals ( F-Type , BNC , RCA )



**NTK-58**

CRIMP TOOL

- Hexagonal for All "F" Connectors



**TTK-012**

IMPACT PUNCH DOWN TOOL

- 110 Blade, Adjustable Impact Wheel
- Punchdown Tool



**TTK-021**

IMPACT PUNCH DOWN TOOL

- 110 Blade, Adjustable Impact Wheel
- Punchdown Tool



**NTK-59**

CRIMP TOOL

- for RG-58 & RG-59



**GHT-301C**

CRIMP TOOL

- for RG-58, 59, 62 & 6



**TTK-061**  
CABLE STRIPPER  
• Yellow Color



**TTK-071**  
2 POSITION MODULAR CRIMPING  
• Tool for 8P8C



**TTK-69**  
ECONOMY NETWORK LAN CABLE CRIMPER  
• All Steel Construction for Durability  
• For Any Ethernet or Telephone Cable



**TTK-725**  
WATERPROOF CONNECTORS  
• Crimping Tools with Adjustment for Crimping Different Length of "F", "BNC" and "RCA" Connectors



**TTK-756**  
F TYPE COMPRESSION TOOL  
• For Crimping RG59, RG6 and RG11 F Type Compression



**TTK-3756**  
PROFESSIONAL COMPRESSION TOOL  
• For Crimping RG59, RG6 and RG11 F Type Compression

**IS-CR1005**

- CRIMPING AND CUTTING TOOL FOR INSULATED AND NON-INSULATED TERMINALS, 9-3/4-INCH
- Accommodates Wire from No. 10-22 AWG (2.59mm - 0.64mm)
  - Specially Hardened Wire Cutter in Nose
  - Tapered Nose Design for Working in Confined Spaces
  - Crimping Die Marked for Insulated and Non-Insulated Solderless Terminals and Connectors
  - Plastic-Dipped, Cushioned Handles for Comfort
  - Size: 4 x 6.6 x 0.5 inches

9"



**IS-CXCO208**

- CUTS UP TO 1" ALUMINUM AND COPPER COAXIAL CABLE
- Precision, One-Hand Shearing Action without Compression or Frayed Ends
  - Forged Body with Heat-Treated and Precision-Ground Steel Blades withstands Frequent Cutting
  - Hot-Riveted Design Requires no Adjustment while Maintaining a Smooth, Precise Operation
  - Handles are Plastic-Coated for Maximum Comfort and Gripping Power
  - Size: 8.2 x 4 inches



**IST-106A**

- HIGH - LEVERAGE CABLE CUTTER
- Cutter Length: 9.3" (237mm)
  - Cuts 0 AWG Copper and Aluminum Cable
  - Dropped-Forged, High-Carbon Steel Construction



**ICR-010**

- HIGH - LEVERAGE CABLE CUTTER
- Cutter Length: 9.3" (237mm)
  - Dropped-Forged, High-Carbon Steel Construction
  - Precision-Ground, Hardened Cutting Edges Provide Accurate Cuts without Cable Distortion
  - Cuts 0 AWG Copper and Aluminum Cable



IS-ST1022

WIRE STRIPPER / CRIMPER / CUTTER

- Cut and Strip 10-22 AWG Solid and Stranded Wire
- Crimp 10-22 AWG Insulated and Non-Insulated Terminals
- Comfortable Soft Grip Handle
- Crimp Coaxial Connectors
- Shear and Thread Common Size Electrical Screws
- Hole in the Side of Jaw for Looping Solid Wire
- Use Pliers Nose to Tighten or Loosen Small Nuts



IS-ICR1555LG

TERMINAL CRIMPER

- 15.4" 6-1/0 AWG Heavy Duty HEX LUG / Terminal Crimper
- Length: 15.4"
- Weight: 2.9 Lbs.
- Capacity: 6-50mm
- Range of Application: BS Standard Type Terminals



IWS-1626

WIRE STRIPPER

- 0.4-1.3mm / 26-16 AWG



IS-FWS-33

FLUSH-CUT MICRO SOFT-WIRE CUTTER

- 5" Flush Cutter
- Body: 50#Steel, HRC42-51, TPR Handle
- Flush-Cut Micro Soft-Wire Cutter has 8mm Long Jaw with Angled Head for Flush-Cutting Applications on up to 16 Gauge (1.3mm) Copper and Soft Wire
- Flush Cutter



IS-FWS-66

FLUSH-CUT WIRE STRIPPER

- 7" Milling Tooth
- Body: 50#Steel, HRC42-50, PVC Handle
- Wire Stripping Range: 10-20AWG /0.8-2.6 mm<sup>2</sup>



IS-NTK-370

SELF-ADJUSTING INSULATION WIRE STRIPPER

- Zink Alloy Head, Cr12MoV, HRC52-60°, PVC Handle
- Wire Stripping Range: 24-10AWG /0.2-6 mm<sup>2</sup>
- Insulation Terminal: 22-10AWG /0.5-6 mm<sup>2</sup>
- Non-Insulated Terminal: 12-10AWG /4-6 mm<sup>2</sup>
- Non-Insulated Terminal: 22-14AWG /0.5-2.5 mm<sup>2</sup>
- Terminal for Car: 7-8mm



IS-NTK-400

SELF-ADJUSTING INSULATION WIRE STRIPPER

- Zink Alloy Head, Cr12MoV, HRC52-60°, PP & TPR Handle, GS
- Wire Stripping Range: 24-10AWG /0.2-6 mm<sup>2</sup>
- Insulation Terminal: 22-10AWG /0.5-6 mm<sup>2</sup>
- Non-Insulated Terminal: 12-10AWG /4-6 mm<sup>2</sup>
- Non-Insulated Terminal: 16-14AWG /1.5-2.5 mm<sup>2</sup>
- Non-Insulated Terminal: 22-18AWG /0.5-1 mm<sup>2</sup>

**IS-IST-166A**

DUAL WIRE STRIPPER / CUTTER FOR SOLID WIRE

- 6" Milling Tooth
- Body: 50#Steel, HRC42-50, TPR Handle
- Wire Stripping Range: 10-20AWG /0.8-2.6 mm<sup>2</sup>



**IS-KIT-130**

INSULATED 3-IN-1 WIRE STRIPPER, CUTTER AND CRIMPER. 50PCS ASSORTED WIRING TERMINALS AND CONNECTOR KIT

- A3 Steel, Non-Carburizing, Caliper Printing
- 8" + 50pcs:
- RV1-4S (Red): Insulated Copper Terminals Ring Terminals 22-16AWG x 5pcs
- RV2-4S (Blue): Insulated Copper Terminals Ring Terminals 16-14AWG x 5pcs
- SV1-4S (Red): Insulated Copper Terminals Spade Terminals 22-16AWG x 5pcs
- SV2-4S (Blue): Insulated Copper Terminals Spade Terminals 16-14AWG x 5pcs
- 2-250 (Red): Male Insulated Quick Disconnectors 16-14AWG x 5pcs
- 2-250 (Blue): Male Insulated Quick Disconnectors 16-14AWG x 5pcs
- 2-250 (Red): Female Insulated Quick Disconnectors 16-14AWG x 5pcs
- 2-250 (Blue): Female Insulated Quick Disconnectors 16-14AWG x 5pcs
- BV1 (Red): Butt Splice Connectors x 5pcs
- BV2 (Blue): Butt Splice Connectors x 5pcs

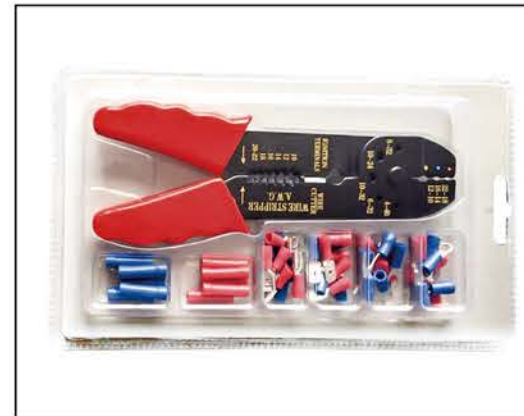

**IS-GRK-270**

270 PCS ASSORTED WIRING TERMINAL AND CRIMP CONNECTORS KIT

- BV1 (Red): Butt Splice Connectors x 10pcs
- BV2 (Blue): Butt Splice Connectors x 10pcs
- BV5 (Yellow): Butt Splice Connectors x 9pcs
- SV5-5 (Yellow): Insulated Copper Terminals Spade Terminals 12-10AWG x 8pcs
- RV5-5 (Yellow): Insulated Copper Terminals Ring Terminals 12-10AWG x 8pcs
- 2-250 (Red): Female Insulated Quick Disconnectors 16-14AWG x 10pcs
- 1-250 (Blue): Male Insulated Quick Disconnectors 22-16AWG x 10pcs
- RV1-5 (Blue): Insulated Copper Terminals Ring Terminals 22-16AWG x 15pcs
- RV1-3 (Blue): Insulated Copper Terminals Ring Terminals 22-16AWG x 25pcs
- SV2-4S (Blue): Insulated Copper Terminals Spade Terminals 16-14AWG x 15pcs
- RV2-4S (Blue): Insulated Copper Terminals Ring Terminals 16-14AWG x 15pcs
- 2-250 (Red): Male Insulated Quick Disconnectors 16-14AWG x 10pcs
- 1-250 (Blue): Female Insulated Quick Disconnectors 22-16AWG x 10pcs
- SV1-4S (Blue): Insulated Copper Terminals Spade Terminals 22-16AWG x 25pcs
- RV1-4S (Red): Insulated Copper Terminals Ring Terminals 22-16AWG x 25pcs
- SV1-5 (Red): Insulated Copper Terminals Spade Terminals 22-16AWG x 15pcs
- SV1-3 (Red): Insulated Copper Terminals Spade Terminals 22-16AWG x 25pcs
- SV1-3 (Blue): Insulated Copper Terminals Spade Terminals 22-16AWG x 25pcs



**ITK-110**

11 IN 1 RATCHETING SCREWDRIVER

- Assorted Philips, Slotted and Torx Bits
- Bits can be Stored in the Handle Storage Cap
- Philips: #00,#0,#1
- Slotted: 2mm, 2.5mm, 3mm
- Torx: T6,T7,T8,T9,T10



**ITK-1200**

TOOLS SET

- Tiny and Slim Design lets User easily Work in a Confined Area
- Contents: 1 PP Box, 1 Ratchet Wrench, 11 Bits



**ITK-3000**

28 IN 1 MINI SCREWDRIVER

- Ideal for Electronics
- Nickel Finished for Rust Prevention
- Fast Turning Swivel Caps
- Heavy Duty Handle made of ABS
- Blade Mode of CR-V



**GSD-140**

ANGLE DRIVER BIT SET

- 11 Pieces



**GSD-149**

ANGLE DRIVER BIT SET

- 41 Pieces



**GTK-174**

PRECISION SCREWDRIVER SET

- 7 Pieces



**IUB-016**

STEP DRILL BITS

- 3/16"-1/2" W/6 STEP- 3/16" - 1/2"



**IUB-018**

STEP DRILL BITS

- 1/8"-1/2" W/13 STEP- 1/8" - 1/2"



**IUB-020**

STEP DRILL BITS

- 1/4"-3/4" W/9 STEPS- 1/4" - 3/4"



**PJ-06**  
PRECISION SCREWDRIVER SET  
• 6 Pieces



**PJ-11**  
PRECISION SCREWDRIVER SET  
• 11 Pieces



**IUPH-700**  
UPHOLSTERY REMOVAL KIT  
• Clear  
• 7 Pieces



**IS-PK-14**  
4-MINI PICK AND HOOK SET  
• Material: 45# Carbon Steel and PP Handle  
• Straight Hook x1  
• 90 Degree Hook x1  
• Full Hook x1  
• Offset 45 Hook x1



**IS-WW3848**

WIRE FEEDER 4FT  
Specialized Tool to Assist Routing Wires Under the Dash Cavity, Under Carpeting, Above Headliners or through the Vehicle's Firewall. It is 3/8" Wide x 48" Long and Made of Nylon that is Rigid enough to Follow a Line, yet Flexible enough to Turn Corners without Collapsing. Will not Scratch or Cut your Vehicle's Interior or Wiring



**IS-KEY9**

• I.S. 9 Pairs Kit OEM Radio Removal Keys



**40AWP-H**

12V DC 40A 5PIN A12V DC 40A 5PIN AUTOMOBILE RELAY WIRE WATERPROOF INTEGRATED CAR AUTO SOCKET

- Contact Form: 1A 1C
- Contact Material: AgCdO
- Contact Resistance  $\leq 100\text{M}\Omega$  (1A 6VDC)
- Max Switching Current: 40A
- Rated Load: 40A/14VDC
- Coil Voltage: 3-24 VDC
- Coil Power: 1.8W
- Insulation Resistance:  $\leq 100\text{M}\Omega$  (500VDC)
- Dielectric Strength(Between Coil and Contact):  $\geq 1000\text{VAC}$
- Operate Time:  $\leq 10\text{ms}$
- Release Time:  $\leq 5\text{ms}$
- Mechanical Life:  $1 \times 10^7$
- Electrical Life:  $1 \times 10^8$
- Install Mode: SCREW
- Weight: 31g
- Wire Length: 14cm
- Coil Wire: AWG16
- Contact Wire: AWG12
- IP67



**IS-EC-WP1213BLK**

CAR BLACK LED LIGHT ILLUMINATED ON/OFF TOGGLE ROCKER SWITCH  
• Current Rating: 10A 12V  
• 3 Pins  
• Waterproof



**IS-EC-WP1213BLU**

CAR BLUE LED LIGHT ILLUMINATED ON/OFF TOGGLE ROCKER SWITCH  
• Current Rating: 10A 12V  
• 3 Pins  
• Waterproof



**IS-EC-WP1213RED**

CAR RED LED LIGHT ILLUMINATED ON/OFF TOGGLE ROCKER SWITCH  
• Current Rating: 10A 12V  
• 3 Pins  
• Waterproof



**IS-EC-WP1216BLU**

ROUND ROCKET SWITCH  
• Current Rating: 16A 12V  
• 3 Pins  
• Waterproof



**IS-EC-WP1216GRN**

ROUND ROCKET SWITCH  
• Current Rating: 16A 12V  
• 3 Pins  
• Waterproof



**IS-EC-WP1216RED**

ROUND ROCKET SWITCH  
• Current Rating: 16A 12V  
• 3 Pins  
• Waterproof



**IS-EP-WB123BLU**

DC 12V 22MM 5/8" BLUE POWER SYMBOL LED METAL SELF-LOCKING LATCHING PUSH BUTTON SWITCH, BLACK WITH WIRED CONNECTOR ADAPTER SOCKET PLUG

- Mounting Hole Size:  $\Phi$ 22mm (5/8 Inch), Switch Rating: 3A/250AC, Switch Combination : 1NO 1NC
- Operation Type: Latching/ Self-Locking [Push it - ON, Push it again - OFF]
- Power Symbol LED can be On all the Time or Only when Switch is On which Depends on how you Wire it
- Great for Electric Switch, Relay, Power Button Switch, Critical Lights, Chassis Lamp, Fog Lamps, Door Switch, Led Switch or any Circuit Controls on over 500,000 Cycles
- High-Quality Metal Material & IP65 Waterproof Protection can be used in Wet or Dusty Environment



**IS-EP-WB123RED**

DC 12V 22MM 5/8" RED POWER SYMBOL LED METAL SELF-LOCKING LATCHING PUSH BUTTON SWITCH, BLACK WITH WIRED CONNECTOR ADAPTER SOCKET PLUG

- Mounting Hole Size:  $\Phi$ 22mm (5/8 Inch), Switch Rating: 3A/250AC, Switch Combination : 1NO 1NC
- Operation Type: Latching/ Self-Locking [Push it - ON, Push it again - OFF]
- Power Symbol LED can be On all the Time or Only when Switch is on which Depends on how you Wire it
- Great for Electric Switch, Relay, Power Button Switch, Critical Lights, Chassis Lamp, Fog Lamps, Door Switch, Led Switch or any Circuit Controls on over 500,000 Cycles
- High-Quality Metal Material & IP65 Waterproof Protection can be used in Wet or Dusty Environments



**IS-EP-WS123BLU**

DC12V 19MM 5/8" BLUE RING LED METAL SELF-LOCKING LATCHING PUSH BUTTON, SILVER SWITCH WITH WIRED CONNECTOR ADAPTER SOCKET PLUG

- Mounting Hole Size:  $\Phi$ 19mm (5/8 Inch), Switch Rating: 3A/250AC, Switch Combination : 1NO 1NC
- Operation Type: Latching/ Self-Locking [Push it - ON, Push it again - OFF]
- Ring LED can be On all the Time or Only when Switch is On which Depends on how you Wire it
- Great for Electric Switch, Relay, Power Button Switch, Critical Lights, Chassis Lamp, Fog Lamps, Door Switch, Led Switch or any Circuit Controls on Over 500,000 Cycles
- High-Quality Metal Material & IP65 Waterproof Protection can be Used in Wet or Dusty Environments



**IS-EP-WS123RED**

DC12V 19MM 5/8" RED RING LED METAL SELF-LOCKING LATCHING PUSH BUTTON SWITCH, SILVER WITH WIRED CONNECTOR ADAPTER SOCKET PLUG

- Mounting Hole Size:  $\Phi$ 19mm (5/8 Inch), Switch Rating: 3A/250AC, Switch Combination : 1NO 1NC
- Operation Type: Latching/ Self-Locking [Push it - ON, Push it again - OFF]
- Ring LED can be On all the Time or Only when Switch is On which Depends on how you Wire it
- Great for Electric Switch, Relay, Power Button Switch, Critical Lights, Chassis Lamp, Fog Lamps, Door Switch, Led Switch or any Circuit Controls on Over 500,000 Cycles
- High-Quality Metal Material & IP65 Waterproof Protection can be Used in Wet or Dusty Environments



**IS-EC-W1210CVR**

HEAVY DUTY ROCKER TOGGLE SWITCH SPST 2 SPADE PIN ON/OFF, WATERPROOF BOOT CAP COVER

- Applicable for All 12-24 DC Volts Connections
- Heavy-Duty Toggle Switch Suitable for Marine, Industrial, or Automotive Applications
- Made from Sturdy Material that Ensures Long Lasting Durability, Facilitate Easy Installation
- Power: 10A 250VAC / 20A 125VAC



**IS-EC-W1220CVR**

HEAVY DUTY ROCKER TOGGLE SWITCH SPST 2 SPADE PIN ON/OFF, WATERPROOF BOOT CAP COVER

- Applicable for All 12-24 DC Volts Connections
- Heavy-Duty Toggle Switch Suitable for Marine, Industrial or Automotive Applications
- Made from Sturdy Material that Ensures Long Lasting Durability, Facilitate Easy Installation
- Power: 20A 250VAC / 15A 125VAC



**EC-2510**  
S.P.S.T. ON-OFF MINI TOGGLE SWITCH  
• Current Rating: 6A-125V AC, 3A-250V AC  
• 2 Pins



**EC-2530**  
S.P.D.T. ON-OFF-ON MINI TOGGLE SWITCH  
• 3 Position  
• Current Rating: 6A-125V AC, 3A-250V AC  
• 3 Pins



**EC-2533P**  
S.P.D.T. ON-OFF-(ON) CONNECTOR SWITCH  
• Current Rating: 6A-125V AC, 3A-250V AC  
• On-Off-Pulse On  
• 3 Pins



**EC-2550**  
D.P.D.T. ON-OFF-ON MINI TOGGLE SWITCH  
• Current Rating: 6A-125V AC, 3A-250V AC  
• 6 Pins



**IS-EC-PB1216RED**  
PUSH SWITCH WITH 40" LEAD WIRE  
• Current Rating: 16A, 12V  
• Mount Hole: 1/4"  
• 2 Pins



**IS-EC138-ALM**  
3' VALET SWITCH  
• Plastic Tach Switch  
• Life: 100,000 Times  
• 2 Cables/BLACK, GREY



**EC-126**  
ON-OFF TOGGLE SWITCH  
• Pre-Wired 2" Long  
• Current Rating: 6A 125V  
• 2 Pins



**AR-110**  
SPDT ON-ON MINI SLIDE SWITCH  
• Current Rating: 3A 125V AC  
• 3 Pins  
This is a simple SPDT slide switch, great for use as an ON/OFF button or just as a general control switch.



**AR-210**  
DPDT ON-ON MINI SLIDE SWITCH  
• Current Rating: 3A 125V AC  
• 6 Pins  
This is a simple DPDT slide switch, great for use as an ON/OFF button or just as a general control switch.



# INSTALLATION

## SWITCHES



**IS-EC-MT1220BLU**  
MATEL TOGGLE SWITCH WITH BLUE COLOR LED AND 6" LEAD WIRE  
 • Current Rating: 20A, 12V  
 • 2 Pins

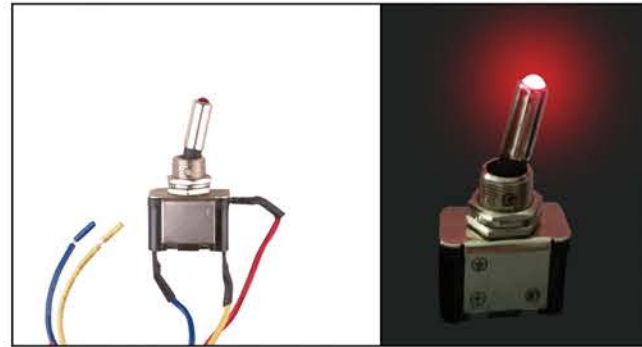

**IS-EC-MT1220RED**  
MATEL TOGGLE SWITCH WITH RED COLOR LED AND 6" LEAD WIRE  
 • Current Rating: 20A, 12V  
 • 2 Pins

**IS-EC-IT1220BLU**  
ILLUMINATED TOGGLE SWITCH WITH 6" LEAD WIRE  
 - Current Rating: 20A, 12V  
 - 3 Pins



**IS-EC-IT1220RED**  
ILLUMINATED TOGGLE SWITCH WITH 6" LEAD WIRE  
 - Current Rating: 20A, 12V  
 - 3 Pins



**IS-EC-OVL12-BLU**  
12V DC 20AMP OVAL BLUE LED LIGHT ILLUMINATED 3P ROCKER SPST ROCKER TOGGLE SWITCH  
 • Easily Fits in 12mm Diameter Opening  
 • Designed to Connect and Disconnect an Electrical Circuit at will - Applicable for Car, Motorcycle, Boat, UTV, RV Etc.  
 • Lower LED is Independent and can be Wired to Separate Dash Light Circuit  
 • Material: ABS  
 • LED Light Color: Blue



**IS-EC-OVL12-RED**  
12V DC 20AMP OVAL RED LED LIGHT ILLUMINATED 3P ROCKER SPST ROCKER TOGGLE SWITCH  
 • Easily Fits in 12mm Diameter Opening  
 • Designed to Connect and Disconnect an Electrical Circuit at Will - Applicable for Car, Motorcycle, Boat, UTV, RV Etc.  
 • Lower LED is Independent and can be Wired to Separate Dash Light Circuit  
 • Material: ABS  
 • LED Light Color: Red



# INSTALLATION

## CRIMP CAPS/SPLICE ADAPTERS/T-TAP NYLON TERMINALS



**EC-1500**  
TOGGLE SWITCH CENTER-OFF  
 • D.P.D.T. Center-Off Toggle Switch  
 • Mount Size : 12/25"  
 • 117V AC  
 • 6 Amp  
 • 6 P



**EC-1501**  
TOGGLE SWITCH CENTER-OFF  
 • D.P.D.T. Center-Off Toggle Switch  
 • Mount Size : 12/25"  
 • 117V AC  
 • 3 Amp  
 • 6 P



**EC-1502**  
D.P.D.T. CENTER-OFF TOGGLE SWITCH  
 • Mount Size : 12/25"  
 • 117V AC  
 • 4 Amp  
 • 6 P



**EC-1503**  
D.P.D.T. CENTER-OFF TOGGLE SWITCH  
 • Mount Size : 12/25"  
 • 117V AC  
 • Current Rating: 4A-125V AC, 2A-250V AC  
 • 3 Amp  
 • 6 P



**EC-1510**  
D.P.D.T. CENTER-OFF TOGGLE SWITCH  
 • Mount Size : 12/25"  
 • 117V AC  
 • Current Rating: 6A-250V AC, 10A-125V AC  
 • 10 Amp  
 • 6 P



**EC-1515**  
D.P.D.T. TOGGLE SWITCH ON-OFF-ON  
 • Mount Size : 12/25"  
 • 117V AC  
 • Current Rating: 10A-250V AC, 15A-125V AC  
 • 15 Amp  
 • 6 P

**EPS-3015BK** (Black)  
**EPS-3015BL** (Blue)  
**EPS-3015CB** (Carbon)

**EPS-3015CH** (Chrome)  
**EPS-3015RD** (Red)



Pilot's Racing Style Toggle Switch Provides you with an Extra Level Safety. Lift the Cover to Flip the Switch On and then Flip the Cover Down to Turn it Off. Works Great with NOS Systems, Fog Lights, Driving Lights, Neon Lights or any other Accessory

**IS-EC-W1215 CVR**

TOGGLE SWITCH  
**Heavy Duty Rocker Toggle Switch SPST 2 Spade Pin ON/OFF, Waterproof Boot Cap Cover**  
 • Applicable for all 12-24 DC Volts Connections  
 • Heavy-Duty Toggle Switch Suitable for Marine, Industrial, or Automotive Applications  
 • Made from Sturdy Material that Ensures Long Lasting Durability, Facilitate Easy Installation  
 • Power: 15A 125VAC





**EC-1512**

TOGGLE SWITCH CENTER-OFF  
 • SPST ON-OFF TOGGLE SWITCH  
 • Mount Size : 12/25"  
 • 10A 250V  
 • 15A 125V  
 • 2 PINS



**EC-1515P**

S.P.D.T. CONNECTOR  
 • Momentary On- Off- (On)  
 • Mount Size : 12/25"  
 • Current Rating: 10A 250V, 15A 125V



**EC-1520**

D.P.D.T. TOGGLE SWITCH CENTER-OFF  
 • 117V AC  
 • Mount Size : 12/25"  
 • Current Rating: 20A-125V AC, 10A-250V AC  
 • 20 Amp  
 • 6 P



**EC-1521MM**

• 20A 125V  
 • 15A 250V  
 • Mounting Size: 12.2mm



**EC-1522**

TOGGLE SWITCH CENTER-OFF  
 • SPST ON-OFF TOGGLE SWITCH  
 • Mount Size : 12/25"  
 • 10A 250V  
 • 20A 125V  
 • 2 PINS



**EC-1523**

S.P.D.T. TOGGLE SWITCH ON-OFF-ON  
 • 117V AC  
 • Current Rating: 10A-250V AC, 15A-125V AC  
 • 20 Amp  
 • 6 P



**EC-1535**

S.P.D.T. ON-OFF-ON TOGGLE SWITCH  
 • Current Rating: 15A 125V AC, 10A-250V AC  
 • 3 Pins



**EQ-CON-12V**

REPLACEMENT MOLEX TYPE  
 POWER CONNECTOR FOR  
 • EQ, Crossovers and other  
 Audio Processors



**EC-1115**

ON-OFF CONNECTOR SWITCH  
 • Current Rating: 3A 250V, 6A125V  
 • 2 Pins  
 • 1/2 x 11/32



**EC-1115PP**

ON-OFF CONNECTOR SWITCH  
 • Current Rating: 3A 250V, 6A125V  
 • 3 Pins  
 • 3/4 x 1/2



**EC-1210**

MINI ROCKER SWITCH  
 • Mount Hole: 1/2" x 3/4"  
 • Current Rating: 10A 12V  
 • 2 Pins  
 • 3/4 x 1/2



**EC-2215P**

CONNECTOR (ON) & ON-OFF 10A25  
 • Switch 10A250V / 15A125V  
 • 6 Pins  
 • 1 x 13/16



**EC-623**

3 POSITION WITH LIGHT  
 • DPST On-Off Switch with Red Light  
 • Current Rating: 20A 125V  
 • 6 Pins  
 • 1 x 7/8



**EC-1220BLU**

MINI ROCKER SWITCH WITH BLUE  
 COLOR LED  
 • Mount Hole: 1/2" x 3/4"  
 • Current Rating: 10A 12V  
 • 3 Pins  
 • 1-1/16 x 1/2



**EC-1220RED**

MINI ROCKER SWITCH WITH RED  
 COLOR LED  
 • Mount Hole: 1/2" x 3/4"  
 • Current Rating: 10A 12V  
 • 3 Pins  
 • 1-1/16 x 1/2



**EC-1220WHT**

MINI ROCKER SWITCH WITH WHITE  
 COLOR LED  
 • Mount Hole: 1/2" x 3/4"  
 • Current Rating: 10A 12V  
 • 3 Pins  
 • 1-1/16 x 1/2

SWITCHES



**EC-2602**

- SPST ON-OFF SWITCH  
 • Current Rating: 20A 125V AC  
 • 2 Pins  
 • 1 x 13/32



**EC-2604**

- DPST ON-OFF SWITCH  
 • Current Rating: 10A 125V AC  
 • Mounting Diameter with Red Light  
 • 4 Pins  
 • 1 x 13/16



**EC-2606**

- DPST ON-OFF SWITCH  
 • Current Rating: 10A 125V AC  
 • Mounting Diameter with Red Light  
 • 6 Pins  
 • 1 x 13/16



**EC-2636**

- DPDT ON-OFF-ON MINI TOGGLE SWITCH  
 • Current Rating: 3A 125V AC  
 • Mounting Diameter with Red Light  
 • Mount Size: 1" x 13/16"  
 • 6 Pins  
 • 1 x 7/8



**EC-315**

- 15 AMP WITH LIGHT  
 • DPST On-On Switch with Red Light  
 • Current Rating: 15A 125V AC  
 • 3 Pins  
 • 1 x 1/2



**EC-620**

- 20 AMP WITH LIGHT  
 • DPST On-Off Switch with Red Light  
 • Current Rating: 20A 125V  
 • Mounting Diameter  
 • 6 Pins  
 • 1 x 13/16

SWITCHES



**EC-1103**

- 110V AC ROUND ROCKER SWITCH  
 • Current Rating: 6A 250V, 10A 125V  
 • 3 Pins  
 • For 110V Applications



**EC-1103ABL**

- 110V AC ROUND ROCKER SWITCH  
 w/BLUE- AC Voltage Switch.  
 • Current Rating: 6.5A 250V, 13A 125V  
 • 3 Pins  
 • For 110V Applications



**EC-1103ARD**

- 110V AC ROUND ROCKER SWITCH  
 w/AC Voltage Switch.  
 • Current Rating: 6.5A 250V, 13A 125V  
 • 3 Pins  
 • For 110V Applications



**EC-1210SCR**

- 10A 124V AC  
 • 6A 250V AC



**EC-1213BLU**

- 12V DC ROUND ROCKER SWITCH w/BLUE  
 • Mini Rocker Switch with Blue Color LED  
 • Mount Hole: 3/4"  
 • 3 Pins



**EC-1213RED**

- 12V DC ROUND ROCKER SWITCH w/RED  
 • Mini Rocker Switch with Red Color LED  
 • Mount Hole: 3/4"  
 • 3 Pins

# INSTALLATION

## SWITCHES



### EC-1215

- RED ROUND ROCKET SWITCH W/RED  
 • Mini Rocker Switch with Red Color LED  
 • Mount Hole: 3/4"  
 • Current Rating: 10A 12V.



### EC-1213

- ROUND ROCKET SWITCH  
 • Mount Hole: 3/4"  
 • 2 Pins  
 • Current Rating: 10A 12V



### EC-1217BLU

- ROUND ROCKET SWITCH W/BLEU LED  
 • Mini Rocker Switch with Blue Color LED  
 • Mount Hole: 3/4"  
 • Current Rating: 10A 12V



### ECR-12615

- 3A 30V DC  
 • 6A 12V DC  
 • Contact R: 50mΩ Max  
 • Insulation R: 500V DC 100MΩ Min



### NB-803M

- 3A 125V AC  
 • 1A 250V AC  
 • Mounting Size: 12mm  
 • Colors: BLK, BLU, RED, WHT, YLW



### NB-804M

- 4A 125V AC  
 • 2A 250V AC  
 • Mounting Size: 19mm



### NB-804PA

- MOMENTARY SWITCH  
 • 4A 125V AC  
 • 2A 250V AC  
 • Mounting Size: 19mm



**For boat horns, starter switches, and other applications in which temporary activation of an electrical current is desired. Operation Type: Momentary**

# INSTALLATION

## SWITCHES



### IS-EC-IR1216BLU

- MINI ROCKER SWITCH WITH BLUE COLOR LED AND 6" LEAD WIRE  
 • Mount Hole: 1/2" x 3/4"  
 • Current Rating: 16A, 12V  
 • 3 Pins



### IS-EC-IR1216RED

- MINI ROCKER SWITCH WITH RED COLOR LED AND 6" LEAD WIRE  
 • Mount Hole: 1/2" x 3/4"  
 • Current Rating: 16A, 12V  
 • 3 Pins



### IS-EC-RS12513

- MINI ROCKER SWITCH WITH 6" LEAD WIRE  
 • Current Rating: 6.5A, 250V; 13A, 125V AC  
 • 2 Pins



### IS-EC-RS1216BLU

- MINI ROCKER SWITCH WITH BLUE COLOR LED AND 6" LEAD WIRE  
 • Current Rating: 16A, 12V  
 • Mount Hole Size: 1/2" x 4/5"  
 • 3 Pins



### IS-EC-RS1216RED

- MINI ROCKER SWITCH WITH RED COLOR LED AND 6" LEAD WIRE  
 • Current Rating: 16A, 12V  
 • Mount Hole Size: 1/2" x 4/5"  
 • 3 Pins

### NL-LBKT-10

LED Light Bar Wiring Kit  
 w/Switch Fuse and Relay





**NB-602PA**  
MOMENTARY PUSH BUTTON  
• Push to Activate  
• Current Rating: 3A 125V AC  
• 2 Pins



**NB-602PD**  
MOMENTARY PUSH BUTTON  
• Push to Deactivate  
• Current Rating: 3A 125V AC  
• 2 Pins



**NB-802**  
PUSH BUTTON SWITCH ON-OFF  
• SPST On-Off Mini Push Button Switch  
• Square  
• Current Rating: 3A 125V AC



**NB-805**  
PUSH SWITCH  
• Current Rating: 3A 125V AC  
• 2 Pins

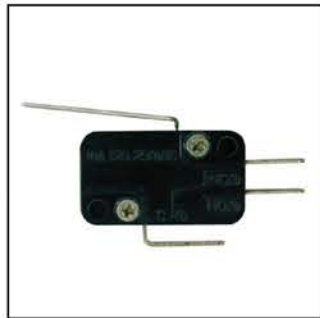

**EC-284**  
SPDT ON-ON MICRO SWITCH  
• Current Rating: 10A 125V AC  
• 2 Pins

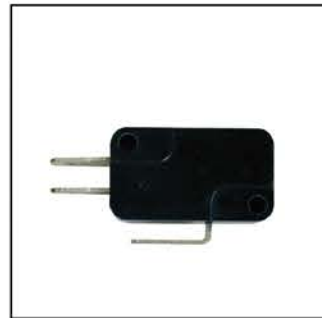

**EC-285**  
MICRO SPDT ON-ON MICRO SWITCH  
• Current Rating: 3A 125V AC  
• 3 Pins



**VS-1122**  
VOLTAGE SWITCH  
• 3 Pins  
• 110/220 V



**IS-LD-AVMS-12**  
AMPERE VOLTAGE METER SOCKET  
• Input 12-24V, 5A  
• Blue LED Display  
• Material: High Quality Nylon Plastic Socket Body  
• Fitment: Universal Fits for 12-24V Vehicle, Motorcycle, ATV, Boat, Car or Marine



**IS-LD-DVS-12**  
DIGITAL VOLTMETER SOCKET  
• Blue LED Display  
• Material: High Quality Nylon Plastic Socket Body  
• Fitment: Universal Fits for 12-24V Vehicle, Motorcycle, ATV, Boat, Car or Marine



**IS-LD-USBVS-12**  
SINGLE USB WITH VOLTMETER SOCKET  
• Input 12-24V; Output: 5A, 2.1A  
• Single USB Fast Charger  
• Blue LED Display  
• Material: High Quality Nylon Plastic Socket Body  
• Fitment: Universal Fits for 12-24V Vehicle, Motorcycle, ATV, Boat, Car or Marine



**IS-EC-12MT-BLU**  
ROUND ROCKER TOGGLE SWITCH SPST ON-OFF CONTROL WITH SWITCH HOUSING & BLUE LED  
• Easy Setup. All you Need is a 3/4" Hole and the Switch will Sit in Nicely  
• Frames are Nylon, Terminals are Silver Plated Brass  
• Illumination: DOT Styled, 12V LED Light  
• Type: 3 Pins with LED SPST: ON-OFF  
• Rating: 12V / DC. 20A  
• LED Color: Blue  
• Size: 37x29mm



**IS-ALD-2UV-BLK**

USB CHARGER W/ VOLTAGE DISPLAY

- Product(hole) Size: 37x49x28.8mm
- 36g
- 7075 Aluminum
- Input Voltage: 12-24V
- Output Voltage: 5V
- Blue LED display
- Body color: Black



**IS-ALD-2UV-BLU**

USB CHARGER W/ VOLTAGE DISPLAY

- Product(hole) Size: 37x49x28.8mm
- 36g
- 7075 Aluminum
- Input Voltage: 12-24V
- Output Voltage: 5V
- Blue LED display
- Body color : Blue



**IS-ALD-2UB-BLK**

USB CHARGER W/ VOLTAGE & AMP DISPLAY

- Product(hole) Size: 37x49x28.8mm
- 32g
- 7075 Aluminum
- Input Voltage: 12-24V
- Output Voltage: 5V
- Output Current: 2.1A+2.1A
- Blue LED display
- Body color : Black



**IS-ALD-UVA-BLK**

USB CHARGER W/ VOLTAGE & AMP DISPLAY

- Product(hole) Size: 37x49x28.8mm
- 27g
- 7075 Aluminum
- Input Voltage: 12-24V
- Output Voltage: 5V
- Blue LED display
- Body color: Black



**IS-EC-PRSM1**

SINGLE HOLE PANEL DASHBOARD MOUNT CAR CHARGER OUTLET SOCKET ADAPTER

- Easily installed in any car, motorcycle, ATV, boat, riding mower, etc.
- Color: Black
- Material: ABS
- Fire retardant
- Size: 53x49x78mm



**IS-EC-PRSM2**

DUAL HOLE PANEL DASHBOARD MOUNT CAR CHARGER OUTLET SOCKET ADAPTER

- Easily installed in any car, motorcycle, ATV, boat, riding mower, etc.
- Color: Black
- Material: ABS
- Fire retardant
- Size: 96x49x78x71mm

**PROW-2002**

UNIVERSAL POWER WINDOWS WITH 3 SWITCHES (2 WINDOW POWER WINDOW KIT)

- Complete Kit to Convert 2 Windows to Full Power
- Universal for All Automobiles
- Converts 2 Manual Windows to Power Window
- Perfectly Suited for any Type of Door, Front or Rear
- Power Window System is Installed Behind the Door Panel
- Does not Change the Exterior Design of the Door Panel
- Power Window Motors are Extremely Quiet
- Cuprum Bearing
- POM Plastic Gear Wheel



**PROW-4004**

DELUXE UNIVERSAL POWER WINDOWS WITH 7 SWITCHES (4 WINDOW POWER WINDOW KIT)

- Complete Kit to Convert 4 Windows to Full Power
- Universal for All Automobiles
- Converts 4 Manual Windows to Power Window
- Perfectly Suited for any Type of Door, Front or Rear
- Power Window System is Installed Behind the Door Panel
- Does not Change the Exterior Design of the Door Panel
- Power Window Motors are Extremely Quiet
- Cuprum Bearing
- POM Plastic Gear Wheel



# INSTALLATION

## WINDOW ACCESSORIES

# INSTALLATION

## ACCESSORIES



**EWD-151**  
 • 12V 24V  
 • 5A-15A



**EWD-153**  
 • 12V 24V  
 • 5A-15A



**EWD-155**  
 • 12V 24V  
 • 5A-15A



**EWD-157**  
 • 12V 24V  
 • 5A-15A



**ISO-RM**  
 DELAY OUTPUT CONTROLLER  
 • Operating Voltage: 12V



**ISO-UT7**  
 CHANNEL DELAY SWITCH CONTROLLER  
 • Negative Trigger Module



**EC-4066-4.3**  
 • 6x6x4.3mm  
 • Black  
 • 180 GF  
 • DIP



**EC-4066-5.0**  
 • 6x6x5mm  
 • Black  
 • 180 GF  
 • DIP



**EC-4063-4.3**  
 • 3x6x4.3mm  
 • White  
 • 180 GF  
 • DIP



**IS-1005SK**  
 5 WIRE RELAY SOCKET  
 • Connection Type: Pigtail  
 • Length: 12"  
 • Gauge: 16  
 • Quantity: 10

**Pre-wired relay socket for use with 12V DC Bosch type five terminal relays. Suitable for use with high power LED Off Road Bars, AUX lights, Work Lights and other custom applications.**



COMPATIBLE WITH 40ARB  
 RELAY NOT INCLUDED



**EC-4112D**  
 MINI SWITCH 12 x 12  
 • Thru Mount  
 • Current Rating: 0.1A 12V  
 • 4 Downward Pins

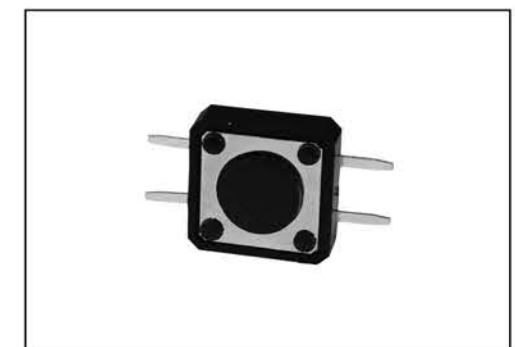

**EC-4112S**  
 MINI SWITCH 12 x 12  
 • Surface Mount  
 • Current Rating: 0.1A 12V  
 • 4 Side Pins



**614**  
DOOR ALARM PIN-SHORT-  

- Accepts 5-Pin through 7-Pin Standard and Interchangeable Core Rim Cylinders
- Saw Resistant Dead Bolt



**PRO-1000**  
RELAY SOCKET  

- with Diode

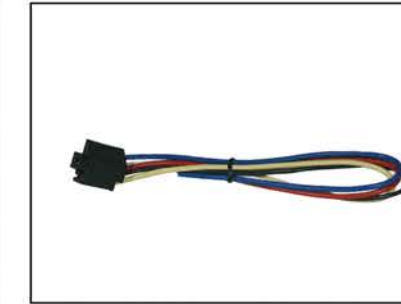

**PRO-1005**  
RELAY SOCKET  

- 5 Wire



**PRO-1020**  
RELAY SOCKET  

- Dual



**617**  
HEAVY DUTY ALARM PIN SWITCH  

- The Code Alarm is a Universal Pin Switch that Will Work for Most Brand of Car Alarms



**618**  
ADJUSTABLE METAL PIN SWITCH  

- Especially Good for Car Bonnets, this Heavy Duty Pin Switch is Nickel-Plated for Protection from Corrosion in Hostile Environments



**40ISR**  
RELAY SOCKET  

- Current: 40A



**40ARB**  
RELAY SOCKET  

- 40 A
- 14 VDC
- DC 12V



**80ARB**  
RELAY SOCKET  

- 80A/14V DC
- 60A/14VDC
- DC 12V



**600V**  

- Van Sliding Door Contact Switch



**621**  

- Cuttable Plastic Pin Switch



**AQK-P14FM**  
MALE/FEMALE TERMINAL  

- 14 Gauge
- 2'
- Security Lock



**30ARF**  
RELAY SOCKET  

- 30 ARF 12V 30A/40A



**40AMP**  
RELAY SOCKET  

- 40A/14VDC
- 30A/14VDC
- DC 12V





**CDLS-MD5**  
ACTUATOR MODULE  
• For Auto Lock



**IS-CDLS-05M**

- 5 WIRE CAR CENTRAL LOCK
- With 360-Degree Rotation Head for Easy Installation
  - Working Force:  $\geq 2.5\text{Kg}$
  - Working Stroke: 19mm
  - Working Life > 100000 Times
  - Strong Iron Back Strap
  - Iron Fixed Block
  - Pull Rod



**IS-CDLS-10R**

- ADJUSTABLE AUTOMATIC AUTO LOCK W/RING
- 2 Wires Gun Type Actuators
  - With 360-Degree Rotation Head for Easy Installation
  - Working Force  $\geq 2.5\text{Kg}$
  - Working Stroke: 19mm
  - Working Life > 100000 Times
  - Strong Iron Back Strap
  - Iron Fixed Block
  - Pull Rod

**IS-CDLS-40R**

- CENTRAL DOOR LOCKING SYSTEM
- Applicable for all Cars(4 Door) and can be Connected with Remote Controller and Alarm Security
  - With 1 Pieces 5 Wires Gun Type Actuators
  - With 3 Pieces 2 Wires Gun Type Actuators
  - With 360-Degree Rotation Head for Easy Installation
  - Working Force  $\geq 2.5\text{Kg}$
  - Working Stroke: 19mm
  - Working Life > 100000 Times
  - Strong Iron back Strap
  - Iron Fixed Block
  - Pull Rod



- ANL-60A (60 Amp)
  - ANL-80A (80 Amp)
  - ANL-100A (100 Amp)
  - ANL-150A (150 Amp)
  - ANL-175A (175 Amp)
  - ANL-200A (200 Amp)
  - ANL-225A (225 Amp)
  - ANL-250A (250 Amp)
  - ANL-300A (300 Amp)
- VISIBLE THROUGH MICA WINDOW
- Voltage Rating: 32V
  - 2 PCs Per Blister



- ATM-LPM-15 (15 Amp)
  - ATM-LPM-20 (20 Amp)
  - ATM-LPM-25 (25 Amp)
  - ATM-LPM-30 (30 Amp)
- LOW-PROFILE MINI FUSES
- Transparent Body
  - Voltage Rating: 32V
  - 25 PCs Per Blister Pack



- AFC-30 (30 Amp)
  - AFC-40 (40 Amp)
  - AFC-50 (50 Amp)
  - AFC-60 (60 Amp)
  - AFC-80 (80 Amp)
  - AFC-120 (120 Amp)
  - AFC-150 (150 Amp)
- MIDGET CAR FUSES
- Transparent Body
  - Voltage Rating: 32V
  - 5 PCs Per Blister Pack

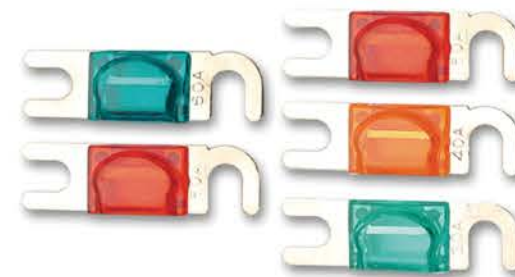

- IS-AST-3A
- IS-AST-7.5A
- IS-AST-10A
- IS-AST-15A
- IS-AST-20A
- IS-AST-25A
- IS-AST-30A

- TERMINAL CAR FUSES
- Transparent Body
  - Voltage Rating: 32V
  - Ampere Rating Body Color
- |         |           |
|---------|-----------|
| 3 A     | Violet    |
| 4 A     | Pink      |
| 5 A     | Tan       |
| 7-1/2 A | Brown     |
| 10 A    | Red       |
| 15 A    | Lt. Blue  |
| 20 A    | Yellow    |
| 25 A    | Natural   |
| 30 A    | Lt. Green |
- Replaces Min and ATM Fuses
  - 25 PCs Per Blister Pack



AGU-40A  
AGU-50A  
AGU-60A  
AGU-70A  
AGU-80A  
AGU-100A



**GOLD PLATED MIDGET CAR FUSES**

- 10.3Ø x 38.10mm (13/32 x 1-1/2 inch)
- Voltage Rating: 32 V/125 V/250 V
- Ampere Rating: 1, 2, 3, 4, 5, 6, 7-1/2, 10, 15, 20, 25, 30, 35, 40, 50, 60, 70, 80, 100.
- Replaces AGU and 4AG Fuses
- 5 PCs per Blister Pack

IS-ATM-LP-10  
IS-ATM-LP-20



**LOW PROFILE ATM MINI FUSES**

- ATM Low Profile Fuse
- Nickel Plated Blade, Polycarbonate Housing
- 10 & 20 Amp
- 25 Pack
- For your Car, SUV, Truck, Home, Boat, Camper, RV, ATV, UTV, Golf Car, and most electrical devices!

**Fuses are color coded with documentation for quick confident identification, and easy installation. These mini fuses can replace 'low profile' mini fuses but it may not be leveled in the compartment.**



IS-ANL-2310

**HEAVY DUTY ANE (ANL) FUSE HOLDER**

- Water Resistant
- All Metal Parts are 24kt Gold finish
- Includes a 150A ANE (ANL) fuse
- Accepts 0 to 4 Gauge Cable Wire
- Perfect Contact for Power Cable
- Set Screw Design – No Crimping required



FGMAC-1 / FGMAC-10  
FGMAC-2 / FGMAC-3  
FGMAC-4 / FGMAC-6.3  
FGMAC-8

**CERAMIC FUSES (100 piece set)**

- Ideal for microwave ovens and flat panel TV's



FC-10A / FC-12A  
FC-15A / FC-20A  
FC-25A / FC-30A

**CERAMIC FUSES**

- Available in 10, 12, 15, 20, 25, & 30 amps
- Ideal for microwave ovens and flat panel TVs



IS-ANLF-9310

**IN-LINE ANL FUSE HOLDER**

- Clear Housing with Mounting Base
- 1 FT (0.3M) 0Ga Red Power Cable
- 24Kt Finish Fuse Holder
- Water Resistant
- Perfect Fit for 4 or 0 Gauge Power Cable
- Connect Base is Precision Machined



FM .25 / FM 0.5 / FM 1  
FM 1.5 / FM 2 / FM 2.5  
FM 3 / FM 3.15 / FM 3.5  
FM 4 / FM 5 / FM 6  
FM 6.3 / FM 7 / FM 8  
FM 9 / FM 10 / FM 15

**MINIATURE FUSES**

- 100 piece set
- 250V



FN .5 / FN 1 / FN 1.5 / FN 10 / FN 15  
FN 2 / FN 2.5 / FN 20 / FN 25 / FN 3  
FN 3.5 / FN 30 / FN 4 / FN 5 / FN 6  
FN 7



IS-N2C

**IN-LINE AGU FUSE HOLDER**

- Clear Housing with Mounting Base
- 24Kt Finish Fuse Holder
- Water Resistant
- Perfect Fit for 8 or 4 Gauge Power Cable
- Accepts AGU fuse up to 80 Amps
- Connect Base is Precision Machined

**AMT-60A (60 Amp)**

**MAXI TERMINAL CAR FUSES**

- Transparent Body
- Voltage Rating: 32V
- Ampere Rating Body Color
- 3 A Violet
- 4 A Pink
- 5 A Tan
- 7-1/2 A Brown
- 10 A Red
- 15 A Lt. Blue
- 20 A Yellow
- 25 A Natural
- 30 A Lt. Green
- 5 PCs Per Blister Pack



- IS-ATO-3
- IS-ATO-4
- IS-ATO-5
- IS-ATO-7.5
- IS-ATO-10
- IS-ATO-15
- IS-ATO-20
- IS-ATO-25
- IS-ATO-30
- IS-ATO-40

- TERMINAL CAR FUSES**
- Transparent Body
  - Voltage Rating: 32V
  - 25 PCs Per Blister Pack
  - Ampere Rating Body Color
  - 20 A Yellow
  - 30 A Lt. Green
  - 35 A Lt. Red
  - 40 A Orange
  - 50 A Red
  - 60 A Lt. Blue
  - 70 A Tan
  - 80 A Transparent

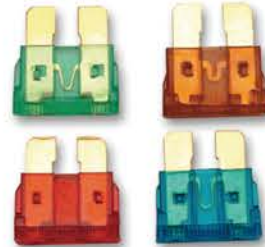

**IS-1020**

- POWER DISTRIBUTION BLOCK**
- One 0GA or 2GA Input, Two 4GA & Two 8GA Output
  - Platinum Finish



**IS-FBG-4328**

- 2 POSITION AGU FUSE HOLDER**
- 24Kt Finish Fuse Holder
  - One 2 Gauge or Two 4GA Input and Two 8 Gauge Outputs
  - Inner Steps Ensure Perfect Recessed Fits Cable into Block
  - Base is Precision Machined

**FS-1  
FS-2**

- Chassis Mount Normal Fuse Holder



**HD-013**

- In-line Fuse Holder for Car Stereo



**IS-160**

- GROUND LOOP ISOLATOR**
- 2-CH Signal Output
  - Signal Noise Eliminator



**IS-210**

- Ground Loop Isolator
- 2-CH Signal Output
- Signal Noise Eliminator



**IS-NR12**

- NOISE SUPPRESSOR**
- 10 Amp
  - Eliminates Engine and Alternator Noise
  - Car Audio, Marine, CB and other 12V Applications
- This power line noise suppressor is designed to eliminate the noise in power line and let the car stereo or CB perform at its optimum



**IS-NR35**

- Line Output Converter
- High/Low Level Converter
- Signal Noise Eliminator
- 2-CH Signal Outputs



**IS-NR100**

- Line Output Converter
- High/Low Level Converter
- Signal Noise Eliminator
- 2-CH Signal Outputs
- Output Level Adjustable



**IS-RM200**

- HI/LO CONVERTER WITH REMOTE TURN ON**
- Line Output Converter with Remote turn ON
  - Gold Female RCA Output
  - Adjustable Line Output Converter
  - Converts from 10 to 25 Watts per Channel to Pre-Amp Output
  - Remote Turn ON Circuit



**IS-MVA4**

- One RCA Video Input
- Four RCA Video Output
- Video Input Level: 2.0Vpp
- Output Impedance: 75 Ohm
- Independent Video Level Control

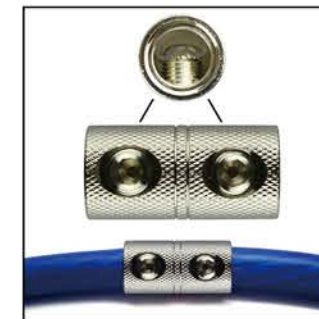

**IS-020**

- Nickel-Plated Finish
- Ideal for Power or Ground Cable
- Set Screw ensures Tight Connection
- Ultra Conductive



**IS-POP10**

- Pop Stopper
- Time Delay Circuit Eliminates "Turn-On Pops"
- Time Delay Circuit Eliminates "Turn-Off Pops"

**IK-4GA**

1000 WATT 4 GA HEAVY-DUTY AC POWER INVERTER CABLE KIT

- 10FT Standard 4 Gauge Primary Wire (Red)
- 10FT Standard 4 Gauge Primary Wire (Brown)
- 8FT Standard 8 Gauge Primary Wire (Brown)
- (Two) Red 4 Gauge Ring Tongue Terminals
- (Two) Black 4 Gauge Ring Tongue Terminals
- (One) Red 8 Gauge Ring Tongue Terminal
- (One) Black 8 Gauge Ring Tongue Terminal



**IS-K800**

AMPLIFIER INSTALLATION KIT

- 17' 10GA Red Power Cable
- 3' 10GA Black Power Cable
- 15' 2-RCA to 2-RCA Plugs Cable with Signal Wire
- 3' Split Loom Tubing
- 10 AWG Fuse Holder
- 30A ATC Fuse
- 10 Pcs. Cable Ties
- Ring Terminal 1+1 Pcs
- Spade Terminal 5 Pcs
- Butt Splices 2 Pcs



**IS-K1700**

AMPLIFIER INSTALLATION KIT

- 17' 8GA Red Power Cable
- 3' 8GA Black Power Cable
- 17' 2-RCA to 2-RCA Plugs Cable with Signal Wire
- 3' Split Loom Tubing
- AFC Fuse Holder
- 60A AFC Fuse
- 10 Pcs. Cable Ties
- Ring Terminal 1+1+1 Pcs
- Spade Terminal 3 Pcs
- Butt Splices 2 Pcs



**IS-K2500**

AMPLIFIER INSTALLATION KIT

- 17' 4GA Red Power Cable
- 3' 4GA Black Power Cable
- 17' 2-RCA to 2-RCA Plugs Cable with Signal Wire
- 3' Split Loom Tubing
- AFC Fuse Holder
- 100A AFC Fuse
- 10 Pcs. Cable Ties
- Ring Terminal 1+1 Pcs
- Spade Terminal 2 Pcs
- Butt Splices 2 Pcs



**IS-K3500**

AMPLIFIER INSTALLATION KIT

- 17' 0GA Red Power Cable
- 3' 0GA Black Power Cable
- 17' 2-RCA to 2-RCA Plugs Cable with Signal Wire
- 3' Split Loom Tubing
- ANL Fuse Holder
- 250A ANL Fuse
- 10 Pcs. Cable Ties
- Ring Terminal 1+1 Pcs
- Spade Terminal 2 Pcs
- Butt Splices 2 Pcs



**IS-K1700P**

AMPLIFIER INSTALLATION KIT

- 17' 8GA Blue Power Cable
- 3' 8GA Silver Power Cable
- 17' 2-RCA to 2-RCA Plugs Cables with Signal Wire
- 3' Split Loom Tubing
- AFC Fuse Holder
- 60A AFC Fuse
- 10 Pcs Cable Ties
- Ring Terminal 1+1+1 Pcs
- Spade Terminal 3 Pcs
- Butt Splices 2 Pcs



NOW INCLUDES:  
60A AFC Holder & Fuse

**IS-K2500P**

AMPLIFIER INSTALLATION KIT

- 17' 4GA Blue Power Cable
- 3' 4GA Silver Power Cable
- 17' 2-RCA to 2-RCA Plugs Cables with Signal Wire
- 3' Split Loom Tubing
- AFC Fuse Holder
- 100A AFC Fuse
- 10 Pcs Cable Ties
- Ring Terminal 1+1 Pcs
- Spade Terminal 2 Pcs
- Butt Splices 2 Pcs



NOW INCLUDES:  
100A AFC Holder & Fuse



**IS-SP-14-1000BR**

SPEAKER CABLE

- 14 Gauge
- 1000 FT.
- 305 M

1000 FT./305 M



**IS-SP-16-1000BR**

SPEAKER CABLE

- 16 Gauge
- 1000 FT.
- 305 M

1000 FT./305 M



**IS-SP-18-1000BR**

SPEAKER CABLE

- 18 Gauge
- 1000 FT.
- 305 M

1000 FT./305 M

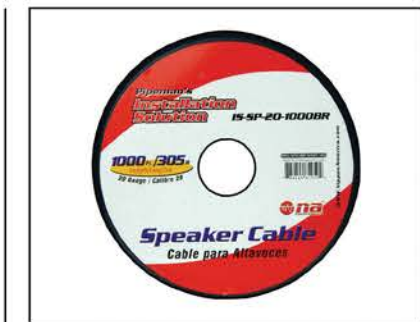

**IS-SP-20-1000BR**

SPEAKER CABLE

- 20 Gauge
- 1000 FT.
- 305 M

1000 FT./305 M



# INSTALLATION

## CABLES



**IS-SP-10-500CL**  
SPEAKER CABLE  
• 10 Gauge  
• 500 FT.

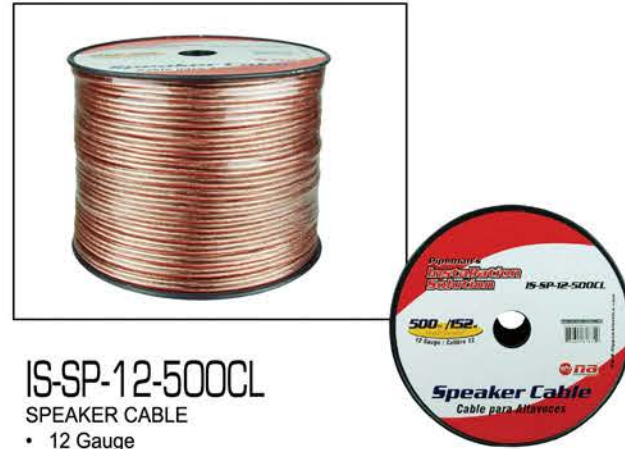

**IS-SP-12-500CL**  
SPEAKER CABLE  
• 12 Gauge  
• 500 FT.



**IS-SP-14-1000CL**  
SPEAKER CABLE  
• 14 Gauge  
• 1000 FT.



**IS-SP-16-1000CL**  
SPEAKER CABLE  
• 16 Gauge  
• 1000 FT.



**IS-SP-18-1000CL**  
SPEAKER CABLE  
• 18 Gauge  
• 1000 FT.

# INSTALLATION

## CAMERA ACCESSORIES

### IS-RLC-245G-BLK

#### CAR REAR VIEW CAMERA

- High Resolution
- Super Low Illumination
- Weather-Proof: IP 65
- Anti-Fog Function
- Wide Angle (120-170°)
- Easy to Install
- 9"x6-3/4"

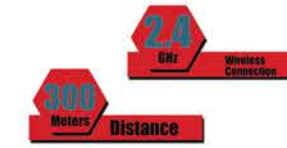

### IS-RVC-170MI

#### MINI CAR REARVIEW CAMERA

- Working Voltage: 10-15V (12V in car)
- Working Temperature: -20 °C~70°C
- Video: NTSC
- Water-Proof: IP67-IP68
- Min-Illumination: 0.1 LUX
- Resolution (TV LINES): 480



### IS-RVMR-43

#### CAR REARVIEW MINI CAMERA

- Screen: 4.30inch
- Power Input: 12V
- Display Format: 16:0.9
- The Brightness of the Screen will Adjust Automatically to its Environment's Lighting Conditions



### IS-BUP400-BLK

#### INTELLIGENT PARKING ASSISTANCE SYSTEM

- Automatically Works when Reversing
- High-Tech Processing
- Digital LED Display
- Four Step Beep Alarm
- Detect Distance is 0-2m
- 4 Sensors
- Voltage: 9~15V DC
- Includes 4 Sensors
- Rated Voltage: 12V DC
- Power Time: <0.5W
- Response Time: 0.3~2.0m
- Sensor Diameter: 22mm
- Sensor Angle: x y 60 °
- Alarm Volume: 65 dB
- Work Temperature: -30 °C~+80 °C
- Power (Wireless): 10mW





**IS-RVC-165GL**  
CAR REAR VIEW CAMERA

- Water-Proof & Dust-Proof
- High Definition
- Night Vision & Wide Angle
- Voltage: 8-15V
- Size:  $\Phi$ 16.5 x 22(H) mm



**IS-RVC-185GL**  
CAR REAR VIEW CAMERA

- Water-Proof & Dust-Proof
- High Definition
- Night Vision & Wide Angle
- Voltage: 8-15V
- Size:  $\Phi$ 18.5 x 32(H) mm



**IS-RVC-803GL**  
CAR REAR VIEW CAMERA

- Water-Proof & Dust-proof
- High Definition
- Night Vision & Wide Angle
- Voltage: 8-15V
- Size:  $\Phi$ 20 x 30(H) mm



**IS-RVC-841TRJ**  
CAR REAR VIEW CAMERA

- 4 LED Night Light
- Image Device: FXP8341 1/3 Color CMOS
- TV System: NTSC/PAL can be Chosen
- Effective Pixel: 720 x 480
- IP Rating: IP67
- Definition: 600 TV Lines



**IS-RVC-258GL**  
CAR REAR VIEW CAMERA

- Water-Proof & Dust-Proof
- High Definition
- Night Vision & Wide Angle
- Voltage: 8-15V
- Size:  $\Phi$ 18 x 20(H) mm



**IS-RVC-360ROT**  
CAR REAR VIEW CAMERA

- Water-Proof & dust-Proof
- High Definition
- Night Vision
- 120 Degree Wide Angle View
- Voltage: 8 - 15V
- Size: 22.5 x 25mm



**IS-CF512**

- 5" Cross Flow Cooling Fan
- Compatible with all 12 Volt Systems
- Comes Equipped with Mounting Tabs for Simple Installation
- Low Profile Cross Flow Design Allows Installation in Tight Fitting Spaces
- Puts out 40 Cubic Feet of Air Flow per Minute

**IS-CF812**

- 8" Cross Flow Cooling Fan
- Compatible with all 12 Volt Systems
- Comes Equipped with Mounting Tabs for Simple Installation
- Low Profile Cross Flow Design Allows Installation in Tight Fitting Spaces
- Puts out 40 Cubic Feet of Air Flow per Minute



**FAN-33**

- EXTREMELY EFFICIENT
- 2 3/8" x 2 3/8" x 1"
  - 28 Cubic Feet per Minute
  - 12V 0.8A



**FAN-550HS**

- EXTREMELY EFFICIENT
- 4.7" (H) x 4.7" (W) x 1.5" (D)
  - Current: 2A, Power: 24W
  - Speed: 4350RPM



**FAN-55**

- EXTREMELY EFFICIENT
- 4 6/8" x 4 6/8" x 1.5"
  - 106 Cubic Feet per Minute
  - 12V 1.0A



**This fan is excellent for keeping your amplifier cool or ventilating your extra battery compartment**



**ISRS-350**  
DUAL CONE CAR SPEAKER  
• 3.5"  
• 45 Watts



**ISRS-400**  
DUAL CONE CAR SPEAKER  
• 4" Dual  
• 45 Watts



**ISRS-460**  
4X6" DUAL CONE CAR SPEAKER  
• Output Power: 75 Watts (P.M.P.O.)  
35Watts (R.M.S.)  
• Frequency Response: 52Hz~2KHz  
• Sensitivity: 88dB/W(1M)  
• Impedance: 4 Ohm



**ISRS-500**  
DUAL CONE CAR SPEAKER  
• 5.25"  
• 65 Watts



**ISRS-600**  
DUAL CONE CAR SPEAKER  
• 6"  
• 75 Watts



**ISRS-680**  
DUAL CONE CAR SPEAKER  
• 6 x 8"  
• 70 Watts



**ISRS-690**  
DUAL CONE CAR SPEAKER  
• 6 x 9"  
• 75 Watts

**NA-1500**

- PILLAR SIDE MOUNT ANTENNA
- 3 Sections
  - Extends to 47.2"
  - Cable: 50"
  - Fits Most Nissan and Toyota Pick-Up Trucks
  - Silver Finish



**NA-1500B**

- PILLAR SIDE MOUNT ANTENNA
- 3 Sections
  - Extends to 48"
  - Cable: 48"
  - Fits Most Cars
  - Black Finish



**NA-1502**

- FRONT/REAR FENDER/ROOF MOUNT ANTENNA
- 3 Sections
  - Extends to 47"
  - Cable: 54"
  - Fits Most Cars
  - Flexible Spring and Deluxe Ball Base



**NA-1508**

- FRONT/REAR FENDER/ROOF MOUNT ANTENNA
- 1 Section
  - Extends to 17"
  - Cable: 54"
  - Fits Most Cars
  - Swivel Ball Base 180° Adjustable Angle



**NA-1599**

- CAR ANTENNA
- Universal Side Mount
  - Detachable Mast
  - 1 Section
  - Extends to 31"
  - Cable: 72"



**SIDE MOUNT**



**NA-1514**

**NARROW FENDER MOUNT ANTENNA**

- 4 Sections
- Extends to 39"
- Cable: 48"
- Fits VW Beetle, Bus and Transporter Audi Auant, Citroen CX, Peugeot 104/204/304/404, Renault 12, Toyota Starlet
- 52° Fixed Angle



**NA-1517L**

**PILLAR SIDE MOUNT ANTENNA**

- 3 Sections
- Extends to 48"
- Cable: 48"
- Fits Toyota Corolla ('78-'83), Tercel ('80-'82), and Mazda GLC ('76-'80)



**NA-1524**

**UNIVERSAL FRONT OR REAR DECK ANTENNA**

- 1 Ssection Spring Whip
- Extends to 31"
- Cable: 54"



**NA-1532**

**UNIVERSAL FRONT OR REAR DECK ANTENNA**

- 3 Sections
- Flexible Spring and Deluxe Ball Base
- Spring Base Booster Type
- Adjustable to 180° Angle
- Extends to 45"
- Cable: 54"



**NA-1533**

**UNIVERSAL ANTENNA**

- Fits Toyota Corolla ('93 & Up)
- 1 Section
- Extends to 31"
- Cable: 82"



**NA-SPAD-C**

**TRUCK SHOCK SPRING ANTENNA ADAPTER**

- The Semi-Flexible Mast Helps withstand Bracing Winds
- Sold Individually



**IS-VW-16P**

**ANTENNA ADAPTER PLUG FOR VW**



**NA-1517R**

**PILLAR RIGHT SIDE MOUNT ANTENNA**

- 3 Sections
- Extends to 48"
- Cable: 48"
- Fits Toyota Corolla ('78-'83), Tercel ('80-'82), and Mazda GLC ('76-'80)



**NA-1518**

**LEFT HAND SIDE ANTENNA**

- 2 Sections
- Extends to 31"
- Cable: 82"
- Fits Nissan/Datsun, GLC ('78-'80), 626 ('78-'87) Ford Festival ('87-'93)



**NA-1549**

**AMPLIFIED WINDSCREEN CAR ANTENNA**

- High Sensitivity
- AM/FM Reception



**NA-1659**

**AMPLIFIED WINDSCREEN CAR ANTENNA**

- High Sensitivity
- AM/FM Reception



**NA-1551**

**LEFT/RIGHT PILL MOUNT ANTENNA**

- 3 Sections
- Extends to 31"
- Cable: 82"
- Fits Daihatsu Charade G100, Honda Accord ('88)P prelude ('88), Mazda 323 4 door ('86), Suzuki Swift ('92), Toyota Corolla Seca ('88-'92)



**NA-1553**

**UNIVERSAL ANTENNA**

- Fits Nissan, Datsun Pick-Up ('89 & up)
- 1 Section
- Extends to 31"
- Cable: 54"





**NA-1560**

- STICK-ON ROOF MOUNT ANTENNA
- 1 Section Fiberglass Mast
  - Extends to 16"



**NA-25215**

- SINGLE MIRROR MOUNT ANTENNA
- 1 Section Fiberglass Mount
  - Extends to 48"
  - Cable: 140"
  - Frequency: 27MHz



**NA-26280**

- NA-26280CH**  
MAGNETIC MOUNT CAR ANTENNA
- Base Loaded
  - 1 Section
  - Extends to 15"
  - Cable: 120"
  - Frequency: 27MHz



**NA-50FL**

- FENDER MOUNT ANTENNA
- 5 Sections
  - Material: SUS304
  - Working Principle: PCB Control
  - Coaxial Cable: 75 Ohms
  - Length: 1500mm (59")
  - Rod Length: 800mm (31.5")
  - Connector: Motorola Plug
  - 0-30° Adjustable Mounting Base



**NA-90FL**

- FENDER MOUNT ANTENNA
- 5 Sections
  - Material: SUS304
  - Working Principle: PCB Control
  - Coaxial Cable: 75 Ohms
  - Length: 1500mm (59")
  - Rod Length: 800mm (31.5")
  - Connector: Motorola Plug
  - 0-30° Adjustable Mounting Base



**NA-1544RF**

- SHARK FIN ANTENNA WITH BUILT IN AMPLIFIER
- Roof Mount
  - 5M Extension Cable
  - Perfect Fit for European Models



**NA-1546ER**

- ANTENNA WITH BUILT IN AMPLIFIER
- Roof Mount
  - 5M Extension Cable
  - Perfect Fit for European Models



**NA-1555UN**

- ALUMINUM ANTENNA MAST
- Made of High Quality Light-Weight Aluminum Alloy
  - Stylish Carbon Fiber Design
  - Replaces most Stock Mast/Whip Antenna Styles



**NA-5000**

- UNIVERSAL STAINLESS STEEL ANTENNA
- 4 Sections
  - Side Key Lock
  - 0 ~ 30° Mounting Angle Big Fit-Head
  - Extends to 39.4"
  - Cable: 50"



**NA-523**

- UNIVERSAL ROOF OR REAR DECK MOUNT ANTENNA
- 1 Section Black Fiberglass Mast
  - Mast Length 510mm (20")
  - Cable Length 2030mm (80")
  - Alloy Ball Base Adjustable Angle 90°
  - Side Mount



**NA-90FL-MAST**

- REPLACEMENT MAST FOR NA-90FL
- 5 Sections
  - Length: 1000mm (31.5")



**IS-NE22**

- UNIVERSAL ROOF, FRONT OR REAR MOUNT ANTENNA
- 1 Section Flexible Rubber Mast
  - Swivel Ball Base 180° Adjustable Angle
  - Extends to 16"
  - Cable: 54"



# INSTALLATION

## CAR AUDIO ANTENNA ACCESSORIES



**EA-1**  
• Standard Male Antenna Plug



**EA-1.5 (1.5')**  
**EA-3 (3')**  
**EA-6 (6')**  
**EA-12 (12')**  
• Antenna Extension Cord

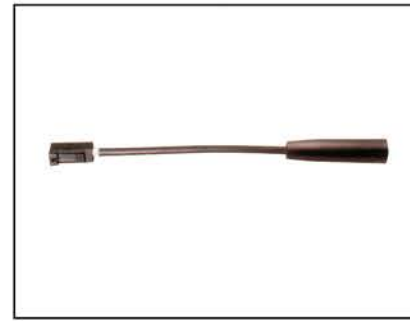

**EU-22**  
• Antenna Adaptor for BMW and Volkswagen 2002-2008  
• Factory Radio to After-Market Antenna Adaptors for European



**FD-16**  
• Factory Radio to After-Market Antenna Adaptors for Ford



**IS-GM16**  
• Factory Antenna to After-Market Radio Adaptors for GM



**IS-NI16**  
• Antenna Adaptor  
• For Nissans 2006 & Up

**SA-111**  
ANTENNA REPLACEMENT MAST  
• 1 Section  
• Universal WIP  
• 31" Extended  
• Adaptor Kit for Perfect Installation



**VW-16**  
• Factory Antenna to After-Market Radio Adaptors for VW



**VW-16P**  
• Antenna adapter plug for VW



**IS-CR16**  
• Antenna Adaptor Chrysler

# INSTALLATION

## WIRING HARNESS



**ISO-002**  
• Volkswagen harness

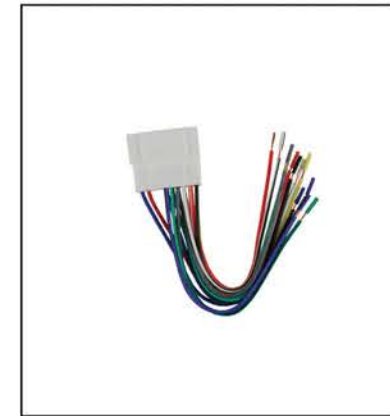

**WH-ACU 9810**  
• Wiring harness for Honda/Acura 1998 & up



**WH-CHDO 0002**  
• Wiring harness for Chrysler 2000-2002



**WH-CHMI 8794**  
• Wiring harness for Chrysler Plymouth, Dodge, Mitsubishi 1987-1994

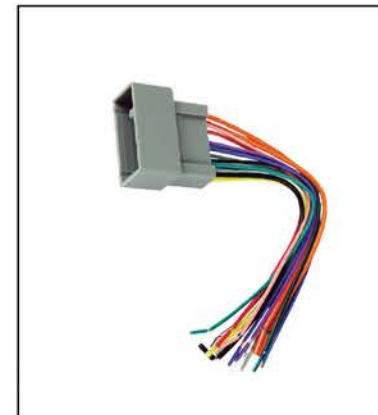

**WH-HON 0208**  
HARNESS HONDA 2002-UP

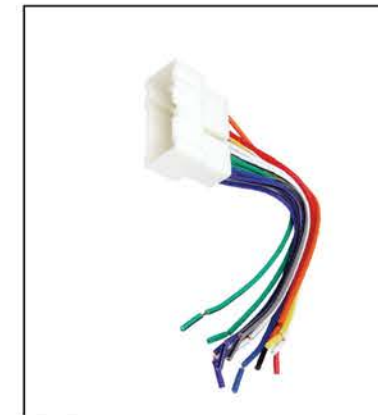

**WH-NIS 0210**  
HARNESS NISSAN 2002-UP



**WH-HYN 0210**  
HARNESS HYUNDAI 2002-UP

**INSTALLATION**

WIRING HARNESS



**WH-GMSA 0002**  
• STR Harness for Saturn 2000



**WH-FORD 9802**  
• Wiring Harness for Ford



**WH-FORDAMP 9597**  
• Wiring Harness for Ford 1995-1997



**WH-GM8802**  
• Wiring Harness for GM 1988-2002



**WH-GM9402**  
• Wiring Harness for Saturn 2000



**WH-HON 9802**  
• Wiring Harness for Honda, Acura 1998-2002

**INSTALLATION**

WIRING HARNESS

**WH-JVC09**  
• JVC Radio Replacement Harness



**WH-JVC16P**  
• JVC Radio Replacement Harness



**WH-KENWOOD16P**  
• Kenwood Radio Replacement Harness

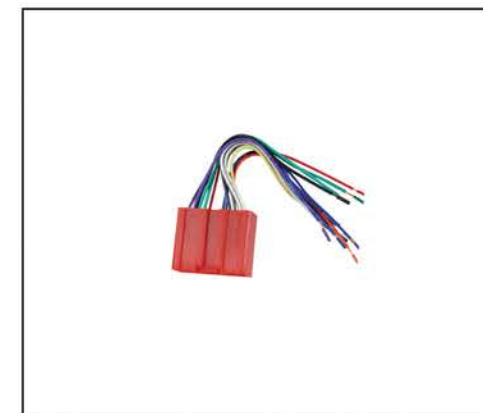

**WH-MAZ 0110**  
• Wiring Harness for Mazda 2001 and up



**WH-MAZ 8902**  
• Wiring Harness for Mazda

**INSTALLATION**

WIRING HARNESS

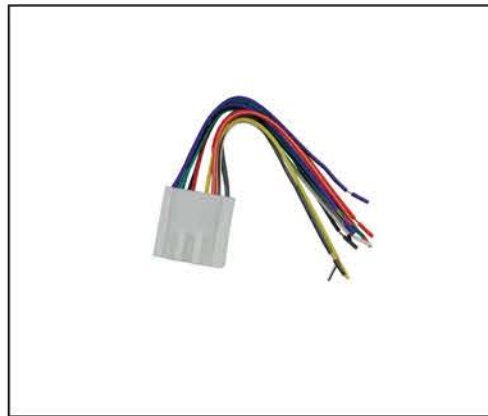

**WH-MIT 9410**

- Wiring Harness for Mitsubishi 1994 & Up



**WH-VW8602**

- Wiring Harness for VW 1986-2002

**INSTALLATION**

WIRING HARNESS



**WH-PIONEER01**

- Pioneer Radio Replacement Harness



**WH-PIONEER11**

- Pioneer Radio Replacement Harness



**VWS-1000**

- Installation Wire Harness 2000 and Up

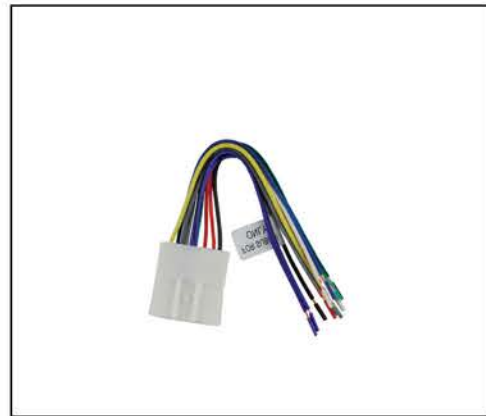

**WH-NIS 0710**

- Wiring Harness for Nissan 2007 & Up

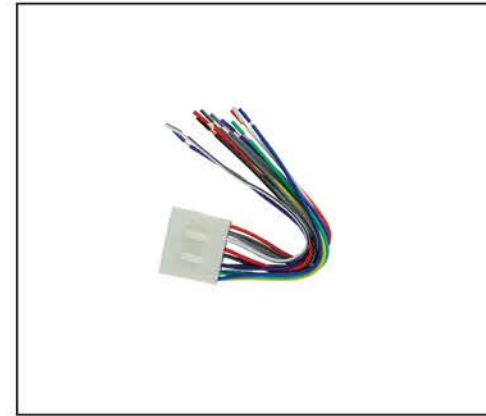

**WH-SUB 9010**

- Wiring Harness for Subaru 1990 & Up

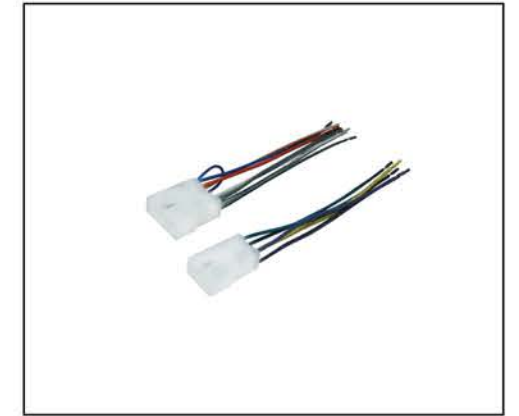

**WH-TOY 8486**

- Wiring Harness for Toyota 1983-1986, Daihatsu 1989-1992



**WH-NIS 9502**

- Wiring Harness for Nissan 1995-2002



**WH-NIS 8694**

- Wiring Harness for Nissan 1986-1994



**WH-TOY 8702**

- Wiring Harness for Toyota 1987-2002



**WH-VW 8702**

- Wiring Harness for VW 1987-2002



**IS-HD10**  
• Honda 2010 and Up, Antenna Adapter



**IS-HD11**  
• Honda 2015 Antenna Adapter



**IS-SB10**  
• Subaru Antenna Adapter



**IS-EXP-MOT**  
BAND EXPANDER  
• FM Band 88-108MHz CRYSTAL 19MHz

**The Radio Band Expander enables the original equipment radio in Japanese import cars to receive universal radio transmissions.**



**IS-EXP14-TYKT**  
14MHz BAND EXPANDER  
• Toyota Female to Toyota Male  
• 2014 and Up



**IS-EXP105N**  
14MHz BAND EXPANDER  
• Nissan Female to Nissan Male  
• 2007 and Up



**IS-MUV40**  
ANTENNA ADAPTOR  
• VW Antenna Adapter



**IS-TY11**  
• Toyota Antenna Adapter



**IS-MVA8**  
8-CHANNEL VIDEO AMPLIFIER  
• Each Channel Output can be Independently Adjusted  
• Shielded Metal Housing  
• Power Supply Voltage: 12V  
• Output Impedance: 75Ω  
• Video Level: Input: 1.0Vp-p / Output: 0.5-1.5Vp-p



**8 Channel Video Output**  
**12 Volts Power Supply**



**IS-AMP-220**  
HIFI STEREO AUDIO AMPLIFIER  
• Input: DC 12V, 5A  
• Power: 20W Max, 10W RMS  
• Speaker Impedance: 4~16Ω  
• Frequency: 20Hz~20KHz



**IS-AMP-221BT**  
HIGH POWER AMPLIFIER  
• USB, SD Card Input, FM Stereo Radio  
• MP3 Audio Format Play  
• External Audio Input  
• GH-Power BTL Output  
• DC 12V Input  
• FM Frequency Range: 87.5MHz-108.0MHz

**80 Watts Max Power**



HHML-6085-3D

60 SMD LED MAGNIFIER LAMP (0.2W/SMD LED)

- Round Glass Lens Size: 5 inch
- Optical Power: 3D
- Super Bright 60 Ultra-Efficient SMD LEDs
- Low Power Consumption: 8W
- Adjustable Arm
- Voltage: AC 110-120V,60Hz
- Luminous Flux: 760 Lumen
- 60pcs SMD LEDs, 8W



**SUPER-BRIGHT**



**ADJUSTABLE**

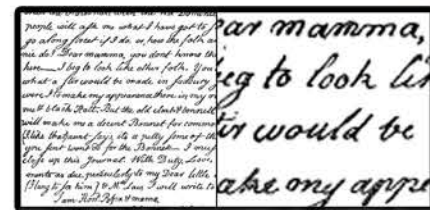

**4X MAGNIFICATION**

SC-104

CD/MD/MP3 Cassette Adapter



ISPOD-WD280-BLK

ISPOD-WD280-TAN

ISPOD-WD280 GREY

DUAL 8" DOOR WOOD SPEAKER POD

- Audiopipe aluminum logo badge
- Can be mounted on door panels or rear decks
- Inner cylinder provides a solid enclosure
- High grade vinyl wrap
- **SOLD BY PIECE**



ISPOD-WD8T-BLK

ISPOD-WD8T-GREY

ISPOD-WD8T-TAN

8" WOOD SPEAKER POD WITH TWEETER OPENING

- Audiopipe aluminum logo badge
- Can be mounted on door panels or rear decks
- Compatible with ATX-3725 tweeter
- Inner cylinder provides a solid enclosure
- High grade vinyl wrap
- **SOLD BY PAIRS**



ISPOD-WD260-BLK (black)

ISPOD-WD260-TAN (tan)

ISPOD-WD260GREY (grey)

DUAL 6" DOOR WOOD SPEAKER POD

- Audiopipe aluminum logo badge
- Can be mounted on door panels or rear decks
- Inner cylinder provides a solid enclosure
- High grade vinyl wrap
- **SOLD BY PIECE**



TUBO-8

- 8" Subwoofer Tubo

TUBO-6.5

- 6.5" Subwoofer Tubo

TUBO-10

- 10" Subwoofer Tubo

TUBO-12

- 12" Subwoofer Tubo



# INSTALLATION

## BULKS



### IS-DB91832

- Damping Mat Bulk Package
- Included Nine (9) / 18"x 32" sheets
- Forget about unwanted road noise and create a quiet environment in your ride.



### IS-DD61224

- Door Kit Bulk Package
- Included Six (6) / 12"x 24" sheets
- Forget about unwanted road noise and create a quiet environment in your ride.



### IS-DS21012

- Speaker Kit Bulk Package
- Included Two (2) / 10"x 12" sheets
- Forget about unwanted road noise and create a quiet environment in your ride.



### IS-DT101224

- Trunk Kit Bulk Package
- Included Ten (10) / 12"x 24" sheets
- Forget about unwanted road noise and create a quiet environment in your ride.



# INSTALLATION

## BATTERY ACCESSORIES



### NB-770

- BATTERY JUMPER CABLE
- 70 amp
  - Available in black & red



### NB-880

- BATTERY JUMPER CABLE
- 80 amp
  - Available in black & red



### NB-440 BLK / NB-440 RED

- BATTERY CLIP
- 30 amp
  - Available in black & red



### NB-550 BLK / NB-550 RED

- BATTERY CLIP
- 50 amp
  - Available in black & red



### NB-660 BLK / NB-660 RED

- BATTERY CLIP
- 60 amp
  - Available in black & red



### NB-2

- BATTERY SNAP
- 9V



### NB-415B (Black)

### NB-415R (Red)

- Banana jack



### NB-416B (Black)

### NB-416R (Red)

- Long handle

# INSTALLATION

## LEAD & CLIP ACCESSORIES

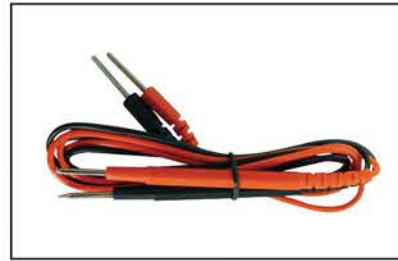

**NB-409**  
TEST LEADS  
• 3' cord with 2 pin prods on each end

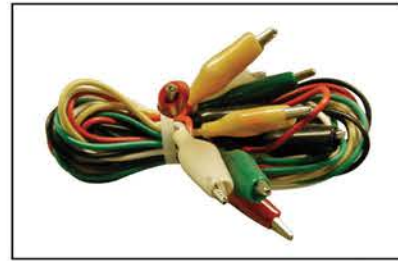

**NB-413**  
TEST LEAD SET  
• 3' set includes 10 wires & 20 clips in black, green, red, white & yellow



**NB-414**  
TEST LEADS  
• 3' cord with 2 pin prods on one end & 2 banana plugs on the other



**NB-425**  
TEST LEAD WITH PROTECTOR  
• 4'  
• Long tip to right angle



**NB-437**  
TEST LEADS SET  
• Flexible cable with right angle DMM plugs  
• 0.08" (2mm) diameter contact tips  
• Max Test Voltage: 600V/1000V  
• Max Test Current: 10A



**NB-341 BLK**  
ALLIGATOR CLIP  
• Molded handles  
• Color black

**NB-341 RED**  
ALLIGATOR CLIP  
• Molded handles  
• Color red

- NB-343 BLK (1")
  - NB-343 RED (1")
  - NB-344 BLK (1-1/2")
  - NB-344 RED (1-1/2")
  - NB-345 BLK (2")
  - NB-345 RED (2")
- ALLIGATOR CLIP  
• Available in black & red



# INSTALLATION

## BATTERY CHARGER

**LBCH-12M**  
POWER SUPPLY  
• Double Insulated  
• Thermal Overload Safety  
• Electronic LED Display  
• CE Approved  
• For 12V Car, Motorcycle & Lawnmower Batteries



**LBCH-612SW**  
POWER SUPPLY  
• 6/12V, 6 AMP  
• Blade Type Fuse  
• Overload Protection



**LBCH-6M**  
POWER SUPPLY  
• Double Insulated  
• Power Supply  
• Thermal Overload Safety  
• Electronic LED Display  
• CE Approved  
• For 12V Car, Motorcycle & Lawnmower Batteries  
• 6/12V, 6 Amp



**LBCH-6PL**  
POWER SUPPLY  
• Automatic Battery Charger  
• 6A Automatic Charging  
• Fully protects against sparks, short circuit and overheating  
• Suitable for all types of 12 V Lead Acid Batteries between 20-110 AH



**LBCH-80M**  
POWER SUPPLY  
• Thermal Overload Safety  
• Electronic LED Display  
• CE Approved  
• For 12V Car, Motorcycle & Lawnmower Batteries  
• 12V, 20 Amp





**EX-JUMP4-20**

BOOSTER CABLES

- 4Ga, 20 FT.
- Tangle Free Construction
- Phase Marked Clamps for Added Safety
- High/Low Temperature Construction
- Extra Flexible for Easy Use



**EX-JUMP6-16**

BOOSTER CABLES

- 6Ga, 16FT.
- Tangle Free Construction
- Phase Marked Clamps for Added Safety
- High/Low Temperature Construction
- Extra Flexible for Easy Use



**TRBM-12-125A**

AUTOMATIC BATTERY MAINTAINER & FLOAT CHARGER

- Switch - Mode Technology
- Input: 110V AC, 60Hz, 0.25A
- Output: 12V Nominal, 0.75A
- Standby Power Consumption: <0.5W
- Maximum Operating Temperature: (122°F (50°C))



**TRBM-1224-6A**

INTELLIGENT BATTERY CHARGER

- Input Voltage: 110V AC, 60Hz or 230V AC, 50Hz
- Output Voltage: 12V & 24V (auto - select)
- Charging Voltage: 28.8V ± 0.25V, or 29.4V ± 0.25V or 14.4V ± 0.25V or 13.6V ± 0.25V or 16.5V ± 0.25V
- Charging Current: 6.0A ± 10% or 4.0A ± 10% or 3.0A ± 10% or 2.5A ± 10% or 1.5A ± 10%
- Ambient Temp: -20°C ~ +40°C / -4°F ~ 104°F, Reduced Output Power at Higher Temperature
- Battery Types: 12V & 24V Lead-Acid Batteries (WET, MF, AGM and GEL)

**IS-QFH18**

FUSE CABLE

- Vinyl Ring Tongue Terminal
- ATC 7.5 AMP Blade type Fuse Included
- Quick Disconnect Power Cable
- 2' Long



**TRMB-12-1.5A**

AUTOMATIC BATTERY CHARGER

- Input: 100-240V AC, 50/60Hz, 0.45A
- Output: 12V DC 1.5A
- LED Indicator: Red-Charging, Green-Charged
- Lead-acid battery charger, specifically used for lamps, toys, solar energy equipment, etc.



*The device is fully automatic to identify the level of charge on 12v lead-acid battery only and maintain a level of maximum charge and it's high frequency charging technology. Automatic charge cycle functionality switches to float mode after fully charging the battery by MCU controlled; High efficiency, long life and high reliability.*

**DC12-2405**

DC TO DC VOLTAGE TRANSFORMER

- Input Voltage: DC 24V
- Output Voltage: DC 12V
- Maximum Current: 5A
- Fuse: 5A



**DC12-2415**

DC TO DC VOLTAGE TRANSFORMER

- Input Voltage: DC 24V
- Output Voltage: DC 12V
- Maximum Current: 15A
- Fuse: 15A



**DC12-2430**

DC TO DC VOLTAGE TRANSFORMER

- Input Voltage: DC 24V
- Output Voltage: DC 12V
- Maximum Current: 30A
- Fuse: 30A



## INSTALLATION

### POWER INVERTERS

#### IS-CLE12

##### 12V, 12' CIGARETTE EXTENSION CABLE

- 12' Length
- Wire Gauge: 18 AWG
- 100% Copper Wire
- High Quality Molded Cable
- Male Plug is Fitted with a 15A Fuse
- Female Plug is Fitted with a Dust and Water Protective Cap
- Perfect for your Favorite 12 Volt Devices



#### PI-200A

##### POWER INVERTER

- Maximum Continuous Power: 200W
- Peak Load Power Rate: Up to 400W
- For Use with 12 Volt Systems
- No Load Current Draw: Up to 0.3 Amps
- Waveform: Modified Sine Wave
- Input DC Voltage Range: DC 11V-15V
- USB Output: 5V/2.4A
- Overload and Short-Circuit Protection
- (1) Replaceable 20 Amp Fuse
- Built-In Cooling Fan
- (2) 110V AC 3 Prong Grounded Receptacles
- Overload Indicator
- 14 AWG 24" Cigarette Plug Cable (Black) with Battery Clamp Included



#### PI-400A

##### POWER INVERTER

- Maximum Continuous Power: 200W
- Peak Load Power Rate: Up to 400W
- For Use with 12 Volt Systems
- No Load Current Draw: Up to 0.3 Amps
- Waveform: Modified Sine Wave
- Input DC Voltage Range: DC 11V-15V
- USB Output: 5V/2.4A
- Overload and Short-Circuit Protection
- (1) Replaceable 20 Amp Fuse
- Built-In Cooling Fan
- (2) 110V AC 3 Prong Grounded Receptacles
- Overload Indicator
- 14 AWG 24" Cigarette Plug Cable (Black) with Battery Clamp Included



#### PI-800A

##### POWER INVERTER

- Maximum Continuous Power: 800W
- Peak Load Power Rate: Up to 1600W
- For Use with 12 Volt Systems
- No Load Current Draw: Up to 0.9 Amps
- Waveform: Modified Sine Wave
- Input DC Voltage Range: DC 10V-15V
- USB Output: 5V/2.4A
- Overload and Short-Circuit Protection
- (1) Replaceable 30 Amp Fuse
- Built-In Cooling Fan
- (2) 110V AC 3 Prong Grounded Receptacles
- Overload Indicator



#### PI-800C

##### POWER INVERTER

- Max continuous power: 800W
- Peak load power rate: up to 1600W
- For use with 12V DC voltage systems
- No load current draw: up to 0.9 Amps
- Waveform: modified sine wave
- Input DC voltage range: 10V-15V DC
- USB Output: 5V/2.4A
- Overload and short-circuit protection
- (1) Replaceable 30 Amp fuse
- Built in cooling fan
- (2) 120V AC Volt 3 prong grounded American standard receptacles
- Overload indicator



#### PI-1500A

##### POWER INVERTER

- Maximum Continuous Power: 1500W
- Peak Load Power Rate: Up to 3000W
- For Use with 12 Volt Systems
- No Load Current Draw: Up to 0.8 Amps
- Waveform: Modified Sine Wave
- Input DC Voltage Range: DC 10V-15V
- USB Output: 5V/2.4A
- Overload and Short-Circuit Protection
- (1) Replaceable 40Ax4 Ffuse
- Built-In Cooling Fan
- (2) 110V AC 3 Prong Grounded Receptacles
- Overload Indicator



## INSTALLATION

### POWER INVERTERS

#### PI-DP-1500C

##### POWER INVERTER

- Max continuous power: 1500W
- Peak load power rate: up to 3000W
- For use with 12V DC voltage systems
- No load current draw: up to 0.9 Amps
- Waveform: modified sine wave
- Input DC voltage range: 10V-15V DC
- USB Output: 5V/2.4A
- Overload and short-circuit protection
- (1) Built-in 6 x 30 Amp fuses
- Built in cooling fan
- (2) 120V AC Volt 3 prong grounded American standard receptacles
- Overload indicator



#### PI-1500R

##### POWER INVERTER

- Nominal input voltage: 12.8-13.2V DC
- Nominal output voltage: 115±10%V AC
- Output frequency: 60±3 Hz
- Operating input voltage: 10-15V DC
- Continuous output power: Up to 1500W
- Surge output power: 3000W
- Waveform: Modified sine wave
- Typical No Load Current (at nominal input voltage): 0.5A DC
- Efficiency (typical): 85%
- Input overvoltage shutdown: 15.5±0.5V DC
- Input undervoltage alarm: 10.5±0.5V DC
- Input low voltage shutdown: 10.0±0.5V DC
- Output power overload shutdown level: 1800±300W
- Input fuse: 6 x 30A
- AC receptacles: Two, NEMA 5-15 USA
- USB port: Two, 5V/2A



#### PI-DP-2000

##### 12V DC TO 110V AC POWER INVERTER

- Equivalent to Standard Household Power
- Delivers High Quality, Clean Power for Superior Performance
- Easy Motor Start-Ups
- Reduced Noise
- Reduced Stress on Circuitry
- Strong compatibility with most Devices
- Cost-Effective
- High Efficiency
- Light and Portable
- Not Compatible with some Devices



#### PI-DP-3000

##### 12V DC TO 110V AC POWER INVERTER

- Equivalent to Standard Household Power
- Delivers High Quality, Clean Power for Superior Performance
- Easy Motor Start-Ups
- Reduced Noise
- Reduced Stress on Circuitry
- Strong Compatibility with Most Devices
- Cost-Effective
- High Efficiency
- Light and Portable
- Not Compatible with some Devices



**PIB-300D**

12V DC TO 115V AC POWER INVERTER

- Input: 10.0~15.0V DC
- Power: 300W RMS, 600W Max
- Output: 110~120V AC
- Dual USB Output: 5V, 2A
- Output Frequency: 60Hz ± 2Hz
- Input Over Voltage Shutdown
- Input Under Voltage Warning
- Input Under Voltage Shutdown
- Input Fuse Protection
- Over Temperature Shutdown
- Output Short Circuit Protection
- Over Load Protection

**300**

**Watts POWER**



**PIB-500D**

12V DC TO 115V AC POWER INVERTER

- Input: 10.0~15.0V DC
- Power: 500W RMS, 1000W Max
- Output: 110~120V AC
- Dual USB Output: 5V, 2A
- Output Frequency: 60Hz ± 2Hz
- Input Over Voltage Shutdown
- Input Under Voltage Warning
- Input Under Voltage Shutdown
- Input Fuse Protection
- Over Temperature Shutdown
- Output Short Circuit Protection
- Over Load Protection

**500**

**Watts POWER**



**PIB-750D**

12V DC TO 115V AC POWER INVERTER

- Input: 10.0~15.0V DC
- Power: 750W RMS, 1500W Max
- Output: 110~120V AC
- Dual USB Output: 5V, 2A
- Output Frequency: 60Hz ± 2Hz
- Input Over Voltage Shutdown
- Input Under Voltage Warning
- Input Under Voltage Shutdown
- Input Fuse Protection
- Over Temperature Shutdown
- Output Short Circuit Protection
- Over Load Protection

**750**

**Watts POWER**



**PIB-1000D**

12V DC TO 115V AC POWER INVERTER

- Input: 10.0~15.0V DC
- Power: 1000W RMS, 2000W Max
- Output: 110~120V AC
- Dual USB Output: 5V, 2A
- Output Frequency: 60Hz ± 2Hz
- Input Over Voltage Shutdown
- Input Under Voltage Warning
- Input Under Voltage Shutdown
- Input Fuse Protection
- Over Temperature Shutdown
- Output Short Circuit Protection
- Over Load Protection

**1000**

**Watts POWER**



**PI-DCDC-2412-10**

10A DC TO DC CONVERTER

- 24V DC TO 12V DC VOLTAGE CONVERTER
- Output Power: 10Amp (Continuous) 15 Amp Max
- Standby Current: <0.02A
- Input Voltage: DC 20V~30V
- Output Voltage: DC 12V~13.8V
- Efficiency: >90%
- Cooling: By Air Convection
- Fuse: 10A x 1PC
- Dimensions (LxWxH): 110x87x42mm
- Net Weight: 0.45Kg

**10 Amp**  
**<0.02 A Current**



**PI-DCDC-2412-20**

20A DC TO DC CONVERTER

- 24V DC TO 12V DC VOLTAGE CONVERTER
- Output Power: 20Amp (Continuous) 30 Amp Max
- Standby Current: <0.07A
- Input Voltage: DC 20V~30V
- Output Voltage: DC 12V~13.8V
- Efficiency: 85~90%
- Over Load: Circuit Protection
- Input Fuse: 20A
- Dimensions (LxWxH): 182x115x62mm
- Net Weight: 0.8Kg

**20 Amp**  
**<0.07 A Current**



**PI-DCDC-2412-30**

30A DC TO DC CONVERTER

- 24V DC TO 12V DC VOLTAGE CONVERTER
- Output Power: 30Amp (Continuous) 45 Amp Max
- Standby Current: <0.08A
- Input Voltage: DC 20V~30V
- Output Voltage: DC 12V~13.8V
- Efficiency: 85~90%
- Over Load: Circuit Protection
- Input Fuse: 30A
- Dimensions (LxWxH): 222x115x62mm
- Net Weight: 0.95Kg

**30 Amp**  
**<0.08 A Current**



PI-DCDC-2412-40

40A DC TO DC CONVERTER

- 24V DC to 12V DC Voltage Converter
- Output Power: 40 Amp (Continuous), 60 Amp Max
- Standby Current: <0.08A
- Input Voltage: DC 20V~30V
- Output Voltage: DC 12V~13.8V
- Efficiency: 85~90%
- Over Load: Circuit Protection
- Input Fuse: 40A
- Dimensions (LxWxH): 222x115x62mm
- Net Weight: 1.0Kg



**40 Amp**  
 <0.08 A Current

PI-DCDC-2412-100

100A DC TO DC CONVERTER

- 24V DC TO 12V DC VOLTAGE CONVERTER
- Output Power: 100 Amp (Continuous), 130 Amp Max
- Standby Current: ≤1.10A
- Input Voltage: DC 20V~30V
- Output Voltage: DC 12V~13.8V
- Efficiency: 85~90%
- Thermal Protection: 65°C +/- 5°C
- Input Polarity Reverse: Diode Protection
- Output Polarity Reverse: Circuit Protection
- Output Short: Circuit Protection
- Over Heating: Circuit Protection
- Over Load: Circuit Protection
- Input Fuse: 4x30A
- Dimensions (L x W x H): 365x165x79mm
- Net Weight: 3.03Kg



**100 Amp**  
 ≤ 1.10 A Current



NL-LBR317-72W

17" LED LIGHT BAR

- Beam: Spot-Flood Combo
- Operating Voltage: DC 10-30V
- Power: 72W (24 x 3W/Pcs High Density LEDs)
- Color Temperature: 6000K
- Lumen: 22000LM
- Lifespan: >30,000 Hours
- Waterproof Rate: IP 67
- Lens Material: PC
- Housing Material: Diecast Aluminum
- Includes Installation Hardware



NL-LBR325-120W

25" LED LIGHT BAR

- Beam: Spot-Flood Combo
- Operating Voltage: DC 10-30V
- Power: 120W (40 x 3W/Pcs High Density LEDs)
- Color Temperature: 6000K
- Lumen: 22000LM
- Lifespan: >30,000 H ours
- Waterproof Rate: IP 67
- Lens Material: PC
- Housing Material: Diecast Aluminum
- Includes Installation Hardware



NL-LBR333-180W

33" LED LIGHT BAR

- Beam: Spot-Flood Combo
- Operating Voltage: DC 10-30V
- Power: 180W (60 x 3W/Pcs High Density LEDs)
- Color Temperature: 6000K
- Lumen: 22000LM
- Lifespan: >30,000 Hours
- Waterproof Rate: IP 67
- Lens Material: PC
- Housing Material: Diecast Aluminum
- Includes Installation Hardware



NL-LBR353-288W

53" LED LIGHT BAR

- Beam: Spot-Flood Combo
- Operating Voltage: DC 10-30V
- Power: 288W (96 x 3W/Pcs High Density LEDs)
- Color Temperature: 6000K
- Lumen: 22000LM
- Lifespan: >30,000 Hours
- Waterproof Rate: IP 67
- Lens Material: PC
- Housing Material: Diecast Aluminum
- Includes Installation Hardware





**NL-LBR355-300W**

- 55" LED LIGHT BAR
- Beam: Spot-Flood Combo
  - Operating Voltage: DC 10-30V
  - Power: 300W (100 x 3W/Pcs High Density LEDs)
  - Color Temperature: 6000K
  - Lumen: 22000LM
  - Lifespan: >30,000 Hours
  - Waterproof Rate: IP 67
  - Lens Material: PC
  - Housing Material: Diecast Aluminum
  - Includes Installation Hardware

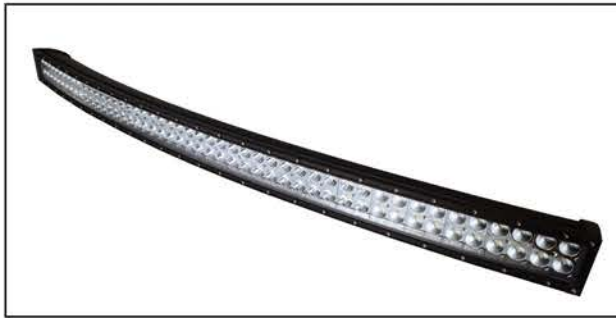

**NL-LBC352**

- 52" CURVED LED LIGHT BAR
- Beam: Spot-Flood Combo
  - Operating Voltage: DC 10-30V
  - Power: 288W (96 x 3W/Pcs High Density LEDs)
  - Color Temperature: 6000K
  - Lumen: 22000LM
  - Lifespan: >30,000 Hours
  - Waterproof Rate: IP 67
  - Lens Material: PC
  - Housing Material: Diecast Aluminum
  - Includes Installation Hardware



**NL-LBC354**

- 54" CURVED LED LIGHT BAR
- Beam: Spot-Flood Combo
  - Operating Voltage: DC 10-30V
  - Power: 300W (100 x 3W/Pcs High Density LEDs)
  - Color Temperature: 6000K
  - Lumen: 22000LM
  - Lifespan: >30,000 Hours
  - Waterproof Rate: IP 67
  - Lens Material: PC
  - Housing Material: Diecast Aluminum
  - Includes Installation Hardware



**NL-LBS326-72W**

- 26" 72W LED LIGHT BAR
- Voltage: DC 10-30V
  - Power: 7 (24pcs x 3W High Intensity LEDs)
  - Luminous Flux: 1530 LM
  - Color Temperature: 6000K
  - Service Life: 50000h
  - Waterproof Rate: IP67
  - Material: Aluminum Alloy



**NL-LB303-18W**

- 3" 12W CREE LED LIGHT BAR
- Description: Cree LED Light Bar
  - Operation Voltage: 10-30V DC
  - LED Module: 3W/pcs Cree LEDs
  - LENS Material: Tempered Glass
  - Beam: Spot, Flood, Combo
  - Waterproof Level: IP67
  - Color Temp.: 6000K~6500K
  - Housing Material: Aluminum
  - Life Span: >30,000 Hours



**NL-LBS36-18W**

- 6" 18W LED LIGHT BAR
- Voltage: DC 10-30V
  - Power: 18W (6 Pcs x 3W High Intensity LEDs)
  - Luminous Flux: 1530 LM
  - Color Temperature: 6000K
  - Service Life: 50000h
  - Waterproof Rate: IP67
  - Material: Aluminum Alloy



**NL-LBSQ-14-27W**

- 4" 27W LED LIGHT BAR
- Power: 27W (9 Pcs x 3W High Intensity LEDs)
  - Lumen: 1980lm
  - Voltage: 9V-36V
  - Color Temperature: 6000K
  - Material: Aluminum
  - Lens: PC
  - Waterproof Rate: IP67
  - Bracket: Stainless Steel Bracket
  - Thickness: 35mm
  - Size: 108mm x 108mm x 35mm



**NL-LBSQ-15-27W**

- 5" 27W LED LIGHT BAR
- Voltage: DC 10-30V
  - Power: 27W (9 Pcs x 3W High Intensity LEDs)
  - Luminous Flux: 1800 LM
  - Color Temperature: 6000K
  - Service Life: 30000h
  - Waterproof Rate: IP67
  - Material: Aluminum Alloy
  - Thickness: 30mm
  - Size: 115mm x 115mm x 30mm



**NL-LBSTRQ-15-27W**

- 5" 27W LED LIGHT BAR
- Voltage: DC 10-30V
  - Power: 27W (9 Pcs x 3W High Intensity LEDs)
  - Luminous Flux: 1800 LM
  - Color Temperature: 6000K
  - Service Life: 30000h
  - Waterproof Rate: IP67
  - Material: Aluminum Alloy
  - Thickness: 45mm
  - Size: 115mm x 115mm x 45mm





**NL-H-9005-36W**

- S1 LED Headlight-9005
- Power: 36 Watts Per Piece
  - Voltage: 9-32V (Fits 12V/24V Vehicles)
  - Lumen: 3600 LM
  - Ideal for High Beam Reflector Headlights
  - Easy and Click Installation
  - Secure Temperature Range up to 6500K
  - With LED CSP Beam
  - Constant Brightness Output at All Times



**NL-H-9006-36W**

- S1 LED Headlight-9006
- Power: 36 Watts Per Piece
  - Voltage: 9-32V (Fits 12V/24V Vehicles)
  - Lumen: 3600 LM
  - Enhanced Light Efficiency
  - Easy and Click Installation
  - Secure Temperature Range up to 6500K
  - With LED CSP Beam



**NL-H-9007-36W**

- S1 LED Headlight-9007
- Power: 36 Watts Per Piece
  - Voltage: 9-32V (Fits 12V/24V Vehicles)
  - Lumen: 3600 LM
  - Easy and Click Installation
  - Secure Temperature Range up to 6500K
  - With LED CSP Beam

**NL-LBR0-07-51W**

- Power: 51W
- Voltage: 9-32V
- Color Temperature: 6500K
- Lumen: 4000LM
- Beam: Spot/Flood Epistar



**NL-LBOV-43-20W**

- Power: 20W
- Voltage: 9-32V
- Color Temperature: 6500K
- Lumen: 1400LM
- Beam: Spot/Flood



**NL-LBMX382-25W**

- Triple Row 4D Off-Road LED Light
- Voltage: 25W
- Waterproof: 10-30V DC
- LED Chips: 0.9W Epistar
- Color Temperature: 6000K
- Beam: Spot
- Span life: >30000 Hours



**NL-H-H4-36W**

- S1 LED Headlight-H4
- Power: 36 Watts Per Piece
  - Voltage: 9-32V (Fits 12V/24V Vehicles)
  - Lumen: 3600 LM
  - Secure Temperature Range up to 6500K
  - With LED CSP Beam
  - Ideal for Replacing Low and High Beams, Fog Lights and Motorcycle H11 Headlight Bulbs
  - Consistent Brightness Output



**NL-H-H11-36W**

- S1 LED Headlight-H11
- Power: 36 Watts Per Piece
  - Voltage: 9-32V (Fits 12V/24V Vehicles)
  - Lumen: 3600 LM
  - Secure Temperature Range up to 6500K
  - With LED CSP Beam
  - Ideal for Replacing Low and High Beams, Fog Lights and Motorcycle H11 Headlight Bulbs
  - Consistent Brightness Output

**NL-LBSQ-33-10W**

- Power: 10W
- Voltage: 10-30W DC
- Waterproof Rate: IP 67
- LED Chips: 2.5W Cree
- Color Temperature: 6000K
- Lumen: 880 LM
- Beam: Spot / Flood
- Span Life: 50000 Hours



**NL-LBSQ874D-10W**

- Power: 10W
- Voltage: 10-30W DC
- Waterproof Rate: IP 67
- LED Chips: 2.5W Cree
- Color Temperature: 6000K
- Lumen: 880 LM
- Beam: Spot / Flood
- Span Life: 50000 Hours



IS-9013

TESTING CONSOLE WITH HDMI PORT

- I/S Testing Console
- CB Antenna Cable & Indicator Light
- Left and Right Speaker
- RJ-11 Phone Jack
- 12V Power Supply
- Speaker Spring Connectors
- RCA Jacks
- Coax Connectors

For:

- Telephone, Fax and Answering Machines
- Video Games
- Camcorders
- Televisions
- VCR's
- CB Radios
- Car Radios/Stereos



with  
**HDMI PORT**

THSY-2050-CH

COMPACT AIR HORN COMPRESSOR SET

- New Powerful High RPM Compressor
- Full Thermal Protection
- New Lubricating System
- Leak-Proof Nylon Hose
- Super Loud: 17 Decibels
- Use Air-Horn for Emergency Warning when on Highway, Mountain Road and Taking a Turn. Also Enriching Air for Car, Motorcycle, Ball, Yacht, Tire, Air-Free, Toys, etc.
- Small Size, Auto-Control Air Pressure, Excellent Very Loud Sound



**Powerful, Loud Sound  
in a Small, Compact Design**

CMP-10012

12V DC PORTABLE AIR COMPRESSOR

- Voltage: 12-14V DC.
- Amperage: 15 Amps.
- Air Flow: 25 LPM@0 PSI.
- Max. Pressure: 100 PSI.
- For use on car tires, sports equipment & more.
- Compact & powerful pump motor.
- Built-in carry handle.
- Nozzle adaptors included.



**Nozzle  
Adaptors  
Included**



CMP-15015-B

12V DC PORTABLE AIR COMPRESSOR

- Voltage: 12-14V DC.
- Amperage: 15 Amps.
- Air Flow: 30 LPM@0 PSI.
- Max. Pressure: 150 PSI.
- For use on car tires, sports equipment & more.
- Compact & powerful pump motor.
- Built-in carry handle.
- Nozzle adaptors included.
- Carry bag included.



**Nozzle  
Adaptors  
Included**





**THSY-3075KIT**

AIR HORN COMPRESSOR

- Air Horn Compressor Motor Repair Kit
- Replacement for THSY-3075C
- 3/4 Gallon



**THSY-5150KIT**

AIR HORN COMPRESSOR

- Motor Repair Kit
- Replacement for THSY-5150C



**THSY-GAUGE**

COMPRESSOR GAUGE

- Replacement Gauge For: THSY-3075C and THSY-5150C



**THSY-HOSE 25**

COMPRESSOR AIR HOSE

- Length: 25' (7.5M)
- 1/4" Ends Terminal made of Iron, GF High Pressure Resistant
- Compatible with THSY-3075C & THSY-5150C

**THSY-HSOLE**

REPLACEMENT HORN SOLENOID

- Voltage: 12V/24V
- Current: 3.6A
- Power: 48W
- Air Pressure Range: 0.2~0.8 MPa



**THSY-1000**

COMPRESSOR AND HORN KIT

- DC 12V, 26.5A, 320W
- Material: Zinc Alloy Totally
- 2 Horns + Aluminum Base
- Size: 168 x Φ75mm, 207 x Φ76mm
- Weight: 0.95 Kgs
- 110 ± 5dB



**THSY-1075-EC**

HORN

- Material: Zinc Alloy totally Horns + Chromed Plastic Base,
- Smaller than THSY-1075H
- Size: 230\*93mm, 306\*96mm, 350\*96mm, 375\*96mm
- 12V/24V, JGK-505 Big VALVE (with Copper Coil)
- Weight: 1.5 Kgs
- 125 DB
- 290/421/548/648 HZ



**THSY-1075-DH**

2-WAY TRAIN HORN

- Air Pressure: 0.4-0.8 MPa
- Current: 3.5-7.0A
- Voltage: 12V/24V
- Sound Level: 115 ± 5dB
- Weight: 0.93Kg / 2lbs
- Dimensions: 11.5" x 6.7" x 3.7" (291 x 170 x 94 mm)



**THSY-1075H**

HORN

- Air Pressure: 0.4~0.8MPa
- Current: 3.5-7.0A
- Voltage: 12-24V
- Sound Level: 125 ± 5dB





**THSY-HSE7**

REPLACEMENT COMPRESSOR HOSE

- 7FT.
- COMPATIBLE WITH:  
THSY-1075-HA  
THSY-1075H  
THSY-3075C  
THSY-5150C



**THSY-1075-H4**

HORN

- Material: Zinc Alloy Totally 4 Horns:
- 2 Small Horn: Length: 280mm, Diameter of the Mount 160mm
- 1 Media Horn: Length: 344mm, Diameter of the Mount 160mm
- 1 Large Horn: Length: 396mm, Diameter of the Mount 160mm
- 12V/24V, JGK-505VALVE (with Copper Coil)
- Weight: 6 Kgs
- 125 DB
- 290/421/548/648 HZ



**THSY-3075C**

AIR HORN COMPRESSOR MOTOR REPAIR KIT

- Replacement for THSY-3075C



**3/4 Gallon**

**THSY-5150C**

AIR HORN COMPRESSOR

- Pressure: 90~120 PSL
- Output: 12V DC
- Volume: 6L (1.59 gal)



**3-1/2 Gallon**



- RING-06CBK (6")
- RING-065CBK (6.5")
- RING-69CBK (6x9")
- RING-08CBK (8")
- MDF Speaker Rings with Black Carpet
- 3/4" Thickness
- Sold in Pairs



- RING-8CTW
- 8" Wood Rings with Curve (Pair)
- Each Ring Accommodates 8" Speakers and 1 ATR-3721 or ATQ-3725 Series Tweeter
- Provides a Custom Look to your Door Panel or Rear Deck and Acts like a Spacer



- RING-4545
- MDF Speaker Rings
- Size: 4.48" x 4.48" / 3.3" x 3.3"
- Sold in Pairs



- RING-5757
- MDF Speaker Rings
- Size: 5.65" x 5.65" / 4.4" x 4.4"
- Sold in Pairs

# INSTALLATION

## SPEAKER RINGS

- RING1.5R (1.5")
  - RING3.5R (3.5")
  - RING4R (4")
  - RING5.25R (5.25")
  - RING-6.5R (6.5")
  - RING-8R (8")
  - RING-10R (10")
  - RING-12R (12")
  - RING-15R (15")
- MDF SPEAKER RINGS



- RING-6.5BZ (6.5")
  - RING-8BZ (8")
  - RING-10BZ (10")
  - RING-12BZ (12")
- MDF SPEAKER RINGS
- with Bezel

- RING-6.5GR (6.5")
  - RING-8GR (8")
- MDF SPEAKER RINGS
- with Grill Cutout



- RING-3720
- WOOD RING FOR TWEETERS
- $\phi$  4.33 x  $\phi$  2.91"
  - Sold in Pairs



- APMB-RING-6 (6")
  - APMB-RING-8 (8")
- ABS PLASTIC SPEAKER RINGS
- Made From ABS Plastic
  - Adds an Extra Half Inch to Available Mounting Depth
  - One Pair of Adapters Included in Each Package



- RING-PVC 6
- 6.5" PVC SPEAKER SPACER RINGS
- Universal 1" Speaker Spacer Rings for Mounting 6.5" Speaker
  - Inner Diameter: 5-7/8"
  - Made From PVC Material
  - 1-inch Allows Extra Mounting Depth
  - Fits most 6.5 inch Speakers | Oversized 6.5" Speakers will not work with these Spacers



# INSTALLATION

## ACCESSORIES

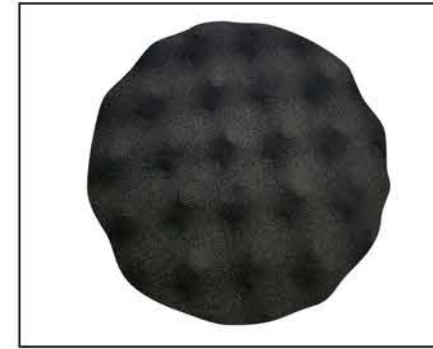

### IS-ACBAF-65

SIZE: 6.5"

- Material: Silicone
- Weight: 150g of Each
- The Front Ring is Foldable to Guide the Sound Wave into Vehicle
- The Rear Foldable Ring Fits Different Door Depth and Speaker Height. No need to Trim it
- The Rear Foldable Ring Protects Speaker and Improves Sound
- Silicone Material is Soft to Seal between Speaker and Door Panel
- Silicone material is durable for harsh environment.
- The Egg Wave Foam behind Speaker Improves Sound by Preventing Sound Wave Bounced back



### IS-ACBAF-69

SIZE: 6X9"

- Material: Silicone
- Weight: 205g of Each
- The Front Ring is Foldable to Guide the Sound Wave into Vehicle
- The Rear Foldable Ring Fits Different Door Depth and Speaker Height. No need to Trim it
- The Rear Foldable Ring Protects Speaker and Improves Sound.
- Silicone Material is Soft to Seal between Speaker and Door Panel
- Silicone Material is Durable for Harsh Environment
- The Egg Wave Foam behind Speaker Improves Sound by Preventing Sound Wave Bounced back



X-450RTF

- Double Speakon with Double 1/4" Terminal and Foam Seal
- In/Out XLR Terminal
- In/Out 1/4" Terminal
- Banana Plug/Speaker Wire Input

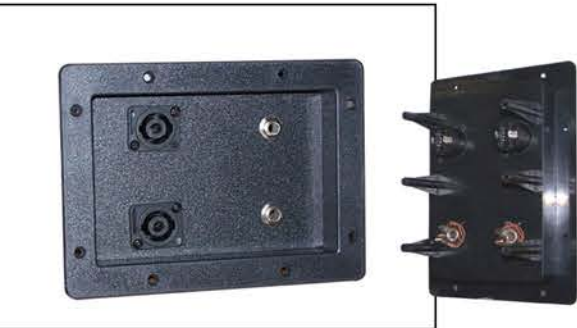

X-825

- Double Speakon with Double 1/4" Terminal
- 7" x 5"
- Without Crossover

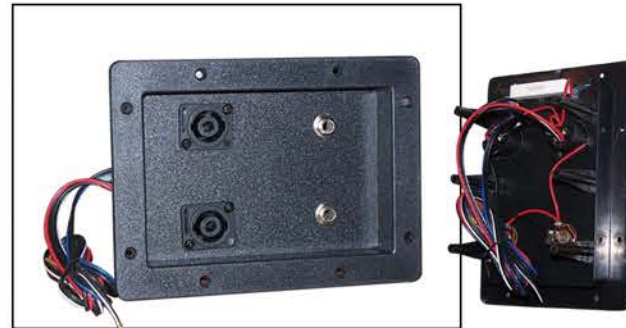

X-870

- Double Speakon Terminal with Double 1/4" Terminal
- 7" x 5"
- With Crossover

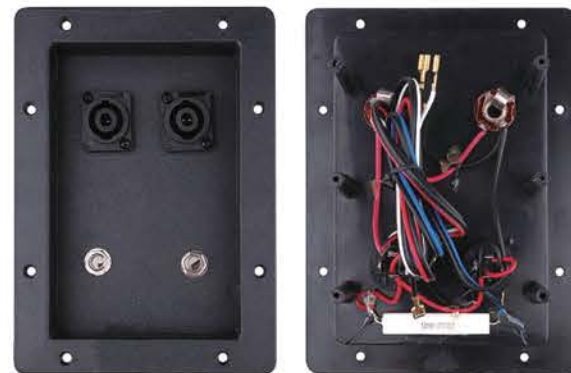

BCP-2.2

- 2.2  $\mu$ F CAPACITANCE
- Non-Polarized Electrolytic Capacitor
- 100V
- Power Handling: 200W
- 5% Dissipation Factor



BCP-4.7

- 4.7  $\mu$ F CAPACITANCE
- Non-Polarized Electrolytic Capacitor
- 100V
- Power Handling: 200W
- 5% Dissipation Factor

WRS-5 (25W, 5 Ohm Resistor)

WRS-1010 (10W, 10 Ohm Resistor)

WRS-1015 (10W, 15 Ohm Resistor)

WRS-2015 (20W, 15 Ohm Resistor)

WRS-2525 (25W, 25 Ohm Resistor)

WRS-3310 (33W, 10 Ohm Resistor)

NON-INDUCTIVE RESISTORS

- Audio Grade Resistors are used in Zobel Networks and fixed L-pad Attenuator Circuits for Tweeters. Nickel-Chromium Elements, a High Thermal Conductivity Ceramic Core, and Welded Construction all Contribute to their Low-Noise Performance.



YCP-1.5 (1.5  $\mu$ f)

YCP-2.0 (2.0  $\mu$ f)

YCP-2.2 (2.2  $\mu$ f)

YCP-2.5 (2.5  $\mu$ f)

YCP-3.0 (3.0  $\mu$ f)

YCP-3.3 (3.3  $\mu$ f)

YCP-4.7 (4.7  $\mu$ f)

YCP-10 (10  $\mu$ f)

YCP-22 (22  $\mu$ f)

MYLAR CAPACITOR

- 25 Pieces
- Low Noise Metalized Film Capacitors for High-End Car Audio installs. Metalized Capacitors Combined the Reliability of Self-Healing Action with High Dielectric Strength.



# INSTALLATION

TNT PRODUCTS LINE



**TNT-SQ11M**  
• Hard Credit Card Squeegee



**TNT-SQ29M**  
HARD SQUEEGEE  
• Used by window film installers, tinters, to get the water out of tight spots.  
• It's a must have tool for any tinter.  
• Great for scraping and installation/removal of vinyl wraps



**TNT-SQ35H (3.5")**  
• Small Power Squeegee



**TNT-SQ35SF (3.75")**  
• Small SOFT Power Squeegee

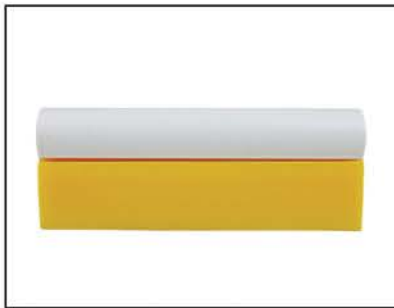

**TNT-SQ55 (5.5")**  
• Small Power Squeegee



**TNT-SQ35MAH**  
• Pro Handle Squeegee



**TNT-SQ22S**  
• Soft/Long Edge Squeegee  
• Ideal for Windowpanes, French Door Panes, Countertops, Mirrors and Auto Windows

## GTD-1200

- Heat Blower Gun
- For Stripping Paint and Varnish Thawing Metal Pipes, Drying Paint Plaster, Heating Shrink Tubing, Shaping and Bonding Plastic and Pipe Connections and also Commonly Used for Drying Window Tinting
- Power: 750/1500W
- Voltage: 110-220V
- Frequency: 50/60Hz



## TNT-SPP42

- Pressurized Water Pump Sprayer
- 42 Oz.



# INSTALLATION

TNT PRODUCTS LINE



**TNT-SC10**  
RETRACTABLE SAFETY SCRAPER  
• Intermediate Blade Position Keeps the Blade from Sliding Out while in Use  
• Removes Old Window Tinting Film or Adhesives from Glass, Tile, Wall or other Smooth Surfaces  
• Blade Retracts for Safe Storage  
• Uses Standard Single Edge Razor Blades



**TNT-SC10010-SB**  
REPLACEMENT BLADE  
• 1Box = 100 Pcs

## TNT-KN09

- AUTO-LOCK UTILITY KNIFE
- Sleek, Lightweight Stainless Steel Handle
  - Slide Lock for Convenient One Hand Operation
  - Use Safety Goggles
  - Retract the Blade after each Use
  - Dispose of use Blade Segment Properly
  - Keep Out of Reach of Children

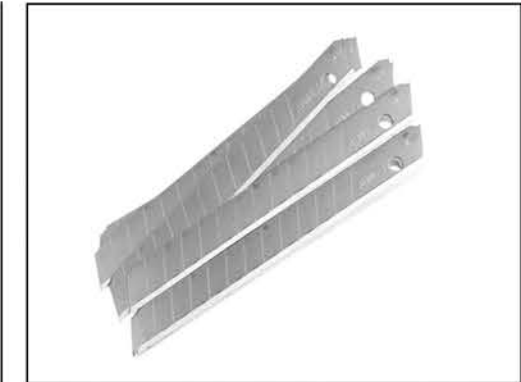

**TNT-KN1210-SB**  
STAINLESS STEEL BLADE  
• Replacement for TNT-KN12

**9 mm**  
Blade Wide

**9 mm, 10 pcs**  
Blade Wide, Pcs

## TNT-BAG

- HANDY TOOL STORAGE
- 12 Pocket
  - Toughwear Handyman's
  - Designed For Tool Storage
  - Front Pocket Easily Fits Most Tapes,
  - 1" Web Belt With Quick Release Buckle for Easy Fit.



# INSTALLATION

## ACCESSORIES



**DL-1202LT**  
SNAIL HORN

- Loud Factory Sounding Tone
- Easily Replaces OEM Horn
- Zinc Plating Avoids Corrosion
- Easy to Install



**DL-1202HT**  
SNAIL HORN

- Loud Factory Sounding Tone
- Easily Replaces OEM Horn
- Zinc Plating Avoids Corrosion
- Easy to Install



**DL-1222PHT**  
SNAIL HORN

- Corrosion Resistant
- OEM Sound
- OEM Quality
- Easy to Install

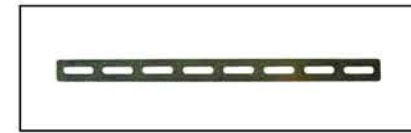

**CRI-09**

- 9" Back Strap Car Radio Installation Rod

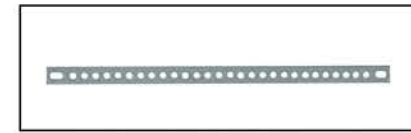

**CRI-16**

- 16" Back Strap Car Radio Installation Rod



**IS-BARST-8**  
8 EXPANDABLE CONNECTIONS

- 8 Connection Barrier Strip
- Stainless Steel Screws



**IS-BARST-12**  
12 EXPANDABLE CONNECTIONS

- 12 Connection Barrier Strip
- Stainless Steel Screws

**NTX-5000G** (Gold Plastic)  
**NTX-5700ALG** (Gold Aluminum)

SIREN OUTPUT: 112 DB

- Size: Ø130 x 125
- Output Power: 250W (P.M.P.O)  
125W (P.M.P.O)
- Impedance: 8 Ohms
- Frequency Range: 1,800Hz ~ 20,000kHz



**NTX-5000CHR**

SIREN OUTPUT: 112 DB

- Size: Ø130 x 125
- Output Power: 250W (P.M.P.O)  
125W (P.M.P.O)
- Impedance: 8 Ohms
- Frequency Range: 1,800Hz ~ 20,000kHz



**AV-1006**

SIREN OUTPUT: 119 DB

- 4" 6 Tone Siren
- Operation Power: 12V, 35W
- Sensitivity: 119dB± 3db
- Impedance: 8 Ohms



**35 WATT**  
MAX POWER

# INSTALLATION

## CARPETING ACCESSORIES

**CPT-150GRY** (Grey)  
**CPT-150BLK** (Black)  
**CPT-150BLU** (Blue)  
**CPT-150PL** (Platinum)  
**CPT-150RED** (Red)

SOUND FELT

- Indoor/Outdoor Carpeting
- Synthetic Fiber
- 4' x 150'



**CPT-450BLK** (Black)  
**CPT-450GRY** (Grey)  
**CPT-450PLT** (Platinum)

SOUND FELT

- Indoor/Outdoor Carpeting
- Synthetic Fiber
- 4' x 15'



**CPT-650** (Grey)  
**CPT-650BLK** (Black)

SOUND FELT

- 6' x 150'

**CPVC-4150BLK** (Black)  
**CPVC-4150GR** (Grey)

PVC COVERING FOR SPEAKER BOX

- 0.0023" x 54" x 0.15"



**CPT-FLE 145**

- Fleece for Fiber Glass
- 4' x 15'
- Blue



**GCF-6036 BLK**  
**GCF-6036 GRY**  
**GCF-6036 TAN**  
**GCF-6036 WIN**

Forming Grill Cloth

- 60" x 36"



TWEETERS



**NTX-1800LBR**  
4" SILVER BULLET SUPER TWEETER  
• Frequency Range: 5K~20KHz  
• Power RMS/Max: 100/200W  
• Impedance: 4 - 8 Ohms  
• Mounting Diameter: 54mm  
• Blue Light



**NTX-1800LMR**  
4" SILVER BULLET SUPER TWEETER  
• Frequency Range: 5K~20KHz  
• Power RMS/Max: 100/200W  
• Impedance: 4 - 8 Ohms  
• Mounting Diameter: 54mm  
• Multicolor



**NTX-1900BR**  
SUPER BULLET TWEETER  
• Frequency Range: 5k~20KHz  
• Power RMS/Max: 150/300W  
• Impedance: 4 - 8 Ohms  
• Mounting Diameter: 53mm  
• Blue Light



**NTX-1900SS**  
SUPER BULLET TWEETER  
• Frequency Range: 5k~20KHz  
• Power RMS/Max: 150/300W  
• Impedance: 4 - 8 Ohms  
• Mounting Diameter: 51mm  
• Silver Light



**NTXL-44R**  
4" TWEETER FLASHING RED LIGHT  
AT HIGH SOUND  
• Frequency Range: 2K~20KHz  
• Power RMS/Max: 75/150W  
• Impedance: 4 - 8 Ohms  
• Mounting Diameter: 65mm  
• Red Light



**NTXL-44BL**  
4" TWEETER FLASHING BLUE LIGHT  
AT HIGH SOUND  
• Frequency Range: 2K~20KHz  
• Power RMS/Max: 75/150W  
• Impedance: 4 - 8 Ohms  
• Mounting Diameter: 65mm  
• Blue Light



**NTX-1005RPZ**  
3 3/4" HORN CHROME TRIM  
• Frequency Range: 5k~20KHz  
• Power RMS/Max: 75/150W  
• Impedance: 4-8 Ohms  
• Mounting Diameter: 66mm  
• Black Light

AUDIO

TWEETERS



**NTX-1004EP**  
ELECTRIC PIEZO TWEETER 3/4" X 3/4"  
• Frequency Range: 4K~27KHz  
• Power RMS/Max: 30/60W  
• Impedance: 4-8 Ohms  
• Mounting Diameter: 76mm



**NTX-1004PZ**  
PIEZO TWEETER 3/4" X 3/4"  
• Frequency Range: 4K~20KHz  
• Power RMS/Max: 30/60W  
• Impedance: 4-9 Ohms  
• Mounting Diameter: 76mm

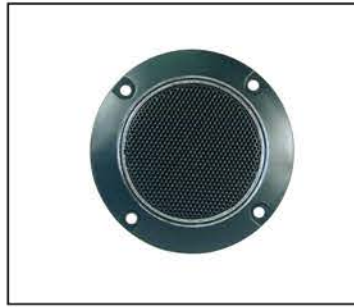

**NTX-1006PZG**  
ROUND PIEZO TWEETER W/ GRILL  
• Frequency Range: 2K~20KHz  
• Power RMS/Max: 75/150W  
• Impedance: 4-8 Ohms  
• Mounting Diameter: 66mm



**NTX-1011GR**  
SUPER HIGH PIEZO 80W TWEETER  
• Frequency Range: 5K~20KHz  
• Power RMS/Max: 75/150W  
• Impedance: 4-8 Ohms  
• Mounting Diameter: 50mm



**NTX-1033PZ**  
PIEZO TWEETER 3" SQUARE  
• Frequency Range: 5K~20KHz  
• Power RMS/Max: 75/150W  
• Impedance: 4-8 Ohms  
• Mounting Diameter: 58mm



**NTX-3004** (Plastic)  
TITANIUM SUPER TWEETER 250W  
• Frequency Range: 3K~20KHz  
• Power RMS/Max: 125/250W  
• Impedance: 4-8 Ohms  
• Mounting Diameter: 126mm



**NTX-3535PZ**  
3.5" X 3.5" TWEETER  
• Frequency Range: 2.3K~20KHz  
• Power RMS/Max: 75/150W  
• Impedance: 4-8 Ohms  
• Mounting Diameter: 73mm



**NTX-4011PZ**  
4" X 11" TWEETER  
• Frequency Range: 3K~30KHz  
• Power RMS/Max: 60W  
• Impedance: 4-8 Ohms  
• Mounting Diameter: 85mm



**NTX-4545PZ**  
4.5" X 4.5" TWEETER  
• Frequency Range: 2K~20KHz  
• Power RMS/Max: 75/150W  
• Impedance: 4-8 Ohms  
• Mounting Diameter: 85mm

TWEETERS



**NTX-1007PZ**  
3 3/4" X 2 3/4" PLASTIC SUPER HORN TWEETER  
• Frequency Range: 3K~30KHz  
• Power RMS/Max: 37.5/75W  
• Impedance: 4-8 Ohms  
• Mounting Diameter: 85mm x 39mm



**NTX-1015CML**  
HIGH-FREQUENCY HORN TWEETER  
• 7 3/8" x 3-1/8"  
• Two Tones



**NTX-1015PZ**  
2X5 PIEZO 75W TWEETER  
• Frequency Range: 3K~40KHz  
• Power RMS/Max: 37.5/75W  
• Impedance: 4-8 Ohms  
• Mounting Diameter: 121mm x 43mm



**NTX-1150DPZ**  
11" X 5" DUAL WIDE DRIVER DISPERSION PLASTIC HORN  
• Frequency Response: 3K-20 KHz  
• Power 150 Watts  
• Impedance 4~8 Ohms



**NTX-1405PZ**  
15-1/4" X 5" WIDE DISPERSION PLASTIC HORN  
• Frequency Range: 3.5K~20KHz  
• Power RMS/Max: 75/150W  
• Impedance: 4-8 Ohms  
• Mounting Diameter: 347mm x 96mm



**NTX-3007 NKL** (Nickel)  
**NTX-3007PZ** (Black)  
3-1/2" X 7-1/2" PLASTIC TWEETER  
• Frequency Range: 1,800K~30KHz  
• Power RMS/Max: 60/120W  
• Impedance: 4-8 Ohms  
• Mounting Diameter: 157mm x 53mm



**NTX-3009PZ**  
3" X 9" PLASTIC CELLULAR HORN  
• Frequency Range: 3K~30KHz  
• Power RMS/Max: 60/120W  
• Impedance: 4-8 Ohms  
• Mounting Diameter: 197mm x 65mm



**NTX-6464-WV**  
6.33" x 6.33" PLASTIC HORN  
• Frequency Range: 3K~30KHz  
• Power RMS/Max: 60/120W  
• Impedance: 4-8 Ohms  
• Mounting Diameter: 146mm x 85mm

TWEETERS



**NTX-362**  
3" X 5" DOUBLE WIDE DISPERSION  
PLASTIC TWEETER  
• Frequency Range: 3K~25KHz  
• Power RMS/Max: 75/150W  
• Impedance: 4-8 Ohms  
• Mounting Diameter: 163mm x 95mm



**NTX-3711PZ**  
3-1/2" X 3-1/2" PLASTIC SUPER  
HORN TWEETER  
• Frequency Range: 4K~27KHz  
• Power RMS/Max: 75/150W  
• Impedance: 4-8 Ohms  
• Mounting Diameter: 88mm x 88mm



**NTX-105045PZ**  
PIEZO TWEETER  
• Frequency Range: 3.5K~20KHz  
• Power RMS/Max: 75/150W  
• Impedance: 4-8 Ohms  
• Mounting Diameter: 165mm x 112mm



**NTX-1044**  
N.A. PIEZO TWEETER 4" X 4" 50  
• Frequency Range: 5~20KHz  
• Power RMS/Max: 25/50W  
• Impedance: 4-8 Ohms  
• Mounting Diameter: 77mm



**NTX-110110**  
SQUARE HORN 11" x 11"  
• Throat: 1-1/12"  
• Type: Bolt-On  
• Mounting Diameter: 212 x 212mm



**NTX-1111**  
SQUARE HORN 11.5" X 11.5"  
• Throat: 1-3/8" (34mm)  
• Type: Screw-On with Metal Thread  
• Mounting Diameter: 244 x 254.5mm

HORNS



**NTX-0714**  
SQUARE HORN 7 1/4" X 7 1/4"  
• Throat: 1-1/2" (240mm)  
• Type: Bolt-On for Solid Fitting  
• Mounting Diameter: 150mm x 150mm



**NTX-0714SCR**  
SQUARE HORN 7 1/4" X 7 1/4"  
• Throat: 1-3/8" (33mm)  
• Type: Copper Thread Screw  
• Mounting Diameter: 147mm x 148mm



**NTX-1466**  
SQUARE HORN 5-1/2"x 6-1/4"x 4-1/2"  
• Throat: 2" (50mm)  
• Type: Screw-On with Metal Thread  
• Mounting Diameter: 158mm x 140mm



**NTX-1711**  
HORN WITHOUT DRIVER  
• Throat: 1-1/2" (38)  
• Type: Screw-On/Bolt-On with Accessories  
Included  
• Mounting Diameter: 432mm x 385mm



**NTX-1810**  
LARGE LIP HORN 18"X10"  
• Throat: 1-3/8" (34mm)  
• Type: Screw-On with Metal Thread  
• Mounting Diameter: 463mm x 243mm



**NTX-3515**  
PLASTIC HORN WITHOUT DRIVER  
• Throat: 1-3/8" (34mm)  
• Type: Screw-On with Metal Thread  
• Mounting Diameter: 348.5mm x 75mm



**NTX-1407**  
HORN 7" X 13-3/4" X 8-1/2" DEEP  
• Throat: 1-3/8" (34mm)  
• Type: Screw-On with Metal Thread  
• Mounting Diameter: 320mm x 140mm



**NTX-1425**  
PLASTIC HORN WITHOUT DRIVER  
• Throat: 1" (25mm)  
• Type: Metal Socket for Solid Fitting  
• Mounting Diameter:  
105.7mm x 105.7mm

**NTX-1450**

IRON HORN WITHOUT DRIVER  
• Compact Size, Flat Front  
• Aluminum Exponential Horn  
• 50mm (2") Throat  
• 45° x 45° Nominal Coverage



**NTX-1451PL**

IRON HORN WITHOUT DRIVER  
• Compact Size, Flat Front  
• Polished Edge  
• Aluminum Exponential Horn  
• 50mm (2") Throat  
• 45° x 45° Nominal Coverage



**NTX-410CML**  
TWO TONE ABS HORN  
• Throat: 1-3/8" (34mm)  
• Type: Screw-On with Plastic Thread  
• Mounting Diameter: 265mm x 112mm



**NTX-77M**  
PLASTIC HORN W/ METAL THREAD  
• Dimensions: 7.5" x 6" x 5"  
(LxWxH)  
• Metal Thread Throat



**NTX-417**  
4" X 10" HORN 180W  
• Frequency Range: 500K~11KHz  
• Power RMS/Max: 100/200W  
• Impedance: 4-8 Ohms  
• Mounting Diameter:  
270mm x 100mm x 196mm





**NTX-515**  
5 X 15 HORN WITH METAL SOCKET  
• Throat: 1-3/8" (34mm)  
• Type: Screw-On with Metal Thread  
• Mounting Diameter: 388mm x 130mm



**NTX-5565**  
5.5" x 6.5" ABS PLASTIC HORN  
• Throat: 1" (26.5mm)  
• Type: Bolt-On  
• Mounting Diameter: 100mm x 125mm



**NTX-6080**  
6" x 8" ABS PLASTIC HORN  
• Throat: 1" (26.5mm)  
• Type: Bolt-On  
• Mounting Diameter: 160mm x 120mm



**NTX-617**  
HORN 6" x 17" WITH LARGE LIP  
• Throat: 1-3/8" (34mm)  
• Type: Screw-On with Metal Thread  
• Mounting Diameter: 194mm x 154mm



**NTX-6170**  
BIG HORN 6" x 17" NO LIP  
• Throat: 1-3/8" (34mm)  
• Type: Screw-On with Metal Thread  
• Mounting Diameter: 418mm x 160mm



**NTX-7095**  
7" x 9.5" ABS PLASTIC HORN  
• Throat: 1" (26.5mm)  
• Type: Bolt-On  
• Mounting Diameter: 190mm x 140mm



**NTX-76**  
PLASTIC HORN 7" X 6"  
• Throat: 1-1/4" (31mm)  
• Type: Screw-On with Metal Thread  
• Mounting Diameter: 194mm x 154mm



**NTX-917**  
9" X 17" Horn with 2" Hole & 1  
• Throat: 1-3/8" and includes 2" Adapters  
• Type: Bolt-On  
• Mounting Diameter: 348.5mm x 75mm



**NTX-BN**  
ABS HORN FLARE w/ 2" THROAT  
• Throat: 2"  
• Type: Bolt-On  
• Mounting Diameter: 260mm x 140mm

**NDX-1225**  
COMPRESSION DRIVER  
• Maximum Power: 100W  
• Frequency Range: 2K-21KHz  
• Impedance: 8 Ohms



**NDX-1312**  
12 OZ. DRIVER TITANIUM DIAPHRAGM  
• Voice Coil: 1-1/4" (34.4mm)  
• Impedance: 8 Ohms  
• Power 200W  
• Diameter: 1" (25.4mm)  
• Mount Screw: 1-3/8" (1cm)  
• O.C. Resistance: 5.8  
• Sensitivity: 102dB/W/m  
• 100W RMS  
• Frequency: 1500-20KHz  
• Density: 1.5T  
• Net Weight: 0.74Kg  
• Measurement: 105mm x 76 mm



**NDX-3540**  
300 WATTS DRIVER  
• Voice Coil: 1-1/2" (38mm) Aluminum  
• Impedance: 8 Ohms  
• Magnet: 40 Oz.  
• Power RMS/Max: 150/300W  
• Mounting Diameter: 34mm



**NSDV-1312**  
1.35" KSV VOICE COIL  
• Impedance: 8Ω  
• Replacement Voice Coil  
VOICE COIL FOR NDX-1312



**NSDV-2222PL**  
2" REPLACEMENT VOICE COIL  
• Impedance: 8Ω



**NTX-4000USA**  
HIGH-GRADE DYNAMIC DRIVER  
• Voice Coil: 2" (51mm) Aluminum  
• Impedance: 8 Ohms  
• Power RMS/Max: 250/500W  
• Mounting Diameter: 90mm



**NDX-6720**  
20 OZ. DRIVER  
• Voice Coil: 1-1/2" (38mm) Aluminum  
• Impedance: 8 Ohms  
• Magnet: 20 Oz.  
• Power RMS/Max: 175/350W  
• Mounting Diameter: 34mm

NSDV-6720  
Replacement Coil



**NDX-6740**  
40 OZ. DRIVER  
• Voice Coil: 1-1/2" (38mm) Aluminum  
• Impedance: 8 Ohms  
• Magnet: 40 Oz.  
• Power RMS/Max: 200/400W  
• Mounting Diameter: 34mm

NSDV-6740  
Replacement Coil

PIEZO DRIVERS/SPEAKERS



**NTD-100**  
PIEZO DRIVER SMALL  
• Frequency Response: 3.5-20KHz  
• Impedance: 4-8 Ohms  
• Power RMS/Max: 37.5/75W



**NTD-300**  
PIEZO DRIVER LARGE  
• Frequency Response: 1.5-22KHz  
• Impedance: 4-8 Ohms  
• Power RMS/Max: 50/100W



**NTD-350**  
PIEZO DRIVER LARGE  
• Frequency Response: 1.5-22KHz  
• Impedance: 4-8 Ohms  
• Power RMS/Max: 50/100W



**NTX-1S**  
2" SQUARE TWEETER 20W  
• Frequency Response: 2K-18KHz  
• Power: 20W  
• Impedance: 8 Ohms  
• Mounting Diameter:  $\varnothing$  66.5-4-4.5\*6.5



**NTX-2S**  
2.5" SQUARE SPEAKER  
• Frequency Response: 2K-18k Hz  
• Power RMS/Max: 10/20W  
• Impedance: 8 Ohms  
• Mounting Diameter:  $\varnothing$  74-4-4.5\*7



**NTX-3R**  
3.5" ROUND SPEAKER  
• Frequency Response: 2K-18K Hz  
• Power RMS/Max: 10/20W  
• Impedance: 8 Ohms  
• Mounting Diameter:  $\varnothing$  89-4- $\varnothing$  5

P.A. HORN SPEAKER



**NAD-60**  
60 WATTS DRIVER UNIT IVORY  
• Frequency Response: 180-5000Hz  
• RMS/Max Power: 60/120W  
• Impedance: 16 Ohms  
• Voice Coil: 51.6mm (2") Til



**NAD-100**  
100 WATTS DRIVER UNIT IVORY  
• Frequency Response: 180-500Hz  
• RMS/Max Power: 100/200W  
• Impedance: 16 Ohms  
• Voice Coil: 51.6mm (2") Til



**TD-200**  
DRIVER UNIT  
• Frequency Response: 160-6000Hz  
• RMS/Max Power: 150/300W  
• Impedance: 16 Ohms  
• Voice Coil: 66KSV



**TD-60**  
DRIVER UNIT  
• Frequency Response: 180-5000Hz  
• RMS/Max Power: 60/120W  
• Impedance: 16 Ohms  
• Voice Coil: 51.6mm (2") Til



**TD-100**  
DRIVER UNIT  
• Rated Input: 100W RMS / 200W Max  
• Impedance: 16 Ohm  
• S.P.L. (1W/M): 110 dB  
• Frequency Response: 180-5000 Hz  
• Voice Coil: 51.6mm (2") til  
• Magnet: 120 x 60 x 20 mm



**PD-1000-710V**  
POWER DRIVER  
• With 70V/100V Transformer  
• Load Rating: 100W  
• Transformer Tappings:  
100W-50W-50W(100V)  
100W-50W-25W-12.5W (70V)  
• Frequency Range: 300Hz ~ 5KHz



**TDO-100**  
DRIVER UNIT  
• Frequency Response: 500-3000Hz  
• RMS/Max Power: 50/100W  
• Impedance: 16 Ohms  
• Voice Coil: 51.6mm (2") Til

U-60 (60W)  
U-100F (100W)  
U-100F OD (100W)  
U-200 (200W)  
VOICE COILS FOR P.A. DRIVERS

U-55S  
REPLACEMENT VOICE COIL  
• to SI-55S

U-77S  
REPLACEMENT VOICE COIL  
• to SI-77S



ADAPTERS/VOICE COILS



**NSDV-1215**  
 • Replacement Voice Coil for DRVP-1215



**NSDV-1520**  
 • Replacement Voice Coil for DRVP-1520



**NSDV-2020**  
 • Replacement Voice Coil for DRVP-2020



**NSDV-2040**  
 • Replacement Voice Coil for DRVP-2040



**NSDV-3004**  
 REPLACEMENT VOICE COIL



**VC-CM15-48**  
 • Coil Diameter: Ø1.5"  
 • Material of Coil: KSV  
 • Mounting Diameter: Ø3.1"  
 • Height of the Coil: 0.22"  
 Replacement for:  
 NDX-6720  
 NDX-6740



**DRAD-100**  
 DRIVER ADAPTER  
 Adapter Converts following Applications:  
 Bolt-On Type Compression Driver to  
 Screw Type Horn  
 Screw Type Compression Driver  
 to Bolt-On Type Horn



**DRVAD-1215**  
 • Driver Adapter 7/8" for 1" Diameter



**DRVAD-1520**  
 • Driver Adapter 1 3/8" for 1" Diameter

MIDRANGES



**MG-513**  
 10 OZ. SPEAKER WITH GRILL  
 • Frequency Response: 160-16000Hz  
 • Power RMS/Max: 30/60W  
 • Impedance: 8 Ohms  
 • Mounting Diameter: C 116-4- C 5.2



**NMG-408**  
 4" MIDRANGE 25 WATTS  
 • Frequency Response: 1,200-15Hz  
 • Power RMS/Max: 12.5/25W  
 • Impedance: 8 Ohms  
 • Mounting Diameter: C 114-4- C 5



**NMG-510**  
 5" MIDRANGE 60 WATTS  
 • Frequency Response: 1K-15KHz  
 • Power RMS/Max: 12.5/25W  
 • Impedance: 8 Ohms  
 • Mounting Diameter: C 135-4- C 4.5



**NMG-612**  
 6" MIDRANGE 70 WATTS  
 • Frequency Response: 800-10KHz  
 • Power RMS/Max: 35/70W  
 • Impedance: 8 Ohms  
 • Mounting Diameter: C 166-4- C 4.2



**NMG-818**  
 8" MIDRANGE 90 WATTS  
 • Frequency Response: 600-10KHz  
 • Power RMS/Max: 45/90W  
 • Impedance: 8 Ohms  
 • Mounting Diameter: C 211.5-6- C 4.8

**NMX-412-8**  
 4 1/2" MIDRANGE 30WATTS  
 • Frequency Response: 700-6KHz  
 • Power RMS/Max: 15/30W  
 • Impedance: 8 Ohms  
 • Mounting Diameter: C 119-4- C 5



**NMX-516-8**  
 5" MIDRANGE 100 WATTS  
 • Frequency Response: 500-10KHz  
 • Power RMS/Max: 15/30W  
 • Impedance: 8 Ohms  
 • Mounting Diameter: C 124.5-4- C 4.5





**NWX-4002**

- 4" WOOFER
- Frequency Response: 130-8KHz
  - Power RMS/Max: 15/45W
  - Impedance: 8 Ohms
  - Mounting Diameter:  $\text{C } 117\text{-}2\text{-}6.5\text{*}12$



**NWX-4013CR**

- 4" PAPER CONE SPEAKER
- Frequency Response: 160-16000Hz
  - Power RMS/Max: 15/45W
  - Impedance: 4 Ohms
  - Mounting Diameter:  $\text{C } 117\text{-}2\text{-}6.5\text{*}12$



**NWX-5035-8RD**

- 5" MIDRANGE PAPER CONE
- Frequency Response: 90-14000Hz
  - Power RMS/Max: 12.5/25W
  - Impedance: 8 Ohms
  - Mounting Diameter:  $\text{C } 119.5\text{-}4\text{-} \text{C } 5$



**NWX-416-8**

- 4" WOOFER 70 WATT 1" AL VOICE C
- Frequency Response: 90-14000Hz
  - Power RMS/Max: 35/70W
  - Impedance: 4 Ohms
  - Mounting Diameter:  $\text{C } 115\text{-}4\text{-}5\text{*}7$



**NWX-516-4SQ**

- 4" PAPER CONE
- Frequency Response: 65-12000Hz
  - Power RMS/Max: 50/100W
  - Impedance: 4 Ohms
  - Mounting Diameter:  $\text{C } 138\text{-}4\text{-}5.5\text{*}8$



**NBM-406S**

- DOUBLE MAGNET SPEAKER, 4" FOAM PA
- Frequency Response: 120-16000Hz
  - Power RMS/Max: 10/20W
  - Impedance: 8 Ohms
  - Mounting Diameter:  $\text{C } 119\text{-}4\text{-} \text{C } 4.3$



**NBM-612S**

- DOUBLE MAGNET SPEAKER
- Frequency Response: 65-12000Hz
  - Power RMS/Max: 15/30W
  - Impedance: 8 Ohms
  - Mounting Diameter:  $\text{C } 157\text{*}4\text{-}5\text{*}8$



**NWC-466**

- 4" X 6" WOOFER 25 WATTS
- Frequency Response: 80-14000Hz
  - Power RMS/Max: 12.5/25W
  - Impedance: 8 Ohms
  - Mounting Diameter:  $77\text{*}133\text{-}3\text{-} \text{C } 7$



**NWX-516-8SQ**

- 4" PAPER CONE
- Frequency Response: 65-12000Hz
  - Power RMS/Max: 50/100W
  - Impedance: 8 Ohms
  - Mounting Diameter:  $\text{C } 138\text{-}4\text{-}5.5\text{*}8$



**NWX-520-4SQ**

- 4" PAPER CONE
- Frequency Response: 70-7000Hz
  - Power RMS/Max: 100/200W
  - Impedance: 4 Ohms
  - Mounting Diameter:  $138\text{*}4\text{-}5.5\text{*}8$



**NWX-520-8SQ**

- 4" PAPER CONE
- Frequency Response: 100Hz-12000Hz
  - Power RMS/Max: 30/60W
  - Impedance: 8 Ohms
  - Mounting Diameter:  $138\text{*}4\text{-}5.5\text{*}8$



**NWX-403-4**

- 4" WOOFER 50 WATTS
- Frequency Response: 120-16000Hz
  - Power RMS/Max: 25/50W
  - Impedance: 4 Ohms
  - Mounting Diameter:  $\text{C } 117\text{-}4\text{-}5\text{*}7$



**NWX-416-4**

- 4" WOOFER 70 WATT 1" AL VOICE C
- Frequency Response: 90-14000Hz
  - Power RMS/Max: 35/70W
  - Impedance: 4 Ohms
  - Mounting Diameter:  $\text{C } 115\text{-}4\text{-}5\text{*}7$



**NMX-2003**

- 4" SILVER CD CONE WITH FOAM EDGE
- 0.7" Aluminum Voice Coil
  - 7 Oz. Magnet
  - 35W
  - 8 Ohms



**NWX-610-4**

- 6" PAPER CONE
- Frequency Response: 80Hz-13000Hz
  - Power RMS/Max: 30/60W
  - Impedance: 4 Ohms
  - Mounting Diameter:  $156.5\text{*}4\text{-}5$



**NWX-610-8**

- DOUBLE MAGNET SPEAKER
- Frequency Response: 65-12000Hz
  - Power RMS/Max: 15/30W
  - Impedance: 8 Ohms
  - Mounting Diameter:  $\text{C } 157\text{-}4\text{-}5\text{*}8$



**NWX-612-4**  
 6" FOAM EDGE PAPER CONE  
 • Frequency Response: 85Hz-12000Hz  
 • Power RMS/Max: 32.5/65W  
 • Impedance: 4 Ohms  
 • Mounting Diameter: 157\*4-5\*8



**NWX-612-8**  
 6" FOAM EDGE PAPER CONE  
 • Frequency Response: 85Hz-12000Hz  
 • Power RMS/Max: 32.5/65W  
 • Impedance: 8 Ohms  
 • Mounting Diameter: 157\*4-5\*8



**NWX-613-4** (4 Ohms)  
**NWX-613-8** (8 Ohms)  
 6" PAPER CONE  
 • Frequency Response: 85Hz-12000Hz  
 • Power RMS/Max: 12.5/25W  
 • Mounting Diameter: 157\*4-5\*8



**NWX-616-4** (4 Ohms)  
**NWX-616-8** (8 Ohms)  
 6.5" PAPER CONE  
 • Frequency Response: 85Hz-12000Hz  
 • Power RMS/Max: 40/80W  
 • Mounting Diameter: 157\*4-5\*8

**NWX-620-4** (4 Ohms)  
**NWX-620-8** (8 Ohms)  
 6.5" PAPER CONE  
 • Frequency Response: 70-8KHz  
 • Power RMS/Max: 40/80W  
 • Mounting Diameter: Φ144MM



**NWX-623-8**  
 6.5" PAPER CONE  
 • Frequency Response: 70Hz-13000Hz  
 • Power RMS/Max: 65/130W  
 • Impedance: 8 Ohms  
 • Mounting Diameter: 156\*4-5.8



**NWX-820-4** (4 Ohm)  
**NWX-820-8** (8 Ohm)  
 6.5" PAPER CONE  
 • Frequency Response: 70-8KHz  
 • Power RMS/Max: 40/80W  
 • Mounting Diameter: Φ144MM



**NWX-832R** (Rubber Edge)  
**NWX-832C** (Cloth Edge)  
 8" PAPER CONE  
 • Frequency Response: 70Hz-13000Hz  
 • Power RMS/Max: 100/200W  
 • Impedance: 4 Ohms  
 • Mounting Diameter: 213\*4-4.5



**NWX-1844ST**  
 15" PAPER CONE  
 • Frequency Response: 25-6KHz  
 • Power RMS/Max: 175/300W  
 • Impedance: 8 Ohms  
 • Mounting Diameter: Φ420MM



**NSCE-620**  
 WOOFER WITH 1" ALUMINUM VOICE COIL  
 • 6" Paper Cone with Cloth Edge  
 • Frequency Response: 70-10000 Hz  
 • Magnet Weight: 20 Oz.  
 • Sensitivity: 86 dB  
 • Voice Coil Size: 1" ASV  
 • Max Power: 250W  
 • Impedance: 8 Ohms



**NSCE-830**  
 WOOFER WITH 1" ALUMINUM VOICE COIL  
 • 8" Paper Cone with Cloth Edge  
 • Frequency Response: 50-5000 Hz  
 • Magnet Weight: 30 Oz.  
 • Sensitivity: 89 dB  
 • Voice Coil Size: 1" ASV  
 • Max Power: 350W  
 • Impedance: 8 Ohms



**NSCE-1040**  
 10" WOOFER WITH 2" ALUMINUM VOICE COIL  
 • 10" Paper Cone with Cloth Edge  
 • Frequency Response: 50-4500 Hz  
 • Magnet Weight: 40 Oz.  
 • Sensitivity: 88 dB  
 • Voice Coil Size: 2" ASV  
 • Max Power: 425W  
 • Impedance: 8 Ohms



**NSCE-1250**  
 WOOFER WITH 2" ALUMINUM VOICE COIL  
 • 12" Paper Cone with Cloth Edge  
 • Frequency Response: 35-5000 Hz  
 • Magnet Weight: 50 Oz.  
 • Sensitivity: 92 dB  
 • Voice Coil Size: 2" ASV  
 • Max Power: 500W  
 • Impedance: 8 Ohms



**NSCE-1550**  
 WOOFER WITH 2" ALUMINUM VOICE COIL  
 • 12" Paper Cone with Cloth Edge  
 • Frequency Response: 35-5000 Hz  
 • Magnet Weight: 50 Oz.  
 • Sensitivity: 92 dB  
 • Voice Coil Size: 2" ASV  
 • Max Power: 500W  
 • Impedance: 8 Ohms



**NWX-655**  
 6" HIGH-POWERED SUBWOOFER  
 • 150 Watts Max Power  
 • 75 Watts Rated Power  
 • Frequency Response: 45-4800Hz  
 • Sensitivity: 89 dB  
 • 1" 2-Layer Single Voice Coil ASV  
 • Rigid Steel Basket  
 • Mounting Depth: 74mm (3")  
 • Impedance: 8 Ohms  
 • 20 Oz. Magnet



**NWX-855**  
 8" HIGH-POWERED SUBWOOFER  
 • 200 Watts Max Power  
 • 100 Watts Rated Power  
 • Frequency Response: 40-5000Hz  
 • Sensitivity: 89 dB  
 • 1" 2-Layer Single Voice Coil ASV  
 • Rigid Steel Basket  
 • Mounting Depth: 88mm (3-1/2")  
 • Impedance: 8 Ohms  
 • 20 Oz. Magnet



**NWX-1055**  
 10" HIGH-POWERED SUBWOOFER  
 • 350 Watts Max Power  
 • 175 Watts Rated Power  
 • Frequency Response: 35-4000Hz  
 • Sensitivity: 90 dB  
 • 1.5" 2-Layer Single Voice Coil ASV  
 • Rigid Steel Basket  
 • Mounting Depth: 107mm (4-1/4")  
 • Impedance: 8 Ohms  
 • 33 Oz. Magnet



**NWX-1255**  
 12" HIGH-POWERED SUBWOOFER  
 • 450 Watts Max Power  
 • 225 Watts Rated Power  
 • Frequency Response: 35-3500Hz  
 • Sensitivity: 90 dB  
 • 1.5" 2-Layer Single Voice Coil ASV  
 • Rigid Steel Basket  
 • Mounting Depth: 120mm (4-3/4")  
 • Impedance: 8 Ohms  
 • 33 Oz. Magnet



**NWX-1555**  
 15" HIGH-POWERED SUBWOOFER  
 • 500 Watts Max Power  
 • 250 Watts Rated Power  
 • Frequency Response: 27-3000Hz  
 • Sensitivity: 91 dB  
 • 2" 2-Layer Single Voice Coil ASV  
 • Rigid Steel Basket  
 • Mounting Depth: 153mm (6")  
 • Impedance: 8 Ohms  
 • 38 Oz. Magnet



**NWX-1255-8**  
 15" HIGH-POWERED SUBWOOFER  
 • 450 Watts Max Power  
 • 225 Watts Rated Power  
 • Frequency Response: 30-3500Hz  
 • Sensitivity: 90dB  
 • 1.5" 2-Layer Single Voice Coil ASV  
 • Rigid Steel Basket  
 • Mounting Depth: 4 3/4"  
 • Impedance: 8 Ohms  
 • 33 Oz Magnet





**STX-848**

8" WOOFER WITH 1" ASV VOICE COIL

- 150 Watts
- with Foam Edge
- Voice Coil: 1" ASV
- Magnet: 20 Oz.
- Frequency Response: 50Hz-12KHz
- Impedance: 8Ω
- Sensitivity: 88 dB
- Sold Individually



**STX-1048**

10" WOOFER WITH 1.5" ASV VOICE COIL

- 300 Watts
- with Foam Edge
- Voice Coil: 1.5" ASV
- Magnet: 30 Oz.
- Frequency Response: 35Hz-10KHz
- Impedance: 8Ω
- Sensitivity: 88 dB
- Sold Individually



**STX-1248**

12" WOOFER WITH 2" ASV VOICE COIL

- 350 Watts
- with Foam Edge
- Voice Coil: 2" ASV
- Magnet: 30 Oz.
- Frequency Response: 30Hz-10KHz
- Impedance: 8Ω
- Sensitivity: 89 dB
- Sold Individually



**STX-1548**

15" WOOFER WITH 2" ASV VOICE COIL

- 600 Watts
- with Foam Edge
- Voice Coil: 2" ASV
- Magnet: 40 Oz.
- Frequency Response: 30Hz-8KHz
- Impedance: 8Ω
- Sensitivity: 89 dB
- Sold Individually



**SRZ-616C**

6" DUAL CONE LOUDSPEAKER

- Frequency Response: 75-25000 Hz
- Magnet Weight: 16 Oz.
- Sensitivity: 88 dB
- Voice Coil Size: 1" ASV
- Max Power: 100 W
- Impedance: 8 Ohms
- Sold Individually



**SRZ-820C**

8" DUAL CONE LOUDSPEAKER

- Frequency Response: 55-25000 Hz
- Magnet Weight: 20 Oz.
- Sensitivity: 88 dB
- Voice Coil Size: 1" ASV
- Max Power: 150 W
- Impedance: 8 Ohms
- Sold Individually



**SRZ-1024C**

10" DUAL CONE LOUDSPEAKER

- Frequency Response: 35-15000 Hz
- Magnet Weight: 24 Oz.
- Sensitivity: 88 dB
- Voice Coil Size: 1.5" ASV
- Max Power: 300 W
- Impedance: 8 Ohms
- Sold Individually



SPEAKER TERMINALS



**21-242**  
SPEAKER TERMINAL CONNECTOR  
• Size: 2mm  
• Type: Plug-In Connector



**21-243**  
SPEAKER TERMINAL CONNECTOR  
• Size: 4 to 5mm  
• Type: Plug-In Connector



**T-110**  
SPEAKER TERMINAL  
• Size: 2 1/8"  
• Type: Push-In



**X-450RTF**  
• Double Speakon w/ Double 1/4" Terminal and Foam Seal  
• In/Out XLR Terminal  
• In/Out 1/4" Terminal  
• Banana Plug/Speaker Wire Input



**T-200**  
SPEAKER TERMINAL (COLOR CODED)  
• Size: 3 3/4" x 3"  
• Type: Screw-In



**T-235G**  
SPEAKER TERMINAL (GOLD)  
• Size: 3 3/4" x 3"  
• Type: Screw-In



**TE-30**  
SPEAKER TERMINAL  
• Size: 2 1/8"  
• Type: Screw-In



**TE-40**  
SPEAKER TERMINAL  
• Size: 2 1/4" x 2 1/4"  
• Type: Screw-In



**TE-50**  
SPEAKER TERMINAL  
• Size: 2 1/2" x 3"  
• Type: Screw-In

SPEAKER TERMINALS



**NB-506 (2P)**  
**NB-507 (4P)**  
SPRING TENSION  
• Color Coded



**X-425SQ**  
SPEAKER TERMINAL  
• Size: 100mm X 84mm  
• Type: Double SPKN and Double 1/4 Terminal



**X-825**  
2 SPKN AND  
• 2 1/4" Sockets  
• 7" x 5"  
• Without Crossover

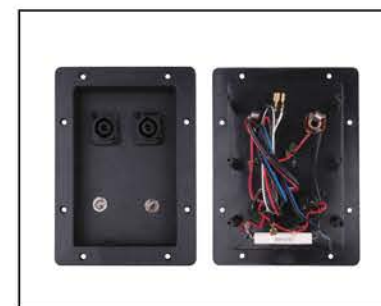

**X-870**  
2 SPKN  
• 2 1/4" Sockets  
• 7" x 5"  
• With Crossover



**XT-200**  
DOUBLE SPKN TERMINAL



**XT-2214**  
DOUBLE SPKN  
• Double 1/4" Terminal



**XK-862-1**  
TERMINAL BOARD  
• Length: 136 cm  
• Width: 89 mm  
• Weight: 95 g



**XK-863-1**  
TERMINAL BOARD  
• Length: 179 cm  
• Width: 126 mm  
• Weight: 250 g



SPEAKER TERMINALS



**TE-22G**  
SPEAKER TERMINAL  
• 2" x 2"  
• Push-In Type with Gold Post



**TE-24G**  
SPEAKER TERMINAL  
• 2" x 2"  
• Screw-In Type with Gold Post



**T-300J**  
TERMINAL  
• 2 1/4" Jacks



**T-500**  
**T-500J** (Two 1/4" Jacks)  
TERMINAL WITH GOLDEN-PLATING  
• 4"  
• Gold Ends  
• Two 1/4 Jacks



**T-700G**  
TERMINAL  
• 3 1/8" x 3 1/8"  
• Gold Post  
  
TERMINAL BINDING POST- GOLD



**T-705PG**  
TERMINAL  
• 3.25" x 3.25" x 1"  
• Gold Post  
  
TERMINAL PUSH-IN BINDING POST- GOLD



**T-707G**  
TERMINAL  
• 3 3/4" x 4 7/8"  
• Gold Post  
  
TERMINAL BINDING POST- GOLD

SPEAKER TERMINALS



**TCR-100R**  
SPEAKER TERMINAL  
• Size: 4-1/2"  
• Type: 2 1/4" Jacks with Crossover



**TCR-200**  
SPEAKER TERMINAL  
• Size: 3-1/4" x 4"  
• Type: 2 1/4" Jacks without Crossover

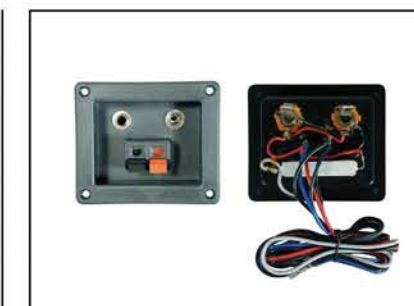

**TCR-200SQ**  
SPEAKER TERMINAL  
• Size: 3-1/4" x 4"  
• Type: 2 1/4" Jacks with Crossover



**TCR-300R**  
SPEAKER TERMINAL  
• Size: 3"  
• Type: 3-Way with Crossover



**T-37 BLK**  
**T-37 RED**  
TERMINAL BINDING POST



**P-101TRA**  
1/4" RIGHT ANGLE PLUG  
• For Speaker Cables  
(12 Gauge & Up) Microphone Cable (All)



**NB-117B** (Black)  
**NB-117R** (Red)  
BANANA PLUG  
• Dual Mini Plug



**NB-417 BLK** (Black)  
**NB-417 RED** (Red)  
BANANA PLUG  
• Dual



**ZP-RCA-PG**  
GOLD-PLATED RCA PLUG  
• Set of Two

SPEAKER CROSSOVER

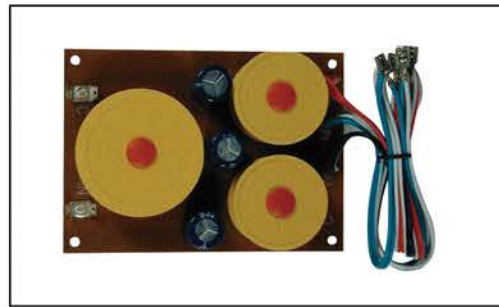

801

3-WAY CROSSOVER

- Frequency Response: 2.5K-5KHz
- Power RMS/Max: 75/150W
- Impedance: 8 Ohms

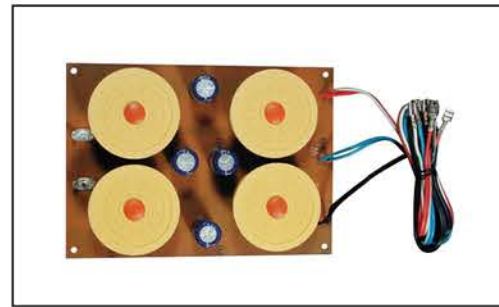

1001

3-WAY CROSSOVER

- Frequency Response: 2.5K-5KHz
- Power RMS/Max: 100/200W
- Impedance: 8 Ohms

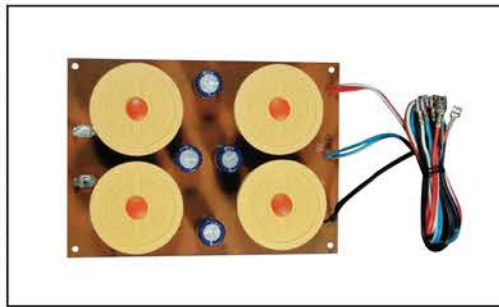

1201

3-WAY CROSSOVER

- Frequency Response: 2.5K-5KHz
- Power RMS/Max: 125/250W
- Impedance: 8 Ohms

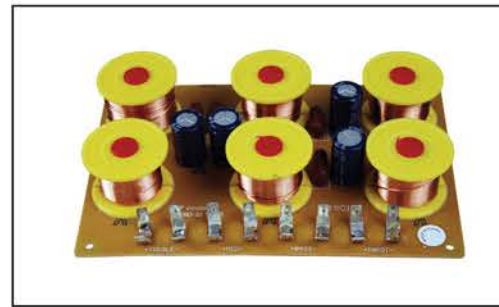

1501

3-WAY CROSSOVER

- Frequency Response: 2.5K-5KHz
- Power RMS/Max: 175/350W
- Impedance: 8 Ohms



HG-101

1 CHANNEL SUBWOOFER CROSSOVER

- Frequency Response: 120Hz Low Pass
- Power RMS/Max: 200/400W
- Impedance: 4 Ohms



N-D103TV

10 PIN DIN PLUG TO RCA 4 WAY PLUG

- Connection type features: 3-Male to 10-Pin RCA Composite Audio-Video Cable
- Perfect audio video cable that eliminates unwanted noise/feedback for pure, clear audio-video; minimal signal loss for reliably consistent video
- Cable Length: 5 feet (1.3 meters); Red-White-Yellow color-marked connectors for quick, easy audio/video hookups

VOICE COIL

KVA-60 (2-3/8", 58.48mm)  
 KVA-90 (2-6/8", 66.04mm)  
 KVA-100 (3-1/8", 78.74mm)  
 KVA-100D (3-1/8", 78.74mm)  
 KVA-800 (3-2/8", 81.28mm)  
 KAPTON VOICE COIL



KVC-1 (1", 25.4mm)  
 KVC-1.5 (1.5", 38.1mm)  
 KEVC-1.5 (1.5", 38.1mm)  
 KVC-2 (2", 50.8mm)  
 KVC-2.5 (2.5", 63.5mm)  
 KVC-3 (3", 76.2mm)  
 KVC-4 (4", 101.6mm)  
 KAPTON VOICE COIL



NVC-26 (1", 25.4mm)  
 NVC-38 (1.5", 38.1mm)  
 NVC-44 (2", 50.8mm)  
 NVC-51 (2.5", 63.5mm)  
 NVC-5104 (2", 51mm)  
 NVC-63 (3", 76.2mm)  
 NVC-77 (4", 101.6mm)  
 NVC-100 (4", 101.6mm)  
 KAPTON VOICE COIL

NVZB-1-8  
 1" ZEBRA KAPTON VOICE COIL



BW-TXX24-50  
 SPEAKERS CABLE



NSDV-4000USA

REPLACEMENT VOICE COIL

- For NTX-4000USA

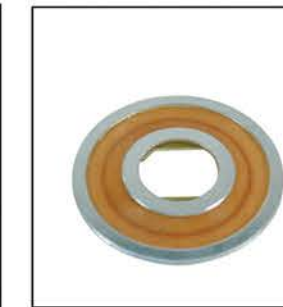

NSDV-3000

REPLACEMENT VOICE COIL

- For NTX-3000



NSDV-3500

REPLACEMENT VOICE COIL

- For NDX-3520, NDX-3540 & NDX-3580



NSDV-4040K

REPLACEMENT VOICE COIL

- 4"



NSDV-417

REPLACEMENT VOICE COIL

- For NTX-417



NSDV-420

REPLACEMENT VOICE COIL

- For NTX-420 & NTX-410



NSDV-6720

REPLACEMENT VOICE COIL

- For NDX-6720



NSDV-6740

REPLACEMENT VOICE COIL

- For NDX-6740

GK-8 (for 8")  
 GK-10 (for 10")  
 GK-12 (for 12")  
 GK-15 (for 15")  
 GK-18 (for 18")  
 GK-69 (for 69")  
 GK-69P (for 69")  
 GASKET



NCE-10 (for 10")  
 NCE-12 (for 12")  
 NCE-15 (for 15")  
 CLOTH EDGE  
 • Speaker Foam Repair



NFE-4 (for 4") NFE-4.5 (for 4.5")  
 NFE-5 (for 4") NFE-6 (for 6")  
 NFE-196-7 (196mm for 8")  
 NFE-228-186 (228mm for 6x9")  
 NFE-243-8 (243mm for 10")  
 NFE-298-9 (298mm for 12")  
 NFE-368-9 (368mm for 15")  
 FOAM EDGE  
 NFE-18-GREY (for 18")  
 FOAM EDGE  
 INNER DIAMETER: 13.5" / OUTER DIAMETER: 17.5"



NPC-4 (4")  
 NPC-5 (5")  
 NPC-6 (6")  
 PAPER CONE WITH FOAM EDGE  
 • 196mm  
 • 1-1/2" Center Core



NDC-72 (2.8" for 8")  
 NDC-90 (3.50" for 10")  
 NDC-114 (1-1/4")  
 NDC-116 (4.56" for 12")  
 NDC-124 (4.88")  
 NDC-140 (5.51")  
 NDC-150 (5.90")  
 NDC-212 (2-1/2" Black)  
 DUST CAP

NDC-336 (3-3/16" Black)  
 NDC-400 (4" Black)  
 NDC-400S (4" Silver)  
 NDC-700 (7" Black)  
 DUST CAP



NPC-196  
 PAPER CONE W/ FOAM EDGE FOR 8"  
 • 196mm  
 • 1" Center Core  
 NPC-243  
 PAPER CONE W/ FOAM  
 • 243mm  
 • 1" Center Core



NPC-228  
 PAPER CONE W/ FOAM EDGE  
 • 228mm  
 • For 6"x 9"  
 • 1" Center Core



NPC-298  
 RIBBED PAPER CONE WITH  
 FOAM EDGE  
 • 298mm  
 • For 12"



NPC-368  
 RIBBED PAPER CONE WITH  
 FOAM EDGE  
 • 368mm  
 • For 15"

NPPC-R-ST-FM250 (10")  
 NPPC-R-ST-FM300 (12")  
 NPPC-R-ST-FM380 (15")  
 NON PRESS PAPER CONE  
 • Machine Stitched Surround



NFER-6.5-166  
 RED FOAM EDGE  
 • 6.5"

NFER-8-196  
 RED FOAM EDGE  
 • 8"

NFER-10-246  
 RED FOAM EDGE  
 • 10"

NFER-12-294  
 RED FOAM EDGE  
 • 12"

NFER-15-371  
 RED FOAM EDGE  
 • 15"

NFER-18-450  
 RED FOAM EDGE  
 • 18"

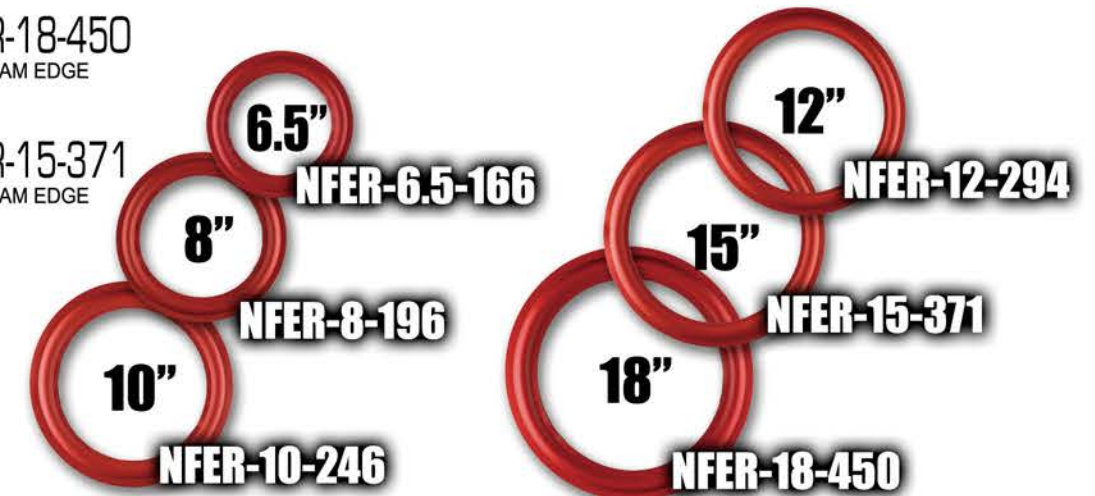



**NPC-8CE** (8")  
**NPC-12CE** (12")  
PAPER CONE  
W/ CLOTH EDGE  
• Center Core: 1.5"  
(38.1mm)

**NPC-6CE** (6")  
**NPC-10CE** (10")  
**NPC-18CE** (18")  
PAPER CONE  
W/ CLOTH EDGE  
• Center Core: 1" (25.4mm)



**NPC-380CE**  
PAPER CONE W/ CLOTH EDGE  
• Diameter: 15" (381mm)  
• Center Core: 1.5" (38.1mm)



**NPD-10CE**  
DEEP NON-PRESS PAPER  
CONES CLOTH EDGE  
• Diameter: 10" (254mm)  
• Center Core: 1.5" (38.1mm)



**NPD-10F** (6")  
**NPD-15F** (15")  
DEEP NON-PRESS PAPER CONES FOAM EDGE  
• Center Core: 1.5" (38.1mm)

**NPD-12CE** (12")  
**NPD-15CE** (15")  
**NPD-18CE** (18")  
DEEP NON-PRESS PAPER  
CONES CLOTH EDGE  
• Center Core: 1.5" (38.1mm)

**NPD-18CE-SH** (18")  
SMOOTH CONE  
W/ CLOTH EDGE  
• Diameter: 18" (457.2mm)  
• Center Core: 3" (76.2mm)



**NSP-73F**  
• Diameter: 7" x 3" x Flat  
**NSP-110**  
• Diameter: 4.5" x 1" x Flat  
**NSP-148**  
• Diameter: 6" x 1.5" x Flat  
**NSP-168**  
• Diameter: 6.5" x 1-3/4" x Flat  
**NSP-180**  
• Diameter: 7" x 2" x Flat  
**NSP-214**  
• Diameter: 2 1/2" x 1" x Flat

**NSP-313**  
• Diameter: 3 3/4"x1"x 1/2"x3/8"  
**NSP-414**  
• Diameter: 4 3/8"x2"x 1/4"  
**NSP-418**  
• Diameter: 5"x1"x 2"x 1/4"  
**NSP-521**  
• Diameter: 5"x1"x 2"x 1/2"  
**NSP-522**  
• Diameter: 5"x1"x 2"x 1/2"  
**NSP-524**  
• Diameter: 4"x1"x 2"x 1/4"

**NSP-618**  
• Diameter: 6"x 1 3/4"x 3/8"  
**NSP-623**  
• Diameter: 6"x 2"x 3/8"  
**NSP-624**  
• Diameter: 6 1/2"x 2"x 1/4"



**NSPSQ-196** (196mm)  
SPIDER  
• for 10" Square Woofer  
**NSPSQ-200** (200mm)  
SPIDER  
• for 10" Square Woofer  
**NTX-405**  
PIEZO TWEETER ELEMENT  
• for NTX-105045 & NTX-1504

**NTX-205**  
PIEZO TWEETER ELEMENT  
• with Cone for NTX-1004PZ



**YD-200-210-C6M2** (8")  
**YD-250-211-C6M1** (10")  
UNIVERSAL CLOTH EDGE  
• 12.3mm Core  
• Adjustable Center Core



**YD-250-211-M1** (10")  
UNIVERSAL FOAM EDGE  
• 13.3mm Core  
• Adjustable Center Core

**YD-300-205-C6M2** (12")  
**YD-380-98-C6M2** (15")  
UNIVERSAL CLOTH EDGE  
• 26.6mm Core  
• Adjustable Center Core



**YD-300-205-M2** (12")  
**YD-380-98-M2** (15")  
UNIVERSAL FOAM EDGE  
• 26.6mm Core  
• Adjustable Center Core



**CS-506**

5 1/4" 2 WAY CEILING SPEAKER

- 5" Woofer IMPP Cone with Rubber Edge
- 10 Oz. Magnet
- 1" ASV Coil
- 30mm
- Silk Tweeter



**CS-507**

5 1/4" 2 WAY CEILING SPEAKER

- 5" Woofer IMPP Cone with Rubber Edge
- 10 Oz. Magnet
- 1" ASV Coil
- 30mm
- Silk Tweeter



**CS-606**

CEILING SPEAKER

- 6"
- 80 Watt
- Plastic Cover
- with Transformer



**CS-65115-710V**

6 1/2" CEILING SPEAKER

- with 70V/100V Transformer can be Adjusted to 5W/10W/15W
- Load Rating @ 70V/100V: 15W
- Transformer Tappings @ 70V/100V: 15W-10W-5W
- Frequency Range: 50~20KHz
- SPL (@1Watt/1Meter): 90dB
- Impedance: 8 Ohms
- Dimension: Ø9.4"(238mm)
- Install Depth: 3.4"(86mm)
- Material: ABS
- Color: White



**CS-85115-710V**

8" CEILING SPEAKER

- with 70V/100V Transformer can be Adjusted to 5W/10W/15W
- Load Rating @ 70V/100V: 15W
- Transformer Tappings @ 70V/100V: 15W-10W-5W
- Frequency Range: 40~20KHz
- SPL (@1Watt/1Meter): 92dB
- Impedance: 8 Ohms
- Dimension: Ø10.9"(276mm)
- Install Depth: 3.7"(93mm)
- Material: ABS
- Color: White



**CS-607**

2 WAY CEILING SPEAKER

- 6" Woofer IMPP Cone with Rubber Edge
- 10 Oz. Magnet
- 1" ASV Coil
- 30mm
- Silk Tweeter



**CS-806**

8" PAPER CONE

- 1" Voice Coil
- 10 Oz. Magnet
- 8 Ohms Impedance
- 10 Watts Power Handling

**CSCT-6540**

6.5" Ceiling Speaker

- Power Rating: 30W
- Frequency Range: 70-20KHz
- SPL (@1W/m): 88dB
- Speaker Diameter: 6.5"
- Impedance: 8 Ohms
- Dimension: Ø244mm



**CSCT-8050**

8" CEILING SPEAKER

- Power Rating: 40W
- Frequency Range: 50-20KHz
- SPL (@1W/m): 90dB
- Speaker Diameter: 8"
- Impedance: 8 Ohms
- Dimension: Ø284mm



**CS-810**

8" PAPER CONE

- 0.75" Voice Coil
- 8 Oz. Magnet
- 4 Ohms Impedance
- 10 Watts Power Handling



**GRILL**

8" PLASTIC GRILL

**CSTM-6510**

6.5" Ceiling Speaker

- Power Rating: 10W
- Transformer Tapping's at 100V: 10W-5W
- Frequency Range: 130-15KHz
- SPL (@1W/m): 92dB
- Speaker Diameter: 6.5"
- Impedance: 8 Ohms
- Dimension: Ø185mm



**SS-610**

2 WAY CEILING SPEAKER

- 6" Woofer IMPP Cone With Rubber Edge
- 10 Oz. Magnet
- 1" ASV Coil
- 38mm
- Silk Tweeter
- 8 Ohms Impedance
- 100 Watt Max Power

### CA-500USBT

P.A. AMPLIFIER

- Power: 30 Watts Peak, 15 Watts RMS  
Less Than 1% THD @ 1KHz
- Speaker Impedance: 4~16Ω ≤ 3dB
- Frequency Response: 60 ~ 16,000Hz
- THD: 60 ~ 16,000Hz ≤ 1%
- SIN Ratio: >85dB
- Power Supply: AC 110/220V 60/50Hz, DC 12V



### PA-500BT

PUBLIC ADDRESS AMPLIFIER WITH BT

- Power Source: 110V / 60Hz
- Power Consumption: 480 Watts
- RMS Power: 240 Watts
- Max Power: 360 Watts
- Frequency Response: 100 Hz – 16KHz + 3dB
- THD: <0.1% @ 1KHz, 1/3 Rated Output Power
- Output: 8Ω, 70V, 110V
- Aux Input: 600Ω 1V (0dBV)
- Input: Mic: 1, 2, 3: 600Ω, 6mV (-55dBV)  
Aux: 1, 2: 10KΩ, 250mV (-17dBV)
- S/N Ratio: Mic: 1, 2, 3: > 66dB  
Aux: 1, 2: > 70dB
- Tone Control: Bass: ± 10dB @ 100Hz  
Treble: ± 10dB @ 10KHz
- Protection: AC Fuse, DC Voltage, Overload and Short Circuit
- Muting Function: 0~ -30dB
- Includes an MP3 with BT Function, USB and SD Card
- Dimension: 17" x 10" x 3.5" (430 x 260 x 88mm)
- Net Weight: 25.7 lbs (11.68 Kg)



### CA-2070BTUS

P.A. AMPLIFIER

MP3, USB, SD, BT, FM Player Included.

Inputs:

- MP3 Player x 1, USB Port x 1, SD Port x 1
- 3 Microphones: - 54dB 600Ω
- 1 AUX/MP3 IN: -18dB 20k
- Bass: ± 10dB @ 100Hz
- Treble: ± 10dB @ 10KHz
- 1 Master VOL -MIC 1-3 Volume Control  
MP3/AUX Volume Control Master Control

Output:

- Power: 180 Watts Peak, 90 Watts RMS  
Less Than 1% THD @ 1KHz
- Speaker Impedance: 4~8~16Ω 25V 70V 100V
- Frequency Response: 50~15,000Hz≤≤≤3dB
- THD: 50~15,000Hz≤≤≤1%
- SIN Ratio: >75dB
- Power Supply: AC 110V/60Hz, DC 24V



### PA-1000BT

Public Address Amplifier with BT

- Power Source: 110V / 60Hz
- Power Consumption: 960 Watts
- RMS Power: 480 Watts
- Max Power: 720 Watts
- Frequency Response: 100 Hz – 16KHz + 3dB
- THD: <0.1% @ 1KHz, 1/3 Rated Output Power
- Output: 8Ω, 70V, 110V
- Aux Input: 600Ω 1V (0dBV)
- Input: Mic: 1, 2, 3: 600Ω, 6mV (-55dBV)  
Aux: 1, 2: 10KΩ, 250mV (-17dBV)
- S/N Ratio: Mic: 1, 2, 3: > 66dB  
Aux: 1, 2: > 70dB
- Tone Control: Bass: ± 10dB @ 100Hz  
Treble: ± 10dB @ 10KHz
- Protection: AC Fuse, DC Voltage, Overload and Short Circuit
- Muting Function: 0~ -30dB
- Includes an MP3 with BT Function, USB and SD Card
- Dimension: 17" x 15" x 3.5" (430 x 388 x 88mm)
- Net Weight: 37.3 lbs (16.9 Kg)



**PA-6-2600UBT**

6 ZONE PA AMPLIFIER WITH USB AND BT

- With Built-In USB / Bluetooth / Tuner/ TF Card
- With 3 MIC Inputs, 2 AUX Inputs and 1 Line Output
- 100V, 70V and 4-16 Ohms Transformer Isolated Speaker Outputs
- Independent Gain Control for Each Zone
- Separate BASS and TREBLE Control
- Power Requirement: 110-220V AC, 50/60 Hz
- Power and Level Indicators
- Gain Control and Power Switch



Memory Stick



Rated Power Output	260W		
Amplification	Analog 100V Transformer Type		
Output	100V, 70V and 4-16 Ohms		
Frequency Response	60 - 15KHz, +/- 3dB		
THD	Less than 0.5% at 1KHz (1/3 Rated Power)		
S/N Ratio	Better than 85dB		
VOL Range	BASS: 100Hz (± 10dB), TREBLE: 12KHz (±10 dB)		
Controls	Gain controls and power switch		
Cooling	Internal 12VDC fan		
Indicators	Power and Level Indicators		
Power Consumption	180W	340W	485W
Dimensions	89(H) x 483(W) x 386(D) mm		
Built-in Dimensions	2 U rack 19 inch		
Carton Dimensions	185(H) x 520(W) x 435(D) mm		
Net Weight	12 kg	13.5 kg	15 kg
Gross Weight	13.8kg	15.2 kg	17 kg
Finish	Panel: aluminium, black Case: steel plate, black		

This series of commercial grade mixer power amplifier delivers clean and powerful sound with reliable performance. With Built-in 6-zone speaker selector and individual volume controller for each zone.

These highly flexible mixer amplifiers designed for a wide variety of voice and background music applications such as restaurants, bars, stores and any small-medium size installations.

**PA-10ZC**

P.A. EQUIPMENT ZONE CONTROLLER

- Power Source: 110V/60Hz
- 10 Partitions Controller
- Power Off Memory for Each Partition
- Dual Input/Output Available for Each Partition
- High Power Device with 10A Available for Each Partition
- Dimension: 19" x 13.7" x 3.5" (480x350x90mm)
- Net Weight: 14.9 Lbs (6.75 Kg)



**NDVA-1000**

DIGITAL MP3 PLAYER WITH FM RADIO

- Compatible with Format MP3 in Memory Type USB or SD
- USB/SD Memory Card Input
- FM Radio Frequency
- Remote Control

Supports USB, SD, FM & Remote Control



**NDVA-3000**

FM MINI CAR AMPLIFIER

- Output Power Rating: 2x2.5W RMS, 2x15W Peak@1%THD, 8Ω, 110V AC
- Tone Control: Treble: 10KHz @ ±12dB  
Bass: 100Hz @ ± 12dB
- Frequency Response: 20Hz~20KHz @ ±1dB
- SIN Ratio: > 100dB
- DC Power Supply: 12V Battery
- Dimensions: 155 x 135 x 50mm

Supports USB, SD, FM & Remote Control



**ER-471**

MEGAPHONE WITH USB

- 35 Watts Megaphone
- Emergency Siren
- Built-In Recorder
- Megaphone with Emergency Siren
- Records and Continuously Repeats your Voice
- With Removable Microphone
- Volume Control
- 6D Size Batteries
- ABS Material, Highly Resistance
- 110-220V Rechargeable Battery
- Recorder
- Siren



**ER-471-RB**  
REPLACEMENT BATTERY

**ER-771**

MEGAPHONE WITH EMERGENCY SIREN

- 50 Watts Megaphone
- Emergency Siren
- Built-In Recorder
- Megaphone with Emergency Siren
- Records and Continuously Repeat your Voice
- With Removable Microphone
- Volume Control
- 8 D Size Batteries
- ABS Material, Highly Resistant
- 110-220V Rechargeable Battery
- Recorder
- Siren
- 12V Input



**ER-771-RB**  
REPLACEMENT BATTERY

**ER-991**

MEGAPHONE WITH USB

- SD AND MP3 PLAYER
- 50 Watts Megaphone
  - Lithium Battery
  - Megaphone with Emergency Siren
  - High Impact ABS Material
  - Emergency Siren (2 Optional Melody)
  - Recordable Function (Records and Continuously Repeats)
  - External Microphone
  - 8 Type C Batteries (Not Included)
  - 12V Input
  - Original Cable
  - Carrying Strap
  - Reaches a Maximum of 1500 Meters
  - 110-220V Rechargeable Battery



**ER-991-RB**  
REPLACEMENT BATTERY

**SK-33S**

POWER MEGAPHONE

- Output: 30 Watts
- Power Source: Uses 6 x D Batteries
- Horn Diameter: 8" (205mm)
- Material: ABS Plastic



**ER-1091BT**

MEGAPHONE W/ WIRELESS MUSIC STREAM

- Dry Cell or Rechargeable Battery Operation
- All ABS Body, Sturdy Yet Light Weight
- Built-in Siren and Music
- 120 seconds Voice Recording Function
- Support U-disk
- Support Playing MP3, WAV
- Support Wireless Music Stream
- Power Output: 25W Rated / 50W Max
- Voice Range: 0.7-1 km
- Power Source: 8 x "D" Cells
- Battery Life: 8-10 Hrs
- Working Voltage: DC-12V
- Dimensions: Horn Dia.230mm, Length 350mm
- Weight: 1.21kg without Cells



**HS-405115-710V**

- HORN SPEAKER
- 12.4"x8.2"x14.5"
  - With 70V/100V Transformer can be Adjusted to 5W/10W/15W
  - Load Rating: 15W
  - Impedance: 8 Ohms
  - Protection Type: IP 66



**NAH-158 (Ivory Marfil)**

- 15" X 8" TRUMPET HORN
- Rectangle
  - Without Driver



**NAH-16 (16", Ivory Marfil)**

**NAH-20 (20", Ivory Marfil)**

- ROUND TRUMPET HORN IVORY
- Without Driver



**TC-604-25**

- 6X4" HORN SPEAKER
- Dimensions: 6"x4"
  - Max Power: 25W
  - Impedance: 8 Ohms
  - Frequency Range: 250-7000Hz
  - Sensitivity: 105dB



**TC-25**

- 8" 4.5" Horn
- Frequency Range: 250Hz-8KHz
  - RMS/Max Power: 40/80W
  - Impedance: 8 Ohms



**TC-35S**

- 12V DC SIREN HORN
- Power Rating: 35W
  - Current Drain: 1.3A
  - Material: ABS Plastic



**TC-45**

- ABS PLASTIC POWER HORN
- Power Handling: 50W RMS
  - Frequency Response: 200Hz-8KHz
  - Impedance: 8 Ohms



**TC-55**

- POWERHORN
- Frequency Response: 350Hz-9KHz
  - RMS/Max Power: 50/100W
  - Impedance (Nominal): 8 Ohms



**TC-305**

- 12" HORN SPEAKER
- Material: Aluminum
  - Bracket: Steel
  - Power: 40W (RMS)
  - Impedance: 8 Ohms
  - Frequency Response: 300-7000 Hz
  - Dimension: 309(D)x286(L) mm [12"x11"]



**NAH-06D**

- 6" HORN SPEAKER ROUND, WITH DRIVER
- Max Power: 50 Watts
  - Impedance: 8Ω
  - Frequency Range: 400~7000Hz
  - Sensitivity: 110dB



**NAH-08D**

- 8" HORN SPEAKER
- 8" Round, 5.2 Oz. Driver
  - Max Power: 60 Watts
  - Impedance: 8Ω
  - Frequency Range: 400~7000Hz
  - Sensitivity: 110dB



**TC-1108T**

- PA HORN SPEAKER
- Magnet: 3.1" x 1.6" x 0.6" (80 x 40 x 15mm)
  - Horn Material: ABS
  - Throat: Aluminum
  - Bracket: Steel
  - Diaphragm: Phenolic
  - IP Rating: 65
  - Power: 30W RMS, 60W Max
  - Impedance: 8Ω
  - Frequency Range: 300~8000Hz
  - SPL@1W/1M: 110dB
  - Voice Coil: 38 KSV



**TC-1712T**

- PA. HORN SPEAKER
- Magnet: 4.3"x2.4x0.8" (110x60x20mm)
  - Horn Material: ABS
  - Throat: Aluminum
  - Bracket: Steel
  - IP Rating: 65
  - Power: 50W RMS, 100W Max
  - Impedance: 16Ω
  - Frequency Response: 200~10000Hz
  - SPL@1W/M: 112dB
  - Diaphragm: Phenolic
  - Voice Coil: 51.6 KSV



**AV-1006**

- 4" 6 TONE SIREN
- Operation Power: 12V, 35W
  - Sensitivity: 119dB± 3db
  - Impedance: 8 Ohms
  - Maximum Power: 35 Watts



**SI-55S**

- PA SIREN
- Frequency Range: 300-5000Hz
  - Sensitivity: 115-122dB
  - 80 Watts
  - 8 Ohms



**SI-77S**

- ELECTRONIC SIREN
- 100 Watts
  - 8 Ohms
  - 12V DC ± 10%



**RA-PA91BT**

- SINGLE DIN RECEIVER WITH BLUETOOTH WITH PA FUNCTION
- Music Support
  - Display: 1 Line, 17 Segment X 11 Digit
  - MP3 / WMA
  - Charge for both Android & iPhone
  - ID3 Tag
  - Subwoofer Line Out
  - Tuner Support
  - Loudness
  - 18 FM / 12 AM
  - 2 Band EQ with 8 Presets
  - Bluetooth Built-In
  - Protocols: HFP / A2DP
  - Maximum Power: 40 Watts X 4
  - RMS Power: 22 Watts X 4
  - Front USB
  - Remote
  - Detachable Front Panel
  - Supports up to 32GB Thumb Drive
  - 2V Line Out
  - SD / MMC Card Slot Behind the Front Panel
  - RDS / RBDS
  - Front Aux-In Jack
  - PA Function (Maximum Power: 40 Watts X 4)
  - Music to PA Fade In and Out



**CA-50WS**

- SECURITY PA AMPLIFIER
- Power: 100 Watts
  - Frequency Range of Microphone: 420Hz – 1780Hz
  - 12V, 7.5A
  - With Microphone & 6 Sounds



**CA-77WS**

- SECURITY PA AMPLIFIER
- Power: 100 Watts
  - Impedance: 8 Ohms
  - 12V
  - With Microphone & 6 Siren Sounds



**TA-1600**

- CAR PA AMPLIFIER
- Impedance: 4Ω / 8Ω
  - Power Source: Standard Voltage: 14 VDC
  - Operating Range: 10-16 VDC (12V Battery)
  - Current Consumption: Under 9 A (Rated Output)
  - Input: Mic 1: 600Ω, 4 mV (Usable Plug: Ø6.3mm Phone Plug)
  - Mic 2: 600Ω, 4 mV (Usable Plug: Ø6.3mm Phone Plug)
  - Aux: 10kΩ, 500 mV (Usable Plug: Ø3.5mm Phone Plug)
  - USB: 10 kΩ, 500mV
  - Distortion: Under 5% (1 kHz, Rated Output)
  - Frequency Response: 100 Hz-10 kHz within ±3 dB
  - Dimensions(mm): 178(W) x 50(H) x 170(D)
  - Weight: 1.2kg (Amplifier Only)
  - Supplied Microphone: Uni-Directional Dynamic Microphone (with Talk Switch)
  - Impedance: 600Ω
  - Sensitivity: -53dB (1 kHz, 0 dB+ 1V/Pa)



UHF TRANSCEIVER

WLTK-100

UHF TRANSCEIVER

- With High illumination Flashlight
- Scrambler
- Noise Reduction Circuit
- Long Standby Time
- Long Communication Range
- High Capability Li-ion Battery
- Battery Save, CTCSS, DCS
- Frequency Range: 400~470MHz
- RF Rated Power: ≤ 5W
- Channel Capacity: 16
- Operated Voltage: 3.7 V
- Dimensions: 4.5" x 2.4" x 1.3"
- Weight: 150g (0.3 Lbs)

Supplied Accessories



WLTK-052

WALKIE-TALKIE SET

- Up to 3 Km Range
- 38 Selectable Tones for CTCSS Use
- 22 Channels
- Built-In LED Flashlight
- 10 Call Tones
- Backlit Display
- Talk Confirmation Tone
- Monitor
- Auto Squelch
- Keypad Tones
- Keypad Lock
- Battery Save
- Audible Low Battery Alert
- VOX Hands-Free Communication without the need for an Audio Accessory



CS-24-20 WHT

COLUMN SPEAKER

- Input Power: Rated 12W, Max 24W
- Output Power: 3, 6, 12, 24W
- Speaker: 4pcs Wide Band Speaker Measuring 70mm in Diameter (Paper Cone Speaker)
- Input Voltage: 70, 100V
- Impedance: 100V: 3.3K-1.67K-835-420Ω
- Frequency Response: 250-2000Hz (-10dB)
- Sound Pressure Level: 94dB (1W/M)
- Bracket: Steel
- Material: Aluminum
- Dimension: 3.9" x 3" x 16" (100x75x405mm)



24Watts

SPEAKERS

CS-44-40 WHT

COLUMN SPEAKER

- Input Power: Rated 20W, Max 40W
- Output Power: 5, 10, 20, 40W
- Speaker: 7pcs Wide Band Speaker Measuring 70mm in Diameter (Paper Cone Speaker)
- Input Voltage: 70, 100V
- Impedance: 100V: 2K-1K-500-250Ω
- Frequency Response: 250-2000Hz (-10dB)
- Sound Pressure Level: 94dB (1W/M)
- Bracket: Steel
- Material: Aluminum
- Dimension: 3.9" x 3" x 24.4" (100x75x619mm)



40Watts

AVAILABLE ACCESSORIES  
SOLD SEPARATELY



RST-65115-710V

ROCK SPEAKER

- 6.5" 2-Way Speaker
- 6.5" IMPP Cone with Rubber Edge
- 1" ASV Coil
- Magnet: 18 Oz.
- Titanium Tweeter
- Voice Coils: 0.75" KSV
- Magnet: 19 x 2
- Material: Glass Reinforced Plastics
- Output Power: 100W Max, 50W RMS
- Frequency Reponse: 80Hz~20KHz
- Sensitivity: 88dB
- Impedance: 8Ω
- Transformer: 70V: 32-16-8-4-2W / 100V: 32-16-8-4W
- Enclosure Material: LLDPE
- Environment: IP56
- Product Dimensions: 12.6" x 9.1" x 10.6" (320x230x270mm)





**HA-12**  
ECONOMIC TYPE  
• 2-1/8" Wide  
• 1" Deep  
• Economy



**HA-24**  
• Heavy Duty Cabinet Lock  
• 3-1/2" x 3-1/2"

**HA-35**  
DEEP AIR TUBE  
• 2-3/4" Wide  
• 4-3/4" Deep



**HA-5275**  
AIR PORT TUBE WITH GRILL  
• 2.75" Wide  
• 5" Deep



**HA-15A**  
**HA-15B (with Grill)**  
AIR TUBE  
• 2" Wide  
• 2.5" Deep



**HA-15C**  
AIR PORT TUBE  
• 3" Wide  
• 4.5" Deep

**HA-15D**  
AIR PORT TUBE  
• 4" Wide  
• 4.5" Deep

**HA-15E**  
AIR PORT TUBE  
• 6" Wide  
• 6" Deep



**HA-54**  
AIR TUBE  
• 3" Wide  
• 3" Deep  
• Nickel



**HA-5412**  
AIR TUBE  
• 3" Wide  
• 12" Deep  
• Nickel  
• Long So You Can Cut to Size



FANS



**12-0715**  
DC FAN MOTOR  
• 1 1/2" x 1 1/2" x 3/4"  
• 12V



**12-1030**  
DC FAN BRUSHLESS  
• 3" x 3" x 1"  
• 12V



**12-1545**  
LUDGER FAN  
• 4 6/8" x 4 6/8" x 1.5"  
• 12V 0.30A  
• 50/60Hz 0.14A  
• Impedance Protected



**12-2323**  
PLASTIC FAN  
• 2 3/8" x 2 3/8" x 8 7/8"  
• 12V  
• 60mm x 60mm x 225mm



**24-3131**  
LUDGER FAN  
• 7/8" x 3 1/8" x 3 1/8"  
• 24V 0.11A  
• Impedance Protected



**FAN-33**  
EXTREMELY EFFICIENT  
• 2 3/8" x 2 3/8" x 1"  
• 28 Cubic Feet per Minute  
• 12V 0.8A



**FAN-55**  
EXTREMELY EFFICIENT  
• 4 6/8" x 4 6/8" x 1.5"  
• 106 Cubic Feet per Minute  
• 12V 1.0A



**FAN-550HS**  
EXTREMELY EFFICIENT  
• 4 7/8" x 4 7/8" x 1.5"  
• Current: 2A, Power: 24W  
• Speed: 4350RPM  
• 12V  
• Speed Control



**110-1032**  
DC FAN BRUSHLESS  
• 1" x 1" x 3/8"  
• 110V



**110-1545**  
MINI FAN  
• 4 1/2" x 4 1/2" x 1 1/2"  
• 110V



**110-15475**  
MINI FAN  
• 4.72" x 4.72" x 1.49"  
• 110V



GRILLS

**GLKT-6.5**  
SPEAKER GRILL  
• 2 GR-8, 8 NP-1 & 8 NSC-001

**GLKT-8**  
SPEAKER GRILL  
• 2 GR-8, 8 NP-1 & 8 NSC-001

**GLKT-10**  
SPEAKER GRILL  
• 2 GR-10, 8 NP-1 & 8 NSC-001



**GLKT-12**  
SPEAKER GRILL  
• 2 GR-12, 8 NP-1 & 8 NSC-001

**GLKT-15**  
SPEAKER GRILL  
• 2 GR-15, 8 NP-1 & 8 NSC-001



**GP-8** (8")  
**GP-10** (10")  
**GP-12** (12")  
SPEAKER GRILL  
• Plastic Grill  
• Perfect Grill Marine or Humid Enviroments

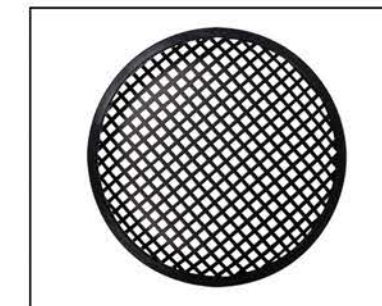

**GR-5** (5")  
**GR-6** (6")  
**GR-6.5** (6.5")  
**GR-8** (8")  
SPEAKER GRILL  
• Clipless  
• For Speakers and Woofers

**GR-10** (10")  
**GR-12** (12")  
**GR-15** (15")  
**GR-18** (18")



**NC-1**  
GRILL CLIPS WITH SCREWS



**GT-4.5** (4.5")  
**GT-6.5** (6.5")  
**GT-8** (8")  
**GT-10** (10")  
**GT-12** (18")  
**GT-15** (15")  
SPEAKER GRILL  
• 2 Piece Metal Grill  
• Perfect for Custom Type Installations

**FGR-3131** (3-1/8" x 3-1/8")  
**FGR-3737** (3.7" x 3.7")  
**FGR-4747** (4.7" x 4.7")  
FAN GRILL  
• Metal



MESH GRILLS/FOAMS

**GR-24 BLK**  
FULL MESH GRILL  
• 2' x 4' x 1.2mm  
• Black Finish

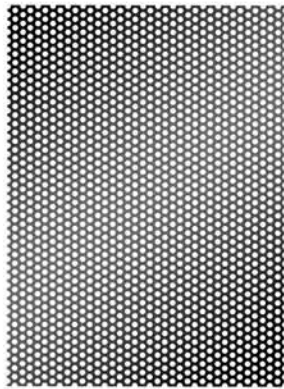

**GR-24NC**  
FULL MESH GRILL  
• 2' x 4' x 1.2mm  
• Nickel Finish

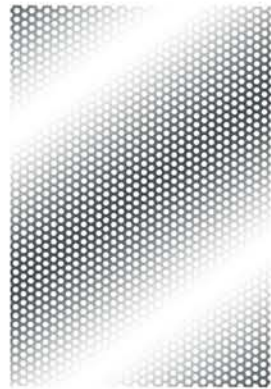

**GR-24HCB**  
FULL MESH GRILL  
• 2' x 4' x 1.2mm  
• Black Finish  
• Honeycomb Mesh

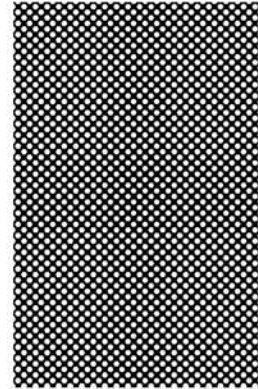

**GR-35 BLK**  
FULL MESH GRILL  
• 3' x 5' x 1.2mm  
• Black Finish

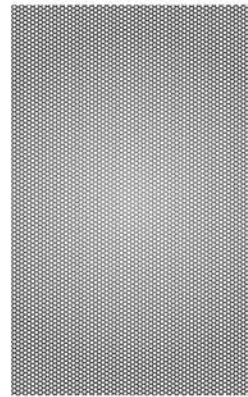

**GR-44 BLK**  
FULL MESH GRILL  
• 4'x4' 1.2mm  
• Black Finish

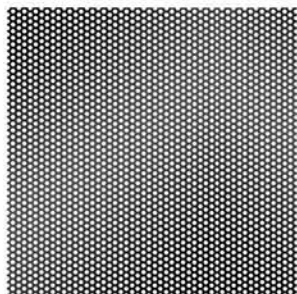

**GR-24FOAM**  
ACOUSTIC GRILL FOAM  
• 2' x 4'  
• Thickness: 0.40"



**GR-2400SP**  
SPEAKER CABINET STEEL MESH GRILL  
• 2' x 4' x 1.2mm  
• Lined with a Black Foam Insulation



**GR-3500SP**  
SPEAKER CABINET STEEL MESH GRILL  
• 3' x 5' x 1.2mm  
• Lined with a Black Foam Insulation



CABINET CORNER PROTECTORS

**HA-30**  
CABINET CORNER PROTECTOR  
• 2"  
• Enclosure  
• Black Finish



**HA-32**  
CABINET CORNER PROTECTOR  
• 3" x 2"  
• Black Finish



**HA-40F**  
METAL CABINET CORNER  
This Cabinet Corner is Made Specifically to Accompany the HA-40



**HA-40 BLK** (1" x 1")  
**HA-45 BLK** (2" x 1.5")  
THREE LEG METAL CABINET CORNER PROTECTOR  
• 2" x 1.5"  
• Black Metal Finish



**HA-47A** (Right)  
**HA-47B** (Left)  
METAL CABINET CORNER  
• Black Finish

Metal High Quality Cabinet Corner Protectors Adds Style and Durability to any Project.



**HA-48 BLK**  
**HA-48 NKL**  
METAL CABINET CORNER  
• 1.5" x 1.5"  
• Black or Nickel Finish



**HA-50**  
CABINET CORNER  
• 3"  
• Enclosure  
• Black Finish



**HA-51**  
CABINET CORNER  
• 2" x 2"  
• Only 2 Screw Holes for Faster & More Economical Installation  
• Black Finish



**HA-53**  
PLASTIC CABINET CORNER  
• 5" x 3"  
• Black Finish



**HA-212 NKL**  
METAL CABINET CORNER  
• Weight: 30g  
• .40mm Thick  
• 90°  
• Nickel Finish



**HA-214 BLK**  
**HA-214 NKL**  
METAL CABINET CORNER  
• Weight: 50g  
• .50mm Thick  
• 90°  
• Black or Nickel Finish



**HA-215 NKL**  
METAL CABINET CORNER  
• Weight: 70g  
• .65mm Thick  
• 90°  
• Nickel Finish



**HA-215-1NL**  
METAL CABINET CORNER  
• Weight: 40g  
• 1.0mm Thick  
• 90°  
• Nickel Finish



CABINET HANDLES

**HA-10**  
POCKET ENCLOSURE  
• 5.5" x 3.5"



**HA-100 BLK** (Black Color)  
**HA-100 NKL** (Nickel Color)  
SPRING SURFACE  
• 5.5" x 3.5"



**HA-1062**  
ABS RECESSED ROUND HANDLE  
• 10" (H) x 6"(W) x 2.5" (D)



**HA-20**  
CARRYING BELT  
• 10" x 1"



**HA-200 BLK** (Black Color)  
**HA-200 NKL** (Nickel Color)  
RECESSED FLIP HANDLE BLACK  
• 6.25" x 4.25"  
• Spring Surfaces



**HA-300**  
METAL CABINET HANDLES  
• 9" x 7"



**HA-350**  
LARGE RECESSED HANDLE  
• 9" x 7"  
• Plastic



**HB-40 BLK**  
PLASTIC HANDLE  
• 5" x 2.5"



**HA-400**  
LARGE RECESSED METAL HANDLE  
• 10.75" x 6.5"



**HA-550**  
METAL HANDLE  
• 6.25" x 6.5 x 5.5"



**HA-762**  
ABS RECESSED ROUND HANDLE  
• 7.5" (H) x 6" (W) x 2.5" (D)



**HA-819-2**  
PLASTIC HANDLE  
• 210mm x 160mm



CABINET LOCKS



**HA-15**  
RUBBER CABINET FOOT



**HA-25**  
LARGE RUBBER  
CABINET FOOT  
• Metal Washer  
• 2.5"



**HB-10 BLK**  
**HB-10 CHR** (CHROMO)  
PADLOCKING DRAWBOLT  
• Draw Bolt



**HB-20BLK**  
LIFT OFF HINGE



**HB-44**  
HEAVY DUTY CABINET LOCK  
• Heavy Duty Cabinet Lock  
• 3-1/2" x 3-1/2"



**HB-55BLK**  
CABINET HEAVY DUTY LOCK  
• Heavy Duty Cabinet Lock  
• 4-1/8" x 4"



**HL-544NKL**  
HEAVY DUTY LOCK  
• 6-3/4" x 5"  
• Black



**HL-544BLK**  
HEAVY DUTY LOCK  
• 6-3/4" x 5"  
• Black

**NP-1**  
GRILL CLIP



**NP-3**  
DJ CABINET CLIP



**SC-03**  
SPEAKER CLAMP



**HR-500**  
SCREW TYPE WHEEL  
• Caster



**HR-600**  
SCREW TYPE LONG WHEEL  
• Screw Type  
• Long Wheel Caster



**HB-33**  
I.S. DJ CABINET HANGING  
SCREW  
SUPPORTS UP TO 140 KGS  
308 LBS (EACH)



**HS-35**  
6.5' DJ CABINET BRACKET



**WVC-HM50-48**

## 2 CHANNEL IN WALL VOLUME CONTROL

- Power Rating: 60 Watts per Channel
- Attenuation: 42dB Maximum per Channel
  - 1st Position (Fully Counterclockwise): Full-Off
  - 2nd Position and 3rd Position: Attenuate  $3 \pm 1$  dB per Step
  - 4th to 9th Position: Attenuate  $3 \pm 1$  dB per Step
  - 10th Position: Full On
- Insulation Resistance: 100M $\Omega$  Minimum @ 500V DC
- Dielectric Withstanding Voltage: 500V AC, 1 Min
- Frequency Response: 20Hz ~ 20KHz
- With 10 Volume Positions
- Weight: 7.8 Oz. (220g)

Rear View**WVC-PA30-710V**

## IN WALL VOLUME CONTROL

- Power Handling: 25W (RMS) per Channel
- Attenuation: 50W Maximum per Channel
  - 1st Position (Fully Cuonterclockwise): Full-Off
  - 2nd Position and 3rd Position: Attenuate  $6 \pm 1$  dB per Step
  - 4th to 9th Position: Attenuate  $3 \pm 1$  dB per Step
  - 10th Position: Full On
- Insulation Resistance: 100M $\Omega$  Minimum @ 500V DC
- Dielectric Withstanding Voltage: 500V AC, 1 Min
- Weight: 7.8 Oz.

Rear View

# AUDIOPIPE PRO DJ

**AOCT-850**

8" LOW MID FREQUENCY SPEAKER

- 500 Watts Power (P.M.P.O.)
- 250 Watts Power (R.M.S.)
- Frequency Response: 70-10000Hz
- Sensitivity: 93dB
- 2" TIL Voice Coil
- Die-Cast Aluminum Basket
- Mounting Depth: 88mm (3 1/2")
- Impedance: 8 Ohms
- 50 Oz Magnet

**8"**



**AOCT-1250**

12" LOW MID FREQUENCY SPEAKER

- 1000 Watts Power (P.M.P.O.)
- 500 Watts Power (R.M.S.)
- Frequency Response: 40 - 4,000 Hz
- Sensitivity: 95dB
- 3" TIL Voice Coil
- Die-Cast Aluminum Basket
- Mounting Depth: 5"
- Impedance: 8 Ohms
- 600 Oz Magnet



**12"**



**1000W  
MAX.**

**AOCT-HF8**

8" LOW MID FREQUENCY SPEAKER

- 700 Watts Power (P.M.P.O.)
- 350 Watts Power (R.M.S.)
- Frequency Response: 70-10,000Hz
- 3" KSV Voice Coil
- Powder Black Paint Aluminum Basket
- Sensitivity: 92dB
- Impedance: 8 Ohms
- Mounting Depth: 90mm (3 9/16)
- 60 Oz Magnet

**8"**



**8Ω**



**700W  
MAX POWER**

**AOCT-1050**

10" LOW MID FREQUENCY SPEAKER

- 800 Watts Power (P.M.P.O.)
- 400 Watts Power (R.M.S.)
- Frequency Response: 50 - 5,000 Hz
- Sensitivity: 95dB
- 2.5" TIL Voice Coil
- Die-Cast Aluminum Basket
- Mounting Depth: 4 - 7/16"
- Impedance: 8 Ohms
- 50 Oz Magnet



**10"**



**800W  
MAX.**

**AOCT-HF8-D4**

8" LOW MID FREQUENCY SPEAKER

- 800 Watts Power (P.M.P.O.)
- 400 Watts Power (R.M.S.)
- Frequency Response: 65 - 8,000Hz
- 3" KSV Voice Coil
- Powder Black Paint Aluminum Basket
- Sensitivity: 92dB
- Impedance: 2 x 4 Ohms
- Mounting Depth: 90mm (3 9/16)
- 60 Oz Magnet

**8"**



**DUAL  
4Ω**



**800W  
MAX POWER**





NWA-830CE

8" PROFESSIONAL PUBLIC ADDRESS WOOFER

- 200 Watts Power (P.M.P.O.)
- 100 Watts Power (R.M.S.)
- Frequency Response: 50-9000Hz
- Sensitivity: 90dB
- 1.5" 2-layer Voice Coil Kapton
- Rigid Steel Basket
- Mounting Depth: 84mm(3.31")
- Impedance: 8 Ohms
- 30 Oz. Maganet



NWA-1063

10" PROFESSIONAL PUBLIC ADDRESS WOOFER

- 800 Watts Power (P.M.P.O.)
- 400 Watts Power (R.M.S.)
- Frequency Response: 35-4000Hz
- Sensitivity: 92dB
- 3" 2-Layer Voice Coil Kapton
- Rigid Steel Basket
- Mounting Depth: 104mm(4.1")
- Impedance: 8 Ohms
- 50 Oz. Maganet



NWA-1563

15" POWER WOOFER

- Power handling: 600W RMS/1200W max
- Frequency response: 30-3500Hz
- Sensitivity: 94dB
- Impedance: 8 ohms
- Magnet: 60 oz.
- 3" 2-layer Kapton voice coil
- Vented magnet structure



NWA-1593

15" POWER WOOFER

- Power handling: 700W RMS/1400W max
- Frequency response: 30-3500Hz
- Sensitivity: 94dB
- Impedance: 8 ohms
- Magnet: 90 oz.
- 3" 2-layer Kapton voice coil
- Vented magnet structure



NWA-1263

12" PROFESSIONAL PUBLIC ADDRESS WOOFER

- Power Handling: 700W RMS/1400W Max
- Frequency Response: 30 - 3500Hz
- Sensitivity: 94dB
- Impedance: 8 Ohms
- Magnet: 90 Oz.
- 3" 2-Layer Kapton Voice Coil
- Vented Magnet Structure



NWA-1283

12" PROFESSIONAL PUBLIC ADDRESS WOOFER

- 1000 Watts Power (P.M.P.O.)
- 500 Watts Power (R.M.S.)
- Frequency Response: 40-5000Hz
- Sensitivity: 94dB
- 3" 2-Layer Voice Coil BASV
- Rigid Steel Basket
- Mounting Depth: 131mm (5.16")
- Impedance: 8 Ohms
- 75 Oz. Magnet



APLB-10

10" DYNAMIC LOUDSPEAKER

- 600 Watts Power (PMPO)
- 300 Watts Power (RMS)
- Frequency Response: 40 - 4,000Hz
- Sensitivity: 96 dB
- 3" Til Voice Coil
- Rigid Steel Basket
- Mounting Depth: 111 mm (4.37")
- Impedance: 8 W
- 80 Oz. Magnet



APLB-12

12" DYNAMIC LOUDSPEAKER

- 600 Watts Power (PMPO)
- 300 Watts Power (RMS)
- Frequency Response: 40 - 4,000Hz
- Sensitivity: 96 dB
- 3" Til Voice Coil
- Rigid Steel Basket
- Mounting Depth: 111 mm (4.37")
- Impedance: 8 W
- 80 Oz. Magnet



**NWA-15204**

15" POWER WOOFER

- Power handling: 700W RMS/1400W max
- Frequency response: 35-4500Hz
- Sensitivity: 95dB
- Impedance: 8 ohms
- Magnet: 200 oz.
- 4" 2-layer Kapton voice coil
- Vented magnet structure

**4" voice Coil**



**NWA-15204D**

15" POWER WOOFER

- Power handling: 700W RMS/ 1400W max
- Frequency response: 28-2500Hz
- Sensitivity: 98.3dB
- Impedance: 8 ohms
- Magnet: 100 oz.
- 3" 2-layer Kapton voice coil
- Rigid steel basket
- Die cast

**3" voice Coil**

**NWA-18204D**

18" PRECISION PROFESSIONAL WOOFER

- 4" 2-Layer Voice Coil BASV
- Die-cast Aluminum Basket
- Vented Magnet Structure
- 200 Oz. Magnet
- Sensitivity: 95 dB
- 1800 Watts Programmed Power
- Frequency Response: 28 - 3200Hz
- Mounting Depth: 195mm (7.68")
- Impedance: 8Ω

Now with  
**4 INCH VOICE COIL**

Now with  
**Increase POWER HANDLING**



**NWA-15104**

15" POWER WOOFER

- Power handling: 600W RMS/1200W max
- Frequency response: 35-4000Hz
- Sensitivity: 93dB
- Impedance: 8 ohms
- Magnet: 100 oz.
- 4" 2-layer Voice coil BASV
- Vented magnet structure

**4" voice Coil**

**NWA-SP151800**

REPLACEMENT SPIDER FOR:  
• NWA-15104



**NWA-18204**

18" POWER WOOFER

- Power handling: 800W RMS/1600W max
- Frequency response: 28-3200Hz
- Sensitivity: 95dB
- Impedance: 8 ohms
- Magnet: 200 oz.
- 4" 2-layer Kapton voice coil
- Vented magnet structure

**4" voice Coil**

**NWA-2100-ND**

21" PRECISION PROFESSIONAL WOOFER

- 2400 Watts Power (P.M.P.O.)
- 1200 Watts Power (R.M.S.)
- Frequency Response: 30 - 2,000Hz
- Sensitivity: 95dB
- 6" 2-Layer Voice Coil BASV
- Die-cast Aluminum Basket
- Mounting Depth: 222mm (8.74")
- Impedance: 1 Ohm
- 145x8mm Neodymium Magnet Structure

**21"**

**NEODYMIUM magnet Speaker Series**



Now with  
**6 INCH VOICE COIL**

Now with  
**Increase POWER HANDLING**

**ODP-653 WHT**  
2-WAY WEATHER-PROOF PROFESSIONAL MONITOR SPEAKER

- 6.5" 2-Way
- 6.5" Monitor Speaker
- Max Power: 100 Watts
- Sensitivity: 90 dB
- Impedance: 8 Ohms
- Frequency Response: 55-20KHz
- 3 Year UV Resistant Housing
- Anti-corrosive, Water Resistant Aluminum Grill
- LED Flashes to the music
- Gross Weight: 7.05 lbs.
- Dimension: 8.3" x 7.3" x 12.2"



**ODP-653 BLK**  
2-WAY WEATHER-PROOF PROFESSIONAL MONITOR SPEAKER

- 6.5" 2-Way
- 6.5" Monitor Speaker
- Max Power: 100 Watts
- Sensitivity: 90 dB
- Impedance: 8 Ohms
- Frequency Response: 55-20KHz
- 3 Year UV Resistant Housing
- Anti-corrosive, Water Resistant Aluminum Grill
- LED Flashes to the music
- Gross Weight: 7.05 lbs.
- Dimension: 8.3" x 7.3" x 12.2"



**ODP-650DBT**

- 6.5" MONITOR SPEAKER
- Maximum Power: 100Watts
  - Sensitivity: 90dB
  - Impedance: 4 Ohms
  - Frequency Response: 55-20KHz
  - 3 Year UV Resistant Housing
  - Anti-corrosive Aluminum Grill, Water-Resistant
  - Gross Weight: 7.9 KG/PAIR
  - Dimension: 8.1" x 8.5" x 13.4" (205x215x340mm)
  - Audio Power: AC 100-240V



*Amplified*



**OUTDOOR**



**Bluetooth**

**APH-5525B0-H**  
5" HIGH FREQUENCY ALUMINUM DIE CASTING HORN

- High frequency Horn
- Aluminum Exponential Horn
- Bolt-on Fitting
- Exit Throat size: 2"
- Overall Dimensions: 5"(H) x 5"(W) x 3"(D)
- Mounting depth: 2.5"



**APH-6250B0-H**  
6" HIGH FREQUENCY ALUMINUM HORN

- High Frequency Horn
- Aluminum Exponential Horn
- Bolt-on Fitting
- Exit Throat Size: 2"
- Overall Dimensions: 6.2"(H) x 6.2"(W) x 5.1"(D)
- Mounting depth: 4.9"



**APH-6556**  
HIGH FREQUENCY HORN

- High Frequency Horn Plastic Horn
- Throat Size: 1.375"
- Overall Dimensions: 5.6" (H) x 5.6" (W) x 7.2" (D)
- Mounting Depth: 6.5"

**Metal Socket for Solid Fitting**



**APH-7750B0-H**  
8" HIGH FREQUENCY ALUMINUM HORN

- High Frequency Horn
- Aluminum Exponential Horn
- Bolt-on Fitting
- Exit Throat Size: 2"
- Overall Dimensions: 7.7"(H) x 7.7"(W) x 4.9"(D)
- Mounting depth: 4.6"



**APH-10610B0-H**  
HIGH FREQUENCY HORN

- High Frequency Horn
- ABS Horn
- Bolt-on Fitting
- Exit Throat Size: 2"
- Overall Dimensions: 10.4"(H) x 6"(W) x 10.7"(D)
- Mounting depth: 10"



**10" X 6"**

**APA-3500BT**

- AUDIO / VIDEO AMPLIFIER RECEIVER
- Aluminum Front Panel, Audio/Video Amplifier
  - with AM/FM Radio, Auto Search and Preset 100 Channels
  - Wireless Bluetooth Function
  - HDMI 2 Input / 1 Output
  - USB/SD, Digital VFD Display
  - Memory Function
  - MIC 1 / MIC 2 Input
  - Dual Voltage: 115V / 240V



**Bluetooth**



- DVD INPUT
- HDMI 2 IN / 1 OUT
- USB/SD Playback
- Memory Function
- MIC 1 MIC 2
- AM/FM Radio
- Bass/Treble
- AUX INPUT

**ODP-423BK**

INDOOR/OUTDOOR WEATHERPROOF LOUDSPEAKER

- 4" 2-Way
- 4" Monitor Speaker
- Maximum Power: 60 Watts
- Sensitivity: 92dB
- Impedance: 8 Ohms
- Frequency Response: 70-20 KHz
- 3 Year UV Resistant Housing
- Anti-Corrosive Aluminum Grill, Water-Resistant
- LED Flashes to the Music
- Available in Black or White
- Gross Weight: 3.8 KG/Pair
- Dimension: 6.7" x 6" x 8.7"



**ODP-423WH**

INDOOR/OUTDOOR WEATHERPROOF LOUDSPEAKER

- 4" 2-Way
- 4" Monitor Speaker
- Maximum Power: 60 Watts
- Sensitivity: 92dB
- Impedance: 8 Ohms
- Frequency Response: 70-20 KHz
- 3 Year UV Resistant Housing
- Anti-Corrosive Aluminum Grill, Water-Resistant
- LED Flashes to the Music
- Available in Black or White
- Gross Weight: 3.8 KG/Pair
- Dimension: 6.7" x 6" x 8.7"



**SB-W350**

LOW FREQUENCY POWERED SUBWOOFER FOR HOME THEATER

- High-Quality MDF Construction
- Single 10" Long Throw Woofer
- Paper Cone with Oversized Foam Surround
- 2" 4-Layer Single Voice Coil BASV
- 40 Oz. Strontium Magnet
- 4 Ohms Mono
- Frequency Response: 35-250Hz
- Dimensions: 14.2"x16.7"x15"



**AMPLIFIER:**

- High Cut Filter: Adjustable from 250Hz down to 50Hz
- Includes Volume/Gain Control Knob, and 0 to 180 Degree Variable Phase Control Knob
- Input: Signal Level RCA and Speaker Level
- Output: Speaker Level
- Power Source: 110V/220V



**CRX-1002K**

- Maximum Power: 400W
- Impedance: 8 Ohms
- Crossover Frequency: 2,000 Hz
- Slope Ratio: 12dB

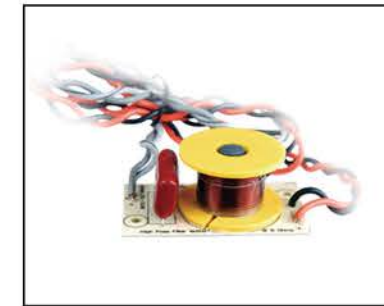

**CRX-1004K**

- Maximum Power: 400W
- Impedance: 8 Ohms
- Crossover Frequency: 4,000 Hz
- Slope Ratio: 12dB



**CRX-1600**

- Maximum Power: 1000W
- Impedance: 8 Ohms
- Crossover Frequency: 600 Hz
- Slope Ratio: 12dB

**CRX-22K**

- Maximum Power: 600W
- Impedance: 4 or 8 Ohms
- Crossover Frequency: 2,000 Hz
- 2-Way



**CRX-23K**

- Maximum Power: 600W
- Impedance: 4 or 8 Ohms
- Crossover Frequency: 3,000 Hz
- 2-Way



**CRX-3003K**

- Maximum Power: 600W
- Impedance: 4 or 8 Ohms
- Crossover Frequency: 375 Hz/ 3,000 Hz
- 3-Way



**CRX-3005K**

- Maximum Power: 600W
- Impedance: 4 or 8 Ohms
- Crossover Frequency: 625 Hz/ 5,000 Hz
- 3-Way



**CRX-2003KHP**

- Maximum Power: 800W
- Impedance: 4 or 8 Ohms
- Crossover Frequency: 3,000 Hz
- 2-Way

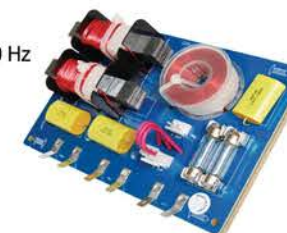

**CRX-3005KHP**

- Maximum Power: 1000W
- Impedance: 4 or 8 Ohms
- Crossover Frequency: 625 Hz - 5,000 Hz
- 3-Way



**CRX-125HP**

- Maximum Power: 1000 Watts
- Impedance: 4 or 8 Ohms
- Crossover Frequency: 125 Hz
- Bass Crossover



**CRX-2012K**

- Maximum Power: 650 Watts
- Impedance: 8 Ohms
- Crossover Frequency: 1.2KHz
- Crossover Frequency: 650Hz
- 2-Way



**CRX-2123KSHP**

- Maximum Power: 1200 Watts
- Impedance: 4 or 8 Ohms
- Crossover Frequency: 3KHz
- 2-Way

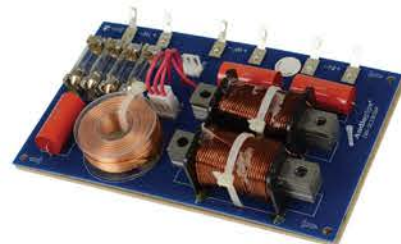

**CRX-D2005KHP**

- Maximum Power: 1000 Watts
- Impedance: 8 Ohms
- Crossover Frequency: 5000Hz
- 2-Way

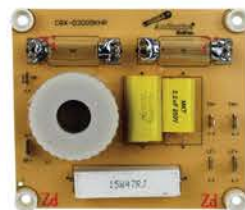

**CRX-XT2003K**

- Maximum Power: 800 Watts
- Impedance: 8 Ohms
- Crossover Frequency: 3000Hz
- Input Connections: Speakon
- 2-Way



**CRX-203**

- 300 Watts
- 2-Way Passive Crossover Network



**CRX-303**

- 300 Watts
- 3-Way Passive Crossover Network



**CRX-FUSE**

- Fuse Lamps
- Output: 12V
- Power 25 Watts
- Dimension: Ø10 x 38mm
- Replaces Fuses for the Following Models:  
CRX-2003KHP & CRX-3005KHP



**CRX-FUSE-44**

- Fuse Lamps
- Output: 12V
- Power 25 Watts
- Dimension: Ø10 x 44mm



**XTR-2214GR**

- 3 WAY CROSSOVER PANEL
- 500 Watts

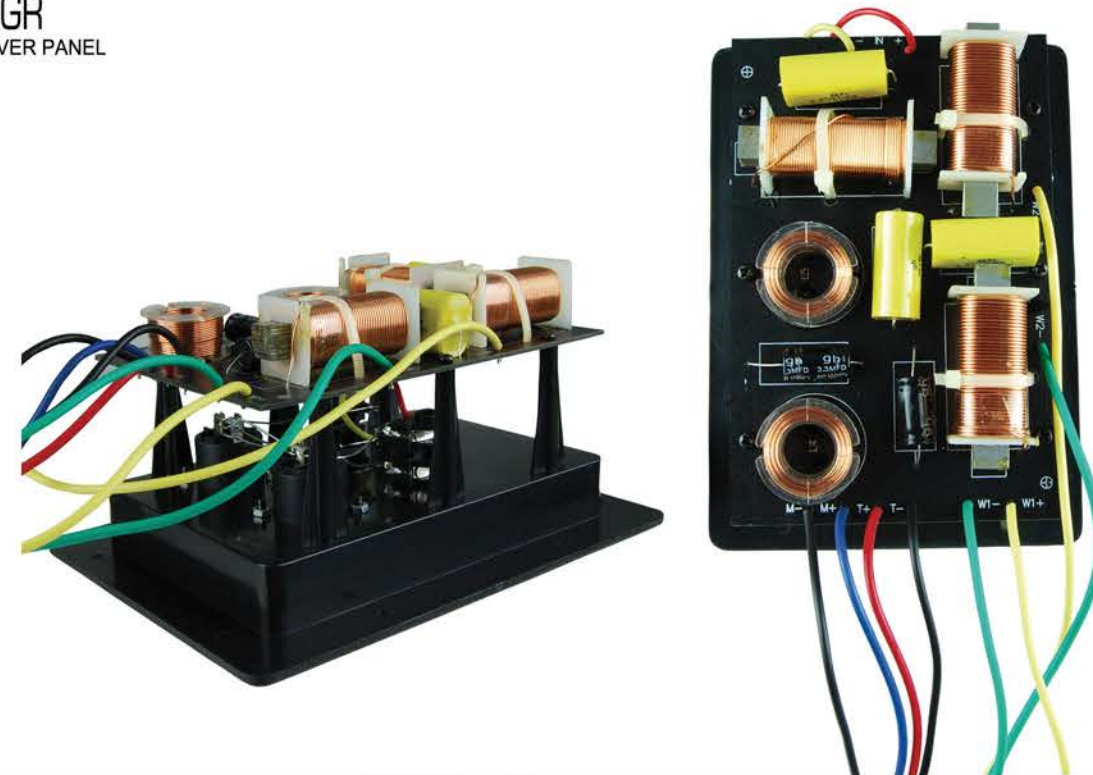

**XTR-D2005KHP**

- CROSSOVER KIT
- Max Power: 1000 Watts
- Impedance: 8 Ohms
- Crossover Frequency: 5000 Hz
- Input Connections: Speakon
- Plastic Terminal Box
- Compatible with Most OEM Crossover
- Mounting Diameter: 4 3/8" x 5"

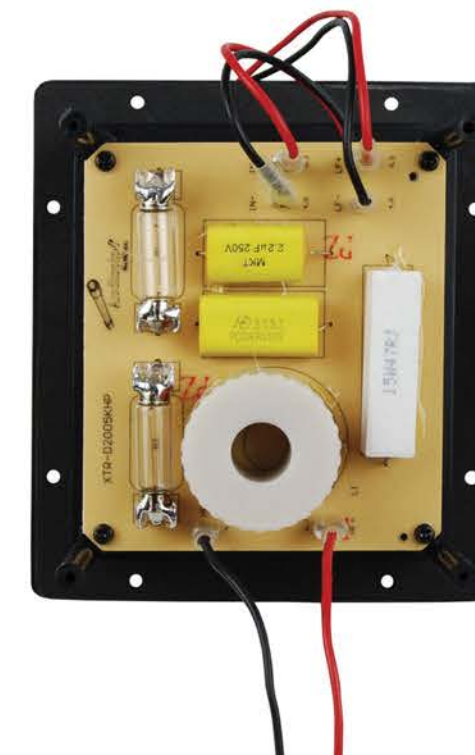



**APH-4545-CD**

- 70 Watts Power (P.M.P.O.)
- 3.5" Titanium Driver
- Frequency Range: 1K-20KHz
- Sound Pressure: 110dB±2dB
- Voice Coil: 1.3" KSV
- Impedance: 8 Ohms
- Magnet: 12 Oz.



**APCD-44FR**

- 80 Watts Power (P.M.P.O.)
- 1,500 - 20,000Hz
- 104dB
- Titanium Diaphragm
- 1.75" Kapton
- 113mm x 15mm Ferrite Magnet
- Magnet: 20 Oz.



**APCD-50FR**

- 100 Watts Power (P.M.P.O.)
- 1,000 - 20,000Hz
- 105dB
- Titanium Diaphragm
- 2" Kapton
- 134mm x 17mm Ferrite Magnet
- Magnet: 34.4 Oz.



**APCD-78FR**

- 400 Watts Power (P.M.P.O.)
- 1,000 - 20,000Hz
- 107dB
- Titanium Diaphragm
- 3" Kapton
- 156mm x 20mm Ferrite Magnet
- Magnet: 50 Oz.



**ADR-250**

- 150 Watts Power (P.M.P.O.)
- 75 Watts Power (R.M.S.)
- Frequency Response: 400-8000 Hz
- Sensitivity: 107dB
- Resin Film Diaphragm
- 2" Kapton Voice Coil with Round Aluminum Wire
- 105mm X 12mm Ferrite Magnet
- SOLD Individually



**ADR-250-VC**

- Replacement Kapton Voice Coil



**APFD-360T**

- 220 Watts Power (P.M.P.O.)
- 110 Watts Power (R.M.S.)
- Frequency Response: 500-18000 Hz
- Sensitivity: 108dB
- Titanium Diaphragm
- 3" Kapton Voice Coil with Flat Wire
- 170mm X 20mm Ferrite Magnet
- SOLD Individually



**APFD-360T-VC**

- Replacement Kapton Voice Coil



**APFD-320T-ND**

- 220 Watts Power (P.M.P.O.)
- 110 Watts Power (R.M.S.)
- Frequency Response: 500-18000 Hz
- Sensitivity: 108dB
- Titanium Diaphragm
- 3" Kapton Voice Coil with Flat Wire
- Neodymium Magnet
- SOLD Individually



**APFD-320T-ND-VC**

- Replacement Kapton Voice Coil



**APCD-4085**

- 1800 Watts Power (P.M.P.O.)
- 900 Watts Power (R.M.S.)
- Frequency Response: 300-7000 Hz
- Sensitivity: 110dB
- Resin Film Diaphragm
- 4" Kapton Voice Coil with Round Aluminum Wire
- 200mm X 20mm Ferrite Magnet
- SOLD Individually



**APCD-4085-VC**

- Replacement Kapton Voice Coil

**APH-4545-H**  
HIGH FREQUENCY HORN  
• Plastic Horn  
• Throat Size: 1.375"  
• Overall Dimensions:  
2.3"(H) x 4.5"(W) x 5"(D)



Metal Socket for Solid Fitting



SHALLOW MOUNT  
3 1/2"



Sold Individually

**APH-4040**

4.5" TITANIUM DRIVER  
• Size:  $\Phi 116 \times H57.5\text{mm}$   
• Max Power: 120 Watts  
• R.M.S. Power: 60 Watts  
• Impedance:  $8\Omega \pm 15\%$  (at 100Hz)  
• Sound Pressure Level:  $103\text{dB} \pm 2\text{dB}$  (at 1M 1W)  
• Frequency Response: 1000-20KHz  
• Total Weight: 1.74Kg  
• Voice Coil: 1.75" KYV, DCR  $6.4\Omega \pm 5\%$   
• Magnet:  $\Phi 116 \times \Phi 45 \times \Phi 15\text{mm}$  (Y30)  
• Plate & T yoke: 717mm

Sold Individually



**APFD-323PH-ND**

RESIN FILM COMPRESSION DRIVER  
• 220 Watts Power (P.M.P.O.)  
• 110 Watts Power (R.M.S.)  
• Frequency Response: 500 - 18,00Hz  
• Sensitivity: 108 dB  
• Resin Film Diaphragm  
• 3" Kapton Voice Coil with Flat Wire  
• Neodymium Magnet

220W  
MAX.



BOLT ON

NEODYMIUM  
magnet  
Speaker Series

2"  
EXIT DRIVER

**APFD-323PH-ND-VC**

REPLACEMENT KAPTON VOICE COIL  
• Resin diaphragm  
• 3" Kapton Voice coil with flat aluminum wire  
• One diaphragm



NOW WITH RESIN FILM  
DIAPHRAGM FOR IMPROVED  
HIGH FREQUENCIES

**APH-5050**

TITANIUM COMPRESSION DRIVER  
• 160 Watts Power (P.M.P.O.)  
• 80 Watts Power (R.M.S.)  
• Frequency Response: 1800-20KHz  
• Sensitivity: 108dB  
• Impedance: 8 Ohms  
• Titanium Diaphragm  
• 2" Kapton Voice Coil  
• 134mm x 17mm Ferrite Magnet  
• 35 Oz. Magnet



BOLT ON

160W  
MAX.

**APCD-940FR**

TITANIUM COMPRESSION DRIVER  
• 180 Watts Power (P.M.P.O.)  
• 90 Watts Power (R.M.S.)  
• Frequency Response: 650-23000Hz  
• Sensitivity: 115 dB  
• Titanium Diaphragm 3" Kapton Voice  
Coil with Flat Wire  
• 145mm x 20mm Strontium Magnet  
• 2" Throat



Sold Individually

SIDE

FRONT

REAR

**APH-5050-VC**

REPLACEMENT KAPTON VOICE COIL  
• 2" Titanium Super Diaphragm  
• 2" High Temperature Kapton Voice Coil  
• One Diaphragm



APH-9460

HIGH FREQUENCY ABS HORN

- Plastic Horn
- Throat size: 1.375"
- Overall Dimensions: 2.3"(H) x 4.5"(W) x 5"(D)



METAL SOCKET FOR SOLID FITTING



APHL-8634

1.4" LINE ARRAY SYSTEM HORN

- Material: Plastic Covered Steel
- Throat Diameter: 35.5mm (1.4")
- Mounting Diameter: 101mm & 75mm (4"&3")



APHC-6256

PRO COMPRESSOR DRIVER KIT

- 400 Watts Power (P.M.P.O)
- 200 Watts Power (R.M.S)
- Frequency Response: 1,000 - 20K HZ
- Sensitivity: 110dB ± 2dB
- Impedance: 8 OHMS
- Titanium Diaphragm
- 2" Kapton Voice Coil
- 134mm X 17mm Ferrite Magnet
- 33 Oz. Magnet
- High Frequency Aluminum Horn
- Exit Throat Size: 2"
- Overall Dimensions: 6.2"H x 6.2"W x 5.6"D
- Mounting Depth: 2-7/8"

6.2"



400 WATTS

APHC-4550

3.5" COMPRESSION DRIVER WITH ABS HORN COMBO

- 70 Watts Power (P.M.P.O)
- 35 Watts Power (R.M.S)
- Frequency Response: 1K-20KHZ
- Sensitivity: 110dB ± 2Db
- Impedance: 8 Ohms
- Titanium Diaphragm
- 1.3" Kapton Voice Coil
- 90mm X 15mm Ferrite Magnet
- 12 Oz. Magnet
- High Frequency ABS Horn
- Throat Size: 1.375"
- Overall Dimensions: 4.5" X 4.5" X 5.1"
- Mounting Depth: 72mm (2-7/8")



METAL SOCKET FOR SOLID FITTING



APHC-6278

PRO COMPRESSOR DRIVER KIT

- 400 Watts Power (P.M.P.O)
- 200 Watts Power (R.M.S)
- Frequency Response: 1K - 20K HZ
- Sensitivity: 110dB
- Impedance: 8 Ohms
- Titanium Diaphragm
- 2" Kapton Voice Coil
- 134mm X 17mm Ferrite Magnet
- 33 Oz. Magnet
- High Frequency Aluminum Horn
- Exit Throat Size: 2"
- Overall Dimensions: 6.2" H X 6.2" W X 7.8" D
- Mounting Depth: 7.3"



400 WATTS

APHC-4550-VC

REPLACEMENT KAPTON VOICE COIL

- 2" Titanium Super Diaphragm
- 1.3" High Temperature Kapton Voice Coil
- Sold Individually



APHC-6256/6278-VC

REPLACEMENT KAPTON VOICE COIL

- Titanium Diaphragm
- 2" Kapton Voice with Flat Aluminum Wire
- Sold Individually



MADE FOR MODELS:  
APHC-6256 & APHC-6278

MADE FOR MODELS:  
APHC-4550



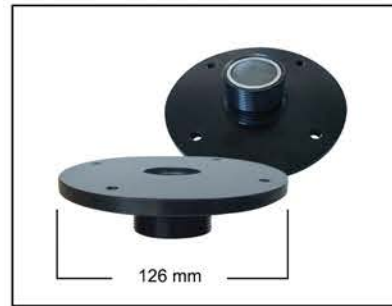

**APCDAD-2550**

- Horn Adapter
- Outer Diameter: Ø 126mm
- Height: 20mm
- Thread: 1 3/8"



**APCDAD-775**

- Horn Adapter
- Outer Diameter: Ø 150mm
- Height: 20mm
- Thread: 1 3/8"



**APCDAD-44FR**

- Replacement Voice Coil for APCD-44FR



**NSDV-4000USA**

- TITANIUM DIAPHRAGM
- Impedance: 8 Ohms
  - 500W MAX



**APCDAD-50FR**

- Replacement Voice Coil for APCD-50FR



**APCDAD-78FR**

- Replacement Voice Coil for APCD-78FR



**APCDAD-900RC**

- 3" Voice Coil Kits
- Replacement for: APCD-940FR / APCD-924ND / APCD-976FR



**ATV-4545**

- 2" Titanium Super Diaphragm
- 1.3" High Temperature Kapton Voice Coil
- One Diaphragm
- Replacement for: APH-4545-CD

**AQP-6100DU**

6 CHANNEL MIXING CONSOLE WITH TWO STEREO CHANNELS AND A SEPARATE STEREO TAPE CHANNEL

- Separate Input Jack Controls for Mix and Line Input on all Mono Channels
- Low-Noise, Discrete Mic Preamplifiers on all Microphone Inputs
- Dedicated Inserts on all Mono Channels
- Balanced 1/4" Stereo Jacks and Balance Controls on all Stereo Channels
- Separate Stereo Tape Channel with 1/4" and RCA Jacks
- Stereo Output for Recording Applications
- Active 3-Band EQ on all Mono Channels
- 2-Band EQ on Stereo Channels
- AUX and Effects Paths as well as Separate Gain Controls on all Channels
- AUX Send Controls in the Main Section for Optimal Level Adjustment
- Headphone Output with Dedicated Volume Control
- Built-In +48V Phantom Power for Condenser Mics
- MP3 Input and Playback
- 99 DSP Digital Multi-Effects (Optional 16 DSP Effects)
- Weight: 6.6 lbs. (3 Kg)



**AQP-8100DU**

8 CHANNEL MIXING CONSOLE WITH TWO STEREO CHANNELS AND A SEPARATE STEREO TAPE CHANNEL

- Separate Input Jack Controls for Mix and Line Input on all Mono Channels
- Low-Noise, Discrete Mic Preamplifiers on all Microphone Inputs
- Dedicated Inserts on all Mono Channels
- Balanced 1/4" Stereo Jacks and Balance Controls on all Stereo Channel
- Separate Stereo Tape Channel with 1/4" and RCA Jacks
- Stereo Output for Recording Applications
- Active 3-Band EQ on all Mono Channels
- 2-Band EQ on Stereo Channels
- AUX and Effects Paths as well as Separate Gain Controls on all Channels
- AUX Send Controls in the Main Section for Optimal Level Adjustment
- Headphone Output with Dedicated Volume Control
- Built-In +48V Phantom Power for Condenser Mics
- MP3 Input and Playback
- 99 DSP Digital Multi-Effects (Optional 16 DSP Effects)
- Weight: 7.7 lbs. (3.5 Kg)



**AQP-AD6181-110**

POWER SUPPLY

- 110V/60Hz, 600mA, 20W
- Indoor Use Only
- Work to: AQP-6100DU, AQP-8100DU



**AQP-AD6181-220**

POWER SUPPLY

- 220V/50Hz, 600mA, 20W
- Indoor Use Only
- Work to: AQP-6100DU, AQP-8100DU



**AQM-1200XLR**

2 CHANNEL GUITAR - SINGER - MIXING CONSOLE

- Sensitivity / Impedance  
CH1, CH2 XLR: 2mV/1.8KΩ (Gain Max)  
CH1 Jack: 10mV/12KΩ (LINE)  
Line, Channel 2: 30mV/20KΩ (LINE); 30mV/240KΩ(GUITAR)  
Output Level: 5.8V Max (MAIN; MONITOR)
- Frequency Range: 20Hz-22KHz
- THD: ≤0.05%
- S/N Ratio: 80dB (A Weighted)
- Equalizer: Bass Range: ±15dB/80Hz; High Range: ±15dB/12KHz
- Headphone Impedance: ≥16Ω
- USB Interface: USB1.1 Compatible, 16-Bit Delta-Sigma, 44.1KHz Sampling Rates; 48KHz Max
- Phantom Power: +48V
- Power Supply: Via USB Port (5V/500mA) of the Computer or Via Power Supply Unit Provided and Connected to AC 100-240V 50/60Hz
- Dimensions: 100x45x135mm
- Weight: 430g
- Suitable Operating System for Data Transfer Via USB Interface: Windows 2000, XP or Higher; Mac OS 9.0.4 or Higher, 10.X or Higher



**AQM-1300U**

3 CHANNEL MIC-LINE MIXER-USB AUDIO INTERFACE

- Sensitivity/ Impedance:  
Mic: 1mV/1.7KΩ (Gain max)  
Line, channel 1: 3mV/12KΩ (Gain max)  
Line, channel 2/3: 150 mV/22KΩ  
Tape in: 300mV/22KΩ
- Output level: 5.8V max (MAIN; MONITOR)
- Frequency range: 20 - 25000 Hz
- THD: ≤0.05%
- S/N ratio: 81 dB (A weighted)
- Headphone impedance: ≥16Ω
- Equalizer: Bass range: ±15dB/80Hz; High range: ±15dB/12kHz
- USB interface: USB1.1 compatible, 16-Bit Delta-Sigma, 44.1 kHz Sampling rates; 48kHz max.
- Phantom power for XLR jack: +18V
- Power supply: via USB port (5V/500mA) of the computer or via power supply unit provided and connected to AC100-240V 50/60Hz
- Dimensions: 101 x 40 x 135 mm (4.0" x 1.6" x 5.3")
- Weight: 430 g (0.95 Lbs)
- Suitable operating system for data transfer via USB interface: Windows 2000, XP or higher; Mac OS 9.0.4 or higher, 10.X or higher.

**3**  
CHANNEL



AC 110-240V



XLR Input



USB 5V DC

**DJAP-1034A**

10" PROFESSIONAL ACTIVE LOUDSPEAKER

- 300 Watts
- Wireless Music Stream
- 2-Way Configuration with Active Filter, Amplifier
- Wireless Remote Control
- 2.5" Titanium Driver
- 10" Woofer with 1.5" ASV Voice Coil
- Class A/B Amplifier, USB Host/SD MP3
- Impedance: 4 Ohms
- Frequency Range: 50Hz-20KHz
- 2-Way Mic Input (XLR/1/4" Jack), Line Input (RCA), Line Output RCA
- Maximum Power: 300W
- Power Source: 115V/230V
- Magnet: 33 Oz.
- Dimensions: 320x250x500mm 12.6" x 10" x 20"
- Weight: 8Kg (17.6 lbs)



**AQM-1300BT**

3 CHANNEL MIC-LINE MIXER-USB AUDIO INTERFACE

- Sensitivity / Impedance  
Mic: 1mV/1.7KΩ (Gain Max)  
Line, Channel 1: 3mV/12KΩ (Gain Max)  
Line, Channel 2/3: 200mV/22KΩ  
Tape in: 300mV/22KΩ
- Output Level: 5.8V Max (MAIN; MONITOR; TAPE)
- Frequency Range: 20Hz-2500Hz
- THD: ≤0.05%
- S/N Ratio: 81dB (A Weighted)
- Equalizer: Bass Range: ±15dB/80Hz; High Range: ±15dB/12KHz
- Headphone Impedance: ≥16Ω
- USB Interface: USB1.1 Compatible, USB 2.0 Full Speed 16-Bit Delta-Sigma, 44.1kHz Sampling Rates; 48kHz Max
- Bluetooth: Compliant with Bluetooth Specification V3.0 + EDR
- Phantom Power for XLR Jack: +18V
- Suitable Operating System for Data Transfer Via USB Interface: Windows 2000, XP or Higher; Mac OS 9.0.4 or Higher, 10.X or Higher
- Power Supply: Via USB Port (5V/500mA) of the Computer or Via Power Supply Unit Provided and Connected to AC 100-240V 50/60Hz
- Dimensions: 100x45x135mm
- Weight: 430g



**VDJ-A800**

MINI DJ MIXER

- Includes Everything you Need to DJ with your Computer
- Compatible with Mac or PC to DJ Parties, Events and even Clubs
- Large, Touch-Sensitive Jog Wheels Provide a Natural Scratching Feel, Cueing, etc.
- Use your Digital Music Library with Support for M4A, AIFF, WAV, MP3, FLAC and OGG Audio Files.
- Cross-Fader.
- Two-Deck Controller with Bass and Treble Volume and Jog Wheel for each Deck, Master Volume
- Pitch Control and Button (-%, +%), Scratch Button
- SYNC, CUE, PLAY, STUTTER Button
- Easy-to-Use, Virtual DJ LE® DJ Software Included.
- Plug-and-Play USB Connection Requires no Drivers or Power Adapter
- Power: Via USB-of the Connected Computer: 5V DC, 500mA
- Weight: 2.4Lbs (1,1Kg)
- Dimensions: 13.8" x 7.1" x 1.4" (350 x 180 x 35mm)



Virtual DJ Program included



**DJAP-1254A**

12" PROFESSIONAL ACTIVE LOUDSPEAKER

- Wireless Music Stream
- 2-Way Configuration with Active Filter, Amplifier
- Wireless Remote Control
- 2.5" Titanium Driver
- 12" Woofer with 2" ASV Voice Coil
- Class A/B Amplifier, USB Host/SD MP3
- Impedance: 4 Ohms
- Frequency Range: 45Hz - 20kHz
- 2-Way Mic Input (XLR / 1/4" Jack), Line Input (RCA), Line Output RCA
- Maximum Power: 400W
- Power Source: 115V / 230V
- Magnet: 40 Oz.
- Dimensions: 380 x 300 x 580mm (15" x 11.8" x 22.8")
- Weight: 10kg (22 lbs)



DJAP-1254A-CMB

PROFESSIONAL ACTIVE LOUDSPEAKER, MICROPHONE AND STAND COMBO

- Wireless Music Stream
- 2-Way Configuration with Active Filter, Amplifier
- Wireless Remote Control
- 2.5" Titanium Driver
- 12" Woofer with 2" ASV Voice Coil
- Class A/B Amplifier, USB Host/SD MP3
- Impedance: 4 Ohms
- Frequency Range: 45Hz-20KHz
- 2-Way Mic Input (XLR/1/4" Jack), Line Input (RCA), Line Output RCA
- Maximum Power: 400W
- Power Source: 115V/230V
- Magnet: 40 Oz.
- Dimensions: 380x300x580mm  
15" x 11.8" x 22.8"
- Weight: 10Kg (22 lbs)



DJAP-1562P-CMB

15" PROFESSIONAL PASSIVE LOUDSPEAKER WITH STAND

- 2-Way Configuration with Active Filter, a Handle and Wheels
- 2.5" Titanium Driver
- 15" Woofer with 2" ASV Voice Coil
- Impedance: 8 Ohms
- Frequency Range: 45Hz-20KHz
- Maximum Power: 500W
- Input: Speak-On
- Magnet: 40 Oz.
- Dimensions: 450x355x685mm 17.7" x 14" x 27"
- Weight: 11Kg (24.2 lbs)



DJAP-1567A-CMB

PROFESSIONAL ACTIVE LOUDSPEAKER

- Wireless Music Stream
- 2-Way Configuration with Active Filter, Amplifier
- Wireless Remote Control
- 2.5" Titanium Driver
- 15" Woofer with 2" ASV Voice Coil
- Class A/B Amplifier, Memory Stick/Memory Card Host
- Impedance 8 Ohms
- Frequency Range: 45Hz - 20,000Hz
- 2-Way Mic Input (XLR/1/4" Jack) Line Input (RCA), Line Output RCA
- Maximum Power: 600W
- Power Source: 115V/230V
- Magnet: 40 Oz.
- Dimensions: 17.7" x 14" x 27"
- Weight: 31.5 Lbs

15" TWO WAY ACTIVE LOUDSPEAKER PACKAGE WITH TRIPOD, MICROPHONE, & WIRELESS REMOTE CONTROL



DJAP-1575-BDMC

PROFESSIONAL ACTIVE LOUDSPEAKER

Includes Tripod, Wireless Microphone, and Wireless Remote Control

- Wireless Music Stream
- 2-Way Configuration with Active Filter, Amplifier
- Wireless Remote Control
- FM tuner
- Rechargeable Battery
- Dual Wireless Mic
- 2.5" Titanium Driver
- 15" Woofer with 2" ASV Voice Coil
- Class A/B Amplifier, Memory Stick Host
- Impedance: 8 Ohms
- Frequency Range: 45Hz-20KHz
- 2-Way Mic Input (XLR/1/4" Jack), Line Input (RCA), Line Output RCA
- Max. Power: 1000W
- Power Source: 115V/230V
- Magnet: 40 Oz
- Dimensions: 17.7"x14"x27"
- Weight: (41.9 lbs)

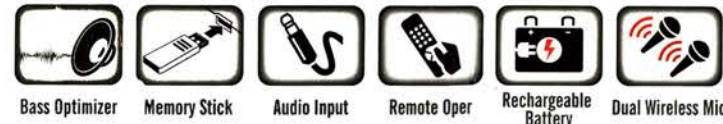

WHEELS FOR EASY TRANSPORTATION



DJAP-B857BT

PROFESSIONAL ACTIVE LOUDSPEAKER

RECHARGEABLE BATTERY INCLUDED

- Wireless Music Stream
- 2-Way Configuration with Active Filter
- Convenient Handle and Wheel for Portability
- Wireless Remote Control
- FM Tuner
- 3.2" Titanium Driver
- 8" Woofer with 1.5" TIL Voice Coil
- Class A/B Amplifier, USB Host/ SD MP3
- 3.5mm Stereo Plug to RCA Plug Included
- Frequency Range: 60Hz - 20kHz
- 2-Way Mic Input (XLR/ 1/4" Jack),
- Line Input (XLR/RCA),
- 2 Band EQ (80Hz, 12kHz),
- Line Output XLR/ 1/4" Jack
- Maximum Power: 250W
- Power Source: 115V
- 12V 7.0Ah Rechargeable Battery Included
- 12V Direct Current Power Supply Connection
- Magnet: 30 Oz.
- Dimensions: 265x285x400mm
- Weight: 11Kg (24.3 lbs)



BUILT-IN BATTERY



Included:  
6 FT 3.5mm to RCA Cable

Wireless Remote Control

DJAP-1577BUSB

BUILT-IN AMPLIFIER

- With USB and SD Card Reader
- 2-Way Configuration with Active Filter
- 4.5 Titanium Driver
- 15" Woofer with 3" ASV Voice Coil
- Class AB Amplifier: USB Host/SD MP3
- Impedance: 8 Ohms
- Frequency Range: 40Hz - 20kHz
- 2-Way Microphone Input
- Maximum Power: 500 Watts
- Power Source: 115V / 230V
- Magnet: 70 Oz.
- Steel Basket Woofer
- High Wattage Powered Class A/B Amplifier
- Stand Mounting Socket
- Auxiliary Line Output
- Metal Grill
- High Temperature Voice Coil
- Rubber Feet
- Easy Carry Handles
- Stacking Grooves
- USB HOST/SD MP3
- Weight: 23.5kg (52 lbs)
- Dimension:  
465 x 420 x 680mm  
18.3" x 16.5" x 26.8"



DJAP-1579SLV

PROFESSIONAL PASSIVE LOUDSPEAKER

- 2-Way Configuration with Active Filter, a Handle and Wheels
- 4.5" Titanium Driver
- 15" Woofer with 3" ASV Voice Coil
- Impedance: 8 Ohms
- Frequency Range: 40Hz - 20kHz
- Maximum Power: 700W
- Input: Speak-On
- Magnet: 70 Oz.
- Dimensions: 480 x 410x 710mm
- Weight: 20kg (44 lbs)



Included:  
15 FT SPEAK-ON Cable



DJAP-1580BT

PROFESSIONAL ACTIVE LOUDSPEAKER

- Wireless Music Stream
- 2-Way Configuration with Active Filter, Amplifier, a Handle and Wheels
- Wireless Remoter Control
- FM Tuner
- Line Output Allows Linking of Additional Enclosure
- 4.5" Titanium Driver
- 15" Woofer with 3" KSV Voice Coil
- Class AB Amplifier, USB Host/SD MP3
- 3.5mm Stereo Plug to RCA Plug Included
- Impedance: 8 Ohms
- Frequency Range: 40Hz - 20kHz
- 2-Way Mic Input (XLR/1/4" Jack), Line Input (XLR/RCA), 2 Band EQ (80Hz, 12kHz), Link Output XLR/1/4" Jack
- Maximum Power: 700W
- Power Source: 115V / 230V
- Magnet: 70 Oz.
- Dimensions: 480 x 410x 710mm
- Weight: 25.5kg (56.2 lbs)



Included:  
6 FT 3.5mm to RCA Cable



Wireless Remote Control

Wireless Music Stream



DJAP-1580BTAMP

- Replacement Amplifier for DJAP-1580BT

### DJAP-B1045CMB

PROFESSIONAL ACTIVE LOUDSPEAKER, MICROPHONE AND STAND COMBO **RECHARGEABLE BATTERY INCLUDED**

- Wireless Music Stream
- 2-Way Configuration with Active Filter Amplifier
- Wireless Remote Control
- 2.5" Titanium Driver
- Double 10" Woofer with 2" KAPTON Voice Coil
- Class A/B Amplifier, USB Host/SD MP3
- Impedance: 8 Ohms
- Frequency Range: 45Hz - 20KHz
- 2-Way Mic Input (XLR/1/4" Jack), Line Input (XLR/RCA), Line Output XLR/1/4" Jack
- Maximum Power: 300W
- Power Source: 115V/230V
- 12V 12.0Ah Rechargeable Battery Included RB12-12
- Magnet: 34 Oz.
- Dimensions: 382x280x810mm  
15" x 11" x 31.9"
- Weight: 18kg (39.7 lbs)



### DJAP-1593BT

WIRELESS MUSIC STREAM

- 2-Way Configuration with Active Filter, Amplifier, a Handle and Wheels
- Line Output Allows Linking of Additional Enclosure
- 4.5" Titanium Driver
- Frequency Range: 40Hz - 20KHz
- 15" Woofer with 3" KSV Voice Coil
- Magnet: 93 Oz.
- Impedance: 8 Ohms
- Class A/B Amplifier, USB Host/SD MP3
- 2-Way Mic Input (XLR/ 1/4" Jack), Line Input (XLR/RCA), 2 Band EQ (80Hz, 12kHz), Line Output XLR / 1/4" Jack
- Maximum Power: 1000W
- Power Source: 115V / 230V
- Dimensions: 465 x 430 x 700mm  
18.3" x 16.9" x 27.6"
- Weight: 22.5kg (49.6 lbs)



### DJAP-1593PRO-P

PROFESSIONAL PASSIVE LOUDSPEAKER

- 2-Way Configuration with Active Filter
- Convenient Handle and Wheel for Portability
- 4.5" Titanium Driver
- 15" Woofer with 3" KSV Voice Coil
- Impedance: 8 Ohms
- Frequency Range: 40Hz - 20kHz
- Maximum Power: 1000 Watts
- Input: Speak-On
- Magnet: 93 Oz.
- Dimensions: 18.3" x 16.9" x 27.6"



Stand Mounting Socket



Wheels for Easy Transportation



**DJAP-BD1560UB**

**RECHARGEABLE BATTERY INCLUDED**  
PROFESSIONAL ACTIVE LOUDSPEAKER

- Wireless Music Stream
- 2-Way Configuration with Active Filter, Amplifier
- Wireless Remote Control
- 2.5" Titanium Driver
- Double 15" Woofer with 2" KAPTON Voice Coil
- Class A/B Amplifier, USB Host/SD MP3
- Impedance: 8 Ohms
- Frequency Range: 40Hz - 20KHz
- 2-Way Mic Input (XLR/1/4" Jack), Line Input (RCA), Line Output RCA
- Rechargeable Battery RB12-12 (12 Volt / 12 Amp) Lasts for 6 Hours on a 3 Hour Charge
- Maximum Power: 1000W
- Power Source: 115V/230V
- Magnet: 40 Oz.
- Dimensions: 470x380x1150mm  
18.5" x 15" x 45.3"
- Weight: 25kg (55 lbs)



**DJAP-SUB1000**

PROFESSIONAL ACTIVE LOUDSPEAKER

- Sub-Woofer with Active Filter
- Frequency Response: 51-122hz
- 10" Woofer with 2.5" Voice Coil
- Line Input: Combo/XLR
- Line Output: XLR
- Maximum Power: 800W
- Power Voltage: AC 115 V & AC 230 V
- Dimensions: 18.3" X 16.5" X 12.8"
- Net Weight: 34.2 Lbs

**BUILT-IN AMPLIFIER**



**HANDLES FOR EASY TRANSPORTATION!**



*StagePipe*

**DJAP-SUB1200**

PROFESSIONAL ACTIVE LOUDSPEAKER

- Sub-Woofer with Active Filter
- Frequency Response: 46 - 125hz
- 12" Woofer with 2.5" Voice Coil
- Line Input: Combo/XLR
- Line Output: XLR
- Maximum Power: 1000W
- Power Voltage: AC 115 V & AC 230 V
- Dimensions: 20.9" X 18.3" X 14.6"
- Net Weight: 46.3 Lbs

**BUILT-IN AMPLIFIER**



**HANDLES FOR EASY TRANSPORTATION!**



*StagePipe*

**DJAP-D1550UB**

2-WAY CONFIGURATION WITH ACTIVE FILTER, AMPLIFIER

- Wireless Remote Control
- 4.5" Titanium Driver
- Double 15" Woofer with 2.5" KAPTON Voice Coil
- Class A/B Amplifier
- USB Host/SD MP3
- Frequency Range: 40Hz - 20KHz
- 2-Way Mic Input (XLR/1/4" Jack) Line Input (XLR/RCA) Line Output (XLR/1/4" Jack)
- Maximum Power: 800W
- Power Source: 115V/230V
- Magnet: 50 Oz.
- Dimensions: 450x345x1100mm  
17.7" x 13.6" x 43.3"
- Weight: 26kg (57.3 lbs)



**DJAP-SUB1500**

PROFESSIONAL ACTIVE LOUDSPEAKER

- Sub-Woofer with Active Filter
- Frequency Response: 43 - 130hz
- 15" Woofer with 2.5" Voice Coil
- Line Input: Combo/XLR
- Line Output: XLR
- Maximum Power: 1200W
- Power Voltage: AC 115 V & AC 230 V
- Dimensions: 22.8" X 18.9" X 17.7"
- Net Weight: 58.4 Lbs

**BUILT-IN AMPLIFIER**



**HANDLES FOR EASY TRANSPORTATION!**



*StagePipe*

DJAP-18601

PROFESSIONAL ACTIVE LOUDSPEAKER

- Subwoofer with Active Filter 18" Subwoofer
- Subwoofer Frequency Response: 30Hz - 180Hz ± 3dB
- Satellite Frequency Response: 180Hz - 20KHz ± 3dB
- Line Input: XLR / RCA
- Line Output: XLR / RCA
- Maximum Power: 500W
- Power Voltage: AC115V & AC230V
- Dimensions: 27.2" x 21.9" x 24.2"
- Net Weight: 37.5kg (83Lbs)



DJAP-COVER01

INDOOR / OUTDOOR SPEAKER COVER

- Fits DJAP-1564A/DJAP-1564A-CMB/ DJAP-1567A-CMB/DJAP-1562P-CMB Speakers
- Fabric and Mesh Cover
- Handle Access Openings
- For Temporary Outdoor use of a Speaker in Adverse Weather Conditions
- Removable Amplifier Panel Allows Access to Connectors and Controls
- Keeps out Dust, Dirt and Helps Prevent Dents



QB-1000BT

BAR CUBE POWER AMPLIFIER

- Monoblock Class A/B Amplifier, USB Host / SD MP3
- Mono Channel Operation
- Total Peak Power Output: 600 Watts
- RMS Power Rating: 4 Ohms: 300W x 1 Channel
- THD at Rated RMS Power 0.5%
- Signal-to-Noise Ratio 60dB
- Frequency Response: 20Hz - 22kHz
- Dimensions: 9.7"L x 7.3"W x 8"H
- 2-Way Mic Input (XLR/ 1/4" Jack) Line Input (XLR / RCA)
- 2 Band EQ (80Hz, 12kHz) Output XLE/RCA
- Power Source: 115/230V
- Dimensions (WxDxH): 10" x 7.5" x 8.5"

600Watts



Designed to power 2 passive Enclosures



MSA-12

P.A. SPEAKER STAND WITH P.A. SPEAKER HOLDER

- Stand with P.A. Speaker Holder
- Height Adjustment Grip
- Carry Bag
- Product Parameter:  
Height: 39.4" - 74.8"  
(1000-1900mm)  
Weight: 6.7Lbs (3.05Kg)



EX-PRO312-25BLK

3 OUTLET 25' HEAVY-DUTY EXTENSION CORD

EX-PRO312-50BLK

3 OUTLET 50' HEAVY-DUTY EXTENSION CORD

- Tangle-Free and Ultra-Flexible
- Great for Indoor/Outdoor use around the House, Garage and many other places
- 3 Ground Outlets



Now stronger than ever, this heavy duty extension cord is a must have accessory for your PA cabinet, disco lighting, or any electrical application.



CABLES



**FBC-3** (3')  
**FBC-6** (6')  
**FBC-10** (12')  
**FBC-18** (18')

**INSTRUMENT CABLE**

- 1/4" to 1/4" Mono
- Black



**FCC-18BLS**

**1/4" TO 1/4" INSTRUMENT CABLE**

- Tweed/ 7.4mm
- 18'
- Shrink Tubing Gold Tip Plug
- Black & Silver Cotton Woven Exterior Cover



**FS-620** (20')

**SPEAKER CABLE**

- 1/4" to 1/4"
- Clear

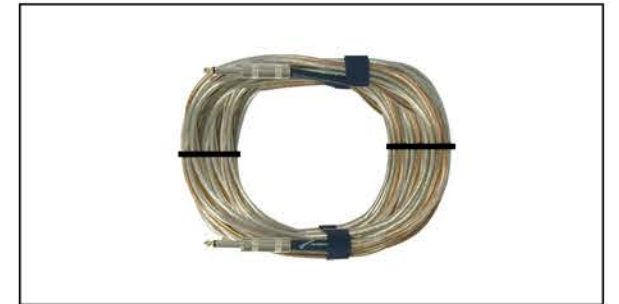

**FS-650** (50')

**SPEAKER CABLE**

- 1/4" to 1/4"
- Clear



**FX-714P-F60** (20')

**FX-714P-F60 30F** (20')

**MICROPHONE CABLE**

- 3 Pin Female XLR to 1/4"
- Black

**FX-714P-P35** (6')

**MICROPHONE CABLE**

- 1/4" Plug to 3.5mm
- Black



**FX-720** (20')

**FX-750** (50')

**INSTRUMENT CABLE**

- 1/4" to 1/4"
- Black

# PRO AUDIO CABLES





FX-7M60-14-6 (6')  
 FX-7M60-14-20 (20')  
 FX-7M60-14-50 (50')  
 1/4" TO XLR FEMALE PREMIUM  
 INSTRUMENT CABLE  
 • Black

FXB-3514-6 (6')  
 FXB-3514-12 (12')  
 INSTRUMENT CABLE  
 • 3.5mm Plug to 1/4" Plug  
 • Ø 6.3mm  
 • Black

FX-7M60-F60-3 (3')  
 FX-7M60-F60-6 (6')  
 FX-7M60-F60-20 (20')  
 FX-7M60-F60-50 (50')  
 FX-7M60-F60-75 (75')  
 MICROPHONE CABLE  
 • 3 Pin Male XLR to 3 Pin Female XLR  
 • Black



MC-5-500WV  
 MICROPHONE CABLE  
 WITH WOVEN JACKET  
 • 500'  
 • 20 Gauge  
 • Stereo



MC-10  
 MICROPHONE CABLE  
 • 20'  
 • 1/4" Plug to 3 Pin XLR Jack

MC-10-10  
 MICROPHONE CABLE  
 • 10'  
 • 3 Pin XLR Female to  
 1/4" Male



MC-14-3 (3')  
 MC-14-6 (6')  
 MC-14-12 (12')  
 MC-14-20 (20')  
 MC-14-30 (30')

PRO AUDIO-INSTRUMENT CABLE  
 • 1/4" to 1/4" Heavy-Duty 20 Gauge Pro Audio Cable  
 • Single Plug Works Great for many  
 Instrument Connections  
 • Low Resistance and Maximum Signal Transfer  
 • Durable yet Flexible, Black PVC Outer Jacket  
 • Heavy-Duty Metal Shell Connectors for  
 a Reliable Connection



FXB-3514M-12 (12')  
 FXB-3514M-18 (18')  
 ACCESSORY CABLES  
 • 3.5MM PLUG TO 1/4" Mono Plug  
 • Black



FXC-61414  
 JUMPER CABLES FOR  
 GUITAR PEDALS  
 • 6 Color Coded: Red, Blue,  
 Yellow, Green, Black & Purple



MC-20-3 (3')  
 MC-20-6 (6')  
 MC-20-12 (12')  
 MC-20-20 (20')  
 MC-20-30 (30')  
 MC-20-50 (50')  
 MICROPHONE CABLE  
 • 3 Pin XLR Plug to  
 3 Pin XLR Jack



MC-30-6 (6')  
 MC-30-12 (12')  
 MC-30-30 (30')  
 MICROPHONE CABLE  
 • 1/4" Mono Plug to  
 3 Pin XLR Plug



**N-110E**  
RED INSTRUMENT CABLE  
• 10'  
• 1/4" Plug to 1/4" Plug with Gold Tips



**N-120E**  
RED INSTRUMENT CABLE  
• 20'  
• 1/4" Plug to 1/4" Plug with Gold Tips



**N-130E**  
BLUE INSTRUMENT CABLE  
• 10'  
• 1/4" Plug to 3 Pin Female XLR with Gold Tip



**N-140E**  
BLUE INSTRUMENT CABLE  
• 20'  
• 1/4" Plug to 3 Pin Female XLR with Gold Tip



**N-112CL (10')**  
**N-122CL (20')**  
PROFESSIONAL WOVEN INSTRUMENT CABLE  
• 1/4" to 1/4" with Gold Tips  
• High Heat Protection



**N-122-MF60**  
WOVEN MICROPHONE CABLE  
• 20'  
• 3 Pin Female XLR to 3 Pin Male XLR



**N-150 (10')**  
• Instrument Cable  
• 1/4" to 1/4" Angled



**N-170E (10')**  
**N-180E (20')**  
• Microphone Cable  
• 3 Pin Male to 3 Pin Female

**N-200**  
• Instrument Cable  
• 1/4" to 1/4"  
• Shielded  
• 20'



**N-234-6 (6')**  
**N-234-12 (12')**  
• Black  
• 3.5mm to 1/4"



**N-251 (10')**  
**N-252 (20')**  
• Instrument Cable  
• 1/4" to 1/4"  
• Gold Tips



**F-70**  
TERMINAL  
• 3 Pins  
• Female  
• Metal



**X-1067**  
TERMINAL  
• 3 Pins  
• XLR Female  
• Plastic



**X-1068**  
TERMINAL  
• 3 Pins  
• XLR Male  
• Plastic



**X-1091**  
TERMINAL  
• 8 Pins  
• SPK Female  
• Plastic



**X-1092**  
TERMINAL  
• 4 Pins  
• SPK Female  
• Plastic



**X-1097**  
TERMINAL  
• 4 Pins  
• SPK Female  
• Plastic



**X-1098**  
TERMINAL  
• 4 Pins  
• SPK Female  
• Plastic



**X-1103**  
• SPKN Male  
• 8 Pins



**X-1135**  
• SPKN Female to 1/4" Female  
• 2 Pins



**X-1136**  
• 1/4" Female to SPKN Male



**X-1142**  
• SPKN Plug Coupler



**XMB-1094**

- 4-Pin Male Cable Mount SPKN Connector
- Professional Audio Connector Commonly used to Connect Speakers to a Powered Amplifier
- Connector Body Unscrews for Easy Assembly with no Soldering Required
- Compact Design with Durable Metal Shell, and Chuck Type Strain Relief for Secure Clamping of all Cables
- Reliable, Easy to Assemble and Improves Contact Integrity as well Cable Strain Relief



**XMP-1095**

- 4-Pin Female Cable Mount SPKN Connector
- These Connectors are the Standard Chassis Connectors for Loudspeaker / Amplifier Interconnections
- Precise Keyway for Secure Mating
- They Feature a Unique Metal Locking System, Making Contact Only Once Fully Locked. The SpeakON Receptacles are Robust, Versatile and Easy to Terminate
- Reliable, Easy to Assemble and Improves Contact Integrity as well Cable Strain Relief

CONNECTORS



**X-1001**  
 • XLR Female with Nickel Finish  
 • 3 Pins



**X-1002**  
 • XLR Male with Nickel Finish  
 • 3 Pins



**X-1088**  
 • SPKN Type Male Plug  
 • 4 Pins  
 • Economy Type



**X-1089**  
 • SPKN Type Female Plug  
 • 4 Pins



**X-1090**  
 • SPKN Male  
 • 4 Pins



**X-1090B**  
 • SPKN Male Plug  
 • 4 Pins



**X-1090F**  
 • SPKN Female  
 • 4 Pins



**X-1090L**  
 • SPKN Plug  
 • 4 Pins  
 • Right Angle



**X-1093**  
 • SPKN Female Cable Connector  
 • 8 Pins

CONNECTORS



**MX-71 BLK**  
 CONNECTOR 3-PINS XLR MALE  
 • Black Color



**MX-73 BLK**  
 CONNECTOR 3 PINS MALE XLR  
 • Hexagon Cap  
 • Color Black



**MX-73 BLU**  
 CONNECTOR 3 PINS MALE XLR  
 • Hexagon Cap  
 • Color Blue



**MX-73 RED**  
 CONNECTOR 3-PIN MALE XLR  
 • Hexagon Cap  
 • Color Red



**MX-75**  
 CONNECTOR 3-PIN MALE XLR  
 • Metal Cap  
 • Ring Color Available in:  
 Blue, Green, White, Yellow and Red



**P-193**  
 CONNECTOR 1/4" FEMALE STEREO  
 • Metal Finish



**P-195**  
 CONNECTOR 1/4" FEMALE  
 STEREO TERMINAL  
 • Metal Finish

CONNECTORS



**F-60**  
• XLR Female



**F-67**  
• XLR Female to 1/4" Mono Plug

**FX-61 BLK**

- XLR Female
- Metal Cap
- Black

**FX-61**

- XLR Female
- Metal Cap
- Includes Rings: Black, Blue, Green, Red, Yellow and White



**FX-63**  
• XLR Female  
• Metal Cap



**FX-71 BLK**  
• XLR Female



**FX-73 BLK**  
• 3 Pins Female XLR  
• Hexagon Cap  
• Color: Black



**FX-73 BLU**  
• 3 Pins Female  
• Hexagon Cap  
• Color: Blue



**FX-73 RED**  
• 3 Pins Female  
• Hexagon Cap  
• Color: Red



**FX-75**  
• 3 Pins Female  
• Metal Cap  
• Includes Rings: Black, Blue, Green, Red, Yellow and White

CONNECTORS



**M-60**  
• XLR  
• Male



**M-67**  
• 3 Pins Male to 1/4" Plug



**M-68**  
• 3 Pins  
• Male XLR to Male XLR



**M-70**  
• 3 Pins  
• Male XLR Terminal



**M-77**  
• XLR Male to 1/4" Female

**M-78**  
• 3 Pins  
• Female XLR to Female XLR



**M-80**  
• Microphone Connector 3Pin/Male  
• XLR / 1/4" Dual Purpose Socket



**MX-61**  
• 3 Pins Male XLR  
• Metal Cap  
• Includes Rings: Blue, Black, Green, Yellow, Red and White



**MX-61 BLK**  
• 3 Pins Male XLR  
• Metal Cap  
• Black



**MX-63**  
• 3 Pins Male XLR  
• Metal Cap



CONNECTORS



**X-1132**

- 1/4" Mono Male
- Nickel Finish
- Gold Tip
- Connects Cable which is between Ø 6~7mm
- Includes 3 Additional Color Code Bands



**X-1132BK**

- 1/4"
- Mono Male
- Nickel Finish
- Gold Tip
- Connects Cable which is between Ø 6~7mm
- Black Color



**X-1132BL**

- 1/4"
- Mono Male
- Nickel Finish
- Gold Tip
- Connects Cable which is between Ø 6~7mm
- Blue Color



**X-1132RD**

- 1/4"
- Mono Male
- Nickel Finish
- Gold Tip
- Connects Cable which is between Ø 6~7mm
- Red Color



**X-1132YL**

- 1/4"
- Mono Male
- Nickel Finish
- Gold Tip
- Connects Cable which is between Ø 6~7mm
- Yellow Color



**P-180 BLU**  
**P-180 RED**  
PROFESSIONAL PLUG 1/4"

- Mono
- Available in Black and Red

**P-181 BLK**  
**P-181 BLU**  
**P-181 RED**  
PROFESSIONAL PLUG 1/4" COLOR CODED

- Stereo
- Available in Black, Blue and Red



CONNECTORS



**X-1133**

- 1/4"
- Stereo Male
- Nickel Finish
- Gold Tip
- Connects Cable which is between Ø 6~7mm



**X-1141**

- 1/4" Plug Coupler
- Nickel Finish



**X-1143**

- 1/4" Plug Coupler Stereo
- Nickel Finish



**X-571**

- 1/4"
- Mono Silver Tip
- Nickel Finish
- Bakelite

**X-571G**

- 1/4"
- Mono Gold Tip
- Nickel Finish
- Bakelite



**X-591G**

- 1/4"
- Mono Gold Tip
- Nickel Finish



**X-601**

- 1/4"
- Mono Male
- Nickel Finish
- Heavy Duty
- Bakelite



**X-602**

- 1/4"
- Stereo Male
- Nickel Finish
- Heavy Duty
- Gold Tip



**X-631GB**

- 1/4"
- Mono Gold Tip
- Bakelite

CONNECTORS

MICROPHONE CABLES



**ZA-XLRF-RCAF**  
 • 3-Pin XLR Female to RCA Female Jack  
 • Connects an Unbalanced RCA Female Head to a Balanced XLR Female



**ZA-XLRM-RCAF**  
 • 3-Pin XLR Male to RCA Female Jack  
 • Connects an Unbalanced RCA Female Head to a Balanced XLR Female



**ZA-XLRF-RCAM**  
 • 3-Pin XLR Female to RCA Male Jack  
 • Connects an Unbalanced RCA Male Head to a Balanced XLR Female



**ZA-XLRF-XLRF**  
 • XLR Female to XLR Female Coupler  
 • In-Line Balanced 3-Pin XLR Adapter Joins Two XLR Male Connectors



**ZA-XLRM-RCAM**  
 • 3-Pin XLR Male to RCA Male Jack  
 • Connects an Unbalanced RCA Male Head to a Balanced XLR Male



**ZA-XLRM-XLRM**  
 • XLR Male to XLR Male Coupler  
 • In-Line Balanced 3-Pin XLR Adapter Joins Two XLR Female Connectors

**ZP-14MN**  
 • 1/4"  
 • Mono



**ZP-14MN-PG**  
 • 1/4"  
 • Gold-Plated  
 • Mono Gold Tip

**ZP-14MN-RA**  
 • 1/4"  
 • Mono Gold Tip  
 • Right Angle



**ZP-35MM-P**  
 • 3.5mm Mono Plug



**ZP-35ST-P**  
 • 3.5mm Stereo Plug



**MC-4 BLU**  
 MICROPHONE CABLE  
 • 500 FT. (152.4 meters)  
 • Color: Blue  
 • Flexible PVC  
 • 100% Copper  
 • Braided for High Shielding  
 • Stereo  
 •  $\Phi$  0.26" / 6.7mm



**MC-4 BLK**  
 MICROPHONE CABLE  
 • 500 FT. (152.4 meters)  
 • Color: Black  
 • Flexible PVC  
 • 100% Copper  
 • Braided for High Shielding  
 • Stereo  
 •  $\Phi$  0.26" / 6.7mm



**MC-4 RED**  
 MICROPHONE CABLE  
 • 500 FT. (152.4 meters)  
 • Color: Red  
 • Flexible PVC  
 • 100% Copper  
 • Braided for High Shielding  
 • Stereo  
 •  $\Phi$  0.26" / 6.7mm



**MC-4 YLW**  
 MICROPHONE CABLE  
 • 500 FT. (152.4 meters)  
 • Color: Yellow  
 • Flexible PVC  
 • 100% Copper  
 • Braided for High Shielding  
 • Stereo  
 •  $\Phi$  0.26" / 6.7mm



### DJ-115FM

15" WOOFER

- 6" x 17" Horn Tweeter
- Power Handling: 200W RMS/ 400W Maximum
- Full Metal Mesh Grill
- Impedance: 8 Ohms
- Magnet: 50 Oz.
- 2" Al Voice Coil
- Dimensions: 530 x 395 x 395 x 755 mm



### MSZ-1550

15" WOOFER

- 6" x 17" Horn Tweeter
- Power Handling: 200W RMS/ 400W Maximum
- Full Metal Mesh Grill
- Impedance: 8 Ohms
- Magnet: 50 Oz.
- 2" Al Voice Coil
- Dimensions: 530 x 395 x 395 x 755 mm



### MSZ-1250

15" WOOFER

- 6" x 17" Horn Tweeter
- Power Handling: 200W RMS/ 400W Maximum
- Full Metal Mesh Grill
- Impedance: 8 Ohms
- Magnet: 50 Oz.
- 2" Al Voice Coil
- Dimensions: 530 x 395 x 395 x 755 mm



**ZEBRA**



**Z-20C**

TWEETER BOX

- Two 4" Piezo Tweeters
- Dimensions: 290 x 225 x 1160mm (11.4" x 8.8" x 6.3")
- Frequency Response: 4K-27KHz
- Maximum Power: 100W



**Z-40C**

TWEETER BOX

- 4-Way Tweeter System
- Carpeted Heavy Duty Construction
- Power Handling: 100W RMS/200W Peak
- Dual 1/4" Phono Jacks
- Frequency Response: 3.5K-20KHz
- SPL: 97dB (1W/1M)



**Z-70**

TWEETER BOX

- 7-Way DJ Tweeter System
- Six 3.5" Piezo Tweeters
- 5" x 12" Horn
- Gold Post Terminals
- Carpet Finish
- Frequency Response: 6K-29KHz
- Sensitivity: 95dB (1W/1M)
- Size: 13" x 22" x 12.5"
- Maximum Power



**Z-90**

TWEETER BOX

- 6-Way DJ Tweeter System
- Five 3.5" Piezo Tweeters
- 10" x 18" Horn Tweeter
- Gold Post Terminals
- Carpet Finish
- Chrome-Plated Metal Corners
- Frequency Response: 9K-31KHz
- Sensitivity: 92dB (1W/1M)
- Size: 16.75" x 22.375" x 1.25"
- Maximum Power: 400W



**ZMX-100**

MINI MIXER

- 4 Mic Inputs
- 1 Line Output
- 20dB Gain
- Power Supply: DC 12V / AC 100-240V



**ZMX-200**

MINI MIXER

- 8 Mic Inputs
- 2 Line Output
- 20dB Gain
- Power Supply: DC 12V / AC 100-240V



**ZMX-400 EFX**

MINI MIXER

- 4 Mono 1/4" Microphone Inputs with Individual Volume Control
- Built-In Echo Effects DSP with Delay Time and Depth Control
- Simulates from Room, Hall, Stadium and Delays Reverb
- 1/4" Unbalanced Output
- Up to 50dB of Gain per Channel
- Power ON/OFF Switch with LED Indicator, 9V DC Powered with PAD
- 1 AC/DC External Adapter



PRO AUDIO CABLES



FXB-3514-6 (6'/1.83m)  
 FXB-3514-12 (12'/3.66m)  
 3.5MM PLUG TO 1/4" PLUG  
 • Ø6.3mm



X-211-25 (25'/7.62m) X-211-50 (50'/15.24m)  
 2 WIRE SPKN to Banana  
 • 14 Gauge X-211-75 (75'/22.86m)  
 2 WIRE SPKN to Banana  
 • 14 Gauge



X-214-15 (15'/4.57m) X-214-50 (50'/15.24m)  
 X-214-25 (25'/7.62m) 2 WIRE SPKN to 1/4"  
 • 14 Gauge  
 2 WIRE SPKN to 1/4"  
 • 14 Gauge



X-352-15 (15'/4.57m) X-352-50 (50'/15.24m)  
 X-352-25 (25'/7.62m) 2 WIRE SPKN MALE TO  
 SPKN MALE  
 • 14 Gauge X-352-75 (75'/22.86m)  
 2 WIRE SPKN MALE TO  
 SPKN MALE  
 • 14 Gauge

X-371-1.5 (4.92'/1.5m)  
 4 WIRE SPKN MALE TO  
 SPKN MALE  
 • 14 Gauge



X-371-5 (16.40'/5m)  
 4 WIRE SPKN MALE TO  
 SPKN MALE  
 • 12 Gauge



X-371-15 (49.21'/15m)  
 4 WIRE SPKN MALE TO  
 SPKN MALE  
 • 12 Gauge



STUDIO Z



**N-110E**  
INSTRUMENT CABLE 1/4" TO 1/4" WITH GOLD TIPS  
• 10 FT



**N-130E**  
INSTRUMENT CABLE 1/4" TO 3 PIN FEMALE WITH GOLD TIPS  
• 10 FT



**N-140E**  
INSTRUMENT CABLE 1/4" TO 3 PIN FEMALE WITH GOLD TIPS  
• 20 FT



**ZPC-PH35-10**  
OFC 3.5MM STEREO TO XLR MALE MICROPHONE CABLE  
• Premium Jacket Material Provide Ease of Handling and Long Service Life  
• Bright Nickel-Plated Connectors for Long Term Good Looks and Conductivity  
• 24 AWG Oxygen-Free Copper Stranded Conductors for Maximum Signal Transfer



**XSPK-14-100** (100' / 30.48m)  
2 WIRE SPKN TO SPKN CABLES  
• 16 Gauge



**XSPK-210-250**  
4 WIRE SPKN CABLE  
• 250' / 76.2m  
• 10 Gauge  
• OD: Ø14mm



**XSPK-214-100**  
4 WIRE SPKN CABLE  
• 100' / 30.48m  
• 14 Gauge  
• OD: Ø10mm



**XSPK-214-250**  
4 WIRE SPKN CABLE  
• 250' / 76.2m  
• 14 Gauge  
• OD: Ø10mm



**N-112CL** (10')  
**N-122CL** (10')  
PROFESSIONAL CABLE  
• 1/4" to 1/4" with Gold Tips  
• High Heat Protection



**ZCI-14S214M-6**  
SIGNAL CABLE  
• 1/4" Stereo to 1/4" Mono Left  
• 1/4" Mono Right  
• 6'

## PRO AUDIO CABLES

**ZICM-241414M-10**

10Ft 1/4" TO 1/4" HEAVY-DUTY

- 24 gauge pro audio cable
- Low resistance and maximum signal transfer
- Durable yet flexible, black PVC outer jacket
- Heavy-duty metal shell connectors for a reliable connection

**ZICM-241414M-20**

20Ft 1/4" TO 1/4" HEAVY-DUTY

- 24 gauge pro audio cable
- Low resistance and maximum signal transfer
- Durable yet flexible, black PVC outer jacket
- Heavy-duty metal shell connectors for a reliable connection

**ZICM-201414MR-20**

20Ft 1/4" TO 1/4" RIGHT ANGLE HEAVY DUTY

- 20 gauge pro audio cable
- Single right angle plug works great for many instrument connections
- Low resistance and maximum signal transfer
- Durable yet flexible, black PVC outer jacket
- Heavy-duty metal shell connectors for a reliable

**ZICM-241414MR-10**

10Ft 1/4" TO 1/4" RIGHT ANGLE HEAVY-DUTY

- 20 gauge pro audio cable
- Single right angle plug works great for many instrument connections
- Low resistance and maximum signal transfer
- Durable yet flexible, black PVC outer jacket
- Heavy-duty metal shell connectors for a reliable

**ZICM-241414M-30**

30Ft 1/4" TO 1/4" HEAVY-DUTY

- 24 gauge pro audio cable
- Low resistance and maximum signal transfer
- Durable yet flexible, black PVC outer jacket
- Heavy-duty metal shell connectors for a reliable connection

**ZICM-201414M-10**

10Ft 1/4" TO 1/4" HEAVY-DUTY

- 20 gauge pro audio cable
- Single plug works great for many instrument connections
- Low resistance and maximum signal transfer
- Durable yet flexible, black PVC outer jacket
- Heavy-duty metal shell connectors for a reliable connection

**ZICM-241414MR-20**

20Ft 1/4" TO 1/4" RIGHT ANGLE HEAVY-DUTY

- 20 gauge pro audio cable
- Single right angle plug works great for many instrument connections
- Low resistance and maximum signal transfer
- Durable yet flexible, black PVC outer jacket
- Heavy-duty metal shell connectors for a reliable

**ZICM-241414MR-30**

30Ft 1/4" TO 1/4" RIGHT ANGLE HEAVY-DUTY

- 20 gauge pro audio cable
- Single right angle plug works great for many instrument connections
- Low resistance and maximum signal transfer
- Durable yet flexible, black PVC outer jacket
- Heavy-duty metal shell connectors for a reliable

**ZICM-201414M-20**

20Ft 1/4" TO 1/4" HEAVY-DUTY

- 20 gauge pro audio cable
- Single plug works great for many instrument connections
- Low resistance and maximum signal transfer
- Durable yet flexible, black PVC outer jacket
- Heavy-duty metal shell connectors for a reliable connection

**ZICM-201414M-30**

PATCH CABLE 1/4" TRS MALE TO 1/4" TRS MALE

- Premium jacket material provide ease of handling and long service life
- Bright nickel plated connectors for long term good looks and conductivity
- 20 AWG oxygen-free copper stranded conductors for maximum signal transfer

**ZICM-201414MR-10**

10Ft 1/4" TO 1/4" RIGHT ANGLE

- 20 gauge pro audio cable
- Single right angle plug works great for many instrument connections
- Low resistance and maximum signal transfer
- Durable yet flexible, black PVC outer jacket
- Heavy-duty metal shell connectors for a reliable connection

## PRO AUDIO CABLES

**ZICW-201414-10B**

10Ft BLACK WOVEN 1/4" TO 1/4" HEAVY-DUTY

- 20 gauge pro audio cable
- Sport nylon braiding protects the cable against cuts and breaks caused by kinking, things falling on it, or things rolling over it
- Low resistance and maximum signal transfer
- Heavy-duty metal shell connectors for a reliable connection

**ZICW-201414-20B**

20Ft BLACK WOVEN 1/4" TO 1/4" HEAVY-DUTY

- 20 gauge pro audio cable
- Sport nylon braiding protects the cable against cuts and breaks caused by kinking, things falling on it, or things rolling over it
- Low resistance and maximum signal transfer
- Heavy-duty metal shell connectors for a reliable connection

**ZICW-241414-20G**

20Ft GREEN WOVEN 1/4" TO 1/4" HEAVY-DUTY

- 20 gauge pro audio cable
- Sport nylon braiding protects the cable against cuts and breaks caused by kinking, things falling on it, or things rolling over it
- Low resistance and maximum signal transfer
- Heavy-duty metal shell connectors for a reliable connection

**ZICW-201414-30B**

30Ft BLACK WOVEN 1/4" TO 1/4" HEAVY-DUTY

- 20 gauge pro audio cable
- Sport nylon braiding protects the cable against cuts and breaks caused by kinking, things falling on it, or things rolling over it
- Low resistance and maximum signal transfer
- Heavy-duty metal shell connectors for a reliable connection

**ZICW-241414-10B**

10Ft BLACK WOVEN 1/4" TO 1/4" HEAVY-DUTY

- 24 gauge pro audio cable
- Sport nylon braiding protects the cable against cuts and breaks caused by kinking, things falling on it, or things rolling over it
- Low resistance and maximum signal transfer
- Heavy-duty metal shell connectors for a reliable connection

**ZICW-241414-20O**

20Ft ORANGE WOVEN 1/4" TO 1/4" HEAVY-DUTY

- 24 gauge pro audio cable
- Sport nylon braiding protects the cable against cuts and breaks caused by kinking, things falling on it, or things rolling over it
- Low resistance and maximum signal transfer
- Heavy-duty metal shell connectors for a reliable connection

**ZICW-241414-20B**

20Ft BLACK WOVEN 1/4" TO 1/4" HEAVY-DUTY

- 24 gauge pro audio cable
- Sport nylon braiding protects the cable against cuts and breaks caused by kinking, things falling on it, or things rolling over it
- Low resistance and maximum signal transfer
- Heavy-duty metal shell connectors for a reliable connection



PRO AUDIO CABLES



**ZMC-24XMXF-6BP**  
6Ft 3 PIN XLR MALE TO 3 PIN XLR FEMALE

- 24 gauge classic microphone cable
- Black polish connector finish
- Extremely low capacitance for pure signal transparency
- Molded strain relief for ultimate durability
- Ultra-pure oxygen-free
- Durable yet flexible, black PVC outer jacket



**ZMC-24XMXF-10BP**  
10Ft 3 PIN XLR MALE TO 3 PIN XLR FEMALE

- 24 gauge classic microphone cable
- Black polish connector finish
- Extremely low capacitance for pure signal transparency
- Molded strain relief for ultimate durability
- Ultra-pure oxygen-free
- Durable yet flexible, black PVC outer jacket



**ZMC-24XMXF-25BP**  
25Ft 3 PIN XLR MALE TO 3 PIN XLR FEMALE

- 24 gauge classic microphone cable
- Black polish connector finish
- Extremely low capacitance for pure signal transparency
- Molded strain relief for ultimate durability
- Ultra-pure oxygen-free
- Durable yet flexible, black PVC outer jacket



**ZMC-24XMXF-50BP**  
50Ft 3 PIN XLR MALE TO 3 PIN XLR FEMALE

- 24 gauge classic microphone cable
- Black polish connector finish
- Extremely low capacitance for pure signal transparency
- Molded strain relief for ultimate durability
- Ultra-pure oxygen-free
- Durable yet flexible, black PVC outer jacket



**ZMC-24XMXF-6NP**  
6Ft 3 PIN XLR MALE TO 3 PIN XLR FEMALE

- 24 gauge microphone Cable with nickel connector
- Satin nickel polish connector finish
- Extremely low capacitance for pure signal transparency
- Molded strain relief for ultimate durability
- Ultra-pure oxygen-free
- Durable yet flexible, black PVC outer jacket



**ZMC-24XMXF-10NP**  
10Ft 3 PIN XLR MALE TO 3 PIN XLR FEMALE

- 24 gauge microphone Cable with nickel connector
- Satin nickel polish connector finish
- Extremely low capacitance for pure signal transparency
- Molded strain relief for ultimate durability
- Ultra-pure oxygen-free
- Durable yet flexible, black PVC outer jacket



**ZMC-24XMXF-25NP**  
25Ft 3 PIN XLR MALE TO 3 PIN XLR FEMALE

- 24 gauge microphone Cable with nickel connector
- Satin nickel polish connector finish
- Extremely low capacitance for pure signal transparency
- Molded strain relief for ultimate durability
- Ultra-pure oxygen-free
- Durable yet flexible, black PVC outer jacket



**ZMC-24XMXF-50NP**  
50Ft 3 PIN XLR MALE TO 3 PIN XLR FEMALE

- 24 gauge microphone Cable w/nickel connector
- Satin nickel polish connector finish
- Extremely low capacitance for pure signal transparency
- Molded strain relief for ultimate durability
- Ultra-pure oxygen-free
- Durable yet flexible, black PVC outer jacket



**ZMCW-24XMXF-6B**  
6FT BLACK WOVEN 3PIN XLR MALE TO 3 PIN XLR FEMALE

- 24 gauge pro audio cable
- Sport nylon braiding protects the cable against cuts and breaks caused by kinking, things falling on it or things rolling over it
- Molded strain relief for ultimate durability
- Extremely low capacitance for pure signal transparency



**ZMCW-24XMXF-6G**  
6FT GREEN WOVEN 3PIN XLR MALE TO 3 PIN XLR FEMALE

- 24 gauge pro audio cable
- Sport nylon braiding protects the cable against cuts and breaks caused by kinking, things falling on it or things rolling over it
- Molded strain relief for ultimate durability
- Extremely low capacitance for pure signal transparency



**ZMCW-24XMXF-6O**  
6FT ORANGE WOVEN 3PIN XLR MALE TO 3 PIN XLR FEMALE

- 24 gauge pro audio cable
- Sport nylon braiding protects the cable against cuts and breaks caused by kinking, things falling on it or things rolling over it
- Molded strain relief for ultimate durability
- Extremely low capacitance for pure signal transparency



**ZMCW-24XMXF-10B**  
10FT BLACK WOVEN 3PIN XLR MALE TO 3 PIN XLR FEMALE

- 24 gauge pro audio cable
- Sport nylon braiding protects the cable against cuts and breaks caused by kinking, things falling on it or things rolling over it
- Molded strain relief for ultimate durability
- Extremely low capacitance for pure signal transparency



PRO AUDIO CABLES



**ZMCW-24XMXF-10G**

- 10Ft GREEN WOVEN 3PIN XLR MALE TO 3 PIN XLR FEMALE
- 24 gauge pro audio cable
  - Sport nylon braiding protects the cable against cuts and breaks caused by kinking, things falling on it or things rolling over it
  - Molded strain relief for ultimate durability
  - Extremely low capacitance for pure signal transparency

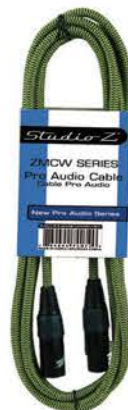

**ZMCW-24XMXF-10O**

- 10Ft ORANGE WOVEN 3PIN XLR MALE TO 3 PIN XLR FEMALE
- 24 gauge pro audio cable
  - Sport nylon braiding protects the cable against cuts and breaks caused by kinking, things falling on it or things rolling over it
  - Molded strain relief for ultimate durability
  - Extremely low capacitance for pure signal transparency



**ZMCW-24XMXF-25B**

- 25Ft BLACK WOVEN 3PIN XLR MALE TO 3 PIN XLR FEMALE
- 24 gauge pro audio cable
  - Sport nylon braiding protects the cable against cuts and breaks caused by kinking, things falling on it or things rolling over it
  - Molded strain relief for ultimate durability
  - Extremely low capacitance for pure signal transparency

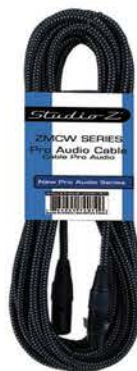

**ZMCW-24XMXF-25G**

- 25Ft GREEN WOVEN 3PIN XLR MALE TO 3 PIN XLR FEMALE
- 24 gauge pro audio cable
  - Sport nylon braiding protects the cable against cuts and breaks caused by kinking, things falling on it or things rolling over it
  - Molded strain relief for ultimate durability
  - Extremely low capacitance for pure signal transparency



**ZMCW-24XMXF-25O**

- 25Ft ORANGE WOVEN 3PIN XLR MALE TO 3 PIN XLR FEMALE
- 24 gauge pro audio cable
  - Sport nylon braiding protects the cable against cuts and breaks caused by kinking, things falling on it or things rolling over it
  - Molded strain relief for ultimate durability
  - Extremely low capacitance for pure signal transparency



**ZMT-8XMXF-16BP**

- MULTI-TRACK 8 CHANNELS SNAKE
- 16ft 8 channel snake 3 pin male XLR to 3 pin XLR female
  - 24 gauge pro audio cable
  - Snake cables provide connectivity for studios, stage rigs, and PA systems
  - Channel identification markings
  - Eliminate messy, expensive patch cables
  - Durable yet flexible, black PVC outer jacket



**ZMT-8XMXF-33BP**

- MULTI-TRACK 8 CHANNELS SNAKE
- 33ft 8 channel snake 3 pin male XLR to 3 pin XLR female
  - 24 gauge pro audio cable
  - Snake cables provide connectivity for studios, stage rigs, and PA systems
  - Channel identification markings
  - Eliminate messy, expensive patch cables
  - Durable yet flexible, black PVC outer jacket



**ZPC-24D14D14-3**

- DUAL HEAD PRO AUDIO CABLE
- 3ft dual 1/4" to dual 1/4" heavy-duty
  - 24 gauge pro audio cable
  - Low resistance and maximum signal transfer
  - Durable yet flexible, black PVC outer jacket
  - Heavy-duty metal shell connectors for a reliable connection



**ZPC-24D14D14-6**

- DUAL HEAD PRO AUDIO CABLE
- 6ft dual 1/4" to dual 1/4" heavy-duty
  - 24 gauge pro audio cable.
  - Low resistance and maximum signal transfer
  - Durable yet flexible, black PVC outer jacket
  - Heavy-duty metal shell connectors for a reliable connection



**ZPC-24D14SD14S3**

- DUAL HEAD PRO AUDIO CABLE
- 3ft dual 1/4" TRS Stereo to dual 1/4" TRS Stereo heavy-duty
  - 24 gauge pro audio cable
  - Low resistance and maximum signal transfer
  - Durable yet flexible, black PVC outer jacket
  - Heavy-duty metal shell connectors for a reliable connection



**ZPC-24D14SD14S6**

- DUAL HEAD PRO AUDIO CABLE
- 6ft dual 1/4" TRS Stereo to dual 1/4" TRS Stereo heavy-duty
  - 24 gauge pro audio cable
  - Low resistance and maximum signal transfer
  - Durable yet flexible, black PVC outer jacket
  - Heavy-duty metal shell connectors for a reliable connection





**ZPC-24RCAD14-6**

- 6Ft MALE DUAL RCA PLUG TO DUAL 1/4" MALE PLUG
- 24 gauge pro audio cable
  - Heavy duty metal shell connectors for reliable connection
  - Gold plated RCA head for superior sound transfer
  - Molded strain relief for ultimate durability
  - Durable yet flexible, black PVC outer jacket



**ZPC-24RCAD14-10**

- 10Ft MALE DUAL RCA PLUG TO DUAL 1/4" MALE PLUG
- 24 gauge pro audio cable
  - Heavy duty metal shell connectors for reliable connection
  - Gold plated RCA head for superior sound transfer
  - Molded strain relief for ultimate durability
  - Durable yet flexible, black PVC outer jacket



**ZPC-24XM14S-3**

- 3FT 3PIN XLR MALE TO 1/4" TRS STEREO MALE PLUG
- 24 Gauge Pro Audio Cable
  - Microphone Cable with Nickel Connector
  - Extremely Low Capacitance for Pure Signal Transparency
  - Molded Strain Relief for Ultimate Durability
  - Durable yet Flexible, Black PVC Outer Jacket



**ZPC-24XM14S-6**

- 6FT 3PIN XLR MALE TO 1/4" TRS STEREO MALE PLUG
- 24 Gauge Pro Audio Cable
  - Microphone Cable with Nickel Connector
  - Extremely Low Capacitance for Pure Signal Transparency
  - Molded Strain Relief for Ultimate Durability
  - Durable yet Flexible, Black PVC Outer Jacket



**ZPC-24XMRCA-6**

- 6Ft 3PIN XLR FEMALE TO 1/4" MALE PLUG
- 24 gauge pro audio cable
  - Microphone cable with nickel connector
  - Extremely low capacitance for pure signal transparency
  - Molded strain relief for ultimate durability
  - Durable yet flexible, black PVC outer jacket



**ZPC-24XF14M-3**

- 3FT 3PIN XLR FEMALE TO 1/4" MALE PLUG
- 24 gauge pro audio cable
  - Microphone cable with nickel connector
  - Extremely low capacitance for pure signal transparency
  - Molded strain relief for ultimate durability
  - Durable yet flexible, black PVC outer jacket



**ZPC-24XM14S-10**

- 10FT 3PIN XLR MALE TO 1/4" TRS STEREO MALE PLUG
- 24 Gauge Pro Audio Cable
  - Microphone Cable with Nickel Connector
  - Extremely Low Capacitance for Pure Signal Transparency
  - Molded Strain Relief for Ultimate Durability
  - Durable yet Flexible, Black PVC Outer Jacket



**ZPC-24XM14S-25**

- 25FT 3PIN XLR MALE TO 1/4" TRS STEREO MALE PLUG
- 24 Gauge Pro Audio Cable
  - Microphone Cable with Nickel Connector
  - Extremely Low Capacitance for Pure Signal Transparency
  - Molded Strain Relief for Ultimate Durability
  - Durable yet Flexible, Black PVC Outer Jacket



**ZPC-24XF14M-6**

- 6Ft 3PIN XLR FEMALE TO 1/4" MALE PLUG
- 24 gauge pro audio cable
  - Microphone cable with nickel connector
  - Extremely low capacitance for pure signal transparency
  - Molded strain relief for ultimate durability
  - Durable yet flexible, black PVC outer jacket



**ZPC-24XF14M-10**

- 10Ft 3PIN XLR FEMALE TO 1/4" MALE PLUG
- 24 gauge pro audio cable
  - Microphone cable with nickel connector
  - Extremely low capacitance for pure signal transparency
  - Molded strain relief for ultimate durability
  - Durable yet flexible, black PVC outer jacket



**ZPC-Y14S14DMN-3**

- 3FT Y-ADAPTER 1/4" TRS STEREO MALE TO DUAL 1/4" TRS STEREO MALE
- 24 Gauge Pro Audio Cable
  - Allows you to Connect One 1/4" TRS Male to Two 1/4" Male Outputs
  - Low Resistance for Maximum Signal Transfer
  - Heavy-Duty Metal Shell Connectors for a Reliable Connection



**ZPC-Y14S14DS-3**

- 3FT Y-ADAPTER 1/4" TRS STEREO MALE TO DUAL 1/4" TRS STEREO MALE
- 24 Gauge Pro Audio Cable
  - Allows you to Connect One 1/4" TRS Male to Two 1/4" TRS Male Outputs
  - Low Resistance for Maximum Signal Transfer
  - Heavy-Duty Metal Shell Connectors for a Reliable Connection





**ZP-XLRFXLR-1.5**

1.5FT 3PIN XLR FEMALE TO XLR FEMALE CABLE WITH NICKEL CONNECTOR

- Extremely Low Capacitance for Pure Signal Transparency
- Molded Strain Relief for Ultimate Durability
- Durable yet Flexible, Black PVC Outer Jacket



**ZP-YXLRF14D**

6" Y-ADAPTER 3PIN XLR FEMALE TO DUAL 1/4" TRS STEREO MALE PLUG

- Low Resistance for Maximum Signal Transfer
- Allows you to Connect One XLR Female Audio Input to Two XLR Male Outputs
- Molded Strain Relief for Ultimate Durability
- Gold-Plated Plug for Superior Sound Transfer



**ZP-YXLRM14D**

6" Y-ADAPTER 3PIN XLR MALE TO DUAL 1/4" TRS STEREO MALE PLUG

- Low Resistance for Maximum Signal Transfer
- Allows you to Connect One XLR Female Audio Input to Two XLR Male Outputs
- Molded Strain Relief for Ultimate Durability
- Gold-Plated Plug for Superior Sound Transfer



**ZP-YXLRFXLRMD-1**

1FT Y-ADAPTER 3PIN XLR FEMALE TO DUAL 3 PIN XLR MALE

- Allows you to Connect One XLR Female audio Input to Two XLR Male Outputs
- Molded Strain Relief for Ultimate Durability
- Heavy-Duty Metal Shell Connectors for a Reliable Connection



**ZP-YXLRFXLRMD-3**

3FT Y-ADAPTER 3PIN XLR FEMALE TO DUAL 3 PIN XLR MALE

- Allows you to Connect One XLR Female Audio Input to Two XLR Male Outputs
- Molded Strain Relief for Ultimate Durability
- Heavy-Duty Metal Shell Connectors for a Reliable Connection



**ZP-YXLRMXLRFD-1**

1FT Y-ADAPTER 3PIN XLR MALE TO DUAL 3 PIN XLR FEMALE PRO AUDIO CABLE

- Allows you to Split One XLR Male to Two XLR Females
- Molded Strain Relief for Ultimate Durability
- Heavy-Duty Metal Shell Connectors for a Reliable Connection



**ZP-YXLRMXLRFD-3**

3FT Y-ADAPTER 3PIN XLR MALE TO DUAL 3 PIN XLR FEMALE PRO AUDIO CABLE

- Allows you to Split One XLR Male to Two XLR Females
- Molded Strain Relief for Ultimate Durability
- Heavy-Duty Metal Shell Connectors for a Reliable Connection



**ZPC-24XF14M-25**

25FT 3PIN XLR FEMALE TO 1/4" MALE PLUG

- 24 Gauge Microphone Cable with Nickel Connector
- Extremely Low Capacitance for Pure Signal Transparency
- Molded Strain Relief for Ultimate Durability
- Durable yet Flexible, Black PVC Outer Jacket



**ZPC-DXM35-10**

DUAL XLR MALE TO 3.5 MALE STEREO

- 10FT Pro Audio Cable
- Durable yet Flexible, Black PVC Outer Jacket
- Oxygen-Free Cable



**ZPC-XM35-10**

XLR MALE TO 3.5 STEREO RIGHT ANGLE PLUG

- 10FT Microphone Cable
- Durable yet Flexible, Black PVC Outer Jacket



**ZPC-Y35S14DMN-6**

"Y" CABLE 3.5MM STEREO TO DUAL 1/4" MONO

- 6FT Pro Audio Cable
- Durable yet Flexible, Black PVC Outer Jacket



ZDMX-3XLRMF-12B

3 Pin XLR Male to XLR Female DMX Cable

- 12"
- Premium Jacket Materials Provide Ease of Handling and Long Service Life
- Bright Nickel-Plated Connectors for Long Term Good Looks and Conductivity
- 24 AWG Oxygen-free Copper Stranded Conductors for Maximum Signal Transfer



ZDMX-3XLRMF-20B

3 Pin XLR Male to XLR Female DMX Cable

- 20"
- Premium Jacket Materials Provide Ease of Handling and Long Service Life
- Bright Nickel-Plated Connectors for Long Term Good Looks and Conductivity
- 24 AWG Oxygen-Free Copper Stranded Conductors for Maximum Signal Transfer



ZDMX-3XLRMF-30B

3 Pin XLR Male to XLR Female DMX Cable

- 30"
- Premium Jacket Materials Provide Ease of Handling and Long Service Life
- Bright Nickel-Plated Connectors for Long Term Good Looks and Conductivity
- 24 AWG Oxygen-Free Copper Stranded Conductors for Maximum Signal Transfer



ZDMX-5XLRMF-12B

5 Pin XLR Male to XLR Female DMX Cable

- 12"
- Premium Jacket Materials Provide Ease of Handling and Long Service Life
- Bright Nickel-Plated Connectors for Long Term Good Looks and Conductivity
- 24 AWG Oxygen-Free Copper Stranded Conductors for Maximum Signal Transfer



ZDMX-5XLRMF-20B

5 Pin XLR Male to XLR Female DMX Cable

- 20"
- Premium Jacket Materials Provide Ease of Handling and Long Service Life
- Bright Nickel-Plated Connectors for Long Term Good Looks and Conductivity
- 24 AWG Oxygen-Free Copper Stranded Conductors for Maximum Signal Transfer



ZDMX-5XLRMF-30B

5 Pin XLR Male to XLR Female DMX Cable

- 30"
- Premium Jacket Materials Provide Ease of Handling and Long Service Life
- Bright Nickel-Plated Connectors for Long Term Good Looks and Conductivity
- 24 AWG Oxygen-Free Copper Stranded Conductors for Maximum Signal Transfer



SZC-1207BW

PROFESSIONAL ABS PA LOUD

- Woofer: 12"
- Voice Coil: 1.5"
- Magnet: 20 Oz
- Tweeter: 2.5" Titanium Driver
- Max. Power: 2500 Watts
- Voltage: 115/230V
- 12V 4.0Ah Rechargeable Battery Included
- Impedance: 4 Ohms
- Sensitivity: 94dB
- Frequency Response: 70Hz~20KHz
- LED Screen + Memory Stick Host + Wireless Music Stream + Remote Control
- Line Input: RCA/AUX
- Wheels and handle for easy transportation



LED LIGHTING



SZC-1500

PROFESSIONAL ABS LOUDSPEAKER

- Woofer: 15"
- Voice Coil: 2"
- Magnet: 40 Oz
- Tweeter: 2.5" Titanium Driver
- Maximum Power: 3500 Watts
- Voltage: 115/230V
- Impedance: 8 Ohms
- Sensitivity: 95dB
- Frequency Response: 45Hz~20KHz
- LED Screen+Memory Stick Host+Wireless Music Stream +Remote Control
- Speaker Output for a Passive Enclosure
- Line Input: RCA
- Wheels and Handle for Easy Transportation

3000 WATTS

LED LIGHTING



INCLUDED



MEMORY STICK



WIRELESS MUSIC STREAM

15" WOOFER



SZC-1507BW

PROFESSIONAL ABS LOUDSPEAKER

- Woofer: 15"
- Voice Coil: 1.5"
- Magnet: 20 Oz
- Tweeter: 2.5" Titanium Driver
- Maximum Power: 3000 Watts
- Voltage: 115/230V
- 12V 4.5Ah Rechargeable Battery Included
- Impedance: 4 Ohms
- Sensitivity: 95dB
- Frequency Response: 60Hz~20KHz
- LED Screen+Memory Stick Host+Wireless Music Stream+Remote Control
- Line Input: RCA/AUX
- Wheels and Handle for Easy Transportation



MEMORY STICK



WIRELESS MUSIC STREAM



RECHARGEABLE BATTERY

3000 WATTS

LED LIGHTING

15" WOOFER



WIRELESS MIC INCLUDED



## SZC-2010

## 4 CHANNEL 10" PA SYSTEM WITH MICROPHONES AND CABLES AMPLIFIER

- Input Channels: 4 Mic (XLR)/(1/4" Phono Jack) 1 RCA
- Output Power: 2x100Watts
- THD:<0.1%(@ 1KHz 10W) Tone Controls
- Bass: 100Hz±12dB
- Treble: 10KHz±12dB
- Frequency Response: 20Hz-20KHz±1dB
- Power: 115V/60Hz or 230V/50Hz
- Dimensions(WxDxH): 15.4" x 12.4" x 9.7"
- Weight: 17.3lbs (7.8Kg)
- Treble Bass Effect Volume on each Channel, Master Section, CD/TAPE Effect Master on the Rear Panel, CD/TAPE-Input (RCA Jack) on the Rear Panel
- Accessories: Microphone x 2, Microphone Cable x 2, Speaker Cable x 2

## BOX

- 2-Way Configuration with Passive Filter, 6" x 12" horn tweeter 10" Woofer
- Frequency Response: 60Hz-18KHz
- Nominal Impedance: 8 Ohm
- Rated Power: 200RMS
- Maximum Power: 400 Watts
- Sensitivity: 95dB(1 Watt/1 Meter)
- Max SPL: 122dB / 1m
- Connectors: 2 x SPK4
- Dimensions: 755 x 380 x 845mm
- Net Weight: 20Kg



## SZC-2012

## 6 CHANNEL 12" PA SYSTEM WITH MICROPHONES AND CABLES AMPLIFIER

- Input Channels: 6 Mic (XLR)/(1/4" Phono Jack) 1 RCA
- Output Power: 2x150Watts
- THD:<0.1%(@ 1KHz 10W) Tone Controls
- Bass: 100Hz±12dB
- Treble: 10KHz±12dB
- Frequency Response: 20Hz-20KHz±1dB
- Power: 115V/60Hz or 230V/50Hz
- Dimensions(WxDxH): 17.7" x 12.4" x 9.7"
- Weight: 18lbs (8.2Kg)
- Treble Bass Effect Volume on each Channel, Master Section, CD/TAPE Effect Master on the Rear Panel, CD/TAPE-Input (RCA Jack) on the Rear Panel
- Accessories: Microphone x 2, Microphone Cable x 2, Speaker Cable x 2

## BOX

- 2-Way Configuration with Passive Filter, 6" x 12" horn tweeter 12" Woofer
- Frequency Response: 35Hz-27KHz
- Nominal Impedance: 8 Ohm
- Rated Power: 300RMS
- Maximum Power: 600 Watts
- Sensitivity: 95dB(1 Watt/1 Meter)
- Max SPL: 122dB / 1m
- Connectors: 2 x SPK4
- Dimensions: 845 x 400 x 910mm
- Net Weight: 24Kg



## SZC-2015

## 8 CHANNEL 15" PA SYSTEM WITH MICROPHONES AND CABLES AMPLIFIER

- Input Channels: 8 Mic (XLR)/(1/4" Phono Jack) 1 RCA
- Output Power: 2x200Watts
- THD:<0.1%(@ 1KHz 10W) Tone Controls
- Bass: 100Hz±15dB
- Treble: 10KHz±15dB
- Frequency Response: 20Hz-20KHz±1dB
- Power: 115V/60Hz or 230V/50Hz
- Dimensions(WxDxH): 20.5" x 12.4" x 9.7"
- Weight: 16.5lbs (7.5Kg)
- Treble Bass Effect Volume on each Channel, Master Section, CD/TAPE Effect Master on the Rear Panel, CD/TAPE-Input (RCA Jack) on the Rear Panel
- Accessories: Microphone x 2, Microphone Cable x 2, Speaker Cable x 2

## BOX

- 2-Way Configuration with Passive Filter, 5" x 15" horn tweeter 15" Woofer
- Frequency Response: 50Hz-18KHz
- Nominal Impedance: 8 Ohm
- Rated Power: 400RMS
- Maximum Power: 800 Watts
- Sensitivity: 96dB(1 Watt/1 Meter)
- Max SPL: 124dB / 1m
- Connectors: 2 x 1/4" Jack



## SPA-1000BT

## DIGITAL KARAOKE STEREO AMPLIFIER

- 15 Watts x 2, 8 Ohm / 20 Watts x 2, 4 Ohms
- Wireless Music Stream Ability
- USB/SD/MMC Card Reader Function with Display
- Remote Control for USB/SD/MMC Inputs
- FM Radio Function
- 2 Mic Input Jacks
- Master Channel Volume/Bass/Treble/Balance Control
- Mic Channel Volume/Echo Control
- 110V-220V Switchable
- Dimensions: 10.2" x 8.3" x 3.1" (260 x 210 x 80 mm)
- Weight: 2.3Kg (5.1Lbs)



## SPA-1200BT

## HYBRID DIGITAL RECEIVER AMPLIFIER

- 60W x 2, 8 Ohm/ 100W x 2, 4 Ohm
- Master Channel Volume/Bass/Treble/Balance Control
- 2 MIC Input with Volume/Bass/Treble/Echo Control
- Digital AM/FM Tuner with Scan and Auto Store Function
- 30 AM and 30 FM Stations Storage
- USB Reader Function with Play/Pause/Prev/Next Control
- MP3 Input Jack with Cable
- A/B Speaker Output
- AUX/Record Output
- 110V/220V Switchable
- Dimensions: 16.9" 12.2" x 4.7"
- Weight: 11.2 Lbs



Perfect for Karaoke  
and Commercial  
Entertainment System

## SPA-2000BT

## HYBRID DIGITAL RECEIVER AMPLIFIER

- 75W x 2, 8 Ohm / 90W x 2, 4 Ohm
- AM/FM Quartz Synthesized Tuner
- Auto Station Seek
- IPOD/MP3 Input With Cable (3.5mm to 3.5mm Cable, Black)
- USB Reader Function
- Inputs: RCA (2 Audio Sources)
- Outputs: Banana Binding Post
- 1 RCA Dedicated for Record Line Output
- 2 Mono RCA Dedicated for Subwoofer Output
- 1 RCA Dedicated for Preamp Output
- Separate Gain Control for Preamp and Subwoofer
- Digital Fluorescent Output Display Meter
- Removable Rack-Mount Brackets
- Dimensions: 19"(W) x 3.5" (H) x 13.2"(D)
- Weight: 15.9 LBS
- 110-220 Switchable



SPA-3070BPA

DIGITAL RECEIVER P.A. AMPLIFIER

- 100 Watts x 2, 8 Ohm / 130 Watts x 2, 4 Ohm.
- 8 Ohm and 70V/100V output terminals for PA speakers.
- 1 RCA dedicated for record line output.
- 2 Mono RCA dedicated for subwoofer output.
- Separate gain control for preamp and subwoofer output.
- AUX MP3 input.
- USB reader function.
- Wireless music stream ability.
- Removable rack-mount brackets.
- AM/FM quartz synthesized tuner.
- Auto station scan and store.
- 60 radio station storage.
- Full function remote control.
- 110V-220V switchable.
- Dimensions (W x H x D):  
19" x 3.5" x 13.2"  
(483 x 89 x 335 mm).
- Weight: 7.7Kg (17Lbs).



DUAL  
10 BAND

SEQ-150

DUAL 10 BAND STEREO GRAPHIC EQUALIZER

- Dual VU Meters Level Monitor
- Dual 10 Bands Equalizer with Blue LEDs
- 2 RCA Line Input / 2 RCA Line Output
- 2 RCA Line Output for REC
- VFD Display Screen
- Bass/Midrange/High Gain Control
- Left/Right Channel Volume Gain Control
- 110/220V Power Switch
- Removable Rack Mount Brackets
- Dimensions: 19"(W) x 9.3"(H) x 2.2"(D)
- Weigh: 5.1 lbs



SPA-3000BT

HYBRID DIGITAL RECEIVER AMPLIFIER

- 100W x 2, 8 Ohm / 130W x 2, 4 Ohm
- AM/FM Quartz Synthesized Tuner
- Auto Station Seek and Store ( 60 Radio Station Storage)
- Full Function Remote Control
- IPOD/MP3 Input With Cable (3.5mm to 3.5mm Cable, White)
- USB Reader Function
- Inputs: RCA (2 Audio Sources)
- Outputs: Banana Binding Post
- Hybrid digital Receiver Amplifier
- 1 RCA Dedicated for Record Line Output
- 2 Mono RCA Dedicated for Subwoofer Output
- 1 RCA Dedicated for Preamp Output
- Separate Gain Control for Preamp and Subwoofer
- Digital Fluorescent Output Display Meter
- Removable Rack-Mount Brackets
- Dimensions: 19"(W) x 3.5" (H) x 13.2"(D)
- Weight: 16.8 LBS
- 110-220 Switchable



STNR-100

AM/FM PLL TUNER / CLOCK WITH BUILT IN ALARM

- 60 (AM + FM) Radio Station Storage
- Tuning/ Pre/ Next/ Auto Scan/ Store and
- 1-10+ Select Keys for Tuner
- Rack Mount Brackets
- 110-220V Switchable
- Clock Display (AM-PM) can Start or Off at Set Time
- Remote Control
- Dimensions: 19"(W) x 9.4"(H) x 1.6"(D)
- Weight: 3.5 lbs



**SPA-140SEL**

4-WAY DUAL-SOURCE, IMPEDANCE-MATCHING  
SPEAKER SELECTOR WITH ZONE VOLUME CONTROLS

- 900W Total Music Power
- 300W Total RMS Continuous Power Handling
- Heavy Duty Transformer Based Impedance Matching System Protects against Power Loss
- Left and Right Channels are Completely Isolated for Safe Operation with any Amplifier, even Bridged Amplifiers
- Quick Connect Terminals will Accommodate 16 to 22Ga Wire
- Can be Connected to Two Separate Amplifiers via A/B Switch
- Circuit Breaker Protected

**SPA-160SEL**

6-WAY DUAL-SOURCE, IMPEDANCE-MATCHING  
SPEAKER SELECTOR WITH ZONE VOLUME CONTROLS

- 900W Total Music Power
- 300W Total RMS Continuous Power Handling
- Heavy Duty Transformer Based Impedance Matching System Protects against Power Loss
- Left and Right Channels are Completely Isolated for Safe Operation with any Amplifier, even Bridged Amplifiers
- Quick Connect Terminals will Accommodate 16 to 22Ga Wire
- Can be Connected to Two Separate Amplifiers via A/B Switch
- Circuit Breaker Protected

**SZ-6200U**

6 CHANNEL PORTABLE AMPLIFIER MIXER

- 6 MIC/LINE mono input channels from separate input sockets
- Built in Digital delay input and output
- Super musical 2-band EQ on each mono input channel
- Super musical 7-band EQ for main output channel
- Built in USB/MMC/MP3 Player with LCD display
- Built in FM/Wireless music stream /Voice Prompt
- Power Supply: 115/230V AC, 50/60Hz
- Amplifier: CLASS AB
- Output: 4 Ohm

**SZ-8200U**

8 CHANNEL PORTABLE AMPLIFIER MIXER

- 8 MIC/LINE mono input channels from separate input sockets
- Built in Digital delay input and output
- Super musical 2-band EQ on each mono input channel
- Super musical 7-band EQ for main output channel
- Built in USB/MMC/MP3 Player with LCD display
- Built in FM/Wireless music stream /Voice Prompt
- Power Supply: 115/230V AC, 50/60Hz
- Amplifier: CLASS AB
- Output: 4 Ohm



DB-01

PROFESSIONAL SINGLE-CHANNEL PASSIVE DIRECT BOX

- Input Attenuation: Switchable (0dB, -20dB, -40dB)
- Instrument Input: 50K Unbalanced TS Jack
- Parallel (Link) Out: 50K Unbalanced TS Jack
- Balanced Output: 600Ω Balanced XLR Jack
- Ground Lift: Switchable Ground lift
- Construction: All Steel Chassis
- Dimensions: 4.7" x 3" x 1.8" (120 x 76.5 x 45mm)



This box lets you connect an unbalanced, high impedance signal to a balanced, low-impedance input. It is most often used for plugging a keyboard, electric guitar, or electric bass guitar directly into a mixing console's microphone - level input. It can also be used in DJ applications.

DB-02

PROFESSIONAL DUAL-CHANNEL PASSIVE DIRECT BOX

- Input Attenuation: Switchable (0dB, -20dB, -40dB)
- Instrument Input: 50K Unbalanced TS Jack
- Parallel (Link) Out: 50K Unbalanced TS Jack
- Balanced Output: 600Ω Balanced XLR Jack
- Ground Lift: Switchable Ground Lift
- Construction: All Steel Chassis
- Dimensions: 5.3" x 3.7" x 1.6" (134 x 95 x 40mm)



This box lets you connect an unbalanced, high impedance signal to a balanced, low-impedance input. It is most often used for plugging a keyboard, electric guitar, or electric bass guitar directly into a mixing console's microphone - level input. It can also be used in DJ applications.

STZP-800

8" RECHARGEABLE SPEAKER

- 10" Woofer
- 1" Horn
- With USB / TF / FM / Wireless Music Stream
- AUX Input
- Microphone Input
- Controller Board on the Top
- LED Display Screen
- Remote Control Included
- (1) Wired Mic Included
- Impedance: 4 ohm
- Max Power: 1000W
- Weight: 3.4 Kg (7.5 Lbs)
- Dimensions: 11.2" x 10.2" x 18.5"



STZP-1000

10" RECHARGEABLE SPEAKER

- 10" Woofer
- 1" Horn
- With USB / TF / FM / Wireless Music Stream
- AUX Input
- Microphone Input
- Controller Board on the Top
- LED Display Screen
- Remote Control Included
- (1) Wired Mic Included
- Impedance: 4 ohm
- Max Power: 1000W
- Weight: 3.4 Kg (7.5 Lbs)
- Dimensions: 11.2" x 10.2" x 18.5"



STZP-400

4" PORTABLE WIRELESS SPEAKER

- Frequency: 100Hz - 18kHz
- Input Sensitivity: 550±50MV
- Charging Voltage: 5V/500MA
- Wireless Connection Distance: ≤ 10 Meters
- Battery: 3.7V ,1200mAh
- Wireless Version: Jely 2.1+1
- S/N Ratio: ≥ 75DB
- Distortion: 10%
- Drive Unit: 1 x 4"
- Supported Functions: Wireless Music Stream, USB Drive, TF Card Play, FM, LINE
- Working Time: 3 - 4 Hours



Battery is easily replaceable

STZP-525

5.25" PORTABLE WIRELESS SPEAKER

- Frequency: 100Hz - 18kHz
- Input Sensitivity: 6003100MV
- Charging Voltage: 5V/500MA
- Wireless Connection Distance: 8-12 Meters
- Battery: 3.7V ,1200mAh
- Wireless Version: Jely 2.1+1
- S/N Ratio: ≥ 60DB
- Distortion: 10%
- Drive Unit: 1 x 5.25"
- Supported Functions: Wireless Music Stream, USB Drive, TF Card Play, FM, LINE
- Working Time: 2.5 - 4 Hours



STZP-650

6.5" PORTABLE WIRELESS SPEAKER

- Use: Computer, Home, Theatre, Karaoke Player, Mobile Phone, Portable Audio Player
- Function: Aux-in, / USB Drive / SD Card / FM / Wireless Music Stream Control / Microphone Player / Remote control
- Port: Line In / USB / TF Card / Mic In / USB 5V In / Microphone Port
- Includes Wired Microphone
- Volume Control Knob
- Mic Echo Volume Control Knob
- Dancing RGB LED Light
- Working Distance: ≤10 Meters in Open Space
- Frequency Range: 200Hz - 20KHz
- Driver Unit: 6.5" x 1"
- Battery: 18650/2 x 1500mAh
- S/N Ratio: ≥ 80dB
- Charging Voltage: DC 5V (Micro USB)
- Supported Audio Formats: MP3
- Charging Time: 1.5 - 2 Hours
- Play-Back Time: 3 - 4 Hours
- Dimensions: (W x H x D): 8.3" x 12.8" x 8.3"
- Net Weight: 3.75 Lbs



PKT-421-AFB

AM/FM 2 BAND WORLD RECEIVER

- High Sensitivity Receiver
- External Earphone Jack
- 2AA Batteries (Battery Not Included)
- Unit Size: 111(H)x63(W)x23(D)mm
- Frequency Range: AM 530-1600KHz FM 87-108MHz
- WB: NA
- Speaker: Φ40mm/8Ω/0.5W
- Unit Weight: 95g
- Output Power: N/A



PRT-742-WB

AM/FM/WB 3 BAND RECEIVER

- HIGH SENSITIVITY RECEIVER
- Excellent Sound Performance
- Speaker: 3 Inch 4Ω 3W 45 Head
- External Earphone Jack
- DC 3V (UM-1 X 2)
- AC 220V/50Hz Input
- Output Power: 8W
- WB 400-550MHz
- Frequency Range: AM 530-1600KHz FM 87-108MHz
- 2D Size Battery (DC 3V) (Battery Not Included)
- Unit Size: 190(W)x110(H)x50(D)



**SDRV-KP11**

## REFLEX DRIVER

- Maximum Input Power: 100W
- Sound Pressure: 102dB±2dB
- Impedance: 8 Ohms
- Frequency Range: 2KHz – 20KHz
- Voice Coil: 1" KSV
- Magnet: 8.5 Oz.
- Common Replacement for JBL Driver

**SRDP-KP11**REPLACEMENT KAPTON VOICE COIL  
FOR SDRV-KP11

- 1" Resin Film Super Diaphragm
- 1" High Temperature Kapton Voice Coil
- Single Pack in Gift Box

**SDRV-R15**

## REFLEX DRIVER

- Maximum Input Power: 140W
- Sound Pressure: 106dB±2dB
- Impedance: 8 Ohms
- Frequency Range: 2KHz – 20KHz
- Voice Coil: 1.3" KSV
- Magnet: 12 Oz.

**SRDP-R15**REPLACEMENT KAPTON VOICE COIL  
FOR SDRV-R15

- 1.3" Resin Film Super Diaphragm
- 1.3" High Temperature Kapton Voice Coil
- Single Pack in Gift Box

**SDRV-R23**

## REFLEX DRIVER

- Maximum Input Power: 160W
- Sound Pressure: 108dB±2dB
- Impedance: 8 Ohms
- Frequency Range: 2KHz – 20KHz
- Voice Coil: 1.7" KSV
- Magnet: 33 Oz.

**SRDP-R23**REPLACEMENT KAPTON VOICE COIL  
FOR SDRV-R23

- 1.7" Resin Film Super Diaphragm
- 1.7" High Temperature Kapton Voice Coil
- Single Pack in Gift Box

**NSCE-620**

## 6" WOOFER W/ 1" ALUMINUM VOICE COIL

- 6" Paper Cone with Cloth Edge
- Frequency Response: 70-10000 Hz
- Magnet Weight: 20 Oz
- Sensitivity: 86 dB
- Voice Coil Size: 1" ASV
- Max Power: 250 W
- Impedance: 8 Ohm

**Sold Individually****NSCE-830**

## 8" WOOFER W/ 1" ALUMINUM VOICE COIL

- 8" Paper Cone with Cloth Edge
- Frequency Response: 50-5000 Hz
- Magnet Weight: 30 Oz
- Sensitivity: 89 dB
- Voice Coil Size: 1" ASV
- Max Power: 350 W
- Impedance: 8 Ohm

**Sold Individually****NSCE-1040**

## 10" WOOFER W/ 2" ALUMINUM VOICE COIL

- 10" Paper Cone with Cloth Edge
- Frequency Response: 50-4500 Hz
- Magnet Weight: 40 Oz
- Sensitivity: 88 dB
- Voice Coil Size: 2" ASV
- Max Power: 425 W
- Impedance: 8 Ohm

**Sold Individually**

**NSCE-1250**

12" WOOFER W/ 2" ALUMINUM VOICE COIL

- 12" Paper Cone with Cloth Edge
- Frequency Response: 35-5000 Hz
- Magnet Weight: 50 Oz
- Sensitivity: 92 dB
- Voice Coil Size: 2" ASV
- Max Power: 500 W
- Impedance: 8 Ohm



**Sold Individually**

**NSCE-1550**

15" WOOFER W/ 2" ALUMINUM VOICE COIL

- 15" Paper Cone with Cloth Edge
- Frequency Response: 30-3700 Hz
- Magnet Weight: 50 Oz
- Sensitivity: 92 dB
- Voice Coil Size: 2" ASV
- Max Power: 675 W
- Impedance: 8 Ohm



**Sold Individually**

**MUSICAL  
EQUIPMENT**



**MS-WB812**

**SPEAKER WALL BRACKET**

- Dimension: 11 cm
- Weight Capacity: 25 Kg
- Material: Sheet Iron
- Tilt Swivel Feature: Tilt
- Tilt: 20°
- Most 8", 10" and 12" DJ Cabinets



**MS-PE12**

**TUBE EXTENSION**

- Outer Tube (Diameter x Height): 41.7 mm x 820 mm
- Inner Tube (Diameter x Height): 35mm x 820 mm



**MSKB-91**

**MIXER AND KEYBOARD STAND**

- Adjustable Height: 20.9" - 37.8" (530-960 mm)
- Bottom Pipe: 18.1" (360 mm)
- Top Pipe: 14.2" (360 mm)
- Loading Capacity: 110 lbs (50 kg)
- Color: Black



**MAR-300**

**PROFESSIONAL MIXER STAND**

- For 18.9 x 16.9 inch (480 x 430 mm) DJ Mixer
- TILT: 45° DOWN
- Maximum DJ Mixer Weight: 60 kg (132 lbs)
- Product Parameter: H: 34.6 inch (880 mm) W: 17.6 lbs (8 kg)
- Slanting Pipe: 21.7~35.4 inch (550-900 mm)



**MS-WB1215**

**SPEAKER WALL BRACKET**

- Dimension: 11 cm
- Weight Capacity: 25 Kg
- Material: Sheet Iron
- Tilt Swivel Feature: Tilt
- Tilt: 20°
- Most 12" and 15" DJ Cabinets



**MS-PE12**

**TUBE EXTENSION**

- Outer Tube (Diameter x Height): 41.7 mm x 820 mm
- Inner Tube (Diameter x Height): 35mm x 820 mm

**MAR-LT200**

**LAPTOP BRACKET**

- Black Spray-Painted Iron
- Height & Width Adjustable
- Fix with Screwed Clamp



Clamps for DJ Flight Case



Base for DJ Table



**MSKB-100**

KEYBOARD STAND

- Adjustable Height: 26.8" ~ 39.4"
- Bottom Pipe: 25.2", Top Pipe: 16.1"
- Weight: 4.5 kg



**MSKB-101**

KEYBOARD STAND

- Adjustable Height: 23.8" ~ 39" (605~990 mm)
- Bottom Pipe: 17.9" (455 mm)
- Top Pipe: 14" (355 mm)
- Loading Capacity: 88.2 lbs (40 kg)
- Weight: 7.1Lbs (3.2 kg)



**MSKB-200**

DOUBLE KEYBOARD STAND

- Adjustable Height: 39.4" ~ 49.6"
- Bottom Pipe: 25.2", Top Pipe: 16.1"
- Weight: 5.8 kg



**MSKB-201**

KEYBOARD STAND

- Lightweight, Portable and Folds Flat for Easy Storage
- Holds 2 Full Size Electronic Keyboard Pianos
- Adjusts Height: 23.8" ~ 39"
- Adjusts Width: 17.7" ~ 31.5"
- Distance between 2 Tiers: 11.8"
- Perfect for Home Use, Churches, Display and Performance



**MS-9**

PROFESSIONAL P. A. SPEAKER STAND

- Height Adjustment Grip
- Hight: 2 5.6"- 48.0" (650- 1220 mm)
- Weight: 4.9 Lbs (2.2 kg)
- Supports up to: 110 Lbs (50 kg)
- Tube Thickness: 0.8 mm



**MS-11**

PROFESSIONAL P. A. SPEAKER STAND

- Stand with P.A. Speaker Holder
- Height Adjustment Grip
- Hight: 39.4"- 74.0" (1000 - 1880 mm)
- Weight: 8.4 Lbs (3.8 kg)
- Supports up to: 165 lbs (75 kg)
- Tube Thickness: 0.8 mm



**DS-201**

- Plastic Base for P. A. Speaker Stands



**DS-203**

- Aluminum Base for P. A. Speaker Stands



**DS-205**

- Iron Base for P. A. Speaker Stands



**DS-303**

- Base for D-11

**F-8**

- Boom Floor Stand with Die Cast Base
- Black Finished



**F-13**

- Long Boom Desk Stand Professional Series
- Black Finished



**MS-5**

- Microphone Stand with Boom Mic Holder and Height Adjustment
- Black Finished



**MS-2**

- MICROPHONE STAND
- Stand with Microphone Holder
  - Height Adjustment Grip
  - Product Parameter:  
Height: 37.8" – 55.1" (661-1680 mm)  
Weight: 9.9 lbs (4.5 kg)
  - Stage Microphone



**MS-5CHR**

MICROPHONE STAND WITH MIC HOLDER

- Adjusts Up to 6'
- Height: 31.5"~55.1"
- Weight: 3.1 lbs
- Slating Pipe: 29.5"
- Chrome Finish



**MS-6**

MICROPHONE STAND WITH BOOM MIC HOLDER

- Adjusts to Different Heights
- Height: 38.6"~66.1"
- Weight: 3.7 lbs
- Cross Pipe: 29.5"



**MS-13**

- Microphone Stand with Adjustable Angle and Height Adjustment
- Black Finished



**MSQ-57**

- Microphone Stand with Boom Mic Holder and Quick Grip Height Adjustment



**MSQ-89**

- Microphone Stand with Adjustable Angle and Quick Grip Height Adjustment



**MSMS-51**

MUSIC SHEET STAND FOLDABLE

- Height Adjustable, Foldable Legs, Lightweight, Metal Construction
- Two Section Design with Adjustable Angle Desk
- Stand Includes Wire Music Clips and Rubber Feet
- Stand Folds to 21-1/2 inches, Folding Tripod Design
- Height Adjustment to 36 inches



**MSMS-52**

FOLDABLE SHEET MUSIC STAND WITH CLIPS

- Height Adjustable, Foldable Legs, Lightweight, Metal Construction
- Two Section Design with Adjustable Angle Desk
- Stand Includes Wire Music Clips and Rubber Feet
- Stand Folds to 21-1/2 inches, Folding Tripod Design
- Height Adjustment



**MS-ITBLT**

MULTIMEDIA TABLET HOLDER FOR STANDS

- Fully Adjustable Multimedia Tablet Holder
- Pivot, Tilt, Rotate, Raise and Lower
- Pole Height: 18.5-32cm
- Accommodates Tablets from: 10.7cm to 20cm



**MS-LS101**

DJ STAND

- Universal Laptop Notebook Placement
- Rugged and Durable Metal Construction
- Convenient Sound Equipment Placement
- Quick and Easy Setup
- Lightweight, Portable and Reliable
- Tripod Floor Standing Design
- Quick and Convenient Height Adjustments
- Minimum Height: 26"
- Maximum Height: 44.1"
- Weight: 6.8 lbs
- Perfect for On-Stage or In-Studio Use
- Folds Completely for Travel and Storage
- Shelf/Plate Size: 16" x 20"
- Glossy Black Finish



**F-915**

- Height: 35-62 cm
- ARM Length: 40 cm
- Weight: 1.62 Kg
- PIG Iron Diecasting: 14mm



**F-917**

- Height: 35-55 cm
- ARM Length: 40 cm
- Weight: 2.542 Kg
- Spray Plastic: Ø180mm



**F-3**

- Desk Stand



**F-4**

- Desk Stand with Die Cast Base



**F-6**

- Desk Stand



**F-7M**

- Goose Neck Desk Stand
- 8"/21 cm



STANDS

MSG-22

A FRAME GUITAR STAND

- Height: 43 cm
- Width: 26 cm
- Weight: 1.30 kg
- Compatible with: Electric Guitars, Bass Guitars, Classic Guitars, Acoustic Guitars
- For Different Sizes: 33" , 36" , 39"



MSG-21

A FRAME GUITAR STAND

- Height: 15.4" (390 mm)
- Width: 10.2" (260 mm)
- Weight: 1.7 lbs (0.75 kg)
- Compatible with Electric Guitars, Bass Guitars, Classic Guitars and Acoustic Guitars



MSTP-105

TRUMPET STAND

- Foldaway Stand



Closed Position



TRUMPET IS NOT INCLUDED

STANDS

MS-GS 6

6 GUITAR DISPLAY STAND

- Height: 2.4M / 7.9'
- Outer Tube (Diameter x Thickness): 30mm x 1.32mm
- Central Tube (Diameter x Thickness): 25.4mm x 1.1mm
- Inner Tube (Diameter x Thickness): 20.2mm x 1.2mm



THE GUITARS SHOWN IN THE PICTURE ARE NOT INCLUDED.

MSSX-103

SAXOPHONE STAND

- Fits Alto Saxophone & Tenor Saxophone
- Foldaway Stand



Closed Position



SAXOPHONE IS NOT INCLUDED

HOLDERS



**A-1S BLK**  
EZ SLIP-IN CLAMP  
• Single Microphone Holder  
• Malleable to Fit Most Standard and Oversized Microphones  
• Black Color



**A-1S WHT**  
EZ SLIP-IN CLAMP  
• Single Microphone Holder  
• Malleable to Fit Most Standard and Oversized Microphones  
• White Color



**A-2**  
SINGLE MICROPHONE HOLDER  
• Spring Type Holder  
• Black Color



**A-3**  
SINGLE MICROPHONE HOLDER  
• Spring Type Holder  
• Black Color



**A-5**  
MICROPHONE CLIP HOLDER MIC STAND ACCESSORY  
• Small Size



**A-6**  
MICROPHONE CLIP HOLDER MIC STAND ACCESSORY  
• Large Size



**A-10**  
SLIDE TYPE HOLDER  
• Copper Screw

HOLDERS/ACCESSORIES



**BDM-3**  
SLIDE TYPE HOLDER  
• Single Microphone Holder  
• Malleable to Fit Most Standard and Oversized Microphones  
• Black Color

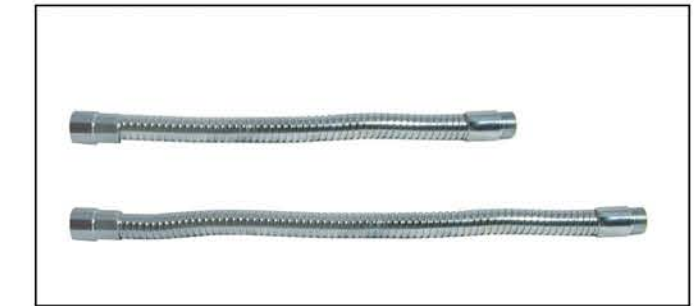

**D-8 (13)**  
**D-8-19 (19)**  
GOOSENECK BASE  
• Metal

**A-52**  
2 MIC HOLDER  
• Break Resistant  
• Fits Standard Microphone Stands  
• For 1" and Large Handles  
• Black Color



**A-54**  
4 MIC HOLDER  
• Break Resistant  
• Fits Standard Microphone Stands  
• For 1" and Large Handles  
• Black Color



**D-14**  
MALE GOOSENECK BASE  
• Metal



**D-15**  
FEMALE GOOSENECK BASE  
• Metal



**F-SCREW**  
ON-STAGE STAND MIC SCREW ADAPTOR  
• 5/8 Male to 3/8 Female Screw Adaptor for Use with Mic Stands that have European 3/8" Threads  
• Sold Individually

MACHINE HEADS

AOD-017A (W)

GUITAR REPLACEMENT TUNING KEYS  
 • Nickel-Plated Tuning Keys (Short)  
 • Steel Pegs



AOD-018C (W)

GUITAR REPLACEMENT TUNING KEYS  
 • Nickel-Plated Tuning Keys (Long)  
 • Plastic Pegs



AOD-019C (W)

GUITAR REPLACEMENT TUNING KEYS  
 • Gold-Plated Tuning Keys (Long)  
 • Plastic Pegs



AOD-017AP

• Machine Head

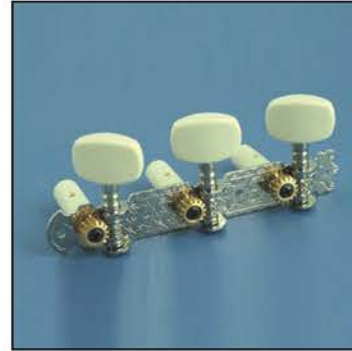

AOD-018CP

• Nickel 3 Machine Head (Long)



AOD-019CP

• Gold 3 Machine Head (Long)

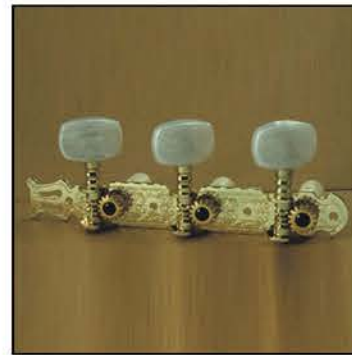

AS-016P

• Single Chrome-Plated Locked Machine Head



AOS-020B1P

• Gold Plated 3 Machine Head (Short)



GUITAR CAPOS



A007A/BK  
 GUITAR CAPO  
 • Acoustic



A007B  
 CLASSIC GUITAR CAPO  
 • Metal Finish



A007C/BK  
 GUITAR CAPO  
 • Classical



A007D/SL-A  
 ACOUSTIC GUITAR CAPO  
 • with Polished Finish



A007G/PC  
 GUITAR CAPO



A007H/PB  
 HARNESS NISSAN 2002-UP



A007D/SL-C  
 CLASSIC GUITAR CAPO  
 • with Polished Finish

GUITAR STRINGS

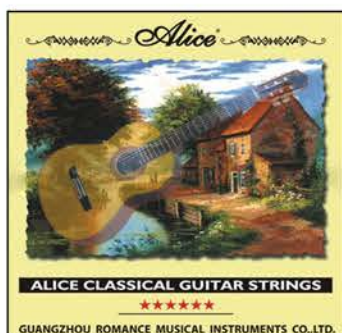

A106-H  
A106-H-1  
A106-H-2  
A106-H-3  
A106-H-4  
A106-H-5  
A106-H-6

CLASSICAL GUITAR STRING  
• Plastic Bag

A106-H	KIT		
A106-H-1	Clear Nylon	.0285	0.72
A106-H-2	Clear Nylon	.0325	0.83
A106-H-3	Clear Nylon	.041	1.04
A106-H-4	Silver-Plated Copper Wound	.030	0.76
A106-H-5	Silver-Plated Copper Wound	.036	0.91
A106-H-6	Silver-Plated Copper Wound	.044	1.12

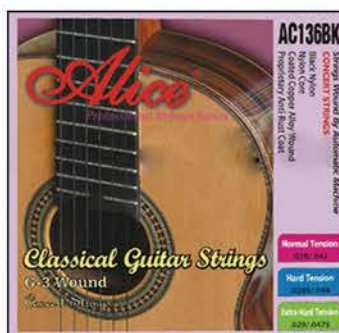

AC136BK-N  
CLASSICAL GUITAR STRING  
• Black Nylon  
• Nylon Core  
• Coated Copper Wound  
• Proprietary Anti-Rust Coat

**AC136BK-N**  
KIT

Black Nylon	.028	0.71
Black Nylon	.032	0.81
Coated Copper Alloy Wound	.025	0.63
Coated Copper Alloy Wound	.029	0.74
Coated Copper Alloy Wound	.035	0.89
Coated Copper Alloy Wound	.043	1.09

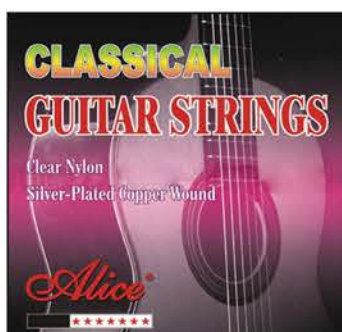

A107-N  
CLASSICAL GUITAR STRING  
• Plastic Bag

**A107-N**  
KIT

Clear Nylon	.028	0.71
Clear Nylon	.032	0.81
Clear Nylon	.040	1.02
Silver-Plated Copper Alloy Wound	.030	0.76
Silver-Plated Copper Alloy Wound	.035	0.89
Silver-Plated Copper Alloy Wound	.043	1.09



A107BK-H  
GUITAR STRING

		inch	mm
<b>E-1st</b>	Black Nylon	.0285	0.72
<b>B-2nd</b>	Black Nylon	.0325	0.83
<b>G-3rd</b>	Black Nylon	.041	1.04
<b>D-4th</b>	Gold-Plated Copper Alloy Wound	.030	0.76
<b>A-5th</b>	Gold-Plated Copper Alloy Wound	.036	0.91
<b>E-6th</b>	Gold-Plated Copper Alloy Wound	.044	1.12

		inch	mm
<b>B</b>	Black Nylon	.022	0.56
<b>F</b>	Black Nylon	.028	0.71
<b>D</b>	Black Nylon	.032	0.81
<b>A</b>	Black Nylon	.022	0.56



AU02  
UKULELE STRING



GUITAR STRINGS

A2012  
• Acoustic Guitar Stainless Steel  
• Steel Core  
• Coated Copper Alloy Wound

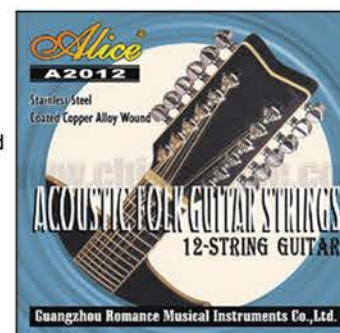

**A2012** KIT

	inch	mm
Stainless Steel	.010	0.25
Stainless Steel	.010	0.25
Stainless Steel	.014	0.36
Stainless Steel	.014	0.36
Coated Copper Alloy Wound	.022	0.56
Stainless Steel	.008	0.20
Coated Copper Alloy Wound	.030	0.76
Stainless Steel	.012	0.30
Coated Copper Alloy Wound	.040	1.02
Stainless Steel	.018	0.46
Coated Copper Alloy Wound	.050	1.27
Coated Copper Alloy Wound	.026	0.66

A306-SL (Complete Kit)  
A306-SL-1  
A306-SL-2  
A306-SL-3  
A306-SL-4  
A306-SL-5  
A306-SL-6  
A307-SL-3

• Acoustic Guitar, Stainless Steel, Silver Plated, Copper Wound, Extra-Light strings

A306-SL		inch	mm
E-1st	Stainless Steel	.011	0.25
B-2nd	Stainless Steel	.015	0.38
G-3rd	Silver-Plated Copper Alloy Wound	.024	0.61
D-4th	Silver-Plated Copper Alloy Wound	.032	0.81
A-5th	Silver-Plated Copper Alloy Wound	.042	1.07
E-6th	Silver-Plated Copper Alloy Wound	.052	1.32

A307-SL		inch	mm
E-1st	Stainless Steel	.011	0.25
B-2nd	Stainless Steel	.015	0.38
G-3rd	Silver-Plated Copper Alloy Wound	.024	0.61
D-4th	Silver-Plated Copper Alloy Wound	.032	0.81
A-5th	Silver-Plated Copper Alloy Wound	.042	1.07
E-6th	Silver-Plated Copper Alloy Wound	.052	1.32

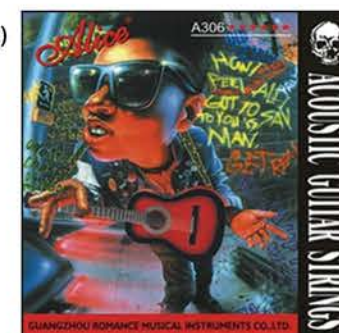

A308-SL (Complete Kit)  
A308-SL-1  
A308-SL-2  
A308-SL-3  
• Acoustic Guitar, Stainless Steel, Silver Plated, Copper Wound, Extra-Light Strings

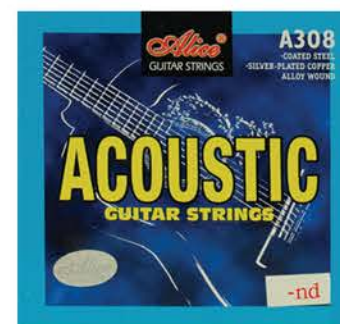

A308-SL SUPER LIGHT		
NOTE	INCH	mm
E	.011	0.28
B	.015	0.38
G	.024	0.61
D	.032	0.81
A	.042	1.07
E	.052	1.32



A406-L  
• Acoustic Guitar, Stainless Steel Bronze Wound, Light Strings



**A406-L** KIT

	inch	mm
Stainless Steel	.012	0.30
Stainless Steel	.016	0.41
Coated Copper Alloy Wound	.024	0.61
Coated Copper Alloy Wound	.032	0.81
Coated Copper Alloy Wound	.042	1.07
Coated Copper Alloy Wound	.053	1.35

A407C-SL  
• Colorful strings for Acoustic Guitar  
• Stainless Steel  
• Steel Core  
• Colorful Coated Copper Alloy Winding



Note	Inch	MM
E-1st	.011	0.28
B-2nd	.015	0.38
G-3rd	.024	0.61
D-4th	.032	0.81
A-5th	.042	1.07
E-6th	.052	1.32



A506-SL (Complete Kit)  
 A506-SL-1  
 A506-SL-2  
 A506-SL-3  
 A506-SL-4  
 A506-SL-5  
 A506-SL-6



• Electric Guitar, Stainless Steel, Nickel Round Wound, Extra-Light Strings

A506-SL	KIT	inch	mm
A506-SL-1	Plated Steel	.009	0.23
A506-SL-2	Plated Steel	.011	0.28
A506-SL-3	Plated Steel	.016	0.41
A506-SL-4	Nickel Alloy Wound	.024	0.61
A506-SL-5	Nickel Alloy Wound	.032	0.81
A506-SL-6	Nickel Alloy Wound	.042	1.07

A507-SL  
 A507-SL-1  
 A507-SL-2  
 A507-SL-3  
 A507-SL-4  
 A507-SL-5  
 A507-SL-6

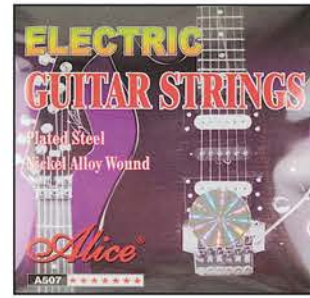

• Electric Guitar, Plated Steel, Nickel Alloy Wound, Nickel-Plated Ball-End, Plastic Bag

A507-SL	KIT	inch	mm
E-1st	Plated Steel	.009	0.23
B-2nd	Plated Steel	.011	0.28
G-3rd	Plated Steel	.016	0.41
D-4th	Nickel Alloy Wound	.024	0.61
A-5th	Nickel Alloy Wound	.032	0.81
E-6th	Nickel Alloy Wound	.042	1.07

A607(4)-M  
 • Electric Bass Strings  
 • Steel Core  
 • Nickel Alloy Wound  
 • Plastic Bag

A607 (4)-M	KIT	inch	mm
	Nickel Alloy Wound	.045	1.14
	Nickel Alloy Wound	.065	1.65
	Nickel Alloy Wound	.085	2.16
	Nickel Alloy Wound	.105	2.67

A638(4)-M  
 • Electric Bass Strings  
 • Hexagonal Core  
 • Nickel Alloy Wound

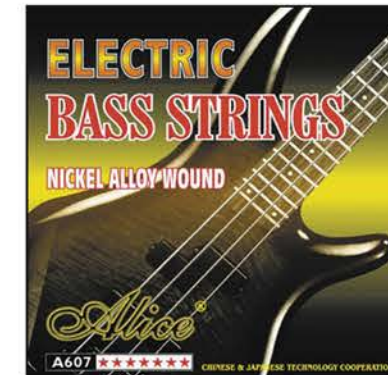
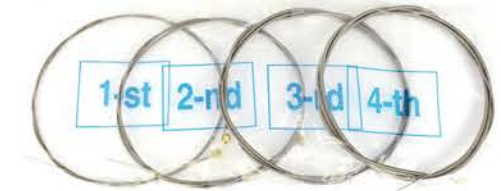

A638(4)-M  
 MEDIUM

Note	inch	mm
G	.045	1.14
D	.065	1.65
A	.085	2.16
E	.105	2.67



AE530-SL  
 ELECTRIC GUITAR STRINGS  
 • Plated Steel  
 • Hexagonal Core  
 • Nickel Alloy Wound



Note	E-1st	B-2nd	G-3rd	D-4th	A-5th	E-6th
inch	.009	.011	.016	.024	.032	.042
mm	0.23	0.28	0.41	0.61	0.81	1.07

A606(4)-M-1  
 A606(4)-M-2  
 A606(4)-M-3  
 A606(4)-M-4  
 A606(5)-M  
 A606(6)-M



• Acoustic Guitar, Stainless Steel, Silver Plated, Copper Wound, Extra-Light Strings

A606-M	KIT	inch	mm
	Nickel Alloy Wound	.032	0.81
	Nickel Alloy Wound	.045	1.14
	Nickel Alloy Wound	.065	1.65
	Nickel Alloy Wound	.085	2.16
	Nickel Alloy Wound	.105	2.67
	Nickel Alloy Wound	.130	3.29

A703  
 • Violin String  
 • Steel Core  
 • Nickel Silver Wound  
 • Plastic Bag

A703 KIT High-Grade  
 Steel Core, Nickel Silver Wound  
 Steel Core, Nickel Silver Wound  
 Steel Core, Nickel Silver Wound

A703A KIT Middle-Grade  
 Stainless Steel  
 Steel Core, Nickel Silver Wound  
 Steel Core, Nickel Silver Wound  
 Steel Core, Nickel Silver Wound

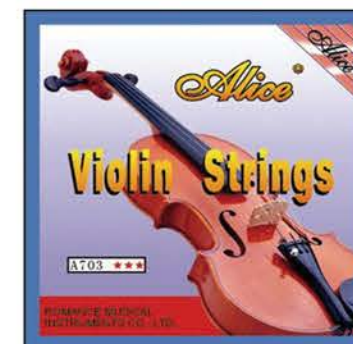

A705  
 A705-1  
 A705-2  
 A705-3  
 A705-4  
 • Violin String  
 • Coated Steel Core  
 • Nickel Chromium Wound  
 • Plastic Bag

A705 KIT  
 E-1st Stainless Steel  
 A-2nd Steel Core, Nickel Chromium Wound  
 D-3rd Steel Core, Nickel Chromium Wound  
 G-4th Steel Core, Nickel Chromium Wound

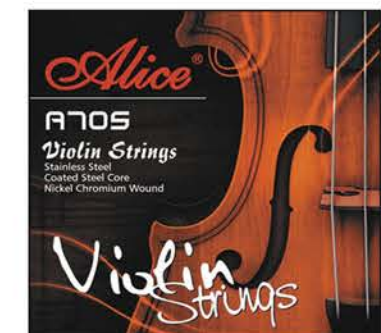



AP-12C  
• Celluloid Picks  
• Constellation



AP-12G  
• Projecting Nylon  
Guitar Picks  
• Clamshell



AP100N  
• Thumb Picks  
• Assorted Colors



A010A  
• Triangle Pick Holder

AP-20M  
• Thumb Picks  
• Assorted Colors  
• 20 Pcs



A010A-G  
TRIANGLE PICK HOLDER  
• 72 Pcs / Canister



AP-20N  
• Celluloid Thumb Picks  
• Assorted Colors  
• 20 Pcs



AP-180  
GUITAR PICK 0.46-1.55MM  
(ASSORTED 180 Pcs)

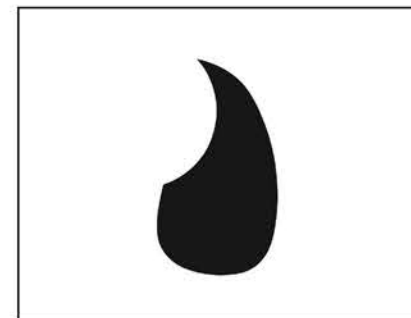

A025A  
• Guitar Pickguard  
• Black

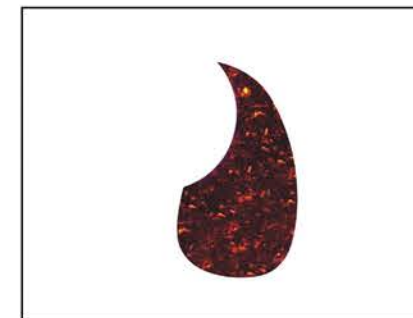

A025B  
• Guitar Pickguard  
• Colorful

TAMBOURINES

ATM-830 BLU  
ATM-830 GRN

- Hand-Held Tambourine with Metal Jingles
- Most Comfortable and Unique Design
- Natural Wrist Shake ever Produced
- High-Quality Metal Jingles
- Sonorous and Amusing Sound
- Careful Making
- Tambourine Popular Among the Music Lovers



ATM-831 WHT

- Hand-Held Tambourine with Metal Jingles
- Most Comfortable and Unique Design
- Natural Wrist Shake ever Produced
- High-Quality Metal Jingles
- Sonorous and Amusing Sound
- Careful Making
- Tambourine Popular Among the Music Lovers



ATM-810 BLU  
ATM-810 RED  
ATM-810 WHT

- Hand-Held Tambourine with Metal Jingles
- Most Comfortable and Unique Design
- Natural Wrist Shake ever Produced
- High-Quality Metal Jingles
- Sonorous and Amusing Sound
- Careful Making
- Tambourine Popular Among the Music Lovers



ATM-818 BLU  
ATM-818 GRN  
ATM-818 RED  
ATM-818 WHT

- Hand-Held Tambourine with Metal Jingles
- Most Comfortable and Unique Design
- Natural Wrist Shake ever Produced
- High-Quality Metal Jingles
- Sonorous and Amusing Sound
- Careful Making
- Tambourine Popular Among the Music Lovers



ATM-820 BLU  
ATM-820 GRN  
ATM-820 RED  
ATM-820 WHT

- Hand-Held Tambourine with Metal Jingles
- Most Comfortable and Unique Design
- Natural Wrist Shake ever Produced
- High-Quality Metal Jingles
- Sonorous and Amusing Sound
- Careful Making
- Tambourine Popular Among the Music Lovers



ATB002-BL  
ATB002-BLK  
ATB002-GR



ATB009  
• Moon Tambourine

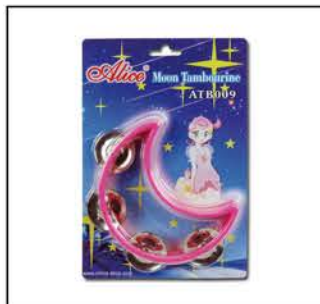

TAMBOURINES



**ATM-DOV-8**  
• 8" Tambourine



**ATM-DOV-10**  
• 10" Tambourine



**ATM-HND8**  
• 8" Tambourine



**ATM-HND10**  
• 10" Tambourine



**ATM-SHI-8**  
• 8" Tambourine



**ATM-SHI-10**  
• 10" Tambourine



**ATM-SHI-6**  
• 6" Tambourine



**ATM-W6**  
• 6" Tambourine



**ATM-W8**  
• 8" Tambourine



**ATM-W10**  
• 10" Tambourine

COWBELLS

**ACB-05**

- 5" MOUNTABLE COWBELL FOR DRUMSET  
 • Designed with the Drum Kit Player in Mind  
 • High Grade 14-Gauge Steel  
 • Rich, Cutting Sound is Low Pitched and Moderately Dry



**ACB-06**

- 6" MOUNTABLE COWBELL FOR DRUMSET  
 • Designed with the Drum Kit Player in Mind  
 • High Grade 14-Gauge Steel  
 • Rich, Cutting Sound is Low Pitched and Moderately Dry



**BCB-06**

- Designed with the Drum Kit Player in Mind  
 • High Grade 14-Gauge Steel  
 • Rich, Cutting Sound is Low Pitched and Moderately Dry  
 • 6"



**ACB-07**

- 7" MOUNTABLE COWBELL FOR DRUMSET  
 • Designed with the Drum Kit Player in Mind  
 • High Grade 14-Gauge Steel  
 • Rich, Cutting Sound is Low Pitched and Moderately Dry



**BCB-07**

- Designed with the Drum Kit Player in Mind  
 • High Grade 14-Gauge Steel  
 • Rich, Cutting Sound is Low Pitched and Moderately Dry  
 • 7"



**ACBH-6**

- 6" HAND HELD COW BELL  
 • Material: Iron  
 • Size: 5.1" x 2.8" x 5.9"  
 (129 x 71 x 151mm)  
 • Weight: 1.15Lb (0.52Kg)  
 • Hand Held  
 • Color: Black



**ACBP-5BL**

- 5" BLUE PERCUSSION  
 • Plastic Cowbell



**ACBP-6RD**

- 5" RED PERCUSSION  
 • Plastic Cowbell



**DS-M5A**

- 5A Wood Tip
- Maple Drumsticks



**DS-M5A-NL**

- 5A Nylon Tip
- Maple Drumsticks



**DS-M7A**

- 7A Wood Tip
- Maple Drumsticks



**DS-M7A-NL**

- 7A Nylon Tip
- Maple Drumsticks



**DS-M5B**

- 5B Wood Tip
- Maple Drumsticks



**DS-OK5A**

- 5A Wood Tip
- Oak Drumsticks



**DS-M7B**

- 7B Wood Tip
- Maple Drumsticks



**DS-OK7A**

- 7A Wood Tip
- Oak Drumsticks



**DS-OK5A-BLK**

- 5A Wood Tip
- Oak Black Drumsticks



**DS-OK5A-NL**

- 5A Nylon Tip
- Oak Drumsticks



**DS-OK7A-BLK**

- 7A Wood Tip
- Oak Black Drumsticks



**DS-OK7A-NL**

- 7A Nylon Tip
- Oak Drumsticks



**DSME-5A-NL**

- 5A Nylon Tip Maple Drumsticks
- Nylon Tip Drumstick
- Normal Size for Adult Use
- Made of Maple



**DSME-7A-NL**

- 7A Nylon Tip Maple Drumsticks
- Nylon Tip Drumstick
- Normal Size for Adult Use
- Made of Maple



GUITAR BAG INCLUDED



**ACG-3910CEQ-SB**

- 39" ELECTRO ACOUSTIC CUTAWAY GUITAR
- 5 Band EQ with Microphone
  - LCD Display Screen, Chromatic Tuner Display
  - Power: 1 x 9v Battery
  - with 1/4" and XLR Socket Output
  - Color: Sun Burst



GUITAR BAG INCLUDED



*Toledo*

**ACG-3910 BLK**

- 39" ACOUSTIC GUITAR
- Color: Black

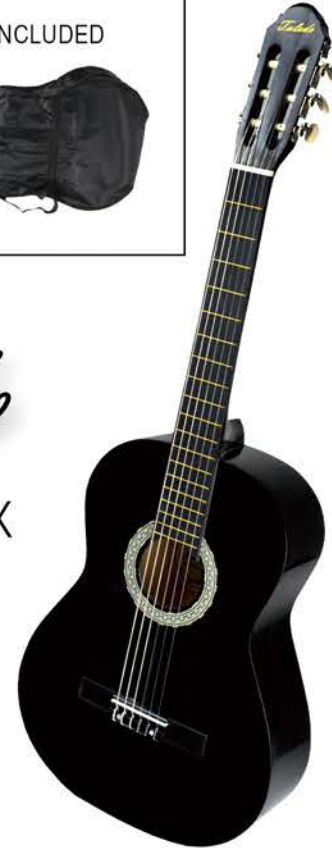

GUITAR BAG INCLUDED



**ACG-3910BL**

- 39" ACOUSTIC GUITAR
- Color: Blue



GUITAR BAG INCLUDED



**ACG-3910SB**

- 39" ACOUSTIC GUITAR
- Color: Sun Burst



GUITAR BAG INCLUDED



**ACG-3910CEQ-WH**

- 39" ELECTRO ACOUSTIC CUTAWAY GUITAR
- 5 Band EQ with Microphone
  - LCD Display Screen, Chromatic Tuner Display
  - Power: 1 x 9v Battery
  - with 1/4" and XLR Socket Output
  - Color: White



GUITAR BAG INCLUDED



**ACG-3910CEQ-YH**

- 39" ELECTRO ACOUSTIC CUTAWAY GUITAR
- 5 Band EQ with Microphone
  - LCD Display Screen, Chromatic Tuner Display
  - Power: 1 x 9v Battery
  - with 1/4" and XLR Socket Output
  - Color: Yellow



GUITAR BAG INCLUDED



**ACG-3910WH**

- 39" ACOUSTIC GUITAR
- Color: White



GUITAR BAG INCLUDED



**ACG-3910YH**

- 39" ACOUSTIC GUITAR
- Color: Yellow



**EB-305BK**

5 STRING ELECTRIC BASS

- Construction Bolt-On
- Scale Length: 34"
- Fingerboard: Rosewood
- Radius: 10"
- Frets: 24
- Body: Alder
- Neck: Maple
- Bridge: Die-Cast
- Pickups: Humbucking Pickup X 2
- Controls: Master Volume, Pan-Pot, 2-Band EQ



**EB-306BK**

6 STRING ELECTRIC BASS

- Construction Bolt-On
- Scale Length: 34"
- Fingerboard: Rosewood
- Radius: 10"
- Frets: 24
- Body: Alder
- Neck: Maple
- Bridge: Die-Cast
- Pickups: Humbucking Pickup X 2
- Controls: Master Volume, Pan-Pot, 2-Band EQ



**EG-101BK**

- Electric Guitar
- 3/4 Size
- Powerful Pickup
- All Wood Body
- Steel Reinforced Bolt-On Neck
- Sealed Die-Cast Tuners
- Fully Adjustable Bridge
- Guitar Strap Buttons Built-In
- Great for Beginners, or as a Travel Guitar
- Built-In Internal AMP with 3" Speaker
- Includes Guitar Strap



**EG-303BK**

- Electric Guitar
- Body: Solidwood
- Neck: Maple
- Fingerboard: Rosewood
- Fret: 22 Frets
- Pickups: TELE PICKUPS
- Control: 1v 1T & 3 Way Toggle s/w
- Scale Length: 648mm
- Hardware: Single Rock



**EG-CP300RD (Red)**

ELECTRIC GUITAR STARTER PACK

- Guitar Strap
- Carrying Bag
- Chord Chart
- 1/4" Guitar Cable (10')
- Turning Tools
- Tremolo Arm
- Guitar Picks
- Pitch Pipe



**ELECTRIC GUITAR:**

- Full-Size Double Cutaway Electric Guitar with 22 Frets
- 3 Single-Coil Pickups
- 5-Way Selector Switch
- Vintage Bridge with Tremolo System
- Maple Neck and Maple Fingerboard
- Color: Red

**TUNER:**

- Built-In Microphone

**AMPLIFIER:**

- 10 Watts Guitar Amplifier
- 5" Speaker
- Input and Headphone Jacks
- Volume, Bass and Treble Controls



**VL-BOW-1**

- Body: Paorosa Solid Wood
- Frong: Ebony
- Double Eye (with Shell and Metal Ring)
- Shape: Round



**VL-BOW-CCT**

- Body: Paorosa Solid Wood
- Frong: Ebony
- Double Eye (with Shell and Metal Ring)
- Shape: Octagonal



**VL-800K**

- Neck: Maple
- Top: Solid Spruce
- Body & Side: Solid Maple
- Back: Linden Plywood
- Fingerboard: Hardwood
- Bridge: Maple
- Form Case, Bow



**VLB-44MW**

- A Class Violin Bridge
- Includes 2 Pcs.





**EQ-A4T**  
GUITAR EQUALIZER  
• Digital 4-Band Equalizer



**EQ-A300**  
GUITAR EQUALIZER  
• 3-Band Equalizer



**EQ-A500**  
GUITAR EQUALIZER  
• 5-Band Equalizer



**DB-01**  
PROFESSIONAL SINGLE-CHANNEL PASSIVE DIRECT BOX  
• Input Attenuation: Switchable (0dB, -20dB, -40dB)  
• Instrument Input: 50K Unbalanced TS Jack  
• Parallel (Link) Out: 50K Unbalanced TS Jack  
• Balanced Output: 600Ω Balanced XLR Jack  
• Ground Lift: Switchable Ground Lift  
• Construction: All Steel Chassis  
• Dimensions: 4.7" x 3" x 1.8"  
(120 x 76.5 x 45mm)



**DB-02**  
PROFESSIONAL DUAL-CHANNEL PASSIVE DIRECT BOX  
• Input Attenuation: Switchable (0dB, -20dB, -40dB)  
• Instrument Input: 50K Unbalanced TS Jack  
• Parallel (Link) Out: 50K Unbalanced TS Jack  
• Balanced Output: 600Ω Balanced XLR Jack  
• Ground Lift: Switchable Ground Lift  
• Construction: All Steel Chassis  
• Dimensions: 5.3" x 3.7" x 1.6"  
(134 x 95 x 40mm)



**MTNR-7CLP**  
• Digital Clip Tuner  
• Signal Receipt Method: MIC & CLIP  
• A4 Frequency Range: 435~445Hz  
• Tuning Mode: For Guitar, Bass & Violin  
• Tuning Range: 0A~7C  
• Tolerance: ≤1 Cent  
• LDC Display: Color Back-Light Display  
• Red to Green Status Indicator  
• Battery: CR2032  
• Size: 53x80x43(mm)  
• Weight: 53G



**Battery Included**



**PICKUP-50**  
• Standard Pickup  
• Easy to Install to Most Acoustical Instruments



**PICKUP-60V**  
• Violin Pickup



**PICKUP-70G**  
• Acoustic Guitar Pickup



**PICKUP-105G**  
• Acoustic Guitar Pickup  
• Can Fit 3-11/16 to 4-1/8  
(94-105mm) Sound Hole  
• Excellent Bass Midrange  
Response and Soft Acoustic Tone



**GM-130**  
• Acoustic Guitar Pickup



**EQ-A7545R**  
ACOUSTIC GUITAR EQUALIZER  
• 4 Band Guitar Equalizer



**GUIRO-310B**

- Percussion Instruments
- 15"
- Diameter 3"



**GUIRO-412**

- Percussion Instruments
- 12"
- Diameter 4"



**GUIRO-512**

- Percussion Instruments
- 12"
- Diameter 5"



**GUIRO-612**

- Percussion Instruments
- 12"
- Diameter 6"



**ARC-820**

- Ivory Recorder
- Includes a Bag
- Lyons Recorder Cleaning Rod
- Approximately 12.50" Long



**AHM-160**

- Harmonica
- Metal & Wood
- Silver
- In C Key



**AO42SE**

- SOUND EGGS
- 1 Unit = 2 Pcs.



**AMRC-06**

- Plastic Concert Maracas with Wood Handles



**AO41SE-G**

- SOUND EGGS
- 1 Unit = 28 Pcs.



**CABASA-438**

- 4.3" CASABA
- Linear Scraper Pattern
- Create Fun and Exciting Sounds
- Diameter x Total Length: 4.3" x 7"
- Weight: 0.88 Lbs.
- Ergonomically Shapped Wood Handle
- Steel Chain and Cylinder
- Easy for Children to Use



**CABASA-510**

- 5.1" CASABA
- Linear Scraper Pattern
- Create Fun and Exciting Sounds
- Diameter x Total Length: 5.1" x 7"
- Weight: 1 Lbs.
- Ergonomically Shapped Wood Handle
- Steel Chain and Cylinder
- Easy for Children to Use



**ABG-10**

- Plastic Bongo
- 7" & 8" Plastic Shell



**ABG-32**

- 7" & 8" Double Color



**ABG-40**

- 7" & 8" Wooden Shell

MUSICAL EQUIPMENT

GUITAR STRAP ACCESSORIES

ZGS-1  
• Guitar Strap



ZGS-7  
• Guitar Strap



ZGS-8  
• Guitar Strap



ZGS-9  
• Guitar Strap



ZGS-10  
• Guitar Strap



ZGS-P140BK  
• Guitar Strap



ZGS-P140MI  
• Guitar Strap



A040-LB  
• Guitar Strap



MUSICAL EQUIPMENT

ACCESSORIES



A013-3  
• Violin Rosin for Orchestra or Solo Work



A013B  
• High Grade Violin-Viola-Cello Rosin



A026A  
• Acoustic Guitar Nut

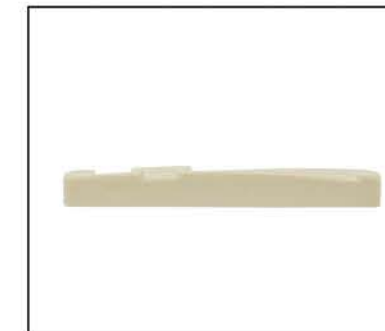

A026C  
• Acoustic Guitar Saddle



A009AP  
• Guitar String Winder



GUIRO-BRUSH-12  
• Güiro Brush  
• Length: 305mm/12"

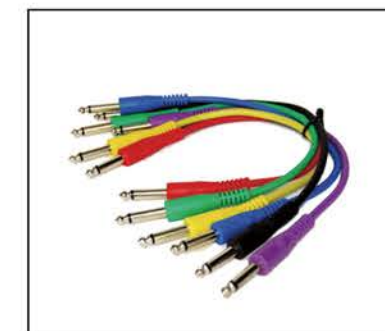

FXC-61414  
• Jumper Cables for Guitar Pedals  
• 6 Color Coded: Red, Blue, Yellow, Green, Black & Purple



CL-1001  
10" CLAVES  
• Good Color

GUITAR BAGS



GB-12EL

• Electrical Guitar Bag Non-Woven  
Fabric Pearl Cotton



GBN-01CL-39

• 39" Guitar Strap



PROFESSIONAL  
MICROPHONES

**DM-212 BLUE**

- DYNAMIC
- 600 Ohms
  - 60-16K Hz
  - -74 ± 3dB



**DM-301**

- DYNAMIC
- Metal Construction
  - 600 Ohms
  - 60-16KHz @ 1KHz
  - -74 ± 3dB



**DIM-620**

- UNIDIRECTIONAL INSTRUMENT MICROPHONE
- Professional Sound Quality for Vocals and Instruments
  - Unidirectional Polar Pattern Reduces Pickup of Undesired Off-Axis Sound
  - Well Suited for On-Stage Vocal/Instrument Use as well as for the Karaoke Enthusiast
  - Impedance: 250 Ohms ± 10%
  - Sensitivity: -53dB ± 3dB
  - Frequency Response: 40 - 18KHz
  - Cable Length: 16' (5m Approx)



**DM-28**

- UNI-DIRECTIONAL DYNAMIC MICROPHONE
- Professional Sound Quality for Vocals and Instruments
  - Unidirectional Polar Pattern Reduces Pickup of Undesired Off-Axis Sounds
  - Well suited for on stage Vocal/Instrument Use as well as for the Karaoke Enthusiast
  - Impedance: 600 Ohms
  - Sensitivity: -52dB ± 3dB
  - Frequency Response: 50 - 18KHz
  - Plastic Body



**DM-605**

- DYNAMIC
- Metal Construction
  - 600 Ohms
  - 60-16KHz @ 1KHz
  - -74 ± 3dB



**DM-18U**

- PROFESSIONAL DYNAMIC MICROPHONE
- Uni-Directional Polar Pattern Reduces Pickup of Undesired Off-Axis Sound
  - Professional Sound Quality for Vocals and Instruments
  - Well Suited for on Stage Vocal/ Instrument Use as well as for the Karaoke Enthusiast
  - Detachable Cable and Professional 3-Pin Output Connector
  - Impedance: 600Ω ± 30%
  - Sensitivity: -74dB ± 3dB
  - Frequency Response: 60~15KHz



**DM-38**

- DYNAMIC MICROPHONE
- Professional Sound Quality for Vocals and Instruments
  - Unidirectional Polar Pattern Reduces Pickup of Undesired Off-Axis Sounds
  - Well Suited for on Stage Vocal/Instrument Use as well as for the Karaoke Enthusiast
  - Impedance: 600 Ohms
  - Sensitivity: -53dB ± 3dB
  - Frequency Response: 40 - 17KHz)
  - Metal Body
  - Switchless



**DM-48**

- PROFESSIONAL DYNAMIC MICROPHONE
- Professional Sound Quality for Vocals and Instruments
  - Unidirectional Polar Pattern Reduces Pickup of Undesired Off-Axis Sounds
  - Well Suited for On-Stage Vocal/Instrument Use as well as for the Karaoke Enthusiast
  - Dynamic Uni-Directional Microphone
  - Impedance: 600 Ohms
  - Sensitivity: -53dB ±3dB
  - Frequency Response: 40-17KHz



**DM-303BL**

- PROFESSIONAL DYNAMIC MICROPHONE
- Dynamic Uni-Directional Microphone
  - Impedance: 600 Ω ± 30%
  - Sensitivity: -76dB ± 3dB
  - Frequency Response: 70-14KHz
  - Neodymium Magnet Ensures Optimum Sound Quality
  - Double Dome Diaphragm for Well Balanced Sound Quality Ranging from the Lower to Upper Frequencies
  - Alight Duty CCAW (Aluminum Wire) is used to Form the Voice Coil which helps Achieve Crystal Clear Sound Levels
  - Reliable Canon Type Connector is Included

**WIRED**



Captures Sound from One Direction  
**UNIDIRECTIONAL**



**DM-88**

- PROFESSIONAL DYNAMIC MICROPHONE
- Professional Sound Quality for Vocals and Instruments
  - Unidirectional Polar Pattern Reduces Pickup of Undesired Off-Axis Sounds
  - Well Suited for on Stage Vocal/Instrument Use as well as for the Karaoke Enthusiast
  - Impedance: 600 Ohms
  - Sensitivity: -53dB ± 3dB
  - Frequency Response: 40 - 18KHz
  - Metal Body
  - Switchless



**DM-35B**

MEETING MICROPHONE

- Output Impedance: 75 Ohms
- Power Supply: DC 3V / DC 48V
- Reference Sound-Receiving Distance: 20 - 50cm
- Capsule Type: Condenser
- Polar Pattern: Ultra-Cardioid
- Frequency Response: 40Hz - 16KHz
- Sensitivity: -40±2dB



**DM-35JLN**

PROFESSIONAL DYNAMIC MEETING MICROPHONE WITH BASE

- Capsule Type: Condenser
- Polar Pattern: Cardioid
- Frequency Response: 40Hz~1.6KHz
- Sensitivity: -40±2dB
- Output Impedance: 200Ω Unbalanced
- Power Supply: Phantom48V/DC3V
- Mic Length: 19.5" (49.5cm)
- Extended Arm Length
- Unidirectional



**GW-2002**

2 CHANNEL UHF WIRELESS MICROPHONE SYSTEM

- Carrier Frequency: UHF 640~699MHz
- Stability: < ± 20ppm
- Dynamic Range: >95dB
- T.H.D.: <1%
- Frequency Response: 50Hz~17KHz ± 3dB
- Audio Out: 0~400mV



**GW-2003L**

SINGLE CHANNEL UHF WIRELESS MICROPHONE SYSTEM

- Carrier Frequency: UHF 640~699MHz
- Stability: < ± 20ppm
- Dynamic Range: >95dB
- T.H.D.: <1%
- Frequency Response: 50Hz~17KHz ± 3dB
- Audio Out: 0~400mV



**GW-750**

UNIDIRECTIONAL

- 30 Meter Range
- 600 Ohms
- 100-10K Hz
- -72dB
- Includes Receiver, Antenna & Wire



**GW-901**

SINGLE CHANNEL FM WIRELESS MICROPHONE SYSTEM

- Using VHF 200-270MHz Band to Avert Interfering Frequencies.
- Using Quartz Crystal Oscillating Circuits to Provide a Steady Frequency
- Specially Designed Compounding Circuit that Strongly Improves S/N Ratio
- Multi-Level Quiet Control Uses the Mutes System to Avoid Signal Interference on Activation and Shut Down
- Uses Dynamic Cardioid Direct Cartridge for Bright and Clear Sound
- Carrier Frequency: VHF 200-270MHz
- Stability: <±20ppm
- Dynamic Range: >90dB
- T.H.D.: <0.5%
- Frequency Response: 40Hz-15KHz ± 3dB
- Audio Out: 0-500mV



**GW-5002**

2 CHANNELS FM WIRELESS MICROPHONE SYSTEM

- Using VHF200-270MHz Band to Avert Interfering Frequencies
- Using Quartz Crystal Oscillating Circuits to Provide a Steady Frequency
- Specially Designed Compounding Circuit that Strongly Improves S/N Ratio
- Multi-Level Quiet Control Circuit Uses the Mute System to Avoid Signal Interference on Activation and Shut Down
- Uses Dynamic Cardioid Direct Cartridge for Bright and Clear Sound
- with 1/4" Socket Conveniently Connects to Any Equipment
- with Quartz Crystal



**GW-3002**

2 CHANNELS WIRELESS MICROPHONE SYSTEM

- Using VHF 88 - 106MHz Band to Avert Interfering Frequencies
- Impedance: 600 Ohms
- Dynamic Range: >80dB
- Distortion Rate: <1%
- Frequency Response: 80 - 17KHz ± 3dB
- with Quartz Crystal



**GW-2001**

SINGLE CHANNELS UHF WIRELESS MICROPHONE SYSTEM

- Carrier Frequency: UHF 640~699MHz
- Stability: < +/- 20ppm
- Dynamic Range: >95dB
- T.H.D.: <1%
- Frequency Response: 50Hz~17Hz +/- 3dB
- Audio Out: 0~400mV
- Input: 100-240VAC 50/60Hz



**GW-6002**

2 CHANNELS WIRELESS, MICROPHONE SYSTEM

- Carrier Frequency: UHF 500-580MHz
- Stability: < ± 20ppm
- Dynamic Range: >98dB
- T.H.D.: <0.5%
- Frequency Response: 40Hz-18 KHz ± 3dB
- Audio Out: Balanced: 0-700mV Mix: 0-300mV



**GW-7011**

2 CHANNELS WIRELESS, MICROPHONE SYSTEM

- Carrier Frequency: UHF 500-580MHz
- Stability: < ± 20ppm
- Dynamic Range: >98dB
- T.H.D.: <0.5%
- Frequency Response: 40Hz-18 KHz ± 3dB
- Audio Out: Balanced: 0-700mV Mix: 0-300mV



**GW-7011RBP**

REPLACEMENT BODY PACKAGE

## STW-7902

Wireless Microphone Dual Channel UHF

- Transmitter Power: < 30mW
- Spurious Emission: < 40dB (with Carrier)
- Battery Voltage: AA1.5v x 2
- Battery Life: > 10 Hours (Receiver) Desk-Top:
- Carrier Frequency Range: UHF 480-600 MHz
- Oscillation Mode: Quartz Controlled Fixed Frequency
- Stability: 10PPM
- Sensitivity: 2uV@sinad=12dB
- Maximum Deviation Range: 50KHz
- SIN Ratio: > 105dB
- T.H.D.: < 0.5%@ 1KHz
- Image Rejection: 85 dB Typical
- Spurious Rejection: 75 dB Typical
- Frequency Response: 50Hz-15KHz
- Squelch Control: Dual-Squelch Circuit
- Max. Output Level: Balanced: 0-400mv, Unbalanced: 0-300mv
- Power Supply: External DC Power Supply, 0.4A, 12-15VDC
- Dimensions: 8.2" x 5.4" x 1.5" (209 x 138 x 39mm)



## GW-8002

FM WIRELESS MICROPHONE SYSTEM

- Carrier Frequency: UHF 740 - 840MHz
- Stability: <math>\pm 20\text{ppm}</math>
- Dynamic Range: >98dB
- T.H.D.: <math>< 0.5\%</math>
- Frequency Response: 40Hz - 18KHz  $\pm 3\text{dB}$
- Audio Out: Balanced:  
0 - 700mV / Mix: 0 - 300mV



## GW-9002

FM WIRELESS MICROPHONE SYSTEM

- Using UHF 740-840MHz Band to Avert Interfering Frequencies
- Using Quartz Crystal Oscillating Circuits to Provide a Steady Frequency
- Specially Designed Compounding Circuit that Strongly Improves S/N Ratio
- Multi-Level Quiet Control Circuit Uses the Mute System to Avoid Signal Interference on Activation and Shut Down
- Uses Dynamic Cardioid Direct Cartridge for Bright and Clear Sound
- With Both XLR and 1/4" Sockets Conveniently Connects to Any Equipment
- Carrier Frequency: UHF 740-840MHz
- Stability: <math>\pm 20\text{ppm}</math>
- Dynamic Range: >98dB
- T.H.D.: <math>< 0.5\%</math>
- Frequency Response: 40Hz-18KHz  $\pm 3\text{dB}$
- Audio Out: 0-400mV (Balanced: 0-2V)



## GW-R2000

2 CHANNEL UHF WIRELESS MICROPHONE SYSTEM

- Features:
- Wide Response Range
- Rechargeable Battery for Microphone
- In-Use, Reception and Transmission Indicators
- Two Antennas for Better Reception
- Volume Control
- Modulation in Frequency
- Balanced and Unbalanced Outputs
- 60 to 100m Range

## SPECIFICATIONS:

Microphone:

- Input: 3.7 V (Lithium Battery)  
3 V (2xAA)
- Frequency Response: 50 Hz-20 KHz
- Frequency Stability: 0.005%
- Sensitivity: - 68 dB  $\pm 3$  dB
- SNR: >100 dB

Receiver:

- Input: 12 V 2A
- Impedance: 600  $\Omega$
- AC/DC Power Converter
- Input: 100 - 240 V,  
50 / 60 Hz, 1A
- Output: 12 V 2 A



## GW-R101

UHF WIRELESS MICROPHONE WITH RECHARGEABLE RECEIVER SYSTEM SPECIFICATIONS

- Modulation Mode: Digital Frequency Modulate
- Oscillation: PLL Synthesized
- Carrier Frequency Range: UHF 500-980MHz
- Preset Frequencies: 8 (Auto Pairing)
- Frequency Response: 75Hz-18kHz  $\pm 3\text{dB}$
- Max. Deviation Range:  $\pm 50\text{kHz}$  (with Level Limiting)
- T.H.D.: <math>< 1.0\%</math> @ 1kHz
- S/N: >98dB
- Working Range: Up to 50m
- RF Carrier Stability:  $\pm 0.005\%$  (-10 $\times$ -50 $\times$ )

MINI WIRELESS RECEIVER (METAL)

- Dimension: 95 x 31 x 16 mm
- Power Supply: Built-In Li-on Rechargeable Battery (500mA)
- Power Consumption: 80mA
- Battery Life: Up to 6 Hrs
- Recharging Time: About 1 Hour (5V/1A)

HANDHELD MICROPHONE (METAL)

- Sound Cartridge: Dynamic
- Carrier Frequency Power: 30mw
- Battery Type: 2 x AA Size
- Working Time: Up to 10 hrs
- Dimension: 250 x 55 mm
- Weight: 350 g



**DMG-01G**

METAL WELD, HARD AND DURABLE

- Replaces Most Common Microphone Grills
- Outer Height: 53mm
- Outer Width: 54mm
- Inner Height: 52mm
- Inner Width at Base: 34mm



**S-05B**

FOAM COVER

- Set of 5
- For use with all Larger Ball-Type Microphones
- This Zebra Microphone Pad is Designed with Acoustically Transparent Foam to Reduce Unwanted Breath and Wind Noise without Affecting the Sound Quality
- Outer Height: 40mm
- Outer Width: 31mm
- Inner Height: 35mm
- Inner Width: 26mm



**S-1**

FOAM BALL-TYPE MIC WINDSCREEN

- Set of 5
- Assorted
- Outer Height: 63mm
- Outer Width: 55mm
- Inner Height: 60mm
- Inner Width: 52mm



**S-1B**

FOAM BALL-TYPE MIC WINDSCREEN

- Set of 5
- Black
- Outer Height: 63mm
- Outer Width: 55mm
- Inner Height: 60mm
- Inner Width: 52mm



**S-2B**

LOT FLAT MICROPHONE WINDSCREEN

FOAM COVER

- Set of 5
- Black
- Outer Height: 63mm
- Outer Width: 55mm
- Inner Height: 60mm
- Inner Width: 52mm



**SM-PS13**

POP SHIELD

- High-Quality Acoustic Filter
- Prevents Pops when Recording Vocals
- Adjustable Clamp Mounts Securely to any Mic Stand
- Adjustable Clamp for Precise Positioning



**SM-PS15**

POP SHIELD

- High-Quality Acoustic Filter
- Prevents Pops when Recording Vocals
- Goose Neck for Precise Positioning
- Adjustable Clamp Mounts Securely to any Mic Stand



**CD-A1**

FOR DM-301

- Pattern: Uni-Directional
- Frequency Response: 50~14KHz
- Sensitivity: -56dB ±3dB
- Output Impedance: 600Ω ±10%
- Outer Height: 43mm
- Outer Width at Base: 29mm



**CD-A2**

FOR GW-8002

- Pattern: Uni-Directional
- Frequency Response: 40~18KHz
- Sensitivity: -53dB±3dB
- Output Impedance: 600Ω ±10%
- Outer Height: 55mm
- Outer Width at Base: 27mm



**CD-A3**

FOR PG48

- Pattern: Uni-Directional
- Frequency Response: 50~ 18KHz
- Sensitivity: -56dB±3dB
- Output Impedance: 500Ω ± 10%
- Outer Height: 40mm
- Outer Width: 30mm
- Outer Width at Base: 30



**CD-A4**

FOR DM-301

- Pattern: Uni-Directional
- Frequency Response: 50~15KHz
- Sensitivity: -56dB ±3dB
- Output Impedance: 600Ω ±10%
- Outer Height: 47mm
- Outer Width at Base: 28mm



**CD-A5**

FOR DM-301

- Pattern: Uni-Directional
- Frequency Response: 40~18KHz
- Sensitivity: -54dB ±3dB
- Output Impedance: 600Ω ±10%
- Outer Height: 40mm
- Outer Width: 28mm
- Outer Width at Base:28



**CD-A6**

FOR PG48

- Pattern: Uni-Directional
- Frequency Response: 50~ 15KHz
- Sensitivity: -56dB±3dB
- Output Impedance: 600Ω ±10%
- Outer Height: 42mm
- Outer Width: 30mm
- Outer Width at Base: 30



**CD-A9**

FOR DM-18K

- Pattern: Uni-Directional
- Frequency Response: 40~15KHz
- Sensitivity: -56dB ±3dB
- Output Impedance: 600Ω ±10%
- Outer Height: 43mm
- Outer Width: 32mm
- Outer Width at Base: 32



## REPLACEMENT VOICE COIL

**CD-A8H**

FOR DM-38

- Pattern: Uni-Directional
- Frequency Response: 50~18KHz
- Sensitivity: -56dB  $\pm$ 3dB
- Output Impedance: 600 $\Omega$   $\pm$ 10%
- Outer Height: 60mm
- Outer Width at Base: 28mm

**CD-A8L**

FOR GW-6002

- Pattern: Uni-Directional
- Frequency Response: 50~18KHz
- Sensitivity: -56dB  $\pm$ 3dB
- Output Impedance: 600 $\Omega$   $\pm$ 10%
- Outer Height: 47mm
- Outer Width at Base: 28mm

**CD-A10**

FOR DM-PG58

- Pattern: Uni-Directional
- Frequency Response: 50~18KHz
- Sensitivity: -55dB  $\pm$ 3dB
- Output Impedance: 600 $\Omega$   $\pm$ 10%
- Outer Height: 47mm
- Outer Width at Base: 29mm

**CD-A11**

FOR DM-605

- Pattern: Uni-Directional
- Frequency Response: 50~16KHz
- Sensitivity: -56dB  $\pm$ 3dB
- Output Impedance: 600 $\Omega$   $\pm$ 10%
- Outer Height: 52mm
- Outer Width at Base: 29mm

**CD-A12**

FOR DM-212

- Pattern: Uni-Directional
- Frequency Response: 50~14KHz
- Sensitivity: -56dB  $\pm$ 3dB
- Output Impedance: 600 $\Omega$   $\pm$ 10%
- Outer Height: 44mm
- Outer Width at Base: 29mm

**CD-A13**

FOR SM-28

- Pattern: Uni-Directional
- Frequency Response: 40~18KHz
- Sensitivity: -53dB  $\pm$ 3dB
- Output Impedance: 600 $\Omega$   $\pm$ 10%
- Outer Height: 52mm
- Outer Width at Base: 28mm

**CD-B1**

FOR GW-901, GW-7011, GW-6002

- Pattern: Uni-Directional
- Frequency Response: 50~18KHz
- Sensitivity: -56dB  $\pm$ 3dB
- Output Impedance: 600 $\Omega$   $\pm$ 10%
- Outer Height: 50mm
- Outer Width at Base: 26mm

**CD-B2**

FOR GW-4004

- Pattern: Uni-Directional
- Frequency Response: 40~19KHz
- Sensitivity: -52dB  $\pm$ 3dB
- Output Impedance: 600 $\Omega$   $\pm$ 10%
- Outer Height: 53mm
- Outer Width at Base: 28mm

**CD-B3**

FOR DM-88

- Pattern: Uni-Directional
- Frequency Response: 40~19KHz
- Sensitivity: -52dB  $\pm$ 3dB
- Output Impedance: 600 $\Omega$   $\pm$ 10%
- Outer Height: 45mm
- Outer Width at Base: 28mm



# DISCO LIGHT





**ZYST-562L-BL**

LED COLORFUL STROBE

- Voltage/Frequency: AC 110V/60Hz
- Power Consumption: 8W
- Lighting Source: 5mm LED Diodes, 62 LED Bulbs
- Control Mode: Sound Control
- Operating Environment: Indoor Use
- BLUE Color



**ZYST-562L-GR**

LED COLORFUL STROBE

- Voltage/Frequency: AC 110V/60Hz
- Power Consumption: 8W
- Lighting Source: 5mm LED Diodes, 62 LED Bulbs
- Control Mode: Sound Control
- Operating Environment: Indoor Use
- GREEN Color



**ZYST-562L-RD**

LED COLORFUL STROBE

- Voltage/Frequency: AC 110V/60Hz
- Power Consumption: 8W
- Lighting Source: 5mm LED Diodes, 62 LED Bulbs
- Control Mode: Sound Control
- Operating Environment: Indoor Use
- RED Color



**ZYST-562L-YL**

LED COLORFUL STROBE

- Voltage/Frequency: AC 110V/60Hz
- Power Consumption: 8W
- Lighting Source: 5mm LED Diodes, 62 LED Bulbs
- Control Mode: Sound Control
- Operating Environment: Indoor Use
- YELLOW Color



**ZYP-34R**

MINI LED PAR LIGHT

- Voltage: AC 110V
- Frequency: 50/60Hz
- Power Consumption: 20W
- Light Source: 3PCS RWGW 4-IN-1 LEDs
- Lens: 45 Degree
- LED Lifespan: 6-10 Thousand HRS
- Features: Outer Shell Made of Strong PVC, Light Weight, Durable, Good Heat Dissipation, High-Speed Chip Design, Connect 512 Signal Controller, can Pull up Numerous Kinds of Color Effects, Etc.
- Control Mode: DMX512 (8chs), Master/Slave, Auto, Sound Active
- Light Body: Black, Blue, and White Optional
- N.W: 0.66 LBS
- Dimensions: 4.7" x 4.7" x 3.9"



**ZYP-112**

LED STAGE LIGHT

- Power Supply: AC100-240V, 50-60Hz
- Rating Power: 12W
- Light Source: 18x0.5W (R6, G6, B6)
- Lamp Life: 50000 Hours
- Control Mode: Auto/Sound/DMX/Master-Slave
- DMX Channels: 7CH
- NW: 2 lbs (0.92Kg)
- Dimension: 7.9" x 3.9" x 9.1" (200 x 100 x 230mm)



**ZYP-118**

LED STAGE LIGHT

- Light Source: 18 x 1W / 6 x RGB
- Source Lifetime: Rated 50,000 Hours
- Power Supply: 100-240V/50-60Hz
- Power Rating: 24W
- Play Mode: Auto/Sound/DMX Master-Slave
- DMX Channel: 7
- Dimensions: 7.5" x 5.5" x 7.5" (190 x 140 x 190mm)
- Gross Weight: 2.03lbs (0.92Kg)

**ZYP-118BAT**

LED STAGE LIGHT / BATTERY OPERATED



**ZYP-154**

LED STAGE LIGHT

- Voltage: AC100-240V, 50-60Hz
- Power Consumption: 120W
- Light Source: 54 x 1W High Brightness RGBW LEDs (R12, G18, B18, W6)
- Lamp Life: 6-10 Ten Thousand Hours
- Color: 16.7 Million Kinds of Color Mixing
- Control Mode: DMX 512, Master/Slave, Auto, Sound Activated
- Control Channels: 8CH
- Weight: 3.3Lbs (1.5KG)
- Dimensions: 8.7" x 8.7" x 9.1" (220 x 220 x 230mm)
- ABS Plastic

**ZYP-207W**

LED STAGE LIGHT

- Power Supply: AC100~240V, 50~60Hz
- Rating Power: 32W
- Light Source: 7x 4W RGBW 4-IN-1 LED
- Lamp Life: 50,000 hours
- Control Mode: Auto/Sound/DMX/Masterslave
- DMX Channels: 8CH
- N.W.: 1.65Lbs (0.75KG)
- Dimension: 6.9" x 7.3" x 3.9"
- Application: Stage, Bar, Club, Party, Home Decoration, Hotel, Shopping Mall, Restaurant, Concert etc.

**ZYP-543**

LED STAGE LIGHT

- Light Source: 54x3W
- Source Lifetime: Rated 50000 Hours
- Power Supply: 100~240V, 50~60Hz
- Power Rating: 180W
- Play mode: Auto/Sound/DMX Master-Slave
- DMX Channel: 8
- Dimensions: 10" x 10" x 14.4" (255x255x295mm)
- Gross Weight: 6.2 lbs (2.8Kgs)

**ZYP-16BAT**

LED CRYSTAL BALL (RECHARGEABLE)

- Power Consumption: 20W
- Lithium Battery: 4.2V, 2000MHA
- Charging Time: 6-8 Hours
- Working Time: 3 Hours
- An Adapter for Charging
- Light Source: 48 x F10mm High Brightness RGB (R16, G16, B16) + LEDs 3 x 3W (R1, G1, B1)
- Control Mode: Auto & Sound Activated
- N.W.: 0.62 lbs (280 G)
- Dimension: 5.3" x 5.3" x 5.3" (135x135x135mm)
- Shell is made of ABS Plastic, Unique Optic Design System, Low Power Consumption, Super Luminance, Rich and Splendid Color

**ZYB-32**

LED MINI COLOR BALL

- Voltage/Frequency: AC 110V/60Hz
- Power Consumption: 10W
- Lighting Source: 10mm LED Diodes, 39 LED Bulbs (Red, Green, Blue, White)
- Motor: 220V 5rpm
- Control Mode: Automatic
- Operating Environment: Indoor Use

**ZYB-13S**

LED MAGIC BULB

- Power Supply: AC 110-240V, 50/60Hz
- Fitting Socket: E27
- 5V DC Motor with High Rotation Speed
- Automatic Operation
- Low Energy Consumption
- 2000 Operation Hours
- Compact & Lightweight, Easy to Use
- Colorful, Bright Light Effect Generated by 3 x RGB LEDs of 1W each
- Amazing Light Effect with Small Dimensions. Screw into an E27 Fitting to Create a Party Atmosphere at Home, in a Pub or During a Karaoke Party, Etc.
- Dimensions: 3.2" x 5"
- Weight: 0.22 Lbs

**ZYB-16**

LED CRYSTAL BALL

- Power Supply: AC110V, 60Hz
- Power Consumption: 15W
- Lamp Life: 100,000 Hours
- Control Mode: Auto and Sound Activated
- Weight: 0.62 Lbs (280G)
- Dimensions: 5.3" x 5.3" x 5.3"
- Shell is made of ABS Plastic, Unique Optics Design System, Low Power Consumption, Super Luminance, Rich and Splendid Color
- **NO BATTERY REQUIRED**

**ZYB-34**

LED MINICRYSTAL LIGHT - DMX

- Voltage: AC 110/60Hz
- Power Consumption: 15W
- Lighting Source: 3W LED x 4PCS (R,G,B,W)
- Control Channel: 8CH
- Control Mode: DMX512, Music, Automatic Activation, Master-Slave
- Operating Environment: Indoor Use

**ZYB-36UB**

LED CRYSTAL BALL WITH MUSIC PLAYER WITH BUILT IN SPEAKER

- Light Source: 6 x 3W RGB LED
- Source Lifetime Rated 18000 Hours
- 2-Way Rotation
- Built-in Speaker
- Power Supply: 110V/50Hz
- Power Rating: 25W
- Operating Mode: Auto/Sound/BT
- SD Card Input and USB Port for Sound Controlled Operation

**ZYB-38U****LED SUN MAGIC BALL**

- Combined LED Magic Ball & UFO Light Effect for Table Top or Hanging
- Beams Light on the Wall and Lights Up the Room
- Power Supply: AC110, 60Hz
- Power Consumption: 20W
- Lamp Life: 100,000 Hours
- LEDs x 6 (R1, G1, B1, W1, A1, P1)
- Control Mode: Auto, Sound Operation
- Dances to the Beat
- Digital Display
- N.W.: 0.62 Lbs
- Dimensions: 7.1" x 7.1" x 6.3"

**ZYB-U08****UFO LED LIGHT**

- Power Supply: AC 110V, 60 Hz
- Light Source: 48 x f 10mm RGB (16R, 16G, 16B)
- Lamp Life: 20000 Hours
- Operating Modes: Auto & Sound
- Dimension: 5.1" x 5.1" x 1.7" (130 x 130 x 42mm)
- Weight: 0.33lb (150 G)
- Built-In Microphone can Trigger External Sound

**ZYMH-78****MINI MOVING HEAD**

- Light Source: 7x8W, 4-in-1 RGBW
- Power Supply: 100~240V AC, 50/60Hz
- Rated Power: 100W
- Control Mode: Sound/Auto/DMX/Master-Slave
- DMX Channel: 9/14
- Scanning Angle: Pan: 540°, Til: 270°
- Widely used in Small Stage, KYV, Bar, Disco Bar, Home Party, Wedding Party, Entertainment Show, etc.
- Dimension: 6.9" x 6.9" x 9.3" (175 x 175 x 235mm)
- Weight: 6 lbs (2.7 Kg)

**ZYMS-83****MINI LED SPIDER LIGHT**

- Voltage: 110V, 50/60Hz
- LEDs: 8pcs x 3W RGBW LEDs (2 Red, 2 Green, 2 Blue, 2 White)
- LED Lifespan: 50,000 Hours Rated
- Power Consumption: 46W
- Beam Angles: 4 Degrees
- Display: 4-Button LED Display
- Multi-Colors
- Operation Modes: 3 Operating Modes, Sound Active, Show Mode, and DMX Control
- Channel Modes: 7/13 Channel Mode
- Stand Alone or Master-Slave Setup
- N.W.: 4.85 Lbs
- Dimensions: 11" x 5.9" x 5.8"

**ZYST-118****18 PCS LED STROBE LIGHT**

- Voltage: 110V/60Hz
- Power Consumption: 18W
- Lighting Source: 18PCSx1W(R,G,B ) LED
- Control Mode: Automatic, Sound Activated
- Sensitivity Adjustable
- Working Environment: Indoor Use

**ZYST-524L****LED MINI STROBE LIGHT**

- Voltage: 110V/220V ,
- Frequency: 50-60Hz
- Power Consumption: 5W,
- Lamp: 5mm LED Diodes, 24 pcs
- Brightness Adjustable Model or Sound Controlled Model
- Size: 160x160x180mm Weight: 0.55KG

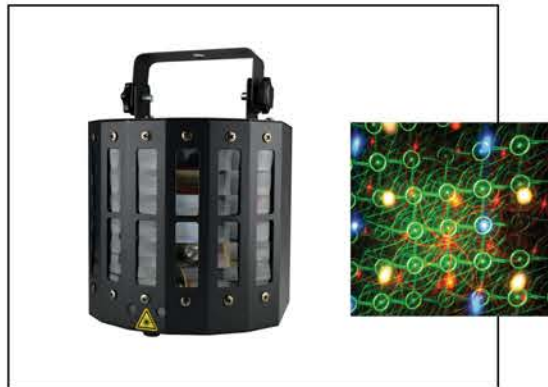
**ZYL-93R****LED LASER DERBY LIGHT**

- 8x DMX Channels
- 9 x 3W LED: Red - Green/Blue/White/Amber/Pink/ Yellow/Orange/Violet
- 1 x 120mW Red Laser
- 1 x 30mW Green Laser
- 8 x Built-In Laser Shows
- Dimmer & Strobe
- Auto, Master-Slave, Sound-Controlled or DMX Operation
- Safety Switch and Remote Control
- Power Supply: 100V AC, 60Hz
- Consumption: 40W
- Laser Class: 3
- Dimensions: 7.3" x 6.4" x 8.3"
- Weight: 3.3 Lbs

**ZYF-C34****MINI LED DERBY**

- Power Supply: AC 127V, 60Hz
- Power Consumption: 15W
- Light Source: 4 x 3W RGBW LEDs (R1, G1, B1, W1)
- Operating Mode: Auto, Sound
- Housing: Clear Plastic Housing
- Dimension: 6.9" x 4.5" x 5.8" (175x115x148mm)
- Net Weight: 0.84lbs (380 g)

**GTS-1200LED (LED)****LED STROBE LIGHT**

- 110V
- 4 Color Shields to choose from
- Adjustable Speed
- Bright white large LEDs
- Sturdy wood casing





**ZYL-101**

MINI LASER STAGE LIGHT

- Projects Over 5000 Laser Beams and Motion Effects
- Boundless Fireflies are Projected as Stars in the Sky
- Widely Used in Family Parties, Suitable for Toy and Unique Gift etc.
- Sound/Auto/Strobe Control
- Speed/Sensitivity Adjustable
- Laser Power: Red≥60mV, Green≥8mV
- Input Power: DC 5V, 1A
- Dimension: 4.7" x 3.7" x 1.9" (120x94.5x49mm)
- Weight: 0.77lb (0.35Kg)



**ZYL-114RG**

LASER KALEIDOSCOPE

- Kaleidoscope of Various Patterns
- True Colorful Patterns such as Bubbles, Flowers, Flying Butterflies and Many More
- Patterns Move to the Beat Alternating Between Red and Green
- Colorful Patterns Display in Accordance with Music
- Sound/Auto Control
- Laser Power: Red: 100mW, Green: 25-45mW
- Input Power: DC 5V, 1A
- Dimension: 5.1" x 6.3" x 2.6" (130x160x65mm)
- Weight: 2lb (0.9Kg)

**ZYL-302R**

LED STAGE LIGHT

- Voltage/Frequency: 100-240V/50-60Hz
- Lighting Source: 252 LED/84 x RGB
- LED Section: 8 Sections
- Power Consumption: 36W
- Control Mode: Automatic, Sound, DMX, Master-Slave
- DMX Channel: 2, 3, 4, 7, 14, 26
- Light Angle: 40°
- Effect: Color-Mixing Wash Wall Effect
- Dimensions: 39.8" x 2.4" x 2.4" (1010 x 60 x 60mm)
- Gross Weight: 3.73Lbs (1.69Kg)
- Standard Configuration: Power Cable



**ZYLD-610**

LED PROJECTOR

- Input Voltage: 100V~240V AC, 50-60Hz
- Output Voltage: 12V; Output Current: 500mA
- LED Source: Red x 1pc, Green x 1pc, Blue x 1pc, White x 1pc; Total 4w
- Power: 4.2~4.8W
- IP44
- Dimension: 3.9" x 3.9" x 14.2" (98 x 98 x 360mm)
- Working Temperature: -10°C~+35°C
- Stock Temperature: -40°C~+70°C



**ZYL-0D-004R**

LASER LIGHT

- Laser Classification: CLASSIIIA
- Power Input: 100V~240V AC (Adaptor Included)
- Built-In Light Sensor
- Maximum Power Output: Less than 5mW
- Wave Lengths: 532nm~650nm
- Weather Resistant Housing
- Operation: Indoor/Outdoor
- With Extra Long Lawn Stake for Outdoor Use
- Operating Temp: -10°F~100°F
- Projection Coverage: 3000+ Sq.Ft.



**ZYL-252BLUE**

DOUBLE HEAD BLUE LASER

- Laser Diode: Blue
- Laser Supply: AC 100-240V
- Laser Power: 400-550mW
- Scanner Angle: ±1°
- Control Mode: DMX 512, Sound, Automatic
- Dimensions: 308 x 210 x 160mm
- Net/Gross Weight: 2.5/2.7kg
- Effect: Displays more than 50 Light Beams and Patterns, Displaying Laser Patterns Specified by International Laser Display Association, Rotating Color Fan, Time and Space Tunnel and Fairy Flowers (can be Programmed with Customers)



**ZYL-300R**

LASER STAGE LIGHT

- Power Supply: 100~240V AC, 50/60Hz
- Laser Power: Red>300mW,
- Scanner Angle: ±18°
- Dimensions: 7.4" x 6.9" x 4.7" (187 x 176 x 120mm)
- Weight: 2.65Lbs (1.2Kg)
- Sound/Auto Control
- Can Project More than 100 Different Laser Beams and different Patterns like: A Wide Single Red Laser Beam, Rotating Color Fan, Space Tunnel and Many More
- Different Patterns can Continuously Strobe or Rotate
- Suitable for Bars, Performing Arts, KTV, Disco Hall



**ZYLB-10253-28**

LED STAGE LIGHT

- Voltage/Frequency: 100-240V/50-60Hz
- Lighting Source: 252 LED/84 x RGB
- LED Section: 8 Sections
- Power Consumption: 36W
- Control Mode: Automatic, Sound, DMX, Master-Slave
- DMX Channel: 2, 3, 4, 7, 14, 26
- Light Angle: 40°
- Effect: Color-Mixing Wash Wall Effect
- Dimensions: 39.8" x 2.4" x 2.4" (1010 x 60 x 60mm)
- Gross Weight: 3.73Lbs (1.69Kg)
- Standard Configuration: Power Cable

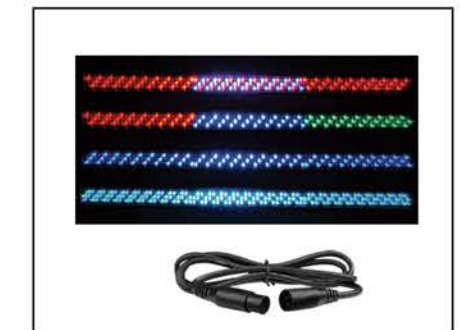

**ZYLB-10252-28**

LED STAGE LIGHT

- Light Source: 252pcs LED/84xRGB
- LED Section: 4 Sections
- Power Supply: 100-240V/50-60Hz
- Power Rating: 28W
- Control Mode: Auto/Sound/DMX/Master-Slave
- DMX Channel: 7
- Light Angle: 30°
- Effect: Color-Mixing Wash Wall Effect
- Dimensions: 39.8" x 2.4" x 2.4" (1010 x 60 x 60mm)
- Gross Weight: 5.51lbs(2.5Kg)
- Standard Configuration: Power Cable



## DISCO LIGHT

### FOG MACHINES



#### ZSM-401L

400W TRANSPARENT HOUSING FOG MACHINE

- Voltage: AC 110V
- LED Color: Each 3W LED Contains 3 Colors in 1
- Power: 400W
- Heat-Up Time: 8 Minutes
- Tank Capacity: 0.3L
- Projection Distance: 3.5M
- Smoke Output: 14M<sup>3</sup>/Min
- Control Mode: Wired Remote Control
- Weight: 1.8KG
- Dimensions: 290 x 150 x 140mm



## DISCO LIGHT

### FOG MACHINES



#### ZSM-400ST

SMOKE MACHINE

- Voltage/Frequency: AC 110V/60Hz
- Power Consumption: 400W
- Control Mode: Remote Control
- Warm-Up Time: 7 Min



#### ZSM-1500R

WIRELESS REMOTE OR MANUALLY TRIGGERED MACHINE

- Voltage: 110V, 50/60Hz
- Power: 1500W
- Nozzle Heating Time: 10 Min
- Fog Volume: 166 M<sup>3</sup>/Min
- Pot of Capacity: 2.3 L
- Spray Smoke Height: 7M
- Control System: Wire Control/Remote Control
- Remote Control Range: 25M
- The Shell: Resin Powder Coating Metal Plate
- Matching Control: Remote Control Using the Same Code as Synchronous Control, Delay Error 0.1-0.5 Seconds
- Weight: 11Lbs (5kg)
- Dimensions: 18.5" x 12.2" x 7.9"



#### ZSM-403SLED

400W LED FOG MACHINE

- Voltage: 110V, 50Hz
- LED Color: 3PCs 1W RGB 3 in 1
- Power Consumption: 400W
- Heat-Up Time: 5 Minutes
- Tank Capacity: 0.3L
- Projection Distance: 3.5M
- Smoke Output: 14M<sup>3</sup> / Min
- Control Mode: Wired Remote Control
- Weight: 1.8Kg
- Dimensions: 290x150x140mm



#### ZSM-900ULED

PROFESSIONAL 900W FOG MACHINE

- Voltage: 110V, 60Hz
- Power: 900W
- Tank Capacity: 1 Litre
- Light Source: 6 Pcs x 3W 3 in 1 LED
- Heat-Up Time: 5 Min
- Fog Volume: 18000 cu.ft/min
- Remote Control Range: 20M
- Control Mode: DMX / Wire Control and Wireless Remote Control
- Weight: 6.2 Lbs (2.8KG)
- Dimensions: 13.4" x 11" x 6.3"



#### ZSM-1006SLED

PROFESSIONAL 950W FOG MACHINE

- Voltage: 110V, 60Hz
- Power: 950W
- Tank Capacity: 1 Litre
- Light Source: 6 Pcs x 3W 3 in 1 LED
- Heat-Up Time: 5 Min
- Fog Volume: 18000 cu.ft/min
- Remote Control Range: 20M
- Control Mode: DMX / Wire Control and Wireless Remote Control
- Weight: 7 Lbs (3.2KG)
- Dimensions: 15.7" x 9.4" x 7.9" (400 x 240 x 200mm)



#### ZSM-900ST

900 SMOKE MACHINE

- Power Supply: AC220V +5% 50-60Hz
- Power Consumption: 900W
- Tank: 2.5L
- Size: 410x225x250mm
- Weight: 4.6Kg



## DISCO LIGHT

### FLUIDS

#### TF-025

##### FOG FLUID

- Compatible with Water-Based Machines
- 1 Quart (946L)



#### TF-100

##### FOG FLUID

- Compatible with Water-Based Machines
- 1 Gallon (3.785L)



#### TFS-20Z-LM

##### FLUID SCENT

- Lime Mint
- 2 Fl. Oz. (60mL)



#### TFS-20Z-MM

##### FLUID SCENT

- Mojito Mint
- 2 Fl. Oz. (60mL)



#### TFS-20Z-PM

##### FLUID SCENT

- Pepper Mint
- 2 Fl. Oz. (60mL)



#### TLS-160MJ

##### DISCO LIGHT STAND

- Minimum Height: 1.4m
- Maximum Height: 3.5m
- Weight: 7kg (15.4 lbs)



#### TLS-275MJ

##### DISCO LIGHT STAND

- Ideal for Light Weight Lighting Fixtures
- Great for Night Clubs, Mobile DJ'S and any Occasion
- Fast and Easy Setup
- Conveniently Holds up to 8 Disco Lights
- Minimum Height: 4.8' (1.45M)
- Maximum Height: 11.5' (3.5M)
- Arm Length: 3.9' (1.2M)
- Load Capacity: 132.3Lbs (60Kg)
- Net Weight: 15.4Lbs (7Kg)"

#### Metal Joints



ADJUSTABLE STABILIZATION



ADJUSTABLE HEIGHT



#### TLS-350MJ

##### PORTABLE TRUSS SYSTEM

- Ideal for Light Weight Lighting Fixtures
- Great for Night Clubs, Mobile DJ's and any Occasion
- Fast and Easy Set Up
- Conveniently Holds up to 20 Disco Lights
- Minimum Height: 5.9' (1.8M)
- Maximum Height: 11.5' (3.5M)
- Arm Length: 3.9' (1.2M)
- Pipe Length: 9.8' (3M)
- Load Capacity: 242.5 Lbs (110Kgs)
- Net Weight: 44.1 Lbs (20Kgs)

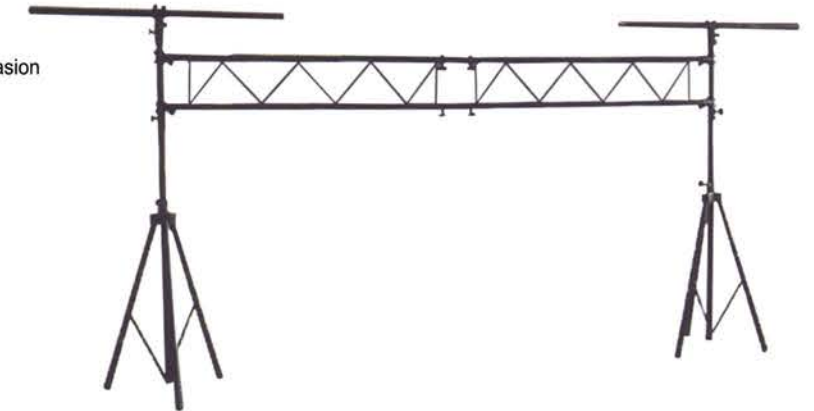

#### ZY-CL3548-80K

##### DISCO LIGHT CLAMP

- Diameter: 35mm to 48mm
- Supports up to 80kg (176 lbs)



#### ZY-CL4252-100K

##### DUAL SWIVEL DISCO LIGHT CLAMP

- Fits on a 40mm - 52mm Truss
- Maximum Bearing Weight of 100Kg
- Made of Polished Cast-Aluminum
- Suitable for moving Head Light, LED Par Light, LED Par Can, Disco Light, DJ Light Etc.



#### ZY-CL4252-200K

##### DISCO LIGHT CLAMP

- Diameter: 42mm to 52mm
- Supports up to 200kg (440 lbs)

### STANDS/ACCESSORIES

## ZLPB-A275L

## LED PARTYBAR

- 2 x PAR Cans Fitted with 3pcs 4 IN 1 4W LEDs
- 2 x LED Derby Effects with 4 x 3W LEDs
- 1x Laser 30mw 532nm Green Diode + 100mw 650nm Red Diode
- 1x Wireless Foot Pedal
- 1x Remote Controller
- 1x Power Cable 3M
- 1x Stand 2.5M
- 1x Black Bag
- Crossbar that Powers the PAR Cans
- 3/7/16-Channel DMX, Master-Slave, Auto & Remote Control
- Pre-Mounted DMX Signal Cable on all 4 x Cans
- Voltage: AC110V, 50/60Hz
- Power: 60W
- Height: 2.5m Maximum
- Weight: 14.6 Lbs (6.6kg)
- Dim: 37.8" x 11" x 6.7" (960 x 280 x 170mm)
- Features: Plug and Play, Easy to Use, Sound Active, Auto Mode, Remote Control, Foot Pedal Control, Transparent Enclosure, High Light Output, Energy Saving
- LEDs Create Super Full Color Wash Effect
- Set Up and Ready to Rock the Stage in Minutes
- Individual Position Per Par Can
- Can be Mounted on the Supplied Lighting Stand

NOW  
WITH  
LASERMAX  
HEIGHT:  
8'-2"

## ZLPB-B265

## LED PARTY BEAM LIGHT BAR W/BAG

- Remote Control
- Power Cable 4m
- Crossbar that Powers the PAR Cans
- 2 x PAR Cans Fitted with 12 x 1W RGBW LEDs
- 2 x Moon Flower Effects with RGBWA LEDs
- 3/6/15-Channel DMX, Master Slave, Auto, and Remote Control
- Pre-Mounted DMX Signal Cable on all 4 Cans
- 2 x Travel bags
- Features: Plug and Play, Easy to Use, Sound Active or Auto Mode, High Light Output, Energy Saving
- LED's Create Super Full Color Wash Effect
- Set Up and Ready to Rock the Stage in Minutes
- Can be Mounted on the Supplied Lighting Stand
- Individual Position per PAR Can
- Pre-Mounted DMX Signal Cable on all 4 Cans
- Voltage: AC110V, 50/60Hz
- Power: 60W
- Dimensions: 31.5" x 9" x 6.7"
- Height: 6 Ft Maximum
- Weight: 12.3 Lbs

Includes  
2 Travel Bags

## ZLPB-D243

## LED PARTY DERBY LIGHT BAR W/BAG

## Items Included

- Remote Control
- Power Cable 4m
- Crossbar that Powers the PAR Cans
- 2 x PAR Cans Fitted with 12 x 1W RGBW LEDs
- 2 x Moon Flower Effects with RGBWA LEDs
- 3/6/15-Channel DMX, Master Slave, Auto, and Remote Control
- Pre-Mounted DMX Signal Cable on all 4 cans
- 2 x Travel Bags
- Features: Plug and Play, Easy to Use, Sound Active or Auto Mode, High Light Output, Energy Saving
- LED's Create Super Full Color Wash Effect
- Set Up and Ready to Rock the Stage in Minutes
- Can be Mounted on the Supplied Lighting Stand
- Individual Position per PAR Can
- Pre-Mounted DMX Signal Cable on all 4 Cans
- Voltage: AC110V, 50/60Hz
- Power: 60W
- Dimensions: 31.5" x 9" x 6.7"
- Height: 6 FT Maximum
- Weight: 12.3 Lbs

Includes  
2 Travel Bags

## ZEZ-8008

## 8 CHANNEL ON/OFF DISCO LIGHT CONTROL

- Switching Pack
- Connector Cable
- 8 Channels with ON/OFF Control
- Flash ON/OFF Button for Each Channel
- Switch Pack Features Eight 3-Prong Switching Plugs and 1 Uninterrupted Power Plug
- Super-Sized Momentary Switches
- Larger ON/OFF Button
- Input Voltage: 110V 60Hz
- Rated Power: 30W
- ON/OFF Fuse: 3A
- Plug Fuse: 15A



## ZYD-DMX512

## PROFESSIONAL LIGHTING DMX CONTROLLER

- Voltage: AC110V/60Hz
- Electric Current: No Less Than 300mA
- Power Consumption: 5W
- External Power Transformer
- Fast Programming, Memorizes the Program, LCD Display, Easy Operation
- Standard DMX 512 Signal
- MID: IN/OUT, Built-In Mic Input
- This Controller has 8 Outlets /192 DMX 512 Channels Output it can Control up to 12 Moving Lights (EACH Outlets has 16 Channels)



## ZPC-8000

## RACK MOUNT POWER STRIP

- Voltage: 110V/60Hz
- Includes 8 Outlets
- Offers 15 Amp AC Power Distribution
- Rack Mountable Using 1 Rack Space (1U)



## ZMB-12 (12" Mirror Ball)

## ZMB-16 (16" Mirror Ball)

## SINGLE COLOR MIRROR BALL WITH MOTOR

- Polyfoam Inner Ball
- ABS Center Core
- Available in 12", 16", 20"



## ZMR-3MTR

## MIRROR BALL MOTOR

- Power: 110-120V, 50/60Hz, 4W
- Motor Speed: 2.5-3 RPM
- Fits up to 12" & 16"



DMX CONNECTION CABLES

ZDMX-3XLRMF-12B

3 Pin XLR Male to XLR Female DMX Cable

- 12"
- Premium Jacket Materials Provide Ease of Handling and Long Service Life
- Bright Nickel-Plated Connectors for Long Term Good Looks and Conductivity
- 24 AWG Oxygen-Free Copper Stranded Conductors for Maximum Signal Transfer



ZDMX-3XLRMF-20B

3 Pin XLR Male to XLR Female DMX Cable

- 20"
- Premium Jacket Materials Provide Ease of Handling and Long Service Life
- Bright Nickel Plated Connectors for Long Term Good Looks and Conductivity
- 24 AWG Oxygen-Free Copper Stranded Conductors for Maximum Signal Transfer



ZDMX-3XLRMF-30B

3 Pin XLR Male to XLR Female DMX Cable

- 30"
- Premium Jacket Materials Provide Ease of Handling and Long Service Life
- Bright Nickel Plated Connectors for Long Term Good Looks and Conductivity
- 24 AWG Oxygen-Free Copper Stranded Conductors for Maximum Signal Transfer



ZDMX-5XLRMF-12B

5 Pin XLR Male to XLR Female DMX Cable

- 12"
- Premium Jacket Materials Provide Ease of Handling and Long Service Life
- Bright Nickel Plated Connectors for Long Term Good Looks and Conductivity
- 24 AWG Oxygen-Free Copper Stranded Conductors for Maximum Signal Transfer



ZDMX-5XLRMF-20B

5 Pin XLR Male to XLR Female DMX Cable

- 20"
- Premium Jacket Materials Provide Ease of Handling and Long Service Life
- Bright Nickel Plated Connectors for Long Term Good Looks and Conductivity
- 24 AWG Oxygen-Free Copper Stranded Conductors for Maximum Signal Transfer



ZDMX-5XLRMF-30B

5 Pin XLR Male to XLR Female DMX Cable

- 30"
- Premium Jacket Materials Provide Ease of Handling and Long Service Life
- Bright Nickel Plated Connectors for Long Term Good Looks and Conductivity
- 24 AWG Oxygen-Free Copper Stranded Conductors for Maximum Signal Transfer



POWER PRODUCTS





4 AMPS - 6 VOLTS

**RB4-6**  
 • Nominal Voltage (V): 6  
 • Nominal Capacity (20H.R) (AH): 4.5  
 • Length:(in)2.76 (mm)70 • Width:(in)1.89 (mm)48  
 • Height:(in)3.98 (mm)101 • With Terminal: (in)4.21 (mm)107  
 • Weight: (Lbs) 1.63 (kgs) 0.74



7 AMPS - 12 VOLTS

**RB7-12**  
 • Nominal Voltage (V): 12  
 • Nominal Capacity (20H.R) (AH): 7  
 • Length:(in)5.95 (mm)151 • Width:(in)2.56 (mm)65  
 • Height:(in)3.7 (mm)94 • With Terminal: (in)3.94 (mm)100  
 • Weight: (Lbs) 4.96 (kgs)2.25



**RB2.6-12**  
 SEALED LEAD-ACID RECHARGEABLE BATTERY

2.6 AMPS - 12 VOLTS



**RB4-3**  
 RECHARGEABLE BATTERY **3 AMPS - 4 VOLTS**  
 • 4V, 3.0Ah  
 • Cycle Use: 4.80V-5.00V  
 • Standby Use: 4.50V-4.60V  
 • Maximum Charging Current: 0.90A



8 AMPS - 6 VOLTS

**RB8-6**  
 • Nominal Voltage (V): 6  
 • Nominal Capacity (20H.R) (AH): 8  
 • Length:(in)5.95 (mm)151 • Width:(in)1.97 (mm)50  
 • Height:(in)3.7 (mm)94 • With Terminal: (in)3.94 (mm)100  
 • Weight: (Lbs) 3.41 (kgs) 1.55



9 AMPS - 12 VOLTS

**RB9-12** (Replacement for ER-770)  
 • Nominal Voltage (V): 12  
 • Nominal Capacity (20H.R) (AH): 9  
 • Length:(in)5.95 (mm)151 • Width:(in)2.56 (mm)65  
 • Height:(in)3.7 (mm)94 • With Terminal: (in)3.94 (mm)100  
 • Weight: (Lbs) 5.3 (kgs)2.40



**RB4-12**  
 RECHARGEABLE BATTERY **4 AMPS - 12 VOLTS**  
 • 4 Amp 12 Volt



**RB4.5-12** **4.5 AMPS - 12 VOLTS**  
 FOR STAND-BY USE: Charging Voltage: 6V (6.8-6.9) 12V (13.6-13.7)  
 FOR CYCLE USE: Charging Voltage: 6V (7.3-7.5) 12V (14.6-15.0)  
 • Charging Current (A): 0.1C-0.25C  
 "C" means Ah Value of Battery Rated Capacity



10 AMPS - 6 VOLTS

**RB10-6**  
 • Nominal Voltage (V): 6  
 • Nominal Capacity (20H.R) (AH): 10  
 • Length:(in)5.95 (mm)151 • Width:(in)1.97 (mm)50  
 • Height:(in)3.7 (mm)94 • With Terminal: (in)3.94 (mm)100  
 • Weight: (Lbs) 4.17 (kgs)1.89



10 AMPS - 12 VOLTS

**RB10-12**  
 • Nominal Voltage (V): 12  
 • Nominal Capacity (20H.R) (AH): 10  
 • Length:(in)5.95 (mm)151 • Width:(in)3.9 (mm)99  
 • Height:(in)3.74 (mm)95 • With Terminal: (in)3.97 (mm)101  
 • Weight: (Lbs) 8.6 (kgs)3.9



**RB40-12**  
 RECHARGEABLE BATTERY  
 • 40 Amp 12 Volt

40 AMPS - 12 VOLTS



**RB65-12**  
 RECHARGEABLE BATTERY  
 • Maintenance - Free  
 • 12V - 65Ah

65 AMPS - 12 VOLTS



12 AMPS - 12 VOLTS

**RB12-12**  
 • Nominal Voltage (V): 12  
 • Nominal Capacity (20H.R) (AH): 12  
 • Length:(in)5.95 (mm)151 • Width:(in)3.9 (mm)99  
 • Height:(in)3.74 (mm)95 • With Terminal: (in)3.97 (mm)101  
 • Weight: (Lbs) 8.6 (kgs)3.9



17 AMPS - 12 VOLTS

**RB17-12**  
 • Nominal Voltage (V): 12  
 • Nominal Capacity (20H.R) (AH): 17  
 • Length:(in)7.13 (mm)181 • Width:(in)2.99 (mm)76  
 • Height:(in)6.57 (mm)167 • With Terminal: (in)6.57 (mm)167  
 • Weight: (Lbs) 14.32 (kgs)6.5



**AR-UV**  
UV METER  
• For all Nippon America Voltage Regulators

- AR-500 (500 Watts)
  - AR-1000 (1000 Watts)
  - AR-2000 (2000 Watts)
  - AR-3000 (3000 Watts)
  - AR-5000 (5000 Watts)
- VOLTAGE REGULATOR
- Input: 180-260V, 75-130V
  - Output: 110V/220V
  - Phase: Single
  - Frequency: 50/60Hz



**Automatic Voltage Regulator**  
Regulador Automático de Voltaje

**AR-500**

**Features:**

- Regulates wide range of voltage, allowing electric items to be used during voltage fluctuations
- Equipped with delay output protection circuit
- Equipped with protection device for exceeding high voltage

**Características:**

- Regula amplia gama de voltaje, permitiendo utilizar artículos eléctricos durante las fluctuaciones de tensión.
- Equipado con circuito de protección de salida de retardo
- Equipado con un dispositivo de protección por exceso de alta tensión

---

**Automatic Voltage Regulator**  
Regulador Automático de Voltaje

**AR-1000**

**Features:**

- Regulates wide range of voltage, allowing electric items to be used during voltage fluctuations
- Equipped with delay output protection circuit
- Equipped with protection device for exceeding high voltage

**Características:**

- Regula amplia gama de voltaje, permitiendo utilizar artículos eléctricos durante las fluctuaciones de tensión.
- Equipado con circuito de protección de salida de retardo
- Equipado con un dispositivo de protección por exceso de alta tensión

---

**Automatic Voltage Regulator**  
Regulador Automático de Voltaje

**AR-2000**

**Features:**

- Regulates wide range of voltage, allowing electric items to be used during voltage fluctuations
- Equipped with delay output protection circuit
- Equipped with protection device for exceeding high voltage

**Características:**

- Regula amplia gama de voltaje, permitiendo utilizar artículos eléctricos durante las fluctuaciones de tensión.
- Equipado con circuito de protección de salida de retardo
- Equipado con un dispositivo de protección por exceso de alta tensión

---

**Automatic Voltage Regulator**  
Regulador Automático de Voltaje

**AR-3000**

**Features:**

- Regulates wide range of voltage, allowing electric items to be used during voltage fluctuations
- Equipped with delay output protection circuit
- Equipped with protection device for exceeding high voltage

**Características:**

- Regula amplia gama de voltaje, permitiendo utilizar artículos eléctricos durante las fluctuaciones de tensión.
- Equipado con circuito de protección de salida de retardo
- Equipado con un dispositivo de protección por exceso de alta tensión

---

**Automatic Voltage Regulator**  
Regulador Automático de Voltaje

**AR-5000**

**Features:**

- Regulates wide range of voltage, allowing electric items to be used during voltage fluctuations
- Equipped with delay output protection circuit
- Equipped with protection device for exceeding high voltage

**Características:**

- Regula amplia gama de voltaje, permitiendo utilizar artículos eléctricos durante las fluctuaciones de tensión.
- Equipado con circuito de protección de salida de retardo
- Equipado con un dispositivo de protección por exceso de alta tensión



**ASERV-1000C**  
1KVA AUTOMATIC VOLTAGE REGULATOR

- Servo Motor Transformer
- Wide Input Voltage Range: 80-260V
- Dual Output: 110V AC and 220V AC at the Same Time
- Advanced CPU Control Circuit
- Automatic 10 Second Countdown Delay Function Integrate
- Full Protection Design: High Voltage/Low Voltage/High Temperature/Short Circuit
- Accurate Output Regulation:  $\pm 3\%$



**ASERV-2000C**  
2KVA AUTOMATIC VOLTAGE REGULATOR

- Servo Motor Transformer
- Wide Input Voltage Range: 80-260V
- Dual Output: 110V AC and 220V AC at the Same Time
- Advanced CPU Control Circuit
- Automatic 10 Second Countdown Delay Function Integrate
- Full Protection Design: High Voltage/Low Voltage/High Temperature/Short Circuit
- Accurate Output Regulation:  $\pm 3\%$



**ASERV-3000C**  
3KVA AUTOMATIC VOLTAGE REGULATOR

- Servo Motor Transformer
- Wide Input Voltage Range: 80-260V
- Dual Output: 110V AC and 220V AC at the Same Time
- Advanced CPU Control Circuit
- Automatic 10 Second Countdown Delay Function Integrate
- Full Protection Design: High Voltage/Low Voltage/High Temperature/Short Circuit
- Accurate Output Regulation:  $\pm 3\%$



**ASERV-5000C**  
5KVA AUTOMATIC VOLTAGE REGULATOR

- Servo Motor Transformer
- Wide Input Voltage Range: 80-260V
- Dual Output: 110V AC and 220V AC at the Same Time
- Advanced CPU Control Circuit
- Automatic 10 Second Countdown Delay Function Integrate
- Full Protection Design: High Voltage/Low Voltage/High Temperature/Short Circuit
- Accurate Output Regulation:  $\pm 3\%$





- ATVR-500 (500 VA)
- ATVR-1000 (1000 VA)
- ATVR-2000 (2000 VA)
- VOLTAGE REGULATOR
- Input: 80-140V/120-240V
- Output: 110/220V
- Frequency: 50-60Hz
- Delay Function



2KVA Power

Voltage Input  
80-140V  
140-260V

ATVR-15000 (15000 VA)  
SINGLE PHASE VOLTAGE REGULATOR

TECHNICAL SPECIFICATIONS:

- Power: 15,000 VA
- Input: 80-260V AC
- Output: 110/220V ~
- Frequency: 50/60Hz
- Precision:  $\pm 8\%$
- Delay Time: 6S/360S Selectable
- Available in Black or White

FEATURES:

- CRGO Transformer, LED Digital Display
- Servo Type, Single Phase
- High Voltage Protection
- Low Voltage Protection
- Overload Protection
- High Temperature Protection
- Short Circuit Protection

15K WATTS



ATVR-20000 (20000 VA)  
SINGLE PHASE VOLTAGE REGULATOR

TECHNICAL SPECIFICATIONS:

- Power: 20,000 VA
- Input: 80-260V AC
- Output: 110/220V ~
- Frequency: 50/60Hz
- Precision:  $\pm 8\%$
- Delay Time: 6S/360S Selectable
- Available in Black or White

FEATURES:

- CRGO Transformer, LED Digital Display
- Servo Type, Single Phase
- High Voltage Protection
- Low Voltage Protection
- Overload Protection
- High Temperature Protection
- Short Circuit Protection

20K WATTS



- ATVR-5000 (5000 VA)
- ATVR-8000 (8000 VA)
- ATVR-10000 (10000 VA)
- VOLTAGE REGULATOR
- Input: 80-140V/120-240V
- Output: 110V/220V
- Frequency: 50/60Hz
- Delay Function



5KVA Power

Voltage Input  
80-140V  
140-260V



**DPWS-3012DS**

30 AMP DC SWITCHING POWER SUPPLY

- Input Voltage: 110AC, 60Hz
- Output Voltage: 13.8VDC, Adjusts Voltage between 9.0V and 15.0V
- Output Voltage Regulation: <2%
- Protection: Short-Circuit, Automatic Current Limiting Over 30A
- Output Current: 30A (Max) 20A (Continuous)
- Fuse: 8A
- Meter: Output Voltage and Current, Back-Lit
- Dimensions: 155 x 70 x 205mm
- Weight: Approx. 1.5Kg



**DPWS-5012DS**

50 AMP DC SWITCHING POWER SUPPLY

- Input Voltage: 110AC, 60Hz
- Output Voltage: 9.15VDC Regulated or 13.8V DC
- Output Voltage Regulation: <2%
- Protection: Short-Circuit, Automatic Current Limiting Over 50A
- Output Current: 50A (Max) 38A (Continuous)
- Fuse: 8A
- Meter: Single Volt/Current Meter, Back-Lit
- Dimensions: 195 x 85 x 280mm
- Weight: Approx. 1.5Kg



**DSPS-5012V**

50 AMP DC SWITCHING POWER SUPPLY

- Adjustable Output Voltage Range: 5-15V DC
- Adjustable Output Current Range: 10-50A DC
- Protection: Short Circuit, Overload, Internal Over-Temperature, Surge, Input Under-Voltage
- Output Voltage Regulation: <1%
- Efficiency: >85%
- Low Ripple



**DSPS-10012V**

100 AMP DC SWITCHING POWER SUPPLY

- Output Voltage Range: 5-15V DC
- Output Current Range: 20-100A DC
- Protection: Short Circuit, Overload, Internal Over-Temperature, Surge, Input Under-Voltage
- Output Voltage Regulation: <1%
- Efficiency: >85%
- Low Ripple

**TPS-946**

SOLAR TRICKLE CHARGER

- Helps to Manage Battery Drain for 12V Batteries
- Package: 12 Pcs/Carton (Foam + Color Inner Carton + Outer Carton)
- Outer Carton Size: 46.7 x 32.5 x 33cm
- Gross Weight: 22kg



**DVP-2712**

DC POWER SUPPLY

- 25 Amp, 27 Amp Surge
- Converts to 13.8V DC
- Low Ripple
- Built-In Surge Protection



**DVP-712 (110V)**

**DVP-220-712 (220V)**

DC POWER SUPPLY

- 5 Amp, 7 Amp Surge
- Converts to 13.8V DC
- Low Ripple
- Built-In Surge Protection



**DVP-512LJ (5 Amp, 7 Amp Surge)**

DC POWER SUPPLY WITH LIGHTER JACK

- Converts to 13.8V DC
- Low Ripple
- Built-In Surge Protection



**DVP-512 (110V)**

**DVP-220-512 (220V)**

DC Power Supply

- 3 Amp, 5 Amp Surge
- Converts to 13.8V DC
- Low Ripple
- Built-In Surge Protection



**DVP-515 (110V)**

- 5 Amp Surge
- Converts to 1.5V-15V DC
- Low Ripple
- Built-In Surge Protection
- Voltage Adjustment Switch

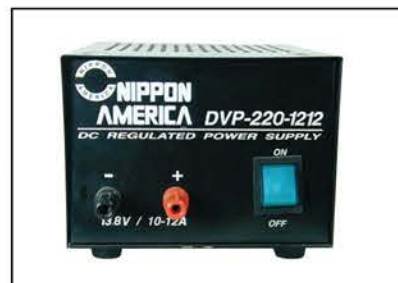

**DVP-1212 (110V)**

**DVP-220-1212 (220V)**

- 10 Amp, 12 Amp Surge
- Converts to 13.8V DC
- Low Ripple
- Built-In Surge Protection



**DVP-2212 (110V)**

**DVP-220-2212 (220V)**

- DC Power Supply
- 20 Amp, 22 Amp Surge
- Converts to 13.8V DC
- Low Ripple
- Built-In Surge Protection



**DV-337CL**

- AC/DC Adapter with Lighter Jack
- Input: 110V AC
- Output: 12V, 1A DC
- Compact Style
- Wall Mount

**DVP-305VR**

VARIABLE DC POWER SUPPLY

- Applicable for School, Small Hobbyist, Laboratory, Repair Center and more
- Provides a Circuit Overload Protection, Reverse Polarity Protection and Short Circuit Protection
- PCB Construction by SMD Adhesive Sheet Element Technology, Highly Reliable
- Fine and Coarse Adjustment of Regulated Current and Voltage Values from 0-30V and 0-5A for Multiple Uses
- Auto Cooling Fan Turns on when Temperature Reaches 50°C (115°F)
- All Metal Construction and Compact Design, Features Elegant Appearance and Power Saving
- Power: 150W
- Display: 3 Digits Green LED x 2 Set
- Display Error of Current: ±1.0% + 2 Digits
- Constant Voltage: Output Voltage: 0-30V Line Regulation: 0.01%+3mV Load Regulation: 0.01%+5mV Ripple Voltage: 1.0mV (RMS)
- Constant Current: Output Current: 0-5A Line Regulation: 0.2%+3mA Load Regulation: 0.2%+3mA Ripple Current: 3.0mA (RMS)
- Input Voltage: AC 110V ± 10%, 60Hz
- Weight: 11.7 lbs (5.3Kg)
- Dimensions: 11" x 5.4" x 6.3" (280 x 136 x 160mm)



**TUD-100 (100 Watts)**

**TUD-200 (200 Watts)**

**TUD-300 (300 Watts)**

**TUD-500 (500 Watts)**

**TUD-1000 (1000 Watts)**

**TUD-1500 (1500 Watts)**

**TUD-2000 (2000 Watts)**

TRANSFORMER

- One Socket
- Carrying Needle
- 2 Adapter Plug
- With Input Voltage Selector (110V/220V)
- No Grounding
- Removable Heads for Safety, in Order to Eliminate a Live Wire



**TUD-3000 (3000 Watts)**

**TUD-5000 (5000 Watts)**

TRANSFORMER

- Two Socket
- With Double Power Cord
- Carrying Handle
- No Grounding
- Removable Heads for Safety, in Order to Eliminate a Live Wire

This Series of Step Up/Down Voltage Transformers Offer you a Safe, Reliable, Affordable, and Convenient Solution to Converting Voltages from 110/120 Volts up to 220/240 Volts or from 220/240 Volts down to 110/120 Volts for both Home Use and Industrial Applications.



**TVS-100 (100 Watts)**

**TVS-200 (200 Watts)**

**TVS-300 (300 Watts)**

**TVS-500 (500 Watts)**

TRANSFORMER

- One Socket
- Carrying Needle
- With Three-Prong Plugs
- With Input Voltage Selector (110V/220V)
- Two Free Spare Fuses
- With Grounding
- IEC Socket for Grounded Connection and Elimination of Live Wire

**TVS-1000 (1000 Watts)**

**TVS-1500 (1500 Watts)**

**TVS-2000 (2000 Watts)**



**TVS-3000 (3000 Watts)**

**TVS-5000 (5000 Watts)**

TRANSFORMER

- Two Socket
- With Double Power Cord
- Carrying Handle
- With Grounding
- IEC Socket for Grounded Connection and Elimination of Live Wire

STEP UP & DOWN TRANSFORMER/VOLTAGE CONVERTERS

MATCHING TRANSFORMER



**TUD-10000** (10,000 WATTS)  
STEP UP & DOWN TRANSFORMER

- 10000 step up and down transformer
- Two Socket
- With Double Power Cord
- Carrying Handle
- With Grounding



**TVS-10000** (10,000 WATTS)  
STEP UP & DOWN TRANSFORMER

- 10000 Step Up and Down Transformer
- Two Socket
- With Double Power Cord
- Carrying Handle
- With Grounding

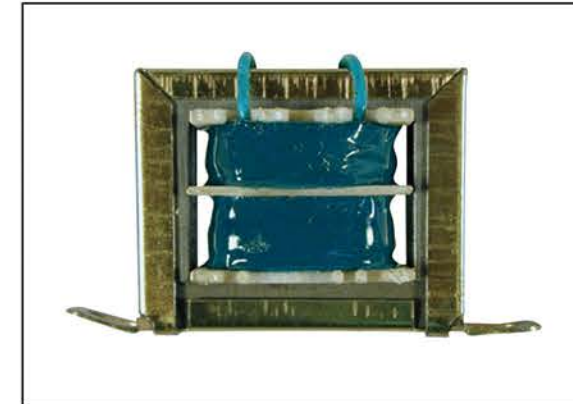

LP-360 (16V,120ma)  
LP-421 (6-0-6V, 0.3A)  
LP-423 (9-0-9V, 0.5A)  
LP-426 (6-0-6V, 0.5A)  
LP-427 (6-0-6V, 1A)  
LP-428 (6-0-6V, 2.A)  
LP-430 (6-0-6V, 4A)  
LP-433 (9-0-9V, 1A)  
LP-435 (9-0-9V, 1.5A)  
LP-437 (9-0-9V, 2A)  
TRANSFORMERS

- Universal
- Center Taps
- 110V/220V
- 9-0-9V, 2A



LP-520 (12-0-12V, 10A)  
LP-570 (12-0-12V, 0.5A)  
LP-573 (12-0-12V, 1A)  
LP-575 (12-0-12V, 2A)  
LP-577 (12-0-12V, 3A)  
LP-580 (12-0-12V, 4A)  
LINE MATCHING TRANSFORMER

- Universal
- Center Taps
- 110V/220V
- 12-0-12V, 3A



**TC-AC-100**  
REPLACEMENT AC CORD FOR  
NIPPON AMERICA TRANSFORMERS



**TC-50D**  
VOLTAGE CONVERTER

- 50W
- Step Down 220v / 240v to 110v/120v



**TCS-50U**  
TRAVEL CONVERTER

- Steps Up 110V/120V AC to 220V/240V
- 50W

**LP-578**  
SPEAKER LINE TRANSFORMER

- 12-0-12V, 4A
- Universal
- Center Taps
- 110/220V

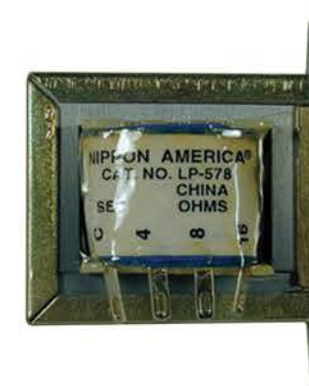

**LP-578-30**  
LINE TRANSFORMER

- Simplifies Proper Installation of Multiple-Speaker PA System
- 30W



**TC-70D**  
VOLTAGE CONVERTER "DELUXE"

- Steps Down 220V to 110V
- 50W



**TC-90**  
INTERNATIONAL VOLTAGE CONVERTER

- Input: AC 110V/220V or 220V/240V
- Output: AC 220V/240V or 110V/220V
- 60W

DC12-2405

DC TO DC VOLTAGE TRANSFORMER

- Input Voltage: DC 24V
- Output Voltage: DC 12V
- Maximum Current: 5A
- Fuse: 5A



DC12-2415

DC TO DC VOLTAGE TRANSFORMER

- Input Voltage: DC 24V
- Output Voltage: DC 12V
- Maximum Current: 15A
- Fuse: 15A



DC12-2430

DC TO DC VOLTAGE TRANSFORMER

- Input Voltage: DC 24V
- Output Voltage: DC 12V
- Maximum Current: 30A
- Fuse: 30A



PIUB-1200-12X

12V DC TO 110V AC POWER INVERTER

- Power: 1200W Max, 600W RMS
- DC Input Voltage: 12V
- Fuse: 25A x 3
- Output Wave Form: **Pure Sine Wave**
- Output Voltage: 110V ± 5%
- Output Frequency: 60Hz ± 5%
- With DC Input Voltage Protection, Short Circuit Protection and Temperature Protection



PIUB-3000-24X

24V DC TO 110V AC POWER INVERTER

- Power: 3000W Max, 1500W RMS
- DC Input Voltage: 24V
- Fuse: 25A x 4
- Output Wave Form: **Pure Sine Wave**
- Output Voltage: 110V ± 5%
- Output Frequency: 60Hz ± 5%
- With DC Input Voltage Protection, Short Circuit Protection and Temperature Protection



PSW-3000C

PURE SINE WAVE POWER INVERTER

- Maximum Continuous Power: 1500W
- Peak Power: 3000W
- Input Voltage: 12V DC (10-15V)
- Output Voltage: 120V AC, 60Hz
- Waveform: Pure Sine Wave
- THD (Total Harmonic Distortion): Less than 4%
- USB Output: 5V DC, 2A Maximum
- Best Efficiency: >85%
- Protection: Overload, Over Voltage, Low Voltage, Over Temperature, Output Short
- Output Receptacle: Dual ETL Approval Sockets
- American Standard Receptacle
- Battery Connecting Cables: Red & Black 2 FT Length
- With ON/OFF Wire Remote Control Kit



PSW-5000C

PURE SINE WAVE POWER INVERTER

- Maximum Continuous Power: 2500W
- Peak Power: 5000W
- Input Voltage: 12V DC (10-15V)
- Output Voltage: 120V AC, 60Hz
- Waveform: Pure Sine Wave
- THD (Total Harmonic Distortion): Less than 4%
- USB Output: 5V DC, 2A Maximum
- Best Efficiency: >85%
- Protection: Overload, Over Voltage, Low Voltage, Over Temperature, Output Short
- Output Receptacle: Dual ETL Approval Sockets
- American Standard Receptacle
- Battery Connecting Cables: Red & Black 2 FT Length
- With ON/OFF Wire Remote Control Kit



**PI-200A**

POWER INVERTER

- Maximum Continuous Power: 200W
- Peak Load Power Rate: Up to 400W
- For Use with 12 Volt Systems
- No Load Current Draw: Up to 0.3 Amps
- Waveform: Modified Sine Wave
- Input DC Voltage Range: DC 11V-15V
- USB Output: 5V/2.4A
- Overload and Short-Circuit Protection
- (1) Replaceable 20 Amp Fuse
- Built-In Cooling Fan
- (2) 110V AC 3 Prong Grounded Receptacles
- Overload Indicator
- 14 AWG 24" Cigarette Plug Cable (Black) with Battery Clamp Included



**PI-400A**

POWER INVERTER

- Maximum Continuous Power: 200W
- Peak Load Power Rate: Up to 400W
- For Use with 12 Volt Systems
- No Load Current Draw: Up to 0.3 Amps
- Waveform: Modified Sine Wave
- Input DC Voltage Range: DC 11V-15V
- USB Output: 5V/2.4A
- Overload and Short-Circuit Protection
- (1) Replaceable 20 Amp Fuse
- Built-In Cooling Fan
- (2) 110V AC 3 Prong Grounded Receptacles
- Overload Indicator
- 14 AWG 24" Cigarette Plug Cable (Black) with Battery Clamp Included



**PIB-300D**

12V DC TO 115V AC POWER INVERTER

- Input: 10.0~15.0V DC
- Power: 300W RMS, 600W Max
- Output: 110~120V AC
- Dual USB Output: 5V, 2A
- Output Frequency: 60Hz±2Hz
- Input Over Voltage Shutdown
- Input Under Voltage Warning
- Input Under Voltage Shutdown
- Input Fuse Protection
- Over Temperature Shutdown
- Output Short Circuit Protection
- Over Load Protection



**PIB-500D**

12V DC TO 115V AC POWER INVERTER

- Input: 10.0~15.0V DC
- Power: 500W RMS, 1000W Max
- Output: 110~120V AC
- Dual USB Output: 5V, 2A
- Output Frequency: 60Hz±2Hz
- Input Over Voltage Shutdown
- Input Under Voltage Warning
- Input Under Voltage Shutdown
- Input Fuse Protection
- Over Temperature Shutdown
- Output Short Circuit Protection
- Over Load Protection



**PIB-750D**

12V DC TO 115V AC POWER INVERTER

- Input: 10.0~15.0V DC
- Power: 750W RMS, 1500W Max
- Output: 110~120V AC
- Dual USB Output: 5V, 2A
- Output Frequency: 60Hz±2Hz
- Input over Voltage Shutdown
- Input Under Voltage Warning
- Input Under Voltage Shutdown
- Input Fuse Protection
- Over Temperature Shutdown
- Output Short Circuit Protection
- Over Load Protection



**PIB-1000D**

12V DC TO 115V AC POWER INVERTER

- Input: 10.0~15.0V DC
- Power: 1000W RMS, 2000W Max
- Output: 110~120V AC
- Dual USB Output: 5V, 2A
- Output Frequency: 60Hz±2Hz
- Input Over Voltage Shutdown
- Input Under Voltage Warning
- Input Under Voltage Shutdown
- Input Fuse Protection
- Over Temperature Shutdown
- Output Short Circuit Protection
- Over Load Protection



**PI-800A**

POWER INVERTER

- Maximum Continuous Power: 800W
- Peak Load Power Rate: Up to 1600W
- For Use with 12 Volt Systems
- No Load Current Draw: Up to 0.9 Amps
- Waveform: Modified Sine Wave
- Input DC Voltage Range: DC 10V-15V
- USB Output: 5V/2.4A
- Overload and Short-Circuit Protection
- (1) Replaceable 30 Amp Fuse
- Built-In Cooling Fan
- (2) 110V AC 3 Prong Grounded Receptacles
- Overload Indicator



**PI-1500A**

POWER INVERTER

- Maximum Continuous Power: 1500W
- Peak Load Power Rate: Up to 3000W
- For Use with 12 Volt Systems
- No Load Current Draw: Up to 0.8 Amps
- Waveform: Modified Sine Wave
- Input DC Voltage Range: DC 10V-15V
- USB Output: 5V/2.4A
- Overload and Short-Circuit Protection
- (1) Replaceable 40Ax4 Fuse
- Built-In Cooling Fan
- (2) 110V AC 3 Prong Grounded Receptacles
- Overload Indicator





PI-DP-2000

12V DC to 110V AC Power Inverter

- Equivalent to Standard Household Power
- Delivers High Quality, Clean Power for Superior Performance
- Easy Motor Start-Ups
- Reduced Noise
- Reduced Stress on Circuitry
- Strong Compatibility with Most Devices
- Cost-Effective
- High Efficiency
- Light and Portable
- Not Compatible with Some Devices

2000  
Watts Power



PI-1000R

POWER INVERTER

- Nominal input voltage: 12.8-13.2V DC
- Nominal output voltage: 115±10%V AC
- Output frequency: 60±3 Hz
- Operating input voltage: 10-15V DC
- Continuous output power: Up to 1000W
- Surge output power: 2000W
- Waveform: Modified sine wave
- Typical No Load Current (nominal input voltage): 0.4A DC
- Efficiency (typical): 85%
- Input overvoltage shutdown: 15.5±0.5V DC
- Input undervoltage alarm: 10.5±0.5V DC
- Input low voltage shutdown: 10.0±0.5V DC
- Output power overload shutdown level: 1300±300W
- Input fuse: 3 x 40A
- AC receptacles: Two, NEMA 5-15 USA
- USB port: Two, 5V/2A
- Battery cables: 8 AWG, 2 x 2'(60cm)



PI-DP-3000

12V DC to 110V AC Power Inverter

- Equivalent to Standard Household Power
- Delivers High Quality, Clean Power for Superior Performance
- Easy Motor Start-Ups
- Reduced Noise
- Reduced Stress on Circuitry
- Strong Compatibility with Most Devices
- Cost-Effective
- High Efficiency
- Light and Portable
- Not Compatible with Some Devices

3000  
Watts Power



PI-1500R

POWER INVERTER

- Nominal input voltage: 12.8-13.2V DC
- Nominal output voltage: 115±10%V AC
- Output frequency: 60±3 Hz
- Operating input voltage: 10-15V DC
- Continuous output power: Up to 1500W
- Surge output power: 3000W
- Waveform: Modified sine wave
- Typical No Load Current (at nominal input voltage): 0.5A DC
- Efficiency (typical): 85%
- Input overvoltage shutdown: 15.5±0.5V DC
- Input undervoltage alarm: 10.5±0.5V DC
- Input low voltage shutdown: 10.0±0.5V DC
- Output power overload shutdown level: 1800±300W
- Input fuse: 6 x 30A
- AC receptacles: Two, NEMA 5-15 USA
- USB port: Two, 5V/2A



INVERTERS

PI-800C

Power Inverter

- Max continuous power: 800W
- Peak load power rate: up to 1600W
- For use with 12V DC voltage systems
- No load current draw: up to 0.9 Amps
- Waveform: modified sine wave
- Input DC voltage range: 10V-15V DC
- USB Output: 5V/2.4A
- Overload and short-circuit protection
- (1) Replaceable 30 Amp fuse
- Built in cooling fan
- (2) 120V AC Volt 3 prong grounded American standard receptacles
- Overload indicator



Convert 24V DC from your car lighter socket to 120V AC outlet, ideal for use at campsites, road trips or anywhere dc to ac inverter is needed. Combine 2 AC outlets and 1 USB charging ports into one, ideal for charging up to 3 devices simultaneously. Built-in fuse & cooling fan, protection against short circuit, overload, overheat, low battery voltage and over battery voltage, will auto-resume after protection triggered.

AC POWER INVERTERS

PI-24110-400C

Power Inverter

- Max continuous power: 400W
- Peak load power rate: up to 800W
- For use with 24V DC voltage systems
- No load current draw: up to 0.2 Amps
- Waveform: modified sine wave
- Input DC voltage range: 20V - 30V DC
- USB Output: 5V/2.4A
- Overload and short-circuit protection
- (1) Replaceable 20 Amp fuse
- Built-in cooling fan
- (2) 120V AC Volt 3 prong grounded American standard receptacles
- Overload indicator



Convert 24V DC from your car lighter socket to 120V AC outlet, ideal for use at campsites, road trips or anywhere dc to ac inverter is needed. Combine 2 AC outlets and 1 USB charging ports into one, ideal for charging up to 3 devices simultaneously. Built-in fuse & cooling fan, protection against short circuit, overload, overheat, low battery voltage and over battery voltage, will auto-resume after protection triggered.

PI-24110-800C

Power Inverter

- Max continuous power: 800W
- Peak load power rate: up to 1600W
- For use with 24V DC voltage systems
- No load current draw: up to 0.4 Amps
- Waveform: modified sine wave
- Input DC voltage range: 20V - 30V DC
- USB Output: 5V/2.4A
- Overload and short-circuit protection
- (1) Replaceable 20 Amp fuse
- Built-in cooling fan
- (2) 120V AC Volt 3 prong grounded American standard receptacles
- Overload indicator



Convert 24V DC from your car lighter socket to 120V AC outlet, ideal for use at campsites, road trips or anywhere dc to ac inverter is needed. Combine 2 AC outlets and 1 USB charging ports into one, ideal for charging up to 3 devices simultaneously. Built-in fuse & cooling fan, protection against short circuit, overload, overheat, low battery voltage and over battery voltage, will auto-resume after protection triggered.

PI-1500C

POWER INVERTER

- Max continuous power: 1500W
- Peak load power rate: up to 3000W
- For use with 12V DC voltage systems
- No load current draw: up to 0.9 Amps
- Waveform: modified sine wave
- Input DC voltage range: 10V-15V DC
- USB Output: 5V/2.4A
- Overload and short-circuit protection
- (1) Built-in 6 x 30 Amp fuses
- Built in cooling fan
- (2) 120V AC Volt 3 prong grounded American standard receptacles
- Overload indicator



Dual 110V AC outlets deliver 1500W continuous power to your refrigerator, coffee maker, desktop, laptop, TV, game console, DVD/Blu-Ray player, microwaves, pumps, and other electric appliances. Dual USB ports Auto 0-2.4A /per port, can automatically identify USB devices and deliver the optimal charging speed. This power inverter is equipped with overload and low-battery shutdown features to protect your electric appliance safe. Hook up the power inverter to your vehicle battery with the battery clips to get Max 3000W power AC output, ideal for outdoor emergency charging, road trip and camping power supply.

PI-24110-2000C

Power Inverter

- Max continuous power: 2000W
- Peak load power rate: up to 4000W
- For use with 24V DC voltage systems
- No load current draw: up to 0.5 Amps
- Waveform: modified sine wave
- Input DC voltage range: 20V - 30V DC
- USB Output: 5V/2.4A
- Overload and short-circuit protection
- (1) Replaceable 35 Amp fuse
- Built-in cooling fan
- (2) 120V AC Volt 3 prong grounded American standard receptacles
- Overload indicator



Convert 24V DC from your car lighter socket to 120V AC outlet, ideal for use at campsites, road trips or anywhere dc to ac inverter is needed. Combine 2 AC outlets and 1 USB charging ports into one, ideal for charging up to 3 devices simultaneously. Built-in fuse & cooling fan, protection against short circuit, overload, overheat, low battery voltage and over battery voltage, will auto-resume after protection triggered.

PI-DCDC-2412-10

24V DC TO 12V DC VOLTAGE CONVERTER

- Output Power: 10Amp(Continuous) 15 Amp Max
- Standby Current: <0.02A
- Input Voltage: DC 20V~30V
- Output Voltage: DC 12V~13.8V
- Efficiency: >90%
- Cooling: By Air Convection
- Fuse: 10A x 1PC
- Dimensions(LxWxH):110x87x42mm
- Net Weight: 0.45Kg



PI-DCDC-2412-30

24V DC TO 12V DC VOLTAGE CONVERTER

- Output Power: 30Amp(Continuous) 45 Amp Max
- Standby Current: <0.08A
- Input Voltage: DC 20V~30V
- Output Voltage: DC 12V~13.8V
- Efficiency: 85~90%
- Over Load: Circuit Protection
- Input Fuse: 30A
- Dimensions(LxWxH):222x115x62mm
- Net Weight: 0.95Kg



PI-DCDC2412-100

24V DC TO 12V DC VOLTAGE CONVERTER

- Output Power: 100Amp(Continuous), 130Amp Max
- Standby Current: ≤1.10A
- Input Voltage: DC 20V~30V
- Output Voltage: DC 12V~13.8V
- Efficiency: 85~90%
- Thermal Protection: 65°C +/- 5°C
- Input Polarity Reverse: Diode Protection
- Output Polarity Reverse: Circuit Protection
- Output Short: Circuit Protection
- Over Heating: Circuit Protection
- Over Load: Circuit Protection
- Input Fuse: 4x30A
- Dimensions(L x W x H): 365x165x79mm
- Net Weight: 3.03Kg



EX-ID216-6WHT  
EX-ID216-9WHT  
EX-ID216-12WHT  
EX-ID216-15WHT  
EX-ID216-20WHT  
EX-ID216-25WHT

- FLAT PLUG EXTENSION CORD
- 1625W, 16/2 SPT-2, 100% Copper
  - Polarized for Convenient Use
  - Safety Cover Permanently Attached

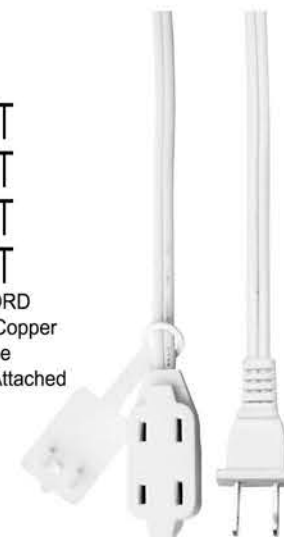

EX-FLT316-6IVO

EX-FLT316-12IVO

- FLAT CABLE WITH FLAT PLUG EXTENSION CORD
- SPT-3, 100% Copper, 16 Ga.
  - 15 Amp, 127 Volt
  - Heavy-Duty for Rugged Use Indoors & Outdoors
  - Unbreakable Molded-On Connectors
  - For Safe Operation with Power Tools, Work Lights, Small Appliances, and Electrical Motors in the Home, Office, Workshop, and Garage



EX-OD314-25ORG

EX-OD314-50ORG

EX-OD314-100ORG

- EXTENSION CORD WITH POWER INDICATOR
- SJTW, 100% Copper, 14 Ga.
  - 13 Amp, 300 Volt, 1625W
  - Heavy-Duty for Rugged Use Indoors & Outdoors
  - Unbreakable Molded-On Connectors
  - For Safe Operation with Power Tools, Work Lights, Small Appliances, and Electrical Motors in the Home, Office, Workshop, and Garage



EX-OD316-25ORG

EX-OD316-50ORG

EX-OD316-100ORG

- EXTENSION CORD WITH POWER INDICATOR
- SJTW, 100% Copper, 16 Ga.
  - 13 Amp, 300 Volt, 1625W
  - Heavy-Duty for Rugged Use Indoors & Outdoors
  - Unbreakable Molded-On Connectors
  - For Safe Operation with Power Tools, Work Lights, Small Appliances, and Electrical Motors in the Home, Office, Workshop, and Garage



EX-PRO312-25BLK

EX-PRO312-50BLK

- 3-OUTLET HEAVY DUTY EXTENSION CORD
- Tangle-Free and Ultra-Flexible
  - Great for Indoor/Outdoor Use Around the House, Garage and many other places
  - 3 Grounded Outlets



EX-PRO612N

3-OUTLET HEAVY DUTY EXTENSION CORD

- Type: SJT 3 Conductor
- Connector A: NEMA 5-15 Power Plug (North America) Male
- Connector B: IEC 60320 C13 Power Plug (North America) Female+B7
- Wire Gauge: 16 AWG
- Amp Rating: 13A Max.
- Length: 12' (3.7M)



- Works with most Amplifiers, DJ Cabinets and most Electronic Devices that Accommodate a 3-Pin Power Connector Ideal for use as a Replacement to an old or missing Power Cord or simply as a handy backup UL listed for Safety; Durable Design for Long-Lasting Strength and Performance





**DVC-505**  
MULTI-OUTLET UNIVERSAL AC/DC ADAPTER

- Current: 500mA
- Input: 110/220V
- Output: 1.5, 3, 4.5, 6, 7.5, 9, 12V
- 6 Detachable Output Plugs



**DVC-505-220**  
MULTI-OUTLET UNIVERSAL AC/DC ADAPTER

- Current: 500mA
- Input: 220V
- Output: 1.5, 3, 4.5, 6, 7.5, 9, 12V
- 6 Detachable Output Plugs



**DVC-1005**  
MULTI-OUTLET UNIVERSAL AC/DC ADAPTER

- Current: 100mA
- Input: 110/220V
- Output: 1.5, 3, 4.5, 6, 7.5, 9, 12V
- 6 Detachable Output Plugs



**DV-2000**  
UNIVERSAL AC/DC ADAPTER

- Current: 2000mA
- Input: 110/220V
- Output: 3, 4.5, 6, 7.5, 9, 12, 15V
- Round Pin



**DV-3467**  
UNIVERSAL AC/DC ADAPTER

- Current: 300mA
- Input: 110/220V
- Output: 3, 4.5, 6, 7.5, 9, 12V



**DV-5100A**  
UNIVERSAL AC/DC ADAPTER

- Current: 500mA
- Input: 90/240V, 50/60Hz
- Output: 3, 4.5, 6, 7.5, 9, 12V
- Short Circuit Protection
- Thermal and Overload Cut-Off
- 6 Detachable Output Plugs



**DV-1500SQU**  
MULTI-OUTLET UNIVERSAL AC/DC ADAPTER

- Input: 100V - 120V/ 200V - 240V AC 50 - 60Hz
- Output: 3, 5, 6, 7.5, 9, 12, 15V DC
- 1500mA Maximum



**J-236**  
DC POWER JACK



**J-238**  
DC POWER JACK 2.5MM X 5.5MM



**AC-003RA**  
4FT AC POWER CORD WITH RIGHT ANGLE PLUGS

- Allows Mounting of the TV Closer to the Wall so there is no Gap



**CCC-DC4**  
4 Connector Cable

- Compatible with: DVCA-24 DVCA548



**CCC-DC8**  
8 Connector Cable

- Compatible with: DVCA-24 DVCA548



**DVCA-24**  
AC ADAPTER

- Input: AV 100~240V, 50/60Hz
- Output: DC 12V, 2A
- Power: 24W
- 2 A Output
- Connector Size: 5.5 x 2.5mm



**DVCA-548**  
AC TO DC ADAPTER

- Input: AV 100~240V, 0.32~0.75A, 50/60Hz
- Output: DC 12V, 5A
- Power: 60W
- 5 A Output
- Connector Size: 5.5 x 2.5mm



**DV-5467**  
UNIVERSAL AC/DC ADAPTER

- Current: 500mA
- Input: 110/220V
- Output: 3, 4.5, 6, 7.5, 9, 12, 15V
- Extra Plug for Walkman



**DV-1000**  
MULTI-OUTLET UNIVERSAL AC/DC ADAPTER

- Current: 1000mA
- Input: 110/220V
- Output: 1.5, 3, 4.5, 6, 7.5, 9, 12V



**DV-CC-212**  
AC/DC ADAPTER

- Input: AC 100~240V, 50/60Hz
- Output: 12V, 2A
- Used for CCTV



**DV-700MX**  
AC POWER ADAPTER  
• Current: 700mA  
• Input: 120V, 60Hz  
• Output: 18V



**DV-1012TV**  
AC POWER ADAPTER  
• Current: 1000mA  
• Input: 120V, 60Hz  
• Output: 12V  
• Used for TV's



**DV-1035TV**  
AC ADAPTER  
• Input: 110VAC, 60Hz  
• Output: 13.5V  
• Current: 1000mA  
• Dual Polarity  
• Use for TV  
• Plug: 5 mm



**DV-2300**  
SWITCHING POWER ADAPTOR FOR DIGITAL CAMERA  
• Input: 100-140V AC  
• Output: 3V, 5V, 6V, 7.5V, 9V, 12V, DC  
• Current: 0-2300mA  
• Output Plug: with 6 Detachable Plugs



**DVK-3D**  
KEYBOARD AC/DC ADAPTER  
• Input: 100-240V, 50-60Hz  
• Output: 12V  
• Current: 1000mA  
• Plug: 5mm



**DVA-500E**  
UNIVERSAL AC/DC ADAPTOR  
• Output: 1.5-.4-5-6-7.5-9-12V AC  
• Current: 500mA Max.

**DVK-5D**  
KEYBOARD AC ADAPTER  
• Input: 120V, 50Hz  
• Output: 12VDC  
• Current: 1500mA  
• Plug: 5mm



**DVD-12012CT**  
LEAD ACID BATTERY CHARGER (1.2A)  
• 110/200V, 50/60Hz AC, 6.0, 12V DC  
AT, ET, ST & RUK Input Plugs, Red & Black Battery Clip Output Plugs



**IS-CLE12**  
12V, 12' Cigarette Extension Cable  
• 12' Length  
• Wire Gauge: 18 AWG  
• 100% Copper Wire  
• High Quality Molded Cable for Strength and Durability  
• Male plug is fitted with a 15A fuse to protect your vehicle and devices and has LED light indication of power on



**DPSW-YA2A**  
AC TO DC POWER ADAPTER  
• Input: AC 100-240V, 50/60Hz, 0.8A  
• Output: DC 12V, 2A  
• Compatible with Yamaha Keyboards

For Keyboard Use



**DVSW-2000**  
2000MA SWITCHING Power Adapter  
• Auto Voltage AC 90V-240V  
• Output DC: 3-4-5-6-7.5-9-12V  
• Output Current: 2000mA



**DVSW-2030SU**  
2100MA SWITCHING Power Adapter  
• Power: 30W  
• Input Type: AC 100-240V 50-60HZ  
• Output Type: DC3V/4.5V/5V/6V/7.5V/9V/12V  
• USB PORT: 5.1V 2.1A  
• DC Cable Length: 150cm  
• DC Head Size: 2.5\*0.7, 3.0\*1.1, 3.5\*1.5, 5.0\*2.1, 5.5\*2.5, 3.5\*1.35mm with Addition  
Plug: Micro USB & LED



**DVSW-2500**  
2500MA SWITCHING Power Adapter  
• Auto Voltage AC 90V-240V  
• Output DC: 3-4-5-6-7.5-9-12V  
• Output Current: 2500mA



**DV-117CL**  
UNIVERSAL AC TO DC CAR CIGARETTE LIGHTER SOCKET ADAPTER  
• Input: 90-240V, 56/60Hz  
• Output: DC 12V, 500mA  
• Turns any vehicle power charger into an AC travel charger  
• Ultra slim design is lightweight and portable  
• Safe for 110v or 220v outlets  
• Useful with other travel items: air pumps, portable coolers, spotlights, laptop, PDA  
• Compatible with any vehicle power charger so never becomes obsolete



**NP-112**  
CIGARETTE LIGHTER PLUG ADAPTER



**NP-115**  
CIGARETTE LIGHTER PLUG TO 1 F JACK



**NP-210**  
CIGARETTE LIGHTER PLUG TO 2 F JACKS

POWER CORDS



**AC-2380**  
FLAT PIN UNIVERSAL AC CHEATER CORDS  
• 6'  
• For Tape Players



**AC-011**  
FLAT PIN UNIVERSAL AC CHEATER CORDS  
• 6'  
• For Tape Players



**AC-2206**  
• Round Pin Universal AC Cheater Cords  
• 6'  
• For Tape Players



**AC-012**  
FLAT PIN FIGURE 8 AC POWER CORD  
• 6'  
• Fits Panasonic, JVC, Sanyo & Fisher



**AC-003**  
MICKEY MOUSE TYPE GROUNDED AC CHEATER CORD  
• 6'  
• Ideal for Laptops and Portable Projectors



**AC-006HQ**  
6' FLAT PIN UNIVERSAL AC CHEATER CORD FOR TAPE PLAYERS  
• 18 ga  
• For Tape Players



**AC-088**  
A/C CORD WITH SPADE TERMINALS



**CMC-200**  
APPLIANCE ELECTRICAL CORD  
• Connector made of ABS and Bakelite for Resistance to Extreme Heat  
• Cable: 2\*38\*0.14 CCA  
• OD:3.8\*7.6  
• 10A 250V  
• 6FT



**IPC-200**  
IRON POWER CORD  
• 6.5'  
• Cotton, Brass  
• Tinny Copper 99%

**F-21A**  
3 SECTION RADIO ANTENNA  
• 11" Knocked Down  
• 30" Extended

**F-21B**  
4 SECTION RADIO ANTENNA  
• 8" Knocked Down  
• 24" Extended

**F-21C**  
4 SECTION RADIO ANTENNA  
• 11" Knocked Down  
• 37" Extended



UNIVERSAL ADAPTERS

**DLPT-451**

UNIVERSAL ULTRABOOK ADAPTER  
• Input: AC 100~240V, 50/60Hz  
• Output: 19, 19.5, 20V, 45W max  
• Compatible with Acer, Asus, Benq, Dell, Gateway, Hp, Lenovo, Samsung, Sony, Toshiba



Type /Tipo	Output /Salida	Connector Size /Tamaño del Conector	Laptop Brand /Marca del Ordenador Portátil
H1	19V/Max45W	5.5x3.0mm	For Samsung 19V, 2.1A
H2	19V/Max45W	4.0x1.35mm	For Asus 19V, 1.75A-2.37A
H3	19V/Max45W	5.5x2.5mm	For Toshiba/Benq/Gateway 19V, 1.58A/19V, 2.1A/19V, 2.37A
H5D	19.5V/Max45W	4.5x3.0mm	For Dell 19.5V 2.31A
H6	19.5V/Max45W	4.5x3.0mm	For Hp 19.5V 2.31A
H7	19V/Max45W	3.0x1.0mm	For Samsung 19V2.1A (For Asus 19V2.37A)
H8	19V/Max45W	2.5x0.7mm	For Asus 19V, 1.58-2.1A
H10	19V/Max45W	5.5x1.7mm	For Acer 19V, 1.58-2.15A
H11	19.5V/Max45W	6.5x4.4mm	For Sony 19.5V 2A
H12	20V/Max45W	USB Type	For Lenovo 20V 2.25A

**DV-2005**

AC/DC ADAPTER  
• Input: AC 100~240V, 50/60Hz  
• Output: 5V, 2A  
• Use for CCTV



**DVS-9V2A-5525**

AC ADAPTER  
• Input: 100-240V, 1.5A, 50/60 Hz  
• Output: 9V, 2A  
• Power: 18W  
• DC Connector: 5.5 x 2.5mm  
• Power Cord Length: 6'/1.8m



**DVS-12V2A-5525**

AC ADAPTER  
• Including one LED Terminal  
• Input: 100-240V, 1.5A, 50/60 Hz  
• Output: 12V, 2A  
• Power: 24W  
• DC Connector: 5.5 x 2.5mm  
• Power Cord Length: 6'/1.8m



### DLPT-1015-LUB

SLIM UNIVERSAL AC ADAPTER

- Input/Entrada: AC 100~240V, 50/60Hz
- Output/Salida: 15, 16, 18.5, 19, 19.5, 20V, 100W Max
- Compatible with/Compatible con: Acer, Asus, Dell, Hp, Lenovo, Samsung, Vivo, Toshiba

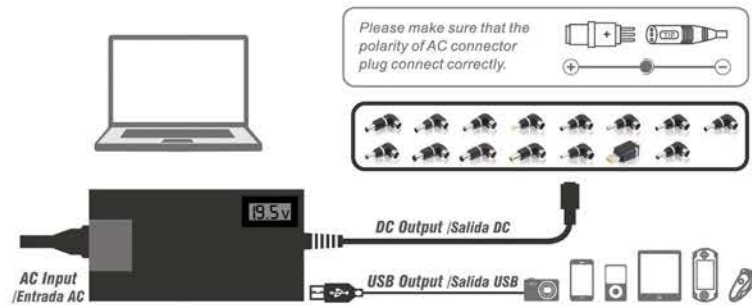

Please make sure that the polarity of AC connector plug connect correctly.



### DLPT-902LUSB

90W AUTOMATIC UNIVERSAL AC ADAPTER FOR LAPTOP

- USB Port Charges for Smart Phone, MP3, MP4, iPad, iPhone, Tablet PC, PDA and other Related Devices with Standard USB Output
- Multiple Types of Interchangeable Connectors
- Safe and Reliable, Variable Voltages Range from 9.5V~24V
- Multi Country Ready (100V~240V)
- High Grade ABS Housing
- Fire Retardant Case
- Incorporates EMC and EMI Technology, for Absorbing Current Burst and Controlling the Circuitry



Type	Output	Connector Size	Laptop Brand
15.0V/M1	15.0V/Ma x 90W	6.3 x 3.0mm	Toshiba
16.0V/M2	16.0V/Ma x 90W	5.5 x 2.5mm	IBM, Lenovo
16.0V/M3	16.0V/Ma x 90W	6.5 x 1.4mm	Sony, Fujitsu
18.5V/M4	18.0V/Ma x 90W	4.8 x 1.7mm	Compaq, HP
19.0V/M5	19.0V/Ma x 90W	5.5 x 2.5mm	Acer, Compaq, Delta, HP, Fujitsu, Gateway, Toshiba, Liteon
19.0V/M6	19.0V/Ma x 90W	5.0 x 3.0mm	Samsung
19.0V/M7	19.0V/Ma x 90W	5.5 x 2.1mm	Acer, Compaq, Delta, HP, Fujitsu, Gateway, Toshiba, Liteon
19.5V/M8	19.5V/Ma x 90W	6.5 x 1.4mm	Sony
19.5V/M9	19.5V/Ma x 90W	7.4 x 5.0mm	Dell
20.0V/M10	20.0V/Ma x 90W	3 Pin Connector	Dell
20.0V/M11	20.0V/Ma x 90W	7.9 x 5.4mm	IBM, Lenovo
18.5V/M12	18.5V/Ma x 90W	7.4 x 5.0mm	HP, Compaq



### DLPT-1208-USB

UNIVERSAL CAR AND HOME ADAPTER FOR LAPTOP

- Input: DC12V; AC 110-240V
- Output: DC12-24V DC 4A USB 5V
- Full protection for notebook computers
- Simple change smart tips, compatible with different devices
- Choose the interchangeable smart tip according to the output voltage
- Works with: Notebook PCs of most brands and models
- Universal car adapter for laptop mobile phone mp3 mp4 digital camera

This Charger Provides up to 120 Watts of Power, and Included 8 Power Tips that are Compatible with Most Popular Laptops and Portable Devices:



120Watts



DC 12V AC110~240V



### DLPT-909USB

AUTOMATIC UNIVERSAL AC ADAPTER (90W)

90Watts

Compatible with: Samsung, Toshiba, Lenovo, Dell, HP, Acer, Sony, ASUS.



Type /Tipo	Output /Salida	Connector Size /Tamaño del Conector	Laptop Brand /Marca del Ordenador Portátil
H1	19V/Max 90W	5.5 x 3.0mm	Samsung: 19V/3.16A, 19V/4.22A, 19V/4.74A
H3	19V/Max 90W	5.5 x 2.5mm	Toshiba/Lenovo/Asus: 19V/3.42A, 19V/3.95A, 19V/4.74A 20V/3.25A, 20V/4.5A
H5D	19.5V/Max 90W	4.5 x 3.0mm	Dell: 19.5V/3.34A, 19.5V/4.62A
H6H	19.5V/Max 90W	4.5 x 3.0mm	HP: 19.5V/3.33A, 19.5V/4.62A
H10	19V/Max 90W	5.5 x 1.7mm	Acer: 19V/3.42A, 19V/3.95A, 19V/4.74A
H11	19.5V/Max 90W	6.5 x 4.4mm	Sony: 19.5V/3.33A, 19.5V/3.9A, 19.5V/4.7A
H12	20V/Max 90W	USB TYPE	IBM/Lenovo: 20V/3.25A, 20V/4.5A
H13D	19.5V/Max 90W	7.4 x 5.0mm	Dell: 19.5V/3.34A, 19.5V/4.62A
H14H	18.5V/Max 90W	7.4 x 5.0mm	HP: 18.5V/3.5A, 19.5V/3.33A, 19V/4.74A



DLPT-909

AUTOMATIC UNIVERSAL AC ADAPTER

- Input: AC 100 ~ 240V, 1.8A, 50/60Hz (Max)
- Output: DC 18.5V ~ 20V, 4.74A (Max)
- Power: 90W
- Charges for Laptop, Tablet, Smart Phone, Digital Camera, MP3, & MP4 Player
- Connector Size: 5.7" x 2.7" x 0.6" (144 x 69 x 16mm)

Type /Tipo	Output /Salida	Connector Size /Tamaño del Conector	Laptop Brand /Marca del Ordenador Portátil
H1	19V/Max 90W	5.5 x 3.0mm	Samsung: 19V/3.16A, 19V/4.22A, 19V/4.74A
H3	19V/Max 90W	5.5 x 2.5mm	Toshiba/Lenovo/Asus: 19V/3.42A, 19V/3.95A, 19V/4.74A 20V/3.25A, 20V/4.5A
H5D	19.5V/Max 90W	4.5 x 3.0mm	Dell: 19.5V/3.34A, 19.5V/4.62A
H6H	19.5V/Max 90W	4.5 x 3.0mm	HP: 19.5V/3.33A, 19.5V/4.62A
H10	19V/Max 90W	5.5 x 1.7mm	Acer: 19V/3.42A, 19V/3.95A, 19V/4.74A
H11	19.5V/Max 90W	6.5 x 4.4mm	Sony: 19.5V/3.33A, 19.5V/3.9A, 19.5V/4.7A
H12	20V/Max 90W	USB TYPE	IBM/Lenovo: 20V/3.25A, 20V/4.5A
H13D	19.5V/Max 90W	7.4 x 5.0mm	Dell: 19.5V/3.34A, 19.5V/4.62A
H14H	18.5V/Max 90W	7.4 x 5.0mm	HP: 18.5V/3.5A, 19.5V/3.33A, 19V/4.74A



Newly added connector covers latest HP models!

DLPT-NTB-65

UNIVERSAL NETBOOK ADAPTER

- Input: 110V~240V, 50/60Hz, 1.6A
- Output Power: 19V/19.5V/20V, 65W Maximum
- Power: Smart 45W-65W
- Type: AC-DC



MULTIPLE DC TIPS & WIDE VOLTAGE RANGE - Works for Lots of Brand Model Laptops. Multiple DC Tips: This set of tips are compatible with most HP, Dell, Toshiba, Lenovo, Acer, Asus, Samsung, Sony, Fujitsu, Gateway, and other Brand laptop models which tips and voltage are included.



DLPT-TYC-45

UNIVERSAL DEVICE TYPE C CHARGER

- Input: 110V~240V, 50/60Hz, 1.1A
- Output: 5V/2A, 9V/2A, 12V/2A, 14.5V/2A, 15V/3A, 20V/2.25A

- Widely compatible with USB-C enabled smart phones, tablets, laptops and computers. Works with Macbook 2016, new Macbook Pro 2016, Dell XPS 13, HP Spectre and more USB-C laptops

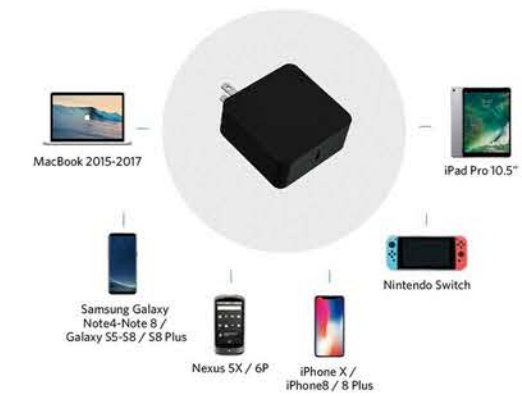

45 Watts Power



DLPT-UNI-16

SMART UNIVERSAL POWER ADAPTER

- Input: 110V~240V, 50/60Hz, 1.5A
- Output: 5.25V, 3A



Type/Tipo	Output/Salida	Connector Size/Tamaño del conector
A	5V/Max 16W	USB Type-C/USB Tipo-C
S	5V/Max 16W	Micro USB/USB Micro
C	5V/Max 16W	5.5 x 2.5mm
F	5V/Max 16W	4.8 x 1.7mm
G	5V/Max 16W	4.0 x 1.7mm
H	5V/Max 16W	3.5 x 1.35mm
I	5V/Max 16W	2.5 x 0.7mm
L	5V/Max 16W	3.0 x 1.0mm

16 Watts Max







20-115-21U

- 1 AC OUTLET & DUAL USB PORTS  
WALL OUTLET CHARGING CENTER  
FOR USB ELECTRONICS
- AC 125V, 15A, 1875W, 60Hz
  - Converts 1 AC Outlet to 1 AC Outlet and Dual USB Port
  - ABS Resistance Burning (94V-0) Housing
  - 2 Ports USB Total 2.1A
  - ETL Approved



20-3245-21U

- WALL OUTLET CHARGING CENTER FOR  
USB ELECTRONICS
- AC Rating: 15A/125V/1875W
  - Maximum Spike Voltage: 550V
  - Clamping Voltage: 550V
  - 245J Surge Suppressor to Protect Sensitive Electronic Equipment
  - USB 1.1A + 1.0A



13-414

- 6 OUTLET AC POWER STRIP
- High Impact, Fire-Retardant Plastic Housing
  - Outlets: 6 "U" Ground
  - Power Supply: 14AWG x 3C SJT
  - Length: 3'
  - Switch: Lighted Approach Switch
  - Maximum Rating: 15A/120V AC/60Hz/1800 W
  - 90 JOULES Surge Suppressor to Protect Sensitive Electronic Equipment
  - For Indoor Use and Dry Locations



13-6400

- 6 OUTLET AC POWER STRIP
- High Impact, Fire-Retardant Plastic Housing
  - Outlets: 6 "U" Ground
  - Power Supply: 14AWG x 3C SJT
  - Length: 2'
  - Switch: Lighted Approach Switch
  - Maximum Rating: 15A/120V AC/60Hz/1800 W
  - 400 JOULES Surge Suppressor to Protect Sensitive Electronic Equipment
  - For Indoor Use and Dry Locations



14-519

- 3 OUTLET SWIVELING  
GROUNDED WALL SOCKET
- 110V
  - Swiveling Design Ideal for Tight Spaces

14-516

- 6 OUTLET GROUNDED  
WALL SOCKET
- 110V
  - Ideal for Home Offices

14-509

- 3 OUTLET WALL SOCKET
- 110V

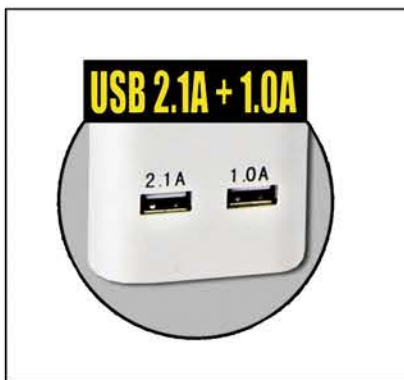

20-6450-31U

- POWER STRIP CHARGING CENTER  
FOR USB ELECTRONICS
- AC Rating: 15A/125V/1875W
  - Maximum Spike Voltage: 550V
  - Clamping Voltage: 550V
  - 450J Surge Suppressor to Protect Sensitive Electronic Equipment
  - Length: 3'
  - USB 2.1A + 1.0A
  - For Indoor Use and Dry Locations
  - Use for Portable Electronics, Video Game Console



22-6450-31U

- WALL OUTLET CHARGING CENTER FOR  
USB ELECTRONICS
- AC Rating: 15A/125V/1875W
  - Maximum Spike Voltage: 550V
  - Clamping Voltage: 550V
  - 450J Surge Suppressor to Protect Sensitive Electronic Equipment
  - USB 2.1A + 1.0A
  - 6 AC Outlets & Dual USB Ports



16-516S

- 6 OUTLET WALL SOCKET
- High Impact, Fire-Retardant Plastic Housing
  - Outlets: 6 "U" Ground
  - Max Rating: 15A / 125V AC/60Hz/1875W
  - 1000 Joules Surge Suppressor to Protect Sensitive Electronic Equipment
  - For Indoor Use Only and Dry Locations
  - Can Swivel to Redirect Power and Safely Slide all your Furniture Back
  - Creates Extra Space where you need it most



17-81803U

- 8 OUTLETS AC POWER STRIP WITH  
TRIPLE USB PORTS
- Suitable for General Electronics, Computers and Hi Fi Receivers
- INPUT:**
- Max Current: 15A
  - Max Voltage: 125V
  - Max Power: 1825W
  - Nominal Voltage: 110V
  - Nominal Frequency: 60Hz
  - Resettable Circuit Breaker: 15A
  - With ON/OFF Switch
- USB CHARGER:**
- Operating Temperature: <45°
  - Operating Relative Humidity: <99%
  - Storage Temperature: <45°



- SURGE PROTECTION:**
- Energy Absorption: 1800 Joules
  - Clamping Voltage: 400V
  - Maximum Spike Current: 36000A

- USB CHARGER:**
- Allows you to charge iPhone/iPod and other mini appliance/iPhone/iPod
  - Output: DC 5V/3.1A

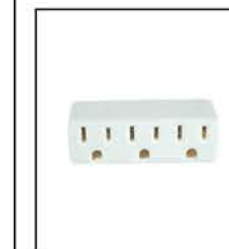

14-512

- 3 OUTLET GROUNDED  
WALL SOCKET
- 110V
  - Converts Single 3-Prong Outlet to Three 3-Prong Outlets

ELECTRONIC PROTECTORS

PROTECT-E-RAE

REFRIGERATOR PROTECTOR WITH ETL APPROVAL

- Safety Range: AC 90-140V
- 50/60Hz Auto Sensing
- 4 States Indicator
- 15s / 30s / 180s Safety Cycle
- 350 degree rotation



1200 WATT CAPACITY



350° ROTATION



PROTECTX-AUD

APPLIANCE SURGE PROTECTOR

- For air conditioner, freezer, ice maker, and washing machine
- Over-voltage disconnection
- 4-minutes safety cycle
- 3 modes LED indicator
- Detachable ground pin



3000 WATT CAPACITY



AUDIBLE ALARM



HEAT OVERLOAD SENSING

**For Air Conditioners, Freezers, Ice Makers, Washing Machines or any Large Appliances. Protect your appliance from High or Low voltage by interrupting the current flow. Once the voltage returns to normal, the SAFETY CYCLE will light up for 4 minutes before it turns to green. After this period, the green light will turn on which will allow the current to flow.**

PROTECTX-AC

AIR CONDITIONER, FREEZER PROTECTOR

- For Air Conditioner, Freezer, Ice Maker and Washing Machine
- Over-Voltage Disconnection
- 4-Minutes Safety Cycle
- 3 Modes LED Indicator
- Detachable Ground Pin



PROTECTX-AC220

AIR CONDITIONER, FREEZER PROTECTOR WITH ANTI SURGE

- For Air Conditioner, Freezer, Ice Maker and Washing Machine
- Over-Voltage Disconnection
- 4-Minutes Safety Cycle
- 3 Modes LED Indicator
- Detachable Ground Pin



PROTECTX-ELE

GENERAL ELECTRONIC PROTECTOR WITH ANTI SURGE

- For TVs, Video Games, Computers and Audio Systems
- High and Low Voltage Disconnection
- 10-Seconds Safety Cycle
- 3 Modes LED Indicator
- Detachable Ground Pin
- Capacity: 900W
- Safety Cycle: About 10 Seconds
- Working Voltage: AC 115V
- Safety Range: AC 85-135V



ELECTRONIC PROTECTORS



PROTECTX-J-45

VOLTAGE PROTECTOR WITH ANTI SURGE

- For TVs, Video Games, Printers, Computers, Routers, Modems and Audio Systems
- High & Low Voltage Disconnection
- With On/Off Switch
- 15/30/180 Seconds Safety Cycle can be Chosen
- 3 Modes LED Indicator



PROTECTX-RF

REFRIGERATOR PROTECTOR

- For All Types of Domestic Refrigerators
- Over-Voltage Disconnection
- 4-Minutes Safety Cycle
- 3 Modes LED Indicator
- Detachable Ground Pin



PROTECTX-612J

6 OUTLETS SURGE PROTECTOR

- Rating: AC 125V/15A or AC 220V/10A 60HZ
- 1875W
- 3 FT. Heavy Duty Cord, 18 AWG.
- 100% Copper
- Surge Spike Protection
- ON/OFF Rocker Switch
- For Indoor Use Only and Dry Locations



PROTECT-J-E2

GENERAL ELECTRONIC PROTECTOR

- 10-Seconds Security Cycle
- High and Low Voltage Disconnection
- 5 Modes LED Indicator
- Detachable Ground Pin
- Ideal to product: TV, Video Games, Microwave Ovens, Computers & Audio System
- With Grounded Indicator and Surge Indicator
- Double Outlets
- Capacity: 1800, 2HP
- Safety Cycle: 10 Seconds
- Input: AC 115V 60Hz, 15A
- Surge Protection Max: 12000A

ELECTRONIC PROTECTORS



**PROTECT-D-ELEC2**

GENERAL ELECTRONIC PROTECTOR

- For TV's, Video Game Systems, Microwave Ovens, Computers and Audio Systems
- Protects against Problems Originating in the AC Electric Line
- High and Low Voltage Disconnection: Low 90V, High 130V
- 10-Second Safety Cycle
- 1800 Watts
- Input: AC 115V, 60Hz, 15A
- AC 110V
- 2 Outlets



**PROTECT-1208E**

AUTOMATIC VOLTAGE REGULATOR

- For TV's, Video Game Systems, Microwave Ovens, Computers and Audio Systems
- Protects against Problems originating in the AC Electric Line
- High and Low Voltage Disconnection: Low 86V, High 138V
- Safety Cycle Switch with 3 Settings: 2 Seconds, 10 Seconds and 30 Seconds
- 600 Watts
- Input: 115V, 50/60 Hz Auto-Sensing
- LED Status Indicator for Boost, Overheat and Buck
- 8 Outlets



**P-523**

UNIVERSAL TRAVEL ADAPTER

The Universal Adaptor is a Compact One Piece Unit with 4 International Adaptors, and Provide a Child Protection Safety Shutter, Power Indicator Light and Surge Protector. This Item will Fit the Plugs in Europe/UK/USA/China/Japan/Australia/Spain and almost every Country in the World

- Sold Individually



**P-525DUSB**

UNIVERSAL TRAVEL ADAPTER

The Universal Adaptor is a Compact One Piece Unit with 4 International Adaptors, and Provide a Child Protection Safety Shutter, Power Indicator Light and Surge Protector. This Item will Fit the Plugs in Europe/UK/USA/China/Japan/Australia/Spain and almost every Country in the World. The USB Charge is 5Vdc 1000mA

- Sold Individually



AC ADAPTERS



**AC-282M**

3 PIN AC EXTENSION PLUG OR JACK PANEL MOUNT

- Male



**P-510**

FLAT PIN PLUG TO ROUND PIN SOCKET



**P-510D**

DELUXE FLAT PIN PLUG TO ROUND PIN SOCKET



**P-510D-C**

AC ADAPTER

- Input: 110-220V
- Output: 10A 250V
- Copper Connectors



**P-513**

ROUND PIN PLUG TO FLAT PIN SOCKET



**P-514**

3-PRONG PLUG TO 2-PRONG OUTLET

- Permits "U" Ground
- Orange Color



**P-514G**

3-PRONG PLUG TO 2-PRONG OUTLET

- Permits "U" Ground
- Grey Color



**P-517**  
MULTI-ADAPTER  
• Adapts American Outlets to Most Foreign Plugs



**P-519**  
EUROPEAN ADAPTER



**P-521**  
FLAT PIN TO MULTI-PLUG ADAPTER  
• Adapts American Outlets to Most Foreign Plugs



**P-522**  
ROUND PIN TO MULTI-PLUG ADAPTER  
• Adapts American Outlets to Most Foreign Plugs



**AC-006**   
FLAT PIN UNIVERSAL AC CHEATER CORDS  
• 6'  
• For Tape Players



**AC-010**   
FLAT PIN UNIVERSAL AC CHEATER CORDS  
• 6'  
• For Tape Players



**LBCH-12M**  
DOUBLE INSULATED  
• Thermal Overload Safety  
• Electronic LED Display  
• CE Approved  
• For 12V Car, Motorcycle & Lawnmower Batteries  
• 6/12V, 12 Amp



**LBCH-612SW**  
6/12V, 6 AMP  
• Blade Type Fuse  
• Overload Protection



**LBCH-6M**  
DOUBLE INSULATED  
• Power Supply  
• Thermal Overload Safety  
• Electronic LED Display  
• CE Approved  
• For 12V Car, Motorcycle & Lawnmower Batteries  
• 6/12V, 6 Amp



**LBCH-6PL**  
AUTOMATIC BATTERY CHARGER  
• 6A Automatic Charging  
• Fully Protects against Sparks, Short Circuit and Overheating  
• Suitable for all Types of 12 V Lead Acid Batteries between 20-110 AH  
• LED Display Shows Changes on the Status Indicator  
• Automatically Switches to Maintenance Mode when Battery is Fully Charged  
• Reverse Polarity Warning

**LBCH-80M**  
THERMAL OVERLOAD SAFETY  
• Electronic LED Display  
• CE Approved  
• For 12V Car, Motorcycle & Lawnmower Batteries  
• 12V, 20 Amp



EX-JUMP4-20

BOOSTER CABLES

- 4Ga, 20FT
- Tangle-Free Construction
- Phase Marked Clamps for Added Safety
- High/Low Temperature Construction
- Extra Flexible for Easy Use



EX-JUMP6-16

BOOSTER CABLES

- 6Ga, 16FT
- Tangle-Free Construction
- Phase Marked Clamps for Added Safety
- High/Low Temperature Construction
- Extra Flexible for Easy Use



**NB-2**  
9-VOLT BATTERY SNAPS  
WITH WIRE LEADS



**NB-440 BLK**  
30A BATTERY CLIP  
• Black



**NB-440 RED**  
30A BATTERY CLIP  
• Red



**NB-480**  
2 BATTERY CLIPS TO  
CIGARETTE LIGHTER JACK



**NB-550 BLK** (Black)  
**NB-550 RED** (Red)  
50 AMP BATTERY CLIP  
• Available in Black and Red



**NB-660 BLK** (Black)  
**NB-660 RED** (Red)  
60 AMP BATTERY CLIP  
• Available in Black and Red



**NB-770**  
70 AMP BATTERY JUMPER CABLE  
• Available in Black and Red



**NB-880**  
80 AMP BATTERY JUMPER CABLE  
• Available in Black and Red

**EL-536USV**

RECHARGEABLE EMERGENCY LANTERN

- Light Source: 36 x 0.5W LED
- Solar Panel Charger
- USB 5V Mobile Phone Charger
- DC 12V Input
- 360° Light Distribution
- Power Source: 110-220V / 60Hz
- Battery: 4V 6Ah Sealed Lead-Acid Rechargeable Battery
- Charge Time: 20-24 Hours
- Duration: 8-10 Hours/Strong Light; ≥25 Hours/Weak Light
- Dimension: 145 x 145 x 300mm (5.7" x 5.7" x 11.8")



**EL-603D**

CAMPING LANTERN

- 24 Pcs Bright LED
- Uses 4 D-size Batteries
- Waterproof
- With Handle and Hanging Hook



**EL-1830LED (W/ CAR ADAPTER)**

RECHARGEABLE EMERGENCY LED LANTERN

- Light: 26 Pcs 0.5W LED x 2 Tubes
- FM Scan Radio
- Overcharge Protection
- 360° Degrees Light Distribution
- AC Power : 110-220V / 60Hz
- Charging Time : Approx. 20-24 Hours
- Working Time:
  - 1 Tube: 5 Hours
  - 2 Tubes: 2.5 Hours
- Radio: 18 Hours
- 4V 4000mAh Rechargeable Lead Acid Battery

Auto Voltage 110-220V Input Capacity  
Auto voltaje 110-220V

FM Scan Radio  
Radio FM

360° Light Distribution  
360° de Distribución de luz



**AT-694**

BUILT-IN SEALED LEAD ACID RECHARGEABLE BATTERY

- Unique ON/OFF Locking Switch Prevents Battery
- Provides up to 20 Minutes of Continuous Operation
- High Impact Rubber Lens Protector
- Anti-Slip Handle
- Additional LED Map Light
- Included both AC Charger for Home Charge and 12 Volt Charger



**EL-7005L**

RECHARGEABLE HANDY LIGHT

- AC Power: 110-220V
- Charging Time: Approx. 12-15 Hours
- Duration Time: Approx 4 Hours
- Rechargeable Battery: 4V 0.4AH Sealed Lead-Acid Rechargeable Battery
- LED: 5x1500MCD, 110 Degree Bright LED Torch



**EL-8003L**

RECHARGEABLE HANDY LIGHT

- 4V 3Ah Rechargeable Lead-Acid Battery
- 12 x 1500MCD
- 110° Bright LED



**EL-8212F**

12" RECHARGEABLE FAN

- Input Voltage: 110-240V, 50/60Hz
- Maximum Power: 22W
- Rated Current: 1.3A
- AC/DC Operate
- 6V 4.5 Ah Rechargeable Lead Acid Battery
- 12 Inch Oscillating 2-Speed Fan
- Over Charge & Discharge Protection
- With New ABS Material
- 1.5M 2 Pin Flat Plug
- 8 Pcs Super Bright LED
- With DC Input and USB Output
- Charging Time: 8-12 Hours
- Working Time: High Speed: 3 Hours  
Low Speed: 5 Hours  
LED: 30 Hours

USB 5V Output for cellular or accessory charging



**EL-8210F**

10" RECHARGEABLE FAN

- Input Voltage: 110-240V, 50/60Hz
- Max. Power: 17W
- Rated Current: 1.3A
- AC/DC Operational
- 6V 4.5 Ah Rechargeable Lead Acid Battery
- 10 Inch 2-Speed Fan
- Over Charge & Discharge Protection
- With New PP Material
- 1.5M 2 Pin Flat Plug
- 4 Pcs Super Bright LED
- With DC Input and USB Output
- FM Radio with Scan Function
- Charging Time: 10-15 Hours
- Working Time: High Speed: 3 Hours  
Low Speed: 4.5 Hours  
LED: 90 Hours  
Radio: 15 Hours

USB 5V Output for cellular or accessory charging



**EL-3360L**

RECHARGEABLE BRIGHT LED  
EMERGENCY LIGHT

- AC Power: 110/220V
- Charging Time: Approx. 20-24 Hours
- Duration Time: Approx. 22 Hours (1 Line),  
Approx. 12 Hours (2 Lines), Approx.  
8 Hours (3 Lines)
- Rechargeable Battery: 4V/2.8Ah  
Sealed Lead-Acid



**RMQT-301**

ELECTRO SWAT

- It is Safe for Indoor or Outdoor Use,  
Convenient Hygienic Insect Terminator
- Comes in Red, Yellow, Blue and Green



This Product Requires 2 AA 1.5V Batteries  
(Not Included). The Electro Swat Emits No Smell,  
Uses No Poisonous or Harmful Material.

**AT-486L**

AUTOMATIC EMERGENCY  
LED LIGHT

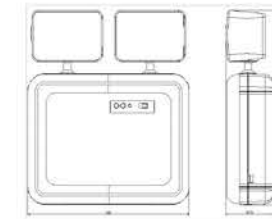

**Voltage: 100V-240V**

No.	Items	Units	
1	Input Voltage	V	AC100-240V
2	Lighting Source	-	SMD LED 24+24PCS
3	Luminous Flux	lm	1200
4	Brightness	cd/m2	>15
5	Beam Angle	°	120
6	Case Material	-	ABS
7	Work Temperature	°C	0-50
8	Operation	Hr	3
9	AC Power Consumption	W	4
10	Battery	-	Lead-Acid 6V4A
11	Charging Time	Hr	48
12	Dimensions	mm	195(L)x57.5(W)x223(H)
13	Net Weight	g	1155
14	One Piece Packing	mm	223x58x230

**AT-324L**

AUTOMATIC EMERGENCY  
LED LIGHT

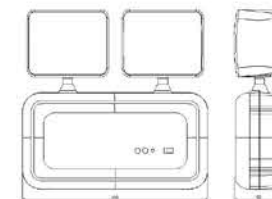

**Voltage: 100V-240V**

No.	Items	Units	
1	Input Voltage	V	AC100-240V
2	Lighting Source	-	SMD LED 16+16PCS
3	Luminous Flux	lm	600
4	Brightness	cd/m2	>15
5	Beam Angle	°	120
6	Case Material	-	ABS
7	Work Temperature	°C	0-50
8	Operation	Hr	3
9	AC Power Consumption	W	4
10	Battery	-	Lead-Acid 4V2.4A
11	Charging Time	Hr	48
12	Dimensions	mm	195(L)x52(W)x176.5(H)
13	Net Weight	g	670
14	One Piece Packing	mm	223x58x191

**ELD-9827**

LED WORK LIGHT

- 72 Red LED for Caution
- Super Luminosity: 5000mcd
- Battery: AA 1200mAh 3.6V
- Mini Work Light: 20 LED
- Super Luminosity: 13000mcd
- Battery: AAA 800mAh 3.6V
- Adapter: 9V 300mA



**NL-102**

LED NIGHT LIGHT

- Input: 120V AC, 60Hz
- Power Consumption: 0.5W
- Lifespan: Up to 50,000 Hours
- Sensor Mode: <10 Lux Light On, >10 Lux Light Off
- IP Classify: IP 20, Indoor Use Only
- Dawn to Dusk Sensor so Light Only Activates  
in Darkness
- Bright White LED Provides Nice Warm  
Light Output
- No Bulb Replacement with Energy Efficient LEDs
- Perfect for Bathrooms, Bedrooms and Anywhere  
you need some Extra Light



**AT-446WL**

AUTOMATIC EMERGENCY  
LED LIGHT

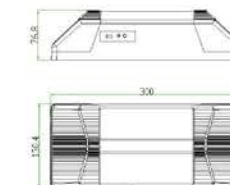

**Voltage: 100V-240V**

No.	Items	Units	
1	Input Voltage	V	AC100-240V
2	Lighting Source	-	SMD LED 22+22PCS
3	Luminous Flux	lm	220
4	Brightness	cd/m2	>15
5	Beam Angle	°	120
6	Case Material	-	ABS
7	Work Temperature	°C	0-50
8	Operation	Hr	12
9	AC Power Consumption	W	4
10	Battery	-	Lead-Acid 6V4A
11	Charging Time	Hr	48
12	Dimensions	mm	300*130.4*76.8
13	Net Weight	g	1170
14	One Piece Packing	mm	310x137x80.5



**GR-507D**

- Gas Regulator with Double Hook
- Inlet Pressure: 1530~30Kpa
- Outlet Pressure: 2.75k ±0.499Kpa
- Gas Flow: 0.6m³/h
- Lock Up Pressure: ≤3.43Kpa



**GR-HP20LPG-4**

- PROPANE REGULATOR HIGH PRESSURE LPG  
BBQ GAS BURNER HOSE 20 PSI
- The Regulator is Adjustable up to 20 PSI
  - 3/8" Flare Swivel Fitting



**GRG-669**

- GAS REGULATOR
- Has a Level Indicator
  - Inlet Pressure: 1530-30Kpa
  - Outlet Pressure: 2.75k±-0.499Kpa
  - Gas Flow: 0.6m³/h
  - Lock Up Pressure: <3.43Kpa



**GR-707**

- GAS REGULATOR
- Inlet Pressure: 1530-30Kpa
  - Outlet Pressure: 2.75k±-0.499Kpa
  - Gas Flow: 0.6m³/h
  - Lock Up Pressure: <3.43Kpa



**ELED27-2CW**

- 110V
- 2W
- Color Temperature: 6000°K Cool
- Lumens: 200
- Life: 20000hrs
- Base: E27
- Dimensions: Ø45 x 69mm



**Cool White**



**ELED27-2WW**

- 110V
- 2W
- Color Temperature: 3000°K Warm
- Lumens: 200
- Life: 20000hrs
- Base: E27
- Dimensions: Ø45 x 69mm



**Warm White**



**ELED27-3CW**

- 100V-240V (Auto-Voltage)
- 3W
- Color Temperature: 5700°K Cool
- Lumens: 300
- Life: 20000hrs
- Base: E27
- Dimensions: Ø60 x 110mm



**Cool White**



**ELED27-3WW**

- 100V-240V (Auto-Voltage)
- 3W
- Color Temperature: 2700°K Warm
- Lumens: 300
- Life: 20000hrs
- Base: E27
- Dimensions: Ø60 x 110mm



**Warm White**



**ELED27-6WW**

- 100V-240V (Auto-Voltage)
- 6W
- Color Temperature: 2700°K Warm
- Lumens: 500
- Life: 20000hrs
- Base: E27
- Dimensions: Ø60 x 110mm

**Warm White**





BULBS



**EWBL-113-2U**  
65W ENERGY SAVING LIGHT BULB  
• 13W Consumption  
• Daylight Color  
• 110V



**EWBL-113-T3**  
65W ENERGY SAVING LIGHT BULB  
• 13W Consumption  
• Daylight Color  
• 110V



**EWBL-115-T3**  
75W ENERGY SAVING LIGHT BULB  
• 15W Consumption  
• Daylight Color  
• 110V



**EWBL-120-2U**  
100W ENERGY SAVING LIGHT BULB  
• 20W Consumption  
• Daylight Color  
• 110V



**EWBL-120-T3**  
100W ENERGY SAVING LIGHT BULB  
• 20W Consumption  
• Daylight Color  
• DC 12V



**EWBL-12V9-T3**  
45W ENERGY SAVING LIGHT BULB  
• 9W Consumption  
• Daylight Color  
• DC 12V



**ACE-E27**  
BULB SOCKET  
• More Lighting – Add a light where lamp sockets are limited with the NA Polarized Socket Adapter  
• Adapter – This adapter converts a 2-prong outlet into a lamp socket in seconds  
• Indoor Use Only – Great for your workshop, garage or utility room that might need extra lighting  
• Easy to Install – Just plug in the adapter into an outlet, and screw in a standard, medium-based bulb to start using  
• Power – Do not exceed the electrical rating of 125VAC and 660W



**EWSL-125-T3**  
25W ENERGY SAVING SPOT LIGHT  
• 110-120V/50-60Hz  
• Color Temperature: 6400K  
• Lumens: 1150  
• Life: 8000 Hrs.  
• Base: E27

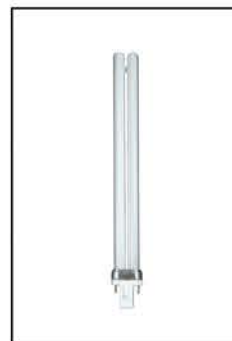

**RFL-189R**  
REPLACEMENT BULB  
• 10W, 10"

# HOME SECURITY

MDT2000

SIMULATED DOME CAMERA

- Professional Outlook Design Simulated Dome Camera with Flashing LED Provides a Real Authentic XLook. IP44 Housing, Ideal for Mounting the Camera In-Door or Out-Door, to Prevent Thieves and Vandals
- Flashing LED and Connection Cable
- Operates by 4 x AA-Cell Batteries. Will Last More than 6 Months
- Weatherproof IP44 Casing Ideal for Outdoor Use
- Packaging: Clam Shell
- Pieces: 10 Pieces
- Gross Weight: 3.3Kg
- Carton Size: 51.5x23.5 x 18.5 (L x W x H)



CCCBL-25 (25')

CCCBL-50 (50')

CCCBL-75 (75')

CCCBL-100 (100')

CCCBL-150 (150')

CCCBL-250 (250')

CCCB-500 (500')

CCCB-1000BL(1000')

CLOSED CIRCUIT TELEVISION EXTENSION CABLE

- RG-6 Siamese Cable
- Solid Copper Conductor for Less Voltage Drop and Better Signal Over Longer Distances
- All in One Video and Power Cable
- Plug and Plug Ready
- Cable Functions for BNC or RCA Connection
- BNC Male Connections On Video Cable
- Male Jack, Plug Female On DC Power Cable
- Double Shielded with Aluminum Foil Insulation and Braiding
- Different Adaptors to Connect Lengths of Cable Together or to Connect to An RCA Jack



HMA-KT-4

WIRELESS EXPANDABLE HOME ALARM

- Box Contents:
  - 1 x Alarm Unit
  - 1 x Door/Window Sensor Magnets
  - 1 x Motion Detector
  - 1 x AAA LR03 Batteries, Alkaline
  - 1 x Remote Control
- Main Unit can Add Maximum 10 Remote Controllers
- Main Unit with 4 Zones, Each Zone can Add Maximum 10 Detectors



CC-TERM12SK

CCTV 12V TERMINAL JACK

- Female DC Jack Connector Plug for CCTV Security Camera
- No more Cutting and Soldering
- Simply Screw your Cable and just Plug it in



CC-TERM12

CCCTV -DC PLUG

- Male DC Jack Connector Plug for CCTV Security Camera
- No more Cutting and Soldering
- Simply Screw your Cable and just Plug it in



CC-TERMBNCF

CCCTV-BNC JACK

- Female BNC Jack Connector Plug for CCTV Security Camera
- No more Cutting and Soldering
- Simply Screw your Cable and just Plug it in



CC-SR250

HD-CVI/TVI/AHD/CVB Passive Video Balun

- Compatible with all HD-CVI, HD-TVI, HD-AHD
- Up to 450m for 720P CVI Cameras
- NTSC, PAL, and SECAM Video Formats
- No Power Required
- 60dB Cross Talk and Noise Immunity



CC-VB2000CB

1 CHANNEL PASSIVE VIDEO TRANSCEIVER WITH CABLE

- Video Transmission Via UTP CAT5 Cable
- 10%~20% Wire Costs Saved
- Full-Motion CCTV Video at Distances up to 2000'(600M)
- Outstanding Interference Rejection and Transient Protection



CC-VB2000RA

1 CHANNEL RIGHT ANGLE PASSIVE VIDEO TRANSCEIVER

- Video Transmission Via UTP CAT5 Cable
- 10%~20% Wire Costs Saved
- Full-Motion CCTV Video at Distances up to 2000'(600M)
- Outstanding Interference Rejection and Transient Protection



CC-VB2000T

1 CHANNEL PASSIVE VIDEO TRANSCEIVER

- Video Transmission Via UTP CAT5 Cable
- 10%~20% Wire Costs Saved
- Full-Motion CCTV Video at Distances up to 2000' (600M)
- Outstanding Interference Rejection and Transient Protection
- Male BNC Allows Connection Directly to the Camera or DVR
- No Power Required
- UP to 3000' (1KM) with Active Receiver or Hub



CC-VB-AUDPTZ

CCTV RJ45 CAT5 Cable Video + Power Balun BNC HD Passive Transceiver Pair

- Transmits Video, Audio and Power Signals Over a Single UTP Cable
- Video Transmission Distance: 1300 Feet
- Audio & Power Transmission Distance: 328 Feet
- BNC Connector for Video, RCA for Audio and 2.1 DC Plug for Power
- Compact Size for Easy Installation



**CC-DIN-BNC**  
CAMERA CABLE  
• CCTV DIN Conversion to BNC



**CC-FIN-BNCFE**  
CAMERA CABLE  
• NA CCTV Conversion to Female BNC



**PTC-3**  
FEMALE BC CABLE  
• 2.1mm



**PTC-4**  
MALE BC CABLE  
• 2.1mm



**CCC-DC4**  
4 CONNECTOR CABLE  
• Compatible with:  
DVCA-24  
DVCA548



**CCC-DC8**  
8 CONNECTOR CABLE  
• Compatible with:  
DVCA-24  
DVCA548



**DVCA-24**  
AC ADAPTER  
• Input: AV 100~240V, 50/60Hz  
• Output: DC 12V, 2A  
• Power: 24W  
• 2 A Output  
• Connector Size: 5.5 x 2.5mm



**DVCA-548**  
AC TO DC ADAPTER  
• Input: AV 100~240V, 0.32~0.75A, 50/60Hz  
• Output: DC 12V, 5A  
• Power: 60W  
• 5 A Output  
• Connector Size: 5.5 x 2.5mm



**CCSL-25**  
CLOSED CIRCUIT TELEVISION  
• 25 FT.

RG59 Siamese Cable is a Heavily Shielded Cable which Contains both the Video (COAX) Cable and the Power Cable (18 Gauge 2 Conductor) in One Jacket. The Advantages to Using this Cable is that its more Durable, and you can Run it Long Distances without Interference. Includes 2 BNC -> RCA Male Adapters in Case your Camera uses RCA Connectors (Component Video) instead of BNC (RF)



**CCSL-100**  
CLOSED CIRCUIT TELEVISION  
• 100 FT.

RG59 Siamese Cable is a Heavily Shielded Cable which Contains both the Video (COAX) Cable and the Power Cable (18 Gauge 2 Conductor) in One Jacket. The Advantages to Using this Cable is that its more Durable, and you can Run it Long Distances without Interference. Includes 2 BNC -> RCA Male Adapters in Case your Camera uses RCA Connectors (Component Video) instead of BNC (RF)



**CCSL-150**  
CLOSED CIRCUIT TELEVISION  
• 150 FT.

RG59 Siamese Cable is a Heavily Shielded Cable which Contains both the Video (COAX) Cable and the Power Cable (18 Gauge 2 Conductor) in One Jacket. The Advantages to Using this Cable is that its more Durable, and you can Run it Long Distances without Interference. Includes 2 BNC -> RCA Male Adapters in Case your Camera uses RCA Connectors (Component Video) instead of BNC (RF)



CLOSED CIRCUIT TELEVISION



**CCSL-25 WHT**

CLOSED CIRCUIT TELEVISION EXTENSION CABLE  
 • 25 FT.  
 • White Color

CCTV ECONOMY EXTENSION CA RG59 Siamese Cable is a Heavily Shielded Cable which Contains both the Video (COAX) Cable and the Power Cable (18 Gauge 2 Conductor) in One Jacket. The Advantages to Using this Cable is that its more Durable, and you can Run it Long Distances without Interference. Includes 2 BNC -> RCA Male Adapters in Case your Camera uses RCA Connectors (Component video) instead of BNC (RF).



**CCSL-50 WHT**

CLOSED CIRCUIT TELEVISION EXTENSION CABLE  
 • 50 FT.  
 • White Color

CCTV ECONOMY EXTENSION CA RG59 Siamese Cable is a Heavily Shielded Cable which Contains both the Video (COAX) Cable and the Power Cable (18 Gauge 2 Conductor) in One Jacket. The Advantages to using this Cable is that its more Durable, and you can Run it Long Distances without Interference. Includes 2 BNC -> RCA Male Adapters in Case your Camera uses RCA Connectors (component video) instead of BNC (RF).



**CCSL-100WHT**

CLOSED CIRCUIT TELEVISION EXTENSION CABLE  
 • 100 FT.  
 • White Color

CCTV ECONOMY EXTENSION CA RG59 Siamese cable is a heavily shielded cable which contains both the video (COAX) cable and the power cable (18 gauge 2 conductor) in one jacket. The advantages to using this cable is that its more durable, and you can run it long distances without interference. Includes 2 BNC -> RCA Male adapters in case your camera uses RCA connectors (component video) instead of BNC (RF).



**CCSL-150 WHT**

CLOSED CIRCUIT TELEVISION EXTENSION CABLE  
 • 150 FT.  
 • White Color

CCTV ECONOMY EXTENSION CA RG59 Siamese Cable is a Heavily Shielded Cable which Contains both the Video (COAX) Cable and the Power Cable (18 Gauge 2 Conductor) in One Jacket. The Advantages to Using this Cable is that its more Durable, and you can Run it Long Distances without Interference. Includes 2 BNC -> RCA Male Adapters in Case your Camera Uses RCA Connectors (Component Video) instead of BNC (RF).



DOORBELLS



**RCN-AC101**

UNIVERSAL A/C REMOTE  
 • Consolidates up to 1000 Remotes  
 • Compatible with Most Popular Brands  
 • This Universal Air Conditioner Remote has been Designed to Control Multiple Brands and Models  
 • Fast Brand and Digital Code Searching  
 • Long Transmitting Range with Low Power Consumption  
 • Large LCD Screen Provides Easy Settings and Operation  
 • On/Off Timer and Night Illumination  
 • Built-In Clock



**RC-100**

WIRELESS DOORBELL  
 • 25M Range



**USI-1227L**

SMOKE & FIRE ALARM  
 • Low Battery Audible Indicator  
 • Mounting Hardware Included  
 • Large Ring Mounting Bracket  
 • Fast and Easy Installation  
 • Test Button



**WDB-700CA**

PIR SENSOR WIRELESS DOORBELL  
 • Easy for Installation  
 • Used as Doorbell, Guest Welcome & Alarm  
 • 32 Melodies  
 • Sense Range: Max 8M  
 • Beam Angle: 90°  
 • Application: Store, Home, Office



**WDB-301C**

WIRELESS DOORBELL  
 • Easy for Installation  
 • Self-Learning Code Function, No Interference  
 • Includes 25 Selectable Tones  
 • 3 Grade Volume Adjusting  
 • IP55 Water Proof  
 • Transmitter Battery Lifespan: 1 Year  
 • Working Frequency: 433.92MHz  
 • Receiver Rated Voltage: AC110-220V  
 • Receiver Standby Current: <5mA  
 • Receiving Sensitivity: -107dBm



**WDB-403BF**

KINETIC, BATTERY FREE, DOORBELL  
 • Operating Distance up to 200M  
 • Self-Learning Code Function  
 • 58 Pcs. Music for Choosing  
 • Grade Volume Adjusting;  
 • IP44 Water Proof;  
 • Music and Indicate Light 4 Mode for Choosing, Ringing + Flashing Light / Ringing Only / Flashing Light Only / Ringing + Lighting all the Time  
 • Transmitter Button Lifespan: 200k Times