



## Instruction Manual

Please read carefully before use and keep for future reference.

---

---

# Table of Contents

<b>Thank You .....</b>	<b>3</b>	<b>Using the CD Player .....</b>	<b>12</b>
<b>In the Box .....</b>	<b>3</b>	About Compact Discs .....	12
<b>Before You Start .....</b>	<b>4</b>	Loading a Disc.....	12
<b>At a Glance .....</b>	<b>5</b>	Playing a Disc.....	13
<b>Connect Power .....</b>	<b>9</b>	Repeat Playback .....	13
AC Power.....	9	Programming a Playlist .....	14
Battery Power.....	9	<b>Using the Cassette Player .....</b>	<b>14</b>
<b>Basic Functions.....</b>	<b>10</b>	About the Cassette Keys .....	14
Turning the Unit On and Off .....	10	Playing a Cassette Tape .....	14
Changing the Function Mode.....	10	Recording to Cassette Tapes .....	15
Headphone Jack .....	11	Record Protection .....	16
<b>Using the Radio.....</b>	<b>11</b>	Caring for the Cassette Mechanism.....	17
Tuning to Radio Stations.....	11	<b>Using the AUX Input .....</b>	<b>18</b>
Saving Stations to Preset Memory .....	12	<b>Warnings and Precautions.....</b>	<b>19</b>
		<b>Specifications .....</b>	<b>23</b>

---

---

# Thank You

We know you have many choices when it comes to technology; thank you for choosing us here at Naxa Electronics. Established in 2001 in Los Angeles, California, we are dedicated to delivering products that entertain and delight.

We trust that you will be happy with your purchase. Please read this manual carefully and save it for reference.

---

---

# In the Box

Please take a moment to make sure that you have everything in the list below. Although we make every effort to ensure that each Naxa device is securely packed and sealed, we know a lot can happen in between us and you. If anything is missing, check back with your local retailer to get immediate assistance.

- NPB-268 Portable CD/Cassette Boombox
- AC power cable
- User manual

---

# Before You Start

Please take note of the following before you start.

- Do not block the ventilation openings or holes.
- Avoid installing the unit in locations described below:
  - Places exposed to direct sunlight or close to heat radiating appliances (such as electric heaters, or on top of other stereo equipment that radiate heat).
  - Places lacking ventilation or dusty places.
  - Places subject to constant vibration.
  - Places that are humid or moist.
- Operate turning controls and switches as instructed in manual.
- Before turning on the power for the first time, make sure that the power cord is properly installed.
- Store your tapes or CD in a cool area to avoid damage from heat.

**CAUTION: TO REDUCE THE RISK OF ELECTRIC SHOCK, DO NOT REMOVE COVER (OR BACK). NO USER SERVICEABLE PARTS INSIDE, REFER SERVICING TO QUALIFIED SERVICE PERSONNEL.**

**WARNING:** Remove batteries if exhausted or if they will not be used again for a long period. The incorrect use of batteries can cause electrolyte leakage and will corrode the compartment or cause the batteries to burst, therefore:

- Do not mix battery types, e.g., alkaline with zinc carbonate.
- When inserting new batteries, replace all batteries at the same time.

# At a Glance

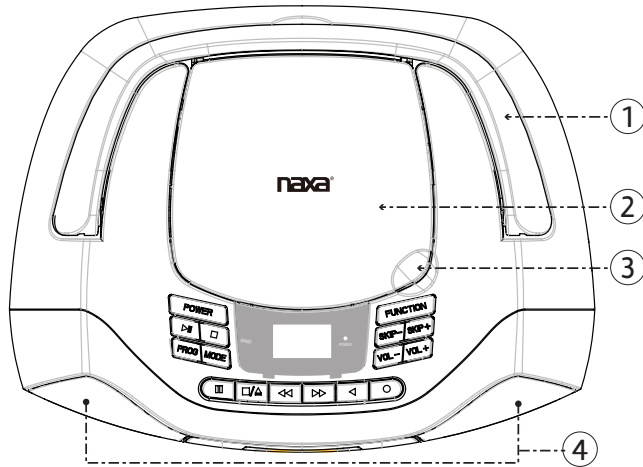

1	Handle	Raise the handle to transport the unit safely and easily.
2	CD compartment	Load compact discs here. The label side should face up.
3	CD door latch	Press here to open/close the door of the CD compartment [2]. <b>Never open the compartment while a CD is playing or spinning!</b>
4	Speakers	Full-range drivers deliver powerful stereo sound.

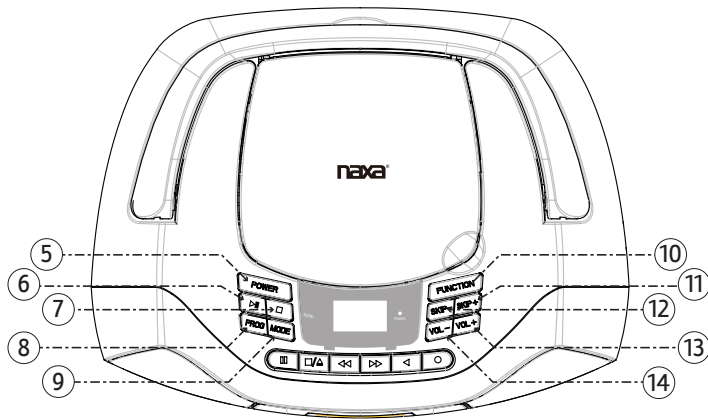

5	POWER key (Standby)	Press to turn the unit on. Press and hold to turn the unit off.
6	▶	CD: Press to start, pause, or resume CD playback.  Radio: Press to automatically scan for and save stations to preset memory.
7	■ BAND	CD: Stop CD playback.  Radio: Change the radio band (AM, FM).
8	PROG	CD: Press to enter Program mode to create a custom CD playlist.  Radio: Press to select a preset station. Press and hold to save a preset station.
9	MODE	Press to change the Play mode during CD playback (repeat, repeat all, random).
10	FUNCTION	Press to change the active source mode (radio, CD, tape, AUX).
11	SKIP+	CD: Next/Forward key.  Radio: Tune/Scan Up key.
12	SKIP-	CD: Previous/Reverse key.  Radio: Tune/Scan Down key.
13	VOL+	Press to increase the volume level.
14	VOL-	Press to decrease the volume level.

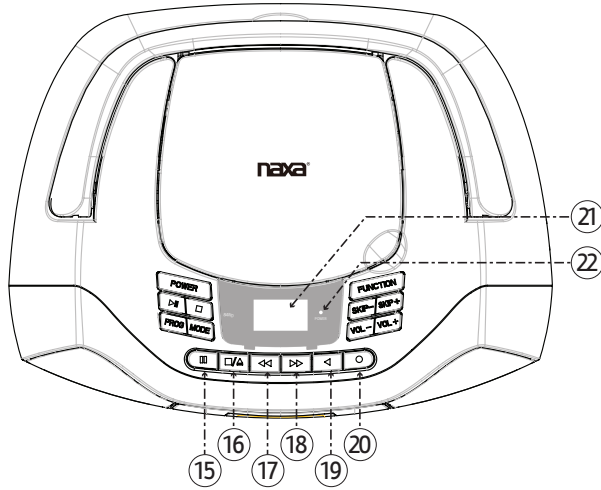

15		Pause. Press to pause tape playback or recording. Depress the key again to re-sume playback or recording.
16		Stop/Eject. Press to stop tape playback. When playback is stopped, press to open the cassette compartment [23].
17		Fast-forward. Press to fast forward through the tape when playback is stopped.
18		Rewind. Press to rewind the tape when playback is stopped.
19		Play. Press play to start tape playback.
20		Record. Press down together with the cassette PLAY key [19] to start recording.
21	LCD screen	Displays player status information (e.g., active source mode, track numbers, station frequency, etc.)
22	Power indicator	Lights up red when the unit is on.

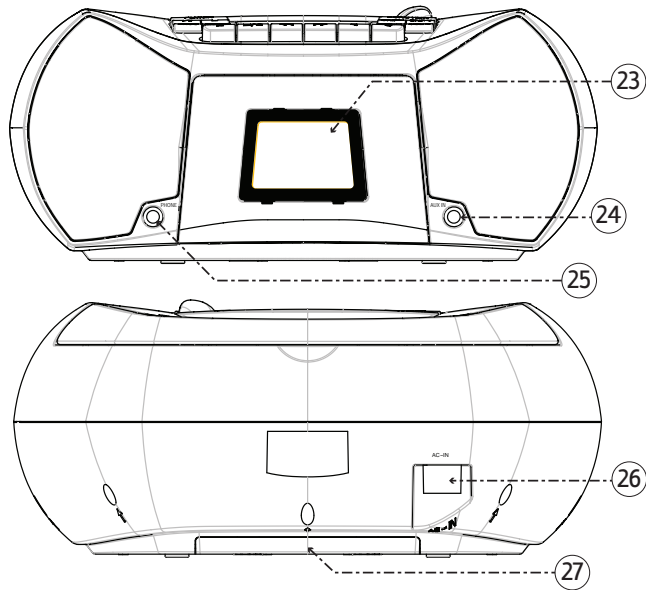

23	Cassette compartment	Load cassette tapes for playback or recording.
24	AUX Input jack	Play audio from a device that is connected to this 3.5mm input jack.
25	Headphone output jack	Connection for headphones with a 3.5 mm plug. The speaker output is disabled when headphones are in use.
26	AC power socket	Connector for the included AC power cable.
27	Battery compartment	Load 8 UM-1 "C" size batteries into the compartment for portable power.



---

---

# Connect Power

The unit can be powered by AC household power, or by batteries.

## AC Power

This unit runs on AC 120 V power. Use the included power cord to connect the AC power socket [26] to a household wall outlet that provides AC 120 V power.



*Do not connect this unit to a power source other than that which is indicated here and on the rating label of the unit.*

*Please be sure the power outlet you plug this unit into is working and receives constant (unswitched) power.*



*Battery operation will be automatically disabled when AC power is used.*

## Battery Power

Install 8 UM-2 “C” size batteries to enjoy music wherever you are.

1. Remove the lid from the battery compartment [27] found on the bottom of the main unit.
2. Load eight “C” size batteries, taking care to match the polarities marked on the inside of the compartment.



*It is time to change the batteries when the sound output of the unit becomes distorted or CD player operation appears unstable. Replace all of the exhausted batteries at the same time as soon as possible to avoid battery leakage.*



*Make sure that the batteries are installed with their poles in the proper orientation. Improper installation may result in damage to the unit and property and will void the warranty.*

*Remove the batteries if they are exhausted or will not be used for a long time.*



*Batteries contain chemicals that may be regulated by your local government. Dispose of them properly according to regulations.*

*Do not incinerate the batteries. The batteries may explode or leak.*

*Do not mix old and new batteries.*

*Do not mix alkaline, standard (carbon-zinc) or rechargeable (nickel-cadmium) batteries.*

---

---

# Basic Functions

## Turning the Unit On and Off

To turn the unit on, press the POWER (Standby) key [5]. The power indicator [22] will light up.

To turn the unit off, press the POWER key [5] again.

## Changing the Function Mode

While the boombox is on, press FUNCTION [10] to change the active source mode. The available modes are:

- RADIO: Listen to AM or FM radio broadcasts.
- CD: Play compact discs (CD-audio).
- TAPE: Play cassette tapes.
- AUX: Play audio from devices connected to the AUX input jack.

## Headphone Jack

Lower the volume on the boombox before connecting headphones or earphones to the 3.5 mm headphone

output jack [25]. Once connected, press VOL+ or VOL- [13, 14] to slowly adjust the volume to a comfortable level.



*The speakers will be disabled when headphones are connected.*



*Using headphones for prolonged periods or at a high volume can damage your hearing permanently.*

---

---

## Using the Radio

Listen to FM or AM radio broadcasts.

Press FUNCTION [8] to change the active source mode to Radio. The FM or AM indicator will light on the LCD screen and the station frequency will be displayed.

### Tuning to Radio Stations

- Press the ■/BAND button [7] to select the AM or FM radio band.
- Tune to a station by pressing SKIP+ or SKIP- [11, 12]. The station frequency is shown on the LCD screen.
- Scan to the next station by briefly holding SKIP+ or SKIP- [11, 12].
- To tune to a preset station, press PROG [8]. While the current preset station number is shown on the LCD screen (e.g., P01), press SKIP+ or SKIP- [11, 12] to change the preset station.



*The ST indicator on the LCD screen will light when the tuner is locked in on an FM stereo signal.*

## Saving Stations to Preset Memory

Press ►|| [6] to automatically scan for stations and save them to preset memory. This will overwrite any previously saved stations.

To manually save a station to preset memory:

1. Tune to the station you want to save.
2. Hold PROG [8] until the LCD screen shows the next available preset station number (e.g., P06).
3. Press SKIP+ or SKIP- [11, 12] to select preset station number.
4. Press PROG [8] to save the station to the selected preset station number.

---

---

## Using the CD Player

Listen to CD and CD-R/RW discs.

Press FUNCTION [10] to change the active source mode to CD. The CD indicator will light on the LCD screen.

### About Compact Discs

This player is compatible with all digital audio CDs, digital audio CD-Recordable discs (CD-R) and CD-Rewritable discs (CD-RW) that have been finalized, and CD-DA format digital audio CDs.



*Only handle a CD by its edge. Avoid touching the label or the playable side with your hands or any other object.*

### Loading a Disc

1. Open the CD compartment [2]. Gently lift the CD door latch [3] to open it.
2. Load a compatible disc. Place the CD into the compartment [2] with its label facing up.

3. Close the CD compartment [2]. Gently lower the door to close it.
  4. The player will attempt to read the disc once the door is closed.
    - The LCD screen [21] will show the number of playable tracks on the disc.
    - If the disc was loaded incorrectly, is incompatible with the player, or is unreadable for some other reason, the screen will read “NO.”
- To select a track to play:
    - Press SKIP+ [11] to skip to the next track.
    - Press SKIP– [12] to skip back to the previous track.
  - To scan through a track at high speed:
    - Press and hold SKIP+ or SKIP– during playback [11, 12]. Play will advance or reverse quickly through the current track; release the key to resume playback at normal speed.



*To ensure good system performance, wait until the player recognizes and reads the disc before proceeding.*

## Playing a Disc

With a compatible disc in the CD compartment [2]:

- Press ►► [6] to start playback.
- To pause playback, press ►► [6] while a disc is playing. Press ►► [6] again to resume playback.
- To stop playback, press ■ [7].

## Repeat Playback

You can change the order in which the tracks of a CD are played. Press MODE [9] to change the playback mode.

Indicator	Mode	Description
REP	Repeat	The current track will play repeatedly until play is stopped.
REP ALL	Repeat all	All tracks will play repeatedly until play is stopped.
RAND	Random	Tracks will play in random order until play is stopped.

 To return to normal playback, press **MODE** [9] until none of the mode indicators appear on the LCD screen.

## Programming a Playlist

When the CD is stopped, you can select up to 20 CD tracks to play in any order that you choose.

1. Press **■** [7] to make sure that playback has stopped.
2. Press **PROG** [8]. The LCD screen [21] will display “01” and the **PROG** indicator will flash.
3. Use the **SKIP+** or **SKIP-** keys [11, 12] to choose a track to enter into the playlist.
4. Press **PROG** [8] to save the track into the playlist.
5. Repeat steps 3 and 4 until your playlist is complete. Press **▶||** [6] to start the playlist; play will start from the first track in the playlist.
6. Press **■** [7] to stop the programmed playlist, then press **■** once more to delete the program and return to normal playback.

---

---

# Using the Cassette Player

Listen to cassette tapes.

Press **FUNCTION** [10] to change the active source mode to **TAPE**. The LCD screen [21] will display **TAP**.

## About the Cassette Keys

The cassette keys are located above the cassette compartment [23]. They are numbered [15] to [20] in the section “At a Glance” and throughout this manual.

You can learn more about their functions in the section “At a Glance.”

## Playing a Cassette Tape



*Do not use C120 cassettes or other specialized cassettes with this player.*

1. Open the Cassette compartment [23]. Press **□/▲** [16] while playback is stopped.

2. Load the cassette into the compartment with its exposed magnetic tape facing up.



*The tape will spool from the right to left reel. If the cassette you are loading is wound to the beginning, the full reel should be on the right.*



*Take up any slack in the tape before loading the cassette into the compartment. Turn the cassette reel with your finger or a pencil until the tape is taut.*

3. Close the cassette compartment [23]. Push the door of the compartment into the body of the player until it is securely closed.
4. Cue the tape (optional). Press << [17] or >> [18] to go to the part of the tape that you want to play.
5. Start playback. Press < [19].
6. To stop playback, press □/▲ [16].



*Your player is equipped with Auto Stop. When the end of the tape is reached, the player will automatically stop the tape and all keys will disengage.*

## Recording to Cassette Tapes

You can record from different sources to cassette tape. Record with quality cassettes only (e.g., IEC type 1).



*Do not use C120 cassettes or other specialized cassettes with this player.*

1. Choose the source of the recording you want to make. Press FUNCTION [10] to change the active source mode:
  - **CD** to record from the CD player.
  - **RADIO** to record from the radio.
  - **AUX** to record from an audio source connected to the AUX input jack [24].
2. Get the source ready. For CD and AUX, cue playback to the point that you want to record. For the radio, tune to the station that you want to record.
3. Get the target ready. Load a blank cassette tape into the cassette compartment [23]. Optionally, cue the tape to the point that you want to record to with the << or >> keys [17, 18].

 *The exposed magnetic tape of the cassette should face up.*

 *Take up any slack in the tape before loading the cassette into the compartment. Turn the cassette reel with your finger or a pencil until the tape is taut.*

4. Start recording. When you are ready to record, press **O** [20] together with **<** [19].

 *Do not force the **O** key down if you feel resistance! If you cannot press the **O** key down, the cassette tape may be write-protected. Refer to the section “Record Protection” to learn more.*

5. Stop recording. Press **□/▲** [16] to stop recording.

 *You may also pause recording by pressing **⏏** [15]. Depress the **⏏** key again to resume recording.*

## Record Protection

Protect your cassette tape from accidental erasure with the Record Protection tab.

1. Locate the tab on your cassette tape. It can be found on the long side of the cassette, opposite the side with the exposed tape (see the illustration below).



Record Protect Tab for Side “A”

2. Use a sturdy, flat object such as a small screwdriver or file to break off the tab.

 *The tab may have been removed already if the cassette tape is not a new, blank tape designed for recording. Commercial recordings and other pre-recorded tapes are usually record protected.*

When the record protection tab is missing, you will not be able to press **O** [20].





*If you would like to record with a cassette tape that is missing its record protection tab, use a small piece of adhesive tape to cover tab opening.*



*Never lubricate any part of the player under any circumstance.*

*Never turn off the player during playback, or leave the player in PLAY mode while the power is off. Doing so can damage the pinch wheel.*

## Caring for the Cassette Mechanism

Cassette care and cleaning products are available for purchase from local and on-line retailers. The tape head and pinch wheel/capstan assemblies need to be cleaned after every 10 hours of use.

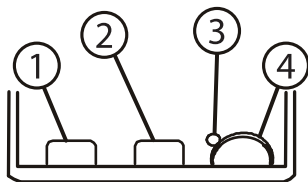

- 1 Erase head
- 2 Record/Play head
- 3 Capstan
- 4 Pinch roller



*Press  $\triangleleft$  [19] to get better access to the heads and roller in order to clean them.*



*The erase head, record/play head and the surface of the pinch roller are delicate parts. Never touch these parts with hard objects (e.g., screwdrivers, metal).*

---

---

# Using the AUX Input

Listen to devices connected to the AUX input jack [24].



Press FUNCTION [10] to change the active source mode to AUX. The LCD screen [21] will display **AUX**.

1. Connect the audio source to the player. Use an optional audio patch cable to connect the 3.5mm headphone or line-out jack of the audio source to the 3.5mm AUX Input jack [24] found on the front of the player.
2. Lower the volume on the player. Press VOL- [14] to lower the volume level.
3. Prepare the audio source. Start playback on the device. Set the volume level of the device to approximately 80% of its maximum.
4. Adjust the final volume. Press VOL+ or VOL- on the player to set the volume to a comfortable level [13, 14].



*Use the audio source to control playback (e.g., stop, play, next). Use the player to control the volume.*

# Warnings and Precautions

	<b>CAUTION</b> WARNING: SHOCK HAZARD. DO NOT OPEN. AVIS: RISQUE DE CHOC ELECTRIQUE. NE PAS OUVRIR	
<b>CAUTION:</b> TO REDUCE THE RISK OF FIRE AND ELECTRIC SHOCK, DO NOT REMOVE THE COVER (OR BACK) OF THE UNIT. REFER SERVICING ONLY TO QUALIFIED SERVICE PERSONNEL.		



The lightning flash with arrowhead symbol within an equilateral triangle is intended to alert the user to the presence of uninsulated “dangerous voltage” within the product’s enclosure that may be of significant magnitude to constitute risk of electric shock



The exclamation point within an equilateral triangle is intended to alert the user to the presence of important operation and servicing instructions in the literature accompanying the appliance.

## CLASS 1 LASER PRODUCT

CLASS 1 LASER PRODUCT  
APPAREIL LASER DE CLASSE 1  
PRODUCTO LASER DE CLASE 1

CAUTION  
INVISIBLE LASER RADIATION WHEN  
OPEN AND INTERLOCKS DEFEATED.  
AVOID EXPOSURE TO BEAM



This product contains a low power laser device.

## On Protection Against Laser Energy Exposure

- As the laser beam used in this product is harmful to the eyes, do not attempt to disassemble the casing.
- Stop operation immediately if any liquid or solid object should fall into the cabinet.
- Do not put anything in the safety slot. If you do, the laser diode will be ON when the disc compartment door is still open.
- If the unit is not to be used for a long period of time, make sure that all power sources are disconnected from the unit. Remove all batteries from the battery compartment, and unplug the AC-DC adapter from the wall outlet. Make it a practice to remove the AC-DC adapter by grasping the main body and not by pulling the cord.
- This unit employs a laser. The use of controls or adjustment or performance of procedures other than those specified here may result in exposure to hazardous radiation.

## CAUTION

- Do not block the ventilation openings or holes.
- Do not place any naked flames (such as lighted candles) on the apparatus.
- When discarding batteries, follow all local rules and laws governing the disposal of batteries. Consider the environmental impact of your actions!
- Invisible laser radiation when open and interlock has failed or been defeated. Avoid direct exposure to beam.
- To prevent fire or shock hazard, do not expose this appliance to rain or moisture.

## Important Safety Information

1. **Read Instructions:** All the safety and operating instructions should be read before the product is operated.
2. **Retain Instructions:** The safety and operating instructions should be retained for future reference.
3. **Heed Warnings:** All warnings on the product and in the operating instructions should be adhered to.
4. **Follow Instructions:** All operating and usage instructions should be followed.
5. **Cleaning:** Unplug this product from the wall outlet before cleaning. Do not use liquid cleaners or aerosol cleaners. Use a damp cloth for cleaning.
6. **Attachments:** Use only attachments recommended by the manufacturer. Use of other attachments may be hazardous.
7. **Water and Moisture:** Do not use this product near water (e.g., near a bathtub, washbowl, kitchen sink, laundry tub, in wet basements, or near a swimming pool and the like).
8. **Accessories:** Do not place this product on an unstable cart, stand, tripod, bracket, or table. Use only with carts, stands, tripods, brackets, or tables recommended by the manufacturer or sold with the product. Any mounting of the product should follow the manufacturer's instructions and should use a mounting accessory recommended by the manufacturer. A product and cart combination should be moved with care. Quick stops, excessive force, and uneven surfaces may cause the product and cart combination to overturn.
9. **Ventilation:** Slots and openings in the cabinet are provided for ventilation to ensure reliable operation of the product and to protect it from overheating. These openings should never be blocked by placing



the product on a bed, sofa, rug, or other similar surface. This product should not be placed in a built-in installation such as a bookcase or rack unless proper ventilation is provided or the manufacturer instructions have been adhered to.

10. **Power Sources:** This product should be operated only from the type of power source indicated on the rating label. If you are not sure of the type of power supply to your home, consult your product dealer or local power company. For products intended to operate from battery power or other sources, refer to the operating instructions.
11. **Grounding or Polarization:** This product may be equipped with a polarized alternating-current line plug that has one blade wider than the other. This plug will only fit into the power outlet in one direction. This is a safety feature. If you are unable to insert the plug fully into the outlet, try reversing the direction of the plug. If the plug does not still fail to fit, contact an electrician to replace the obsolete outlet. Do not defeat the safety purpose of the polarized plug.
12. **Power-Cord Protection:** Power supply cords should be routed so that they are not likely to be walked on or pinched by items placed upon or against them, paying particular attention to cords at plugs, convenience receptacles, and at the point which they exit from the product.
13. **Protective Attachment Plug:** The product may be equipped with an attachment plug with overload protection. This is a safety feature. See the operating instructions for replacement or directions to reset the protective device. If replacement of the plug is required, be sure the service technician has used a replacement plug that has the same overload protection as the original plug as specified by the manufacturer.
14. **Lightning:** For added protection for this product, unplug it from the wall outlet during a lightning storm or when it is left unattended and unused for long periods of time. This will prevent damage to the product due to lightning or power-line surges.

15. **Overloading:** Do not overload wall outlets, extension cords, or integral convenience receptacles as this can result in a risk of fire or electric shock.
16. **Object and Liquid Entry:** Never push objects of any kind into this product through openings as they may touch dangerous voltage points or short-out parts that could result in a fire or electric shock. Never spill liquid of any kind on the product.
17. **Service:** Do not attempt to service this product yourself as opening or removing covers may expose you to dangerous voltage or other hazards. Refer all servicing to qualified service personnel.
18. **Damage Requiring Service:** Unplug this product from the wall outlet and refer servicing to qualified service personnel under the following conditions: a) when the power supply or plug is damaged; b) if liquid has been spilled or if objects have fallen into the product; c) if the product has been exposed to rain or water; d) if the product does not operate normally by following the operating instructions. Adjust only those controls that are covered by the operating instructions as improper adjustment of other controls may result in damage and will often require extensive work by a qualified technician to restore the product to its normal operation; e) if the product has been dropped or damaged in any way; f) when the product exhibits a distinct change in performance—this indicates a need for service.
19. **Replacement Parts:** When replacement parts are required, be sure that your service technician has used replacement parts specified by the manufacturer or have the same characteristics as the original part. Unauthorized substitutions may result in fire, electric shock, or other hazards.
20. **Safety Check:** Upon completion of any service or repairs to this product, ask the service technician to perform safety checks to ensure that the product is in proper operating condition.
21. **Wall or Ceiling Mounting:** The product should be mounted to a wall or ceiling only as recommended by the manufacturer.
22. **Heat:** The product should be situated away from heat sources such as radiators, heat registers, stoves, or other products (including amplifiers) that produce heat.

## FCC NOTICE

This device complies with Part 15 of the FCC Rules. Operation is subject to the following two conditions: (1) this device may not cause harmful interference, and (2) this device must accept any interference received, including interference that may cause undesired operation.

Note: This equipment has been tested and found to comply with the limits for a Class B digital device, pursuant to Part 15 of the FCC Rules. These limits are designed to provide reasonable protection against harmful interference in a residential installation. This equipment generates, uses and can radiate radio frequency energy and, if not installed and used in accordance with the instructions, may cause harmful interference to radio communications. However, there is no guarantee that interference will not occur in a particular installation. If this equipment does cause harmful interference to radio or television reception, which can be determined by turning the equipment off and on, the user is encouraged to try to correct the interference by one or more of the following measures:

- Reorient or relocate the receiving antenna.
- Increase the separation between the equipment and receiver.
- Connect the equipment into an outlet on a circuit different from that to which the receiver is connected.
- Consult the dealer or an experienced radio/TV technician for help.

## CAUTION ON MODIFICATIONS

Any changes or modifications not expressly approved by the grantee of this device may void the authority granted by the FCC to operate the equipment.

## WARNING:

This product contains lead, a chemical known to the State of California to cause cancer and birth defects or other reproductive harm. ***Wash hands after handling.***

---

---

# Specifications

<b>Speaker Output</b>	12 W peak, 2.4 W RMS
<b>Media Support</b>	CD, CD-R/RW, Cassette
<b>Radio Tuner</b>	AM, FM
<b>Preset Memory</b>	20 AM, 20 FM
<b>Input</b>	3.5mm AUX jack
<b>Output</b>	3.5mm headphone jack
<b>Power Source</b>	AC 120 V 8 x C batteries (not included)
<b>Standby Power</b>	1 W
<b>Operating Power</b>	12 W

Note: Product are improved continuously. We reserve the right to modify the product and specifications without prior notice.

---

---

# Support

If you have problems with your device, please consult the instructions in this manual.