



42" Sound Bar with Bluetooth®

NHS-7008



Instruction Manual

Please read carefully before use and keep for future reference.

Table of Contents

Thank You	3	Manual Station Preset	14
In the Box	3	Using Bluetooth® Mode.....	14
Installing Your Sound Bar	4	Pairing a Bluetooth® Device	14
On a Table Top.....	4	NFC One-Touch Setup.....	15
How to Mount the Sound Bar to a Wall.....	4	Bluetooth® Controls	15
At a Glance	7	Using AUX 1 Mode.....	16
Front View	7	Using AUX 2 Mode	16
Remote Control.....	9	Using OPT 1 Mode	17
Using the Remote Control.....	10	Using USB & SD Modes.....	17
Replacing the Battery	10	Warnings and Precautions.....	18
Connect Power	11	Troubleshooting Guide.....	22
Getting Started.....	12	Specifications	23
Turning the Unit On and Off	12		
Setting the Time.....	12		
Setting the Source Mode	12		
Adjusting the Volume.....	13		
Using FM Radio Mode	13		
FM Radio Controls	13		
Optimizing FM Radio Reception.....	13		
Automatic Station Scan.....	13		

Thank You

We know you have many choices when it comes to technology; thank you for choosing us here at Naxa Electronics. Established in 2001 in Los Angeles, California, we are dedicated to delivering products that entertain and delight.

We trust that you will be happy with your purchase. Please read this manual carefully and save it for reference.

In the Box

Please take a moment to make sure that you have everything in the list below. Although we make every effort to ensure that each Naxa device is securely packed and sealed, we know a lot can happen in between us and you. If anything is missing, check back with your local retailer to get immediate assistance.

- NHS-7008
- AC power adapter
- Wall mount kit
- Remote control
- RCA audio cable
- AUX audio cable
- User manual

Installing Your Sound Bar

On a Table Top

Find a flat and level surface to place your sound bar. Most people position the sound bar centered below their TV.

When placing the Sound Bar on an entertainment center, bookshelf, or any type of enclosed space, be sure to allow space around the Sound Bar for ventilation. If the Sound Bar is enclosed in a tight space without adequate ventilation, heat generated by the Sound Bar could produce a potential heat hazard.

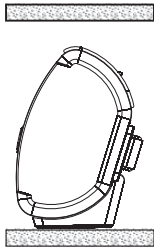

How to Mount the Sound Bar to a Wall

A wall mounting kit is included in the box for your convenience. However, each installation environment is unique and has its own requirements; you may need additional material to prepare the sound bar for mounting.

You will need the following:

- Included wall mounting kit (2 wall brackets, 4 screws, 4 drywall plugs)
- Pencil
- Level
- Ruler
- Drill
- Hammer (for drywall installations only)
- Cross-head screwdriver

Naxa Electronics recommends that wall mounting be performed by a qualified professional installer. Naxa is not liable for any accidents or damage to property or the sound bar due to incorrect installation.

1. Using a level and ruler, use a pencil to mark 2 points on the wall that are 33.4 inches apart. Use the level to ensure that the points are on the same horizontal plane.

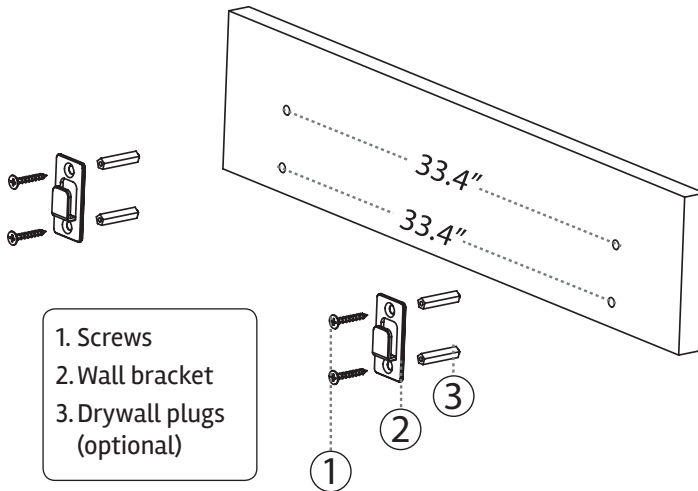

2. Use the wall brackets as a template to mark a second set of points on the wall. Make sure the bracket is level before marking the wall, and that the points are level with each other.
3. Use the drill to drill a hole at each of the 4 marked points on the wall. Select a drill bit that is appropriate for your wall's construction. If you are using the dry-wall plugs as directed in step 4, make sure the diameter of the drill bit matches the diameter of the plugs.
4. **For drywall installations only;** for wood, skip to step 5: using a hammer, gently insert the drywall plugs in each of the holes. The plugs should fit completely into the hole, with the tops of the plug flush with the wall.
(For installations in brick or concrete walls, please obtain masonry plugs from your local hardware store.)
5. Use a screwdriver and two screws to affix the left bracket to the wall, then do the same for the right bracket. Hand-tighten the screws; do not over-tighten them! **Note the orientation of the hooks on the bracket in the illustration.**

6. Make sure that the brackets are stable and firmly attached to the wall. Locate the mount points on the rear of the sound bar, then hook the sound bar onto the brackets.

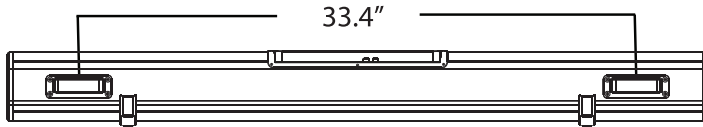

The wall that the brackets are mounted on should be of sufficient strength to support the weight of the sound bar, and the brackets should be perpendicular to the floor.

At a Glance

Front View

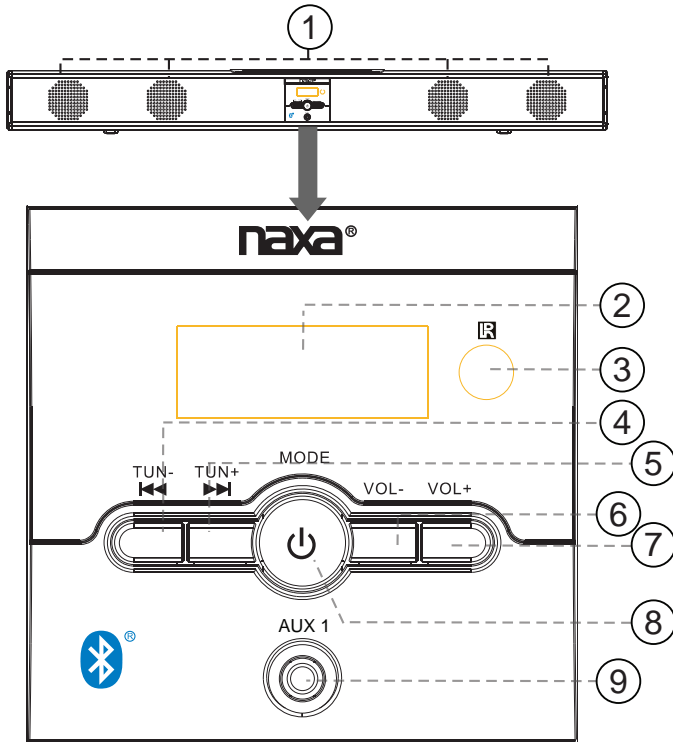



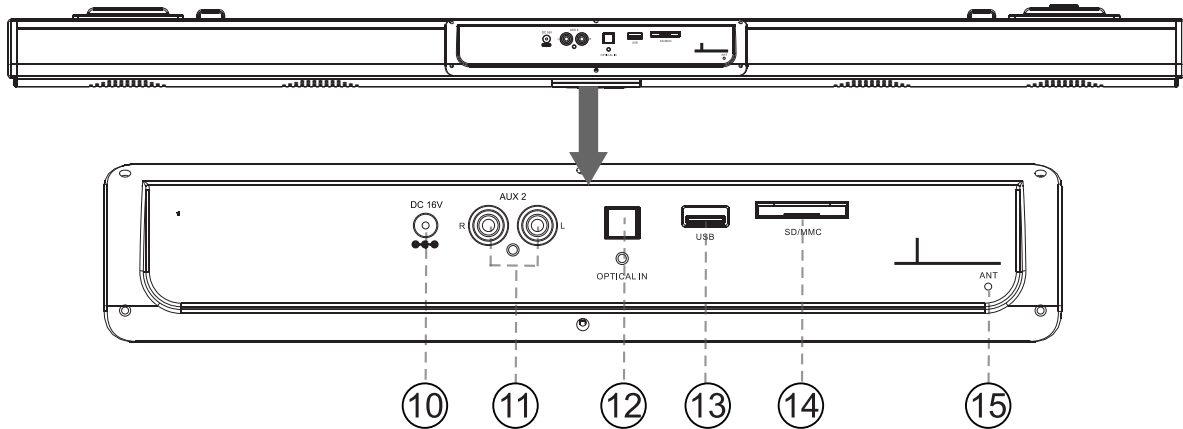



1	Speakers	Full-range drivers and built-in subwoofers.
2	Display screen	Displays status information.
3	Remote sensor	Detects signals from the remote control.
4	TUN- / ◀◀	Tuning down, Previous/Reverse
5	TUN+ / ▶▶	Tuning up, Next/Forward
6	MODE ⏻	Press to change the active connection mode (FM, BT, USB, CARD, OPTI, AUX 1, AUX 2). Press to turn the unit on and off.
7	VOL-	Volume down
8	VOL+	Volume up
9	AUX 1 connector	AUX 1 mode. 3.5mm stereo connection for devices with 3.5mm line-out or headphone output.



10	Power socket	Connector for the included power adapter.	14	CARD	CARD mode. Load memory cards here. Refer to the specifications for a list of supported memory card types.
11	AUX 2 connector	AUX 2 mode. RCA stereo connection for devices with red and white RCA left/right audio output.	15	ANT	Antenna lead. Extend and position the antenna wire for optimal radio signal reception.
12	OPTI connector	OPTI mode. Digital optical audio connection for devices with optical audio output.			
13	USB port	USB mode. Load USB memory sticks here. The USB port is designed for media playback from flash memory devices. It is not designed to charge high-power devices.			

Remote Control



	Power/standby. Press to turn the unit on or off (standby).		Clock. Press and hold to adjust.
MODE	Mode. Press to change the active source mode.		Mono/Stereo. Press to change between FM mono and stereo reception mode. Using mono mode will give you the best change of receiving stations from far away.
	Mute. Press to temporarily disable or to restore the sound.	VOL-	Volume down. Press to decrease the volume level.
FM SCAN	FM scan. Press to find FM radio stations within reception range.	VOL+	Volume up. Press to increase the volume level.
TUN-	Tuning down. Press to tune to a lower radio station.	BASS-	Bass down. Press to decrease the bass level.
	Previous. Press to skip to the previous track (BT, USB, SD).		Pause or resume playback (BT, USB, SD).
TUN+	Tuning up. Press to tune to a higher radio station.	BASS+	Bass up. Press to increase the bass level.
	Next. Press to skip to the next track (BT, USB, SD).	TREBLE-	Treble down. Press to increase the treble level.
M+	Memory up. Press to go to the next FM radio preset station.	TREBLE+	Treble up. Press to increase the treble level.
EQ	Equalizer. Press to change the audio equalizer preset stat		

Using the Remote Control

Before using the remote for the first time, remove and discard the plastic insulation tab as shown.

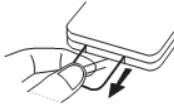

Aim the IR emitter of the remote control at the remote sensor and then press a key.

The remote control will work within 16 feet of the remote sensor and within 30 degrees from center.

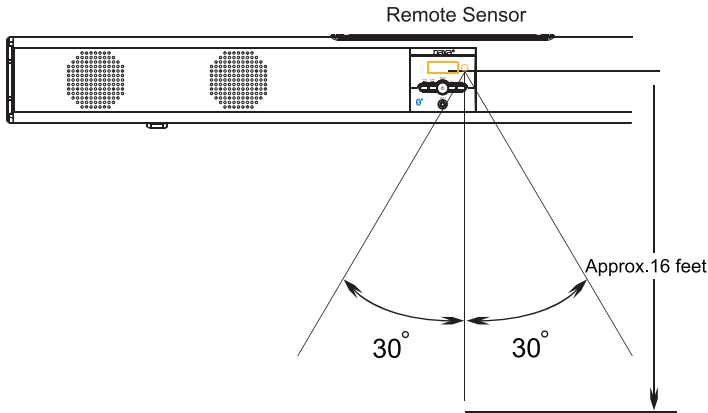

Obstacles between the unit and transmitter may prevent the remote control from

working. Direct sunlight, incandescent or fluorescent lamps, or any other strong light shining on the remote sensor of the unit may prevent the remote control from working properly.

Replacing the Battery

The remote control is powered by one (1) “CR2025”-type battery.

1. Squeeze the tab of the battery compartment to the right while drawing the battery tray out.
2. Take note of the orientation of the existing battery. Replace it with a new “CR2025” lithium battery, making sure to match the polarity of the old battery (as well as the +/- markings on the remote control).
3. Push the tray back into place.

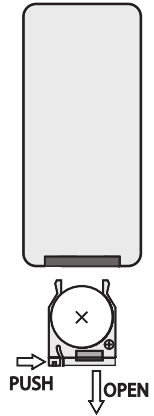

The battery in the remote will last for approximately 1 year. Replace the battery if the remote control does not

work. Always dispose of batteries according to your local municipal regulations.



The batteries used in the remote control may present a fire or chemical burn if mistreated. Do not recharge, disassemble, incinerate, or heat the battery (~212°F). Do not mix old with new batteries, or different types of batteries. Remove the batteries from the remote if it will not be used for a long period of time. Keep batteries away from children.

Do not spill water on the remote control. Do not use the remote control for other equipment at the same time.

Battery Precaution

Heed the following when handling the battery used in this device.

1. Use only the size and type of battery specified.
2. Be sure to install the battery properly by matching the polarities indicated in the battery compartment. Installing a battery with reversed poles may cause damage to the device.
3. Remove the battery from the device if it is empty or will not be used for a long time to prevent damage or injury from leakage.
4. Do not charge a battery that is not designed for charging.

Connecting Power

Use the included AC power adapter to connect the unit to AC household power.

- Connect the two-pronged end of the adapter to a household power outlet.
- Connect the barrel plug end of the adapter to the Power socket [10] of the unit.



The adapter supports AC 100–240V power only. Do not connect the power adapter to a power outlet other than that which is indicated here and on the rating label of the power adapter as this may result in the risk of fire or electric shock.

Disconnect the unit from power if it will not be used for a long time.

Do not handle the power plug with wet hands. Doing so may cause electric shock. Do not use the adapter with any other power source.

Getting Started

Turning the Unit On and Off

To turn the unit on, press the \odot button [6]. The display screen [2] will light up.

To place the unit in Standby mode, press the \odot button on the remote until the display screen [2] shows the time.

To turn the unit off completely, disconnect the unit from power.

Setting the Time

The time is shown on the display screen [2] when the unit is in Standby mode. To set the time:

1. Press and hold the CLOCK/MO/ST button on remote control. The hour digit will blink.
2. Press the TUN- or TUN+ button [4, 5] to adjust the hour while it is blinking. Press CLOCK/MO/ST to save the hour; the minutes will blink.

3. Press the TUN- or TUN+ button [4, 5] to adjust the minutes while it is blinking. Press CLOCK/MO/ST to save the minutes. The time is now set,

Setting the Source Mode

Press MODE [6] to set the active source mode. This controls which connection is being used.

The display screen [2] will indicate which mode has been selected when MODE [6] is pressed.

Display Screen	Connection Mode
FM	FM radio
BT	Bluetooth®
USB	USB [13]
CARD	SD/SDHC card reader [14]
OPT1	Optical audio input [12]
AUX1	3.5mm audio input [9]
AUX2	RCA stereo input [11]

Adjusting the Volume

- Use the VOL- and VOL+ keys [7, 8] to decrease or increase the volume level, respectively.
- Press the MUTE key on the remote to disable sound output completely. Press the MUTE key again to restore sound output.

Using FM Radio Mode

Press MODE [6] to set the active mode to FM.

FM Radio Controls

To do this...	...do this
Tune to a higher frequency	Press TUN+
Tune to a lower frequency	Press TUN-
Auto-tune to a higher station	Press and hold TUN+
Auto-tune to a lower station	Press and hold TUN-
Tune to the next preset station	Press M+
Toggle between Mono and Stereo reception modes	Press CLOCK/MO/ST

To do this...	...do this
Save a station to preset memory	Press FM SCAN
Scan for stations and auto save them to preset memory	Press and hold FM SCAN

Optimizing FM Radio Reception

- Fully extend the FM antenna wire [15] and position it for best radio reception.
- Use FM mono mode if a radio station is far away and its signal is weak. Press the CLOCK/MO/ST button on the remote to change between Mono and Stereo modes.

Automatic Station Scan

Use the station scan feature to find stations within broadcast reception range and save them to preset memory.

1. Press and hold the FM SCAN button on the remote. The sound bar will search for and store stations automatically.

Manual Station Preset

To save a station as a preset:

1. Press TUN- or TUN+ to tune to the station you want to save.
2. Press the FM SCAN button the remote. The display screen [2] will flash “CH00”.
3. Press M+ on the remote to change the preset station (e.g., CH01, CH02).
4. Press FM SCAN to save the station to the selected preset station.

Using Bluetooth® Mode

Press MODE [6] to set the active mode to BT.

Pairing a Bluetooth® Device

You will need to pair your Bluetooth device with the sound bar the first time you use them together.

1. Turn the sound bar on and press MODE [6] to set the active mode to BT. The sound bar will now be ready to pair with a device.
2. Use your Bluetooth device to search for available devices. The sound bar will announce itself as “NHS-7008.”
3. Select NHS-7008. Use the pairing code “0000” if your device asks for one.



Make sure Bluetooth® is enabled on your device. Please refer to the instructions that came with your device to learn more about how to connect it to other Bluetooth devices.

Only one device can be paired with the sound

bar at a time. Disable Bluetooth on other devices to prevent interference.

NFC One-Touch Setup

If you have a device that is equipped with NFC and Bluetooth, you can pair the device to the sound bar with a single tap. It's just that easy!

1. Place the sound bar in Bluetooth® mode (press the MODE button [6] until "BT" appears on screen.
2. Locate the NFC sensor on the "NFC" sticker on the sound bar. Touch the back of your device to the sound bar sensor. The sound bar will detect your device.
3. Your device may ask you for permission to pair with the sound bar. Select "yes" and pairing is complete!



Before attempting to use NFC to set up your Bluetooth connection, make sure that Bluetooth and NFC are enabled on your device. For devices running Android™ OS, you can find the NFC option in the "Settings > Wireless & Networks > More..." menu screen.

Bluetooth® Controls

To do this...	...do this
Pause or resume playback on a connected device.	Press .
Skip to the next track on a connected Bluetooth device.	Press .
Skip to the previous track on a connected Bluetooth device.	Press .

Using AUX 1 Mode

Press MODE [6] to set the active mode to AUX 1.

Use a 3.5mm AUX cable to connect devices with headphone out or line out connectors (e.g., smartphones, MP3 players, portable audio devices).

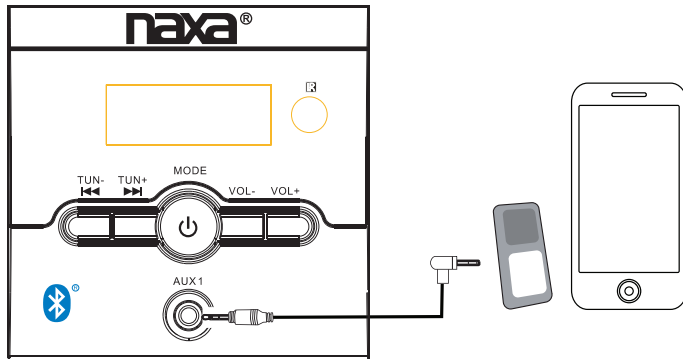

Operate the external device as directed by its manufacturer to control playback.

Using AUX 2 Mode

Press MODE [6] to set the active mode to AUX 2.

Use an RCA stereo patch cable to connect devices with white and red RCA stereo out connectors (e.g., TVs, DVD players, camcorders, Hi-Fi stereo and home theater components).

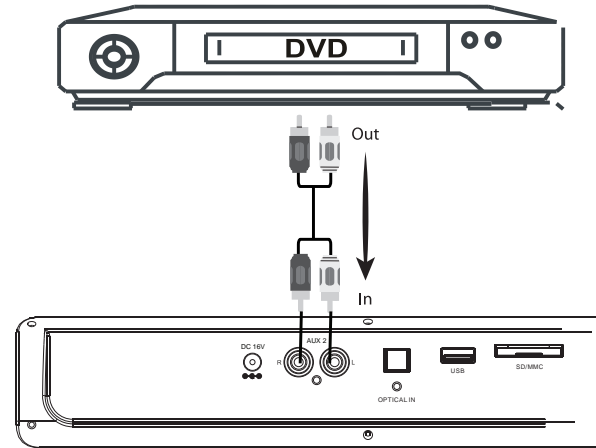

Operate the external device as directed by its manufacturer to control playback.

Using OPT 1 Mode

Press MODE [6] to set the active mode to OPT 1.

Use a optical audio patch cable to connect devices with a optical audio out connector (e.g., TVs, DVRs, Hi-Fi stereo and home theater components).

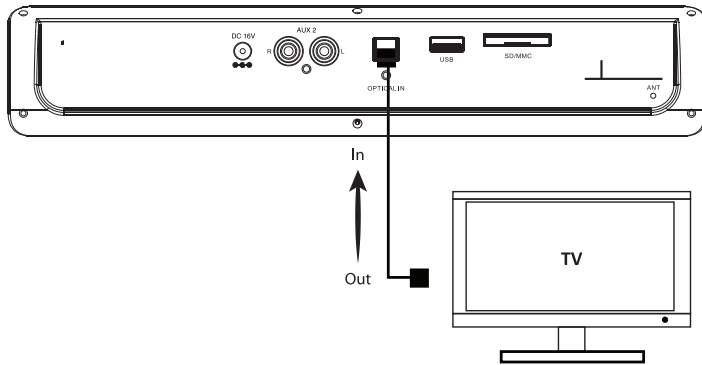

Operate the external device as directed by its manufacturer to control playback.

i *This optical connection only supports the uncompressed PCM signal format.*

Using USB & SD Modes

Install a USB drive or SD memory card and then press MODE [6] to set the active mode to USB or SD.

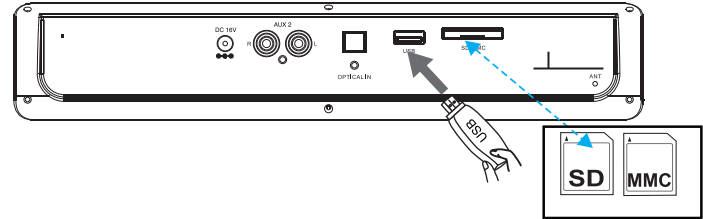

Install a compatible USB drive or memory card with music files on it. Please refer to the Specifications section to learn more about compatibility.

i *Music files must be saved to the root directory. The sound bar will not play files that are saved in a folder.*

To do this...

...do this

Pause or resume playback.

Press **⏮**.



Skip to the next track.

Press **⏭**.

Skip to the previous track.

Press **⏪**.

Warnings and Precautions

	CAUTION WARNING: SHOCK HAZARD. DO NOT OPEN. AVIS: RISQUE DE CHOC ELECTRIQUE. NE PAS OUVRIR	
CAUTION: TO REDUCE THE RISK OF FIRE AND ELECTRIC SHOCK, DO NOT REMOVE THE COVER (OR BACK) OF THE UNIT. REFER SERVICING ONLY TO QUALIFIED SERVICE PERSONNEL.		



The lightning flash with arrowhead symbol within an equilateral triangle is intended to alert the user to the presence of uninsulated “dangerous voltage” within the product’s enclosure that may be of significant magnitude to constitute risk of electric shock



The exclamation point within an equilateral triangle is intended to alert the user to the presence of important operation and servicing instructions in the literature accompanying the appliance.

CAUTION

- Do not block the ventilation openings or holes.
- Do not place any naked flames (such as lighted candles) on the apparatus.
- When discarding batteries, follow all local rules and laws governing the disposal of batteries. Consider the environmental impact of your actions!
- To prevent fire or shock hazard, do not expose this appliance to rain or moisture.

Important Safety Information

1. **Read Instructions:** All the safety and operating instructions should be read before the product is operated.
2. **Retain Instructions:** The safety and operating instruction should be retained for future reference.
3. **Heed Warnings:** All warnings on the product and in the operating instructions should be adhered to.
4. **Follow Instructions:** All operating and usage instructions should be followed.
5. **Cleaning:** Unplug this product from the wall outlet before cleaning. Do not use liquid cleaners or aerosol cleaners. Use a damp cloth for cleaning.
6. **Attachments:** Use only attachments recommended by the manufacturer. Use of other attachments may be hazardous.
7. **Water and Moisture:** Do not use this product near water (e.g., near a bathtub, washbowl, kitchen sink, laundry tub, in wet basements, or near a swimming pool and the like).
8. **Accessories:** Do not place this product on an unstable cart, stand, tripod, bracket, or table. Use only with carts, stands, tripods, brackets, or tables recommended by the manufacturer or sold with the product. Any mounting of the product should follow the manufacturer’s instructions and should use a mounting accessory recommended by the manufacturer. A product and cart combination should be moved with care. Quick stops, excessive force, and uneven surfaces may cause the product and cart combination to overturn.
9. **Ventilation:** Slots and openings in the cabinet are provided for ventilation to ensure reliable operation of the product and to protect it

from overheating. These openings should never be blocked by placing the product on a bed, sofa, rug, or other similar surface. This product should not be placed in a built-in installation such as a bookcase or rack unless proper ventilation is provided or the manufacturer instructions have been adhered to.

10. **Power Sources:** This product should be operated only from the type of power source indicated on the rating label. If you are not sure of the type of power supply to your home, consult your product dealer or local power company. For products intended to operate from battery power or other sources, refer to the operating instructions.
11. **Grounding or Polarization:** This product may be equipped with a polarized alternating-current line plug that has one blade wider than the other. This plug will only fit into the power outlet in one direction. This is a safety feature. If you are unable to insert the plug fully into the outlet, try reversing the direction of the plug. If the plug should still fail to fit, contact an electrician to replace the obsolete outlet. Do not defeat the safety purpose of the polarized plug.
12. **Power-Cord Protection:** Power supply cords should be routed so that they are not likely to be walked on or pinched by items placed upon or against them, paying particular attention to cords at plugs, convenience receptacles, and at the point which they exit from the product.



13. **Protective Attachment Plug:** The product may be equipped with an attachment plug with overload protection. This is a safety feature. See the operating instructions for replacement or directions to reset the protective device. If replacement of the plug is required, be sure the service technician has used a replacement plug that has the same overload protection as the original plug as specified by the manufacturer.

14. **Outdoor Antenna Grounding:** If an outside antenna is connected to the product, be sure the antenna system is grounded so as to provide some protection against voltage surges and built-up static charges. Article 810 of the National Electrical Code, ANS/NFPA 70 provides information with regard to proper grounding of the mast and supporting structure, grounding of the lead-in wire to an antenna-discharge unit, size of grounding conductors, location of antenna-discharge unit, connection to grounding electrodes, and requirements for the grounding electrode (see figure).

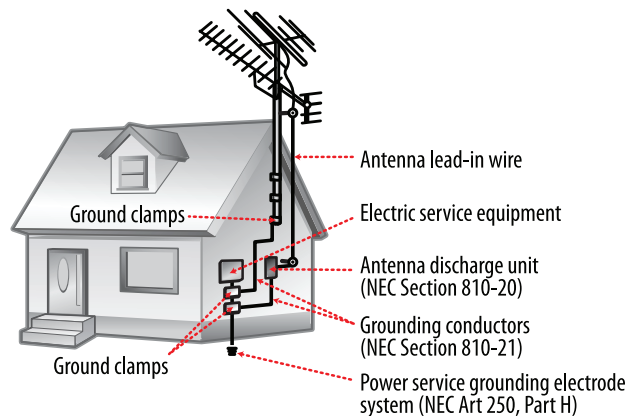

15. **Lightning:** For added protection for this product, unplug it from the wall outlet and disconnect the antenna or cable system during a lightning storm or when it is left unattended and unused for long periods of time. This will prevent damage to the product due to lightning or power-line surges.
16. **Power Lines:** An outside antenna system should not be located in the vicinity of overhead power lines or other electric light or power circuits, or where it can fall into such power lines or circuits. When in-

stalling an outside antenna system, extreme care should be taken to keep from touching such power lines or circuits, as contact with them might be fatal.

17. **Overloading:** Do not overload wall outlets, extension cords, or integral convenience receptacles as this can result in a risk of fire or electric shock.
18. **Object and Liquid Entry:** Never push objects of any kind into this product through openings as they may touch dangerous voltage points or short-out parts that could result in a fire or electric shock. Never spill liquid of any kind on the product.
19. **Servicing:** Do not attempt to service this product yourself as opening or removing covers may expose you to dangerous voltage or other hazards. Refer all servicing to qualified service personnel.
20. **Damage Requiring Service:** Unplug this product from the wall outlet and refer servicing to qualified service personnel under the following conditions: a) when the power-supply or plug is damaged; b) if liquid has been spilled or if objects have fallen into the product; c) if the product has been exposed to rain or water; d) if the product does not operate normally by following the operating instructions. Adjust only those controls that are covered by the operating instructions as improper adjustment of other controls may result in damage and will often require extensive work by a qualified technician to restore the product to its normal operation; e) if the product has been dropped or damaged in any way; f) when the product exhibits a distinct change in performance—this indicates a need for service.
21. **Replacement Parts:** When replacement parts are required, be sure that your service technician has used replacement parts specified by the manufacturer or have the same characteristics as the original part. Unauthorized substitutions may result in fire, electric shock, or other hazards.

22. **Safety Check:** Upon completion of any service or repairs to this product, ask the service technician to perform safety checks to ensure that the product is in proper operating condition.

23. **Wall or Ceiling Mounting:** The product should be mounted to a wall or ceiling only as recommended by the manufacturer.

24. **Heat:** The product should be situated away from heat sources such as radiators, heat registers, stoves, or other products (including amplifiers) that produce heat.

WARNING:

This product contains lead, a chemical known to the State of California to cause cancer and birth defects or other reproductive harm. ***Wash hands after handling.***

FCC NOTICE

This device complies with Part 15 of the FCC Rules. Operation is subject to the following two conditions: (1) this device may not cause harmful interference, and (2) this device must accept any interference received, including interference that may cause undesired operation.

Note: This equipment has been tested and found to comply with the limits for a Class B digital device, pursuant to Part 15 of the FCC Rules. These limits are designed to provide reasonable protection against harmful interference in a residential installation. This equipment generates, uses and can radiate radio frequency energy and, if not installed and used in accordance with the instructions, may cause harmful interference to radio communications. However, there is no guarantee that interference will not occur in a particular installation. If this equipment does cause harmful interference to radio or television reception, which can be determined by turning the equipment off and on, the user is encouraged to try to correct the interference by one or more of the following measures:

- Reorient or relocate the receiving antenna.
- Increase the separation between the equipment and receiver.
- Connect the equipment into an outlet on a circuit different from that to which the receiver is connected.
- Consult the dealer or an experienced radio/TV technician for help.

CAUTION ON MODIFICATIONS

Any changes or modifications not expressly approved by the grantee of this device may void the authority granted by the FCC to operate the equipment.

Troubleshooting Guide

This guide lists common problems and their solutions. Please refer to this guide before requesting service.

Symptom	Possible Cause	Possible Solution
There is no power.	The power adapter is not connected.	Connect the AC/DC power adapter.
	The unit is in Standby mode.	Press ⏻ to turn the unit on.
There is no sound.	The volume is set to the minimum level.	Press VOL+ to increase the volume level.
	The connected device is not in playback mode.	Start playback on the connected device and make its volume is set to a high level.
	The input source is incorrect.	Check which connection your device is using and then press MODE to set the active mode.

Symptom	Possible Cause	Possible Solution
The sound is distorted.	The bass level of the connected device is too high.	Reduce the bass level of the connected device. Press the BASS- button to reduce the bass level on the sound bar.
	The volume level is too high.	Press VOL- to reduce the volume level.
The remote control is not working.	The battery is dead.	Replace the battery in the remote control with a new one.
	The Bluetooth® connection is not working.	Reduce the distance between the Bluetooth® device and the sound bar. The Bluetooth® device has not been paired. Pair the Bluetooth® device with the sound bar.

Specifications

Speaker Output	Total 50W RMS 2 x 10W (drivers) + 30W (subwoofer)
Display type	LCD (blue)
Removable Media Support	USB, SD, SDHC (max 32 GB)
Playable Formats	MP3, WMA
Radio Tuner Type	Digital FM
Radio Preset Memory	20 FM
Input	Bluetooth® version 2.1+EDR with A2DP Optical digital audio RCA stereo audio 3.5mm AUX audio
Additional Features	NFC (one touch setup)
Power Source	AC 100–240V (DC 16V, 3.5A)
Operating Power / Standby Power	50W/0.6W

Note: Product are improved continuously. We reserve the right to modify the product and specifications without prior notice.

Support

If you have problems with your device, please consult the instructions in this manual.