

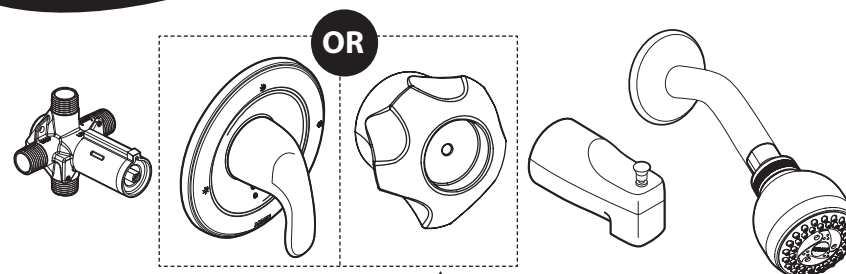

Buy it for looks. Buy it for life.®

## 6. Post Installation - Troubleshooting Guide

Problem	Possible Cause	To Diagnose	Remedy
<b>Hot/cold reversed</b>	Lines reversed/cartridge installed upside down	Hot/cold reversed	Rotate cartridge stem 180° so that the notch is facing down towards the drain.
<b>No water/low flow</b>	One or both supplies not on to the unit	No water/low flow	Turn both water supply valves counterclockwise to the on position
<b>Leak or drip from spout</b>	Grommets not sealing properly	Leak/drip from spout	Replace cartridge
<b>Only hot/no cold – Only cold/no hot</b>	Balancing spool stuck	Only hot/no cold – Only cold/no hot	Replace cartridge
<b>Stacking (Water comes out of the showerhead during tub fill mode)</b>	Choice of pipe/distance between valve and showerhead less than 46"/multiple elbows/anything restricting flow of water exiting valve	Water comes out of spout and showerhead at the same time	Remove tub spout and flush out debris – Replace undersized line or fittings
	Flow restriction between valve and tub spout	Water comes out of spout and showerhead at the same time causing restriction	Remove tub spout and flush out debris – Replace undersized line or fittings
	Valve installed upside down	Remove cartridge and verify that the outlet hole is in proper location (should be down). "Up" is on the top of the valve	Remove valve and reinstall in the proper orientation
<b>Restricted temperature range</b>	Handle (more common in knob models) is installed upside down	In the off position, able to turn the handle both clockwise and counterclockwise	Remove handle, rotate 180°, re-install
	Temperature limit stop out of position	Remove handle and see Step 5.3	Position temperature limit stop to desired temperature position
<b>Not able to install handle/handle rubs up against escutcheon</b>	Valve installed too far back from finished wall	Handle does not install	Contact Moen for assistance.
<b>Handle is hard to turn</b>	Cartridge stem is difficult to rotate	Difficult movement from handle	Replace cartridge or lubricate



One Handle Tub/Shower Valve Trim

One Handle Shower Only Valve Trim

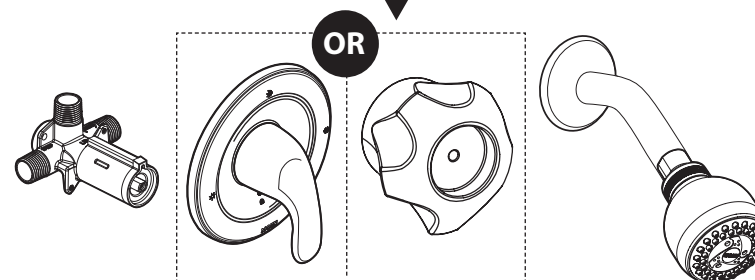

## Installation Instructions

*Styles and parts vary by model.*



Buy it for looks. Buy it for life.®

Thank you for choosing Moen.

Styles and parts vary by model.

### Tub/Shower Parts Supplied

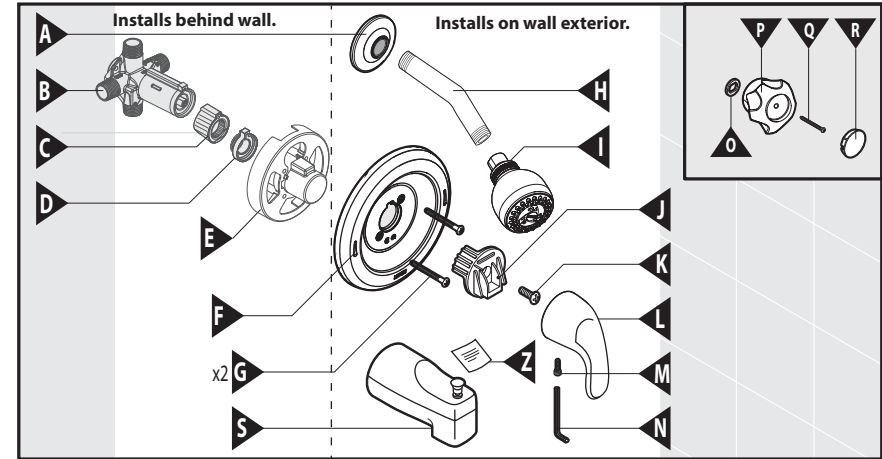

- A. Shower Arm Flange
- B. 4 Port Valve and Stop Tube
- C. Key Stop
- D. Adjustable Temperature Limit Stop
- E. Plaster Ground
- F. Escutcheon
- G. Escutcheon Screws (2-3/16")
- H. Shower Arm
- I. Showerhead
- J. Lever Handle Adapter
- K. Adapter Screw (1/2")
- L. Lever Handle
- M. Hex Screw
- N. 7/64" Hex Wrench
- O. Double D Washer
- P. Knob
- Q. Phillips Screw – Knob (1-1/2")
- R. Knob Cap
- S. Tub Spout
- Z. Product Identification Label

### Table of Contents

Tub/Shower Parts Supplied .....E3

Shower Only Parts Supplied .....E3

Rough-in Plumbing Variations

    Copper .....E4

    IPS .....E4

    PEX .....E5

    CVPC .....E5

    Helpful Tools.....E4-E5

Installation Schematics .....E6

Thin Wall/Thick Wall and Plaster Ground Installation .....E6-E8

Trim Installation .....E8-E10

Setting the Temperature Limit Stop .....E10-E11

Warranty.....E11

Care Instructions .....E12

Troubleshooting Guide.....E12

### Shower Only Parts Supplied

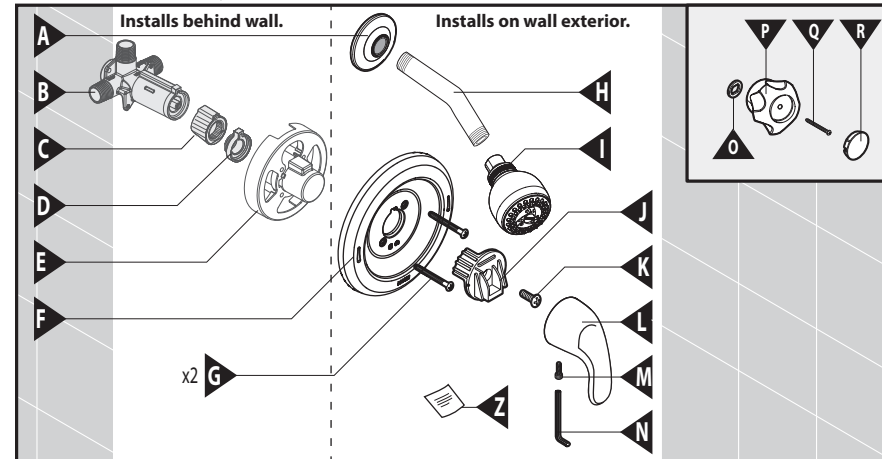

- A. Shower Arm Flange
- B. 3 Port Valve and Stop Tube
- C. Key Stop
- D. Adjustable Temperature Limit Stop
- E. Plaster Ground
- F. Escutcheon
- G. Escutcheon Screws (2-3/16")
- H. Shower Arm
- I. Showerhead
- J. Lever Handle Adapter
- K. Adapter Screw (1/2")
- L. Lever Handle
- M. Hex Screw
- N. 7/64" Hex Wrench
- O. Double D Washer
- P. Knob
- Q. Phillips Screw – Knob (1-1/2")
- R. Knob Cap
- Z. Product Identification Label

# 1. Determining Your Existing Rough-In Plumbing Installation

If you are replacing your plumbing valve, see below for four common plumbing methods. Specific rough-in fittings are **not supplied**. These may be required for installation. Remove existing handle and valve trim before replacing your valve. **Please follow all local building and plumbing codes.**

## Copper

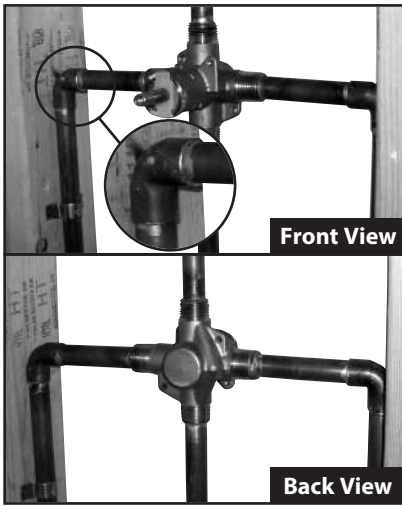

**Helpful Tools**  
For safety and ease of faucet replacement, Moen recommends the use of these helpful tools.

## PEX

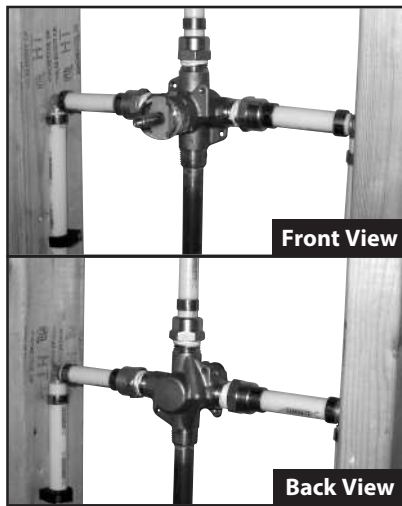

**Helpful Tools**  
For safety and ease of faucet replacement, Moen recommends the use of these helpful tools.

## IPS – (Galvanized Iron Pipe/Threaded Connections)

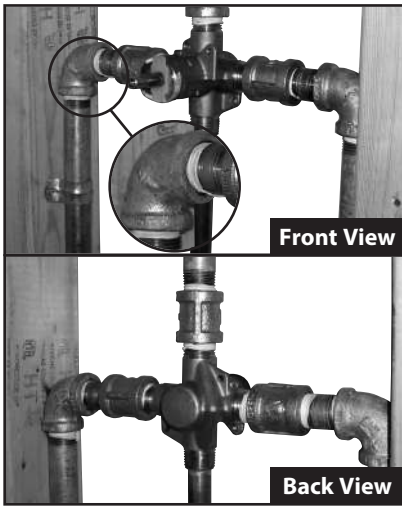

**Helpful Tools**  
For safety and ease of faucet replacement, Moen recommends the use of these helpful tools.

## CPVC

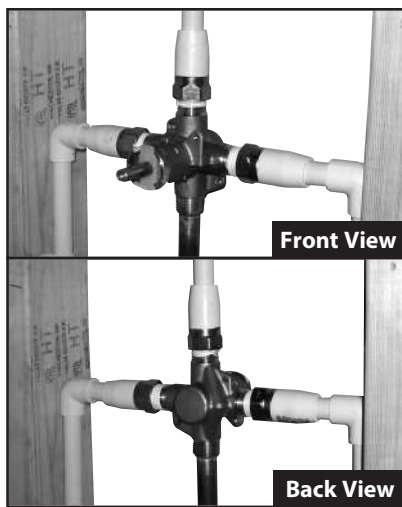

**Helpful Tools**  
For safety and ease of faucet replacement, Moen recommends the use of these helpful tools.

**⚠ CAUTION – TURN HOT & COLD WATER SUPPLIES OFF BEFORE REMOVING YOUR CURRENT FAUCET OR DISASSEMBLING YOUR CURRENT VALVE. OPEN FAUCET HANDLE TO RELIEVE WATER PRESSURE AND ENSURE COMPLETE WATER SHUT-OFF HAS BEEN ACCOMPLISHED.**

**⚠ CAUTION – TURN HOT & COLD WATER SUPPLIES OFF BEFORE REMOVING YOUR CURRENT FAUCET OR DISASSEMBLING YOUR CURRENT VALVE. OPEN FAUCET HANDLE TO RELIEVE WATER PRESSURE AND ENSURE COMPLETE WATER SHUT-OFF HAS BEEN ACCOMPLISHED.**

## 2. Installation Schematics – Measuring for Ideal Tub/Shower Performance

Installation of this product at non-recommended measurements may lead to issues such as water discharge from the showerhead during tub fill mode.

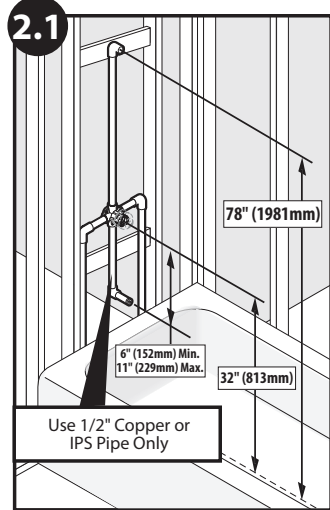

### Tub/Shower

Position the valve body 32 inches from the floor of the tub basin. The shower arm should be placed 78 inches above the floor of the tub basin (recommended installation of the shower arm is with a flanged elbow fitting – **not included** – and attached to a wood brace). The tub spout is to be no less than 6 inches and no greater than 11 inches below the valve. If installing a threaded tub spout, connect to the valve with 1/2 inch pipe or 1/2 inch copper tubing with a threaded adapter. If installing a slip-fit tub spout, connect to the valve with only copper tubing – no threaded adapter is needed.

See step 4.3 for tub spout tube length.

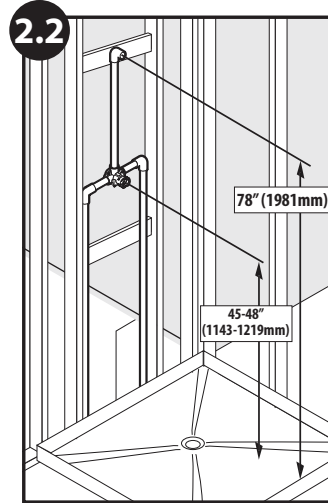

### Shower Only

The center of the valve should be 45 inches to 48 inches above the shower stall floor. The shower arm should be placed 78 inches above shower stall floor (recommended installation of the shower arm is with a flanged elbow fitting – **not included** – and attached to a wood brace).

## 3. Installing Your Valve

Moen has provided a plaster ground attached to the valve to be used as an installation and alignment guide. The plaster ground comes attached to the valve in the standard configuration from the factory. The plaster ground may be configured in different ways to accommodate various installation needs and maximize the aesthetic look of the valve in the shower. The plaster ground may be left in place until the trim is installed in order to protect the valve from possible construction damage.

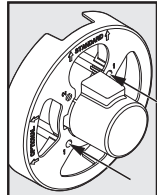

Plaster ground should be attached to valve using screw hole #1.

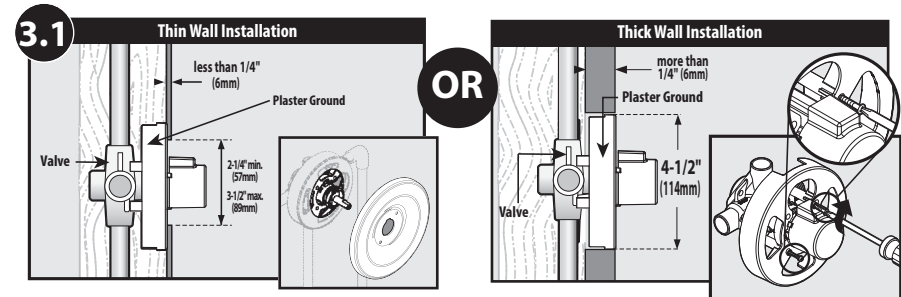

### Thin Wall Installation: (Using the plaster ground to support the valve)

The thin wall installation method is used when the tub/shower wall is less than 1/4 inches thick (such as a fiberglass tub surround) and will be the main source of support for the valve. Installations of this type require the plaster ground to **remain attached** to the valve.

1. Drill a 2-1/4 inch to 3-1/2 inch diameter hole thru the wall in the location shown in the installation schematic. This hole will allow access to the valve but not the plaster ground.
2. Center the plaster ground / valve assembly behind the wall opening.
3. Attach the water connections to the valve.
4. Break off the plaster ground cap with a pair of pliers. Once the trim is installed, the wall will be "trapped" between the trim and the plaster ground.

### Thick wall Installation: (Most installations)

The thick wall installation method is used when the tub/shower wall is greater than 1/4 inches thick. Thick walls are usually built up with materials such as cement board, drywall, tile etc. The plaster ground will aid with alignment and can remain attached to the valve until the valve has been positioned and secured.

1. Drill a 4-1/2 inch hole in the wall (the same size as the plaster ground) in the location shown in the installation schematic. This hole will help support the valve during installation and allow access for future servicing if necessary.
2. Position the plaster ground in the hole so that its printed face is flush with the finished wall. This will ensure that the valve will be at the proper height to accept the trim.
3. Mechanically secure the valve to the wall frame members by the use of straps (not included) or attaching the valve mounting holes to a cross member behind the valve through mounting tabs on the valve.
4. Attach the water connections to the valve.
5. Remove the plaster ground or break off the plaster ground cap and discard.

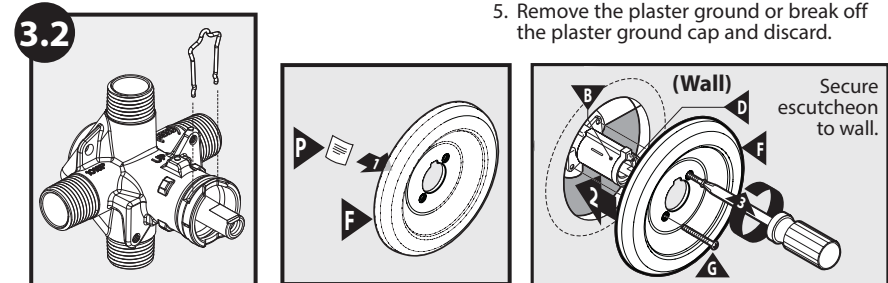

Ensure cartridge clip is installed prior to escutcheon installation. For a thin wall installation, the wall will be "trapped" between the plaster ground and the trim. The plaster ground may be discarded for thick wall installations. Once the valve is secured in place, remove the escutcheon screws (G). **Keep the escutcheon screws (G) for installation of the escutcheon (F)**. Place product identification label (P) on back of escutcheon. Make sure wall is clean, place the escutcheon (F) over the stop tube (B) then re-install the screws (G). A gasket on the back of the escutcheon provides a seal against the wall.

## Special instructions for shallow wall cavity installations:



This plaster ground valve assembly variation should only be used when the wall cavity restricts the depth the valve may be placed in the wall. It can be used with either the thick wall installation when the back wall prevents the plaster ground printed face from coming flush to the finished wall or the thin wall installation where the plaster ground / valve assembly will not fit within the wall cavity.

**Note:** Installing the valve using this method will result in the handle extending into the shower area farther and exposing more of the valve.

### Snap off Plaster Ground Cap

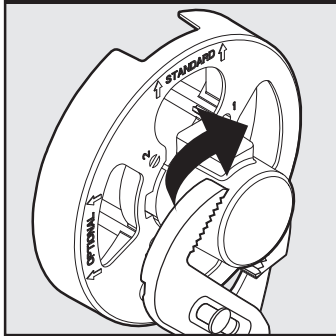

### Rotated 90° clockwise view

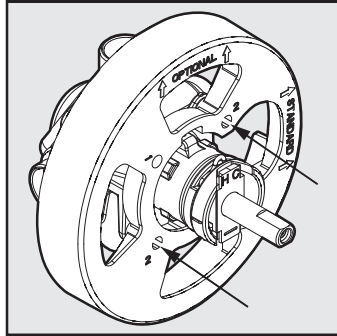

To reconfigure the plaster ground / valve assembly for a shallow wall cavity installation:

1. Using a pair of pliers, remove the plaster ground cap by snapping it off.
2. Remove the screw (s) holding the plaster ground to the valve.
3. Remove the #2 hole covers by prying them out with a flat bladed screw driver or drilling them out with a 3/16" drill bit.
4. Rotate the plaster ground 90° clockwise so that the arrows on either side of the word optional point upwards and reinstall the screws removed in step 2 into the holes marked 2.
5. Install the plaster ground per the thick wall installation or thin wall installation method described earlier.

## 4. Installing Your Moen Tub/Shower Trim



Wrap thread seal tape around the threads of the shower arm (H) then screw the arm into the threaded connection in the wall.

If there is a rubber washer inside the threaded adapter on the showerhead, continue to step 4.2A. If there is no rubber washer, then proceed to step 4.2B.

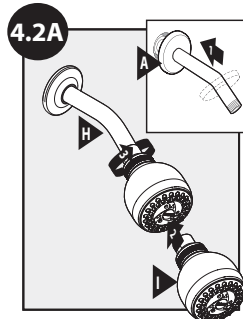

### 4.2A Plastic Shower Ball

Seal around the shower arm hole with sealant (caulk) then slide shower flange (A) over shower arm (H). Remove any debris from the shower arm to ensure proper flow. Then, simply thread showerhead (I) onto shower arm (H).

OR

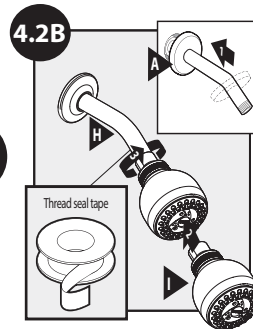

### 4.2B Metal Shower Ball

Seal around the shower arm hole with sealant (caulk) then slide shower flange (A) over shower arm (H). Wrap thread seal tape around threads at bottom of shower arm (H). Remove any debris from the shower arm to ensure proper flow. Thread showerhead (I) onto shower arm (H).

## Threaded Tub Spout Installation

4.3A

### Tub Spout Installation

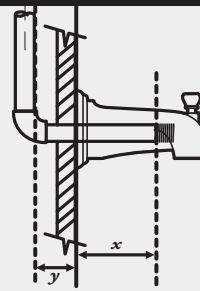

$$(y) + (x) + 1/4" = \text{Pipe Length}$$

To determine the proper pipe length, measure from the inside elbow shoulder to the wall (y) and from the threaded adapter inside of the tub spout to the base of the tub spout (x), then add 1/4".

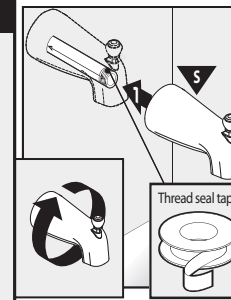

If this is a shower only installation, skip to step 4.4.

IPS (threaded) spouts are designed to screw onto a pipe with 1/2 inch male pipe threads. To determine the proper pipe length, measure from the inside elbow shoulder to the wall (y) and from the threaded adapter inside of the tub spout to the base of the tub spout (x), then add 1/4". Place thread seal tape around the pipe threading and a sealant (plumbers putty or caulk) around the base of the pipe to prevent leaking behind the wall. Thread the tub spout onto the pipe until flush with the wall.

## Cartridge Orientation

4.4

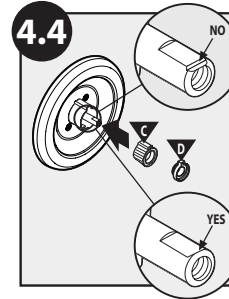

Now you are ready to attach the handle. Rotate cartridge stem so the notch at the end of the stem is facing down towards the drain. Insert the key stop (C) and the adjustable limit stop (D) into stop tube as shown.

## For Handles Installed with Plastic Handle Adapter (J)

4.5

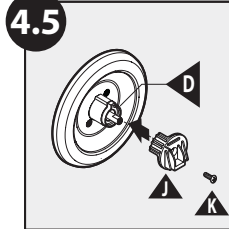

If this is a lever handle that attaches with the lever handle adapter (J), attach the plastic handle adapter (J) to the cartridge stem using the 1/2 inch adapter screw (K). Make sure the ridges on the back of the adapter (J) are to the left of the tab on limit stop (D).

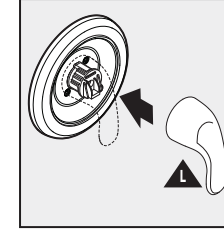

Place the lever (L) on the lever handle adapter.

## Other Possible Handle Type Installations

4.6

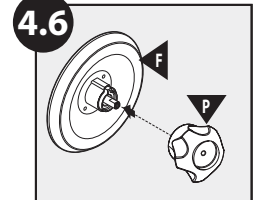

Place the knob handle (P) – onto the cartridge – make sure the indicator on the knob is pointing down.



## 5. Setting The Temperature Limit Stop and Finishing Your Tub/Shower Installation

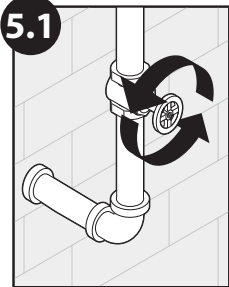

Turn on the hot and cold water supply to check for leaks and set temperature limit stop.

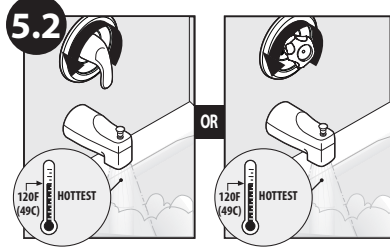

Rotate the lever **OR** knob counterclockwise until the water is to the maximum desired temperature, not to exceed 120 degrees F (49 degrees C). Seasonal maintenance of the maximum outlet temperature may be required due to changes in groundwater temperature. **TURN LEVER OR KNOB TO THE OFF POSITION ONCE THE TEMPERATURE IS SET.**

**If temperature exceeds 120 degrees, go to step 5.3.  
If temperature is less than 120 degrees, go to step 5.4.**

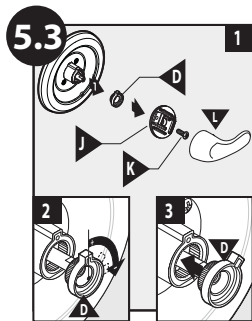

Remove the lever (L) and lever handle adapter (J). Note the position of the stop. Position the adjustable temperature limit stop (D) so the lever or knob stops at that position. This prevents the lever or knob from being turned into an unsafe temperature.

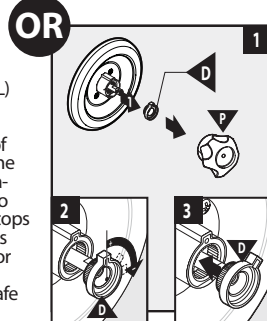

Remove the knob handle (P). Note the position of the stop. Position the adjustable temperature limit stop (D) so the lever or knob stops at that position. This prevents the lever or knob from being turned into an unsafe temperature.

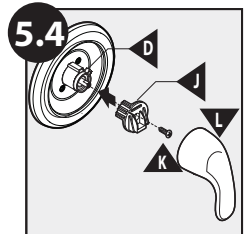

After setting the adjustable temperature limit stop to the desired position, remove the lever (L), reattach the lever handle adapter (J), adapter screw (K), and lever (L) – make sure ridges on back of (J) are to the left of the tab on (D).

**OR**

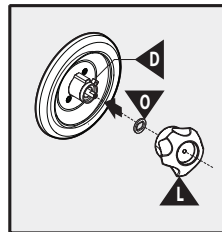

After setting the adjustable temperature limit stop to the desired position, reattach the double D washer (O) and knob (L) – make sure indicator on the knob is pointing down.

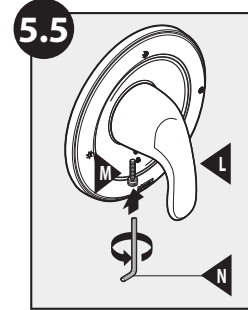

Using 7/64 inches hex wrench (N), insert and tighten hex screw (M) into lever (L).

**OR**

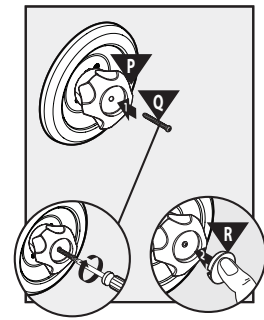

**OR** insert 1-1/2 inch Phillips screw (O). Tighten screw and insert cap (R).

### Care Instructions

To preserve the finish on the metallic parts of your Moen faucet, apply non-abrasive wax, such as car wax. Any cleaners should be rinsed off immediately.

### Spot Resist™ Stainless and Spot Resist™ Brushed Nickel Finishes:

Moen recommends cleaning the Spot Resist finish with a mild soap, rinsing thoroughly with warm water and drying with a clean, soft cloth. Never use cleaners containing abrasives (including abrasive sponges or steel wool), ammonia, bleach or sodium hypochlorite, organic solvents (e.g. alcohols) or other harsh chemicals (e.g. lime scale removers) to clean the Spot Resist finish, as they may damage the finish. Failure to comply with these cleaning instructions may void Moen's warranty.