

Backset

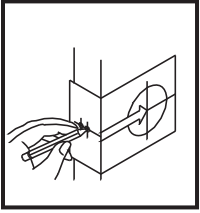

Backset is the distance from the door edge to the center of the hole on the door face. Master Lock door locks are supplied with an adjustable latch which can fit 2-3/8" (60mm) or 2-3/4" (70mm) backset.

Follow steps below to change backset.

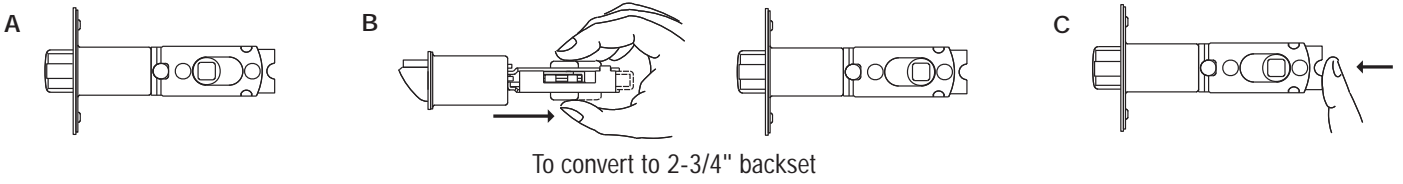

To convert to 2-3/4" backset

- This latch is for 2-3/8" (60mm) backset.
- Keep spindle cam in correct position as illustrated. Pull spindle cam all the way to the right.
- Your latch is now set for 2-3/4" (70mm) backset. To reset 2-3/8" backset, push spindle all the way back to the left.

Attach the latch face that matches the mortise in the edge of your door

To change latch faces:

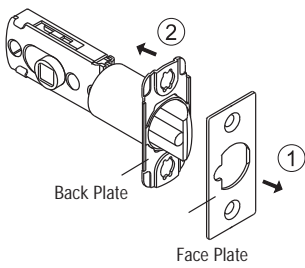

- Use a flat screwdriver to separate the face plate.
- Snap selected latch face onto backplate.

For drive in installation:

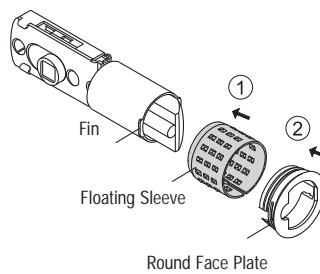

Push latchbolt to the end and hold. Align the round face plate opening with the fin on the latch. Push to the end and rotate the round face plate counter-clockwise. After assembly, release latchbolt to fully extend. Move the floating sleeve toward the round face plate until the edge fits into the ring opening of the round face plate.

Locate floating sleeve and round face plate and proceed.

Mark door with template

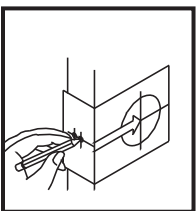

Select 2-3/8" or 2-3/4" (60mm or 70mm) backset as desired and mark center of hole on door face.

Drill holes

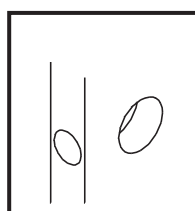

Drill 2-1/8" (54mm) hole on door face from both sides to avoid wood splitting. Drill 1" (25.4mm) hole for latch.

Install latch

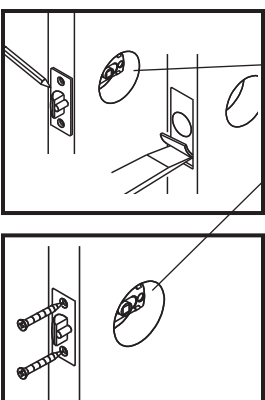

Insert latch in hole, mark outline of face plate and chisel 11/64" (4mm) deep.

Insert latch and tighten screws.

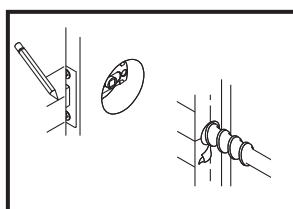

Close door to mark horizontal centerline of strike.

Measure one half of door thickness from doorstop and mark for the vertical centerline of strike. Drill 1" hole, 1/2" deep at the intersection of the horizontal and vertical centerlines.

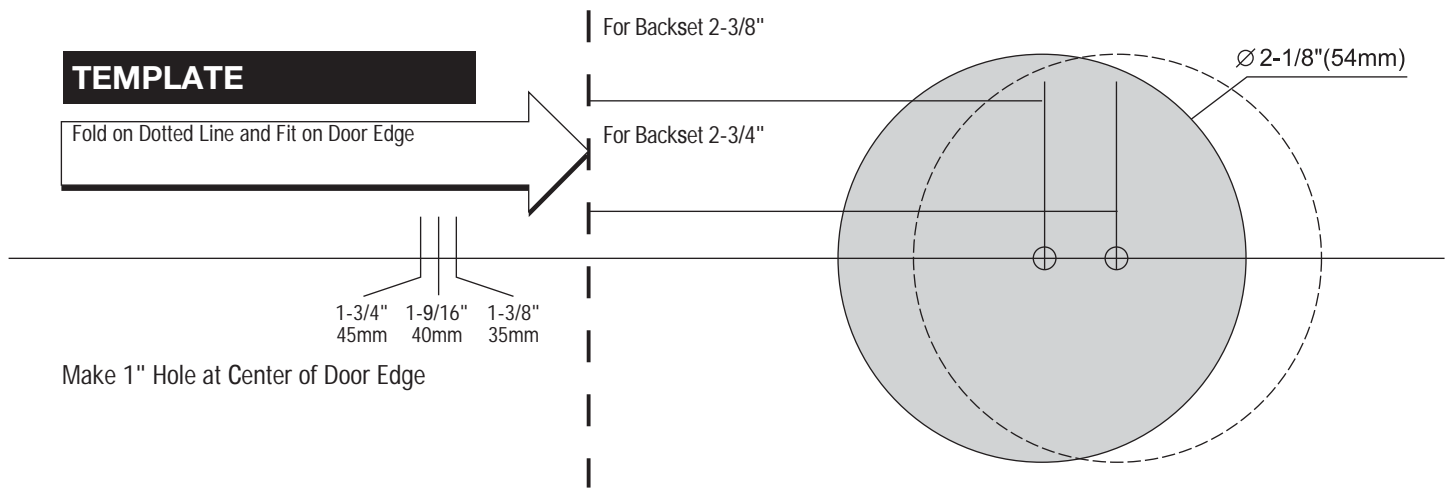

Install strike

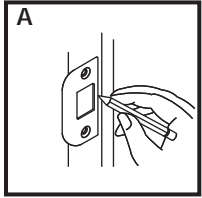

- Match screw holes on strike with vertical centerlines on jamb. Mark outline of strike plate and chisel out until strike is flush with jamb. (Approx. 1/8")
- Install strike and tighten screws.

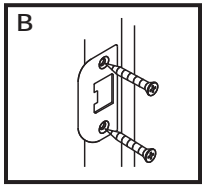

Install outside knob (or lever)

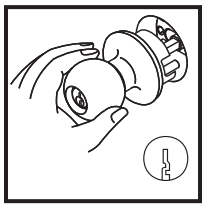

Insert spindle through latch. Press flush against door. (NOTE: Key hole must be in down position).

Install inside knob (or lever)

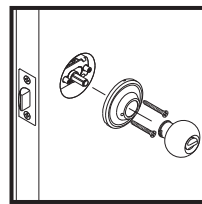

Install inside knob (or lever) and tighten screws until lock is firm.