



MERCHANDISE CATALOG 2021



TABLE OF CONTENTS

INTRODUCTION...2-5

- Table of Contents...2
- We Make It Easy...3
- Lippert Brand Announcement...4-5
- Gold Circle Dealer®...6-7

DEALER PROFIT PROGRAMS...8-75

INTERIOR...8-19

- Thomas Payne® Collection Furniture...8-12
- Thomas Payne Collection Mattresses...13
- Thomas Payne® Teddy Bear Covers and Matts...14
- Floë Drain Down System™...15
- Flow Max™ Water Pumps...16
- Flow Max Galley Faucets...17
- RV Air Freshener...18
- 360 Siphon®...19

SOLERA® AWNINGS...20-25

- Solera Universal Introduction...20
- Solera Universal Modular Display...21
- Solera Universal Slide Toppers...22
- Solera Universal Hardware...23
- Solera Universal Replacement Fabrics...24
- Solera Universal Shades and Rooms...25

STEPS, JACKS, AND DOORS...26-32

- Solid Step® Gen. 3 Entry Step & Accessories...26-27
- Entry Door Upgrade...28-29
- Jack-IT® Bike Solutions...30
- Step and Chassis Care...31
- Manual Steps...32

LEVELING & STABILIZATION...33-39

- Manual Stabilization...33
- Ground Control® Leveling...34
- JT's Strong Arm...35
- Tongue Jacks...36-37
- Trailair® Pin Boxes...38
- Power Stabilizer...39

REPAIR & REPLACE...40-49

- Alpha Systems Sealants...40-43
- Brake Assembly...44
- Slide-Out Repair Parts...45
- Axle and Suspension Repair Parts...46
- Flow Max 40V Power Cleaner...47
- Tire Linc® TPMS...48
- Tire Assembly...49

CURT® TOWING...50-75

- The New Standard In Towing...50-51
- Weight Distribution...52-53
- Echo® Mobile Brake Controller...54
- Brake Controller...55
- 5th Wheel Hitches...56-57
- 5th Wheel & Gooseneck OEM Puck System...58-59
- Bike Racks & Cargo Management...60-61
- Trailer Jack...62
- BetterWeigh™ Mobile Towing Scale...63
- ShockDrop™ Series...64-65
- Towing Accessories...66-69
- Towing Electrical...70-71
- Rambler™ Steel Tow Bar...72-73
- Cargo & Strap...74-75

IN-STORE MARKETING...76-81

- Planogram and Product Displays...76-77
- Spider Banners and POP Displays...78-79
- Retail Packaging...80-81

CONNECT WITH US...82

TECHNICAL TRAINING...83

WE MAKE IT EASY. YOU MAKE THE SALE.

Lippert™ develops custom product solutions in a broad range of categories that enhance the mobile lifestyle. We're proud to be a leading supplier of premium components to the recreational vehicle, residential housing, trailer, bus, marine and heavy truck industries. With state-of-the-art facilities, machinery and operational processes, we're committed to continued growth and improvement in all of the industries we serve.

We give you the personal attention and marketing support you deserve with must-have products, value-added profit programs, and comprehensive marketing and sales support. We give you all the tools you need to make products fly off the shelves!



*Solid Step and Entry Door
Upgrade Showroom Display*



*Thomas Payne
Showroom Display*



*Solera Dealer Modular
Showroom Display*





WHENEVER, WHEREVER, WE MAKE YOUR EXPERIENCE BETTER.

At Lippert, our goal is to make products that help you discover the ultimate sense of freedom. With thousands of team members globally, innovation is at our core and we will never wait to see what can be done better. Our products are inventive and inspired. We promise you the best Customer Service, period. Why? Because your adventure is on the line, and it's our job to make every future journey even better than those of the past.





LIPPERT
COMPONENTS
 GOLD CIRCLE DEALER®

Gold Circle Dealer®: Pillars to Success

Achieve Gold Circle Dealer status today! Qualification is easy and the benefits are strong. We have changed up existing programs and added great new programs to make it easier than ever for your dealership to achieve Gold Circle status.

In order to gain Gold Circle Status, you must purchase and stock the top program from each category in our 2021 Profit Program Lineup and purchase an additional six profit programs from any of the six tiers for a total of 12 profit programs. Talk to your Lippert Sales Representative today and get started on the Pillars to Success.



Interiors

TOP PROGRAM
 Thomas Payne®
 Furniture

ADDITIONAL PROGRAMS

Thomas Payne
 Mattresses
 Teddy Bear
 Bunk Covers
 and Mats
 Floë Drain
 Down System
 Flow Max™
 Water Pumps
 Flow Max
 Galley Faucets
 RV Air
 Fresheners
 360 Siphon®
 RV Vent Cap



Solera® Awnings

TOP PROGRAM
 Solera Universal
 Slide Toppers

ADDITIONAL PROGRAMS

Solera Universal
 Hardware
 Solera Universal
 Replacement Fabrics
 Solera Universal
 Shades and Rooms



Steps, Jacks and Doors

TOP PROGRAM
 Solid Step®
 Entry Steps

ADDITIONAL PROGRAMS

Manual
 Steps
 Jack-IT® Bike
 Solutions
 Tongue Jacks
 Entry Door
 Upgrades
 Step And
 Chassis Care



Leveling & Stabilization

TOP PROGRAM
 Manual
 Stabilization

ADDITIONAL PROGRAMS

Ground Control®
 Leveling Systems
 JT's Strong Arm
 Trailair®
 Pin Boxes
 Power
 Stabilizers



Repair & Replace

TOP PROGRAM
 Alpha Systems
 Sealants

ADDITIONAL PROGRAMS

Alpha Systems
 Backroom
 Slide-Out
 Repair Parts
 Axle and
 Suspension
 Repair Parts
 Flow Max
 Power Cleaner
 Tire Linc
 Tire Assembly
 Brake Assemblies



CURT Towing

TOP PROGRAM
 Weight
 Distribution

ADDITIONAL PROGRAMS

Brake Controllers
 5th Wheel Hitches
 5th Wheel OE/
 Puck Systems
 Bike Rack/Cargo
 Trailer Jacks
 Electrical
 BetterWeight™
 ShockDrop™
 Towing Accessories
 Towing Electrical
 Rambler™ Tow Bar
 Cargo & Strap

Gold Circle Dealer[®]: Program Benefits



Premier Customer
Support



Specialized
Marketing Solutions



Priority Profit
Program Support



Warranty Claims
Priority



Targeted Consumer
Advertising



Social Media
Consultation

Additional Benefits for 2021

Matching Charitable Event Contribution (up to \$500 in matching funds)

Priority Product Training

Dealership Event Door Prize Contribution

Retail Stimulus Program Opportunity

Product Hot Buy Opportunity

Join The Gold Circle Dealer Program

We want to build strong relationships with our committed partners like you, and help you succeed with value-added profit center programs, must-have products and comprehensive marketing and sales support. More opportunity, more value, more support, and more sales! Talk to your Lippert Sales Representative for more details on any of the great benefits offered with the Gold Circle Dealer Program.



THOMAS PAYNE® COLLECTION

BY **LIPPERT**

NEW COLLECTION FOR 2021

Quality workmanship and unsurpassed comfort are the foundation upon which every piece of Thomas Payne® Collection furniture is built. Equally impressive is the high level of functionality this furniture offers. With seven styles of furniture and multiple fabric options to choose from, we have all the seating and sleeping options to suit your needs.

AVAILABLE POLYHYDE™ VINYL

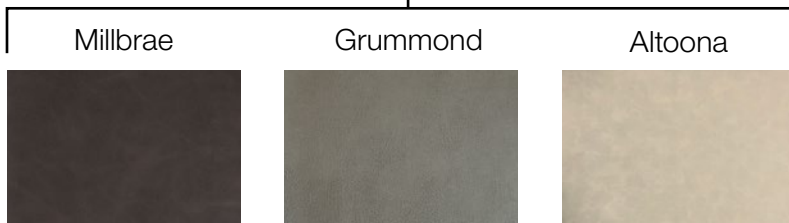

AVAILABLE FABRIC

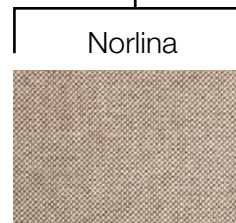

FIVE-YEAR HYDROLYSIS WARRANTY



All upgraded PolyHyde vinyls come with the new five-year Hydrolysis warranty

SEISMIC THEATER SEATING

- 3 modular pieces you can configure to fit any need
- Stylish, residential power recliner
- Upgraded PolyHyde vinyl cover with high density foam
- Fabric carries a 5 year hydrolysis warranty, an industry first
- Fits through any 26" or larger entry door
- Chaise-style footrest
- Space saving wall hugger recliners
- Available in 4 colors – Millbrae, Grummond, Altoona and Norlina



Shown In Millbrae

SEISMIC RIGHT AND LEFT HAND RECLINER FEATURES

- Heat
- Lights
- Massage
- Power recline, lumbar, and headrest
- Chrome LED cupholders color adjust lights
- Rear power outlet with single plug source per piece
- Accessories power port

SEISMIC CENTER CONSOLE FEATURES

- Chrome LED cupholders with color adjust lights
- Flip up power center with 110V outlets and USB charging port
- Storage compartment



Shown In Norlina

HERITAGE THEATER SEATING

- 4 modular pieces you can configure to fit any need
- Stylish, residential recliner
- Upgraded PolyHyde vinyl cover with high density foam
- Fabric carries a five-year hydrolysis warranty, an industry first
- Fits through any 26" or larger entry door
- Space-saving wall hugger recliners
- Chaise-style footrest
- Available in 4 colors – Millbrae, Grummond, Altoona and Norlina

DESTINATION TRI-FOLD SOFA

- Available in 3 sizes – 62", 68", 72"
- Stylish residential sofa
- Upgraded PolyHyde vinyl cover with high density foam
- Fabric carries a five-year hydrolysis warranty, an industry first
- As comfortable as a bed as it is as a sofa
- Fits through 26" or larger entry door
- Large storage space in base
- Takes up 12" less space when extended than a traditional hide-a-bed
- Converts to bed in 4 easy steps
- Available in 4 colors – Millbrae, Grummond, Altoona and Norlina



Shown in Grummond



Shown in Norlina
Leg kit sold separately

JACKKNIFE SOFA

- Available in 3 sizes – 62", 68", 72"
- Stylish, residential sofa
- Upgraded Polyhyde vinyl cover with high density foam
- Fabric carries a five-year hydrolysis warranty, an industry first
- Converts to bed in one easy motion
- Sofa includes matching kickboard
- Optional leg kit offered
- Folddown center console with cupholders
- Overall depth in bed position is 42"
- Available in 4 colors – Millbrae, Grummond, Altoona and Norlina

All jackknife sofas come with a kickboard. Leg kit also available, but must be ordered separately, Lippert part #364582



Shown in Millbrae



Shown in Grummond



Shown in Norlina

SWIVEL PUSH BACK RECLINER

- 360° swivel base and glider action
- Upgraded Polyhyde vinyl cover with high density foam
- Fabric carries a five-year hydrolysis warranty, an industry first
- Fits through any 26" or larger entry door
- Smooth, manual reclining action
- Chair size allows it to fit in tighter locations
- Available in 4 colors – Millbrae, Grummond, Altoona and Norlina

SWIVEL GLIDER RECLINER

- 360° swivel base and glider action
- Upgraded Polyhyde vinyl cover with high density foam
- Fabric carries a five-year hydrolysis warranty, an industry first
- Fits through any 26" or larger entry door
- Smooth manual Reclining Action
- Chaise-style footrest
- Available in 4 colors – Millbrae, Grummond, Altoona and Norlina

EURO RECLINER CHAIRS

- 360° swivel base and glider action
- Upgraded Polyhyde vinyl cover with high density foam
- Fabric carries a five-year hydrolysis warranty, an industry first
- Fits through any 26" or larger entry door
- Attached footrest
- Lightweight and easily moveable
- Available in 4 colors – Millbrae, Grummond, Altoona and Norlina

AVAILABLE POLYHYDE VINYLs



AVAILABLE FABRIC

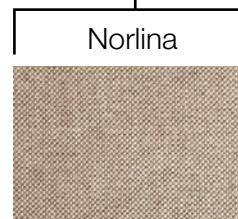

FIVE-YEAR HYDROLYSIS WARRANTY



All upgraded PolyHyde vinyls come with the new five-year Hydrolysis warranty



THOMAS PAYNE POWER PORT

Introducing the Thomas Payne Power Port. This new feature located on the armrests of the Seismic Series (Left hand and right hand recliners only) furniture pieces allows you to plug in various accessories so you can enjoy even more relaxation inside your RV.



WINE CADDY

Now you can drink your wine and have a secure place to hold it in your RV. Our wine glass holder pairs perfectly with your Thomas Payne Power Port for Seismic Series furniture.

- Securely holds stemmed wine glasses
- Plugs directly into Thomas Payne Power Port
- Allows you to use stemmed wine glasses on the road



THREE-SPEED PORTABLE FAN

Feel the breeze with this rechargeable, handheld portable fan that fits right into your Thomas Payne Power Port for Seismic Series furniture.

- Plugs directly into your Thomas Payne Power Port
- Rechargeable battery
- Adjustable for optimal positioning
- Three, one-touch fan modes
- 2-hour battery life



LED READING LIGHT

Upgrade your Thomas Payne Seismic Series furniture seating with this rechargeable, LED light.

- Equipped with LED lights
- Plugs directly into your Thomas Payne Power Port
- Rechargeable battery
- Easily adjusts to meet your lighting needs
- Lightweight and easy to set up or store
- Three, one-touch lighting modes
- 2-hour battery life



360 SWIVEL DESK

Now you can create a personal desk space inside your RV. This easy-to-install, removeable desk attaches to your Thomas Payne Seismic Series furniture to give you an extra place to set belongings.

- Attaches to your Power Port
- Lightweight, easy to install and dismantle
- Perfect place to eat, read, use your computer, or store belongings
- Swivel-adjustment for optimal positioning
- Easy to clean with a non-abrasive cleaning solution



WIRELESS PHONE CHARGER

This wireless phone charger and cradle is the perfect addition to your RV's Thomas Payne Seismic Series furniture.

- Wirelessly charges your smartphone*
- Flexible, adjustable neck for positioning
- Cradle adjusts to 7.5 inches to fit various phone sizes
- Includes alternative USB connection port to charge phone with USB cord (not included)

**Supports Qi-enabled devices*

NEW THOMAS PAYNE FABRIC CLEANER COMING SOON

Introducing the professional vinyl, leather and upholstery cleaner from Thomas Payne

- Removes the toughest spots on vinyl, leather and carpet surfaces
- Perfect for clear vinyl, indoor / outdoor fabric and canvas
- Leaves a clean, soft, non-greasy shine
- Safe, non-caustic, non-butyl and biodegradable
- Spray on, wipe off application

THOMAS PAYNE® COLLECTION FURNITURE DEALER PROFIT PROGRAM NEW

INTERIOR

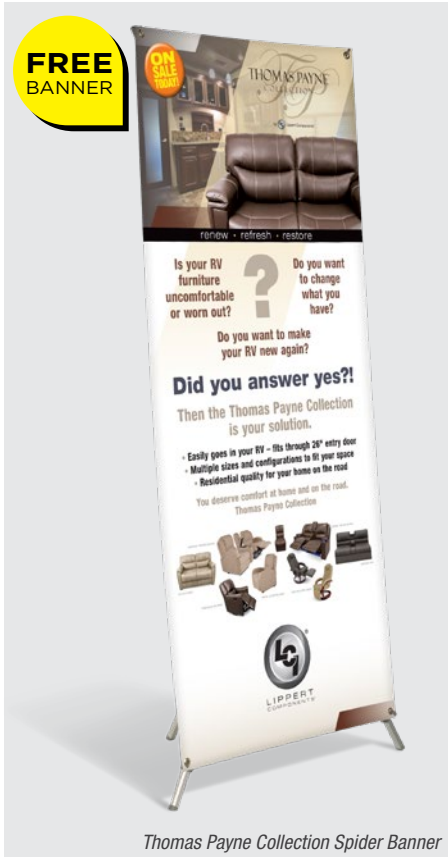

FREE DISPLAY OPPORTUNITY

Purchase the Gold or Silver Level Thomas Payne Collection Furniture Dealer Profit Program and receive the marketing materials as outlined in the Gold and Silver programs.

Limited time offer - while supplies last. Limit one display per dealership. Minimum order to qualify. Free qualifying display is to be kept clean, visible to consumers in retail store and showcase only Lippert product. Displays subject to change.

Series	Description	Millbrae	Grummond	Altoona	Norlina	Silver	Gold	Dealer
Heritage	Destination Trifold Sofa	2020126716	2020126718	2020134887	2020126719			
Heritage	Destination Trifold Sofa	2020127590	2020128147	2020134966	2020128771		1	
Heritage	Destination Trifold Sofa	2020128894	2020128895	2020134969	2020128896			
Heritage	Jackknife Sofa	2020129834	2020129835	2020135018	2020129836			
Heritage	Jackknife Sofa	2020129837	2020129838	2020135025	2020129839			
Heritage	Jackknife Sofa	2020129840	2020129841	2020135030	2020129842			
Heritage	Universal Leg Kit			364582				
Heritage	Right Hand Recliner	2020129262	2020129285	2020134970	2020129304		1	
Heritage	Left Hand Recliner	2020129263	2020129286	2020134971	2020129306		1	
Heritage	Center Console	2020129264	2020129291	2020134972	2020129307		1	
Heritage	Armless Recliner	2020129265	2020129293	2020134973	2020129308		1	
Seismic	Right hand recliner	2020129316	2020129328	2020134974	2020129336	1	1	
Seismic	Left hand recliner	2020129321	2020129329	2020134975	2020129337	1	1	
Seismic	Center Console	2020129322	2020129330	2020134976	2020129339	1	1	
Heritage	Swivel Glider Recliner	2020129853	2020129855	2020135001	2020129856		1	
Heritage	Swivel Pushback Recliner	2020129869	2020129870	2020135002	2020129886	1	1	
Heritage	Swivel Euro Recliner Chair	2020129900	2020129901	2020135004	2020129902	1	1	
Seismic	Reading Light for Power Plug			2020129993		2	2	
Seismic	Tray Table for Power Plug			2020129994		2	2	
Seismic	Cell Phone for Power Plug			2020129995		2	2	
Seismic	Wine Glass Holder for Power Plug			2020129996		2	2	
Seismic	Fan for for Power Plug			2020129997		2	2	
Both	Arm Clamp Tray for Power Plug			2020129999		2	2	
	Thomas Payne Showroom Display			2020221354			FREE	
	Thomas Payne Spider Banner			711084		FREE	FREE	
	Thomas Payne Fabric sample Board			405203		FREE	FREE	
	Thomas Payne Sales Brochures			2020221355		FREE	FREE	

NEW

THOMAS PAYNE® PREMIUM MATTRESS DEALER PROFIT PROGRAM



FREE IN-LINE DISPLAY OPPORTUNITY

Purchase the Thomas Payne Premium Mattress profit program and receive the in-line display for FREE!

Limited time offer - while supplies last. Limit one display per dealership. Minimum order to qualify. Free qualifying display is to be kept clean, visible to consumers in retail store and showcase only Lippert product. Displays subject to change.

THE COOL, COMFORTABLE SLEEPING SOLUTION

Don't let your customers spend another night only dreaming of better sleep, upgrade them with a Thomas Payne Mattress today!

FEATURES

- Perfect for RVs or residential sleeping spaces
- Dual foam layers
- Smart temperature, moisture-wicking materials
- Top layer of 1", 2.2 lb. memory foam infused with charcoal and cooling gel
- Eco Flex, fiberglass-free mattress barrier
- 9", 1.56 lb. foam support layer
- Fits on any flat, secure surface like box springs or slated bed
- Six-month compression guarantee
- Ships compressed and double-bagged in a box for added protection and easy handling

ALL NEW THOMAS PAYNE MATTRESS ACCESSORIES

- Microfiber sheet sets
- Mattress protectors
- Adjustable sheets sets
- All available in standard residential and RV sizes

THOMAS PAYNE PREMIUM MATTRESS DEALER PROFIT PROGRAM

Part #	Description	Thickness/size	Qty.	Dealer	Program
2020000135	Thomas Payne RV Mattress - Short Queen	10" / 60" x 75"	1		
2020000136	Thomas Payne RV Mattress - Queen	10" / 60" x 80"	1		
2020000137	Thomas Payne RV Mattress - Narrow King	10" / 72" x 80"			
2020000138	Thomas Payne RV Mattress - King	10" / 76" x 80"			
2020218489	Thomas Payne Microfiber Sheet Set, Short Queen	10" / 60" x 75"	2		
2020218491	Thomas Payne Microfiber Sheet Set, Queen	10" / 60" x 80"	2		
2020218492	Thomas Payne Microfiber Sheet Set, Narrow King	10" / 72" x 80"	2		
2020218493	Thomas Payne Microfiber Sheet Set, King	10" / 76" x 80"	2		
2020218501	Thomas Payne Mattress Protector, Short Queen	10" / 60" x 75"	2		
2020218503	Thomas Payne Mattress Protector, Queen	10" / 60" x 80"	2		
2020218504	Thomas Payne Mattress Protector, Narrow King	10" / 72" x 80"	2		
2020218505	Thomas Payne Mattress Protector, King	10" / 76" x 80"	2		
2020218506	Thomas Payne Adjustable Microfiber Sheet set, bunks	30-34" x 70-75"	2		
2020218507	Thomas Payne Adjustable Microfiber Sheet Set, twin and 3/4	35-48" x 70-75"	2		
2020218508	Thomas Payne Adjustable Microfiber Sheet set, full/queen	49-60" x 75-80"	2		
2020218510	Thomas Payne Adjustable Microfiber Sheet set, king	61-76" x 75-80"	2		
2020136331	Thomas Payne Mattress Profit Program In Line Display		1	FREE	FREE

INTERIOR

THOMAS PAYNE® UNIVERSAL TEDDY BEAR BUNK COVERS DEALER PROFIT PROGRAM

INTERIOR



Teddy Bear Bunk Covers

SOFT AND INVITING

The Teddy Bear Bunk Mattress Cover provides a soft and inviting sleep surface while protecting RV mattresses from dirt and debris. The soft and comforting sleep surface is perfect for children.

Available in multiple sizes and two color options, the Teddy Bear Bunk Mattress Cover easily zips onto your existing RV bunk mattress, providing a plush, inviting sleep surface perfect for lounging and sleeping.



**FREE
WALLPAPER**

FREE WALLPAPER DISPLAY OPPORTUNITY

Purchase 12 Teddy Bear Bunk Covers and receive the 4' planogram wallpaper for FREE!

Limited time offer - while supplies last. Limit one display per dealership. Minimum order to qualify. Free qualifying display is to be kept clean, visible to consumers in retail store and showcase only Lippert product. Displays subject to change.

Teddy Bear Bunk Cover Display

THOMAS PAYNE TEDDY BEAR COVERS AND MATTS DEALER PROFIT PROGRAM

Part #	Description	Size	Thickness	Qty.	Dealer Price	Program
679278	Thomas Payne Universal Teddy Bear Bunk Cover, Chocolate	28" x 74"	3"			
679279	Thomas Payne Universal Teddy Bear Bunk Cover, Tan	28" x 74"	3"			
679285	Thomas Payne Universal Teddy Bear Bunk Cover, Chocolate	32" x 74"	3"	3		
679294	Thomas Payne Universal Teddy Bear Bunk Cover, Tan	32" x 74"	3"	3		
679280	Thomas Payne Universal Teddy Bear Bunk Cover, Chocolate	50" x 74"	3"			
679281	Thomas Payne Universal Teddy Bear Bunk Cover, Tan	50" x 74"	3"			
679284	Thomas Payne Universal Teddy Bear Bunk Cover, Chocolate	28" x 74"	4"			
679282	Thomas Payne Universal Teddy Bear Bunk Cover, Tan	28" x 74"	4"			
679299	Thomas Payne Universal Teddy Bear Bunk Cover, Chocolate	32" x 74"	4"	3		
679300	Thomas Payne Universal Teddy Bear Bunk Cover, Tan	32" x 74"	4"	3		
679301	Thomas Payne Universal Teddy Bear Bunk Cover, Chocolate	50" x 74"	4"			
679302	Thomas Payne Universal Teddy Bear Bunk Cover, Tan	50" x 74"	4"			
355980	Thomas Payne Universal Bunk Matt, Chocolate	28" x 74"	2.5"			
358665	Thomas Payne Universal Bunk Matt, Tan	28" x 74"	2.5"			
359982	Thomas Payne Universal Bunk Matt, Chocolate	32" x 74"	2.5"			
360909	Thomas Payne Universal Bunk Matt, Tan	32" x 74"	2.5"			
380762	Thomas Payne Universal Bunk Matt, Chocolate	50" x 74"	2.5"			
380763	Thomas Payne Universal Bunk Matt, Tan	50" x 74"	2.5"			
345038	Thomas Payne Universal Bunk Matt, Chocolate	28" x 74"	3"			
375995	Thomas Payne Universal Bunk Matt, Tan	28" x 74"	3"			
345041	Thomas Payne Universal Bunk Matt, Chocolate	32" x 74"	3"			
374921	Thomas Payne Universal Bunk Matt, Tan	32" x 74"	3"			
345046	Thomas Payne Universal Bunk Matt, Chocolate	50" x 74"	3"			
380764	Thomas Payne Universal Bunk Matt, Tan	50" x 74"	3"			
353041	Thomas Payne Universal Bunk Matt, Chocolate	28" x 74"	4"			
380765	Thomas Payne Universal Bunk Matt, Tan	28" x 74"	4"			
380767	Thomas Payne Universal Bunk Matt, Chocolate	32" x 74"	4"			
380766	Thomas Payne Universal Bunk Matt, Tan	32" x 74"	4"			
380769	Thomas Payne Universal Bunk Matt, Chocolate	50" x 74"	4"			
380768	Thomas Payne Universal Bunk Matt, Tan	50" x 74"	4"			
711092	Teddy Bear Profit Program Planogram Wallpaper-4'			1	FREE	FREE



Floë Drain Down System



Floë Packaging

INTERIOR

MEET FLOË

An industry-first, integrated water drain-down system that lets you flush out your RV's water system, anywhere, anytime. Using compressed air pressure, Floë clears your water lines — cleaning out the stagnant water that could cause harmful bacteria growth. It's an easy, convenient way to clean your RV, boat, or any mobile vehicle's freshwater system.

Floë offers you the peace of mind and ease of draining your lines whenever and as often as you'd like. In no time, you can get back to enjoying drinkable water that's ready for your family, friends and pets to use. Or you can prep your RV, trailer, vacation home or boat for winterization — preventing frost damage to your pipes and freshwater tank.

HERE'S HOW FLOË WORKS

First, run your water until your tank is empty. Once you've finished, turn on Floë, and open each faucet, one at a time, until every water line is drained. Repeat this process if needed to completely empty each water line.

And just like that, you're done. In as little as two minutes, your entire water system can be flushed out, and you can be ready for your next big adventure or to store your RV or boat for the winter months.

WHY FLOË

- Flushes stale, stagnant water out of pipes
- Helps prevent frost damage during winter months
- Easy installation, no dismantling necessary
- Drains water system in minutes
- NSF 61 and UL verified and approved
- Backed by a reliable one-year warranty

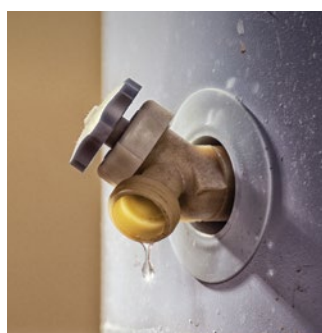

STEP 1

Manually drain water heater and close dump valve and outlets after to seal water system

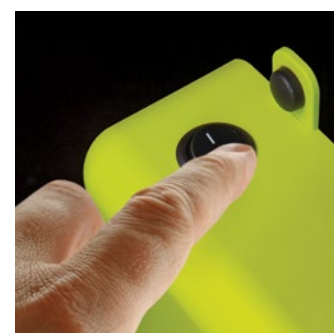

STEP 2

Switch Floë on to compress air into water system

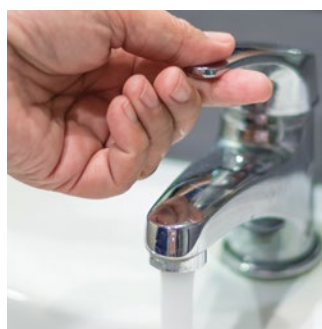

STEP 3

Open and drain each outlet one by one

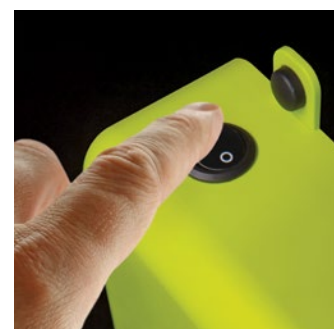

STEP 4

Switch Floë off and leave all water outlets open

FLOË DRAIN DOWN SYSTEM DEALER PROFIT PROGRAM

LPart #	Description	Qty.	Dealer Price	Program
809127	Floë 12V Integrated Drain Down System	3		
809128	Floë 115V Integrated Drain Down System	1		

FLOW MAX™ WATER PUMP DEALER PROFIT PROGRAM

INTERIOR



Accessory parts included!



Flow Max Water Pump

FRESH WATER WHEN YOU NEED IT

Fresh water when you want it and when you need it. The Flow Max water pump delivers a steady flow of water to your RV. Flow Max offers superior performance and is available in both 12V and 115V.

FEATURES

- Self-priming
- Quiet operation
- 2-year limited warranty
- 12V VDC, 9.5 max amps
- Available in 12V and 115V
- Certified to NSF/ANSI 372 by CSA
- Heavy-duty, corrosion resistant motor
- Pump can run dry without incurring damage
- Average leading pressure of 50 PSI with an average GPM of 3.0

Average Gallons Per Minute

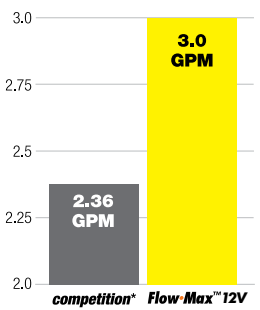

Average Leading Pressure

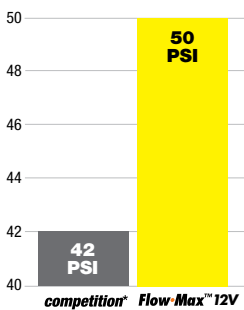

Freeze/Thaw 2-Hour Cycle

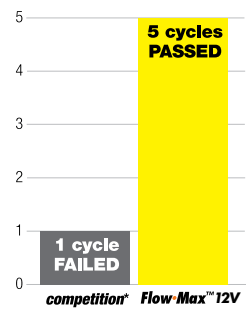

* Compared to SHURflo® Revolution™ 4008 Fresh Water Pump. Independently tested by Progressive Engineering, Inc, Goshen, Indiana USA.

FREE WALLPAPER



Flow Max Water Pump Wallpaper

FREE WALLPAPER DISPLAY OPPORTUNITY

Purchase a qualifying combination of Flow Max Pumps and receive the 2' planogram wallpaper for FREE!

Limited time offer - while supplies last. Limit one display per dealership. Minimum order to qualify. Free qualifying display is to be kept clean, visible to consumers in retail store and showcase only Lippert product. Displays subject to change.

FLOW MAX WATER PUMP DEALER PROFIT PROGRAM

Part #	Description	Qty.	Dealer Price	Program
689052	Water Pump 12V 3.0 w/ Strainer and Connectors	12		
689054	Water Pump 115V 3.0 w/ Strainer and Connectors			
689059	Replacement Screen, Filter and Connectors - Universal	2		
768201	Flow Max Water Pump Profit Program Wallpaper - 2'	1		

FLOW MAX™ GALLEY FAUCET DEALER PROFIT PROGRAM

DESIGNED WITH MODERN IN MIND

Add a splash of modern to your kitchen or bath with a Stainless Steel Faucet by Lippert. Available in a variety of spout constructions like coiled spring and high-arched, we're challenging how the world feels about faucets. Constructed with quality stainless steel, these sleek faucets are designed for maximum lifespan and durability.

FEATURES

- 304 Grade stainless steel construction
- Pull-down faucet head with toggle
- Toggle for stream or spray options
- Easy DIY installation
- Pairs well with stainless steel sink sets by Lippert



FREE FLOW MAX FAUCET DISPLAY OPPORTUNITY

Purchase a qualifying combination of Flow Max Galley Faucets and receive the display for FREE!

Limited time offer - while supplies last. Limit one display per dealership. Minimum order to qualify. Free qualifying display is to be kept clean, visible to consumers in retail store and showcase only Lippert product. Displays subject to change.

FLOW MAX GALLEY FAUCET DEALER PROFIT PROGRAM

Part #	Description	Qty.	Dealer Price	Program
719324	Stainless Steel Curved Gooseneck Faucet	1		
719325	Stainless Steel Square Gooseneck Faucet	1		
719326	Stainless Steel Pull Down Sprayer Faucet	1		
719333	Stainless Steel Bullet Pulldown Faucet	2		
719323	Stainless Steel Spring Spout Faucet	1		
768205	Flow Max Galley Faucet Profit Program Display	1	FREE	FREE

RV AIR FRESHENER DEALER PROFIT PROGRAM

INTERIOR



Air Fresheners

ADD SOME FRAGRANCE TO YOUR JOURNEY.

Hit the open road with a fresh, clean scent from Lippert. Choose from Vanilla Mist, Home Sweet Home, or Woody Sage and Salt — and give your RV a fragrance upgrade today! Our new line of air fresheners are a fun, aromatic addition to any vehicle, and will help keep your trip smelling fresh mile after mile.

DISCOVER FRESHNESS

Lippert air fresheners are available in two fun, RV-themed designs and three fresh fragrances.

- Home Sweet Home
- Vanilla Mist
- Woody Sage and Salt

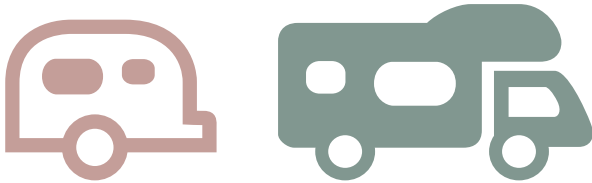

Air Fresheners Display

FREE COUNTER TOP DISPLAY OPPORTUNITY

Purchase the RV Air Freshener Dealer Profit Program and receive the counter top display for FREE!

Limited time offer - while supplies last. Limit one display per dealership. Minimum order to qualify. Free qualifying display is to be kept clean, visible to consumers in retail store and showcase only Lippert product. Displays subject to change.

AIR FRESHENER DEALER PROFIT PROGRAM

Part #	Description	Qty.	Dealer Price	Program
808116	Home Sweet Home RV Air Freshener - Motorhome	18		
808117	Home Sweet Home RV Air Freshener - Travel Trailer	18		
808118	Woody Sage and Sea Salt RV Air Freshener - Motorhome	18		
808119	Woody Sage and Sea Salt RV Air Freshener - Travel Trailer	18		
808120	Vanilla Mist RV Air Freshener - Motorhome	18		
808121	Vanilla Mist RV Air Freshener - Travel Trailer	18		
811736	RV Air Freshener Profit Program Counter Display Box	1	FREE	FREE

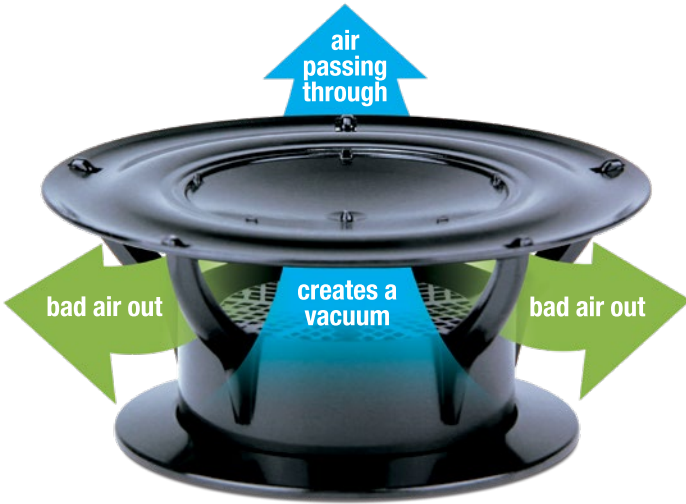

STOP THE STINK

The 360 Siphon RV holding tank vent cap removes odors from the source — the holding tanks — and exhausts them out the roof vent before they have a chance to invade the RV living space. By design, the patented 360 Siphon can only create an updraft, expelling odors and fostering an oxygen-rich environment to speed up waste breakdown.

FEATURES

- Prevents odors and gases from invading the RV living space
- Speeds up waste breakdown, eliminating the need for chemicals
- Sophisticated, patented design with no moving parts
- Works in any wind condition
- Made in America of strong polycarbonate
- Available in black or white
- Easy installation and universal fit
- Built-in bug screen
- No maintenance



FREE COUNTER TOP DISPLAY OPPORTUNITY!

Purchase 12 360 Siphon products and receive the counter top display for FREE!

Limited time offer - while supplies last. Limit one display per dealership. Minimum order to qualify. Free qualifying display is to be kept clean, visible to consumers in retail store and showcase only Lippert product. Displays subject to change.

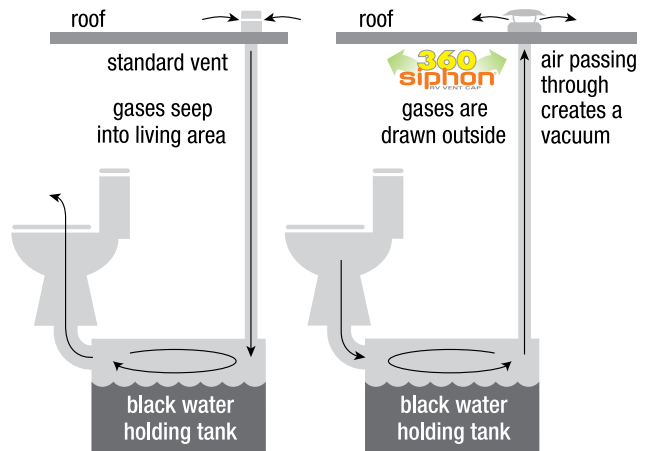

360 SIPHON RV VENT CAP DEALER PROFIT PROGRAM

Part #	Description	Qty.	Dealer Price	Program
389380	360 Siphon Roof Vent (Gen II Black)	6		
389381	360 Siphon Roof Vent (Gen II White)	6		
768209	360 Siphon Profit Program Counter Display Box	1	FREE	FREE

Solera®

BY LIPPERT

SOLERA AWNINGS



YOUR UNIVERSAL CHOICE FOR ALL THINGS SUN AND SHADE

We've revamped our entire awning collection to make your life simpler. The Solera Universal line of awnings and accessories makes it simple and easy to replace your awning. Featuring universal application, Solera Universal products work with competitor awning brands as well as many of Solera's most popular awnings and accessories. With a wide variety of innovative Solera awning models and accessories to choose from, Solera Universal saves time, money and stress.



POWER UP

Power Up your mobile lifestyle with the Solera Smart Arm® 12V Power or 18V Battery Operated awnings. Save yourself the stress and added time of manually setting up your awning!



UPGRADE

Upgrade your current manual or power awning with Solera Universal Hardware! Our hybrid and power awnings set up automatically for camping as they extend.



FIX IT

Tired of your old manual or power awning? With our newly designed Solera Universal Hardware, replacing your broken or worn out hardware has never been easier, no matter what awning brand you have.

Solera Universal components fit any of these brands:

Dometic* (A&E)

Universal Hardware fits the following Dometic® 8' extension awnings models: 8500, 9000, 9100, Sunchaser and Weather Pro

Solera®
BY LIPPERT

Universal Hardware fits the following Solera 8' extension awnings models: 18V Power, Smart Arm® 12V, Hybrid and Classic Manual.

Carefree™**

Universal Hardware fits the following Carefree™ 8' extension awnings models: Spirit, Fiesta, Simplicity Traveler and Eclipse

*Dometic® is a registered mark and logo owned by Dometic Sweden and A&E is a mark used by Dometic Group. **Carefree™ and the Carefree logo are a mark and logo used by Carefree of Colorado, member of The Scott Fetzer Co.

NEW SOLERA PROFIT PROGRAM DISPLAY DEAL

The Solera Universal brand has numerous successful dealer profit programs under its belt. The Universal Hardware program supplies you with all the latest hardware to go Universal. Solera Slide Topper's are a big up-sell to your customers, giving them protection from the elements. The Universal Fabric Replacement program has all your awning replacement fabric needs covered, from slide toppers to awnings. The Universal Shades and Rooms program lets RVers expand their outdoor living space, create shade and keep the bugs out. Solera has you covered.

PURCHASE ALL 4 SOLERA DEALER PROFIT PROGRAMS



Universal Hardware



Universal Shades and Rooms



Universal Fabric Replacement



Universal Slide Toppers

GET THE SOLERA UNIVERSAL DEALER MODULAR DISPLAY



SOLERA® UNIVERSAL SLIDE TOPPERS DEALER PROFIT PROGRAM



PROTECT YOUR INVESTMENT

Give your slide-outs extra protection from debris and water infiltration with Solera Universal Slide Toppers. These attractive and economical slide-out awnings automatically retract and extend with your slide-out and prevent leaves, bird droppings, branches and more from damaging slide-out seals.

FEATURES

- Attractive and economical protection for your slide-out
- Heated wedge welding fuses vinyl together for strong, leak-resistant seams
- Blocks leaves, bird droppings, branches and debris
- Automatically retracts and extends with slide-out
- Fits slides ranging from 66" to 192" long and extending up to 48"
- Comes complete with awning rail and all mounting brackets
- Premium 13.5 oz fabric

PREPPING OVER 200,000+ OEM SLIDE-OUTS IN 2019-2020... AND THAT'S JUST THE START

If you're not in the slide topper business, the new Solera Slide Topper Prep Program provides a fast and easy solution to Slide Topper Installation. Now is the time to get into the slide topper business and Lippert is making it easier than ever.



FREE BANNER



Solera Slide Topper Spider Banner

FREE BANNER DISPLAY OPPORTUNITY

Purchase a qualifying Solera product assortment and receive the FREE spider banner display! As long as quantity of 6 is met, you will qualify for the program.

Limited time offer - while supplies last. Limit one display per dealership. Minimum order to qualify. Free qualifying display is to be kept clean, visible to consumers in retail store and showcase only Lippert product. Displays subject to change.

SOLERA UNIVERSAL SLIDE TOPPER DEALER PROFIT PROGRAM

Part #	Description	Width	Flange Measurement	Qty.	Dealer Price	Program
V000165062	Solera Slide Topper Black/Black	85"	80" - 85"	2		
V000168106	Solera Slide Topper Black/Black	91"	86" - 91"	1		
V000165061	Solera Slide Topper Black/Black	151"	146" - 151"	2		
V000168109	Solera Slide Topper Black/Black	157"	152" - 157"	1		
711096	Solera Universal Slide Topper Spider Banner			1	FREE	FREE

SOLERA® UNIVERSAL HARDWARE DEALER PROFIT PROGRAM



SMART ARM® 12V AWNING

The Solera Smart Arm® 12V Power Awning incorporates several intelligent features sure to enhance everyone's camping experience. Best of all, these new features are all accessible from a weatherproof controller built right into the awning arm itself, making for easy and convenient access without having to go inside the RV to operate the switches.



18V POWER AWNING

Upgrading to a power awning has never been easier! An industry first, the Solera 18V Power Pack features a unique, rechargeable battery that fits right inside your Solera Power Awning arm and comes with everything you need to connect to the motor wire.



Smart Arm Proximity/Security Sensor



Smart Arm Wind Sensor



Solera Universal Spider Banner

FREE BANNER DISPLAY OPPORTUNITY

Purchase 3 sets of Solera Universal Hardware plus the Smart Arm Accessories and get the Spider Banner display FREE! As long as quantity is met, you will qualify for the program.

Limited time offer - while supplies last. Limit one display per dealership. Minimum order to qualify. Free qualifying display is to be kept clean, visible to consumers in retail store and showcase only Lippert product. Displays subject to change.

SOLERA AWNINGS

SOLERA UNIVERSAL HARDWARE DEALER PROFIT PROGRAM

Part #	Description	Arm Color	Arm Size	Qty.	Dealer Price	Program
434730	18V Tall Arm 69" - Universal	White	69"			
434729	18V Tall Arm 69" - Universal	Black	69"	1		
434724 / 434723	12V Tall Arm 69" - Universal	White/Black	69"	1		
759404 / 759516	12V Smart Arm 63" - Universal	White/Black	69"	1		
759405/759517	12V Smart Arm 69" - Universal	White/Black	63"			
715123	Smart Arm Wind Sensor Kit			1		
715124	Smart Arm Infrared Security Sensor Kit			1		
711095	Solera Universal Hardware Spider Banner			1	FREE	FREE

SOLERA® UNIVERSAL REPLACEMENT FABRIC DEALER PROFIT PROGRAM

SOLERA AWNINGS



Solera Slide Topper Replacement Fabric Box

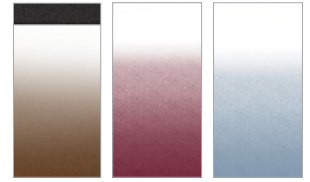

UNIVERSAL SLIDE TOPPER REPLACEMENT FABRIC

Stop wasting time by custom ordering slide topper fabric every time you get an order, and save room for more inventory! Our Slide Topper Replacement Fabric boxes are compact yet durable and are a universal fit, meaning no more guesswork when it comes to replacing slide topper fabric. Works with: Solera, Dometic®* and Carefree™**

FEATURES

- Our slide topper fabric is universal, fitting all three major slide topper brands
- Premium, 13.5 oz fabric - not the competition's 10 oz fabric
- Best of all, we offer a cut-to-fit option in a tissue-style box, complete with easy-to-use roller. Just extend out the amount of fabric you need and cut
- Roll stays in place with plastic reel (competitors do not offer this)

		Competitor A	Competitor B
Fits slide-outs ranging from 66" to 192" in length	✓	✓	✗
(1) Part number that comes complete with awning rail, topper and all mounting brackets	✓	✗	✗
Multiple colors and options available	✓	✗	✗
Premium 13.5 oz vinyl fabric	✓	✗	✗
No anti-billowing device needed	✓	✗	✗
Heated wedge welding fuses vinyl together for strong, leak-resistant seams	✓	✗	✗
Accommodates slide-outs up to 48" wide	✓	✗ 42"	✗ 42"
Flexible placement; can be installed up to five inches above slide box trim	✓	✗	✗

UNIVERSAL PATIO REPLACEMENT FABRICS

Solera's premium awning replacement fabric is head and shoulders above other brands with super heavy-duty materials, a 5-year warranty and heat-welded seams. Our canopy fabric also features an integrated light track so you can easily add the Solera Fabric Light Kit and enjoy LED lighting at the campsite. Best of all, get same day shipping if ordered by 12:00 EST.

FREE BANNER

FREE BANNER DISPLAY OPPORTUNITY!

Purchase a qualifying Solera product assortment and receive the FREE spider banner display! As long as quantity of 4 is met, you will qualify for the program.

Limited time offer - while supplies last. Limit one display per dealership. Minimum order to qualify. Free qualifying display is to be kept clean, visible to consumers in retail store and showcase only Lippert product. Displays subject to change.

*Dometic® is a registered mark and logo owned by Dometic Sweden and A&E is a mark used by Dometic Group.

**Carefree™ and the Carefree logo are a mark and logo used by Carefree of Colorado, member of The Scott Fetzer Co.

SOLERA UNIVERSAL CUT-TO-FIT DEALER PROFIT PROGRAM

Part #	Description	Length	Qty.	Dealer Price	Program
432253	Universal Topper Replacement Fabric - Black	50'	2		
432252	Universal Topper Replacement Fabric - White	50'	2		
2020221356	Solera Universal Replacement Fabric Spider Banner		1	FREE	FREE

SOLERA® UNIVERSAL SHADES AND ROOMS DEALER PROFIT PROGRAM



FRONT AND SIDE SHADES

Perfect for all awnings, the one-piece, black Solera Front Shade is easy to slide into your awning roller tube whenever you need a little extra shade, privacy or wind block. Solera Front Shade panels are available in 8', 10', 13', 15', 17' & 19' widths, each with a 6' screen height. The Front Shade kit includes storage bag, spikes and tie downs.



SOLERA SUPER SHADE®

Many of the larger RVs today have patio awnings that are too high to reach when they are fully extended, and that's why we created the Solera Super Shade! The two-piece, black Solera Super Shade® features a standard 6' shade height that easily zips into a Solera Super Shade extension and can be permanently installed into your awning's roller tube.



SOLERA FAMILY ROOM®

Turn the space under your awning into an enclosed outdoor patio with the Solera Family Room kit. Add up to 160 square feet of enclosed space so you can enjoy meals minus pesky insects. Or roll down the all-weather panels and use as a cozy sleeping area for kids. 10-21' rooms available.



SCREEN ROOM

Keep the bugs out and enjoy the breeze with the Solera Screen Room. Its neutral tan material helps to block out extra heat, making the Solera Screen Room perfect for outdoor dining, board games and social gatherings on hot summer days. 10-21' rooms available.

SOLERA AWNINGS

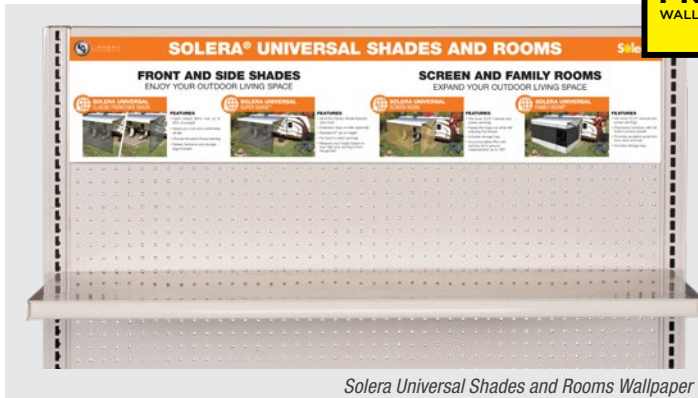

FREE WALLPAPER

FREE WALLPAPER DISPLAY OPPORTUNITY

Purchase a qualifying order of Solera Shades and Rooms and receive the 4' Planogram Wallpaper for FREE! As long as quantity of 5 is met, you will qualify for the program.

Limited time offer - while supplies last. Limit one display per dealership. Minimum order to qualify. Free qualifying display is to be kept clean, visible to consumers in retail store and showcase only Lippert product. Displays subject to change.



Solera Universal Shades and Rooms Packaging

SOLERA UNIVERSAL SHADES AND ROOMS DEALER PROFIT PROGRAM

Part #	Description	Qty.	Dealer Price	Program
3833980615	Solera Classic Shade - 15' Wide	1		
37978608	Solera Side Shade panel - 8' Drop	1		
3797820815	Solera Super Shade - 15' Wide 8' Drop	1		
3797820819	Solera Super Shade 19' Wide 8' Drop	1		
362221	Solera Screen Room 18' Wide	1		
711093	Solera Universal Shades and Rooms Wallpaper - 4'	1	FREE	FREE



STABLE. STURDY. SOLID.

The Solid Step®'s innovative design permits the step to operate through a wide range of ride heights. The design also ensures that the steps stay parallel to the ground, reducing the potential for slipping or falling during use. The Solid Step design permits the step to stow inside of the entry door, keeping road debris and corrosion away while simultaneously permitting continuous skirt metal on the RV, enhancing the aesthetics of the coach.

- No bounce, manual steel step with aluminum treads
- Threshold panel behind the top step to protect the trailer sidewall from damage
- Recessed feet prevent trip hazard and maximize clearance for camping spot
- 13" XL top step depth for easy entry and exit
- Aluminum treads that hold up against the elements
- Mounting fasteners provided for either wood or laminate floor applications
- Double, triple and quad variations available
- 400-lb. capacity
- Includes floor backing plate

SOLID STEP® GEN. 3 ENTRY STEP & ACCESSORIES DEALER PROFIT PROGRAM



LIFT ASSIST UPGRADE KIT

Make raising and lowering your Solid Step easier with the addition of Lift Assist, allowing even our largest quad step to be lifted with just one finger!

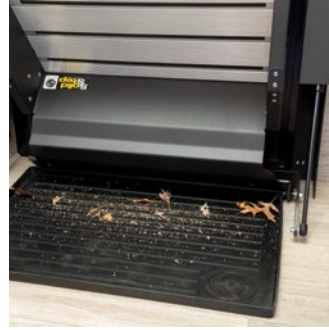

ALL-WEATHER FLOOR TRAY

Designed to collect debris from stored Solid Step treads, the versatile All-Weather Floor Tray works wonders as a catch-all for dirt and debris.

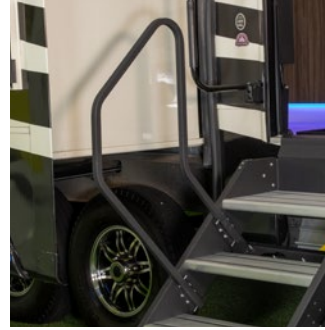

ENTRY ASSIST HANDRAIL

The perfect accessory for any Generation 3 Triple or Quad Solid Step, the Entry Assist Handrail provides added support when entering and exiting the RV.

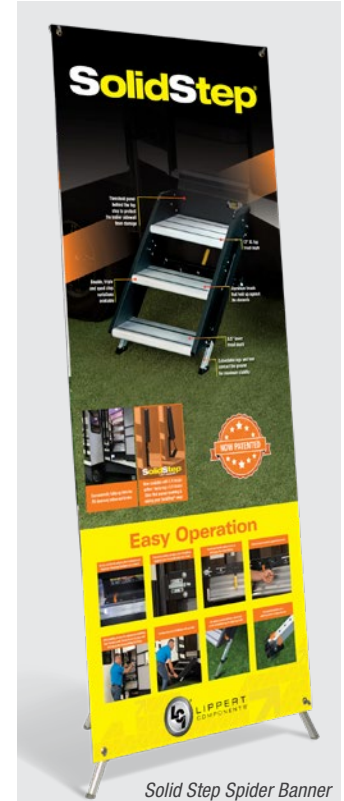

Solid Step Spider Banner

FREE SPIDER BANNER DISPLAY OPPORTUNITY

Purchase the Solid Step Dealer Profit Program and receive the Solid Step Spider Banner for free!

Limited time offer - while supplies last. Limit one display per dealership. Minimum order to qualify. Free qualifying display is to be kept clean, visible to consumers in retail store and showcase only Lippert product. Displays subject to change.



Solid Step and Entry Door Upgrade Showroom Display

FREE DISPLAY

FREE SHOWROOM DISPLAY OPPORTUNITY

Purchase the Entry Door and Solid Step Dealer Profit Programs and receive the Showroom Display for free!

Limited time offer - while supplies last. Limit one display per dealership. Minimum order to qualify. Free qualifying display is to be kept clean, visible to consumers in retail store and showcase only Lippert product. Displays subject to change.

SOLID STEP GEN. 3 ENTRY STEP & ACCESSORIES DEALER PROFIT PROGRAM

Part #	Description	Frame Width*	Qty.	Dealer Price	Program
733931	26" Premium Double Solid Step	26" - 29.9"	1		
733932	30" Premium Double Solid Step	30" - 36"			
791572	26" Premium Triple Solid Step	26" - 29.9"			
791573	30" Premium Triple Solid Step	30" - 36"	1		
791574	26" Premium Quad Solid Step	26" - 29.9"			
791575	30" Premium Quad Solid Step	30" - 36"	1		
733937	Narrow Lift Assist Kit for Solid Step	25"-28"	1		
733939	Wide Lift Assist Kit for Solid Step	29"-32"	1		
799640	Solid Step Handrail for Triple and Quad Gen 3 Steps		3		
801380	Solid Step All-Weather Floor Tray		10		
702177	Solid Step Dealer Profit Program Spider Banner		1	FREE	FREE
2020221360	Solid Step and Entry Door Upgrade Showroom Display		1	FREE	FREE

*Frame Width - Measure frame to frame at bottom of door or threshold length. Lift Assist cannot be installed on frame widths above 32"



SCREEN SHOT® AUTOMATIC SCREEN DOOR CLOSER FOR RVs

The majority of RV screen doors do not come with a retracting hinge, allowing the screen door to hang wide open if it is not shut properly. This invites unwanted pests inside your living space and detracts from the RV's heating and cooling.

FEATURES

- Patent pending design automatically closes the screen door when left opened
- Keeps unwanted pests out of your living space
- Easy DIY installation
- All required fasteners included



BRING YOUR PETS ALONG WITH SCREEN DEFENDER

Protect your pet and your RV with the Lippert Screen Defender entry door screen protector. Bring your pet along with you for the adventure without worrying about them getting out of the RV at unwanted times or damaging your Lippert screen door.

FEATURES

- Protects RV screen doors
- Black powder-coated aluminum screen
- Available in sizes to fit 24", 26" 28" and 30" door widths
- Compatible with Lippert's full line of screen doors for travel trailers, 5th wheels, and for motorized doors on motorhomes
- Fits into existing extrusion channels on the RVs screen door



STAY PUT TECHNOLOGY WITH FRICTION HINGE

Upgrade your RV entry door with ease. With the Friction Hinge from Lippert your door stays in the exact position you need it to, and it can handle wind gusts of up to 25 mph — helping to protect your door and your RV from harmful, costly damage. Easy-to-install, this hinge is a win-win on the open road. The Friction Hinge is compatible with all Lippert RV and trailer entry door series.

FEATURE

- Keeps RV entry door open in wind gusts up to 25 mph
- No need for door catches or gas strut
- Helps protect your RV entry door and sidewalls
- No additional hardware required
- Easy installation
- One-year warranty



ENTRY DOOR UPGRADE DEALER PROFIT PROGRAM



BLOCK LIGHT AND HEAT, CREATE SHADE WITH THIN SHADE™

Are you one of the millions of RVers without an entry door shade solution? Prevent sunlight and heat from entering through your RV entry door window and add instant privacy to your home on wheels with the Thin Shade Complete Kit or the Thin Shade Ready Kit for prepped entry doors. The Thin Shade keeps the sun's rays out of your RV living space, helping to regulate the interior temperature and can create instant privacy.



Screenshot Wallpaper

FREE WALLPAPER DISPLAY OPPORTUNITY

Purchase the Screen Shot® Dealer Profit Program and receive the planogram wallpaper for FREE!

Limited time offer - while supplies last. Limit one display per dealership. Minimum order to qualify. Free qualifying display is to be kept clean, visible to consumers in retail store and showcase only Lippert product. Displays subject to change.



Solid Step and Entry Door Upgrade Showroom Display

FREE SHOWROOM DISPLAY OPPORTUNITY

Purchase the Entry Door and Solid Step Dealer Profit Programs and receive the Showroom Display

Limited time offer - while supplies last. Limit one display per dealership. Minimum order to qualify. Free qualifying display is to be kept clean, visible to consumers in retail store and showcase only Lippert product. Displays subject to change.

STEPS, JACKS AND, DOORS

ENTRY DOOR UPGRADE DEALER PROFIT PROGRAM

Part #	Description	Qty.	Dealer Price	Program
730812	Screen Shot Assembly Kit, 24" Door Frame Width	2		
730813	Screen Shot Assembly Kit, 26" Door Frame Width	4		
730814	Screen Shot Assembly Kit, 28" Door Frame Width	2		
730815	Screen Shot Assembly Kit, 30" Door Frame Width	4		
859791	Screen Defender Entry Door Screen Protector - 24"			
859792	Screen Defender Entry Door Screen Protector - 26"	2		
859793	Screen Defender Entry Door Screen Protector - 28"			
859794	Screen Defender Entry Door Screen Protector - 30"	4		
NEW 2020109835	Friction Hinge for LCI Entry Door - White	1		
NEW 2020102629	Friction Hinge for LCI Entry Door - Black	1		
786037	Thin Shade Integrated Window Shade (for Prepped Units)	2		
806621	Thin Shade Complete Entry Door Window Kit	4		
768221	Screen Shot Vertical Profit Program Wallpaper - 2'	1	FREE	FREE
2020221360	Solid Step and Entry Door Upgrade Showroom Display	1	FREE	FREE

JACK-IT® BIKE SOLUTIONS DEALER PROFIT PROGRAM



BUMP-IT™



Bike Base



HITCH-IT



JACK-IT™



BIKEWING™

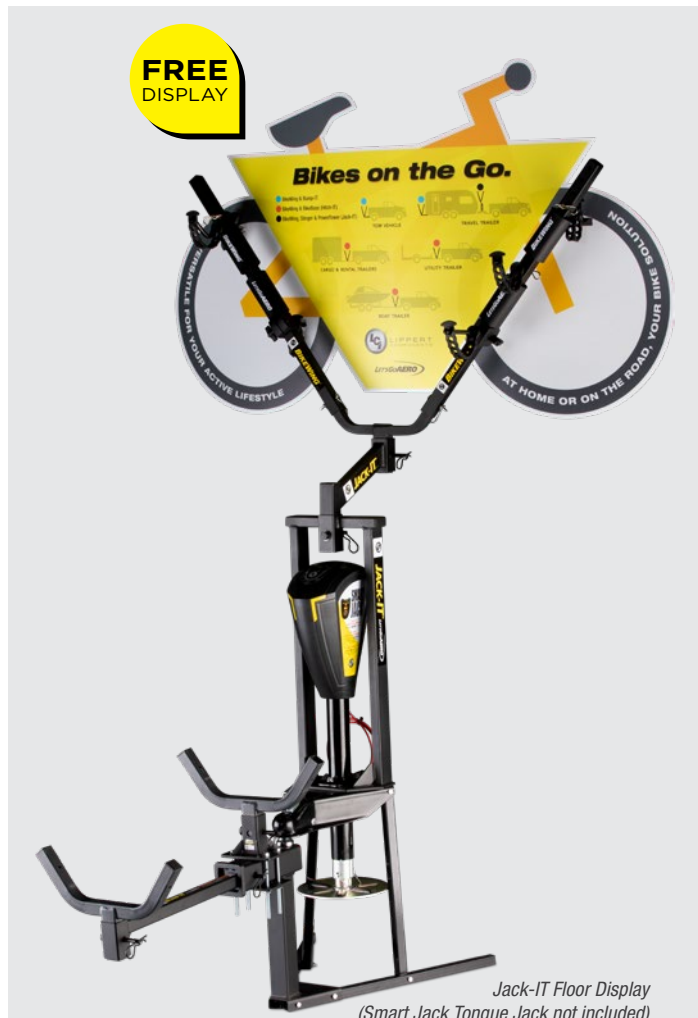

Jack-IT Floor Display
(Smart Jack Tongue Jack not included)

FREE FLOOR DISPLAY OPPORTUNITY

Purchase the Jack-IT Bike Solutions Dealer Profit Program and receive the floor display for FREE!

Limited time offer - while supplies last. Limit one display per dealership. Minimum order to qualify. Free qualifying display is to be kept clean, visible to consumers in retail store and showcase only Lippert product. Displays subject to change.

TAKE YOUR BIKES WHEREVER YOU GO

Give your customers the newest and most innovative products from Lippert. The Let's Go Aero product line gives your customers a variety of bike mounting accessories and options so they can take their bikes wherever they go.

JACK-IT BIKE SOLUTIONS DEALER PROFIT PROGRAM

Part #	Description	Qty.	Dealer Price	Program
429756	Jack-IT Bike Carrier	3		
723359	Bump-IT Receiver Adapter	1		
731137	BikeWing 2-Bike Carrier	1		
731138	Hitch-IT BikeBase/BikeWing Combo	1		
731157	BikeBase A-Frame Adapter	1		
643589	Smart Jack Power Tongue Jack	1		
656439	Jack-IT Bike Solutions Profit Program Floor Display	1	FREE	FREE

STEP AND CHASSIS CARE DEALER PROFIT PROGRAM



Kwik Lube



Chassis Shield



Step Tread

KWIK LUBE SPRAY LUBRICANT

- Great for RVs
- Leveling systems
- Tongue jacks
- Ramp doors
- Slide-outs
- Steps

CHASSIS SHIELD® RUST INHIBITOR

- Creates a thin film to protect RV and trailer chassis from rust and corrosion
- Penetrates and lubricates to free rusted, stuck parts and eliminate squeaks
- Approved for sale in California and Canada
- Displaces water on metal surfaces
- Lubricates moving parts
- Made in the USA

STEP TREAD REPLACEMENT

This product utilizes a luminescent system, which glows in the dark once it has been exposed to natural or artificial light. This product will glow the brightest during the first 30 minutes, after activation has ceased, and will remain visible to the night darkness adapted eye for up to 10 hours.

**FREE
DISPLAY**



Step and Chassis Care
Counter Top Display

FREE COUNTER TOP DISPLAY OPPORTUNITY

Purchase the Step And Chassis Care Dealer Profit Program and receive the counter display box for FREE!

Limited time offer - while supplies last. Limit one display per dealership. Minimum order to qualify. Free qualifying display is to be kept clean, visible to consumers in retail store and showcase only Lippert product. Displays subject to change.

STEP AND CHASSIS CARE DEALER PROFIT PROGRAM

Part #	Description	Qty.	Dealer Price	Program
674806	Chassis Shield - Rust Inhibitor (Per can)	12		
379177	Kwik Lube - Spray Lubricant (12 cans per case)	1		
379600	Kwik Lube Glow in the Dark Step Tread - 6" x 21"	6		
704759	Step and Chassis Care Counter Display Box	1	FREE	FREE

MANUAL STEP DEALER PROFIT PROGRAM

STEPS, JACKS AND DOORS



Alumi-Tread Quad Step



Alumi-Tread Triple Step



24" Manual Radius Triple Step



24" Manual Radius Double Step



TAKE THE BOUNCE OUT OF YOUR STEP

Take the bounce out of your RV or trailer's entrance step with the Solid Stance Step Stabilizer™ kit by Lippert. This is one of the most versatile RV step enhancements on the market that can ground most standard entry steps for improved stability and convenience. And better yet, this kit is compatible with all Lippert double and triple Steel Radius Steps as well as our double and triple Alumi-Tread® Hybrid Aluminum steps, plus a wide-variety of non-Lippert assemblies — making the Solid Stance the easy choice when it comes to upgrading your RV's entry steps.

THE LAST STEP YOU'LL EVER NEED

We offer a complete line of premium manual RV steps including our lightweight hybrid Alumi-Tread Step® featuring strong steel linkage and attractive aluminum treads as well as our Manual Radius Steps featuring a powder-coated finish, compact design and available in single, double, triple and quad configurations.

FREE WALLPAPER



Manual Steps Wallpaper

FREE WALLPAPER DISPLAY OPPORTUNITY

Purchase the Manual Step Dealer Profit Program and receive the 4' planogram wallpaper for FREE!

Limited time offer - while supplies last. Limit one display per dealership. Minimum order to qualify. Free qualifying display is to be kept clean, visible to consumers in retail store and showcase only Lippert product. Displays subject to change.

MANUAL STEP DEALER PROFIT PROGRAM

Part #	Description	Qty.	Dealer Price	Program
432678	24" Radius Single Steel Step - Manual	1		
432682	24" Radius Double Steel Step - Manual	1		
432687	24" Radius Triple 7" Steel Step - Manual	1		
432690	24" Radius Triple 9" Steel Step - Manual	1		
432696	Alumi-Tread Triple 9 Step - Hybrid			
432698	Alumi-Tread Quad Step - Hybrid	1		
NEW 2020109777	Solid Stance Step Stabilizer	4		
711101	Manual Step Dealer Profit Program Wallpaper - 4'	1	FREE	FREE

MANUAL STABILIZATION DEALER PROFIT PROGRAM



STABILIZE YOUR RV OR TRAILER

Lippert 24-inch and 30-inch lift scissor jacks provide a cost-efficient way to stabilize your RV or trailer. Manual scissor jacks feature easy bolt-on installation and powder-coated, rust-inhibitive finish. Each kit contains two scissor jacks, mounting hardware and manual crank handle.

FEATURES

- Easy and inexpensive way to add stabilization to your RV in order to reduce rocking and swaying
- Heavy gauge steel scissor jacks manually raise and lower with crank handle and add stability to RV fifth-wheel or travel trailer
- 24" or 30" rise
- Easy bolt-on installation; mounting hardware included
- Powder-coated, rust-inhibitive surfaces

FREE WALLPAPER



FREE WALLPAPER DISPLAY OPPORTUNITY!

Purchase the Stabilization Dealer Profit Program and receive the 4' planogram wallpaper for FREE!

Limited time offer - while supplies last. Limit one display per dealership. Minimum order to qualify. Free qualifying display is to be kept clean, visible to consumers in retail store and showcase only Lippert product. Displays subject to change.



LEVELING & STABILIZATION

MANUAL STABILIZATION DEALER PROFIT PROGRAM

Part #	Description	Qty.	Dealer Price	Program
285325	24" Scissor Jack Kit (Single)	2		
285326	24" Scissor Jack Kit with Crank Handle (Pair)	4		
285332	30" Scissor Jack Kit (Single)	2		
285344	30" Scissor Jack Kit with Crank Handle (Pair)	4		
768219	Stabilization Profit Program Wallpaper - 4'	1	FREE	FREE

GROUND CONTROL® LEVELING DEALER PROFIT PROGRAM

NEXT LEVEL RVING

Lippert has developed a range of leveling and stabilization solutions to enhance every RV set up. We've made it faster, easier and simpler to get your RV up and running at the campsite and to maintain a stable and safe foundation for the RV lifestyle. From automatic leveling systems to power stabilizer jacks and stabilization accessories, we've got you covered.



Ground Control
3.0

Ground Control 3.0 Leveling

ONE-TOUCH FIFTH-WHEEL LEVELING

With the push of a button, Ground Control 3.0 levels and stabilizes the RV in a matter of minutes and features automatic re-hitch smart memory that saves the exact height at which the RV unhitched, saving RVers time when hooking up.



Ground Control
TT

Ground Control TT Leveling

ONE-TOUCH TRAVEL TRAILER LEVELING

Ground Control TT is the first-ever automatic one-touch leveling system designed for travel trailer RVs. Long gone are the days of cranking manual jacks and using chocks and wedges to level your travel trailer. Four leveling jacks as well as the power tongue jack level your trailer accurately every time. Manual setup is now a thing of the past!

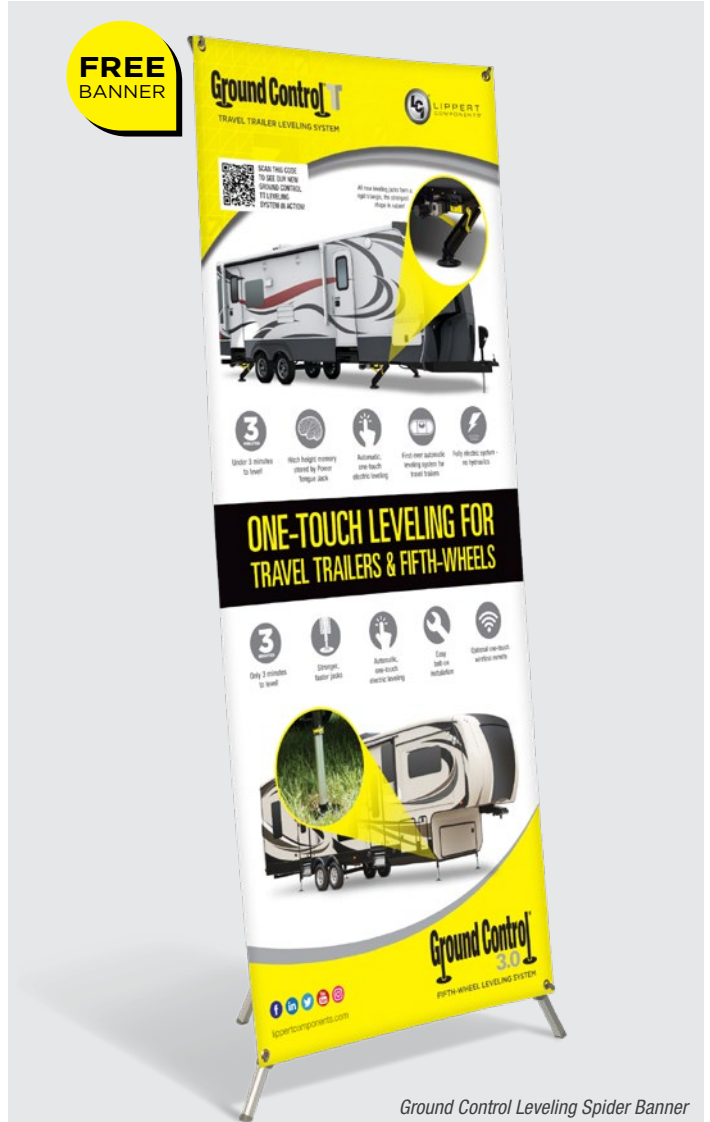

Ground Control Leveling Spider Banner

FREE BANNER DISPLAY OPPORTUNITY!

Purchase one of either Ground Control kits, and get the spider banner display for FREE!

Limited time offer - while supplies last. Limit one display per dealership. Minimum order to qualify. Free qualifying display is to be kept clean, visible to consumers in retail store and showcase only Lippert product. Displays subject to change.

GROUND CONTROL LEVELING SYSTEM DEALER PROFIT PROGRAM

Part #	Description	Qty.	Dealer Price	Program
672136	Ground Control TT - Travel Trailer Leveling	1		
358590	Ground Control 3.0 - Fifth-Wheel Leveling Four-Point 15.5K			
675817	Ground Control 3.0 - Fifth-Wheel Leveling Six-Point 15.5K			
711091	Ground Control Leveling System Spider Banner	1	FREE	FREE

JT'S STRONG ARM DEALER PROFIT PROGRAM



JT's Strong Arm



JT's Strong Arm Travel Trailer Kit

PUT AN END TO UNWANTED CHASSIS MOVEMENT

Each JT's Strong Arm stabilizer tube bolts on to each landing gear leg and to the RV frame, forming a rigid triangle to eliminate unwanted chassis movement and provide a rock-solid camping experience with no welding required. The patented universal system is designed to attach to the three main types of jacks found on RVs: scissor, front landing gear and telescoping. JT's Strong Arm Jack Stabilizers come in easy bolt-on kits of four or six stabilizer tubes and include everything needed for installation.



FEATURES

- Eliminates annoying chassis movement
- Provides a rock steady camping experience
- One-time installation/permanently attached
- Works with all types of jacks
- Bolt-on installation — No welding required
- Includes 6 stabilizer bars plus all hardware

FREE WALLPAPER



Stabilization Wallpaper

FREE WALLPAPER DISPLAY OPPORTUNITY!

Purchase the JT's Strong Arm Dealer Profit Program and receive the 4' planogram wallpaper for FREE!

Limited time offer - while supplies last. Limit one display per dealership. Minimum order to qualify. Free qualifying display is to be kept clean, visible to consumers in retail store and showcase only Lippert product. Displays subject to change.

LEVELING & STABILIZATION

JT'S STRONG ARM DEALER PROFIT PROGRAM

Part #	Description	Qty.	Dealer Price	Program
191023	JT's Strong Arm Jack Stabilizer Kit, 5th Wheel, Over 58"	2		
191025	JT's Strong Arm Jack Stabilizer Kit, Travel Trailer	2		
314594	T-Bolt for JT's Strong Arm (2 Pack)	2		
314602	T-Bolt Tightening Tool (27 1/2")	2		
768219	Stabilization Profit Program Wallpaper - 4'	1	FREE	FREE



POWER STANCE™ TONGUE JACK

Delivering on power, versatility, and durability like never before, the Power Stance tongue jack by Lippert was engineered with all of the same great features as our original power tongue jack — and then some.

This jack can be operated with an industry-first 2-way-to-7-way plug powering system. The Power Swap Auxiliary Cord™ (sold separately) can be added to any Power Stance — allowing you to easily connect your jack directly to your tow vehicle without worrying about draining your RV's power.

FEATURES

- Power Swap Auxiliary Cord 2-way-to-7-way plug powering system (sold separately)
- 7-way plug storage inlet underneath the hood of the jack
- Integrated safety chain storage ring
- Helical cut gears reduce noise and improve operating efficiencies
- 3 LED lights improve lighting and reduce power consumption
- Textured casing protects against chips and cracks
- Enhanced rocker switch for improved durability
- 3,500 lb. capacity; 18" stroke; 30 AMP
- Emergency crank thru socket
- Removable foot pad included
- Increased UV protection

POWER SWAP AUXILIARY CORD

Add the Power Swap Auxiliary Cord (sold separately) to your Power Stance tongue jack to equip it with a more convenient, less hassle power source. The 2-way-to-7-way plug connects your jack right to the power in your tow vehicle. No more draining the battery in your RV. And no more worrying whether or not there's an available power supply.



Power Swap Auxiliary Cord for Power Stance tongue jack. (sold separately)



INNOVATIVE VERSATILITY

Every jack comes with an integrated safety chain storage ring — allowing you to clip your chains out of your way instead of dragging them or wrapping them around your jack.



ADVANCED PROTECTION

Convenient storage inlet for you to tuck away your trailer's 7-way connector — keeping it safely protected from damage.

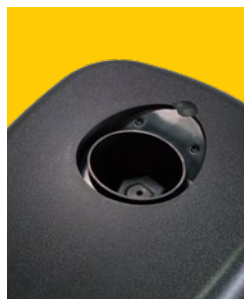

THOUGHTFUL ENGINEERING

In the event of a power failure, this jack is equipped with an emergency manual crank option so you never have to worry about being stranded.



USER-FRIENDLY OPERATION

Built-in LED lights shine directly down on your trailer coupler — making it easy to see and operate your Power Stance jack at night.



The 2-way plug inserts into the jack head underneath the control button.



The 7-way plug inserts into the tow vehicle power receptacle on the back bumper.

NO MORE CRANKING

The Lippert Tongue Jack Profit Program gives you everything you need to sell a variety of tongue jack options. Each tongue jack product comes in Lippert branded, eye-catching packaging that will jump off your shelf!



Quick Drop

Power Tongue Jack

Smart Jack

Power Stance



Power Swap Harness for Power Stance



Replacement Override Plugs

FREE DISPLAY

*Tongue Jack Floor Display
(Tongue Jacks not included)*

FREE FLOOR DISPLAY OPPORTUNITY

Purchase a qualifying combination of Tongue Jack products and receive the floor display for FREE!

Limited time offer - while supplies last. Limit one display per dealership. Minimum order to qualify. Free qualifying display is to be kept clean, visible to consumers in retail store and showcase only Lippert product. Displays subject to change.

LEVELING & STABILIZATION

TONGUE JACK DEALER PROFIT PROGRAM

Part #	Description	Qty.	Dealer Price	Program
285318	Electric Tongue Jack - Black	3		
NEW 813748	Power Stance Tongue Jack	3		
643589	Smart Jack Power Tongue Jack	2		
733926	Quick Drop Manual Tongue Jack	2		
NEW 813749	Power Swap Harness for Power Swap	5		
733924	Override Plug for Power Tongue Jack (Pair)	6		
733925	Override Plug for Smart Jack (Pair)	6		
688492	Tongue Jack Profit Program Floor Display	1	FREE	FREE

Flex Air



ROTA-FLEX Trailair



Air Ride



**FREE
DISPLAY**



Trailair Pin Box Display

FREE PIN BOX DISPLAY OPPORTUNITY

Purchase a quantity of 1 pin box and you will qualify for the program. Display program available for a limited time.

Limited time offer - while supplies last. Limit one display per dealership. Minimum order to qualify. Free qualifying display is to be kept clean, visible to consumers in retail store and showcase only Lippert product. Displays subject to change.

5TH WHEEL TOWING SOLUTIONS

5th wheel RV owners know all too well the perils of towing down bumpy roads. The Trailair pin box Profit Program features a complete line of 5th wheel towing solutions to cover the novice weekend RVer and the full-time RVer who demands nothing but the best towing experience.

TRAILAIR PIN BOX DEALER PROFIT PROGRAM

Part #	Description	Qty.	Dealer Price	Program
328484	Flex-Air M15 Pin Box w/ Medium Jaw, 18K			
328492	Flex-Air 18K Pin Box w/ Long Jaw			
369535	Flex-Air 21K Pin Box w/ Long Jaw	1		
807711	Flex-Air 21K Pin Box for Rhino Box			
179879	Air Ride M15 HD Pin Box, 18K (replaces LCI 0719 Pin Box)			
158778	Air Ride Long Jaw Pin Box, 21K (replaces LCI 1621 Pin Box)			
155943	Air Ride M19 Pin Box, 21K (replaces LCI 1116 Pin Box)			
807710	Air Ride Rhino Pin Box, 21K (For Rhino Box)			
328330	Roto-Flex 1621 Pin Box, 18K			
176440	Roto-Flex 1116 Pin Box, 19K			
328329	Roto-Flex 1621 SHD Pin Box, 21K			
807712	Roto-Flex Rhino Pin Box, 21K (For Rhino Box)			
768198	Trailair Pin Box Display with video/audio	1	FREE	FREE

POWER STABILIZER DEALER PROFIT PROGRAM



Power Stabilizer



HIGH-SPEED STABILIZATION

The PSX1® Power Stabilizer by Lippert lets you do the one thing you want most – spend more time camping, and less time setting up for camp. With the flip of a switch, you can take the sway out of your RV or trailer in minutes. No more manual cranking. No more hassle.

Uneven terrain? No problem. Each leg of our stabilizer operates independently — automatically reacting to bumpy, rugged surfaces until the RV is secured safely in place. Plus, our PSX1 Power Stabilizers are compatible with most RVs and trailers on today's market.

FEATURES

- Legs automatically adjust to uneven terrain
- Front and rear mounting applications available for maximum stability
- Constructed with a heavy gauge steel frame
- Embossed legs for added protection
- Powder-coat finish to reduce wear and tear from the elements
- One motor independently controls both legs
- Legs extend up to 30"



Stabilization Wallpaper

FREE WALLPAPER DISPLAY OPPORTUNITY!

Purchase the Stabilization Dealer Profit Program and receive the 4' planogram wallpaper for FREE!

Limited time offer - while supplies last. Limit one display per dealership. Minimum order to qualify. Free qualifying display is to be kept clean, visible to consumers in retail store and showcase only Lippert product. Displays subject to change.

LEVELING & STABILIZATION

POWER STABILIZER DEALER PROFIT PROGRAM

Part #	Description	Qty.	Dealer Price	Program
298707	Electric Stabilizer with Black Waterproof Switch	2		
1134122	Electric Stabilizer Support Arm (Yellow)	2		
352338	Power Stabilizer Replacement Motor	1		
768219	Stabilization Profit Program Wallpaper - 4'	1	FREE	FREE



REPAIR AND REPLACE

SEAL YOUR BUSINESS WITH ALPHA

Maintaining your RV just got easier. Formulated specifically to tackle the unique challenges of RV upkeep, adhesives and sealants from Alpha Systems will keep RV owners safe, happy, and dry for years to come. Alpha's complete product line features premium sealants, tapes, roofing kits, and much more.

Whether you need to seal around a window or railing, or patch a pesky leak or two on your roof, Alpha's products help get the job done right so you can enjoy the road ahead without worry.



SEALANTS

Alpha's complete line of advanced adhesives and sealants stand up to extreme weather, ozone, UV rays and vibrations, and includes all-weather sealants, solvent-based and water-based adhesives.



TAPE PRODUCTS

Our taping solutions are quick to install and leave you with no gaps to worry about — assuring that your seals are leak-proof. Designed with a non-drying compound, Alpha tapes have excellent resistance to water, weather, and air intrusion.



ROOFING KITS

Today's RVs demand better, more flexible roofing membranes for their complex designs which means you need an Alpha Systems SuperFlex Roof Kit. These kits supply you with all the major items you need to complete your next RV roof project.



**FREE
DISPLAY**

Alpha Systems Display

FREE PRODUCT DISPLAY OPPORTUNITY!

Purchase the Alpha Systems Dealer Profit Program and receive the product display for FREE!

Limited time offer - while supplies last. Limit one display per dealership. Minimum order to qualify. Free qualifying display is to be kept clean, visible to consumers in retail store and showcase only Lippert product. Displays subject to change.

REPAIR AND REPLACE

ALPHA SYSTEMS DEALER PROFIT PROGRAM

Part #	Description	Color	Qty.	Dealer Price	Program
Self-Leveling Sealants					
862144	1021 White UPC Low-VOC Self-Leveling Sealant-Tube	White	36		
862147	1021 Gray UPC Low-VOC Self-Leveling Sealant-Tube	Gray	0		
862148	1021 Beige UPC Low-VOC Self-Leveling Sealant-Tube	Beige	12		
862149	1021 Almond UPC Low-VOC Self-Leveling Sealant-Tube	Almond	12		
862215	5121 White Alphathane 100% Solids Self-Leveling Tube	White	18		
Non-Sag Sealants					
862157	1010 White UPC Non-Sag Sealant	White	18		
862159	1010 Gray UPC Non-Sag Sealant	Gray	0		
862160	1010 Beige UPC Non-Sag Sealant	Beige	12		
862161	1010 Almond UPC Non-Sag Sealant	Almond	12		
All Purpose Sealants					
862224	N2100 All Purpose RV Sealant	Clear	24		
RV Adhesives and Roof Coatings					
2020002238	8011 Water-based Adhesive (1-Gallon)		1		
862400	8019 Adhesive (1 Gallon)		1		
862401	4034 White Latex Roof Coating (1-Gallon)		1		
Butyl And Tapes					
862403	Q130 1/8" x 3/4" x 30' Butyl Tape Bulk (20ct)		0		
862405	Q130 1/8" x 3/4" x 35' Butyl Tape Clam Shell		8		
862406	Alphabond TPO Tape 3"X50' Black	Black	3		
862408	Alphabond TPO Tape 3"X50' White	White	3		
862409	Alphabond TPO Tape 4"X10' Repair Tape-Black- Clam Shell	Black	3		
862410	Alphabond TPO Tape 4"X10' Repair Tape-White- Clam Shell	White	3		
Cleaners					
862414	RV Roof Cleaner		12		
Roof and Patch Kits					
862449	Superflex Patch Kit Almond - 6.0 Sf	Almond	0		
862452	Superflex Patch Kit White - 6.0 Sf	White	0		
862422	RV Roof Kit - Superflex White	White	0		
2020043993	Alpha Systems Dealer Profit Program Display		1	FREE	FREE

COLOR SAMPLES AVAILABLE FOR: ALPHATHANE, SELF-LEVELING LAP SEALANT AND NON-SAG SEALANT CAULK TUBES*

All colors provide excellent UV protection and have color-coordinating sealants and adhesives.



Black

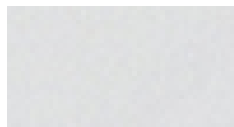

White



Gray



Almond



Beige

* The above colors are samples. Due to printing, the colors portrayed may not be accurate reproductions of actual product colors.



ALPHA SYSTEMS BACK ROOM DEALER PROFIT PROGRAM

Part #	Description	Color	Qty.	Dealer Price	Program
Self-Leveling Sealants					
862144	1021 White UPC Low-VOC Self-Leveling Sealant-Tube	White	48		
Non-Sag Sealants					
862157	1010 White UPC Non-Sag Sealant	White	24		
All Purpose Sealants					
862224	N2100 All Purpose RV Sealant	Clear	24		
RV Adhesives and Roof Coatings					
2020002238	8011 Water-based Adhesive (1-Gallon)		4		
862401	4034 White Latex Roof Coating (1-Gallon)		4		
Butyl And Tapes					
862403	Q130 1/8"X 3/4"X 30' Butyl Tape Bulk (20ct)	White	3		
2020002259	Q130 1/8"X 1"X 30' Butyl Tape Bulk (16ct)	White	3		
2020002323	Q130 1/8"X 3/4"X 30' Butyl Tape Bulk (20ct)	Black	1		
2020328716	Q180 1/8" X 1" X 30' Trim Grade Butyl Tape (16/Case)		1		
2020328717	Q180 1/8" X 3/4" X 30' Trim Grade Butyl Tape (20/Case)		1		
2020328718	Q180 1/8" X 1 1/2" X 30' Trim Grade Butyl Tape (12/Case)		1		
2020328719	Q180 3/16" X 1" X 30' Trim Grade Butyl Tape (16/Case)		1		
862406	Alphabond Tpo Tape 3"X50' Black	Black	8		
862408	Alphabond Tpo Tape 3"X50' White	White	8		

BRAKE ASSEMBLY DEALER PROFIT PROGRAM



GET UP TO 50% BETTER BRAKING DISTANCE!

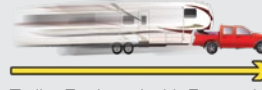

Trailer Equipped with Forward Self-Adjusting Brakes



Trailer Equipped with Standard Electric Brakes

Stopping distance at 60 MPH

BE PREPARED FOR EMERGENCY STOPS

Did you know standard brakes should be adjusted every 3 months or 3,000 miles? Forward Self-Adjusting Brakes self-adjust during every forward stop, providing up to 50 percent better braking distance and preventing premature brake line and magnet wear.



297956



298275



296649

FREE
WALLPAPER

FREE WALLPAPER DISPLAY OPPORTUNITY!

Purchase the Brake Assembly Dealer Profit Program and receive the 4' planogram wallpaper for FREE!

Limited time offer - while supplies last. Limit one display per dealership. Minimum order to qualify. Free qualifying display is to be kept clean, visible to consumers in retail store and showcase only Lippert product. Displays subject to change.

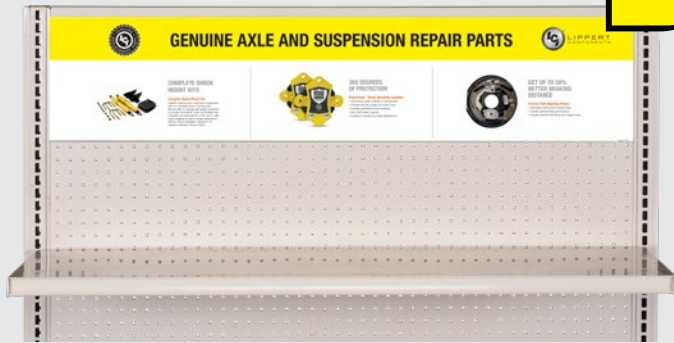

Axle and Suspension Wallpaper

REPAIR AND REPLACE

BRAKE ASSEMBLY DEALER PROFIT PROGRAM

Part #	Description	Qty.	Dealer Price	Program
296649	10" X 2.25" LH Electric Self Adjusting Brake Assy, 3.5K	4		
296650	10" X 2.25" RH Electric Self Adjusting Brake Assy, 3.5K	4		
296651	12" X 2" LH Electric Self Adjusting Brake Assy, 7.0K	4		
296652	12" X 2" RH Electric Self Adjusting Brake Assy, 7.0K	4		
297956	10" X 2.25" LH Electric Brake Assy, 3,500 Lbs.	2		
298274	10" X 2.25" RH Electric Brake Assy, 3,500 Lbs.	2		
298275	12" X 2" LH Electric Brake Assy, 7,000 Lbs.	2		
298276	12" X 2" RH Electric Brake Assy, 7,000 Lbs.	2		
768226	Brake Assembly Profit Program Wallpaper - 4'	1	FREE	FREE

SLIDE-OUT REPAIR PARTS DEALER PROFIT PROGRAM



287298



364262



118246



211852



320500



281331

Slide-outs are a main mechanical part of the RV that require constant upkeep, maintenance and repairs. Our Slide-Out Repair Parts Dealer Profit Program keeps your service team stocked with fast moving slide-out repair and maintenance parts to keep your customers camping in the great outdoors and not in your waiting area. Load up on motors, gears, wiring harnesses and more and be prepared for when your customers need to be taken care of.



FREE WALLPAPER DISPLAY OPPORTUNITY!

Purchase the Slide-Out Repair Parts Dealer Profit Program and receive the 4' planogram wallpaper for FREE!

Limited time offer - while supplies last. Limit one display per dealership. Minimum order to qualify. Free qualifying display is to be kept clean, visible to consumers in retail store and showcase only Lippert product. Displays subject to change.

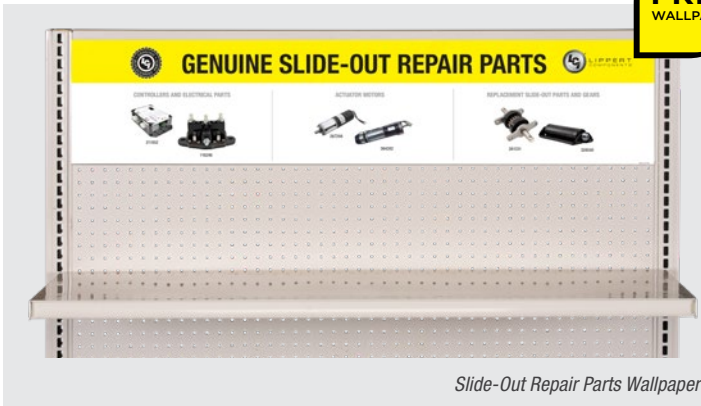

Slide-Out Repair Parts Wallpaper

SLIDE-OUT REPAIR PARTS DEALER PROFIT PROGRAM

LCI Part #	Description	Qty.	Dealer Price	Program
236575	Slide-Out Motor, IG-42 Motor - 10mm	2		
287298	Slide-Out Motor, 500:1 - High Torque	1		
364262	Slide-Out Motor, In-wall, 42mm - Mid Torque	1		
320500	J38 Roller for In-Wall Slide-Out	2		
103480	Universal Lippert Slide-Out Wear Pad	6		
281331	2 x 2 Slide-Out Gear Pack	2		
177094	Hydraulic Cartridge Valve	1		
138416	Hydraulic Hose End Fitting-JIC, Crimp-on Coupling	6		
118246	Dual Polarity Solenoid-Silver/Bronze Allo Posts	1		
211852	In-Wall Slide-Out Controller, V-Sync II	1		
229755	20' Wiring Harness	2		
238991	25' Wiring Harness	2		
120639	Interior In/Out Switch and Plate	1		
1346271	Single Flex Guard Kit	1		
1346281	Double Flex Guard Kit	1		
1346291	Triple Flex Guard Kit	1		
134993	Slide-Out Slicker (Pair)	4		
811738	Slide-Out Repair Parts Dealer Profit Program Wallpaper - 4'	1	FREE	FREE

AXLE AND SUSPENSION REPAIR PARTS DEALER PROFIT PROGRAM



Road Armor Equalizers



Shock Mount Kits



Brake Hubs



Grease Seals

FULL 360 DEGREES OF PROTECTION

Introducing the Road Armor™ Shock Absorbing Equalizer, built on our legendary Trailair® anti-shock technology. The patent pending Road Armor dampens road shock and vibrations transferred from both the leading and trailing trailer axle leaf springs.



Axle and Suspension Wallpaper

FREE WALLPAPER DISPLAY OPPORTUNITY

Purchase the Axle and Suspension Repair Parts Dealer Profit Program and receive the 4' planogram wallpaper for FREE!

Limited time offer - while supplies last. Limit one display per dealership. Minimum order to qualify. Free qualifying display is to be kept clean, visible to consumers in retail store and showcase only Lippert product. Displays subject to change.

AXLE AND SUSPENSION REPAIR PARTS DEALER PROFIT PROGRAM

Part #	Description	Qty.	Dealer Price	Program
281281	Shock Mount Replacement Kit-3" Axle Tube	1		
281255	Shock Mount Replacement Kit-2 3/8" Axle Tube	1		
696740	Road Armor Tandem Axle Equalizer Kit	1		
814200	Brake Hub - 3500 lbs	1		
814202	Brake Hub - 5200-6000 lbs	2		
814203	Brake Hub - 6000-7000 lbs	1		
693722	Rubber Insert for Lubed Dust Caps - Universal (2000-8000# axles) (10pkg)	1		
333961	Grease seal, 3500#, 1.719" ID, 2.565" OD (10/pkg)	1		
333963	Grease seal, 5200#-8000#, 2.25" ID (10/pkg)	1		
811739	Axle and Suspension Repair Parts Dealer Profit Program Wallpaper - 4'	1	FREE	FREE

REPAIR AND REPLACE



COMPACT CLEAN ON THE GO

With the Flow Max 40V Portable Power Cleaner, you can take on all of your outdoor cleaning projects like a pro. This lightweight, ultra-portable power cleaner doesn't require a spigot or garden hose connection to work. Just drop the included hose line in a bucket full of water, pool, lake, or other water source and get the job done

Easy to store in a garage, under boat seats, or in your RV, our Flow Max Power Cleaner comes equipped with the versatility and power you need to conquer everyday cleaning jobs around the house or on the road. Plus, it's equipped with a 6-in-1 spray attachment, soap bottle, long nozzle, and rotatable nozzle, so you can adjust your spraying style project to project.

FEATURES

- 520 max psi
- Lightweight and easy to transport
- Complete with 2 40V lithium-ion batteries
- High and low-pressure settings
- Long nozzle and rotatable nozzle included
- 6-in-1 spray attachment
- 25 oz. soap bottle
- Up to 28 minutes of battery life
- 4-hour charging time per battery

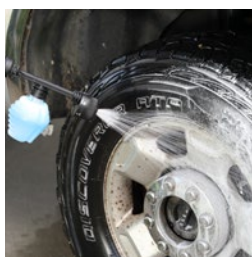

EASY CLEANING

Lightweight and compact, this power cleaner doesn't need a hose or spigot for operation. All you have to do is drop the included hose line in a water source like a lake, pool, or bucket, and spray away. It's that easy.

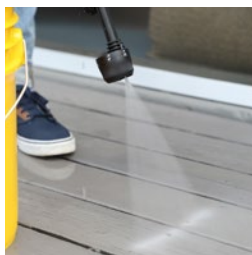

SIMPLY POWERFUL

Complete with (2) 40V lithium ion batteries, this pressure washer can reach up to 520 PSI, and can run up to 28 minutes, so you can spray down those hard to clean surfaces with no problem.



FULLY EQUIPPED

The Flow Max Power Cleaner comes with a 6-in-1 spray attachment, long and rotatable spray nozzles, and 25 oz. soap bottle, so you can switch up your cleaning style whenever you need to tackle everything from washing the car to watering the flowers.

REPAIR AND REPLACE

FLOW MAX 40V POWER CLEANER DEALER PROFIT PROGRAM

LCI Part #	Description	Qty.	Dealer Price	Program
2020111765	Flow Max 40V Portable Power Cleaner	4		

TIRE LINC TPMS DEALER PROFIT PROGRAM NEW



Tire Linc Tire Pressure and Temperature Monitoring System

ALWAYS BE READY FOR THE ROAD

The Tire Linc® system is the easy-to-install, always-on tire pressure and temperature monitoring system that makes sure you're always ready for the road. Integrated with Lippert's OneControl® app, you can monitor tire pressure and temperature right from your smartphone — don't mess with additional dashboard interfaces again.

Before a trip, on the road, and in any weather conditions, make sure you know the state of your tires with the monitoring system from a manufacturer you trust.

FEATURES

- Monitors and alerts drivers of high or low tire pressure and temperature
- Easy, do-it-yourself installation
- Works with OneControl app on iOS and Android devices
- OneControl app allows users to enter the manufacturer's suggested PSI range for each tire
- Kit includes 4 sensors and can also monitor up to 20 tires simultaneously
- Additional sensors are available for purchase and can track tires on additional towed vehicles or large RVs with more than 4 tires
- Repeater technology strengthens wireless signal in order to easily reach the tow vehicle
- Sensors come with CR2032 batteries (replaceable)

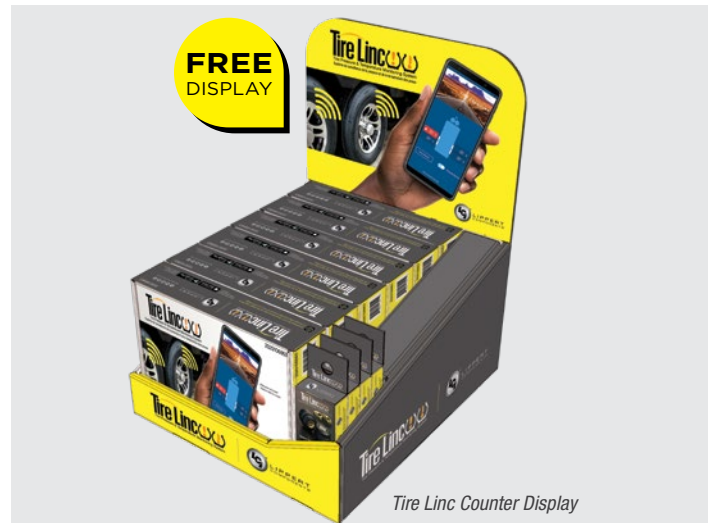

Tire Linc Counter Display

FREE COUNTER TOP DISPLAY OPPORTUNITY!

Purchase the Tire Linc Dealer Profit Program and receive the counter top display for FREE!

Limited time offer - while supplies last. Limit one display per dealership. Minimum order to qualify. Free qualifying display is to be kept clean, visible to consumers in retail store and showcase only Lippert product. Displays subject to change.

REPAIR AND REPLACE



Download the Lippert OneControl app via the Apple App Store or Google Play and take control of Tire Linc technology.



Apple and App Store are registered trademarks of Apple Inc.



Google Play and the Google Play logo are trademarks of Google LLC.

TIRE LINC DEALER PROFIT PROGRAM

Part #	Description	Qty.	Dealer Price	Program
2020106863	Tire Linc Tire Pressure and Temperature Monitoring System	6		
2020106299	Tire Linc Sensor Kit - 2 pack	4		
2020107499	Tire Linc Indicator FOB Accessory Kit	4		
2020109748	Tire Linc Profit Program Counter Display Box	1	FREE	FREE

GOODYEAR® ENDURANCE®

LIPPERT IS NOW PLEASED TO ANNOUNCE A DISTRIBUTION PARTNERSHIP WITH LIONSHEAD AND OFFER ASSEMBLIES USING GOODYEAR ENDURANCE® ST

TOW HEAVIER LOADS WITH CONFIDENCE

- Polyester construction reinforced with steel belts
- Minimize air loss while towing with an enhanced inner liner

OPERATE AT LOWER TEMPERATURES AND TRACK STRAIGHT

- Optimized tread depth and a decoupling groove keep the tire cool when traveling at faster speeds
- Enhanced tread pattern allows for a smooth, straight tow

“N” SPEED RATING AT 87 MPH

- Ideal for highway traffic

PROTECT YOUR INVESTMENT

- Defend against scuffs and punctures with Scuff Guard and Durawall® technology

LIONSHEAD 1-2-5 LIFETIME + PROTECTION

- First year (1) “No Excuses Guarantee”
- Two (2) year complimentary roadside assistance
- Five (5) year warranty on radial ST tires
- Lifetime structural warranty on all wheels
- Nitrogen Filled Tires

SEE YOUR LIPPERT SALES REP. FOR DETAILS

FREE DISPLAYS

GOODYEAR MORE DRIVEN
THE **ENDURANCE** TRAILER TIRE
TOW WITH CONFIDENCE.
1 Year (First year) “No Excuses Guarantee”

ORACLE ST TIRE
INTRODUCING THE NEW Oracle ST Tire
ENHANCED FOR HEAVY LOAD ENDURANCE

FREE TIRE AND WHEEL SHOWROOM DISPLAY OPPORTUNITY!
Purchase the Tire Assembly Dealer Profit Program and receive the Tire and Wheel Showroom display for FREE!
Limited time offer - while supplies last. Limit one display per dealership. Minimum order to qualify. Free qualifying display is to be kept clean, visible to consumers in retail store and showcase only Lippert product. Displays subject to change.

Tire Assembly Floor Displays

REPAIR AND REPLACE

TIRE ASSEMBLY DEALER PROFIT PROGRAM

Part #	Description	Qty.	Dealer Price	Program
2020328918	ST225/75R15 LRE Goodyear Radial Tire on 15x6 6-5.5 Aluminum Wheel	4		
2020329072	ST225/75R15 LRE Oracle Radial Tire on 15x6 6-5.5 Aluminum Wheel	4		
2020221361	Tire Assembly Profit Program Showroom Display	1	FREE	FREE



WEIGHT DISTRIBUTION

Level your vehicle and trailer and get safer, smooth towing with a CURT weight distribution hitch. We offer trunnion and round bar WD hitches. Add a sway control unit for even more control or select the TruTrack™ for combined weight distribution and integrated sway control.

WHY USE A WEIGHT DISTRIBUTION HITCH?

CURT weight distribution hitches are designed to distribute the tongue weight of a trailer across all axles of the vehicle-trailer combination, allowing for more control and safer towing. We offer both round bar and trunnion bar hitches in a range of weight capacities. Most WDs are also available in a kitted option with a pre-torqued trailer ball and sway control.

FEATURES

- Trunnion and round bar options
- Multiple capacities to choose from
- Kits include a pre-torqued 2-5/16" trailer ball and sway control unit
- Protected by a durable black powder coat finish

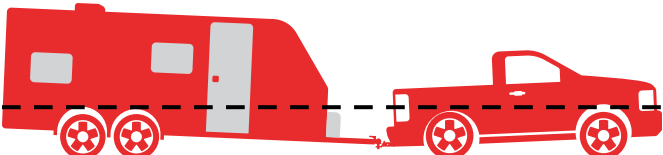

Without weight distribution

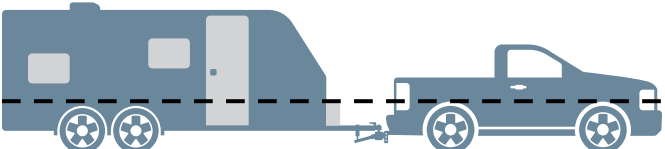

With weight distribution

WEIGHT DISTRIBUTION DEALER PROFIT PROGRAM



SCAN TO SEE OUR VIDEO



TRUTRACK™ WEIGHT DISTRIBUTION SYSTEM

- Integrated sway control actively resists sway and levels the vehicle and trailer
- Welded head with cast pieces provides solid spring bar attachment
- Uses spring & cam system with hardened components, instead of metal friction
- Brackets use friction to resist lateral movement, replacing a sway control
- Fits virtually all A-frame trailers



Quick, easy tilt adjustment, no disassembly required



Adjustable brackets provide fixed support unlike chain models

DID YOU KNOW?

TruTrack is designed to work in two neutral spring bar settings to fit almost all A-frame trailers. The spring bars can easily be repositioned in the 30-degree or 70-degree position (+/-5 degrees). Adjustment takes only 15 to 20 minutes, start to finish.

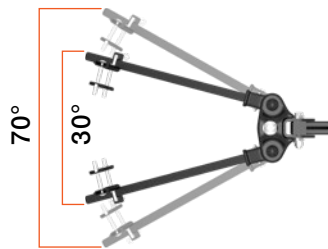

FREE DISPLAY

FREE WEIGHT DISTRIBUTION DISPLAY OPPORTUNITY

Purchase the qualifying dealer program dollar amount and receive a free weight distribution display and header card.

Limited time offer - while supplies last. Limit one display per dealership. Minimum order to qualify. Free qualifying display is to be kept clean, visible to consumers in retail store, and showcase only CURT product.



17062 / 17063 (sway control incl.)

17200

MV ROUND BAR WD KITS & SWAY CONTROL

- Grease zerks fitting provides easy, continuous lubrication
- Snap-up brackets and lift handle for easy leveraging of spring bars
- Heavy-duty, fabricated head can be adjusted for precise leveling

Sway control units reduce lateral movement, commonly caused by the wind, while pulling a trailer. The diagrams below illustrate the effectiveness of using sway control units. Two sway control units should be used for maximum control and stability.



WEIGHT DISTRIBUTION DEALER PROFIT PROGRAM

CURT Part#	Description	GTW	Qty.	Dealer Price	Program
17500	TruTrack™ weight distribution system	8,000 - 10,000 lbs.	4		
17062	MV round bar weight distribution kit	8,000 - 10,000 lbs.	4		
17063	MV round bar weight distribution kit	10,000 - 14,000 lbs.	2		
17200	Sway control	--	6		
99254-GC	Weight distribution, double-stack display stand (header card included)		1	FREE	FREE

ECHO® MOBILE BRAKE CONTROLLER DEALER PROFIT PROGRAM



ECHO® MOBILE BRAKE CONTROLLER

- Wireless, portable design allows for easy transfer from one vehicle to another
- Bluetooth connection to control all brake settings from your smartphone
- Custom-designed app monitors brake activity and sends status updates
- Zero-tool, plug-and-play install between vehicle-trailer 7-way connectors
- Triple-axis, motion-sensing accelerometer for highly responsive, smooth stops
- Stores multiple user and vehicle-trailer profiles
- Multi-color LED indicates power, trailer detection and wireless connectivity
- Potted circuit board is sealed off from the elements for lasting durability
- Locking tab helps maintain a strong connection
- App available for Apple iOS and Android OS

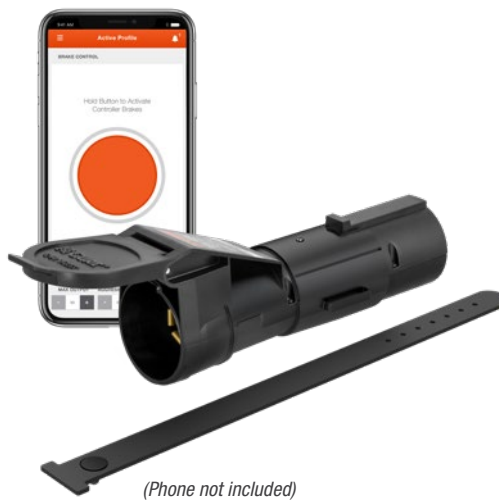

**FREE
DISPLAY**



99286-GC

FREE ECHO DISPLAY OPPORTUNITY!

Purchase six Echo brake controller units and receive a free Echo counter display.

Limited time offer - while supplies last. Limit one display per dealership. Minimum order to qualify. Free qualifying display is to be kept clean, visible to consumers in retail store, and showcase only CURT product.

CURT MANUFACTURING



Insert Echo® between the vehicle and trailer



Download the app on your smartphone



Configure settings in the app and tow

ECHO MOBILE BRAKE CONTROLLER DEALER PROFIT PROGRAM

CURT Part#	Description	Qty.	Dealer Price	Program
51180	Echo mobile brake controller	6		
99286-GC	Echo counter top display	1	FREE	FREE

BRAKE CONTROLLER DEALER PROFIT PROGRAM



Quick plug equipped for fast, easy installation (excluding Echo®)

BRAKE CONTROLLERS

- Easily calibrated for all towing needs
- Compatible with anti-lock brakes and cruise control
- Includes mounting hardware, if necessary
- Informative, full-color retail packaging
- Limited lifetime warranty

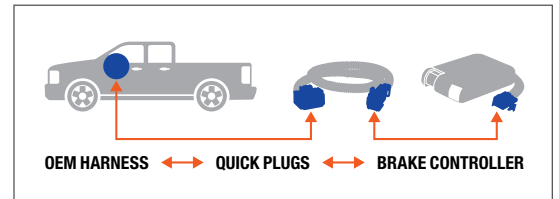

Quick plug equipped for fast, easy installation (excluding Echo®)



51180

ECHO® MOBILE

Bluetooth-enabled
Smartphone-ready
Portable design



51170

SPECTRUM™

Integrated OE look
Hidden main module
Tri-color LED display



51140

TRIFLEX™

Tri-axis sensitivity
Auto adjustment
Digital display



51120

DISCOVERY™

Time-based
Adjustable output
Digital display



51110

VENTURER™

Time-based
Adjustable output
Ramp-up LED display

DYNAMIC POWER ADJUSTMENT

Applies to Echo®, Spectrum™, and TriFlex™



Automatic power reduction for incline

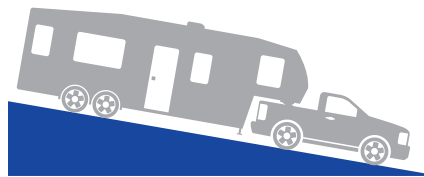

Automatic power increase for decline

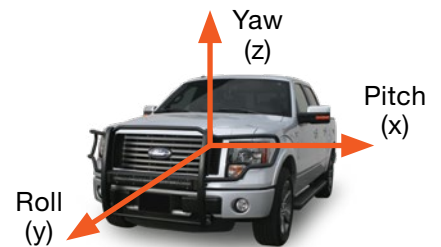

Tri-axis circuit detects inertia on three planes for greater sensitivity over dual-axis models

Note: Values represented are for illustration only. The actual preset and adaptive values may differ from those shown here.

BRAKE CONTROLLER DEALER PROFIT PROGRAM

CURT Part#	Description	Activation	Display	Axes	Brakes	Qty.	Dealer Price	Program
51180	Echo	Tri-axis inertia	Phone app	1 - 2	2 - 4	2		
51170	Spectrum	Tri-axis inertia	Tri-color LED	1 - 4	2 - 8	2		
51140	TriFlex	Tri-axis inertia	Digital	1 - 4	2 - 8	3		
51120	Discovery	Time-based	Digital	1 - 4	2 - 8	3		
51110	Venture	Time-based	LED	1 - 3	2 - 6	2		



5TH WHEEL HITCHES

A CURT 5th wheel hitch is your ticket to freedom, giving you confidence for the road ahead. We offer 5th wheel hitches and mounting options to perfectly suit your truck and trailer, including OEM puck products.

ADVANTAGE OF OEM PUCK SYSTEM LEGS

These products make installation and removal of a 5th wheel hitch easier than ever, using the OEM puck system built into select pickup trucks.



Ram puck system



16021 Ram legs shown with 16540 5th wheel head

5TH WHEEL HITCHES & ACCESSORIES DEALER PROFIT PROGRAM

16K
GTW



20K
GTW



25K
GTW



A-SERIES 5TH WHEEL HITCHES

The A-series is named for its articulating head design. The head is built on a patented cast yoke that offers a stable, quiet ride, even with large 5th wheel trailers. This cast yoke also features torsion springs and poly-torsion inserts to support the head and add even more stability to the connection.

- Lockable, self-resetting handle for fewer steps while coupling
- One-pin head attachment for easy removal and relocation
- High-strength interlocking jaws to add security and reduce noise
- Compatible with rotating pins boxes, such as Sidewinder™



16428 brackets shown with 16204 base rails

CUSTOM BRACKETS & BASE RAILS

- Vehicle-specific bracket applications eliminate drilling, cutting installation time in half
- Brackets designed to be used with CURT industry-standard base rails
- Protected by a rust-resistant liquid Bonderite® coating

THREE-POSITION COUPLING INDICATOR



Three-position coupling indicator clearly shows coupling status

- UNCOUPLE** Jaws unlocked, ready to uncouple
- COUPLE** Jaws open, ready to couple
- TOW** Jaws locked, ready to tow



16721025



16722

5TH WHEEL LUBE PLATES

- Provides a buffer between 5th wheel head plate and kingpin box
- Reduces normal wear and tear when towing
- Eliminates messy grease deposits on hitch head plate
- Constructed from tough polyethylene

5TH WHEEL HITCHES & ACCESSORIES DEALER PROFIT PROGRAM

CURT Part#	Description	Applications	Qty.	Dealer Price	Program
16204	Base rails only, universal	--	4		
16200	Base rails and hardware, universal	--	2		
16120	5th wheel with legs, A-series, 16K	--	2		
16140	5th wheel with legs, A-series, 20K	--	2		
16180	5th wheel with legs, A-series, 25K	--	1		
16427	Custom under-bed brackets	Ram	2		
16428	Custom under-bed brackets	Ford	2		
16429	Custom under-bed brackets	Chevrolet / GMC	2		
16722	5th wheel lube plate, 12"	--	4		
16721025	5th wheel lube plate, 10", 25-pack	--	1		

5TH WHEEL & GOOSENECK OEM PUCK SYSTEM DEALER PROFIT PROGRAM



5TH WHEEL PUCK SYSTEM LEGS

Installing a 5th wheel hitch couldn't be easier than with CURT OEM puck system 5th wheel legs or rollers. They simply drop into the truck bed puck system built into select pickups and instantly provide a solid mounting platform for a 5th wheel hitch.

- Allows CURT 5th wheel hitches to fit an OEM puck system
- Quarter-turn anchors allow for quick installation and removal
- Anchors can be adjusted to eliminate chocking between the legs and under-bed platform
- Highly durable carbide powder coat finish

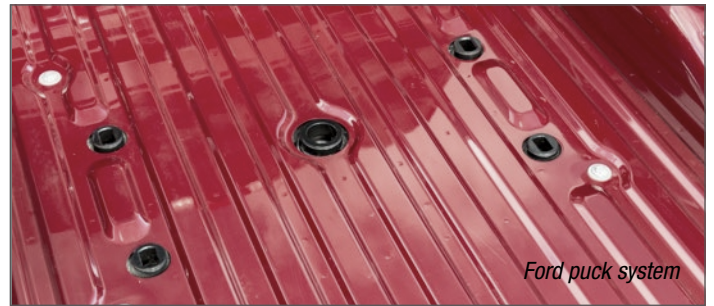

HOW TO INSTALL OEM PUCK SYSTEM PRODUCTS



Step 1 - Drop OEM product into the truck bed puck system



Step 2 - Close the anchor levers to lock the 5th wheel into place



Step 3 - Secure levers with attached safety pins and you're ready to hitch up your trailer



A-SERIES 5TH WHEEL HITCHES

- Lockable, self-resetting handle for fewer steps while coupling
- Fully articulating torsion head for controlled coupling and stable towing
- Alignment pegs and easy-access mounting bolts for simple leg-to-body attachment
- Cast yoke and poly-torsion inserts suppress shock loads and reduce noise
- One-pin head attachment for easy removal and relocation
- High-strength interlocking jaws to add security and reduce noise
- Compatible with rotating pins boxes, such as Sidewinder™

THREE-POSITION COUPLING INDICATOR



Three-position coupling indicator clearly shows coupling status

- UNCOUPLE** Jaws unlocked, ready to uncouple
- COUPLE** Jaws open, ready to couple
- TOW** Jaws locked, ready to tow

5TH WHEEL & GOOSENECK OEM PUCK SYSTEM DEALER PROFIT PROGRAM



GM puck system



60618
Ram



60692
Chev / GMC, Ford, Nissan

OEM PUCK SYSTEM GOOSENECK KITS

Available for Chevrolet, Ford, GMC, Nissan and Ram, these kits utilize the truck bed puck system built into select pickups with the towing prep package. The ball and anchors easily drop into the pucks, lock into place and are immediately ready to couple.

- Kits include a 2-5/16" gooseneck ball, two safety chain anchors, rubber hole cover and durable storage case
- Ball installs easily with quarter-turn latch locking system and anchors simply drop in, eliminating the need for tools
- Wide openings accept large safety chain hooks
- Stainless steel retention balls keep the gooseneck ball's shank fully locked into the hitch

Shown with A25 5th wheel and base rails (not included)

FREE 5TH WHEEL DISPLAY OPPORTUNITY

Purchase the qualifying dealer program dollar amount and receive a free 5th wheel display, adapter and display box.

Limited time offer - while supplies last. Limit one display per dealership. Minimum order to qualify. Free qualifying display is to be kept clean, visible to consumers in retail store, and showcase only CURT product.

5TH WHEEL & GOOSENECK OEM PUCK SYSTEM DEALER PROFIT PROGRAM

CURT Part#	Description	Applications	Qty.	Dealer Price	Program
16017	5th wheel legs, OEM puck system, 24K	Ford trucks with puck system	2		
16021	5th wheel legs, OEM puck system, 25K	Ram trucks with puck system	2		
16025	5th wheel legs, OEM puck system, 25K	Chev / GMC trucks with puck system	2		
16520	5th wheel head, A-series, 16K	--	2		
16540	5th wheel head, A-series, 20K	--	2		
16580	5th wheel head, A-series, 25K	--	1		
60692	Gooseneck kit, OEM puck system, 30K	Chev, Ford, GMC, Nissan trucks w/ pucks	2		
60618	Gooseneck kit, OEM puck system, 30K	Ram trucks with puck system	2		
99156-GC	5th wheel display (adapter required for A-series hitches)		1	FREE	FREE
99330-GC	Display box, A-series 5th wheels (shows all A-Series capacities and features)		1	FREE	FREE
99257-GC	Display adapter for 99156-GC (adapts A20 and A25 only)		1	FREE	FREE
99183-GC	Display adapter for 99156-GC (adapts A16 only)		1	FREE	FREE

BIKE RACKS & CARGO MANAGEMENT DEALER PROFIT PROGRAM



ALUMINUM CARGO CARRIER WITH RAMP

- Three-position ramp can be extended, folded vertically or stowed in the carrier
- Double-folding ramp for ergonomic operation and less wind resistance
- Ramp folds flat into the carrier for compact storage and rear vehicle access
- Built-in reflectors add visibility
- Non-skid ridges provide enhanced traction when moving up or down the ramp
- 8-bolt assembly for fast, easy installation



18112

CARGO CARRIERS

- Available in tray-style and basket-style and with folding ramp
- Easily bolts together for quick assembly
- Mesh base for easy cleanup
- Built-in reflectors add visibility (basket-style only)
- Mounting holes for cargo net or bungees (tray-style only)
- Full-color retail packaging



18109

18153



83001 (2-pack)



83002 (4-pack)



18202 (includes netted storage bag)



CARGO STRAPS & NETS

Fully secure your items with CURT cargo straps and nets. We offer various sizes for light-duty and heavy-duty cargo. Our cargo carrier net combines the convenience of a bungee cord with the effectiveness of a rope.

BIKE RACKS & CARGO MANAGEMENT DEALER PROFIT PROGRAM

HITCH-MOUNTED BIKE RACKS

- Arms fold down when not in use for compact storage
- Threaded anti-wobble shank prevents swaying during travel
- Adjustable rubber cradles will not scratch bike frames
- Tilts away for convenient rear vehicle access
- 1-1/4" or 2" shank on 18029 and 18030
- 2" shank on 18065
- Full-color retail packaging



18029



18030



18065



18085

TRAY-STYLE BIKE RACK

- Ratcheting arms lock down onto the frames and will not loosen
- Adjustable cradles easily fit various bike sizes and styles
- Padded arms protect the bike frames from nicks and scratches
- Tilts away for convenient rear vehicle access
- Folds up when not in use for compact storage
- Threaded anti-wobble shank helps prevent bikes from swaying
- Adapter sleeve allows mounting on 1-1/4" or 2" receiver tubes

99039-GC

Shown with three bike racks (not included)

FREE BIKE RACK DISPLAY OPPORTUNITY

Purchase the qualifying dealer program dollar amount and receive a free bike rack display and header card.

Limited time offer - while supplies last. Limit one display per dealership. Minimum order to qualify. Free qualifying display is to be kept clean, visible to consumers in retail store, and showcase only CURT product.

BIKE RACKS & CARGO MANAGEMENT DEALER PROFIT PROGRAM

CURT Part#	Description	Capacity	Specifications	Qty.	Dealer Price	Program
18109	Tray-style cargo carrier	500 lbs.	60" (L) x 19-1/4" (W) x 2-1/2" (H)	2		
18153	Basket-style cargo carrier	500 lbs.	60" (L) x 23-3/4" (W) x 5-1/2" (H)	2		
18113	Aluminum cargo carrier with ramp	500 lbs.	50" (L) x 30-1/2" (W) x 4" (H)	2		
18029	Hitch-mounted bike rack	90 lbs.	Holds 2 bikes	2		
18030	Extendable, hitch-mounted bike rack	90 / 180 lbs.	Holds 2 or 4 bikes	2		
18065	Premium, hitch-mounted bike rack	225 lbs.	Holds 5 bikes	2		
18085	Tray-style bike rack	90 lbs.	Holds 2 bikes	2		
18202	Cargo net, fits 60" (W) carriers	--	43" x 24"	4		
83001	Ratchet strap, red, 2-pack	500 lbs. (WL)	10' (L) x 1" (W)	2		
83002	Ratchet strap, red, 4-pack	500 lbs. (WL)	16' (L) x 1" (W)	2		
99039-GC	Single-sided bike rack display, holds three bikes			1	FREE	FREE
99012-GC	Bike rack display header card			1	FREE	FREE

TRAILER JACK DEALER PROFIT PROGRAM



MARINE JACK

- Caster wheel for trailer mobility and coupling
- Side-wind handle raises or lowers trailer coupler
- Bolt-on hardware included for secure mounting



Swivel bracket allows jack to fully swing up during travel



Heavy-duty pull-pin locks jack securely in place



28101

A-FRAME JACKS

- Designed to be mounted on an A-frame trailer tongue
- Can be bolted or welded on (hardware not included)



Mounting bracket can be bolted or welded to the trailer



28204 side-wind

28202 top-wind

TRAILER JACK DEALER PROFIT PROGRAM

CURT Part#	Description	Capacity	Wind	Travel	Packaging	Qty.	Dealer Price	Program
28101	Marine jack	1,000 lbs.	Side	10-1/2"	Packaged	2		
28202	A-frame jack	2,000 lbs.	Top	14-3/4"	Bulk	2		
28204	A-frame jack	2,000 lbs.	Side	15"	Bulk	2		

BETTERWEIGH™ MOBILE TOWING SCALE DEALER PROFIT PROGRAM



WHAT IT MEASURES



BETTERWEIGH MOBILE TOWING SCALE

- Measures real-time vehicle-trailer weights for safer, easier towing and hauling
- No more complicated at-home measurements or trips to the scale
- Bluetooth connection provides active readouts on the driver's smartphone
- No-install, plug-and-play setup into vehicle diagnostic port (OBD-II) below the dash
- Accurate within + / - 5%
- Offers easy brake controller setup by measuring exact trailer brake gain needed
- App available for Apple iOS and Android OS

FREE BETTERWEIGH DISPLAY OPPORTUNITY

Purchase 12 BetterWeigh units and receive a free BetterWeigh counter display.

Limited time offer - while supplies last. Limit one display per dealership. Minimum order to qualify. Free qualifying display is to be kept clean, visible to consumers in retail store, and showcase only CURT product.



99293-GC shown with 12 BetterWeigh retail packages (not included)

FREE DISPLAY

HOW IT WORKS

FORCE

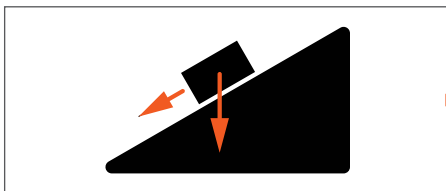

Force is determined by measuring slip across the torque converter as the vehicle accelerates through 15 mph

ACCELERATION

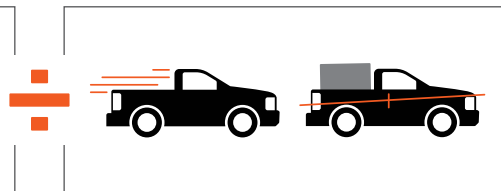

An integrated accelerometer detects how quickly the vehicle takes off and measures changes in the vehicle's pitch

WEIGHT

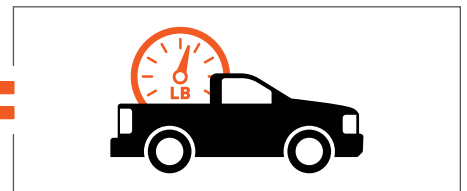

BetterWeigh™ calculates towing weights by gathering data from the OBD-II port and applying Newton's Second Law

BETTERWEIGH MOBILE TOWING SCALE DEALER PROFIT PROGRAM

CURT Part#	Description	Qty.	Dealer Price	Program
51701	BetterWeigh mobile towing scale	12		
99293-GC	BetterWeigh counter top display	1	FREE	FREE

SHOCKDROP™ SERIES DEALER PROFIT PROGRAM



SHOCKDROP TECHNOLOGY

ShockDrop technology is an adaptive, dynamic towing system that is engineered to reduce vibrations, rattling and strain on the vehicle. It does this by using an integrated, flexible polyurethane isolator for improved comfort and control. Compared to other cushion hitch options, ShockDrop is simple and virtually maintenance-free.

ENHANCED COMFORT

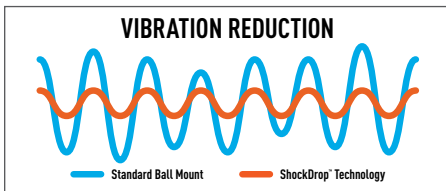

Unlike a traditional towing connection, ShockDrop absorbs road unevenness to maximize comfort

IMPROVED CONTROL

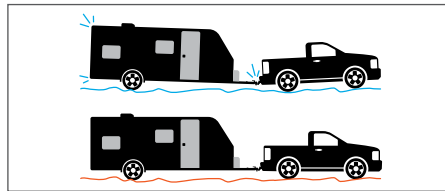

ShockDrop dynamically reacts to jarring, limiting its effects and giving the driver increased control on the road

UNMATCHED CONFIDENCE



Unlike other cushion hitches, ShockDrop is virtually maintenance-free and is tested for thousands of cycles

FEATURES OF SHOCKDROP TECHNOLOGY

- Dampens jerking and jarring from bumps and potholes for smoother towing
- Cushioned isolator reduces rattling and vibration for a more comfortable ride
- Improved trailer control during events of sudden braking
- Minimizes stress on tow vehicle's brakes and suspension for extended longevity
- Virtually maintenance-free with no airbag or bearings to service
- Grease zerk fitting provides easy lubrication



SHOCKDROP SERIES DEALER PROFIT PROGRAM

CURT Part#	Description	Capacity	Qty.	Dealer Price	Program
45949	Rebellion™ XD cushion hitch ball mount	15,000 lbs. / 6-1/4" drop / 1/4" rise	1		
40047	RockerBall™ trailer ball	7,500 lbs. / 2" ball / 1" shank	2		
99291-GC	RockerBall counter top display		1	FREE	FREE
99295-GC	Rebellion XD floor display		1	FREE	FREE
99300-GC	Rebellion XD display header card		1	FREE	FREE





99291-GC

FREE DISPLAY



99295-GC shown with 99300-GC signage

FREE DISPLAY OPPORTUNITY

Purchase the qualifying dealer program dollar amount and receive a free display and header card.

Limited time offer - while supplies last. Limit one display per dealership. Minimum order to qualify. Free qualifying display is to be kept clean, visible to consumers in retail store, and showcase only CURT product.



REBELLION™ XD ADJUSTABLE CUSHION HITCH BALL MOUNT

- Dynamic, adaptive suspension ball mount featuring ShockDrop technology
- Lighter-weight design for less stress on the trailer hitch receiver
- 6-1/4" maximum drop and 1/4" rise (shank cannot be used in the rise position)
- Cast steel construction with a textured, dark grey teridium finish for a premium look on your vehicle
- Tested and rated for 15,000 lbs. GTW and 1,500 lbs. TW
- Fits trailer hitches with a 2" x 2" receiver tube opening
- Equipped with 1-1/4" hole (trailer ball sold separately)

ROCKERBALL™ TRAILER BALL

- Dynamic trailer ball featuring ShockDrop technology reduces jerking and jarring
- Anti-swivel base keeps RockerBall locked in place
- Forged steel construction with a durable carbide black powder coat finish on base and chrome plating on ball
- Tested for safety to meet SAE J684 specifications
- Not compatible with Rebellion XD ball mount



Adjustable, six-position head for precise leveling with different trailers



Grease zerk fitting on the back of the shank provides easy lubrication



Retrofits onto ball mounts with 2-1/2" wide tongues to improve the towing experience



Grease zerk fitting on the bottom of the shank provides easy lubrication



TOWING ACCESSORIES

Whether it's a ball mount, trailer ball, trailer hitch lock or wheel chocks, CURT has the towing accessories you need to outfit your vehicle and trailer for a safe, successful journey. Our trailer hitch accessories allow you to make the most of your adventure and enjoy every mile.

FEATURED PRODUCT: REBELLION™ XD CUSHION HITCH MOUNT

- Dampens jerking and jarring from bumps and potholes for smoother towing
- Improved trailer control during events of sudden braking

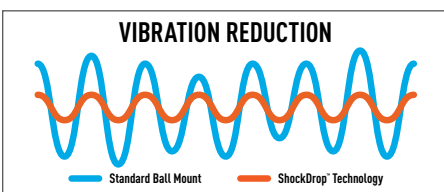

Unlike a traditional towing connection, ShockDrop™ absorbs road unevenness to maximize comfort



TOWING ACCESSORIES DEALER PROFIT PROGRAM



FREE LOZIER HEADER CARD OPPORTUNITY

Purchase the qualifying dealer program dollar amount and receive a free 'Towing Accessories' category Lozier header card.

*Limited time offer - while supplies last. Limit one display per dealership. Minimum order to qualify.
Free qualifying display is to be kept clean, visible to consumers in retail store, and showcase only CURT product.*

TOWING ACCESSORIES DEALER PROFIT PROGRAM

CURT Part#	Description	Specifications	Qty.	Dealer Price	Program
45949	Rebellion XD cushion hitch mount	15,000 lbs. / 6-1/4" drop / 1/4" rise	1		
40004	Trailer ball, bulk	6,000 lbs. / 2" ball / 1" shank	3		
40005	Trailer ball, bulk	7,500 lbs. / 2-5/16" ball / 1" shank	3		
40006	Trailer ball, bulk	10,000 lbs. / 2-5/16" ball / 1-1/4" shank	3		
40007	Trailer ball, bulk	10,000 lbs. / 2-5/16" ball / 1" shank	3		
40030	Trailer ball, bulk	15,000 lbs. / 2-5/16" ball / 1-1/4" shank	3		
45030	Ball mount, class 3	7,500 lbs. / 2" drop / 3/4" rise	2		
45050	Ball mount, class 3	7,500 lbs. / 4" drop / 2" rise	2		
45070	Ball mount, class 3	7,500 lbs. / 6" drop & 6,000 lbs. / 4" rise	2		
45036	Ball mount, class 3, loaded	7,500 lbs. / 2" drop / 2" ball	2		
45056	Ball mount, class 3, loaded	7,500 lbs. / 4" drop / 2" ball	2		
45042	Ball mount, class 3, loaded	7,500 lbs. / 4" drop / 2-5/16" ball	2		
45041	Ball mount, class 3, loaded	7,500 lbs. / 2" drop / 2-5/16" ball	2		
45340	Ball mount, forged	17,000 lbs. / 2" drop / 1" rise	1		
45341	Ball mount, forged	17,000 lbs. / 4" drop / 3" rise	1		
45342	Ball mount, forged	17,000 lbs. / 6" drop / 5" rise	1		
21581	Hitch pin & clip, hole-style	5/8" pin fits up to 2-1/2" receivers	8		
21506	Hitch pin & clip, groove-style	5/8" pin fits up to 3" receivers	4		
21501	Hitch pin & clip, hole-style	5/8" pin fits up to 2" receivers	4		
16722	5th wheel lube plate, single	12"	4		
16721025	5th wheel lube plate, 25-pack	10"	1		
45405	Reducer sleeve	2-1/2" to 2"	3		
45408	Reducer sleeve	3" to 2-1/2" or 2-1/2" to 2"	3		
23255	5th wheel lock, king pin	--	3		
23256	5th wheel lock, base rail	1/2" pin diameter	3		
23021	Hitch lock, dead bolt, chrome-plated	5/8" pin fits up to 3" receivers	3		
23025	Hitch lock, barbell, chrome-plated	5/8" pin fits up to 3" receivers	3		
23519	Hitch lock, barbell, stainless steel	5/8" pin fits up to 2-1/2" receivers	3		
23528	Hitch lock, barbell, chrome-plated	5/8" pin fits up to 2-1/2" receivers	3		
23503	Coupler lock, adjustable	1/4" pin fits latches 1" to 3"	3		
22800	Wheel chock	--	3		
25081	Safety pin	1/4" pin / 2-3/4" long	3		
25011	Safety pin	5/16" pin / 3" long	3		
58141	Plug, 7-way RV blade	Trailer end	4		
58151	Socket, 7-way RV blade	Vehicle end	4		
58291	Mounting bracket	Holds 7-way RV blade sockets	3		
58000	Mounting bracket, easy-mount, 2"	Holds 4- or 5-way flat & 6- or 7-way sockets	2		
58003	Mounting bracket, easy-mount, 2-1/2"	Holds 4- or 5-way flat & 6- or 7-way sockets	2		
99148-GC	Towing accessories header card		1	FREE	FREE

TOWING ACCESSORIES DEALER PROFIT PROGRAM



REBELLION™ XD CUSHION HITCH MOUNT

- Dynamic, adaptive suspension ball mount featuring ShockDrop technology
- Minimizes stress on tow vehicle's brakes and suspension for extended longevity
- Virtually maintenance-free with no airbag or bearings to service
- Lighter-weight design for less stress on the trailer hitch receiver
- Adjustable, six-position head
- 6-1/4" maximum drop and 1/4" rise (shank cannot be used in the rise position)
- Textured, dark grey teridium finish for a premium look on your vehicle
- Rated for 15,000 lbs. GTW / 1,500 lbs. TW
- Fits 2" x 2" receiver tube openings



TRAILER BALLS

- Chrome-plated, stainless steel and raw trailer balls available
- Fine threads provide superior holding strength
- Tested for safety to meet U.S. VESC specifications



HITCH & COUPLER LOCKS

- 1/4-turn lock activation
- Watertight dust cap
- Two keys included

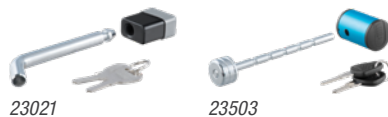

CLASS 3 BALL MOUNTS

- Fits any 2" x 2" receiver tube opening
- Multiple drop and rise options to accommodate various vehicle-trailer combinations
- Loaded mounts include a factory-torqued trailer ball and pin & clip
- Increased drop on select models allows for level towing with lifted vehicles



FORGED BALL MOUNTS

- Fits any 2" x 2" receiver tube opening
- Solid, forged steel for superior strength



REDUCER SLEEVES

- #45405 reduces a 2-1/2" x 2-1/2" receiver tube opening to fit a 2" x 2" shank
- #45408 two-piece set reduces a 3" receiver tube opening to fit a 2-1/2" shank or 2" shank



HITCH PINS & CLIPS

- Secures ball mounts and other receiver tube inserts
- Bent handle for an easier grip

CURT MANUFACTURING



Key slot angled upward for easier ergonomic access



23256

5TH WHEEL HITCH LOCK

- Locks a 5th wheel hitch into the rails, taking the place of a pin & clip
- Installs tight against the lip of the base rail for enhanced security
- Extra-long 1/2" diameter pin fits all industry-standard base rails
- Rust-free aluminum housing with a durable black powder coat finish
- Easy-to-access, 1/8-turn lock activation



Universal design fits most 5th wheel trailer kingpins



23255

5TH WHEEL KING PIN LOCK

- Locks on to 5th wheel kingpin to deter theft
- Built with an aluminum body for corrosion resistance
- Two keys included for added convenience



16721025



16722

5TH WHEEL LUBE PLATES

- Provides a buffer between 5th wheel head plate and kingpin box
- Reduces normal wear and tear when towing
- Eliminates messy grease deposits on hitch head plate
- Constructed from tough polyethylene



Adds safety during vehicle maintenance or to parked trailers



22800

WHEEL CHOCK SET

- Raised tread offers a better grip on the wheel
- Saw-tooth edges on the base provide solid traction on the ground
- Always to be used with vehicle brake
- Not for commercial use



25081



25011

SAFETY PINS

- Quickly secures coupler latches, pintle hooks, jack legs or caster wheels
- Square retainer wire clip adds clearance



58141



58151



58291

7-WAY RV BLADE PLUG & SOCKET AND MOUNTING BRACKET

- Concealed terminals help ensure a reliable connection
- Splices into existing vehicle or trailer wiring (wires not included)
- High-strength steel bracket secures socket to the vehicle or hitch

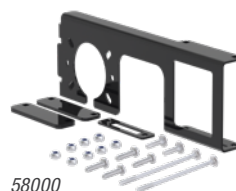

58000

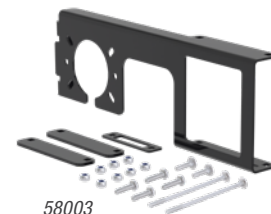

58003

EASY-MOUNT ELECTRICAL BRACKETS

- Allows connectors to be hitch-mounted with no drilling or clamping required
- Two threaded stainless steel bolts provide secure attachment to the hitch
- Notched design allows convenient access to pin & clip
- Steel body will not break like competitive plastic products
- Protected by a durable powder coat finish
- Patent #5,664,304

TOWING ELECTRICAL DEALER PROFIT PROGRAM



56070 (7')

7' CUSTOM WIRING HARNESS EXTENSION

- Routes a 7-way RV blade socket into truck bed while retaining use of rear socket
- Simple plug-and-play design; no cutting or splicing
- Allows for easy connection of 5th wheel or gooseneck wiring
- Vehicle-specific, plug-and-play design



Right-angle plug for easy installation



7' routes socket into rear of the truck bed



52044



52028



52010

52023

BREAKAWAY KITS

- Activates electric trailer brakes in the event of a breakaway
- Meets DOT requirements for holding / breakaway situations
- Compatible on trailers with up to three axles
- LED lights indicate a good charge, battery charging or low battery (#52044)
- Bolt-on mounting system for secure installation on the trailer
- Required in most states

BREAKAWAY KIT REPLACEMENT PARTS

- For use with trailer breakaway systems
- Breakaway switch with 10' leads connects tow vehicle to trailer breakaway battery (#52010)
- Sealed lead acid battery for 1-3 axle trailers (12-volt, 5 amps per hour)



7-WAY RV BLADE REPLACEMENT HARNESSSES

- Replaces the trailer-end plug of any 7-way harness
- Wires protected by heavy-duty, weather-resistant cable
- Double-sided blades for improved connectivity



4-WAY FLAT PLUG & SOCKET

- Splices into existing wiring
- Bonded wires and durable molded rubber
- For use on vehicles and trailers with two-wire systems



7-WAY RV BLADE ADAPTER HARNESS

- Adapts 7-way RV blade vehicle socket to fit 4-way flat trailer plugs
- UV-resistant coiled cable extends up to 5' without scraping the ground
- Simple plug-and-play design



No splicing or cutting



7-WAY RV BLADE PLUG & SOCKET

- Concealed terminals help ensure a reliable connection
- Splices into existing vehicle or trailer wiring
- Wires not included



7-WAY RV BLADE CONNECTOR TESTER

- Tests 7-way RV blade for tail, brake, reverse, turn signals, brakes and auxiliary power
- Confirms proper function of vehicle-side wiring connector
- Constructed with LED lights for long-lasting use

TOWING ELECTRICAL DEALER PROFIT PROGRAM

CURT Part#	Description	Location	Packaging	Qty.	Dealer Price	Program
52028	Breakaway kit, SoftTrac II	--	Packaged	2		
52044	Breakaway kit, push-to-test	--	Packaged	2		
52010	Breakaway switch, nylon	--	Bulk	4		
52023	Battery, 5.4 amp, rechargeable	--	Bulk	4		
56070	Custom wiring extension harness	Vehicle end	Packaged	6		
56601	Replacement harness, 6', 7-way RV blade	Trailer end	Bulk	4		
56603	Replacement harness, 10', 7-way RV blade	Trailer end	Bulk	2		
57271	Adapter harness, 5', 7-way RV blade to 4-flat	From vehicle to trailer	Packaged	2		
58355	Socket, 48" / Plug, 12", 4-way flat	Vehicle & trailer ends	Packaged	6		
58141	Plug, 7-way RV blade	Trailer end	Packaged	6		
58151	Socket, 7-way RV blade	Vehicle end	Packaged	6		
58271	Tester, connector	Vehicle end	Packaged	4		

RAMBLER™ STEEL TOW BAR DEALER PROFIT PROGRAM



AUTOMATIC, HANDS-FREE LOCKING MECHANISM

ACTIVE SLIDE RESISTANCE FOR ENHANCED CONTROL

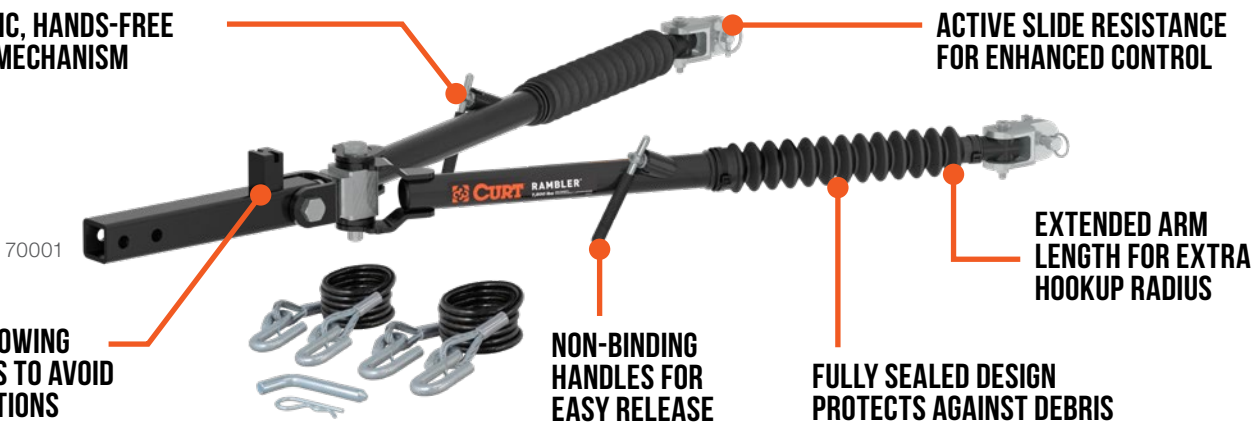

70001

THREE STOWING POSITIONS TO AVOID OBSTRUCTIONS

NON-BINDING HANDLES FOR EASY RELEASE

FULLY SEALED DESIGN PROTECTS AGAINST DEBRIS

EXTENDED ARM LENGTH FOR EXTRA HOOKUP RADIUS

UPGRADE YOUR TOW BAR

- Rigorous physical testing for proven safety and performance
- Polymer isolator washers reduce friction for smooth, anti-rattle operation
- Premium textured black finish for lasting corrosion and wear resistance
- Two hitch pin holes for adjustable length and added clearance as needed
- Compatible with CURT or Blue Ox® base plates (sold separately)

NON-BINDING LATCHES



Patent-pending, non-binding latches for easy release on uneven ground

THREE STOWING POSITIONS



Three stowing positions to avoid obstructions and maximize versatility

ONLY 40 LBS.



With a total weight of only 40 pounds, Rambler™ is easy to lift, carry and install

RAMBLER™ STEEL TOW BAR DEALER PROFIT PROGRAM



TOW BAR BASE PLATES

- Spreads towing forces equally for reduced stress on the vehicle frame
- Made with a vehicle-specific design for a custom fit
- Precisely welded for superior strength and fit
- Physically tested to gross vehicle weight rating (GVWR)
- Durable high-gloss black powder coat finish
- Co-cured in a rust-resistant liquid A-coat

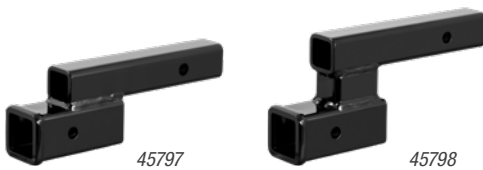

RECEIVER HITCH ADAPTERS

- Fits industry-standard 2" hitch receiver tubes and accepts 2" shanks
- Ideal for leveling a tow bar with vehicle base plates

RV HARNESES

- Connects a towed vehicle to an RV using a standard 4-way flat trailer plug
- Simple plug-and-play design eliminates the need for cutting or splicing
- Uses towed vehicle's existing taillights, brake lights and turn signals

FREE TOW BAR DISPLAY OPPORTUNITY

Purchase the qualifying dealer program dollar amount and receive a free tow bar display and header card.

Limited time offer - while supplies last. Limit one display per dealership. Minimum order to qualify. Free qualifying display is to be kept clean, visible to consumers in retail store, and showcase only CURT product.



99331-GC shown with 99334-GC sign

RAMBLER™ STEEL TOW BAR DEALER PROFIT PROGRAM

CURT Part#	Description	Capacity / Years	Qty.	Dealer Price	Program
70001	Rambler steel tow bar	7,500 lbs.	2		
70106	Base plates, Ford F-150	09 - 20	--		
70102	Base plates, Jeep Wrangler JK (excl Rubicon, special eds)	07 - 18	--		
70105	Base plates, Jeep Wrangler	18 - 19	--		
70110	Base plates, Jeep Wrangler JK (excl Std) Bumper)	07 - 18	--		
70101	Base plates, Dodge Durang / Jeep Grand Cherokee	11 - 13 / 11 - 16	--		
70108	Base plates, Chevrolet Equinox	18 - 20	--		
70107	Base plates, Chevrolet Colorado	15 - 20	--		
58970	RV Harness, F-150	--	--		
58903	RV Harness, Jeep Wrangler	--	--		
58964	RV Harness, Jeep Wrangler JL	--	--		
58907	RV Harness, Jeep Grand Cherokee	--	--		
58974	RV Harness, Chevrolet Equinox	--	--		
58910	RV Harness, Chevrolet Colorado	--	--		
45797	2" rise / drop receiver	7,500 lbs.	--		
45798	4" rise / drop receiver	7,500 lbs.	--		
99331-GC	Rambler floor display		1	FREE	FREE
99334-GC	Rambler display header card		1	FREE	FREE

CARGO & STRAP DEALER PROFIT PROGRAM



CARGO STRAPS

- Cambuckle mechanism allows for quick, direct tension on lighter loads
- Ratchet mechanism allows for greater tension on heavy loads
- High-strength, woven nylon
- Cinching components protected by a durable yellow zinc-plated finish



AUXILIARY LED INDICATOR LIGHTS

- Auxiliary indicator lights for increased safety on cargo carriers or bike racks
- Double row of LEDs in each strip correspond with brake, turn and running lights
- Industry-standard 4-way flat connector for quick installation
- Durable, waterproof construction for lasting weather resistance



Increases safety on cargo carriers



Versatile, stick-on adhesive backing

CARGO & STRAP DEALER PROFIT PROGRAM



18220



18221



18210 & 18211

CARGO BAGS

- Keeps cargo protected from water, dirt, wind damage and more
- Made from thick, 500 x 500 denier, UV-resistant vinyl
- Zippers feature large holes to accept a padlock
- Tie-down straps securely attach to cargo carrier frame
- Easily folds up for compact storage



18202

CARGO NETS

- Elastic netting provides better cargo security compared to bungee cords
- Attachment hooks feature holes for easy handling and installation

FREE PEG BOARD DISPLAY OPPORTUNITY

Purchase the qualifying dealer program dollar amount and receive a free peg board display.

Limited time offer - while supplies last. Limit one display per dealership. Minimum order to qualify. Free qualifying display is to be kept clean, visible to consumers in retail store, and showcase only CURT product.

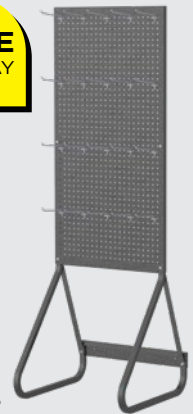

99193-GC

CARGO & STRAP DEALER PROFIT PROGRAM

CURT Part#	Description	Category	Qty.	Dealer Price	Program
83015	Cambuckle, 1" x 15' 900# - 2 pack	Tiedowns	6		
83016	Cambuckle, 1" x 16' 900# - 4 pack	Tiedowns	3		
83001	Ratchet, 1" x 10', 1500# - 2 pack	Tiedowns	6		
83002	Ratchet, 1" x 16', 1500# - 4 pack	Tiedowns	3		
83009	Ratchet, 1" x 10', 1500# - 2 pack	Tiedowns	3		
83010	Ratchet, 1" x 16', 1500# - 4 pack	Tiedowns	3		
83019	Ratchet, 1" x 16' 2200# - 1 pack	Tiedowns	3		
83020	Ratchet, 1" x 16', 2200# - 2 pack	Tiedowns	3		
83025	Ratchet, 1-1/16" x 16', 3300# - 1 pack	Tiedowns	3		
83026	Ratchet, 1-1/16" x 16', 3300# - 2 pack	Tiedowns	3		
83027	Ratchet, 1-1/16" x 16', 3300# - 1 pack	Tiedowns	3		
83028	Ratchet, 1-1/16" x 16', 3300# - 2 pack	Tiedowns	3		
83036	Ratchet, 1-1/2" x 14', 5000# - 1 pack	Tiedowns	3		
83047	Ratchet, 2" x 27', 10000# - 1 pack	Tiedowns	3		
83048	Ratchet, 2" x 27', 10000# - 1 pack	Tiedowns	3		
18202	Cargo net, fits up to 60" wide carriers	Cargo Nets	2		
18200	Cargo net, fits roof rack cargo carriers	Cargo Nets	2		
53201	Auxiliary LED indicator light kit	Lights	9		
18210	Cargo carrier bag, 56" x 18" x 21"	Cargo Bags	2		
18211	Cargo carrier bag, 56" x 22" x 21"	Cargo Bags	2		
18220	Roof rack cargo carrier bag, 38" x 34" x 18"	Cargo Bags	1		
18221	Roof rack cargo carrier bag, 59" x 34" x 18"	Cargo Bags	1		
99193-GC	Pegboard floor display		1	FREE	FREE

WE MAKE IT EASY. YOU MAKE THE SALE.

Lippert provides you with must-have products and all the necessary materials to create one-of-a-kind product planograms and displays. When you purchase a qualifying assortment of specific product lines, we provide you with print collateral that will be sure to push the product from the display to the register.



Solid Step® and Entry Door Upgrade Showroom Display



Solera® Dealer Modular Showroom Display



CURT 5th Wheel Display

Limited time offer - while supplies last. Limit one display per dealership. Free qualifying display is to be kept clean, visible to consumers in retail store, and showcase only Lippert product. Displays subject to change.

ONE-OF-A-KIND DISPLAYS.

Looking for a unique way to display your product to customers? Look no further. We provide you with the newest, cost-effective and space saving ways to beautifully display product out on your showroom floor.



Tongue Jack Display



Trailair® Pin Box Display



Thomas Payne® Showroom Display

Limited time offer - while supplies last. Limit one display per dealership. Free qualifying display is to be kept clean, visible to consumers in retail store, and showcase only Lippert product. Displays subject to change.

SMALL FOOTPRINT. BIG SALES.

These unique upright spider banners are easy to setup, move around, take up minimal floor space and give your customers the low down on the products you carry. Place one of the Ground Control banners in your service waiting area to let your customers know you have leveling upgrades, or place a Thomas Payne Furniture banner at the entrance of your showroom to let customers know you offer furniture.



Ground Control® Spider Banner



Solera® Universal Replacement Fabrics Spider Banner



Thomas Payne® Spider Banner

Limited time offer - while supplies last. Limit one display per dealership. Free qualifying display is to be kept clean, visible to consumers in retail store, and showcase only Lippert product. Displays subject to change.

GET ONE MORE SALE.

Our counter displays work to make one last sale at the register. An extra moment to sell a product as you ring up a customer can create an impulsive up-sell opportunity. Our counter displays store the product in a presentable and easily accessible way so your customers get what they need right at the counter.



Sway Command®
Counter Display



BetterWeigh™ Counter Display (99293-GC)
with 12 BetterWeigh™ retail packages (not included)



Chassis Shield®
and KwikLube Can
Counter Display



360 Siphon®
Counter Display

Limited time offer - while supplies last. Limit one display per dealership. Free qualifying display is to be kept clean, visible to consumers in retail store, and showcase only Lippert product. Displays subject to change.

NOT YOUR TYPICAL BROWN BOX.

Our in-house design team creates Lippert branded packaging that presents our products in eye-catching, shelf-ready boxes that will attract your customers.



IN-STORE MARKETING

Limited time offer - while supplies last. Limit one display per dealership. Free qualifying display is to be kept clean, visible to consumers in retail store, and showcase only LCI product. Displays subject to change.

EYE-CATCHING PRODUCT PACKAGING.

Lippert branded packaging lets your customers know what product they are going to invest their hard earned money on. Our product packaging clearly lists the features, benefits, and quick hitting facts all while looking great.



Limited time offer - while supplies last. Limit one display per dealership. Free qualifying display is to be kept clean, visible to consumers in retail store, and showcase only LCI product. Displays subject to change.

Learn more about RV furniture we have.