

KISAE

Abso Charger

12V 20A (AC1220)

12V 40A (AC1240)

12V 60A (AC1260)

Owner's Manual



1. INTRODUCTION

Thank you for purchasing the KISAE Abso Charger. With our state of the art, easy to use design, this product will offer you reliable service by providing a multi-stage multi-bank battery charger to charge different types of batteries you have installed in your boat, RV, vehicle or your cabin battery bank.

This manual will explain how to use this unit safely and effectively. Please read and follow these instructions and precautions carefully.

IMPORTANT SAFETY INFORMATION

This section contains important safety information for the KISAE Abso Charger. Each time, before using the unit, READ ALL instructions and cautionary markings on or provided with the unit, and all appropriate sections of this guide.

The KISAE Abso Charger contains no user-serviceable parts. See Warranty section for how to handle product issues.

WARNING: FIRE AND/OR CHEMICAL BURN HAZARD

Do not cover or obstruct any air vent openings and/or install in a zero-clearance compartment.

WARNING: FAILURE TO FOLLOW THESE INSTRUCTIONS CAN RESULT IN DEATH OR SERIOUS INJURY. KEEP AWAY FROM CHILDREN!

- When working with electrical equipment or lead acid batteries, have someone nearby in case of an emergency.
- Study and follow all the battery manufacturer's specific precautions when installing, using and servicing the battery connected to the charger.
- Wear eye protection and gloves.
- Avoid touching your eyes while using this unit.
- Keep fresh water and soap on hand in the event battery acid comes in contact with eyes. If this occurs, cleanse right away with soap and water for a minimum of 15 minutes and seek medical attention.
- Batteries produce explosive gases. **DO NOT** smoke or have an open spark or fire near the system.
- Keep unit away from moist or damp areas. Never expose unit to snow, water etc.
- Avoid dropping any metal tool or object on the battery. Doing so could create a spark or short circuit which goes through the battery or another electrical tool that may create an explosion.

WARNING: Explosion hazard!

- DO NOT use the unit in the vicinity of flammable fumes or gases (such as propane tanks or large engines).
- AVOID covering the ventilation openings. Always operate unit in an open area.

FCC INFORMATION

This equipment has been tested and found to comply with the limits for a Class B digital device, pursuant to part 15 of the FCC Rules. These limits are designed to provide reasonable protection against harmful interference in a residential installation. This equipment generate, uses and can radiate radio frequency energy and, if not installed and used in accordance with the instructions, may cause harmful interference to radio communications. However, there is no guarantee that interference will not occur in a particular installation. If this equipment does cause harmful interference to radio or television reception, which can be determined by turning the equipment off and on, the user is encouraged to try to correct the interference by one or more of the following measures:

- Reorient or relocate the receiving antenna.
- Increase the separation between the equipment and the receiver.
- Connect the equipment into an outlet on a circuit different from that to which the receiver is connected.
- Consult the dealer or an experienced radio/TV technician for help.

LIMITATIONS ON USE

Do not use in connection with life support systems or other medical equipment or devices.

2. PRODUCT DESCRIPTION

The KISAE Abso Charger includes the items list below.

- Base unit (AC1220 or AC1240 or AC1260)
- Owner's manual (P/N: MU IC1210)

3. UNDERSTANDING THE UNIT

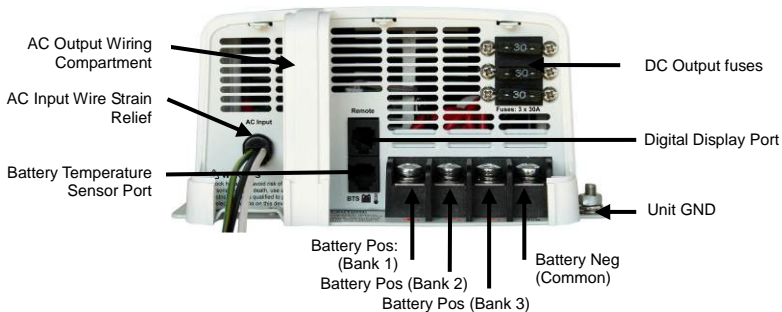

Typical wiring block diagram of the Battery Charger with 3 batteries bank:

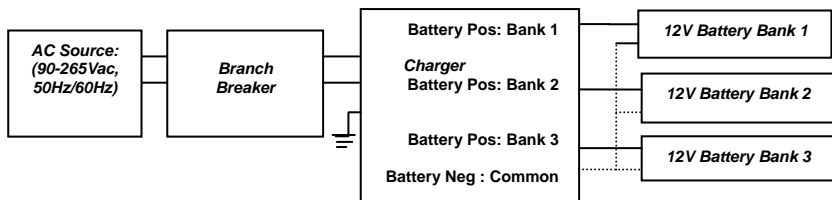

Battery Bank 1, _2, _3:

- The charger can charge four different types of batteries (GEL, AGM, Flooded and Lithium) and each battery bank can have its own bulk, absorption and float current setting.
- By setting the battery type to 'Program', the charger will act as a power supply and can provide power to Bank_1 only. Bank_2 and Bank_3 are disabled.

Branch Breaker:

For AC Input hardwire charging systems, it is required to use a 15A branch breaker to connect between the AC source and the charger AC input.

AC Source:

The charger accepts full universal input voltage (90-265Vac, 47-63Hz).

Digital Display Port:

Use for external display

The interface port is used for connecting an optional external display. The external display has identical functions to the built-in display.

Use for PC interface

- A KISAE Abso Charger PC Interface Kit (sold separately) is available and is used to connect between the port and the PC. This can be used to monitor and make changes to the charger settings.
- Full details of the KISAE Abso Charger PC Interface Kit

Battery Temperature Sensor Port:

CAUTION: RISK OF BATTERY DAMAGE. If temperature sensor is not being used, never set the battery temperature lower than the actual temperature. This may overcharge and damage

the battery.

- A KISAE Abso Charger Temperature Sensor (sold separately) is available and is used to connect to one of the battery terminals. It measures the battery temperature and will make small adjustments to the battery charging voltage for better battery charging performance.
- If the temperature sensor is not used, you can also manually set the charger to Low, Normal, or High to reflect the environmental temperature for better charging effect. See more details on **Understanding the Battery Temperature Function** in Section 5.

Digital Display:

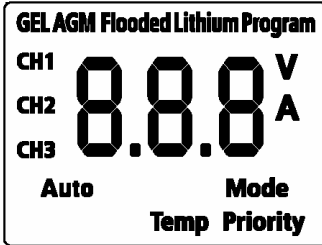

- ‘CH1’, ‘CH2’ and ‘CH3’ represent Battery Bank 1, 2 and 3 respectively. With individual icon turned ON, the numerical value on the display shows individual battery information like battery voltage in ‘V’ or charging current in ‘A’.
- ‘GEL’, ‘AGM’, ‘Flooded’, ‘Lithium’ and ‘Program’ represent different battery types setting.
- ‘Auto’ indicates silent mode is activated.
- ‘Priority’ indicates priority battery bank charging is activated

- ‘Mode’ only turns on during the setting of charging stage (Mode 2 – 2 stage: Bulk and Absorption mode only, or Mode 3 – 3-stage: Bulk, Absorption and Float charging).
- ‘Temp’ only turns on during the setting of battery temperature.

Battery Charger Voltage:

Battery Type	Absorption	Float	Equalization
GEL	14.2 V	13.8 V	N.A.
AGM	14.3 V	13.4 V	N.A.
Flooded	14.4 V	13.5 V	16.0 V <i>(See Note1)</i>
Lithium	Constant 14.2 V, 14.3 V, 14.4 V <i>(See Note2)</i>		N.A
Program (Power Supply)	Constant 13.3 V, 13.5 V, 13.7 V <i>(See Note3)</i>		N.A

*Note 1: Equalization setting can only be used on flooded battery type selection only. See more details on **Procedure to Equalize the Flooded Battery**.*

Note 2: Charger will terminate charging when charging current drop to below the set charger termination value.

Note 3: Charger is acting as a power supply with selected constant output voltage and preset maximum output current. With this setting, only Bank 1 can be used, Bank 2 and 2 is disabled.

Battery Bank Size Recommendation:

The battery charging current rating is based on the battery size. Each battery bank should meet the minimum Ah rating as shown. If a smaller size battery bank is used, set the current rating to lower value to match with the battery bank size. Normally, the minimum battery bank capacity is based on twice the charger current rating.

AC 1220		AC 1240		AC1260	
Current Setting	Battery Capacity	Current Setting	Battery Capacity	Current Setting	Battery Capacity
5A	Min 10Ah	5A	Min 10Ah	5A	Min 10Ah
10A	Min 20Ah	10A	Min 20Ah	20A	Min 40Ah
15A	Min 30Ah	20A	Min 40Ah	40A	Min 80Ah
20A	Min 40Ah	40A	Min 80Ah	60A	Min 120Ah

4. INSTALLING THE CHARGER

WARNING: KISAE Technology recommends that all wiring be done by a certified technician or electrician to ensure adherence to the applicable electrical safety wiring regulations and installation codes. Failure to follow these instructions can damage the unit and could also result in personal injury or loss of life.

CAUTION: Before beginning your unit installation, please consider the following:

- The unit should be used or stored in an indoor area away from direct sunlight, heat, moisture or conductive contaminants.
- When placing the unit, allow a minimum of three inches of space around the unit for optimal ventilation.

Note: The KISAE Abso Charger is designed to be permanently mounted.

Mounting the Charger:

- Choose an appropriate mounting location.
- For installing in an indoor location, the unit can be mounted in any direction.
- For installing in boat or marine environment, the unit can be mounted horizontally and vertically (AC and DC panel facing downwards) only.
- Use the mounting template below to mark the positions of the mounting screws.
- Drill the 4 mounting holes and place the Charger in position and fasten the unit to the mounting surface. See mounting location as below.

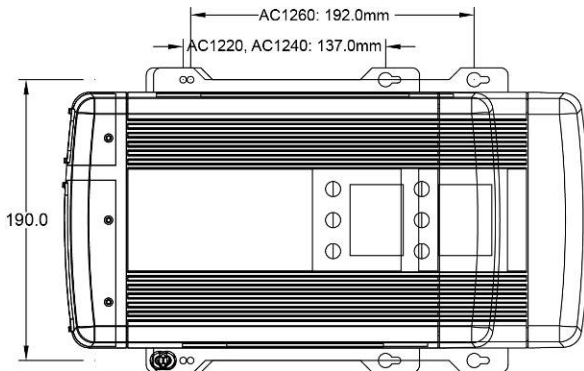

Chassis Grounding Connection:

DANGER: The unit chassis has to be grounded properly. Never operate the Charger without proper grounding. Failure to do so will result in death or serious injury. Ground connection to the charger must comply with all local and application-specific codes and ordinances.

- Connect the unit's chassis ground to the common ground point through the ground stud located near one of the unit mounting slots. See image in Section 3.

DC Output Wiring:

WARNING: The DC wiring used must be of appropriate size. An individual over-current protection device usually within 7 inches (17.8cm) of each battery bank is required. A DC disconnect switch is also recommended. Both devices must be rated for DC voltage and current and be rated to withstand the short circuit current available from the connected battery bank. Both devices must match with the size of the DC wiring.

Recommended Cable Length, Size and Required Fuse Size:

Wire Length	Wire Size (AWG/mm ²) - Fuse Size (A)		
	AC 1220	AC1240	AC1260
5' (1.5 m)	#10 / 5.3mm ² – 30A	#8 / 8.4mm ² – 50A	#6 / 13.3mm ² – 80A
7.5' (2.2m)	#10 / 5.3mm ² – 30A	#6 / 13.3mm ² – 80A	#4 / 21.2mm ² – 100A

20' (6m)	#6 / 13.3mm ² – 80A	#2 / 33.6mm ² – 125A	#1 / 42.4mm ² – 150A
----------	--------------------------------	---------------------------------	---------------------------------

- Remove the DC compartment cover by removing the two screws located on the top surface of the unit near the AC wiring compartment.
- Keep the connection between the battery and the charger as short as possible.
- Connect one end of the positive wire (red wire) to the Bank_1 of charger positive terminal with torque 4.0 ~ 5.0 N-m (35 ~ 45 lb-in) and the other end to the over current protection device, then the DC disconnect device. Do not over tighten as this may result in damage to the charger.
- Connect another wire from the DC disconnect device to the battery bank.
- For systems with multi-battery banks: Follow the same instruction as on Bank_1 and connect to Bank 2 & 3 accordingly.
- Prepare the negative wire (black wire) and connect to the negative terminal of the charger. Connect the other end of the negative wire to all the negative terminals of the battery bank(s).
- Place the DC Compartment cover back to the original position and secure the cover using the two screws provided.

AC Input Wiring:

WARNING: The AC wiring must be of appropriate size, and it must be protected by an appropriate branch breaker (not provided) connected between the AC source and the Charger. A three color coded #14 AWG wire (L, N and GND) with a rated minimum of 75°C wire and a minimum 12 inches in length must be used.

Before connecting AC wiring, make sure the AC source is OFF.

- Remove AC compartment cover by unscrewing the two screws located at the top of the AC compartment cover.
- Remove the top section of the AC Input wire strain relief located at the bottom of the base panel inside the AC wiring compartment by unscrewing the two strain relief mounting screws.
- Use the provided butt-splices to extend the AC Input wires (L, N & GND) to the customer-provided chosen AC wire.
- Feed the extended AC Input wire through the strain relief located at the bottom of the unit's base panel.
- Place the top section of the strain relief back to the original position and secure the AC extended wire by using the strain relief and secure with the two screws provided.
- Connect the other end of the extended AC wire to the chosen branch breaker and connect it to the AC power source. Please verify all the connections from Charger AC Live wire (black color) to Black AC extended wire, Charger AC Neutral (white color) to White AC extended wire and AC Charger green wire to AC extended green wire.

Optional Remote Display Connection:

- To install the optional Remote Display in a specific location, a 6 pin standard RJ12 cable (maximum length 25 ft) is required.
- Install the standard RJ12 cable in your desired location.
- Connect one end of the RJ12 cable to the Interface Port and the other end of the cable to the Display Panel. Please note polarity.
- The Remote Display is now ready for use.

Optional Temperature Sensor Connection:

- To install the temperature sensor, simply connect the RJ12 plug from the sensor to the RJ12 Temperature Sensor Port located near the Interface Port.
- On the temperature sensor ends, simply connect the ring terminals to the negative terminal of one of the battery banks.

Test the Charger Connection:

- Switch AC branch breaker switch to ON.
- The display will turn on. Pressing the 'Info' key will toggle the display to show the factory default setting. The charger is now ready to use.

5. UNIT OPERATION

Understanding the Charger

The charger is a three bank battery charger that is capable of charging three battery banks individually. The three battery banks must be the same battery type.

For the charging mechanism, if more than one bank is connected to the charger, the charger will charge each individual bank continuously for 15 minutes and then switch to the different bank(s) and cycle until all battery banks reach float mode. Once all battery banks reach float mode, all the banks are connected in parallel through a separation diode and will be charged together. The maximum current the charger can provide during the float mode is about ½ the maximum current rating of the charger.

For charging GEL, AGM and Flooded batteries:

- The charger can be set to 2 stage (Bulk and Absorption mode) or 3 stage (Bulk, Absorption and Float mode) charging.
- Each battery bank can have its own maximum charging current and absorption to float mode current settings.

For charging Lithium batteries:

Each battery bank can have its own maximum charging current and termination current setting. The charger process will terminate when the charging current drops to the set termination current.

For using charger as Power Supply (Program setting):

The charger can be used as a constant voltage power supply that will deliver the preset output voltage (13.3, 13.5, 13.7 V) with the maximum current setting. With this setting, only Bank 1 can be used and the other banks are disabled.

Understanding the Display during Operation:

During normal operation that include normal charging, priority charging and silent charging, the numerical section on the display show battery voltage (e.g. 12.5V), charging current (e.g. 60A) and charging stage (e.g. 'bul' – Bulk stage, 'abs' – Absorption stage, 'flo' – Float stage) alternatively.

During equalization operation on flooded battery, the numerical section on the display show a flashing 'eq' indicate the equalization process is in progress and it will not show the battery voltage or the charging current.

Understanding the Unit 'INFO', 'NEXT' and 'SET' Button Functions:



To change charger setting,

- Press and hold 'INFO' key for longer than 3 seconds to enter charger setting mode and shows function setting.
- Press 'NEXT' key once to save the setting and change the display to display different setting.
- Press 'SET' key to select the displayed function.
- Once new setting is done, press 'INFO' again for longer than 3 seconds to exit the charger setting mode.

Understanding the Three-Stage (Mode 3) Charging:

The Three-Stage Charging (Mode 3) has a Bulk, then Absorption and then Float sequence.

During the Bulk stage, the battery accepts the maximum constant current from the charger. In the Absorption stage, the battery voltage is held to constant voltage and the charging current will slowly reduce. In Float stage, the charger continuously produces voltage at a lower level to fully top up and maintain the battery in a fully charged stage.

The charger will automatically restart the charging cycle in Bulk stage if the battery is discharged to 12.5V. Also, after seven days, the charger will automatically restart the recharging cycle to refresh the battery.

Understanding the Two-Stage (Mode 2) Charging:

The Two-Stage charging is similar to the Three-Stage charging except there is no float stage after the absorption stage. The charger will terminate the battery charging after Absorption. After seven days, the charger will automatically restart the charging cycle to refresh the battery.

The charger will automatically restart the charging cycle in Bulk stage if the battery is discharged to 12.5V. Also, after seven days, the charger will automatically restart the recharging cycle to refresh the battery.

Understanding the Battery Temperature Functions:

Optional Battery Temperature Sensor KISAE Part Number #BTS-10K is highly recommended with the charger to protect your battery and provide better charging voltage accuracy. The battery temperature sensor senses the battery temperature and makes small adjustments to the charging voltage. If the battery sensor is not in use or not available, you can manually set the battery temperature. There are three manual battery temperature settings on the unit. The battery temperature sensor will override the manual setting when the sensor is used. See below for voltage adjustments for temperature compensation.

Temperature Setting	Recommended for Battery Temperature	Battery Type	Voltage adjustment from 25°C normal setting
Low (Lo)	<5°C (41°F)	GEL, Flooded	0.675 V
		AGM	0.525 V
Normal (nor)	>5°C and <30°C (>41°F and <86°F)	GEL, Flooded	0 V
		AGM	0 V
High (HI)	>30°C (86°F)	GEL, Flooded	-0.27 V
		AGM	-0.21 V

Procedure to set or view charger setting:

Follow the procedure or sequence in Appendix A to set or view the charger setting.

GEL, AGM or Flooded battery type:

Parameters below are required for setting:

- Battery type (GEL, AGM, Flooded)
- Charging stage (3-stage , 2-stage)
- Battery temperature (low, normal, high temperature)
- Maximum Current setting (see table below)
- Absorption to float mode current setting (see table below)

The following table shows the maximum available charging current and its related available Absorption to Float Mode current.

Model	Maximum Current Setting	Absorption to Float Mode Current Setting
AC 1220	* 20A	* 1A / 2A / 4A
	15A	0.75A / 1.5A / 3A
	10A	0.5A / 1A / 2A
	5A	0.3A / 0.5A / 1A
AC 1240	* 40A	* 2A / 4A / 8A
	20A	1A / 2A / 4A
	10A	0.5A / 1A / 2A
	5A	0.3A / 0.5A / 1A
AC 1260	* 60A	* 3A / 6A / 12A
	40A	2A / 4A / 8A
	20A	1A / 2A / 4A
	5A	0.3A / 0.5A / 1A

Note: * Recommended setting (Factory Default Setting)

Lithium battery type:

Parameters below are required for setting:

- Charging Voltage (14.2V, 14.3V, 14.4V)
- Maximum Charging Current (see table below)
- Termination Charging Current (current to define when the charging process will terminate)

The following table shows the available charging voltage, maximum charging current, and the available termination charging current.

Model	Charging Voltage	Maximum Charging Current	Termination Charging Current
AC 1220	14.2V / 14.3V / 14.4V	* 20A	* 1A / 2A / 4A
		15A	0.75A / 1.5A / 3A
		10A	0.5A / 1A / 2A
		5A	0.3A / 0.5A / 1A
AC 1240	14.2V / 14.3V / 14.4V	* 40A	* 2A / 4A / 8A
		20A	1A / 2A / 4A
		10A	0.5A / 1A / 2A
		5A	0.3A / 0.5A / 1A
AC 1260	14.2V / 14.3V / 14.4V	* 60A	* 3A / 6A / 12A
		40A	2A / 4A / 8A
		20A	1A / 2A / 4A
		5A	0.3A / 0.5A / 1A

Program (Power Supply) type:

Parameters below are required for setting:

- Supply Voltage 13.3, 13.5, 13.7 Vdc
- Maximum available current (see table)

The following table shows the programed voltage and the maximum current setting.

Model	Program Output Voltage Setting	Max. Current
AC 1220	13.3V/13.5V/13.7V	20A/15A/10A/5A
AC 1240	13.3V/13.5V/13.7V	40A/20A/10A/5A
AC 1260	13.3V/13.5V/13.7V	60A/40A/20A/5A

Procedure to Equalize Flooded Battery:

DANGER: Explosion Hazard. The battery generates explosive gases during equalization.

Follow all the battery safety precautions listed in the manual.

CAUTION: Risk of Battery and Equipment damage. Only the Flooded lead-acid can be equalized. Consult your battery manufacturer or read the battery manual when you try to equalize your batteries. Disconnect any DC load connected to the battery, as during equalize mode, the charger will produce 16V to the batteries. You must monitor the battery specific gravity throughout the equalization process to determine the end of the equalizing cycle.

Charge batteries in one full cycle before you start equalized the batteries. Check the battery electrolyte level. If necessary, refill with distilled water only. All cells should have similar electrolyte levels. If distilled water is added, batteries must undergo a complete charge cycle. The charger cannot determine when to terminate the equalization of the battery. A one hour time-out is set and this is used as a safety feature to require the user to continually re-activate it as necessary after checking batteries manually.

During equalization mode the other two banks are disabled.

Use the following procedure to setup the charger for battery equalization.

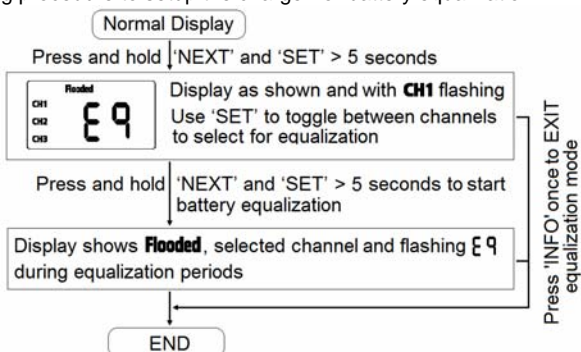

Understanding the Priority Bank Charging Function

The charger comes with a unique 'Priority' bank charging function that allows the user to force the charger to fully charge one of the three banks to float mode before it switches to other banks. This function will only work for GEL, AGM, Flooded, and Lithium battery type setting only.

To set this function, see **Appendix A** in details.

Once the chosen bank is charged to float stage, this function will turn off automatically and it will switch to charge the other 2 banks to float stage. Once all 3 banks reach float stage, the charger will start the float charging process together.

Tips: Only use this mode if you want to fully charge a specific bank as soon as possible.

Understanding the Auto Mode Function

The charger also comes with another unique 'Auto' mode function that reduced the fan speed and charger current automatically for a silent operation.

Tips: Use this function during night time or when a quiet environment is needed. Please also note that the charging time will increase in this mode because the charger is not running at maximum power.

This function can switch to ON or OFF at any time during the charging period.

To set this function, press and hold 'SET' button for 3 seconds to execute the 'Auto' mode. The 'Auto' icon will show on the display.

To turn this function off, press and hold the 'SET' function for 3 seconds to exit the 'Auto' mode. The 'Auto' icon on the display will turn off and the charger current and the fan speed will return to normal.

Understanding the Protection Features

De-rating Charging Current:

When the charger senses the environmental temperature is above 50°C, the maximum charger current will de-rate to 1/2 of the value. It will recover automatically back to maximum charging current when the environmental temperature drops to below 45°C. A02 warning code will display.

Over Temperature Shutdown:

When the charger senses the environmental temperature is above 60°C, the charger will shutdown. It will recover automatically when the environmental temperature drops to below 45°C.

Battery Reverse Polarity:

When a reverse polarity is connected to the battery bank, Fault Code E03 on display will appear. In some case, the user replaceable DC fuse located near the DC Output terminals may blow and Error code E08 will display.

AC Input Voltage Protection:

The charger will shutdown when it senses the AC input voltage is outside of the operating range. A fault code will display. The charger will recover automatically when it senses the AC input voltage has returned back to the normal operation range.

Charging Dead Battery

The charger is designed to charge batteries with terminal voltage greater than 2.5Vdc.

Understanding the Error Codes

Error codes will show on the display when either an internal fault such as *high internal temperature* or external fault like *AC input voltage out of range* is detected. The unit will shutdown.

Code	Condition	Corrective Action
A01	Temperature Sensor (BTS) is defective.	Check and or replace the sensor.
A02 with black lighting flashing	Inlet temperature is high >50°C (122°F) or ventilation of the unit is blocked charger will shutdown shortly.	Cool down the unit by reducing the charging current or improve the ventilation near the unit.

E01	Unit shutdown due to low AC Input (< 85 +/- 5Vac)	Check AC input source. The unit will automatically recover when the AC Input voltage return to > 108 +/-5Vac
E02	Unit shutdown due to high AC Input (>270 +/- 5Vac)	Check AC input source. The unit will automatically recover when the AC Input voltage return to < 260 +/-5Vac
E03	Battery is connected backwards	Check all battery connections
E04	Charger Internal temperature is too high and unit has shutdown. Unit will automatically recover when the unit cools down.	The ventilation of the unit is blocked or the environmental temperature is high. Reduce charging current or improve the ventilation near the unit.
E05	Inlet temperature is high >60°C (140°F) and unit has shutdown. Unit will automatically recover when inlet temperature is reduced to <45°C (113°F).	Check environmental temperature. Improve the ventilation around the unit.
E06	High battery temperature >70 °C (158°C) is sensed by the BTS. The unit will shutdown. Unit will automatically recover when battery temperature has reduced to 60°C (140°F).	Check battery, charger setting and the environment the charger is in.
E07	Low battery temperature < -25°C (-13°F) is sensed by the BTS. The unit will shutdown. Unit will automatically recover when battery temperature reaches -20°C (-4°F).	It is not recommended to charge the battery at extreme low temperatures.
E08	DC Output fuses are brown.	Check battery connection and replace fuse with the same type and rating.
E09	Unit shutdown due to high battery voltage (> 17Vdc). Unit will automatically recover when battery temperature reduced to 16Vdc.	Check battery and charger setting. Check also if there is any other DC supply connected to the battery banks.

6. SPECIFICATIONS

Note: Specifications are subject to change without notices.

Charger Output:	AC 1220 / AC 1240 / AC 1260
Output Current (Maximum)	20A / 40A / 60A
Output Voltage Range	
Charge	14.2 - 15.5 V
Float	13.4 - 13.8 V
Equalize	16.0 V
Charging Control	Three stages (Bulk/Absorption/Float) Two stages (Bulk/Absorption) Constant Power Supply (Program setting)
DC Output Bank	Three
Selectable Battery Type	Gel, AGM, Flooded, Lithium, Program
Parasitic Current	< 2 mA
Charger Input:	
AC Input Voltage (Nominal)	100, 120, 220, 230, 240 VAC
AC Input Operating Range	90 - 265 VAC
AC Input Frequency Range	47 - 63 Hz
Power Consumption (Full Load)	350W / 700W / 1050W
Power Factor Correction	Yes
Charger Efficiency	> 82%
Protection and Features:	
Reverse Battery	Yes, unit shutdown
Over Charge	Yes, unit shutdown
Over Temperature	Yes, unit de-rated and shutdown
Output Short Circuit	Yes, unit shutdown
DC Fuse	2*15A, 32V / 2*30A,32V / 3*30A,32V
Cooling	Force air ventilation
Temperature Setting	Hot, Normal, Cold (no sensor connected)
Battery Temperature Sensor Port	RJ12 (optional battery sensor use)
Digital Display Port	RJ12 (optional display panel use)
Display:	
LCD Display (with back lighting)	Charging status, Battery Voltage
Warning and Fault Code	A01-02, E01-09
Digital Display Port	RJ12, use with optional display panel
AC Input and DC Output Connection:	
AC Input Connection	Hardwire or AC Cord
DC Output Connection	Heavy Duty Studs (3 banks)
DC Output Ground	Single Heavy Duty Common Ground Stud
Environmental and Operating Temperature:	
Storage Range	-40° to 70° C (-40° to 158° F)
Operating Range	-20° to 60° C (-4° to 140° F)
Humidity	5-95%, RH non-condensing
Ingress Protection	IP32
Based Unit Weight and Dimensions:	
AC 1220	5.3 lb., 11.6 x 8.1 x 3.4 inches (2.4 Kg, 295 x 206 x 86 mm)
AC 1240	5.7 lb., 11.6 x 8.1 x 3.4 inches (2.6 Kg, 295 x 206 x 86 mm)

AC 1260

8.8 lb., 14 x 8.1 x 3.8 inches
(4.0 Kg, 356 x 206 x 99mm)

Regulatory Compliance:

Standards/Safety:

North America: Approved to UL1236 including the marine supplement
UL1564
CSA C22.2 107.2-01

European Union: CE marked for the low voltage directive 2006-95-EC,
Complying with EN60335-2-29 battery chargers;
Approved to IEC60529:2001, IP32 ingress protection level.

Standards/EMC

North America: Class B according to FCC part15B and ANSI C63.4

European: CE marked for the EMC directive 2004-108-EC
Complying with EN55014-1, EN55014-2, EN61000-3-2 and EN61000-3-3
(as equivalent IEC standards series)

Accessories (optional):

Remote Digital Display

For unit remote sensing

Battery Temperature Sensor

For battery temperature sensing

PC Interface & Software

For monitoring and feature setting through
PC USB port

Appendix A1

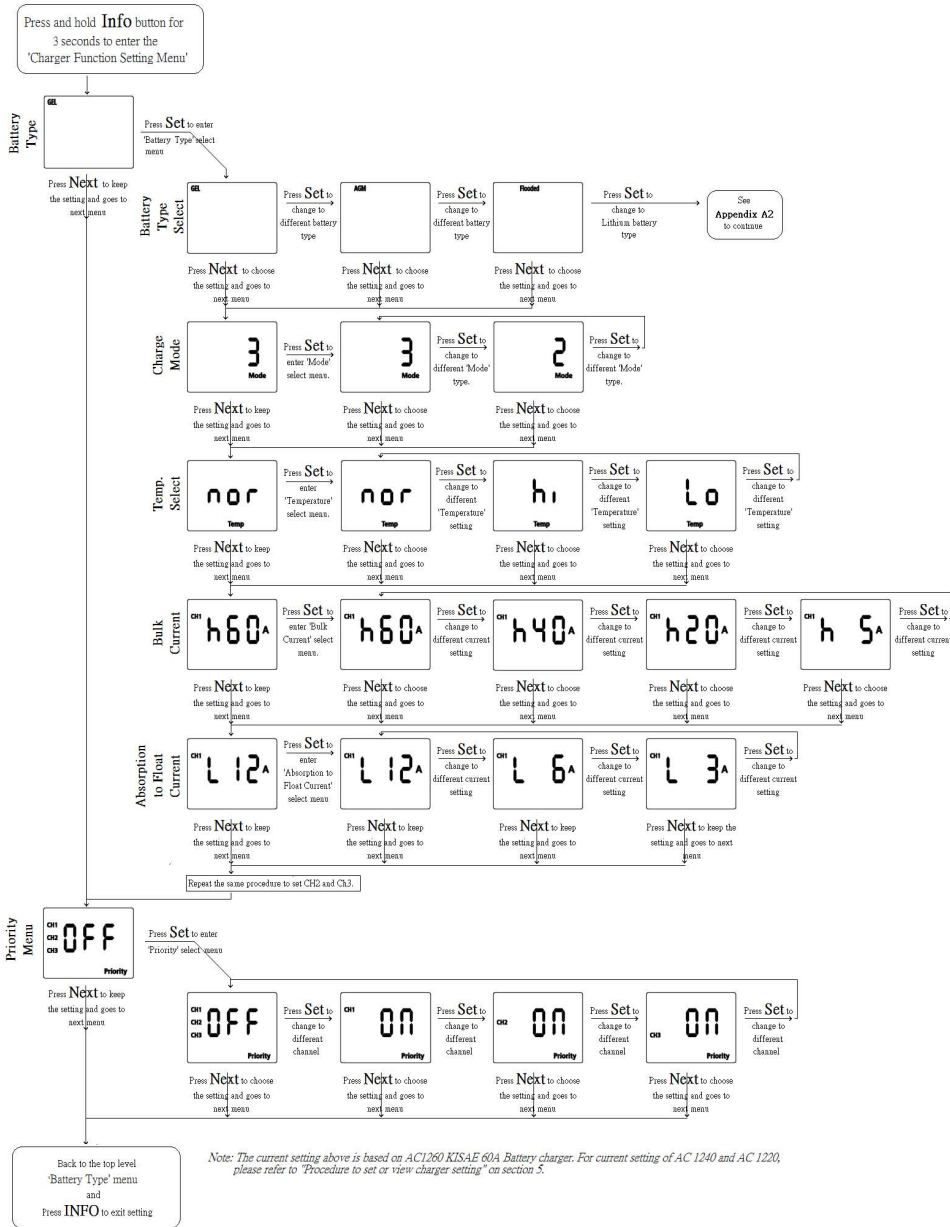

Appendix A2

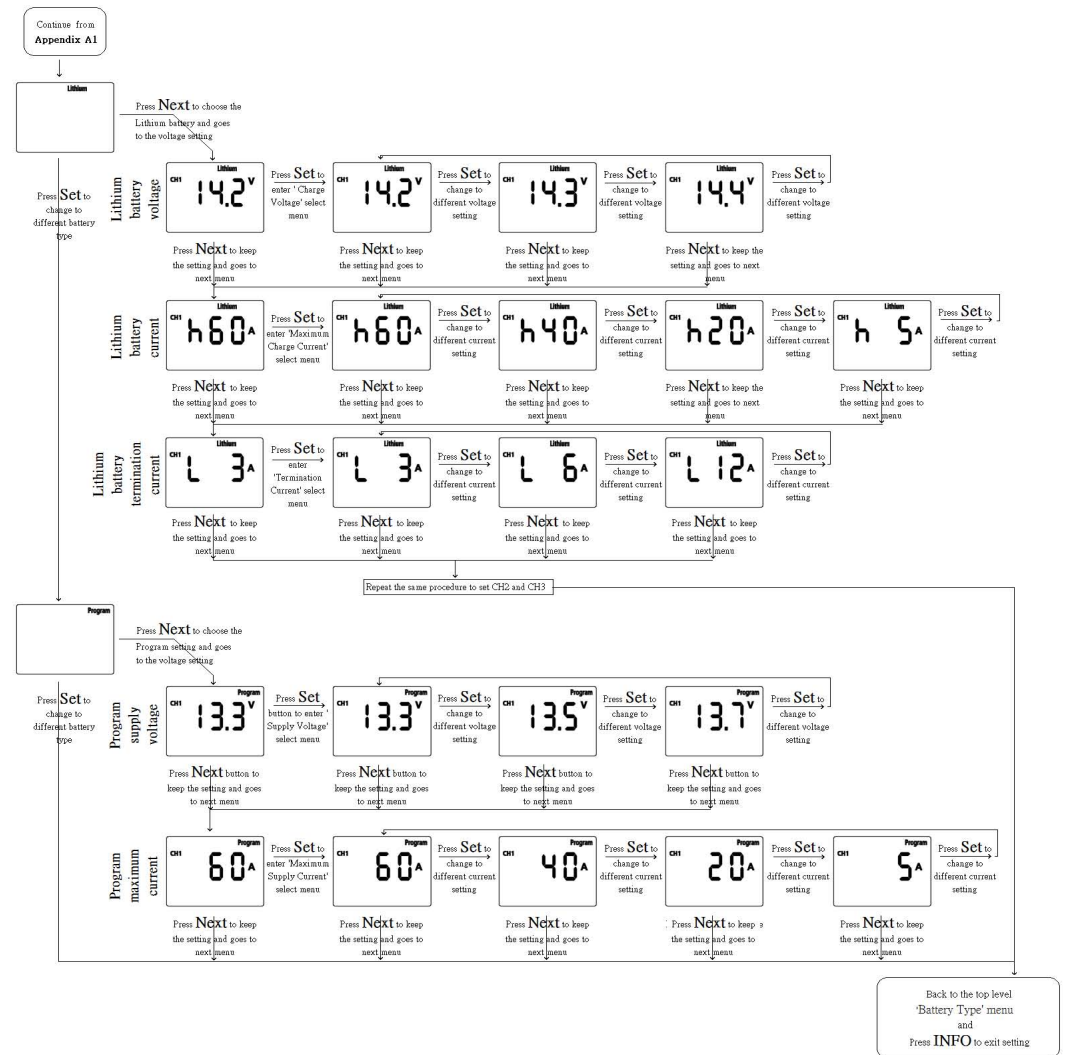

Note: The current setting above is based on AC1260 KISAE 60A Battery charger. For current setting of AC1240 and AC1220, please refer to 'Procedure to set or view charger setting' on section 5.