



Mobile Evaporative Cooler

1300 CFM

Use & Care Guide

MC18



General Safety Precautions



Read and follow all instructions, cautions and warnings. Failure to do so could result in personal injury, death or property damage.

Unit must be in **OFF** position and **UNPLUGGED** from power receptacle before performing any maintenance / service or before **REMOVING** access panels.

Make sure the electrical power source conforms to the requirement of the evaporative cooler as well as local codes.

To reduce risk of fire or electrical shock, do not expose electrical connections to water.

Do not touch electrically live components.

Ensure all power cords do not touch sharp edges, hot surfaces or chemicals. Immediately replace damaged parts.

Never leave unit unattended.

Continuous fill not to be used indoors or unattended.

Operation Tips

Hessaire coolers are highly recommended for outdoor use. If used indoors, position cooler in front of window or open door for fresh intake air. Ensure there is an open door or window through which the air can exhaust from the room.

Clean media pads and tank frequently.

When shutting down unit, run without pump for 30 minutes to properly dry media pads.

Prior to long term storage:
Drain tank and wipe clean
Dry and clean rigid media pads

Indoor Use:
Do Not Use Garden
Hose Attachment.

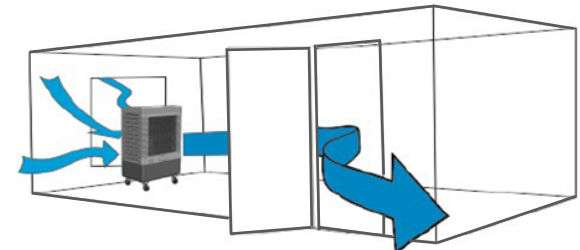

Inspection

After unpacking your cooler, carefully inspect for any damage that may have occurred during transit. Inspect for loose, missing or damaged parts. *Note: wheels & hose adapter are located on top of cooler upon opening box.*

Contents: Evaporative Cooler (1), Hose Adapter (1), Caster Wheels (4).

Visit Hessaire.com to request replacement parts if any of these items are missing.

Quick Start

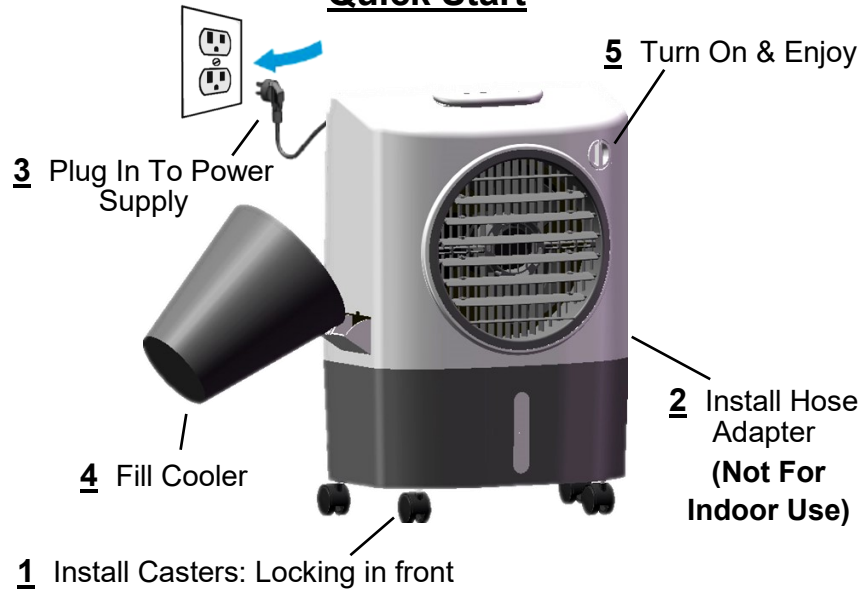

Note: Media pads may have a slight odor upon initial start up but will go away with continued use.

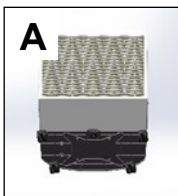

Lay Cooler Down

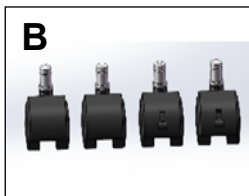

Gather Casters, Push In To Install

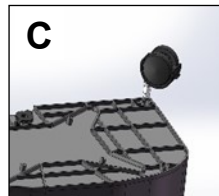

Features

Control Functions For MC18

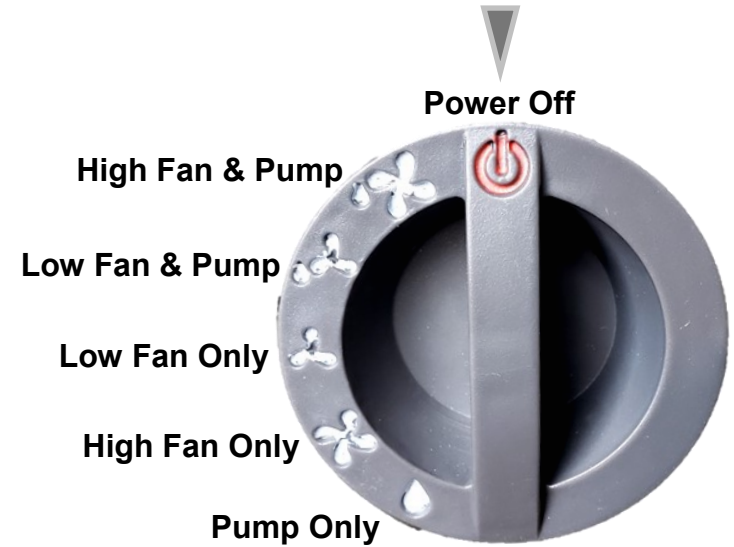

Convenient Carry Handle



Continuous Fill Option (not for indoor use)



Manual Fill Option

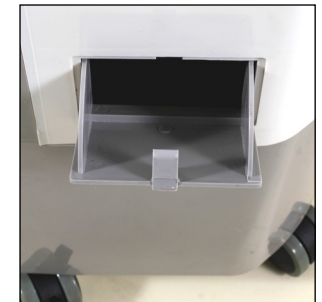

Maintenance

⚠ WARNING

Disconnect from power source before attempting any maintenance or routine service. NEVER remove any access panels while cooler is in operation. Failure to do so could lead to SERIOUS INJURY.

Cleaning Cooler & Rigid Media Pads:

The removable panel(s) & pads can be gently sprayed off to remove build up. A soft bristle brush can also be used.

NEVER spray pads with water while cooler is in operation. Damage can occur to the motor and will void the warranty.

Note: Vinegar is recommended for cleaning of cooler and can be periodically cycled through during normal use.

Removal Of Back Panel:

Disconnect power supply. Remove the two phillips screws from the upper back side of cooler.

Pull out top of back panel.

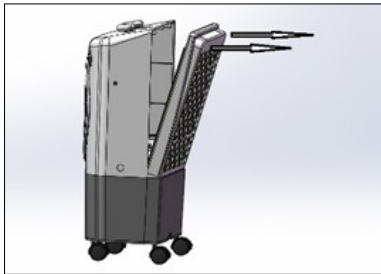

Removal Of Rigid Media:

Once back is removed, the media pads will be accessible.

Note: some pads may be held in place with pins (media keepers) which will need to be removed to free up the pads.

Storage:

Drain tank and wipe dry. Plug is located on bottom of cooler. Ensure pads are dry by running fan without pump for at least 30 minutes.

Visit Hessaire.com for additional maintenance tips and service videos.



Troubleshooting

Problem	Cause / Remedy
Cooler won't turn on	Ensure unit is plugged in and switched on. Receptacle breaker may need to be reset. If unit is equipped with a GFCI plug, reset. If unit has a timer, ensure it is off. May need new ON/OFF switch.
Fan will not operate	Ensure fan function is on. Make sure nothing is obstructing fan blade. Fan motor may need to be replaced. Fan switch may need to be replaced. Slow running - may need capacitor replaced.
Cooler does not pump	Ensure pump switch is turned on. Make sure water level is not low. Add water. Make sure hoses are connected and free of debris. Pump may need to be replaced. Pump switch may need to be replaced.
Swing does not work	Ensure swing switch is turned on. Make sure the linkage is connected. Oscillation switch may need to be replaced. Oscillation motor may need to be replaced.
Water leakage	Make sure drain plug is securely in place. Make sure cooler is level. Inspect tank for cracks. Check media pads for water running on outside of unit. Change pads if necessary. Check for leaks in water distribution hose connections. Check spreaders for build up causing spill over of water into the airstream.
Water level high or low	Adjust nut on float valve. Float valve may need to be replaced.

Cooler Parts

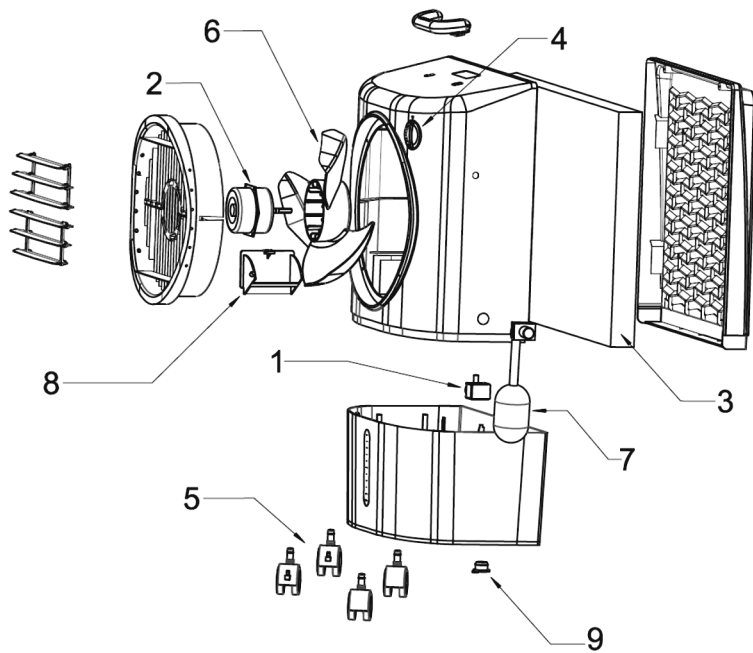

#	Parts	MC18
1	Pump	6017050
2	Motor	6017051
3	Rigid Media Panel	CP150
4	Control Knob & Switch	6017069
5	Caster Set (4 pcs)	6176100
6	Fan Blade	6017052
7	Float Valve Kit (float valve, hose adapter)	6018058
8	Manual fill door	6017076
9	Drain plug	6017081