

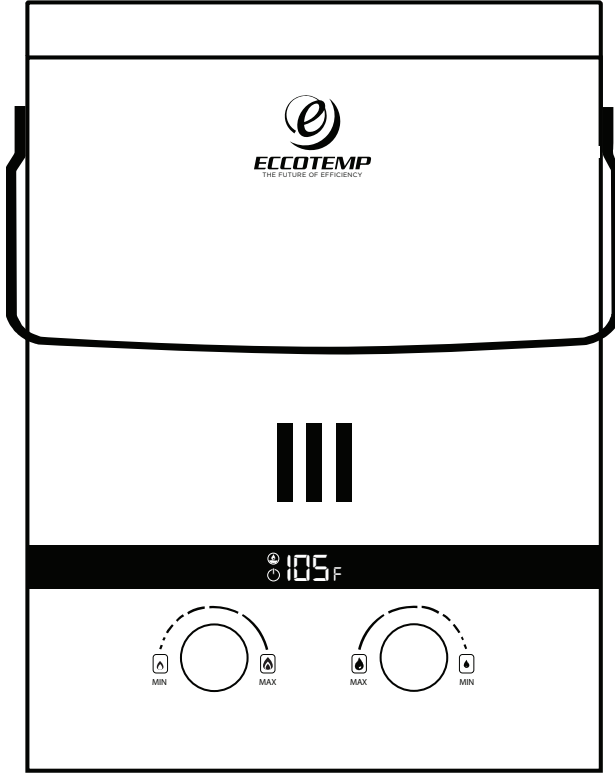

# EL5 Manual

PORTABLE TANKLESS WATER HEATER  
INSTALLATION, USE AND CARE INSTRUCTIONS



## RECREATIONAL USES



SHOWER



EQUESTRIAN



HUNTING



RECREATION



POOL SIDE



FOOD TRUCKS



PET BATHING



GREEN HOUSES



CAMPING



TINY HOMES



EMERGENCY PREP



OFF-GRID

# PLEASE RETAIN THIS INSTRUCTION MANUAL FOR FUTURE REFERENCE

 **WARNING**



**CARBON MONOXIDE HAZARD**  
This appliance can produce carbon monoxide which has no odor.

Using it in an enclosed space can kill you.  
Never use this appliance in an enclosed space such as a camper, tent, car or home.

 **CAUTION**



**Vapors from flammable liquids will explode and catch fire causing death or severe burns.**

**FOR YOUR SAFETY:**  
**Do not use or store flammable products such as gasoline, solvents or adhesives in the same room or near the water heater.**

Keep flammable products :

1. Far away from heater
2. In approved containers
3. Tightly closed
4. Out of children's reach

Water heater has a main burner flame.  
The main burner flame:

1. Can come on at any time and
2. Will ignite flammable vapors.

**Vapors:**

1. Cannot be seen
2. Are heavier than air
3. Go a long way on the floor
4. Can be carried from other rooms to the main burner flame by air currents.

**Installation:**  
Do not install water heater where flammable products will be stored or used unless the main burner flame is at least 18" above the floor. This will reduce, but not eliminate, the risk of vapors being ignited by the main burner flame.

Read and follow water heater warnings and Instructions. If owners manual is missing, contact the retailer or manufacturer.

 **CAUTION**

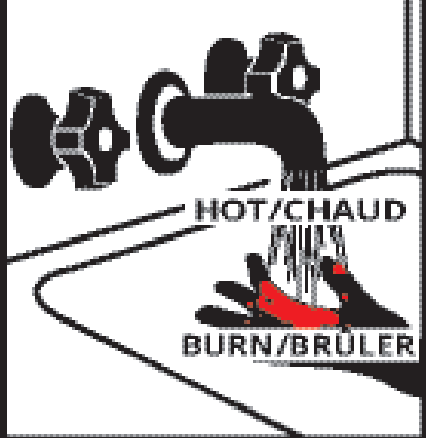

Water from pipes can reach 120°F (49°C) or more. Burns instantly and depth could be 1/2 inch. Disabled and elderly are at highest risk of being scalded. See instruction manual before setting temperature of water heater. Test water before bathing or showering. Temperature limiting valves are available, see manual.

 **WARNING**

Incorrect installation, use, adjustment, alteration, service or maintenance may cause injury or damage materials. Refer to this manual for a assistance or additional information consult a qualified installer, service agency or gas supplier.

 **WARNING**

**Fire or Explosion Hazard**  
Do not store or use gasoline or other flammable vapors and liquids in the vicinity of this or any other appliance.

# EL5 PORTABLE TANKLESS WATER HEATER

## Use & Care Manual

With Installation Instructions for the Installer

### Safety Information

Safety Precautions	3
Leak Testing	6
Combustion and Ventilation Air	6

### Installation Instructions

Benefits and Recommendations	7
Getting Started	8
Water and Gas Connections	8
Proper Installation	9

### Operating Instructions

Use and Operation	10
Adjustment	11
Functions and Features	12

### Maintenance

Rain Cap Inspection	13
Storage	13
Cleaning Water Screen	13
Flushing Water Heater	14

### Troubleshooting

Troubleshooting	15
Construction and Parts	17
Electrical Wiring	18
Replacement Parts	18

### Warranty

Warranty	19
----------	----

APPLICATION	INSTALLATION	BTU'S	FLOW RATE
Recreational	Outdoor	25,000-37,500	1.5 GPM

## CONGRATULATIONS!

You've just purchased a new Ecotemp EL5 portable tankless water heater. This will open a world of enjoyment to going tankless!

We highly suggest you take the time to read through all the safety and installation procedures in this manual before attempting to install your new tankless water heater.

### PLEASE RETAIN THE INSTRUCTION MANUAL FOR FUTURE REFERENCE

#### FOR YOUR RECORDS

Write your serial number here: # \_\_\_\_\_

You can find them on a label on the appliance and/or packaging. Staple sales slip or canceled check here. Proof of the original purchase date is needed to obtain service under the warranty.





#### READ THIS MANUAL

Inside you will find many helpful hints on how to use and maintain your water heater properly. A little preventive care on your part can save you time and money over the life of your water heater. You will find many answers to common problems in the Troubleshooting Guide. If you review the chart of Troubleshooting Tips first, you may not need to call for service.

#### READ THE SAFETY INFORMATION

Your safety and the safety of others are very important. There are many important safety messages in this manual and on your water heater. Always read and obey all safety messages. This is the safety alert symbol. Recognize this symbol as an indication of Important Safety Information! This symbol alerts you to potential hazards that can kill or hurt you and others.

All safety messages will follow the safety alert symbol and the words: "DANGER", "WARNING", "CAUTION" or "NOTICE". These words mean:

-  **WARNING** - A potentially hazardous situation that could result in death or serious injury and/or damage to property.
-  **DANGER** - An imminently hazardous situation that will result in death or serious injury.
-  **CAUTION** - A potentially hazardous situation that may result in minor or moderate injury.
-  **NOTICE** - Attention is called to observe a specified procedure or maintain a specific condition.

## **IMPORTANT SAFETY INFORMATION: READ ALL INSTRUCTIONS BEFORE USING**

Be sure to read and understand the entire Use and Care Manual before attempting to install or operate this water heater. It may save you time and money. Pay particular attention to the Safety Instructions. Failure to follow these warnings could result in serious bodily injury or death. Should you have problems understanding the instructions in this manual, or have any questions, STOP, and get help from a qualified service technician, or the local gas utility.

### **⚠ DANGER!**

---

#### **PROPERLY INSTALL WATER HEATER**

Failure to properly install the tankless water heater outdoors as outlined in the installation could result in injury.

Failure to follow instructions in this manual can result in unsafe operation of the water heater. To avoid the risk of fire, explosion, or asphyxiation from carbon monoxide, never operate this water heater unless it is installed properly and has an adequate air supply for proper operation. Be sure to inspect the attached rain cap for proper installation at initial start-up; and at least annually thereafter. Refer to the Care and Cleaning section of this manual for more information regarding rain cap inspection.

### **⚠ WARNING!**

---

Gasoline, as well as other flammable materials and liquids (adhesives, solvents, paint thinners etc.), and the vapors they produce are extremely dangerous. DO NOT handle, use or store gasoline or other flammable or combustible materials anywhere near or in the vicinity of a water heater or any other appliance. Be sure to read and follow the labels on the water heater, as well as the warnings printed in this manual. Failure to do so can result in property damage, bodily injury or death.

### **⚠ NOTICE!**

---

To ensure that this product is safe to use, Eccotemp has had this model tested and certified by CSA Group and it is marked CSA/ANSI Z21.96 - CSA 11.6 2020 Portable Water Heaters for Outdoor Use.

## **⚠ DANGER!**

### **LIQUIFIED PETROLEUM MODELS**

---

Liquid propane has an odorant added to aid in detecting a gas leak. Some people may not physically be able to smell or recognize this odorant. If you are unsure or unfamiliar with the smell of liquid propane, ask the gas supplier.

Other conditions, such as "odorant fade", which causes the odorant to diminish in intensity, can also hide or camouflage a gas leak. Always check with commercial leak detector or soapy water.

- Gas detectors are recommended in liquid propane applications and their installation should be in accordance with the detector manufacturer's recommendations and/or local laws, rules and regulations.
- Water heaters utilizing liquid propane gas are different from natural gas models. A natural gas water heater will not function safely on liquid propane gas and vice versa.
- No attempt should ever be made to convert the tankless water heater from liquid propane to natural gas. To avoid possible equipment damage, personal injury or fire, do not connect the water heater to a fuel type not in accordance with the portable tankless water heater data plate: propane for propane portable tankless water heaters and natural gas for natural gas portable tankless water heaters. These portable tankless water heaters are not certified for any other fuel type.
- Liquid propane gas must be used with great caution. It is heavier than air and will collect first in lower areas making it hard to detect at nose level.
- Before attempting to light the water heater, make sure to look and smell for gas leaks. Use a soapy solution to check all gas fittings and connections. Bubbling at a connection indicates a leak that must be corrected. When smelling to detect a gas leak, be sure to sniff near the floor also.
- It is recommended that more than one method, such as soapy solution, gas detectors, etc., be used to detect leaks in gas applications.

## **⚠ NOTICE!**

### **IF A GAS LEAK IS PRESENT OR SUSPECTED:**

---

- **DO NOT attempt to find the cause yourself.**
- **DO NOT try to light the water heater.**
- **DO NOT touch any electrical switch.**

## **⚠ ADDITIONAL WARNINGS!**

---

1. Do not leave unattended.
2. The exhaust gas and top of the portable tankless water heater is HOT! Do not place hands or any foreign object near the top of the heater.
3. Do not use in high wind conditions.
4. If the smell of gas is detected, turn off the gas valve at the tank immediately! Do not use flame for leak detection.
5. Use only liquid propane.
6. Use only outdoors.
7. Do not over tighten the gas regulator connection to the portable tankless water heater with a wrench. This may cause a crack in the gas regulator.

## Leak Testing

**⚠ WARNING: Never use an open flame to test for gas leaks, as property damage, personal injury, or death could result.**

The tankless water heater and its gas connections must be leak tested at normal operating pressures before it is placed in operation.

- Turn on the gas to the tankless water heater from the recommended gas cylinder.
- Use a commercial leak detector or soapy water solution to test for leaks at all connections and fittings.
- Bubbles indicate a gas leak that must be corrected.

The factory connections should also be leak tested after the tankless water heater is placed in operation cause water damage which may or may not be repairable.

## Pressure Relief Valve

A new pressure relief valve, complying with the standard for pressure relief valves and automatic gas shut-off Devices for Hot Water Supply Systems, ANSI Z21.22, must be installed at the hot water outlet connection of the tankless water heater at the time of installation. Local codes shall govern the installation of pressure relief valves.

**The diagram below illustrates a pressure only relief valve. If local codes require a combination and pressure relief valve be installed, an extension piece may be required.**

For safe operation of the water heater, be sure that:

- The pressure rating of the pressure relief valve must not exceed 150 psi, the maximum working pressure of the tankless water heater as marked on the rating plate.
- The BTUH rating of the pressure relief valve must equal or exceed the BTUH input of the tankless water heater as marked on its rating plate.
- No valve of any type should be installed between the pressure relief valve and the water heater.
- The discharge line must be NO SMALLER than the outlet of the valve and must pitch downward to allow complete drainage (by gravity) of the pressure relief valve and discharge line.
- The end of the discharge line should not be threaded or concealed. No valve of any type, restriction or reducer coupling should be installed in discharge line.

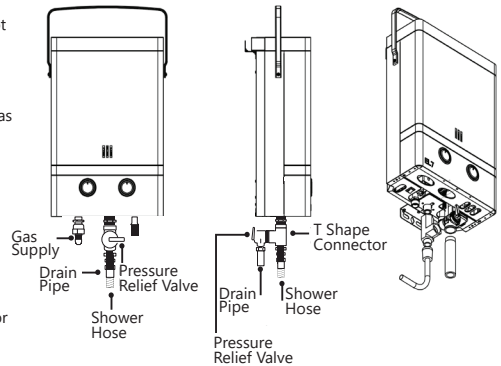

## Combustion and Ventilation Air

**⚠ Warning!**

**Gasoline, as well as other flammable materials and liquids (adhesives, solvents, paint thinners etc.), and the vapors they produce are extremely dangerous. DO NOT handle, use or store gasoline or other flammable or combustible materials anywhere near or in the vicinity of a water heater or any other appliance. Be sure to read and follow the labels on the water heater, as well as the warnings printed in this manual. Failure to do so can result in property damage, bodily injury or death.**

This water heater is for **OUTDOOR** installation ONLY. It must NOT be installed indoors or in a confined space.

An air supply containing halogenated hydrocarbons may be safe to breathe, but when it passes through a gas flame corrosive elements are released that will shorten the life of any gas burning appliance.

Propellants from common spray cans or gas leaks from A/C and refrigeration equipment are highly corrosive after passing through a flame and therefore should never be used around the water heater.

The tankless water heater warranty is voided when failure of the heater is due to operation in a corrosive atmosphere.

# The EL5 Portable Tankless Water Heater

## BENEFITS AND RECOMMENDED USES

The Eccotemp EL5 is a portable liquid propane fired tankless water heater capable of delivering 1 to 1.5 gallons of hot water per minute to almost anywhere. The portable tankless water heater has standard 1/2" NPT pipe fittings and an adapter for using a standard garden hose for inlet water supply. People around the world use similar portable tankless water heaters to heat water for recreational use, safely and reliably.

Required gas supply should be from a standard 20 pound liquid propane cylinder (not included). Included with your EL5 Portable Tankless Water Heater is a CSA approved regulator with hose and a multi-spray showerhead set with an on/off switch. If you purchased the EL5 Bundle then you received in addition to the above items the EccoFlo 12v water pump and strainer.

The automatic ignition is powered by 4 "AA" Cell Batteries (not included). When water starts flowing through the tankless water heater the burner ignites and starts producing instant hot water! No pilot light! Ideal water pressure for operation is 20-80 psi.

The EL5 has a built-in tilt switch that will automatically shut off the tankless water heater any time it is tilted more than 45° in any direction.

Required gas supply should be from a standard 20 pound liquid propane cylinder (not included). LP-gas cylinders must either be designed, fabricated, tested and marked (or stamped) in accordance with the regulations of the U.S. Department of Transportation (DOT) or for use in Canada, cylinders must be constructed and marked in accordance with the specifications for Cylinders, Spheres, and Tubes for the Transportation of Dangerous Goods, CSA B339.

- Do not store a spare LP gas cylinder under or near this appliance.
- Never fill the cylinder beyond 80 percent full.

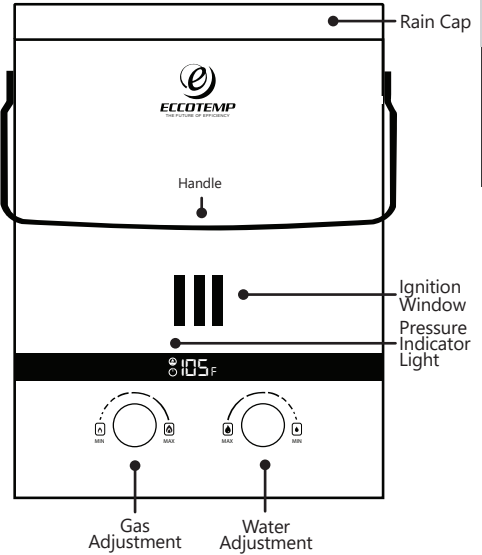

**⚠ WARNING: If the information above is not followed exactly, a fire causing death or serious injury may occur.**

## Outdoor Recreational Uses



SHOWER



EQUESTRIAN



HUNTING



RECREATION



POOL SIDE



FOOD TRUCKS



PET BATHING



GREEN HOUSES



CAMPING



TINY HOMES



EMERGENCY PREP



OFF-GRID

## Getting Started

1. Check box for damage. Damages caused in shipment must be reported immediately.
2. Make sure you have all the parts:

Please note: included parts and accessories may vary depending on country and regulations.



qty. 1 - Water Heater



qty. 1 - Rain Cap



qty. 1 - Shower Nozzle and Hose



qty. 1 - 1/2" NPT to Garden Hose Adapter

All accessories come with a 30 day manufacturer's warranty.



qty. 1 - Gas Hose and Regulator



qty. 1 - Hardware Pack

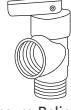

Pressure Relief Valve (Only in Canadian Shipments)

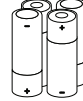

4 "AA" Cell Batteries (Not included)

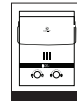

Manual

### Parts Sold Separately



3/4" Threaded Tee Fitting



3/4" x 1/2" Adapter x 2

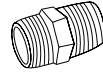

1/2" x 1/2" Hex Nipple



3/4" Pressure Relief Valve (Provided in Canadian Shipments Only)

## Location

### THIS WATER HEATER IS FOR OUTDOOR USE ONLY!

- This model is an outdoor model and must be mounted on a vertical wall. It must not be installed indoors or in a confined space. Make sure people (particularly children, disabled, and elderly) will not touch the hot water outlet or the flue terminal. The flue terminal and air inlet must be clear of obstruction and shrubbery.
- The tankless water heater must be installed on a fire retardant area, and must be away from all flammable materials. Clearance should be 4 ft to the left and right side of flammable materials and 6.75 ft to the front.
- The tankless water heater should be installed in open area where strong wind currents are not prevalent. Take measures to avoid direct wind, rain and snow.
- Make sure the tankless water heater is not temporarily installed in a location where damage can occur, for example, by moving vehicles or area flooding, etc.

## Water and Gas Connections

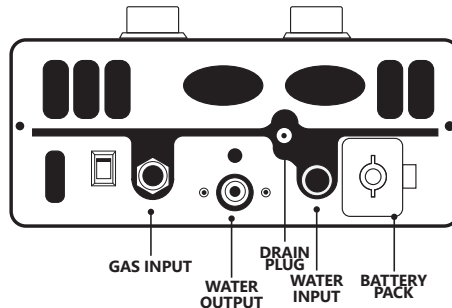

**⚠ NOTICE:** Sealant tape included in your hardware pack should be used on your water inlet and outlet pipes before connecting your water source or output device.



# Proper Installation

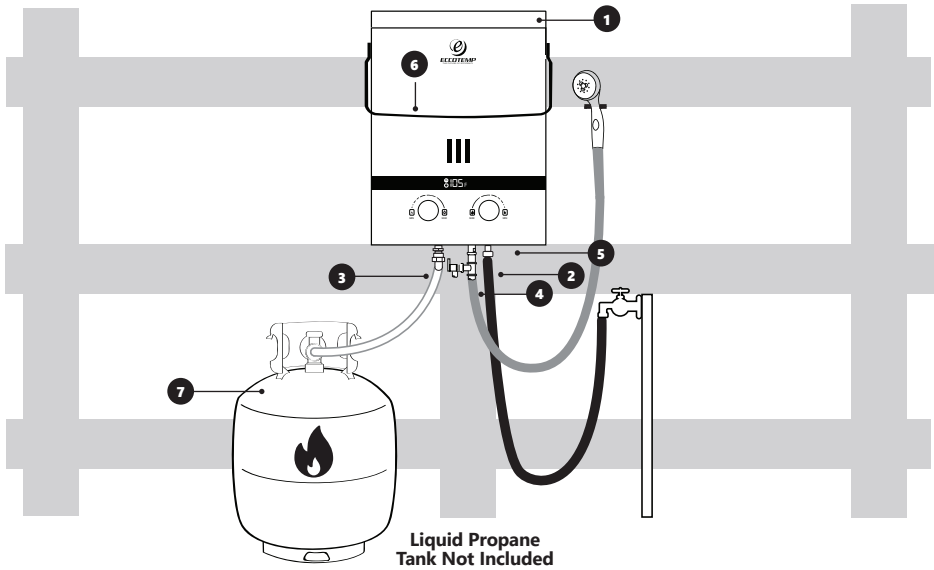

**⚠ WARNING: If using with non-potable water, do not heat water for human consumption.**

1. Attach the rain cap securely to the top of your portable tankless water heater by sliding the shield into the designated slots.
2. If using a standard garden hose, attach the 1/2" NPT to garden hose adapter to the fitting marked "Water Input". Use sealant tape or other approved sealing method on the threads for a secure, watertight fit. Check to make sure the screen inside the water inlet is in place and clean. Then attach your water input/garden hose.
3. Install gas supply line and regulator to the portable tankless water heater by using 2 wrenches, one on the compression fitting already attached to the tankless water heater and the other on the gas line. **DO NOT OVER TIGHTEN. OVER TIGHTENING MAY CRACK THE GAS REGULATOR CAUSING A GAS LEAK!** Check for any gas leaks before ignition! Make sure the gas connection is secured and cylinder in an upright position for proper vapor withdrawal.
4. Attach the shower nozzle hose to the water output to the fitting marked "Water Outlet". Do not over tighten. If using with a pressure relief valve the pressure relief valve should be installed to the tankless water heater first and then the shower nozzle hose.
5. Install four AA batteries in the compartment on the bottom left of the heater. Check that the batteries are facing the correct direction. Additional parts are necessary when installing with pressure relief valve. See pg. 8 for more details.
6. Use the top tab on the portable tankless water heater to suspend from a mounted screw capable of holding 30 pounds. Place at a comfortable height without putting stress on the gas hose. Do not use suspended from the handle! Do not permanently mount this portable tankless water heater!
7. Attach gas regulator with hose to the LP tank. Use hand pressure only on the plastic connector. **LEAVE GAS TANK VALVE IN THE "OFF" POSITION.**

## **⚠ Before going to the USE section:**

Check around area for flammables, especially gasoline or other vapors which may ignite. The exhaust and top of the portable tankless water heater will get HOT! Make sure there are no foreign objects around the portable tankless water heater or that have fallen into the top.

## Use and Operation

This water heater is for point of use and is meant for temporary water heating. You should not connect to a permanent inlet water connection or connect to a water distribution system to supply multiple outlets. If this water heater is only intended for use with non-potable water (such as a portable shower) do not consume the water internally. This water heater does not screen contaminants and poses a potential health risk if used to heat water for consumption.

### **⚠ Warning: This model is intended for recreational & portable use only. This model CANNOT be permanently mounted or plumbed in any way.**

1. Be sure the showerhead or other water outlet device is in the "OFF" position.
2. Set the water regulator knob on the face of the portable tankless water heater to its highest setting.
3. Set the gas regulator knob on the face of the portable tankless water heater to its minimum setting.
4. Make sure the gas cylinder is in an upright position and turn the gas valve on the cylinder all the way open.
5. IF THE SMELL OF GAS IS DETECTED, TURN OFF THE GAS VALVE FROM THE LP-GAS SUPPLY CYLINDER IMMEDIATELY!!!
6. Turn on incoming water supply. Ensure that you have adequate water pressure between 20-80 PSI.
7. Turn on your showerhead or other water output device to the "on" position and adjust to the desired water flow.
8. There will be a series of audible clicks and the burner will ignite. Should the burner not ignite after 5 seconds, shut off and go to the "Trouble Shooting" section.
9. Upon completion, turn the showerhead off or other water output off.
10. Turn your gas and water supply off.
11. For storage, disconnect the water and gas lines from your portable tankless water heater.
12. Drain the water heater by unscrewing the drain plug from the bottom of the tankless water heater. See page 9 for location.
13. Store water heater when not in use in a safe, warm and dry place.

### **⚠ WARNING: If the outside temperature is around or below freezing (32°F, 0° C, ensure that the drain plug is opened and water drained from the portable tankless water heater after each use to avoid internal damage to the water heater. You will also need to unhook the outgoing water line to ensure that any water in the heat exchanger is drained. Failure to properly drain your portable tankless water heater will cause water damage which may or may not be repairable.**

This appliance must be installed in accordance with local codes or, in the absence of local codes, the National Fuel Gas Code, ANSI Z223.1/NFPA 54, or the Natural Gas and Propane Installation Code, CSA B149.1, or the Propane Storage and Handling Code, CSA B149.2

### **⚠ WARNING!**

#### GAS HOSE ADAPTER

THE EL5, EL5 and EL5 PORTABLE TANKLESS WATER HEATERS HAVE 1/2" TO 3/8" ADAPTER ALREADY ATTACHED TO THE GAS INLET ON THE WATER HEATER.

PLEASE ENSURE THE ADAPTER IS CORRECTLY INSTALLED WITH THREAD SEALANT. A SPOOL OF SEALANT TAPE IS INCLUDED WITH THE WATER HEATER.

MULTIPLE WRAPS OF SEALANT TAPE MAY BE NECESSARY TO ASSURE COMPLETE SEAL.

ALWAYS CHECK FOR GAS LEAKS BEFORE USING HEATER.

# Adjustment

The temperature of the outgoing water is dependent on the temperature of the incoming water balanced with the amount of heat applied. Use extreme caution when setting the outlet water temperature.

1. Make sure showerhead is in the off position.
2. Turn the water knob to max.
3. Turn gas knob to min.
4. Turn on gas.
5. Turn on water.
6. Turn showerhead on. (Or other outlet device)
7. Wait to hear a series of audible clicks.
8. Upon completion turn off showerhead set.
9. Turn off water supply.
10. Turn off gas supply.
11. Disconnect water and gas lines.
12. Drain plug open. See page 9 for location of pressure drain plug.
13. Store in a safe, warm, dry place.

**⚠ WARNING: Do not alter or change this water heater's original temperature sensor.**

**⚠ WARNING: Should overheating occur or the gas supply fail to shut off, turn off the manual gas control valve to the appliance.**

**⚠ WARNING: THE PORTABLE TANKLESS WATER HEATER IS CAPABLE OF PRODUCING SCALDING WATER TEMPERATURES!**

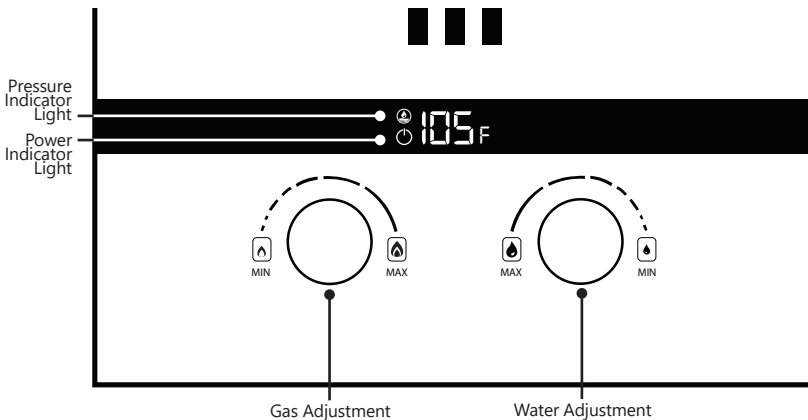

## Functions and Features

- **Water controlled automatic ignition:** Water pressure between 20-80 PSI and 0.5-2.0 GPM opens the ignition circuit for easy and convenient operation.
- **Auto cut-off protection:** The auto cut-off protection will shut the gas supply off immediately in the event of flameout to reduce the risk of gas leakage.
- **Remove drain valve to avoid water pipe and regulator damage caused by freezing water.\***
- **Anti-dry combustion protection:** The portable tankless water heater will shut off the gas supply in the event water stops flowing through the portable tankless water heater.

\*Read the maintenance section on draining the portable tankless water heater entirely to avoid freeze related issues.

TEMPERATURE INCREASE PER GPM					
MODEL	Gas Setting	0.5 GPM	1.0 GPM	1.5 GPM	2.0 GPM
EL5	Highest	96 °	48 °	32 °	25 °
	Lowest	34 °	17 °	11 °	9 °

**⚠ NOTICE** - Temperature increases listed are based on use of the tankless water heater under optimal conditions. Variable factors such as incorrect or imperfect installation and varying incoming water temperatures may yield different results.

TECHNICAL SPECIFICATIONS - PORTABLE	
Gas Type	Liquid Propane
Model	EL5
Water Pressure	25 PSI
Gas Input Rating	25,00-37,000 Btu/hr
Manifold Gas Pressure	11 in w.c. (2.74 kPa)
Ignition	Electric Pulse, AA Battery Powered (No electrical connection required)
Protections	Auto cut-off water control, automatic ignition, anti-dry combustion protection, over-pressure overheating and flameout protection
Dimensions	15.9" x 11.9" x 4.8"
Weight	11.2 lbs.
Pipe fittings	1/2" NPT, incoming/outgoing water & gas

## Rain Cap Inspection

Be sure to turn the unit off and disconnect the water supply before performing any housekeeping tasks to this tankless water heater. Vacuum around the tankless water heater for dust, dirt and lint on a regular basis. Clean the tankless water heater and front panel by using a damp soft cloth with a few drops of mild detergent and gently wiping the surfaces of the unit. Wipe any remaining moisture with a dry soft cloth.

## Storage

When not in use, your portable tankless water heater should be stored away in a climate-controlled area.

**⚠ WARNING: Item should not be left or stored in freezing conditions (at or below 32°F / 0°C). Internal damage can occur.**

Upon completion of use, prepare your water heater for storage:

1. Turn OFF water and gas supply and then disconnect from water heater.
2. Unscrew the drain valve (ribbed cylindrical stem next to the water input valve) to ensure draining of water.
3. Remove the screen at the end of the water inlet pipe and clean. Return screen after cleaning. (see housekeeping section above for instructions)
4. Store tankless water heater in a climate-controlled area.

When the tankless water heater is not in use and remains connected to the LP-gas supply cylinder, the tankless water heater and cylinder must be stored outdoors, in a well ventilated space, out of the reach of children, and must not be stored in a building, garage or any other enclosed area.

Storage of the tankless water heater indoors is permissible only if the cylinder is disconnected and removed from the water heater.

LP-gas cylinders must be stored outdoors, in a well-ventilated space, out of the reach of children, and must not be stored in a building, garage or any other enclosed area.

## Cleaning the Water Screen

1. Make sure the water heater is OFF.
2. Disconnect the water supply from the water heater.
3. Locate the screen at the end of the water inlet pipe and gently remove with a screwdriver.
4. Rinse the screen in a sink or with a hose to remove any debris.
5. Return the screen by gently inserting back into the end of the water inlet pipe.
6. Reconnect the water supply and turn ON the water heater.
7. Clean the water screen on a monthly basis.

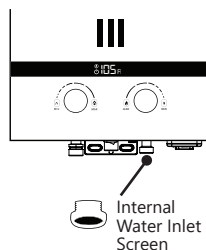

## Flushing your Water Heater

It is highly recommended that you clean your Eccotemp portable tankless water heater after every other use or every 3 months to ensure your water heater is running as efficiently as possible. Exposure to unfiltered water can increase your chances of water scale, lime or rust deposit buildup.

To do this we recommend that you use our Eccotemp EZ-Flush Descaler System to flush out any unwanted build-up and sediment.

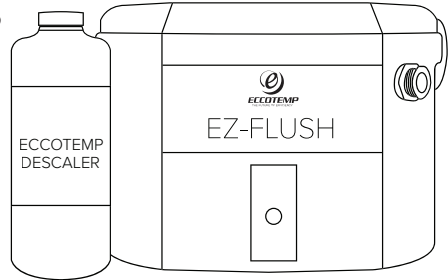

Use code: **EZ2020**  
for 10% off EZ Flush

- ⚠ **DANGER:** Before disconnecting the water supply, make certain no one will be exposed to the danger of the hot water released by disconnecting. The water may be hot enough to create a scald hazard. The water should be released into a suitable drain to prevent injury or property damage.
- ⚠ **DANGER:** Hotter water increases the potential for hot water scalds.
- ⚠ **DANGER:** Failure to perform the recommended routine preventative maintenance can harm the proper operation of this water heater, which can cause carbon monoxide dangers, excessive hot water temperatures and other potentially hazardous conditions.

When properly maintained, your water heater will provide years of dependable trouble-free service. It is recommended that a periodic inspection of the burner, water screen and top exhaust should be made by service personnel qualified in gas appliance repair.

It is suggested that a routine preventive maintenance program be established and followed by the user.

Inspect the area around the tankless water heater to ensure a safe operating environment. Keep water heater area clear and free from combustible materials, gasoline, and other flammable vapors and liquids. Ensure the tankless water heater has not been damaged. If damage or denting is present, contact a service personnel to verify proper operation.

Check for any abnormal sounds during normal operation of the water heater.

All piping should be checked for gas and/or water leaks. Refer to page 4 of this manual for instructions on leak testing.

The air intake and cold water supply screen should be cleaned monthly. Refer to the "Housekeeping" section for further information.

**DO NOT** operate the tankless water heater if you feel something is wrong with the unit.

**DO NOT** allow children to operate or otherwise handle the unit.

# Construction and Parts of the EL5

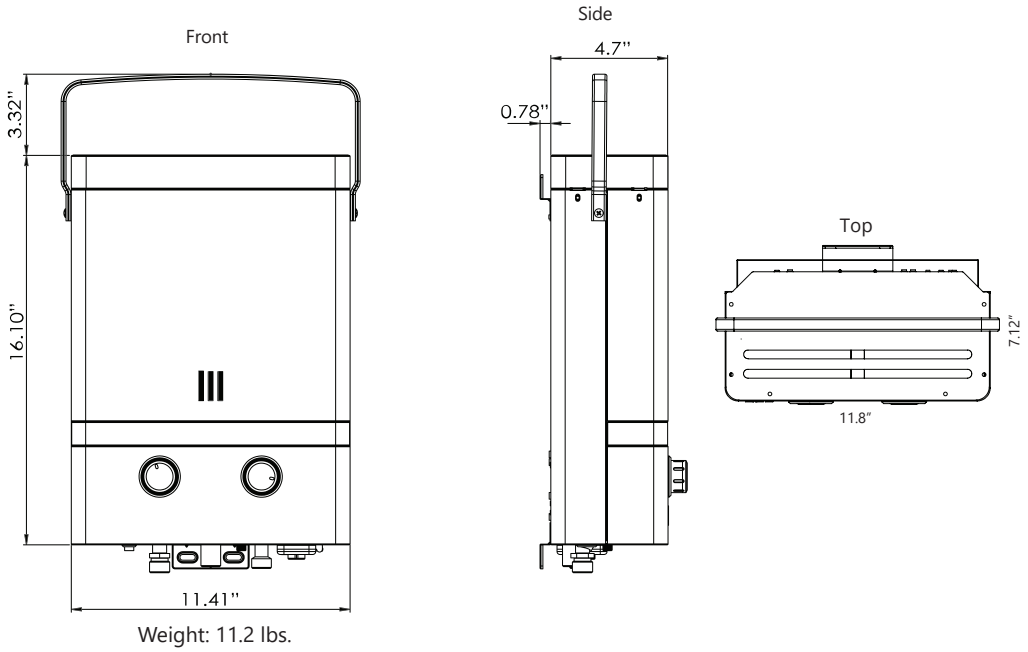
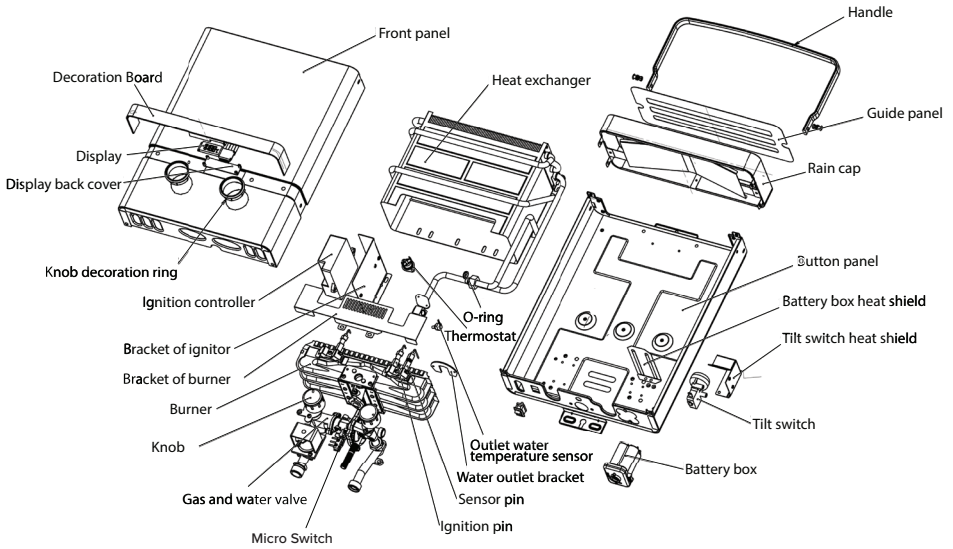



# Electrical Wiring

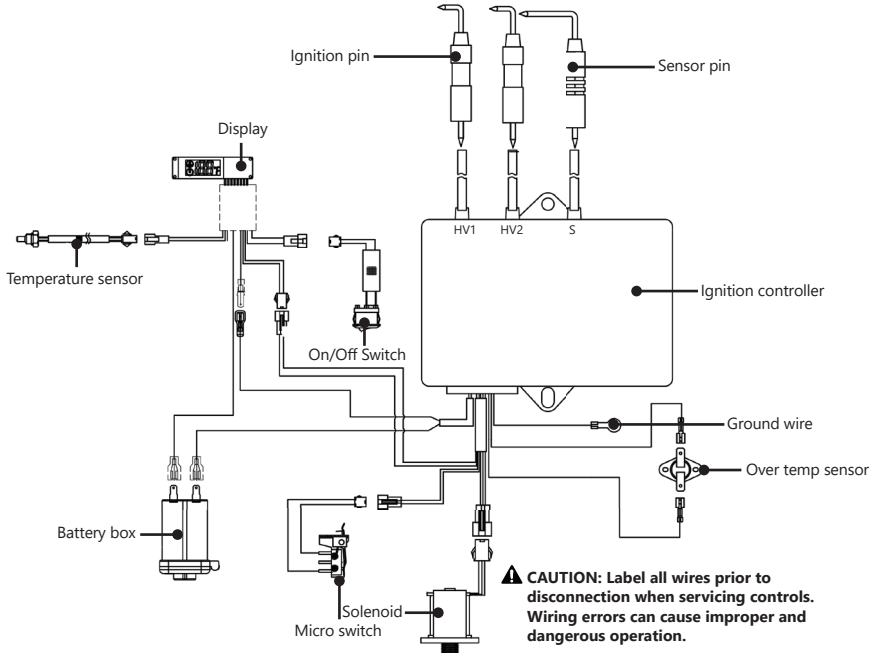

This connection is for low-voltage batteries or direct current only. Do not connect 120 or 240 volts AC.



**▲ NOTICE -** If any of the original wire as supplied with the appliance shall be replaced, it shall be replaced with the original type wire or its temperature equivalent.

## Replacement Parts

REPLACEMENT PART	SKU
 Shower Nozzle and Hose	502024
 1/2" NPT to Garden Hose Adapter	502028
 Gas Hose and Regulator	502005

REPLACEMENT PART	SKU
 Hardware Pack	201032
 Pressure Relief Valve	JPRV12
 Battery Box and Control Pack	501026



## PORTABLE PRODUCT COMPARISONS

### EL5

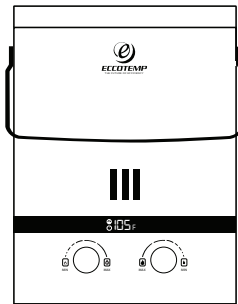

### EL7

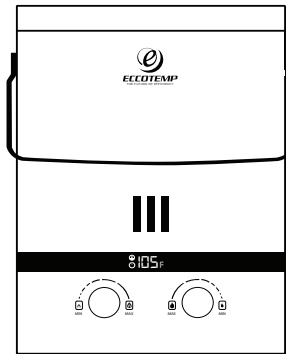

### EL10

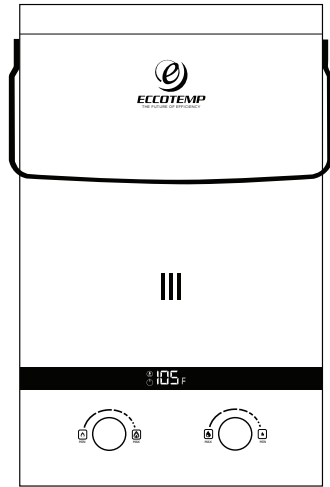

	EL5	EL7	EL10
INSTALLATION	OUTDOOR ONLY	OUTDOOR ONLY	OUTDOOR ONLY
BTU	25,000 - 37,500	47,800 - 52,500	75,000
Flow Rate	Rated 1.5 GPM	Rated 1.85 GPM	Rated 2.65 GPM
Portable	Yes	Yes	Yes
Power Source	4 "AA" Cell Batteries	4 "AA" Cell Batteries	4 "AA" Cell Batteries
Gas Type	Liquid Propane Only	Liquid Propane Only	Liquid Propane Only
Venting	None Needed	None Needed	None Needed
Water Pressure	20-80 PSI	20-80 PSI	20-80 PSI
Regulator & Hose	Standard / Included	Standard / Included	Standard / Included
Temperature Control	Manual 80	Manual 80	Manual 80
Warranty	2 Years	2 Years	2 Years
Product Dimensions	15.9" x 11.4" x 4.8" - 11.2 lbs	19.1" x 11.9" x 7.1" - 14.7 lbs	*30.2" x 13.6" x 9.5" - 30.8 lbs
Package Dimensions	21.9" x 12.4" x 7.7" - 13.8 lbs	25.8" x 14" x 7.7" - 16 lbs	*25.1" x 11.5" x 6" - 23.7 lbs

\*Subject to change