



ISO 9001:2008

**CLEAN SEAL,<sup>®</sup> INC.**



Transportation/RV

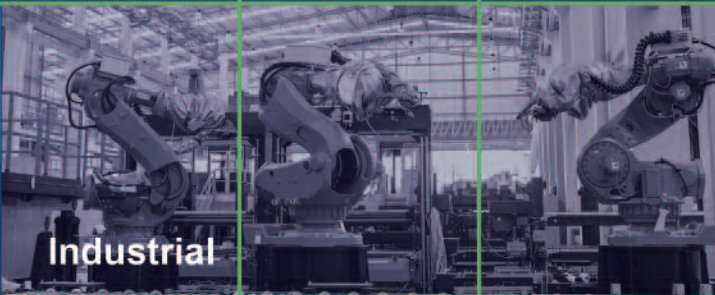

Industrial



Energy/Construction



# 2016

PRODUCT CATALOG

CLEAN TRIM MOLDINGS • 3M SEALING TAPE • SEALS • CLEAN GRIP • EXTRUDED PLASTIC PARTS

# HISTORY

**ISO 9001:2008 CERTIFIED IN 2011**



**Serving Our Customers for over 35 Years**

## **About Clean Seal® , Inc.**

Closed cell rubber extrusions are shaped to fit a wide variety of applications sealing in or sealing out unwanted elements.

Clean Seal, Inc. has provided the original equipment manufacturer and fabricator with these high quality seals and gaskets since 1978.

Our seals are compounded, mixed and tested using the most advanced equipment and technologies available in the polymer industry.

Clean Seal received the prestigious ISO 9001:2008 certification in early 2011. ISO 9001:2008 is the term for a series of standards sponsored by the International Organization for Standardization (ISO), a federation of more than 110 countries. The certification process establishes, documents, and maintains a system for ensuring the output quality of the process. An independent certifying body performs annual audits to verify that the company is meeting all of the requirements of the standard. The procedure is difficult to pass, but it shows customers that Clean Seal has taken the steps necessary to ensure their products and services are the very highest of quality.

Secondary Operations to speed installation include:

- cutting to length
- splicing/bonding
- notching
- adhesive lamination
- hole punching
- vulcanizing

And our business has grown every year since 1978! In late 2000, we moved into a spacious plant located in South Bend, Indiana.



## **Here are some reasons for our growth.**

### **• Quality Products**

When quality is there, customers continue to purchase! Our list of satisfied customers grows daily.

### **• Large Inventory of Stock Items On Hand**

Many of our stock items can be on their way to you within 24 hours, as we keep an adequate supply of inventory in our warehouse.

### **• Customer Service**

Our customer service department will help you with prices on standard line stock items, sample requests, availability of product and give you suggestions on product to order for your specific requirements.

Our quoting department can quote on custom products.

### **• Quality Assurance**

Uniform materials and design are critical to any manufacturing process. Strict adherence to Quality Assurance procedures assures that you receive product that will maintain specific tolerances to meet your requirements.

### **• Sales/Consultation**

Our national sales organization and our in-house staff can suggest the most effective material and profile shape for your application. We'll work with your engineers and purchasing personnel to select the best product for your use and environment.

### **• Our Size**

We're large enough to service the largest automotive companies, but we're still small enough to give you the personal service that's so important today.

### **• Central Location**

We're located just 1½ hours from Chicago, 3½ hours from Detroit and 2½ hours from Indianapolis. Our international customers find they can easily reach our plant with the convenient location near the South Bend airport.

PLEASE NOTE: Due to the constant effort to update product, specifications are subject to change without notice and without incurring obligation. Because we cannot anticipate or control the different conditions which this information and our products may be used, we do not guarantee the applicability of the accuracy of this information or the suitability of our products in any given situation. Users of our product should make their own tests to determine the suitability of each product for their particular purposes. All prices are stated in U.S. Dollars and are subject to change without notice. Due to the ever-changing cost of raw materials used to manufacture our parts, Clean Seal, Inc. reserves the right to revise a quoted price at any time. In no event should the content of this quote be construed as an expressed or implied promise, guarantee or implication by or from Clean Seal, Inc. Clean Seal cannot be held accountable and the buyer will assume all responsibility for loss or damage arising from the handling and use of our products. All statements concerning the possible use of our products are not intended as recommendations to use our products in the infringement of any patent. Clean Seal, Inc. reserves the right to correct errors in specifications or prices, due to typographical or clerical errors or because of incomplete or inaccurate information from the Buyer.

## MARKETS

### **Innovators**

Clean Seal has long been the innovator, the problem solver and the originator of new products. Original Equipment Manufacturers (O.E.M.'s) look to Clean Seal® to solve their sealing problems. When a large recreational vehicle manufacturer of motorhomes and travel trailers was experiencing leakage problems with their slide-out rooms, they came to Clean Seal® for a solution. Clean Seal®, with the help of an engineering consulting firm, designed a series of extruded gaskets that eliminated the problem. Now these slide-out gaskets are the most copied extruded profiles in the industry.



### **Diversity of Knowledge**

Since 1978, we have provided superior service in such diverse industries as recreational vehicles, transportation, marine, agriculture and mining. The vast knowledge of a variety of industries and the materials that will best work for the specific application is Clean Seal's strong suit. Because the nation-wide sales force works with a wide variety of manufacturers, their shared experiences can help solve problems in an innovative and timely manner.



### **New Product Lines (See page 16-21 & 32-33)**

At Clean Seal® we strive to keep up to date with our customers needs. In order to do that it is important for us to offer a diverse product line. One product line you may be familiar with is Clean Shield, electromagnetic interference (EMI) shielding products. In the second quarter of 2012 we also started to offer a new product line called Clean Spring (page 32-33), Clean Spring is our own line of springs our customer use everyday on their applications, so Clean Spring is a natural fit for Clean Seal and our customers.



### **Experienced Sales Force**

Our sales personnel and in-house staff have many years of experience. They are ready to show you the numerous applications of closed cell extrusions and assist with gasket problems that have a challenged solution. Most problems can be corrected with gaskets that are designed to meet your specific needs.

Large or small, Clean Seal® has the resources and expertise to expedite your order.



### **Going Green**

For the past several years, Clean Seal has made a concerted effort to cut the use of energy sources. Since 2003, they have tracked monthly usage of electricity and natural gas. By making significant changes to habits and an awareness of energy values, they kept their energy costs at the same level as in 2003 while the same costs have skyrocketed. They make use

of daylighting, thermostat controls, cutting unnecessary lighting, etc. Delivery routes have been changed to make the most efficient use of time and fuel. Recycling has also played a part in the effort, while a windmill is now used to oxygenate their pond. Clean Seal is going Green.



# SEALS & GASKETS

**DIE IDENTIFICATION KEY:** ▲ EPDM ■ Neoprene\* ● Nitrile ★ Dense ✓ Non Stock Item - Minimum Requirement

A "W" included in the part number or the word "White" indicates that the part is white. All other parts are black.  
\* It is recommended that only 3M™ HATS adhesive be used with all Neoprene profiles.

## " Pedestal " Sections Die shapes not to scale

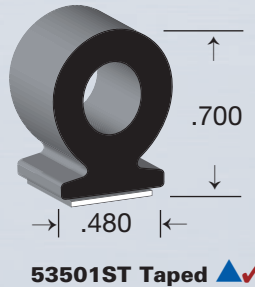
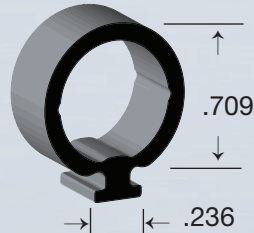
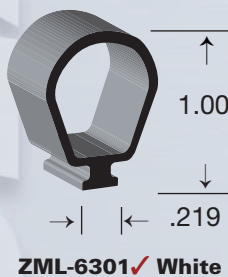
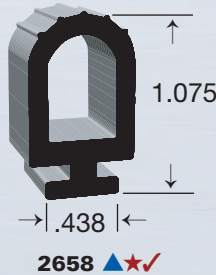
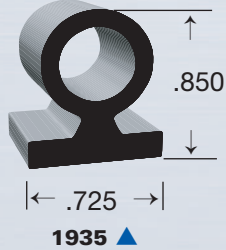
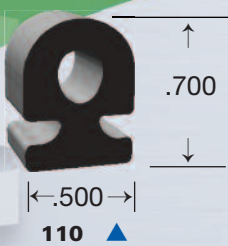

BULB WALL THICKNESS	
PART #	
ZML-6302 ▲★✓	.059
ZML-6303 ▲★✓	.089

## " U " Channels Die shapes not to scale

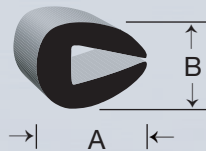
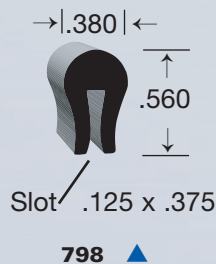

PART #	A	B
2588 ▲★	.400	.340
2589 ▲★	.480	.425

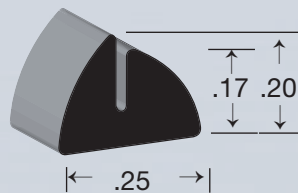
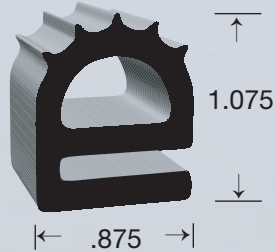
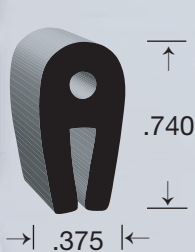

## RUBBER EXTRUSIONS

Our products are available in standard and custom profiles. EPDM, Neoprene, Nitrile and Silicone compounds are available. (Note Key indicating the make-up of stock profiles.)

These extrusions are available in continuous lengths and intricate profile shapes, but can be cut to length to meet your specifications. Our cold glue splicing service offers you the option to shape the extrusion to meet your application around windows, doors and other seal requirements.

## DUROMETERS

The majority of our rubber extrusions are closed cell sponge materials (medium density) while a selected few are dense (ranging from 40-90 durometer, Shore A).

## ADHESIVES (See page 12)

Pressure sensitive adhesives are available for a wide variety of applications. Our heavy-duty requirement adhesive is specifically formulated to meet Clean Seal requirements. This adhesive is available in either a rubber-based or an acrylic-based formula to meet your specific needs and is available on most of the extruded profiles listed in our catalog.

Clean Seal is also able to apply 3M™'s revolutionary 3M™ (ST) sealing tape with high-tech equipment, for a permanent bond. In addition to the aggressive (ST) adhesive, Clean Seal offers 3M™ silicone/acrylic double coated film tape available for most of our sponge silicone profiles.

These adhesives fit most applications including door jambs, lid or cap closures, and locations that involve the human contact element.

## SEALS & GASKETS

Clean Seal extrusions meet original equipment manufacturer and fabricator specifications for a multitude of seal and gasket applications. In-service applications are evaluated to determine the best and most cost-effective polymer for your requirements.

## FOAM

Clean Seal offers a variety of foam sealant products. They are available in EPDM and Neoprene.

# SEALS & GASKETS

**DIE IDENTIFICATION KEY:** ▲ EPDM ■ Neoprene\* ● Nitrile ★ Dense ✓ Non Stock Item - Minimum Requirement

A "W" included in the part number or the word "White" indicates that the part is white. All other parts are black.  
\* It is recommended that only 3M™ HATS adhesive be used with all Neoprene profiles.

## Miscellaneous Sections Die shapes not to scale

50322 ▲      214 ■      432 ■      510 ■      5102 ▲✓

1743ST TAPED ▲✓

50500 ▲      51991 Taped ▲✓      52787ST Taped ▲✓

1656 / 1660	
PART #	A
1656 ▲	1.375
1660 ▲	1.824

## "Ribbed" Sections

## Cord Stock Die shapes not to scale

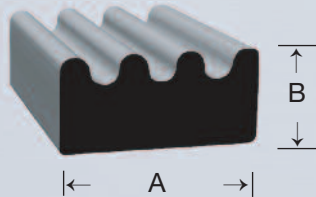

RIBBED STOCK (4)		
PART #	A	B
113 ▲	.375	.188
1076 taped ▲	.334	.137
1152W ▲	.375	.133
1152B ▲	.375	.133

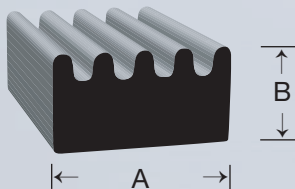

RIBBED STOCK (5)		
PART #	A	B
103 ▲	.625	.375
1083 ▲	.625	.312
2613W ▲	.625	.375
2897 ▲	.500	.312
2897W ▲✓	.500	.312
5984 ▲	.563	.315
54633ST taped ▲✓	.500	.430

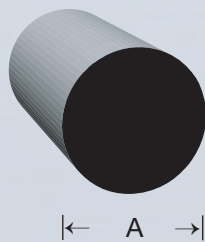

CORD STOCK	
PART #	A
121 ▲	.0940
6500 ■	.5000
6507 ■	.3750
6510 ■	.6250
6554 ■	.2500
6558 ■	.1410
6564 ■	.1875
6632 ▲	.0800
9501 ▲✓	.3300
60106 ▲✓	.2500
60109 ▲✓	.3130
65073 ▲✓	.3750
64716 ▲✓	.5300
60205 ▲✓	.6250

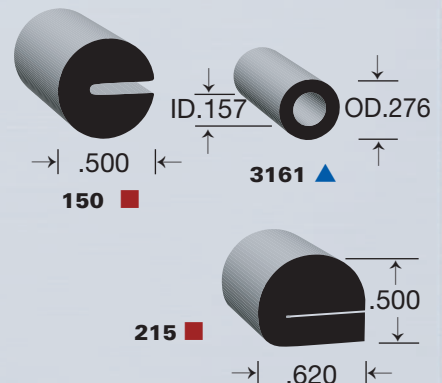

We Use... **3M** Automotive Sealing Tapes

# SEALS & GASKETS

**DIE IDENTIFICATION KEY:** ▲ EPDM ■ Neoprene\* ● Nitrile ★ Dense ✓ Non Stock Item - Minimum Requirement

A "W" included in the part number or the word "White" indicates that the part is white. All other parts are black.  
 \* It is recommended that only 3M™ HATS adhesive be used with all Neoprene profiles.

## "D" Sections Die shapes not to scale



# SEALS & GASKETS

**DIE IDENTIFICATION KEY:** ▲ EPDM ■ Neoprene\* ● Nitrile ★ Dense ✓ Non Stock Item - Minimum Requirement

A "W" included in the part number or the word "White" indicates that the part is white. All other parts are black.  
 \* It is recommended that only 3M™ HATS adhesive be used with all Neoprene profiles.

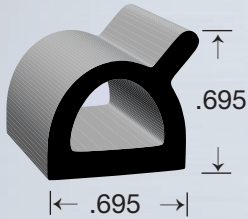

5036 ▲

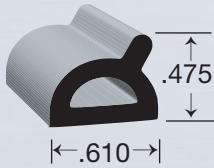

50449 ▲

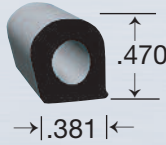

1007 ■ ✓

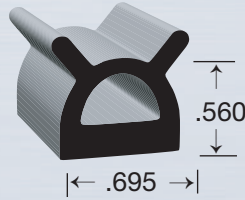

9187 ▲  
53749 ▲ ✓

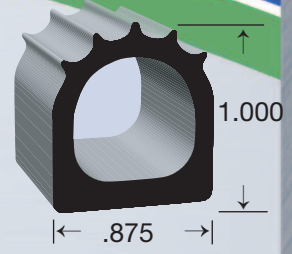

50405 ▲

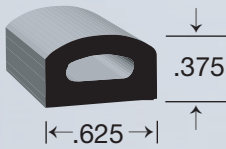

714 ■  
5243 ▲

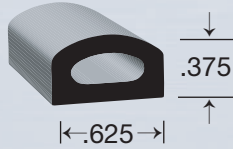

1723 ▲

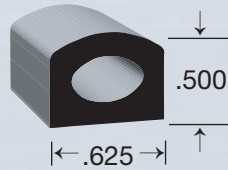

50512 ▲

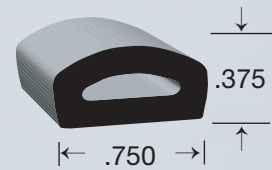

939 ■  
5253 ▲

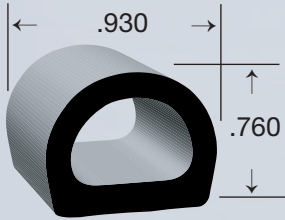

1750 ▲

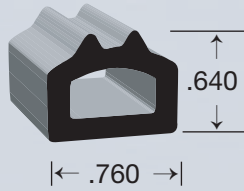

518 ▲

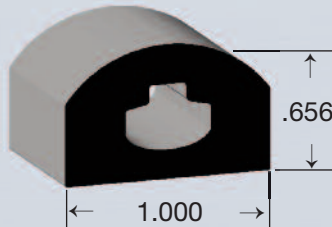

342 ■  
3423 ▲ ✓

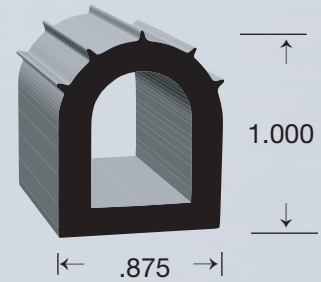

2828B ▲  
2828W ▲

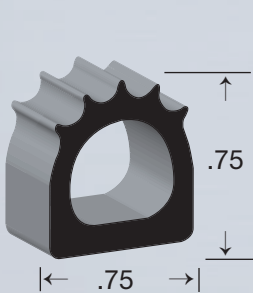

53018 ▲  
53017W ▲ ✓

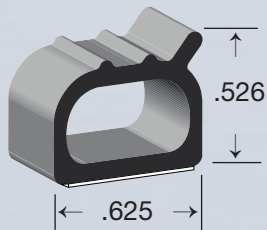

54245T TAPED ▲ ✓

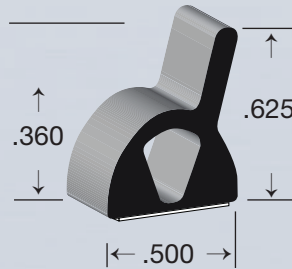

54438 TAPED ▲ ✓

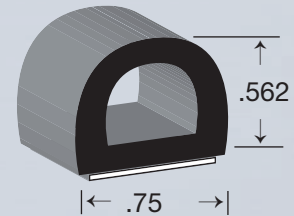

ZML-6101T TAPED ✓

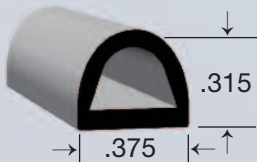

38293 ▲

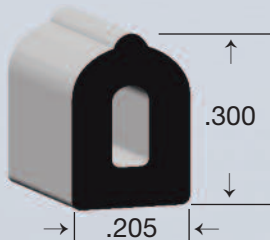

54845 ● ✓

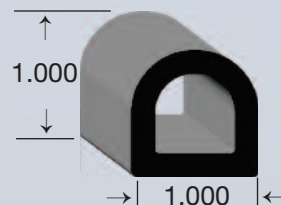

54587 ▲ ✓ White

We Use...  
**3M** Automotive  
 Sealing Tapes

# SEALS & GASKETS

**DIE IDENTIFICATION KEY:** ▲ EPDM ■ Neoprene\* ● Nitrile ★ Dense ✓ Non Stock Item - Minimum Requirement

A "W" included in the part number or the word "White" indicates that the part is white. All other parts are black.  
 \* It is recommended that only 3M™ HATS adhesive be used with all Neoprene profiles.

## "P" Sections Die shapes not to scale

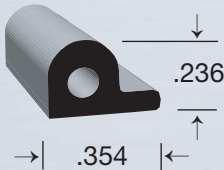

1077 ▲

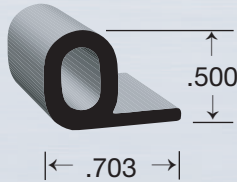

2692 ▲

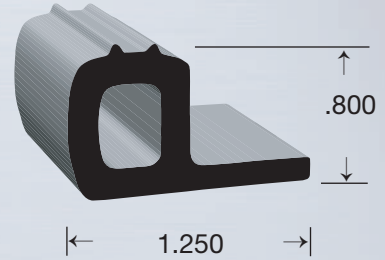

589 ●  
52346▲

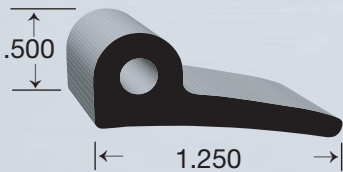

2199 ▲

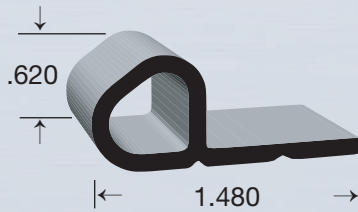

1867ST ▲ TAPED  
2178 ▲

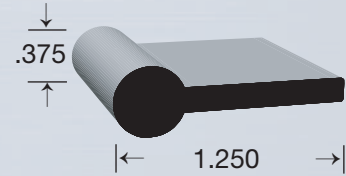

5413 ▲ WHITE  
5896 ▲



2452 / 2879 / 50663 / G-7094ST / G-7096ST		
PART #	A	B
2452 ▲	2.625	.875
2879 ▲	3.375	.875
50663 ▲✓	4.000	.875
G-7094ST ▲✓ White/Taped	2.625	.875
G-7096ST ▲✓ Black/Taped	2.625	.875

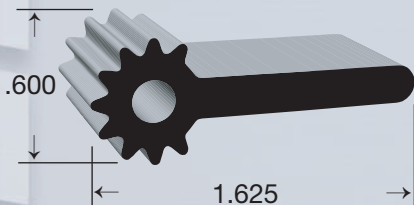
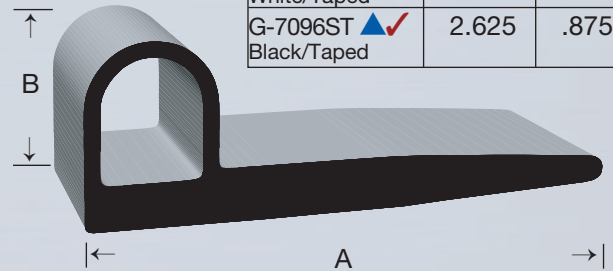

50944 ▲✓

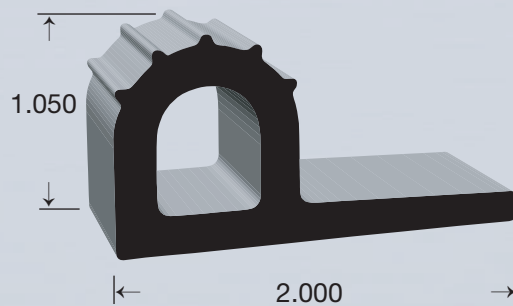

50962 ▲ WHITE

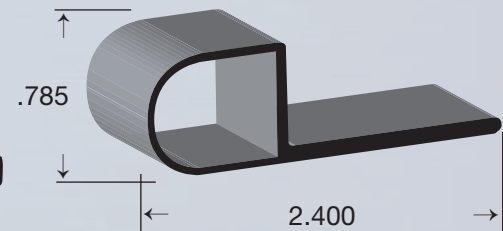

ZML-6201 ✓ WHITE



# SEALS & GASKETS

**DIE IDENTIFICATION KEY:** ▲ EPDM ■ Neoprene\* ● Nitrile ★ Dense ✓ Non Stock Item - Minimum Requirement

A "W" included in the part number or the word "White" indicates that the part is white. All other parts are black.  
 \* It is recommended that only 3M™ HATS adhesive be used with all Neoprene profiles.

## Rectangles and Squares Die shapes not to scale

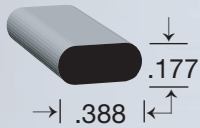

1598 ▲ WHITE

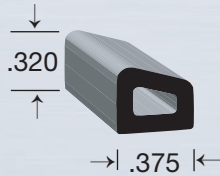

5491 ▲

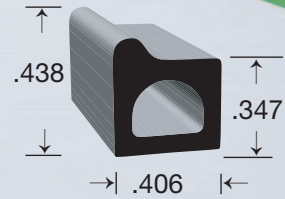

106 ▲  
5746 ▲✓ WHITE

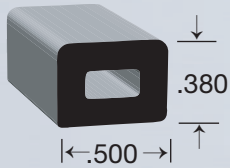

333 ▲

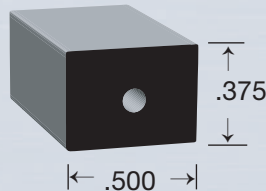

4559 ■✓

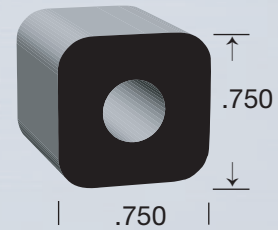

357 ■

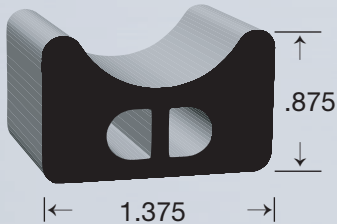

352 ▲

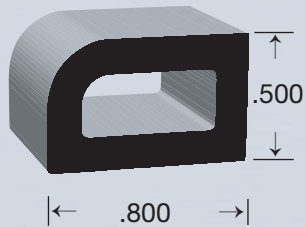

2770 ▲

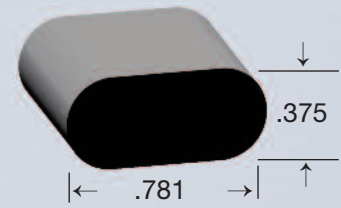

54923 ■✓

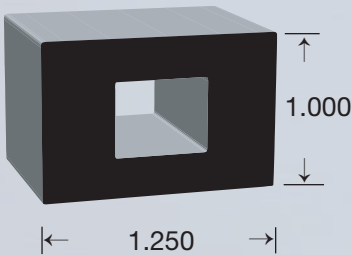

2886 ▲



We Use...  
**3M** Automotive  
 Sealing Tapes

# SEALS & GASKETS

**DIE IDENTIFICATION KEY:** ▲ EPDM ■ Neoprene\* ● Nitrile ★ Dense ✓ Non Stock Item - Minimum Requirement

A "W" included in the part number or the word "White" indicates that the part is white. All other parts are black.  
\* It is recommended that only 3M™ HATS adhesive be used with all Neoprene profiles.

## Coves / Wipers / "L" Sections Die shapes not to scale



WIPERS		
PART #	A	B
2385 ▲★	1.875	.125
2731 ▲★	3.000	.125
2877 ▲	2.750	.250
54672 ▲★✓	2.500	.110
G7005B ▲	4.000	.200
G7005PW ▲	4.000	.200
50499 ▲★	4.500	.125
ZML-3.00 ▲★✓	3.000	.165
ZML-3.25 ▲★✓	3.250	.165
ZCS-4.00 ▲★	4.000	.125
ZCS-5.00 ▲★	5.000	.125
G-7139 ▲★✓	6.000	.100
G-7109 ▲★✓	6.000	.200

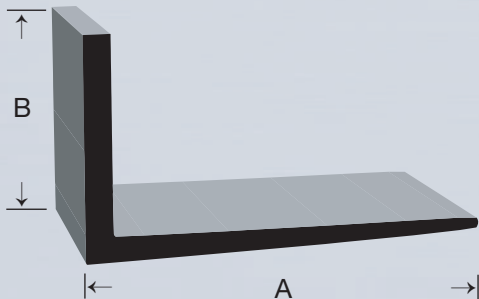

"L" SECTIONS		
PART #	A	B
2730 ▲★	2.000	1.125
G-7095 ▲★✓	3.000	1.150

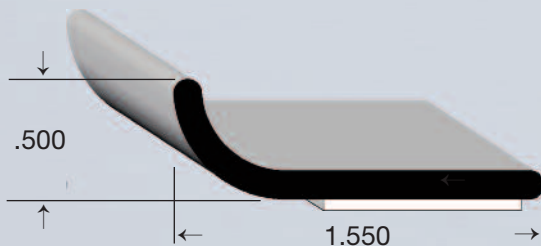

G-7138ST ▲★✓

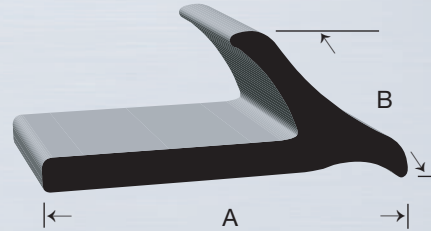

COVES		
PART #	A	B
1974 ▲ White	1.980	1.300
2398 ▲	1.980	1.300

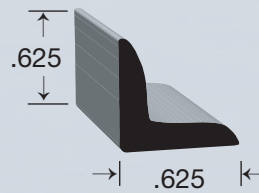
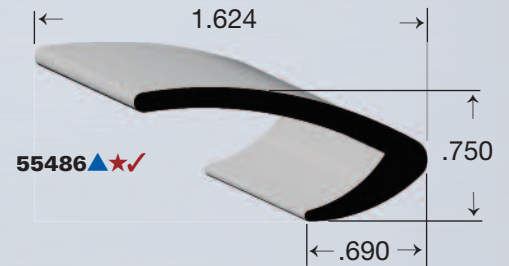

421 ■

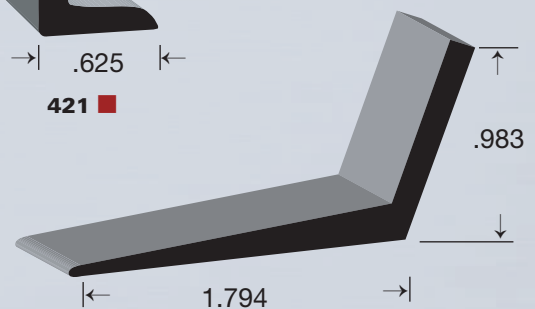

ZML-6401 ▲★✓

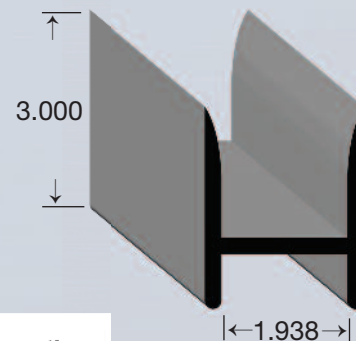

G-7075 ▲✓

We Use...  
**3M** Automotive Sealing Tapes

# SEALS & GASKETS

**DIE IDENTIFICATION KEY:** ▲ EPDM ■ Neoprene\* ● Nitrile ★ Dense ✓ Non Stock Item - Minimum Requirement

A "W" included in the part number or the word "White" indicates that the part is white. All other parts are black.  
\* It is recommended that only 3M™ HATS adhesive be used with all Neoprene profiles.

## Bar Stock Die shapes not to scale

BAR STOCK		
PART #	A	B
4506 ■	.750	.250
4508 ■	.500	.250
4516 ■	.750	.187
4517 ■	.625	.625
4521 ■ ✓	.750	.500
4528 ■ ✓	.750	.375
4531 ■	1.000	.250
4534 ■	.500	.187
4537 ■	1.250	.250
4540 ■ ✓	.500	.375
4548 ■ ✓	1.500	.500

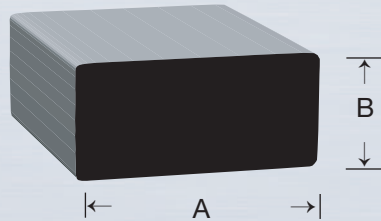

BAR STOCK (cont.)		
PART #	A	B
4712 ▲	1.250	.625
4804 ▲	1.250	.1875
4876 ▲	.500	.375
4879 ▲	.500	.250
4968 ▲	.750	.500
4969 ▲	.750	.187
4970 ▲	.750	.375
4971 ▲	1.000	.250
4972 ▲	.500	.187
4973 ▲	1.000	.500
4974 ▲	.750	.250
40508 ▲ ✓	.250	.300
45082 ▲ ✓	.500	.250
45342 ▲ ✓	.500	.187
54722 ▲ ★ ✓	.500	.125

## "Triangle" Sections Die shapes not to scale

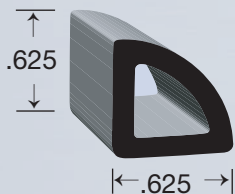

2123 ▲

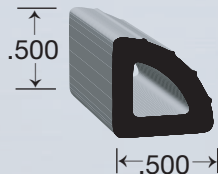

560 ▲

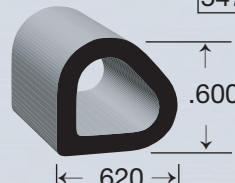

2180 ▲



54767 ▲ ✓

## Silicone Die shapes not to scale

Because of its reliability of performance under a wide range of difficult service conditions, engineers often choose silicone rubber. Silicone becomes more cost-effective when the costs of fabrication, maintenance, and installation are considered. Silicone is available in a variety of standard dies and may be offered in additional configurations according to your requirements.

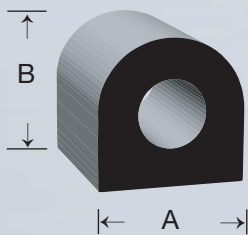

"D" SECTION (with hole)		
PART #	A	B
8490	.3125	.1875
8543	.500	.500

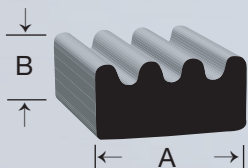
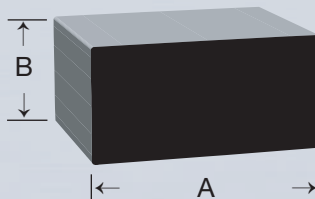

RIBBED SECTIONS		
PART #	A	B
8489	.375	.187
8544	.625	.312
8602	.312	.125

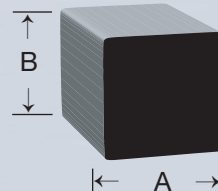

RECTANGLES		
PART #	A	B
8556	.500	.250
8598	.500	.125
8600 ✓	.500	.375
8656	.250	.125
8669 ✓	.750	.375
81117 ✓	1.000	.375
81092 ✓	.750	.375

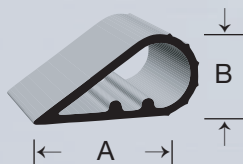

TEARDROP		
PART #	A	B
8325 ✓	.500	.250
8325 Taped	.500	.250

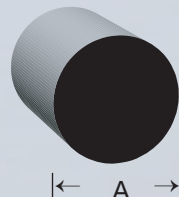

SQUARES		
PART #	A	B
8501 ✓	.500	.500
8604 ✓	.375	.375
8605 ✓	.250	.250

CORDS	
PART #	A
8531	.3750
8536	.2500
8539	.1870
8601 ✓	.1250
8634 ✓	.5000
8753 ✓	.3125

# ADHESIVES

## A New Generation of Adhesives



**Clean Seal continues to be excited about the breakthrough technology for automotive sealing tapes. You simply peel off the liner and press the part into place. This revolutionary 3M™ (ST) sealing tape has an aggressive bonding ability and is specifically designed for automotive and transportation applications.**

**It's Important To Know The Conditions** When attaching your gaskets, you will need some type of adhesive or grip to hold your gasket in place. Whether you chose to attach the gasket by mechanical means (screws) or by a permanent adhesive will depend on your particular circumstances.

It is critical to communicate all conditions that may apply to your specific needs. Heat, moisture, type of surface, painted or unpainted, weather conditions and other factors will all play a part in how well a specific bonding agent will work. Each gasket material reacts differently with specific adhesives. That's why it is so important to let your Clean Seal specialist suggest the correct adhesive method for your special application.

### **Acrylic or Rubber-Based PSA Adhesive?**

Acrylic and rubber-based PSA adhesives are normally used to hold the gasket in place before the gasket is more permanently attached by mechanical fasteners. Acrylic adhesives work best on painted or fiberglass surfaces. Rubber-based adhesives will work better on aluminum, bare metal and stainless steel.

We Use...  
**3M** Automotive  
Sealing Tapes

### **3M™ (ST) Sealing Tape**

Clean Seal uses high tech heat-laminating equipment to thermally bond the revolutionary 3M™ (ST) sealing tape to an extruded seal or gasket part. The thermo process ensures a strong, reliable bond of the adhesive based tape to the gasket. A removable liner protects the adhesive until the gasket is ready to be applied.

To apply, you simply peel off the liner and press the gasket part into place. The part is easy to align and stays in place during application. You can securely attach gaskets to just about any surface without the expense or work of mechanical fasteners or messy contact adhesives. The tape is based on new technology used in automotive sealing applications by increasing wet-out (surface adhesion) and conformability. It builds on the strengths of our (HATS) Heat Activated Tape, by providing 25-30% more adhesion improvement and bonding integrity. This more aggressive bonding ability has been specifically designed for automotive and transportation applications, allowing for superior adhesion to automotive paint surfaces. It also delivers what our customers have been requesting:

- The adhesive carrier is black to give a better visual appearance.
- There's improved performance and wet-out for uneven surfaces.

### **Benefits to our Customer?**

- More contact with the substrate surface provides a better seal against the elements.
- Improved initial adhesion in applications saves labor costs.

It's easy to see why more manufacturers are requesting this product to be applied to their gaskets. Call our Customer Service Department today to find out how we can help improve your application with 3M™ (ST) tape.

# SPLICING AND DIE CUTTING

## Secondary Manufacturing Procedures

Save your company some money. Specialize in what you do well and let Clean Seal® assist you in manufacturing processes they specialize in.

### **DIE CUTTING**

Foam and rubber sheets can be die cut to fit irregular shapes. Gasket materials used around automotive style lights, for example, often need to be hand cut requiring valuable time. Clean Seal® can complete this process by die cutting the shape and reducing valuable labor costs.

### **CUTTING & NOTCHING**

If you need to facilitate the forming of a gasket, you often need to make special cuts for relief points, notches and holes. This takes time and effort. Clean Seal® can make these cuts and drill these holes in-house, saving both time and money.

### **CUT TO SPECIFIC LENGTHS**

Need the extruded rubber gasket cut to a specific length? Why hand measure out each piece? Clean Seal® can do it much more efficiently to save you time and money.

### **VULCANIZING/HOT SPLICING**

A rubber extrusion around a window opening is often the best way to keep the rain and wind out.



Clean Seal® uses the hot splicing/vulcanizing process to chemically bond two ends of a rubber extrusion together. By creating an endless seal, the gasket is more impermeable to the elements. This is especially important when a moving vehicle is involved due to flexing of the parts. The bond is longer lasting and maintains its elastic properties.

Clean Seal® can vulcanize extruded rubber into circles, squares, and a variety of other shapes. From a simple square window to a complex door opening, Clean Seal® can manufacture the endless gasket for your requirements.

### **COLD GLUE SPLICING**

Several methods of splicing, using a variety of adhesives, give you the flexibility of fitting the gasket to your specific needs. Each has advantages and disadvantages.

### **SPLICING TYPES**

- 1 Butt Splice – used for fabricating endless gaskets where there is limited or no strain on the splice.
- 2 Corner Splice – used to form gaskets of special configurations. They provide a satisfactory static seal where the splice is not under a strain.
- 3 Bevel Splice – used as an alternate to the butt splice if the cross sectional area does not allow for a suitable bond using the butt splice.
- 4 Molded Splice – Many gaskets and seals can be produced economically by splicing extruded shapes to form complete gaskets. A radius corner or square corner can be spliced to fit a specified shape.

# SPLICING AND DIE CUTTING

1

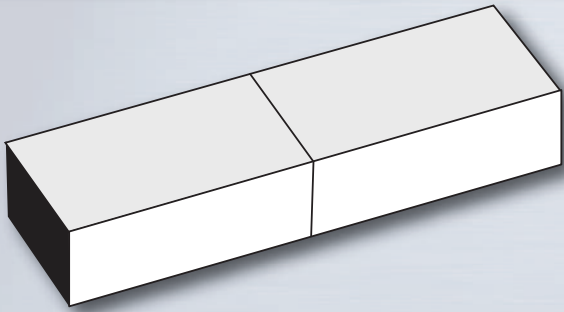

4

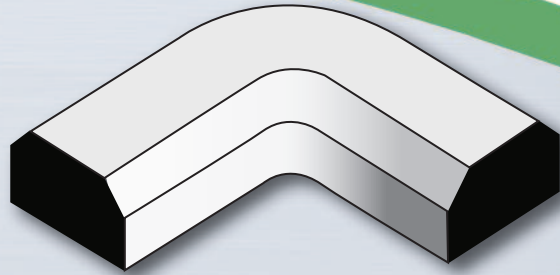

2

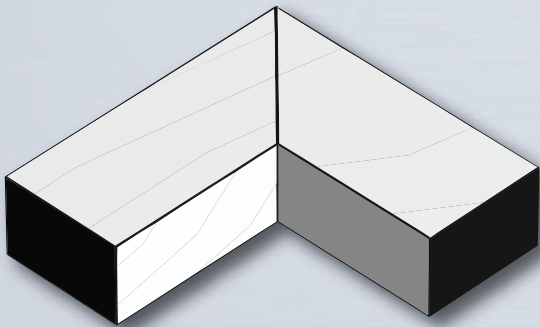

3

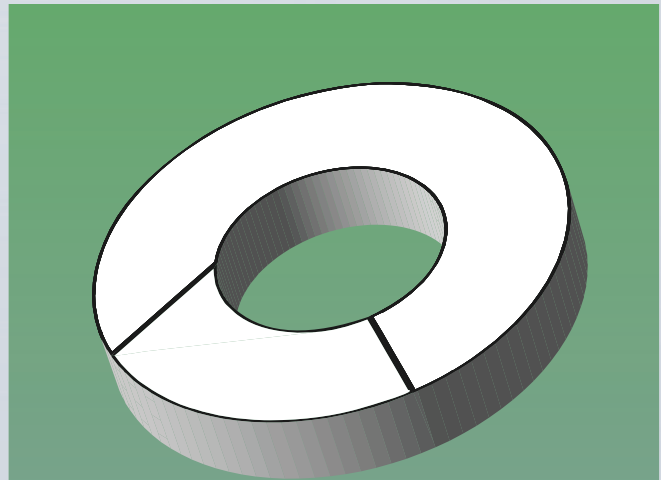
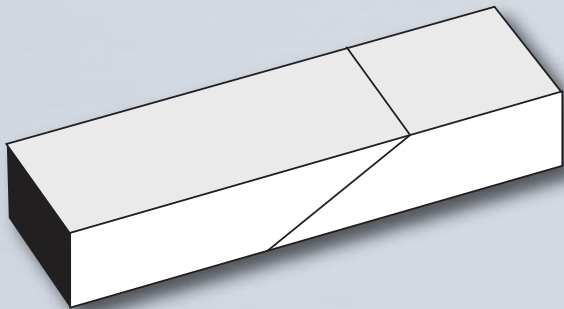

*Endless Gasket*

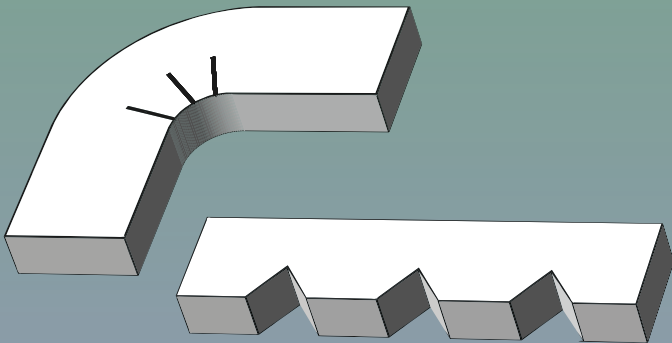

*Multi-notched for Radius Corner*

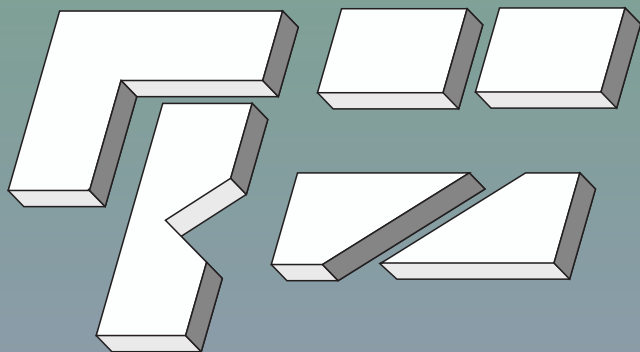

*Notched 90° Corner*



# CLEAN SHIELD

## *Electromagnetic Interference and Radio Frequency Interference*

### **CLEAN SHIELD**

Engineers today are facing an ever-increasing challenge when they're required to design and manufacture electronic devices for the consumer or industrial markets. As the operating frequencies increase and devices become more complex, electronic devices often may be more susceptible to electromagnetic interference (EMI) and radio frequency interference (RFI). Even the most well designed systems generate some level of noise.

Clean Shield is a new line of gaskets specifically designed to control or reduce the undesired electromagnetic interference (EMI) and radio frequency interference (RFI) from disrupting or radiating from electrical devices. Clean Shield consists of a protective shielding fabric covering the foam profile. The seals are available in strip form or precision die-cut shapes and can include a self-adhesive strip for ease of application.

In medical facilities, equipment must always be protected. Diagnostic equipment, X-ray machines, CT imaging scanners and MRI machines are examples that require shielding. All sensitive equipment needs the protection from EMI to operate in the most life-threatening solutions!

Industrial applications such as telephone switching systems and telecommunications equipment for voice and data are also subject to EMI and RFI.





Now Offering

# Dense Rubber



ISO 9001:2008

We have your solution when it comes to custom dense rubber products. Dense is great for heavy duty applications.

**CLEAN SEAL<sup>®</sup>, INC.**



Heavy Duty Trans. Applications

Perfect for...  
Transportation  
Appliance  
Automotive  
Construction  
Marine

*Dense products...*

- Rubber Seals
- Formed Hose
- Window Seals (High Wind)
- Weatherstripping
- Rubber Pad Sheeting
- Anti-Skid Sheeting



Water Tight Seals





# INDUSTRIAL USES FOR EXTRUDED RUBBER SEALS

## ***Growing, Growing, Growing!***

When Clean Seal was organized 36 years ago, our focus was on the recreational vehicle industry. As time went on, we continued to expand into the transportation market supplying seals to the light and heavy duty trucking industry.

Today our products are used in just about every market imaginable. Sealing in or sealing out the elements on tool boxes, large lighted signs, and even the cabins of large earth moving equipment.

Our company receives daily inquiries from an ever expanding industrial market. The diverse customer base that we work with includes applications such as vacuum tables, electrical boxes, outdoor halogen lights, underwater camera cases, refrigerator doors and equipment as well as heavy construction equipment. The addition of Clean Shield (see page 16) gives us confidence this list will grow day by day.

When your manufacturing process needs a superior seal look to Clean Seal for a solution. We can help.





ISO 9001:2008

# BUMPER GUARD

by Clean Seal, Inc.



## *Industrial/Commercial Dock Bumpers*

Loading dock bumpers and protective bumpers are used in a variety of industrial and marine applications. Since Clean Seal, Inc. has been a leader in the seal market since 1978, branching out to this product offering has been an easy choice.

These bumpers add protection to concrete structures of buildings and loading docks. They will also keep the top of semis at a safe distance from the building when a sloped approach has been used.

Clean Seal, Inc. offers many shapes, sizes, colors, and densities of dock bumpers. We can also custom make your bumpers.



## *Placement/Installation of Bumpers*

In most cases, placement of your bumpers will be on a vertical or horizontal plane for optimal protection of dock, truck and cargo protection. This is also true for most marine applications, as many docks/piers will only allow this type of placement.

Installation is very straight forward and incredibly easy. With a few simple and readily available tools, mark your placement holes by holding the bumper against the wall or pier. Pre-drill your holes at your marked locations and screw into place. You will need to use anchor bolts if you're mounting the bumper to a concrete structure. 4" anchor bolts are suggested for most applications.



# FLIP-N-SEAL™



PATENT PENDING

ISO 9001:2008



## Slide Out Sealing System

With impressive new features unlike any other seal in the marketplace. Easy to install, more efficient inventory management and cross-platform features. You no longer need to purchase a seal to accommodate different wall thickness or wiper lengths.



### Key Features:

- Unique Integrated Bulb Design
- Specially Designed Wiper Tip
- 3M ST1200 Adhesive
- Low Friction Coating
- Foldable Leg
- Specially Blended Compound for Application

### Key Attributes:

- Less scrap
- Lower cost
- Simple installation
- Supplied in coiled lengths
- Fits all sidewalls 1.125" to 2.375"
- Single SKU for all slide room sizes
- One part integrated system design
- Reduced friction / drag on slide mechanics
- Can be used as single or double wipe / bulb

### Packaging

- No long cut lengths
- All seals in one box
- Easier shipping to our customers
- Easily staged online in S/O department
  - All boxes are 42" x 42" skid able
- Coil packaging creates smaller footprint of box
- Available in low box quantity to bulk quantities

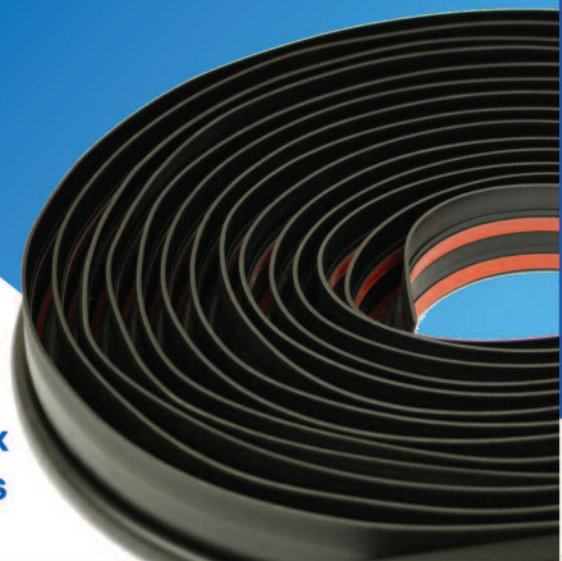

CLEAN SEAL®, INC.

NEW INDUSTRY STANDARD

# Quality Molded Products



## Stock Standard Molded Products

Clean Seal, Inc. Molded Specialties stocks many standard parts for fast order completion and delivery. We currently stock or have access to close to 500 molded products. Our extensive product line includes...

- Rubber Grommets
- Grommet Bumpers
- Dock Bumpers
- Recessed Bumpers
- Stem Bumpers
- Stick-On Bumpers
- Extruded Bumpers
- O-Rings
- Lab Stoppers
- Bushings
- Suction Cups
- Vibration Mounts
- Crutch Tips
- Extruded Shapes
- Mil Spec Grommets
- Stud, Feet, and Mounts

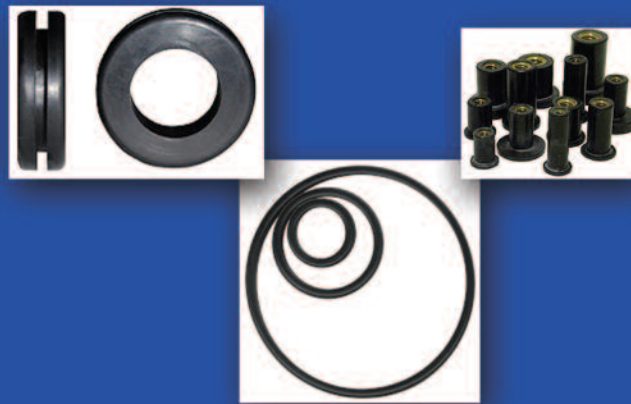

The applications for these products are many. We have been serving the trailer, R.V., truck, and marine industry for some time with these molded products. With our new stock Molded Specialties line we have opened up our product offerings to hundreds of other industries.

## Stock Standard Options

With each of our stock product offerings, there will be a numerous amount of options to choose from including materials, hardness, styles, and even custom colors (This is a custom option. Please call for quote). Some of our material options include natural rubber, neoprene, SBR, EPDM and buna-nitrile.

## Custom Molded Products

Clean Seal, Inc. Molded Specialties also specializes in creating custom rubber solutions for many different types of applications with very affordable tooling. Call us today for your quote.

**CLEAN SEAL, INC.<sup>®</sup>**  
**MOLDED SPECIALTIES**

# DECIMAL AND MILLIMETER EQUIVALENT

Find Your Measurements...

Milli-meter	Decimal	Fraction (inches)	Milli-meter	Decimal	Fraction (inches)	Milli-meter	Decimal	Fraction (inches)	Milli-meter	Decimal	Fraction (inches)	Milli-meter	Decimal	Fraction (inches)
0.1	.0039		5.159	.2031	13/64	10.2	.4016		15.3	.6024		20.3	.7992	
0.2	.0079		5.2	.2047		10.3	.4055		15.4	.6063		20.4	.8031	
0.3	.0118		5.3	.2087		10.319	.4063	13/32	15.478	.6094	39/64	20.5	.8071	
0.397	.0156	1/64	5.4	.2126		10.4	.4094		15.5	.6102		20.6	.8110	
0.4	.0157		5.5	.2165		10.5	.4134		15.6	.6142		20.638	.8125	13/16
0.5	.0197		5.556	.2188	7/32	10.6	.4173		15.7	.6181		20.7	.8150	
0.6	.0236		5.6	.2205		10.7	.4213		15.8	.6220		20.8	.8189	
0.7	.0276		5.7	.2244		10.716	.4219	27/64	15.875	.6250	5/8	20.9	.8228	
0.794	.0313	1/32	5.8	.2283		10.8	.4252		15.9	.6260		21.0	.8268	
0.8	.0315		5.9	.2323		10.9	.4291		16.0	.6299		21.034	.8281	53/64
0.9	.0354		5.953	.2344	15/64	11.0	.4331		16.1	.6339		21.1	.8307	
1.0	.0394		6.0	.2362		11.1	.4370		16.2	.6378		21.2	.8346	
1.1	.0433		6.1	.2402		11.113	.4375	7/16	16.272	.6406	41/64	21.3	.8386	
1.191	.0469	3/64	6.2	.2441		11.2	.4409		16.3	.6417		21.4	.8425	
1.2	.0472		6.3	.2480		11.3	.4449		16.4	.6457		21.431	.8438	27/32
1.3	.0512		6.350	.2500	1/4	11.4	.4488		16.5	.6496		21.5	.8465	
1.4	.0551		6.4	.2520		11.5	.4528		16.6	.6535		21.6	.8504	
1.5	.0591		6.5	.2559		11.509	.4531	29/64	16.669	.6563	21/32	21.7	.8543	
1.588	.0625	1/16	6.6	.2598		11.6	.4567		16.7	.6575		21.8	.8583	
1.6	.0630		6.7	.2638		11.7	.4606		16.8	.6614		21.828	.8594	55/64
1.7	.0669		6.747	.2656	17/64	11.8	.4646		16.9	.6654		21.9	.8622	
1.8	.0709		6.8	.2677		11.9	.4685		17.0	.6693		22.0	.8661	
1.9	.0748		6.9	.2717		11.906	.4688	15/32	17.066	.6719	43/64	22.1	.8701	
1.984	.0781	5/64	7.0	.2756		12.0	.4724		17.1	.6732		22.2	.8740	
2.0	.0787		7.1	.2795		12.1	.4764		17.2	.6772		22.225	.8750	7/8
2.1	.0827		7.144	.2813	9/32	12.2	.4803		17.3	.6811		22.3	.8780	
2.2	.0866		7.2	.2835		12.3	.4843		17.4	.6850		22.4	.8819	
2.3	.0906		7.3	.2874		12.303	.4844	31/64	17.463	.6875	11/16	22.5	.8858	
2.381	.0938	3/32	7.4	.2913		12.4	.4882		17.5	.6890		22.6	.8898	
2.4	.0945		7.5	.2953		12.5	.4921		17.6	.6929		22.622	.8906	57/64
2.5	.0984		7.541	.2969	19/64	12.6	.4961		17.7	.6968		22.7	.8937	
2.6	.1024		7.6	.2992		12.7	.5000	1/2	17.8	.7008	45/64	22.8	.8976	
2.7	.1063		7.7	.3031		12.8	.5039		17.859	.7031		22.9	.9016	
2.778	.1094	7/64	7.8	.3071		12.9	.5079		17.9	.7047		23.0	.9055	
2.8	.1102		7.9	.3110		13.0	.5118		18.0	.7087		23.019	.9063	29/32
2.9	.1142		7.938	.3125	5/16	13.097	.5156	33/64	18.1	.7126		23.1	.9094	
3.0	.1181		8.0	.3150		13.1	.5157		18.2	.7165		23.2	.9134	
3.1	.1220		8.1	.3189		13.2	.5197		18.256	.7188	23/32	23.3	.9173	
3.175	.1250	1/8	8.2	.3228		13.3	.5236		18.3	.7205		23.4	.9213	
3.2	.1260		8.3	.3268		13.4	.5276		18.4	.7244		23.416	.9219	59/64
3.3	.1299		8.334	.3281	21/64	13.494	.5313	17/32	18.5	.7283		23.5	.9252	
3.4	.1339		8.4	.3307		13.5	.5315		18.6	.7323	47/64	23.6	.9291	
3.5	.1378		8.5	.3346		13.6	.5354		18.653	.7344		23.7	.9331	
3.572	.1406	9/64	8.6	.3386		13.7	.5394		18.7	.7362		23.8	.9370	
3.6	.1417		8.7	.3425		13.8	.5433		18.8	.7402		23.813	.9375	15/16
3.7	.1457		8.731	.3438	11/32	13.891	.5469	35/64	18.9	.7441		23.9	.9409	
3.8	.1496		8.8	.3465		13.9	.5472		19.0	.7480		24.0	.9449	
3.9	.1535		8.9	.3504		14.0	.5512		19.050	.7500	3/4	24.1	.9488	
3.969	.1563	5/32	9.0	.3543		14.1	.5551		19.1	.7520		24.2	.9528	
4.0	.1575		9.1	.3583		14.2	.5591		19.2	.7559		24.209	.9531	61/64
4.1	.1614		9.128	.3594	23/64	14.288	.5625	9/16	19.3	.7598		24.3	.9567	
4.2	.1654		9.2	.3622		14.3	.5630		19.4	.7638	49/64	24.4	.9606	
4.3	.1693		9.3	.3661		14.4	.5669		19.447	.7656		24.5	.9646	
4.366	.1719	11/64	9.4	.3701		14.5	.5709		19.5	.7677		24.6	.9685	
4.4	.1732		9.5	.3740		14.6	.5748		19.6	.7717		24.606	.9688	31/32
4.5	.1772		9.525	.3750	3/8	14.684	.5781	37/64	19.7	.7756		24.7	.9724	
4.6	.1811		9.6	.3780		14.7	.5787		19.8	.7795		24.8	.9764	
4.7	.1850		9.7	.3819		14.8	.5827		19.844	.7813	25/32	24.9	.9803	
4.763	.1875	3/16	9.8	.3858		14.9	.5866		19.9	.7835		25.0	.9843	
4.8	.1890		9.9	.3898		15.0	.5906		20.0	.7874		25.003	.9844	63/64
4.9	.1929		9.922	.3906	25/64	15.081	.5938	19/32	20.1	.7913		25.1	.9882	
5.0	.1969		10.0	.3937		15.1	.5945		20.2	.7953		25.2	.9921	
5.1	.2008		10.1	.3976		15.2	.5984		20.241	.7969	51/64	25.3	.9961	
												25.400	1.0000	1

# CLEAN GRIP

**DIE IDENTIFICATION KEY:** ▲ EPDM ■ Neoprene\* ● Nitrile ★ Dense ✓ Non Stock Item - Minimum Requirement  
**FS Flange Size**

A "W" included in the part number or the word "White" indicates that the part is white. All other parts are black.  
 \* It is recommended that only 3M™ HATS adhesive be used with all Neoprene profiles.

Clean Grip is an economical way to secure decorative trims and/or functional seals and gaskets. It's one of the easiest and fastest trims to install. There's no need for rivet holes to be drilled, no screws are required. Clean Grip simply clamps on.

The heart of the Clean Grip system is the continuous flexible coated steel core. The core grips the flange providing a professional, simple and low cost assembly method to attach seals and gaskets or decorative trims. To install, start the Clean Grip over the flange and push it on. It's just that simple.

It takes less time and provides a professional look unmatched by many other trims. Clean Grip is available in a variety of designs to fit almost every need.

Call today and let us help you find just the right design for your application.

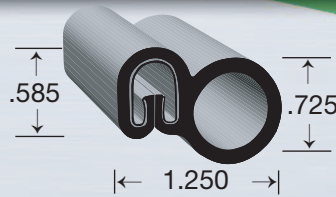

**G-7002 ▲(FS: .125" - .25")**

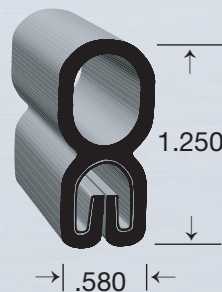

**G-7003 ▲(FS: .125" - .25")**

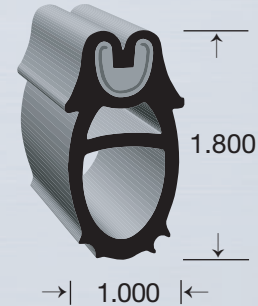

**G-7004 ▲ ✓(FS: .125" - .25")**  
**G-7004PW ▲ ✓(FS: .125" - .25")**

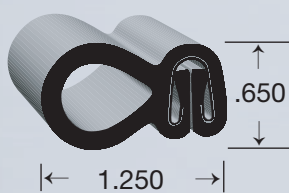

**G-7006 ▲(FS: .125" - .25")**

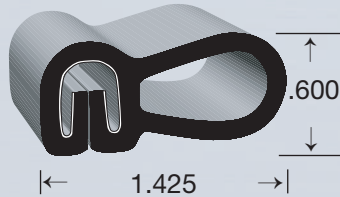

**G-7007 ▲(FS: .125" - .25")**  
**G-7007W ▲ ✓(FS: .125" - .25")**

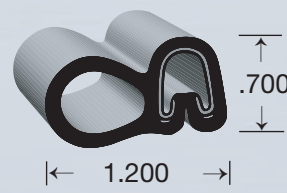

**G-7009 ▲ ✓(FS: .125")**

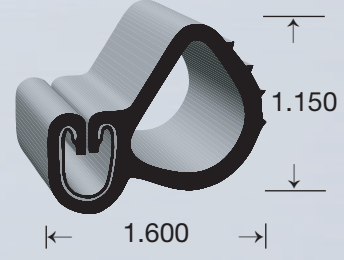

**G-7010 ▲(FS: .125" - .25")**  
**G-7010PW ▲ ✓(FS: .125" - .25")**

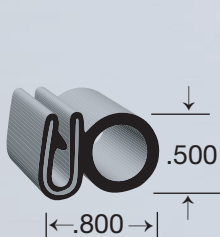

**G-7011-S ▲(FS: .125")**

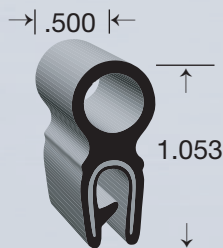

**G-7011-T ▲(FS: .125")**  
**G-7011-TW ▲ ✓(FS: .125")**

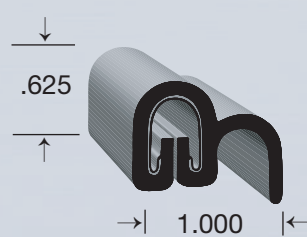

**G-7012 ▲ ✓(FS: .125")**

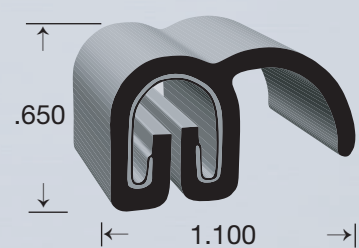

**G-7013 ▲(FS: .125" - .25")**

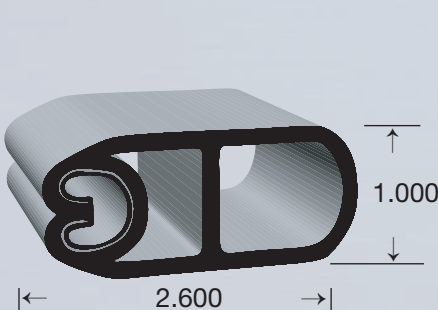

**G-7014 ▲ ✓(FS: .125")**

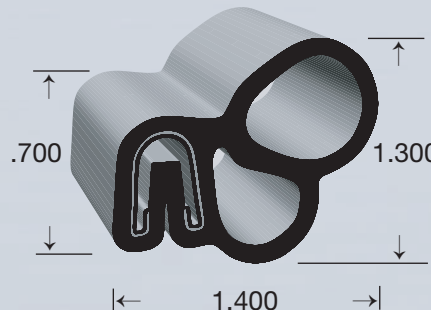

**G-7015 ▲(FS: .25")**

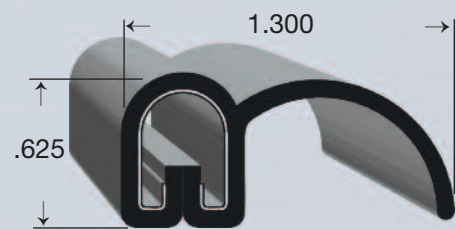

**G-7146 ▲ ✓(FS: .125" - .25")**

# CLEAN GRIP

**DIE IDENTIFICATION KEY:** ▲ EPDM ■ Neoprene\* ● Nitrile ★ Dense ✓ Non Stock Item - Minimum Requirement  
**FS Flange Size**

A "W" included in the part number or the word "White" indicates that the part is white. All other parts are black.  
 \* It is recommended that only 3M™ HATS adhesive be used with all Neoprene profiles.



**G-7018 / G-7025 (FS: .125")**

Part #	A	B
G-7018 ▲	3.375	.200
G-7025PW ▲✓	2.100	.150

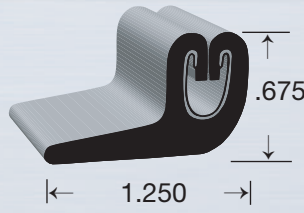

**G-7019 ▲✓(FS: .125")**

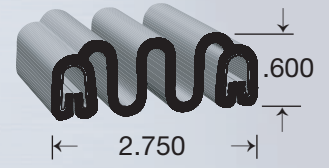

**G-7020-B ▲ ✓(FS: .125")**

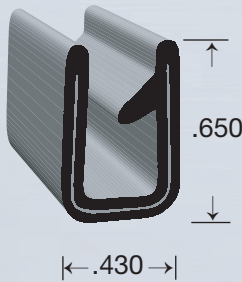

**G-7021 ✓(FS: .219")**



**G-7022 ▲(FS: .125")**

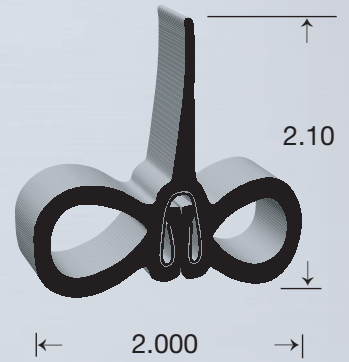

**G-7024 ▲(FS: .125")**

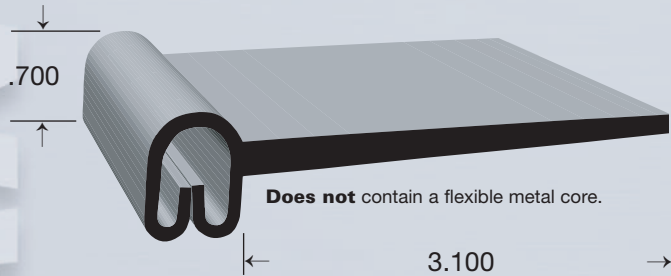

**G-7027 ▲✓**  
**G-7027W ▲ ✓**

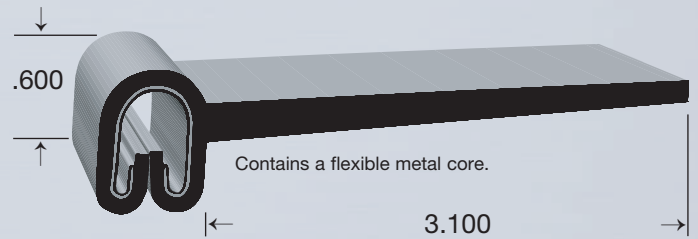

**G-7027A ▲ ✓(FS: .125")**  
**G-7027W-A ▲ ✓(FS: .125")**

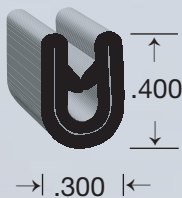

**G-7030 ✓(FS: .094")**  
**G-7030W ✓(FS: .094")**

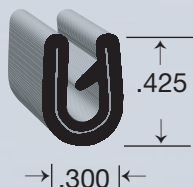

**G-7031 ✓(FS: .094")**

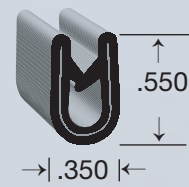

**G-7032 (FS: .125")**

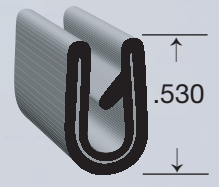

**G-7033 (FS: .125")**  
**G-7033PW ✓(FS: .125")**

# CLEAN GRIP

**DIE IDENTIFICATION KEY:** ▲ EPDM ■ Neoprene\* ● Nitrile ★ Dense ✓ Non Stock Item - Minimum Requirement  
**FS Flange Size**

A "W" included in the part number or the word "White" indicates that the part is white. All other parts are black.  
 \* It is recommended that only 3M™ HATS adhesive be used with all Neoprene profiles.

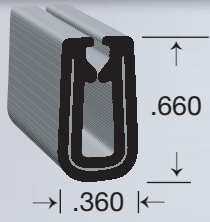

G-7034 ✓ (FS: .156")

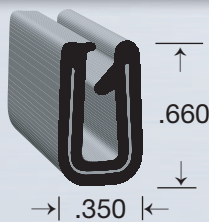

G-7035 ✓ (FS: .125")  
 G-7035W ✓ (FS: .125")

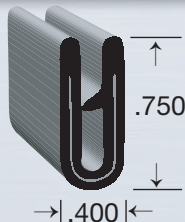

G-7038 (FS: .156")

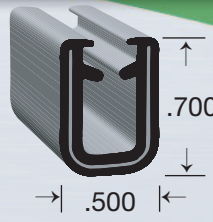

G-7041 ✓ (FS: .313")

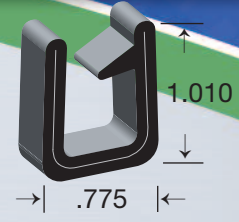

G-7090 ✓ (FS: .5")



G-7042-B ▲ ✓ (FS: .125")

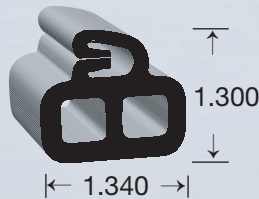

G-7043 ▲ ✓ (FS: .125")  
 G-7043W ▲ ✓ (FS: .125")

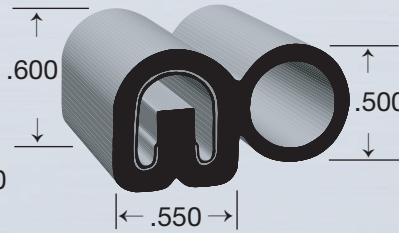

G-7046 ▲ (FS: .125")

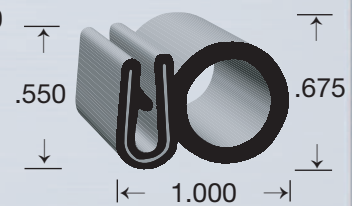

G-7056 ▲ (FS: .125")  
 G-7056W ▲ ✓ (FS: .125")

G-7057 / G-7058 / G-7058PW (FS: .125")

PART #	A	B
G-7057 ▲ ✓	1.300	2.000
G-7058 ▲	1.550	2.000
G-7058PW ▲ ✓	1.550	2.000

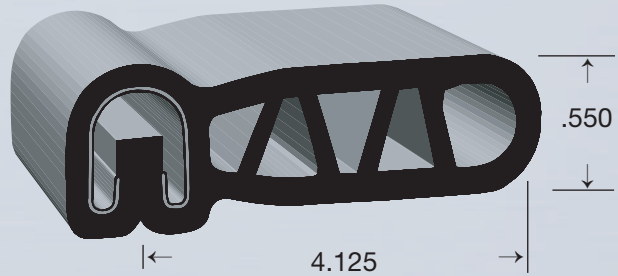
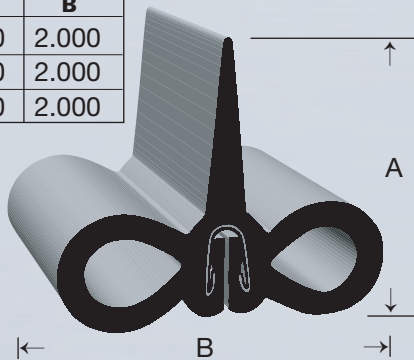

G-7059 ▲ ✓ (FS: .125")

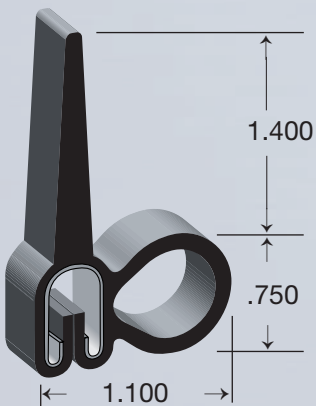

G-7061 ▲ ✓ (FS: .125")

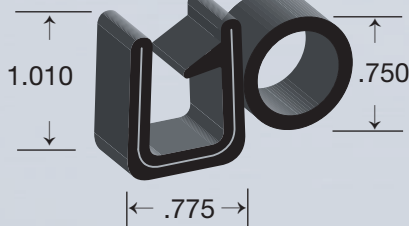

G-7093W ▲ ✓ (FS: .5")



G-7099 ▲ ✓ (FS: .125")

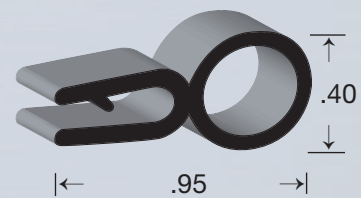

G-7100 ▲ ✓ (FS: .125")

We Use...  
**3M** Automotive Sealing Tapes



# CLEAN GRIP

**DIE IDENTIFICATION KEY:** ▲ EPDM ■ Neoprene\* ● Nitrile ★ Dense ✓ Non Stock Item - Minimum Requirement  
**FS Flange Size**

A "W" included in the part number or the word "White" indicates that the part is white. All other parts are black.  
 \* It is recommended that only 3M™ HATS adhesive be used with all Neoprene profiles.



**G-7066** ▲ ✓(FS: .0625")

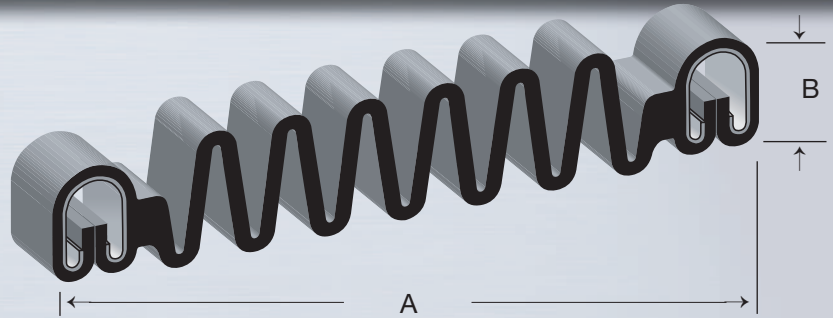

**G-7060 / G-7065**

PART #	A	B	Stretched
G-7060 ▲ ✓	5.000	.655	15.000
Does not contain a flexible metal core.			
G-7065 ▲ ✓(FS: .125")	4.000	.655	10.000

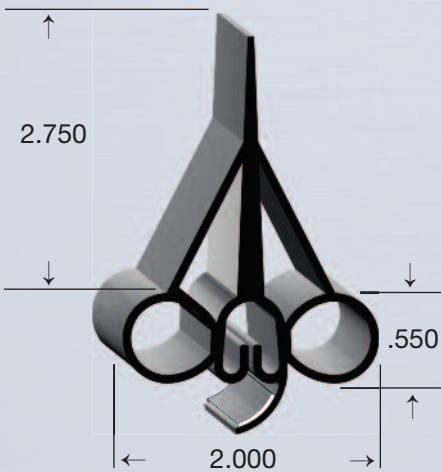

**G-7135ST** ▲ ✓

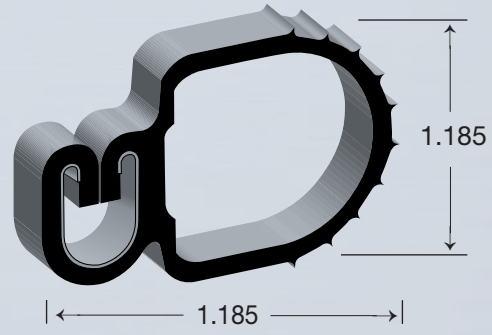

**G-7067** ▲ ✓(FS: .125")

## Automotive Style Encapsulated Seals

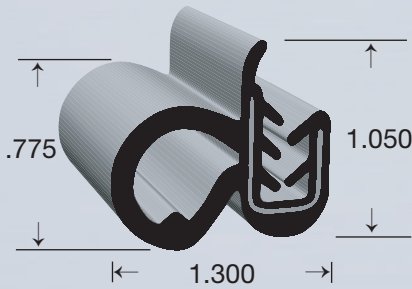

**G-7053** ▲ (FS: .25")

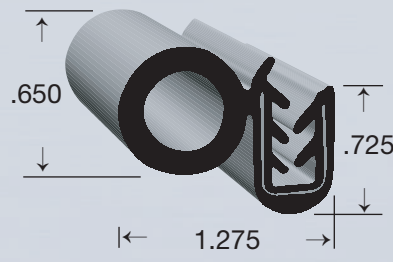

**G-7054** ▲ (FS: .25")

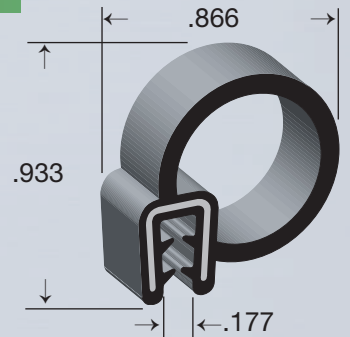

**G-7091** ✓(FS: .125")

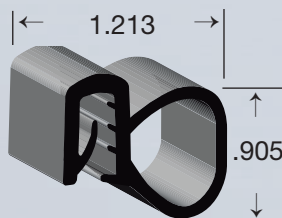

**G-7123** ▲ ✓(FS: .125")

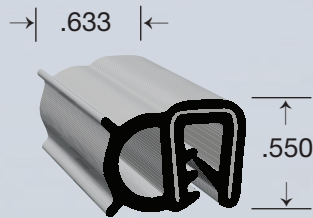

**G-7124** ▲ (FS: .125")

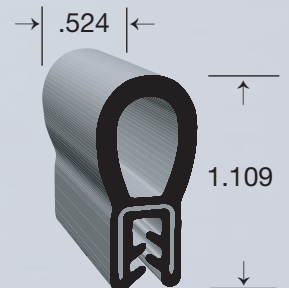

**VG-12601T** ▲ (FS: .1718")

# CLEAN GRIP

**DIE IDENTIFICATION KEY:** ▲ EPDM ■ Neoprene\* ● Nitrile ★ Dense ✓ Non Stock Item - Minimum Requirement  
**FS Flange Size**

A "W" included in the part number or the word "White" indicates that the part is white. All other parts are black.  
 \* It is recommended that only 3M™ HATS adhesive be used with all Neoprene profiles.

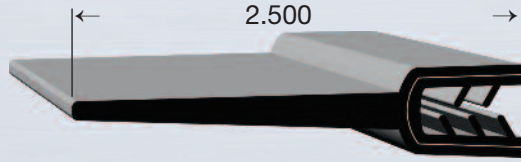

**G-7145 ▲ ✓ (FS: .25")**

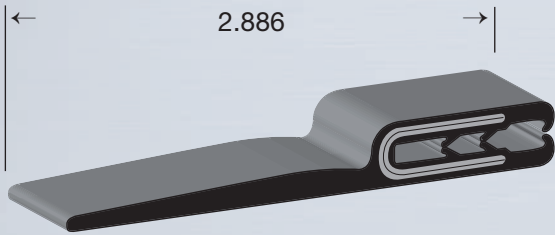

**ZML-6701-01 ▲ ★ ✓ (FS: .087")**

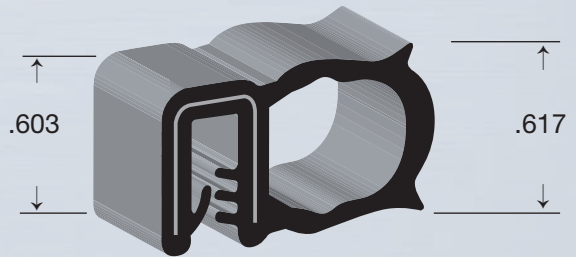

**ZML-6702 ▲ (FS: .172")**



**ZML-6703 ▲ ✓ (FS: .116")**

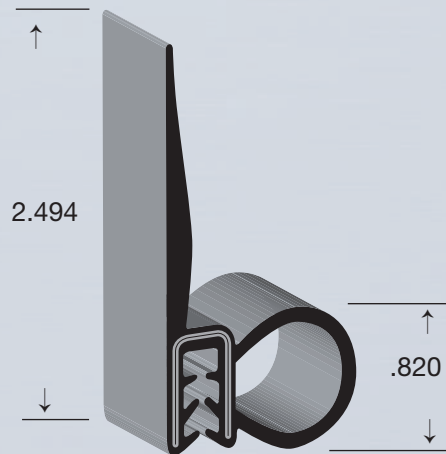

**ZML-6704 ▲ (FS: .258")**

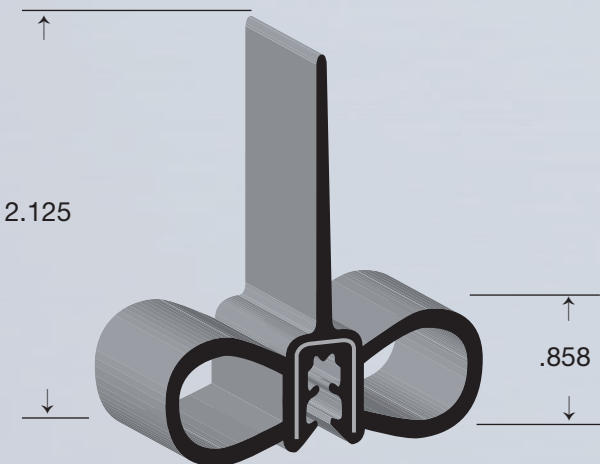

**ZML-6705 ▲ ★ (FS: .232")**

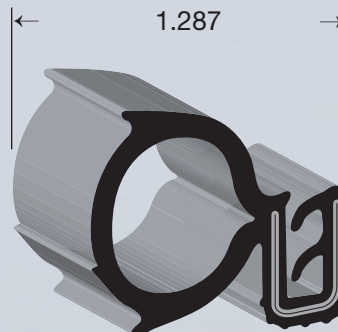

**ZML-6706 ▲ (FS: .182")**

We Use...  
**3M** Automotive  
 Sealing Tapes

# CLEAN GRIP

**DIE IDENTIFICATION KEY:** ▲ EPDM ■ Neoprene\* ● Nitrile ★ Dense ✓ Non Stock Item - Minimum Requirement

A "W" included in the part number or the word "White" indicates that the part is white. All other parts are black.  
\* It is recommended that only 3M™ HATS adhesive be used with all Neoprene profiles.

## Regular Trim

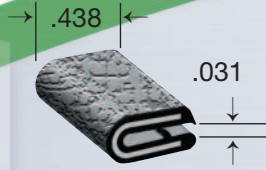

T-75B3X1/32 • Black Pebble

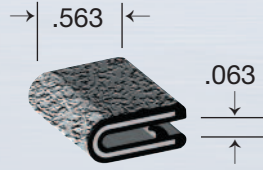

T-100B3x1/16 • Black Pebble  
T-100B7x1/16 • Black Sand  
T-100T1x1/16 • Tan Course Pebble  
T-100W1x1/16 • White Course Pebble

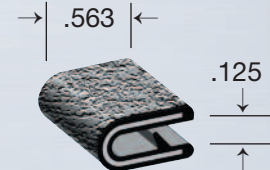

T-100B3x1/8 • Black Pebble  
T-100LB1x1/8 • Light Beige Course Pebble  
T-100T1x1/8 • Tan Course Pebble  
T-100W1x1/8 • White Course Pebble

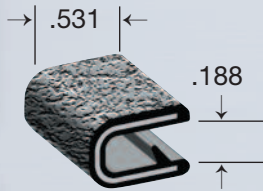

T-100B3x3/16 • Black Pebble  
T-100T1x3/16 • Tan Course Pebble  
T-100W1x3/16 • White Course Pebble

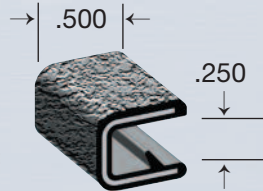

T-100B3x1/4 • Black Pebble

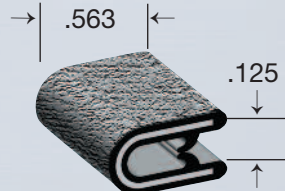

T-150B2x1/8 • Black Leather

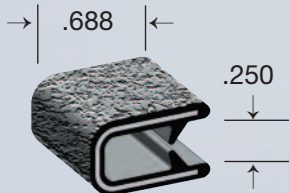

T-1350B2x1/4 • Black Leather

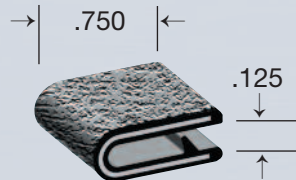

T-1375W3x1/8 • White Pebble

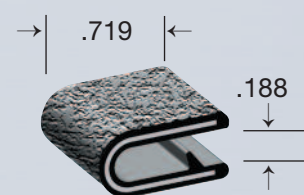

T-1375B3x3/16 • Black Pebble  
T-1375W3x3/16 • White Pebble

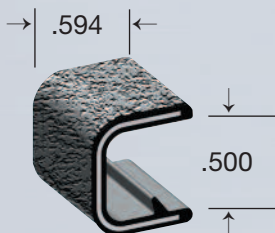

T-1375B3x1/2 • Black Pebble

## HOW TO ORDER

- 1) Determine thickness of your material.
- 2) Select the proper trim series to correspond with the flange length of your material.
- 3) Determine order quantity in 250 foot increments.

Minimum requirements vary per part.



# CLEAN GRIP

**DIE IDENTIFICATION KEY:** ▲ EPDM ■ Neoprene\* ● Nitrile ★ Dense ✓ Non Stock Item - Minimum Requirement

A "W" included in the part number or the word "White" indicates that the part is white. All other parts are black.  
 \* It is recommended that only 3M™ HATS adhesive be used with all Neoprene profiles.

## Trim Seals

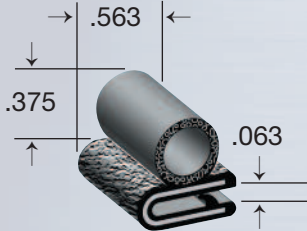

**T-3100B3x1/16A • Black Pebble**  
 3/8" Bulb Located on Side

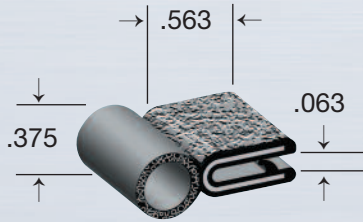

**T-3100B3x1/16C • Black Pebble**  
 3/8" Bulb Located on End

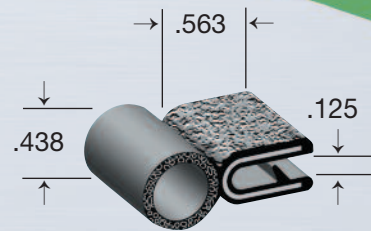

**T-4100B3x1/8C • Black Pebble**  
 7/16" Bulb Located on End

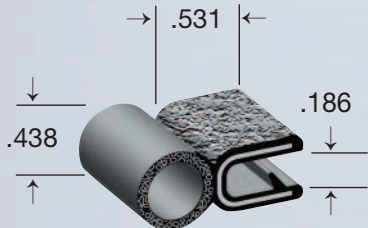

**T-4100B3x3/16C • Black Pebble**  
 7/16" Bulb Located on End

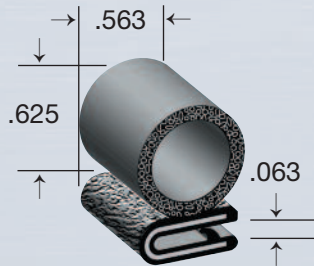

**T-6100B3x1/16A • Black Pebble**  
 5/8" Bulb Located on Side

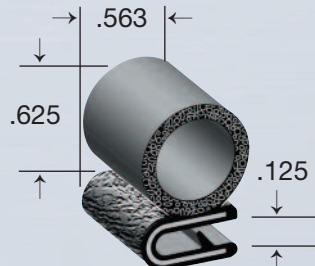

**T-6100B3x1/8A • Black Pebble**  
 5/8" Bulb Located on Side

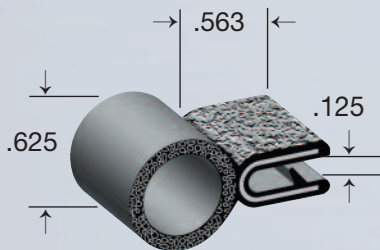

**T-6100B3x1/8C • Black Pebble**  
 5/8" Bulb Located on End

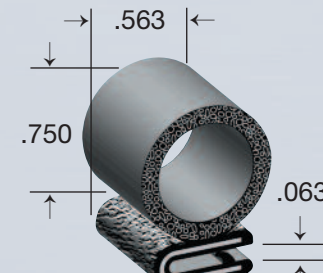

**T-7100B3x1/16A • Black Pebble**  
 3/4" Bulb Located on Side

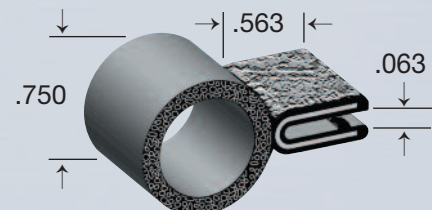

**T-7100B3x1/16C • Black Pebble**  
 3/4" Bulb Located on End

## Decorative Trim

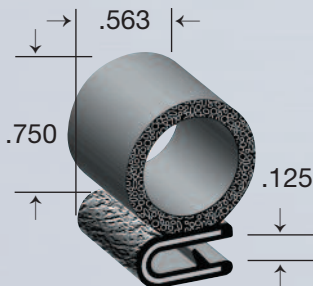

**T-7100B3x1/8A • Black Pebble**  
 3/4" Bulb Located on Side

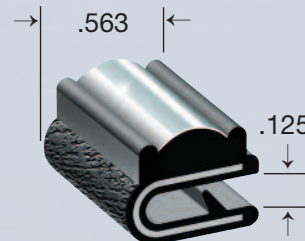

**T-8100B3x1/8 • Chrome Trim Black Pebble**

















We Use...  
**3M** Automotive  
 Sealing Tapes

# CLEAN TRIM MOLDINGS

Clean Trim is the premier aftermarket moldings used by manufacturers and refitters as the original equipment molding. A large assortment of molding is available for the sides of automobiles, wheel wells, door edges, sills, running boards, drip rails, step treads and van window inserts.



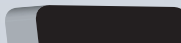

Some products available in a variety of popular colors.

## Universal Moldings



Profile	Profile Number	Width	Lengths
	<b>C600</b> colors: 02,04,05,07,08,10,14	9/16"	16' 50'
	<b>602</b> - All Black	9/16"	50'
	<b>CM44-00</b> colors: 02,04,05,10,14	7/8"	26'
	<b>PC02</b> - All Black	3/4"	16' 42'
	<b>8002E</b> - Black Embossed <b>8002S</b> - Black Smooth	1"	20' 50' 100'
	<b>2502E</b> - Black Embossed <b>2502S</b> - Black Smooth	2"	20' 50' 100'
	<b>3502E</b> - Black Embossed <b>3502S</b> - Black Smooth	3-1/4"	16' 50'
	<b>M300</b> colors: 01,02,06	9/32"	20' 50'
	<b>0300</b> colors: 01,02,04,05,06,08,10,14	7/16"	20' 50' 150'
	<b>900</b> colors: 01,02,06	5/8"	20' 50' 100'
	<b>CM88-00</b> colors: 02,04	1"	42'
	<b>1402HG</b> - All Black	1-3/8"	20' 50'
	<b>BT01</b> - Chrome Only	1"	30'
	<b>1401</b> - Chrome Only	1-3/8"	50'
	<b>99GT-00</b> colors: 01,02	2"	50'
	<b>PP01</b> - All Chrome	7/8"	20' 50'
	<b>CMV01</b> - All Chrome <b>CMV02</b> - All Black	1-1/2"	20' 50'



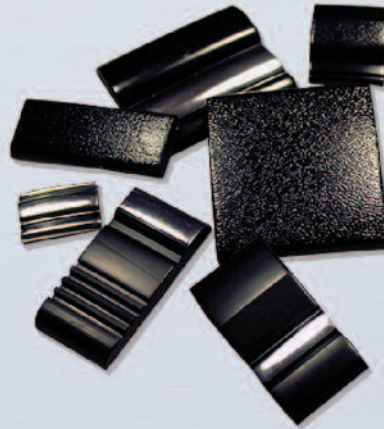

# CLEAN TRIM MOLDINGS

See the Clean Trim Catalog for the complete listing of profiles that are available!

<b>Lip Trim</b>			
Profile	Profile Number	Width	Length
	<b>NE00</b> colors: 01,06	5/16"	50' 150'
	<b>WLS02</b> - Black	15/32"	50'
	<b>WLS01</b> - Black & Chrome		150' 750'
	<b>WW2-NT</b> - Black	11/16"	20'
	<b>WW2-WC</b> - Black & Chrome		50' 300'



<b>Drip Rail</b>			
Profile	Profile Number	Width	Length
	<b>DR02</b> - Black	5/8"	50'
	<b>WRT02</b> - Black		50' 100'

<b>Edge Trim Moldings</b>			
Profile	Profile Number	Width	Length
	<b>M402A</b> - All Black	1/4"	50' 500'
	<b>400</b> colors: 01,02,04,05,06, 08,10,14	9/32"	50' 150'
	<b>21</b> - Chrome <b>22</b> - Black <b>26</b> - Gold	5/16"	50' 150'
	<b>22L</b> - Black	1/2"	50'
	<b>NC02</b> - Black <b>NC00</b> - Clear		5/16"

<b>Colors for Moldings</b>		
01-CHROME	05-DARK BLUE	08-ADOBE BEIGE
02-BLACK	06-GOLD	10-DARK RED
04-WHITE	07-DARK GREEN	14-SILVER

<b>Step Tread</b>			
Profile	Profile Number	Width	Length
	<b>SS02</b> - All Black	2"	100'
	<b>ST Series NL</b> - All Black (No Lip)	2", 2.5", 3" 3.5" to 7"	100' 50'
	<b>ST Series WL</b> - All Black (With Lip)	3" to 6"	50'





**CLEAN SEAL<sup>®</sup> INC.**

*Now Offering*

**CLEAN SPRING**

SPRING & STAMPING DIVISION

ISO 9001:2008



**Compression Springs**

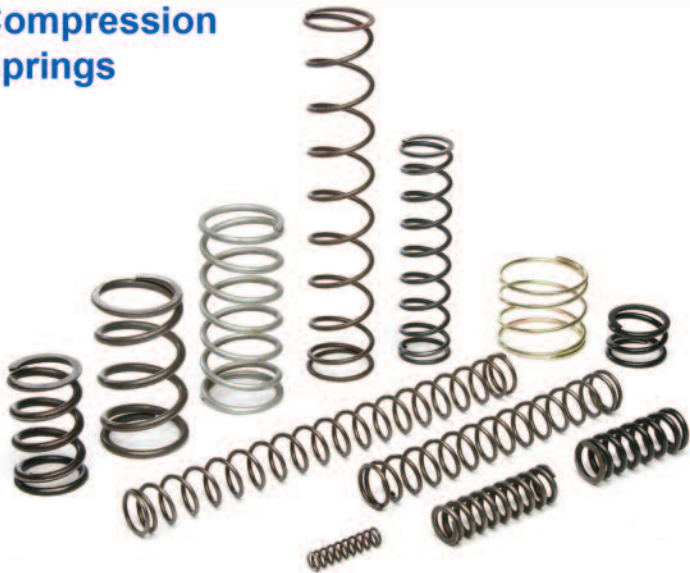

**Tension Springs**



**Extension Springs**



# Gun "SPRING" Schematic

# CLEAN Spring

A div. of:



- 1 - OD Swivel
- 2 - Spring, Weld (Wave)
- 3 - Spring, Trigger
- 4 - Spring, Hammer
- 5 - Spring, Buffer Retainer
- 6 - Spring, Index
- 7 - Spring, Disconnect
- 8 - Take Down Detent
- 9 - Spring, Detent Takedown Pin
- 10 - Spring, Magazine Catch
- 11 - Pin, Trigger
- 12 - Pin, Rear Take Down
- 13 - Pin, Front Pivot
- 14 - Spring, Ejector & Safety Detent
- 15 - Pin, Extractor
- 16 - Spring, Front Sight Detent
- 17 - Ring, Bolt Gas
- 18 - Spring, Ejector Port
- 19 - Spring, Carb Buffer
- 20 - Spring, Charging Handle Latch

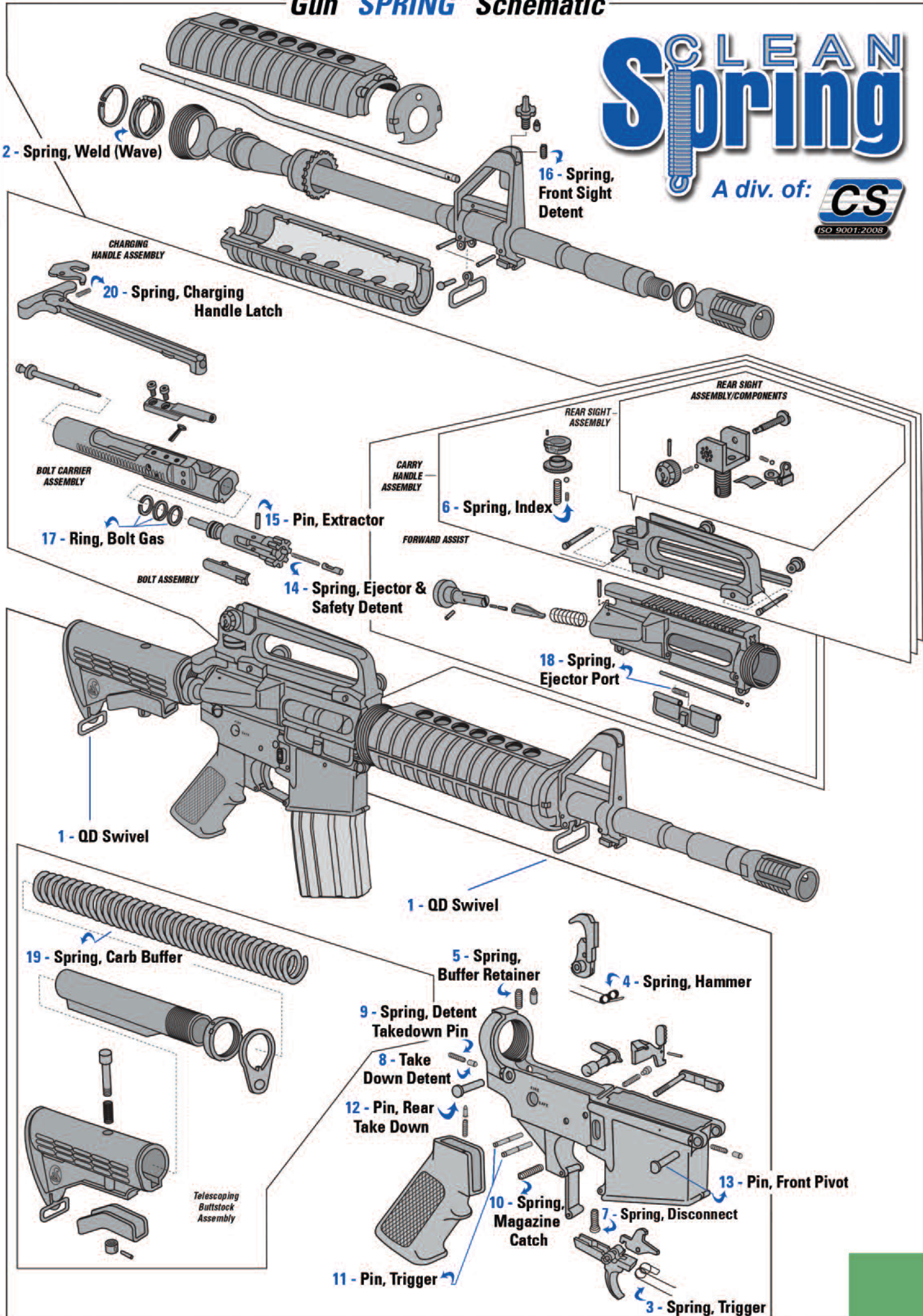



## Hose Protectors

Hose Protectors are durable wear shields made of an abrasion resistant material. Easily attached to almost any size or type hose, the Hose Protector prevents up to 90% of all hose failure due to wear at points of contact.

- \* Extremely high wear factor
- \* Resists solvents, oils, grease, gasoline, etc
- \* Grooves protect cable ties and prevent slipping
- \* Prevents damage from unrestrained hoses
- \* Operating temperature range of -40 to +430 F
- \* Available in five sizes - 4", 6", 8", 10"
- \* All sizes available in Black, Orange or Yellow

Abrasion Protection For:

- \* Hydraulic Hoses
- \* Battery Cables
- \* Wiring Harness
- \* Brake Systems
- \* Fuel Lines
- \* Air Lines
- \* Radiator Hoses
- \* Oil Lines

### Easy Installation in Minutes - No need to remove hose

- Step One - Locate problem area on hose
- Step Two - Place Hose Protector over problem area
- Step Three - Install Cable Ties, pulling tight with pliers
- Step Four - Cut off excess Cable Ties leaving the hose safely shielded



## Hose Spacers and Looms

Hose Spacers & Looms are accessories used to simplify routing and prevent damage from unrestrained hoses. Easy to install and provide protection by separating hoses from points of abrasion and contact. They are constructed using an impact resistant material which gives them high strength, abrasion and chemical resistance and provides for a wide range of operating conditions. This allows Hose Spacers & Looms to withstand the constant impact that many assemblies endure.

### Hose Spacer

- \* Prevents hose abrasion
- \* Helps keep hoses organized
- \* Prevents damage from unrestrained hoses
- \* Easy to install

### Available Sizes

- \* 5/8"
- \* 3/4" #
- \* 1" #
- \* 1 1/8" #
- \* 1 3/8" #

### Hose Loom

- \* Prevents hose abrasion
- \* Keeps multiple hoses organized
- \* Simplifies hose routing
- \* Prevents damage from unrestrained hoses
- \* Easy to install

### Available Sizes

- \* 3/16"    \* 3/4" #
- \* 1/4" #    \* 1" #
- \* 3/8" #    \* 1 1/8" #
- \* 1/2"    \* 1 3/8" #
- \* 5/8"

# Available Stocked Sizes



Both manufacturer and distributor specifically, but not by way of limitation, disclaims any and all liability for the use or performance of the products in any application(s) other than those applications specified for such product(s) in this catalog and any such non-specified use voids any otherwise applicable warranty and is at the purchaser's sole risk and liability.

\*Not Suitable for use with any form of ethylene glycol type engine coolants.

\*\*Not Suitable for gasoline/oil mixed fuels, alcohol blended fuels, or bio-diesel fuel.

## \*\* *Black Standard Heater Hose*

A replacement for hose on most cars and light trucks. This standard grade hose is SAE20R3 Class D2 for normal duty service. Withstands the abuse of corrosive solutions and additives. Resists weathering to provide a long, trouble-free service life.

<b>Application</b>	Heater
<b>Style</b>	Black
<b>Grade</b>	Black Standard
<b>Specifications</b>	SAE20R3 Class D2
<b>Cover Color</b>	Black
<b>Construction</b>	
<b>Tube</b>	EPDM
<b>Reinforcement</b>	Two Spiral Polyester
<b>Cover</b>	EPDM
<b>Temperature Resistance</b>	-40 Degrees F to +212 Degrees F



Product Number	Inside Diameter (in.)	Length (ft.)	Description	Packaging
HHS-.625	5/8	700'	Standard Black Heater Hose	Spool
GR-HHS-D2-.750	3/4	500'	Standard Black Heater Hose	Spool

## \*\* *Nomex World Spec Heater Hose*

A replacement for OE hose on all FORD cars, as well as heavy and light trucks chassis. This high quality hose is made from flame retardant Nomex materials and meets or exceeds WSEM96D34-A4 for higher under hood temperatures. Withstands the abuse of corrosive solutions and additives. Resists weathering to provide a long, trouble-free service life.

<b>Application</b>	Heater
<b>Style</b>	Black
<b>Grade</b>	Black Standard
<b>Specifications</b>	WSEM96D34-A4
<b>Cover Color</b>	Black
<b>Construction</b>	
<b>Tube</b>	EPDM
<b>Reinforcement</b>	Two Spiral Polyester
<b>Cover</b>	Nomex
<b>Temperature Resistance</b>	-40 Degrees F to +212 Degrees F



Product Number	Inside Diameter (in.)	Length (ft.)	Description	Packaging
GR-HHFR-.625	5/8	700'	Nomex World Spec Heater Hose	Spool

# AUTOMOTIVE HOSE

## \* Gas Tank Fuel Fill Hose

Designed for connection between gas tank and filler neck on automotive vehicles. This special hose handles leaded, unleaded, alcohol-added, diesel and most modern fuels. Resists heat, weather, abrasion and ozone.

<b>Application</b>	Fuel Line
<b>Style</b>	Gas Tank Filler
<b>Grade</b>	N/A
<b>Specifications</b>	SAEJ1527 Type A2
<b>Cover Color</b>	Black with Red Stripe
<b>Construction</b>	
<b>Tube</b>	Nitrile
<b>Reinforcement</b>	Spiral Polyester Cord
<b>Cover</b>	Polychloropene
<b>Temperature Resistance</b>	257 Degrees F



Product Number	Inside Diameter (in.)	Length (ft.)	Description	Packaging
R-FFW-1.00	1	50	Gas Tank Fuel Fill Hose w/wire	Roll
R-FFW-1.250	1 1/4	50	Gas Tank Fuel Fill Hose w/wire	Roll
R-FFW-1.50	1 1/2	50	Gas Tank Fuel Fill Hose w/wire	Roll
R-FFW-1.750	1 3/4	50	Gas Tank Fuel Fill Hose w/wire	Roll
R-FFW-2	2	50	Gas Tank Fuel Fill Hose w/wire	Roll

## \* Soft Wall Fuel Fill Hose

This hose meets the same standards as our gas tank fill hose, but is not wire re-enforced. It is an excellent product when used in a "straight run" from the fuel tank to the filler neck. This provides a production friendly connection application.

<b>Application</b>	Fuel Line
<b>Style</b>	Gas Tank Filler
<b>Grade</b>	N/A
<b>Specifications</b>	SAEJ1527 Type A2
<b>Cover Color</b>	Black with Red Stripe
<b>Construction</b>	
<b>Tube</b>	Nitrile
<b>Reinforcement</b>	N/A
<b>Cover</b>	Polychloropene
<b>Temperature Resistance</b>	257 Degrees F



Product Number	Inside Diameter (in.)	Length (ft.)	Description	Packaging
R-SWFF-1.00	1	50	Gas Tank Fuel Fill Hose	Roll
R-SWFF-1.50	1 1/2	50	Gas Tank Fuel Fill Hose	Roll
R-SWFF-1.750	1 3/4	50	Gas Tank Fuel Fill Hose	Roll
R-SWFF-2	2	50	Gas Tank Fuel Fill Hose	Roll
R-SWFF-2.375	2 3/8	50	Gas Tank Fuel Fill Hose	Roll

# AUTOMOTIVE HOSE

## \* Low Perm Tier III CARB Hose

Our low permeable fuel line is a more cost efficient alternative for those companies wanting to meet the California Air Resources Board (CARB) requirements. While some applications are mandatory to meet the more stringent requirements of SAE30R9 CARB LEV II hose, this fuel line meets the CARB Tier III standards as required under Executive Orders G-05-018. CARB LEV II Low Perm Hose is a suitable low-permeation replacement for most standard SAE30R7 applications.

<b>Application</b>	Fuel Line
<b>Style</b>	700 Series CARB LEV II Low Perm Hose
<b>Grade</b>	N/A
<b>Specifications</b>	SAE30R7 CARB Tier III
<b>Cover Color</b>	Black
<b>Construction</b>	
<b>Tube</b>	Nitrile Rubber
<b>Reinforcement</b>	THV Barrier
<b>Cover</b>	CSM (Hypalon®)
<b>Temperature Resistance</b>	-40 Degrees F +257 Degrees F Continuous

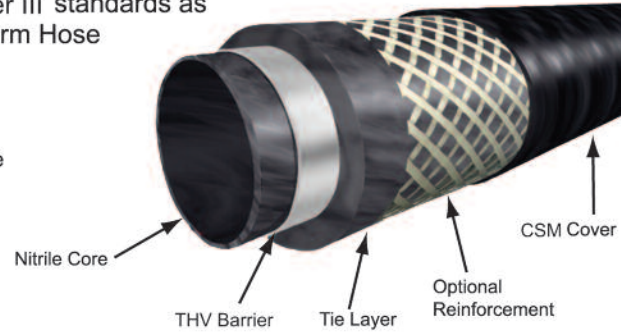

Product Number	Inside Diameter (in.)	Length (ft.)	Description	Packaging
A-LPFL-.250	1/4	400	Low Perm Premium Fuel Line	Spool
A-LPFL-.3125	5/16	360	Low Perm Premium Fuel Line	Spool
A-LPFL-.375	3/8	150	Low Perm Premium Fuel Line	Spool
A-LPFL-.500	1/2	250	Low Perm Premium Fuel Line	Spool

## \* SAE30R9 CARB LEV II Approved Hose

Our SAE30R9 Fuel Injection Hose has been approved by Executive Order C-U-05-002 for use under the CARB LEV II specifications. This hose is also designed for the extremely high temperatures generated by today's fuel injection engines. This hose handles leaded, unleaded, alcohol added, diesel, and extended gasolines, resisting sour fuel oxidation. This product is designed for use in the RV, Off Road, and Mass Transit (Bus) Industries.

<b>Application</b>	Fuel Line
<b>Style</b>	Fuel Injection (SAE30R9)
<b>Grade</b>	N/A
<b>Specifications</b>	SAE30R9/CARB LEV II
<b>Cover Color</b>	Black
<b>Construction</b>	
<b>Tube</b>	Fluroelastomer
<b>Reinforcement</b>	Two Spiral Aramid Fiber
<b>Cover</b>	CSM
<b>Temperature Resistance</b>	-29 Degrees F +275 Degrees F (+302 Degrees F Intermittent)



Product Number	Inside Diameter (in.)	Length (ft.)	Description	Packaging
DM-FIL-.250	1/4	250	SAE30R9 CARB LEV II	Spool
DM-FIL-.3125	5/16	250	SAE30R9 CARB LEV II	Spool
DM-FIL-.375	3/8	250	SAE30R9 CARB LEV II	Spool
DM-FIL-.500	1/2	200	SAE30R9 CARB LEV II	Spool

(These are our most commonly used sizes. Other sizes available upon request)

# AUTOMOTIVE HOSE

## *Standard Premium Fuel Line*

Designed for conveying most modern fuels in cars, trucks, buses, etc. Handles temperature ranges of -40 to +257 Degrees F. Withstands oil, grease, abrasion and ozone. Meets or exceeds the burst requirements of the SAE30R7 specification.

<b>Application</b>	Fuel Line
<b>Style</b>	SAE30R7
<b>Grade</b>	N/A
<b>Specifications</b>	SAE30R7
<b>Cover Color</b>	Black
<b>Construction</b>	
<b>Tube</b>	Nitrile
<b>Reinforcement</b>	Two Spiral Polyester
<b>Cover</b>	Nitrile/PVC
<b>Temperature Resistance</b>	-40 Degrees F +257 Degrees F (+302 Degrees F Intermittent)



Product Number	Inside Diameter (in.)	Length (ft.)	Description	Packaging
FL-.250	1/4	250	Standard Premium Fuel Line	Spool
FL-.3125	5/16	250	Standard Premium Fuel Line	Spool
FL-.375	3/8	250	Standard Premium Fuel Line	Spool
FL-.500	1/2	700	Standard Premium Fuel Line	Spool
FL-.59375	19/32	250	Standard Premium Fuel Line	Spool

## *Gas Tank Vent Hose*

A low pressure hose built to handle gasoline vapor, carbon monoxide exhaust fumes and engine heat. The cover resists oil, grease, abrasion and ozone, providing extended service life.

<b>Application</b>	Fuel Line
<b>Style</b>	Gas Tank Filler
<b>Grade</b>	N/A
<b>Specifications</b>	Similar to SAEJ30R7
<b>Cover Color</b>	Black
<b>Construction</b>	
<b>Tube</b>	Nitrile
<b>Reinforcement</b>	Two Spiral Polyester
<b>Cover</b>	CSM
<b>Temperature Resistance</b>	257 Degrees F



Product Number	Inside Diameter (in.)	Length (ft.)	Description	Packaging
FT-.625	5/8	250	Gas Tank Vent Hose	Spool
FTP-.750	3/4	700	Gas Tank Vent Hose	Spool

# AUTOMOTIVE HOSE

## Air Conditioning Hose

### GoodYear Galaxy Air Conditioning Hose 4826

- \*Two Polyester Spiral Barrier Hose
- \*J51 All Outside Diameters
- \*Temperature Range -40 to +257 Degees F
- \*Compatible with:
  - \*R-12/R134A Refrigerants
  - \*Mineral Oil, PAG's
- \*Meets J2064 "TYPE C Class II" Hose Performance
- \*Low Volumetric Expansion
- \*Dimensionally Stable
- \*Flexible - Easy to Route



Product Number	Size (in.)	Inside Diameter (in.)	Outside Diameter (in.)	Packaging	Length
ACBH06-.3125	5/16	.307	.719	Reel	500'
ACBH08-.40625	13/32	.401	.875	Reel	500'
ACBH10-.500	1/2	.490	.969	Reel	500'
ACBH12-.625	5/8	.615	1.094	Reel	500'

## Molded Hoses

Our molded hoses come in a wide range of shapes and size requirements. These hoses can be made for use in fuel systems, meeting the various SAE30R7, SAE J1527, and the CARB LEV II fuel ratings required. Many of the more traditional SAE20R3 D2 and the SAE20R1 Class B engine coolant molded hoses are also in stock.

Please contact your customer service representative for more details and availability.



# AUTOMOTIVE HOSE

## Heavy Duty Air Hose

A multi-purpose hose designed for tough general service air and water applications. It features an EPDM tube and cover with a four spiral polyester reinforcement that keeps the hose kink resistant and flexible in extreme temperatures. The cover is resistant to abrasion, weathering and ozone. Rated at 200 to 300 PSI working pressure.

<b>Application</b>	Air
<b>Style</b>	Heavy Duty Bulk Air
<b>Grade</b>	N/A
<b>Specifications</b>	N/A
<b>Cover Color</b>	Red
<b>Construction</b>	
<b>Tube</b>	EPDM
<b>Reinforcement</b>	Four Spiral Polyester
<b>Cover</b>	EPDM
<b>Temperature Resistance</b>	-40 Degrees F to +212 Degrees F (not for steam use)



Product Number	Inside Diameter (in.)	Length (ft.)	Description	Packaging
AH-.500	1/2	700'	Heavy Duty Air Hose 7/8" OD, 300PSI W.P.	Reel
AH-.750	3/4	700'	Heavy Duty Air Hose 1 3/16" OD, 300PSI W.P.	Reel
AH-1.000	1	700'	Heavy Duty Air Hose 1 7/16" OD, 200PSI W.P.	Reel

## Push-On Air Hose

This high quality hose can be used by all industries. It has a Class A high oil resistant tube and cover that offers excellent resistance to oil and petroleum based products. It has excellent coupling retention. It holds the special fitting tightly and safely. With an easy push, the spiral hose design grips the fitting securely and maintains a constant internal holding action. The fitting will not give, even under full working pressure.

Not recommended for unleaded gasoline.

<b>Application</b>	Air
<b>Style</b>	Push-On Hose
<b>Grade</b>	N/A
<b>Specifications</b>	N/A
<b>Cover Color</b>	Black, Blue, Gray, Red or Yellow
<b>Construction</b>	
<b>Tube</b>	Nitrile
<b>Reinforcement</b>	Two Spiral Aramid Fiber
<b>Cover</b>	Nitrile/PVC Blend
<b>Temperature Resistance</b>	-30 Degrees F to +160 Degrees F (180 Degrees F Intermittent)



Product Number	Inside Diameter (in.)	Length (ft.)	Description	Packaging
PAH-.250	1/4	250'	Push-On Hose, Uncoupled	Reel
PAH-.375	3/8	250'	Push-On Hose, Uncoupled	Reel
PAH-.500	1/2	250'	Push-On Hose, Uncoupled	Reel
PAH-.625	5/8	250'	Push-On Hose, Uncoupled	Reel
PAH-.750	3/4	250'	Push-On Hose, Uncoupled	Reel

# AUTOMOTIVE HOSE

## Windshield Wiper/Vacuum Tubing

Low pressure EPDM tubing for windshield washers, vacuum and emissions systems for power accessories. Meets SAE J1037 specifications. Will not deteriorate from heat, weathering or ozone. Maintains its flexibility even at low temperatures.

<b>Application</b>	Windshield Wiper/Vacuum
<b>Style</b>	N/A
<b>Grade</b>	N/A
<b>Specifications</b>	SAE J1037
<b>Cover Color</b>	Black
<b>Construction</b>	
<b>Tube</b>	EPDM
<b>Reinforcement</b>	None
<b>Cover</b>	N/A
<b>Temperature Resistance</b>	-40 Degrees F to +257 Degrees F (Not for Steam Use)



Product Number	Inside Diameter (in.)	Length (ft.)	Description	Packaging
VT-1094	7/64	500	Windshield Wiper/Vacuum Tubing	Reel
VT-1563HW	5/32	500	Windshield Wiper/Vacuum Tubing	Reel
VT-2188	7/32	400	Windshield Wiper/Vacuum Tubing	Reel

## Engine Coolant Hose

A general purpose, low pressure coolant and heater connector built for long lasting performance at temperature ranges of 0 to +212 Degrees F. Resists aging, ozone, chemicals and lubricants.

<b>Application</b>	Engine Coolant
<b>Style</b>	Black
<b>Grade</b>	General Purpose Coolant
<b>Specifications</b>	SAEJ2006
<b>Cover Color</b>	Black
<b>Construction</b>	
<b>Tube</b>	Nitrile/SBR Blend
<b>Reinforcement</b>	3 Ply Nylon Screen
<b>Cover</b>	Nitrile/SBR Blend
<b>Temperature Resistance</b>	0 Degrees F to +212 Degrees F



Product Number	Inside Diameter (in.)	Length (ft.)	Description	Packaging
R-HWWH-1.25	1 1/4	50	Engine Coolant Hose with wire	Roll
R-HWWH-1.50	1 1/2	50	Engine Coolant Hose with wire	Roll
R-HWWH-2	2	50	Engine Coolant Hose with wire	Roll
R-SWWH-1.00	1	50	Engine Coolant Hose without wire	Roll
R-SWWH-1.25	1 1/4	50	Engine Coolant Hose without wire	Roll
R-SWWH-2	2	50	Engine Coolant Hose without wire	Roll
R-SWWH-2.25	2 1/4	50	Engine Coolant Hose without wire	Roll
R-SWWH-2.50	2 1/2	50	Engine Coolant Hose without wire	Roll