



## **OWNER'S MANUAL**

### **FREEDOM AWNINGS**

#### **PATIO, WINDOW AND OTD AWNINGS**



***Freedom Patio Awning***

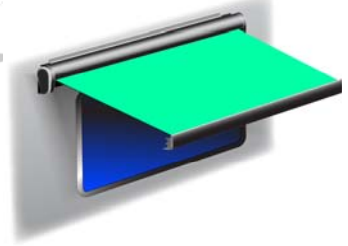

***Freedom Window and OtD Awnings***

**Special Note:** This manual provides a basic description of the product and the standard operating controls provided by Carefree of Colorado. Some Original Equipment Manufacturers (OEM's) may alter or change the placement, style and/or functional configuration of the switches. If your controls do not match the style or description included, contact the coach manufacturer for an accurate description. OEM furnished components are not covered by the Carefree warranty.

## About Carefree

From its beginning in the early 70's, Carefree of Colorado has emerged as the premier manufacturer of quality awnings and accessories for Recreational Vehicles (RVs). Our full line of products can provide the accessories that match your life style; no matter what type of RV you own. Check with your dealer to discover the products that can make your life more Carefree.

---

The Carefree Freedom series of awnings are state of the art with lateral support arms that provides strength and functionality without interfering with coach sidewalls, custom graphics or equipment that may be mounted on the sidewalls.

- *When retracted, the housing provides protection against the elements while the streamlined styling blends in with the RV sidewall and is a perfect complement to other Carefree products.*
  - *The awnings are made with heavy duty construction including an all metal chassis.*
  - *The patio, window and OtD (Over the Door) models are all available as manually operated or motorized awnings.*
- 

<b>Operation .....</b>	<b>3</b>
Motorized Awnings: .....	3
Manually Operated Awnings:.....	3
Using the Vertical Support Legs .....	4
<b>Awning Care .....</b>	<b>5</b>
Fabric Care.....	5
Mildew .....	5
Pooling .....	5
Arm Care.....	5

## **OPERATION**

### **⚠WARNING**

KEEP ALL SOURCES OF HEAT AND FLAME AWAY FROM THE AWNING CANOPY. FABRIC IS NOT FIRE-PROOF AND CAN BURN IF LEFT IN CONTACT WITH ANY FLAME OR HEAT SOURCE.

### **⚠CAUTION**

The effects of wind and rain on an awning are unpredictable. Severe damage to the awning and the vehicle may result. IF WIND OR EXTENDED PERIODS OF RAIN ARE EXPECTED, RETRACT THE AWNING.

It is recommended that if leaving the RV unattended for a length of time, retract the awning to avoid unexpected climate conditions.

### **MOTORIZED AWNINGS:**

*To Operate the Awning:* Press and hold the switch until the awning is in the desired position then release the switch.

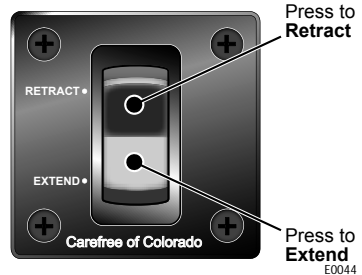

### **MANUALLY OPERATED AWNINGS:**

- Insert the hook of the manual crank into the gear loop located on the left side of the awning.
- Turn the handle counterclockwise to extend the awning.
- Turn the handle clockwise to retract the awning.

The crank handle may be extended or shortened by pressing the spring lock button in or out to the next button hole.

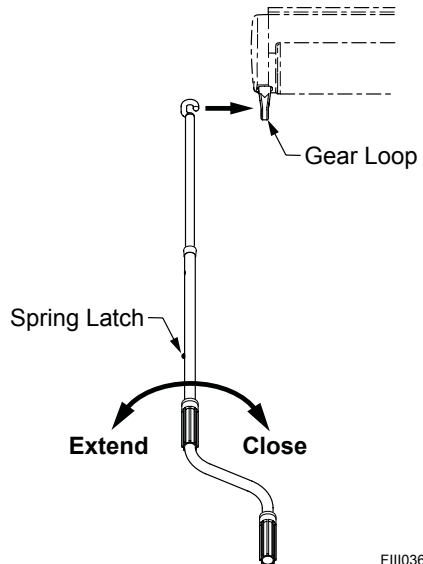

F111036

## USING THE VERTICAL SUPPORT LEGS

(Available For Patio Awnings Only)

Two telescoping vertical support legs are stowed in the lead rail of the awning. These can be used to provide increased stability and to adjust the height of the front edge (lead rail) of the awning.

### ⚠ CAUTION

THE GROUND SUPPORT LEGS DO OFFER INCREASED STABILITY BUT DO NOT COMPENSATE FOR HARSH WEATHER CONDITIONS SUCH AS WIND AND/OR HEAVY RAIN. DURING INCLEMENT WEATHER, RETRACT AND SECURE THE AWNING IN THE TRAVEL POSITION.

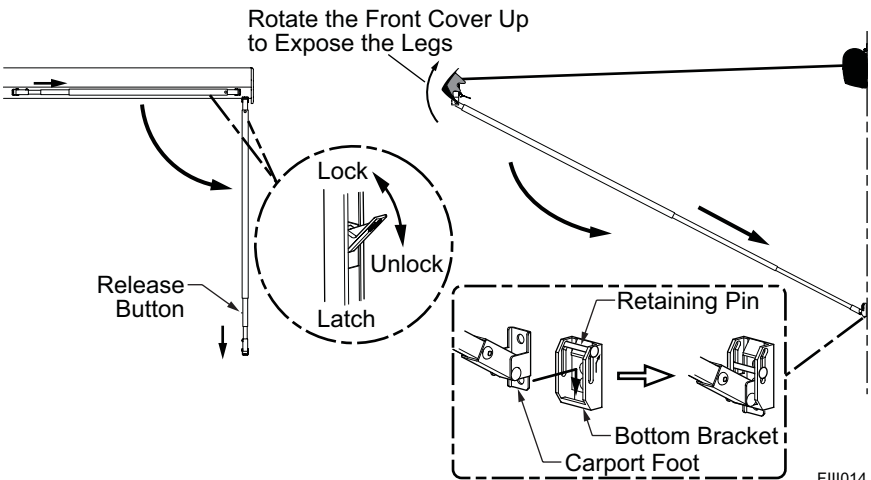

1. Extend the awning.
  2. Rotate the front cover of the leading edge up to expose the legs.
  3. Unsnap the leg from the storage position. To do so, open the latch and slide the foot out from the retaining clip.
  4. Swivel the leg down.
  5. Press the release catch and extend the first section of the leg until it locks in place with the ball lock.
  6. *For Carport Position:*
    - Extend the second section of the support down to ground.
    - Hold the carport foot on the ground and lift the top section of the support until the awning is at the desired height. Close the latch.
    - Stake the carport foot to the ground. (Stakes are not included)
  7. *For Wall Support:*
    - Rotate and extend the leg to the bottom bracket.
    - Lift the retaining pin and insert the foot into the bracket. Allow the retaining pin to drop down over the foot.
    - Lift the top section of the support until the awning is at the desired height. Close the latch.
  8. Repeat for other side.
- To stow the leg, reverse the above steps.

---

## **AWNING CARE**

Maintaining a Carefree Awning is easy. Just follow these basic steps:

- Always operate the awning according to the instructions.
- Periodically check that the fasteners are tight. Tighten if necessary.
- Keep the awning fabric and arms clean.

### **FABRIC CARE**

#### **CAUTION**

**DO NOT USE OIL BASED CLEANERS OR ANY CAUSTIC, GRANULATED, OR ABRASIVE TYPE CLEANERS ON YOUR CAREFREE PRODUCT.**

1. One of the best ways to keep the fabric looking good and to delay the need for deep or vigorous cleanings is to hose fabrics off on a monthly basis with clear water. This practice will help prevent dirt from becoming deeply imbedded in the fabric. In most environments, a thorough cleaning will be needed every two to three years.
2. When it's time for a thorough cleaning, the fabric can be cleaned while still on the awning frame.
  - For Vinyl Fabric – Use a soft brush and warm water with soap.
  - For Acrylic Fabric – Use a stiff brush and warm water with soap.
3. When cleaning the fabric, it is important to observe the following:
  - Always use a natural soap, never detergent.
  - Water should be cold to lukewarm, never more than 100°F.
  - Air-dry only. Never apply heat to the fabric.
  - Always allow the fabric to dry thoroughly before rolling up the awning.

### **MILDEW**

Mildew is a fungus growth that looks like dirt. Vinyl coated polyester fabrics are mildew resistant because of a chemical biocide in the vinyl coating. Under ordinary conditions, mildew will not appear. However, in areas where high temperature and humidity are common, mildew can be a problem and required the material to be washed more frequently. Thoroughly rinse the fabric and allow to air dry completely before retracting the awning.

### **POOLING**

When water collects on the top of the fabric, this is known as "pooling". This can occur during inclement weather or if a running air conditioner discharges over the awning. The water is dumped when the awning is retracted. It is recommended that if water accumulates; retract the awning in steps (8"-12") to dump the water. This will help prevent the fabric from stretching or distorting.

### **ARM CARE**

The best method of keeping the arms and braces operating smoothly is to clean them. Dirt and debris can cause the channels not to slide easily.

Periodically wash out the channels with running water (i.e. a hose) to keep them clean. If the channels still do not slide easily, lightly spray the joints and/or inside of the channels with a dry silicone lubricant after the arms have been cleaned and dried thoroughly.



**OWNER'S MANUAL**  
**FREEDOM AWNINGS**

---

**OTD (OVER THE DOOR) SLIDER AWNING**

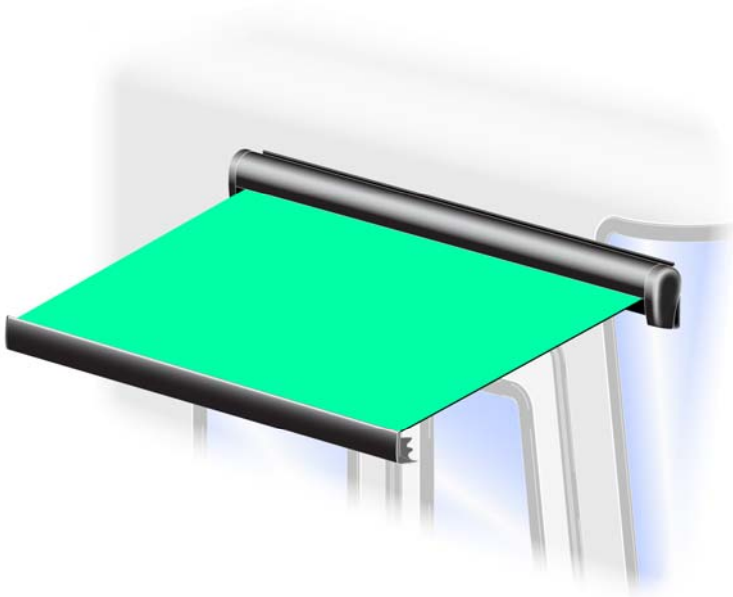

*Awning shown in the camping position*

## **OPERATION**

### **⚠WARNING**

KEEP ALL SOURCES OF HEAT AND FLAME AWAY FROM THE AWNING CANOPY. FABRIC IS NOT FIRE-PROOF AND CAN BURN IF LEFT IN CONTACT WITH ANY FLAME OR HEAT SOURCE.

### **⚠CAUTION**

AWNINGS ARE DESIGNED TO PROVIDE SHADE AND PROTECTION FROM THE SUN. THE EFFECTS OF WIND AND RAIN ON AN AWNING ARE UNPREDICTABLE AND CAN CAUSE SEVERE DAMAGE TO THE AWNING AND/OR THE VEHICLE. IF WIND OR EXTENDED PERIODS OF RAIN ARE EXPECTED, ROLL UP THE AWNING AND SECURE.

## **POSITIONING THE AWNING**

Use the hook of the manual crank handle to hook over the notches in the catches.

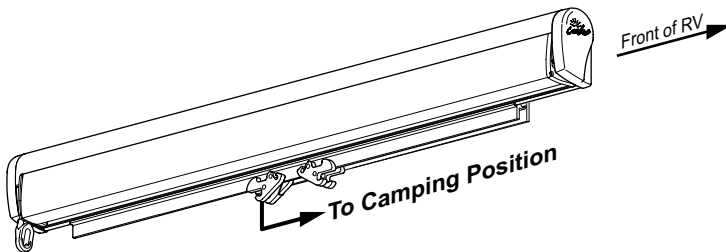

F111009a

### To position the awning in the camping position:

Grab the rear catch with the crank handle and pull down to unlock and pull forward until the front latch catches.

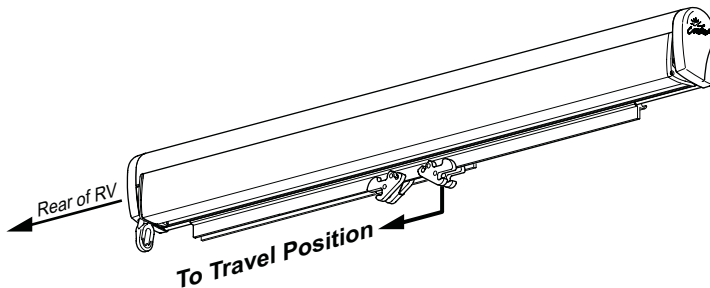

F111009b

### To position the awning in the travel position:

Grab the front catch with the crank handle and pull down to unlock and pull to the rear until the rear latch catches.

## ***To OPERATE THE AWNING***

- Insert the hook of the manual crank into the gear loop located on the left side of the awning.
- Turn the handle counterclockwise to extend the awning.
- Turn the handle clockwise to retract the awning.

The crank handle may be extended or shortened by pressing the spring lock button then sliding the handle in or out to the next button hole.

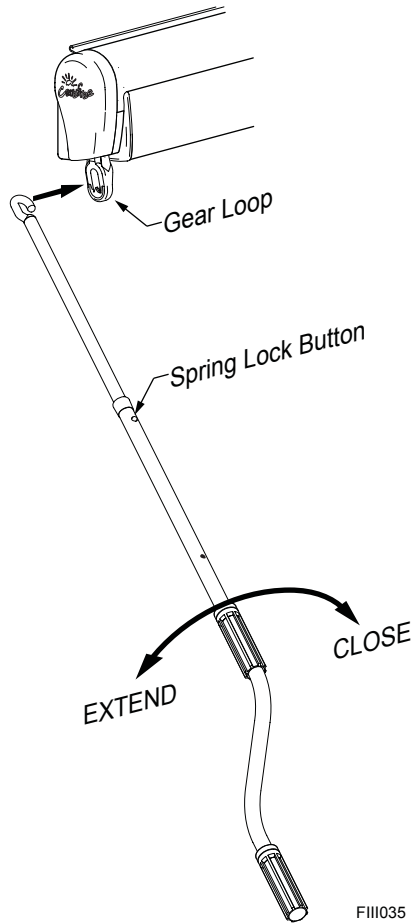



## **AWNING CARE**

Maintaining a Carefree Awning is easy. Just follow these basic steps:

- Always operate the awning according to the instructions.
- Periodically check that the fasteners are tight. Tighten if necessary.
- Keep the awning fabric and arms clean.

### **FABRIC CARE**

#### **CAUTION**

**DO NOT USE OIL BASED CLEANERS OR ANY CAUSTIC, GRANULATED, OR ABRASIVE TYPE CLEANERS ON YOUR CAREFREE PRODUCT.**

1. One of the best ways to keep the fabric looking good and to delay the need for deep or vigorous cleanings is to hose fabrics off on a monthly basis with clear water. This practice will help prevent dirt from becoming deeply imbedded in the fabric. In most environments, a thorough cleaning will be needed every two to three years.
2. When it's time for a thorough cleaning, the fabric can be cleaned while still on the awning frame.
  - For Vinyl Fabric – Use a soft brush and warm water with soap.
  - For Acrylic Fabric – Use a stiff brush and warm water with soap.
3. When cleaning the fabric, it is important to observe the following:
  - Always use a natural soap, never detergent.
  - Water should be cold to lukewarm, never more than 100°F.
  - Air-dry only. Never apply heat to the fabric.
  - Always allow the fabric to dry thoroughly before rolling up the awning.

### **MILDEW**

Mildew is a fungus growth that looks like dirt. Vinyl coated polyester fabrics are mildew resistant because of a chemical biocide in the vinyl coating. Under ordinary conditions, mildew will not appear. However, in areas where high temperature and humidity are common, mildew can be a problem and required the material to be washed more frequently. Thoroughly rinse the fabric and allow to air dry completely before retracting the awning.

### **POOLING**

When water collects on the top of the fabric, this is known as "pooling". This can occur during inclement weather or if a running air conditioner discharges over the awning. The water is dumped when the awning is retracted. It is recommended that if water accumulates; retract the awning in steps (8"-12") to dump the water. This will help prevent the fabric from stretching or distorting.

### **ARM CARE**

The best method of keeping the arms and channels operating smoothly is to clean them. Dirt and debris can cause the channels not to slide easily.

Periodically wash out the channels with running water (i.e. a hose) to keep them clean. If the channels still do not slide easily, lightly spray the joints and/or inside of the channels with a dry silicone lubricant after the arms have been cleaned and dried thoroughly.