



RV



Before operating the awning, carefully review the Owner's Manual. The manual contains important safety information, detailed operating instructions, common maintenance procedures and other useful information.



TABLE OF CONTENTS

Introduction	2
First Time Installation	3
Installing the Wall Brackets	3
<u>Setting Up the Campout Awning</u>	4
Center Rafter	5
Carport Position	5
Pitch Adjustment	5
Rain Release Setting	5
Storage	6
Awning Care	7
Fabric Care	7
Mildew	7
Pooling	7
Leaking	7
Rafter and Vertical Support Arm Care	8
Hardware Maintenance	8

INTRODUCTION

From its beginning in the early 70's, Carefree of Colorado has emerged as the premier manufacturer of quality awnings and accessories for Recreational Vehicles (RVs). Our full line of products can provide the accessories that match your life style; no matter what type of RV you own.

Check with your dealer to discover the products that can make your life more Carefree.

Product Description

- Simple Installation.
 - Easy setup.
 - The rolled up awning stores in a heavy duty zippered vinyl bag attached to the RV.
 - Self-storing arms and braces simply fold up into the lead bar.
 - The pitch can be set to optimize shade and rain run-off.
 - The vertical support arms can be attached to the RV or set in the carport position to provide an open walkway from the side of the awning.
-

 WARNING Awnings are designed to provide shade and protection from the sun. The effects of wind and rain on an awning are unpredictable and can cause severe damage to the awning and/or the vehicle. If wind or extended periods of rain are expected, roll up the awning.

NOTICE It is recommended that if leaving the RV unattended for a length of time, retract the awning to avoid unexpected climate conditions.

 WARNING Keep all sources of heat and flame away from the awning canopy. Fabric is not fire-proof and can burn if left in contact with any flame or heat source.

CALIFORNIA PROPOSITION 65

 WARNING This product contains chemicals known to the state of California to cause cancer or birth defects or other reproductive harm. California's Proposition 65 requires this warning to be given to customers in the state of California.

FIRST TIME INSTALLATION

The Campout awning mounts in a standard awning rail. The mounting surface must be relatively flat and measure a minimum of 3" longer than the awning bag with 6 1/2" of space below the awning rail.

1. Slightly spread open one end of the awning rail. Clean and deburr any sharp edges.

Tip: Lightly spray the inside of the awning rail with a dry silicone lubricant to aid in sliding the awning into the awning rail.

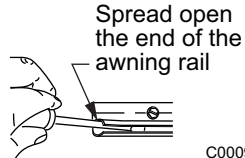

2. Slide the awning into the awning rail and position as desired. Ensure that the bag does not extend past the ends of the awning rail.

3. Secure the awning using one #6 x 3/8" hex head screw at both sides of the awning bag. Place the screw through the awning rail, polyrod and bag fabric approximately 1" in from the end of the bag.

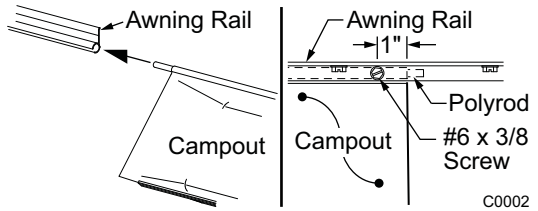

INSTALLING THE WALL BRACKETS

The awning uses vertical supports. These supports extend from the leading edge of the awning to a bracket mounted on the wall or can be used in the carport (vertical) position.

1. Determine the location of the brackets:
 - Locate the support loop on the rear of the awning bag.
 - In line with the loop, measure down vertically 142-152cm [56"-60"] from the awning rail and mark the bracket locations.

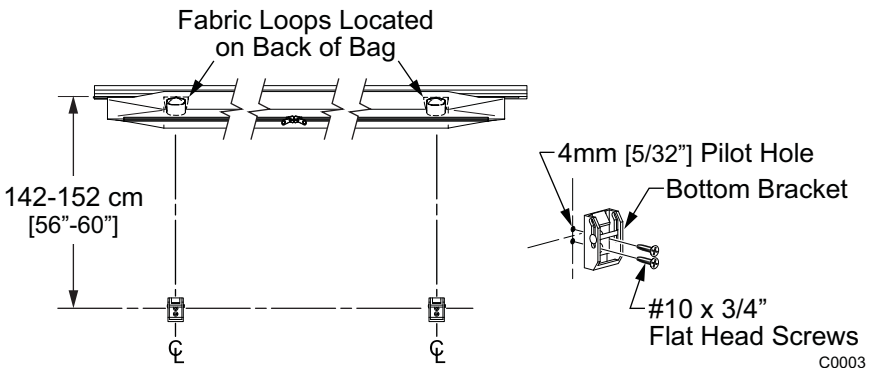

2. Center the brackets at the location marks and using the bracket as a template, drill two (2) 4mm [5/32"] pilot holes.
3. Attach each bracket with two (2) #10 x 3/4" flat head screws.

This completes the installation of the Campout Awning.

SETTING UP THE CAMPOUT AWNING

CAUTION Hold onto the lead rail when the bag is open and when the retaining strap is released to prevent awning from unrolling and dropping unexpectedly.

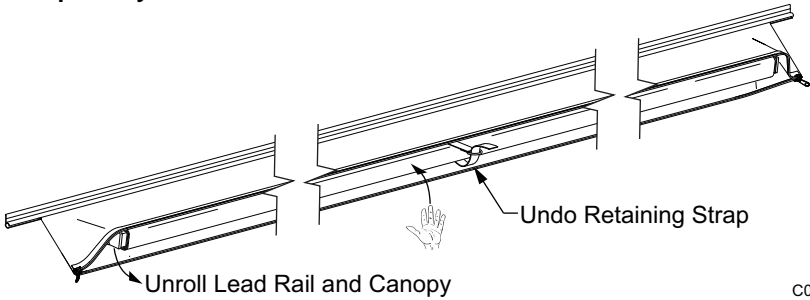

1. Unzip the bag.
2. While holding the lead rail, move to the center and undo the retaining strap.
3. Unroll the lead rail and canopy.
4. Rotate the vertical support leg down from the bottom of the lead rail.
5. Open the latch and extend the lower leg out. Close the latch.
6. Swing the support toward the wall bracket and attach the carport foot into the wall bracket.

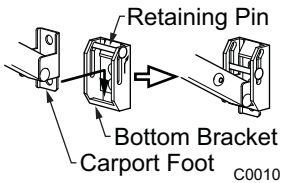

- Lift the retaining pin and insert the foot into the bracket. Allow the retaining pin to drop down over the foot.

7. Repeat for other side.
8. Rotate the rafter out from the back of the lead rail.
9. Open the latch and extend the channel back toward the RV.
10. Place the end of the rafter into the support loop located inside the bag below the awning rail.
11. Extend the rafter to tension the canopy then close the latch.
12. Repeat for other side.

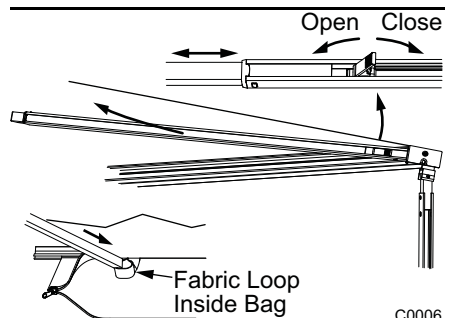
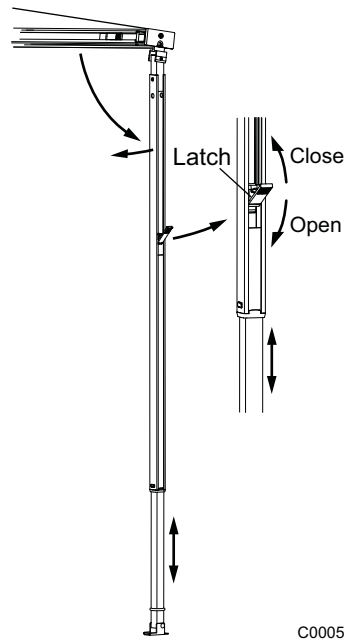

CENTER RAFTER

For 3.5 meter and larger Campouts, a center rafter is provided to add tension to the canopy. To use:

1. Insert the larger end into the middle of the lead rail.
2. Open the latch and extend the channel back toward the RV.
3. Place the end of the rafter into the support loop located inside the bag below the awning rail.
4. Extend the rafter to tension the canopy then close the latch.

CARPORT POSITION

The vertical supports can be placed in the carport (vertical) position to provide an open walkway from the sides of the awning.

NOTE: It may be necessary to use the carport position for head and door clearance for low mounted awnings.

1. Remove the carport foot from the wall bracket.
 - Lift the retaining pin and pull the foot out of the bracket.
2. Rotate the leg to the vertical position.
3. For improved support, use stakes through the carport foot.

NOTE: Stakes are not included with awning.

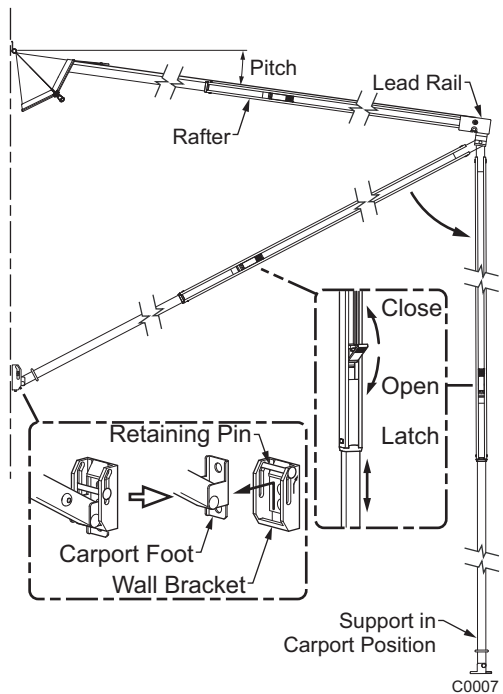

C0007

PITCH ADJUSTMENT

The awning pitch can easily be adjusted to raise or lower the lead rail for clearance and to provide the best shade.

To change the pitch:

1. Open the vertical support latch
2. Extend or retract the lower channel as desired.
3. Close the latch.

RAIN RELEASE SETTING

The effects of wind and rain on an awning are unpredictable and can cause severe damage to the awning and/or the vehicle. IF WIND OR EXTENDED PERIODS OF RAIN ARE EXPECTED, ROLL UP THE AWNING AND SECURE.

If the awning is extended during rain, shorten one support to create a steeper pitch on one side. This will provide a slope to allow the water to run off to the lower side of the awning.

STORAGE

The Campout is easy to take down and store.

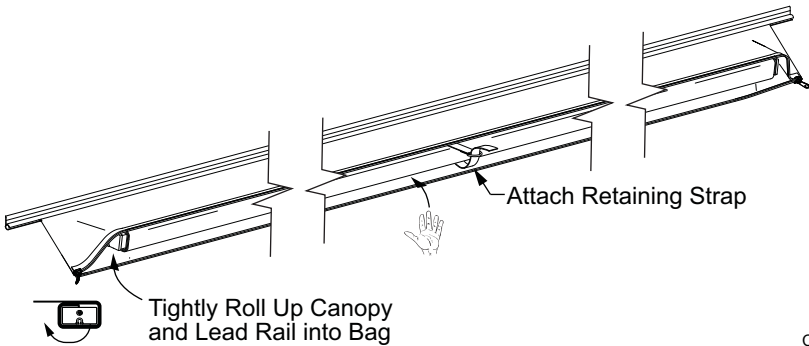

1. Allow the canopy to dry.

NOTE: If the awning must be stored when wet, be sure to unroll the awning at the earliest opportunity and allow to dry.

2. Collapse the rafters then rotate and store in the lead rail.

NOTE: For awnings with a center rafter: the center rafter is collapsed and stored separately. It does not store in the lead rail or fit in the bag.

3. Remove the vertical supports from the wall brackets or remove any stakes used in the carport position.
4. Collapse the vertical supports then rotate and store in the lead rail.
5. Tightly roll up the canopy around the lead rail. The canopy must be wound over the top of the lead rail.
6. Hold on to the lead rail and fasten the center retaining strap.
7. Zip the bag closed.

AWNING CARE

Maintaining a Carefree Awning is easy. Just follow these basic steps:

- Always operate the awning according to the instructions.
- Periodically check that the fasteners are tight. Tighten if necessary.
- Keep the awning fabric and arms clean.

FABRIC CARE

NOTICE Do not use oil based cleaners or any caustic, granulated or abrasive type cleaners on your Carefree product.

1. One of the best ways to keep the fabric looking good and to delay the need for deep or vigorous cleanings is to hose fabrics off on a monthly basis with clear water. This practice will help prevent dirt from becoming deeply imbedded in the fabric. In most environments, a thorough cleaning will be needed every two to three years.
2. When it's time for a thorough cleaning, the fabric can be cleaned while still on the awning frame.
3. When cleaning the fabric, it is important to observe the following:
 - Use a soft brush and warm water with soap.
 - Always use a natural soap, never detergent.
 - Water should be cold to lukewarm, never more than 100°F.
 - Air-dry only. Never apply heat to the fabric.
 - Always allow the fabric to dry thoroughly before rolling up the awning.

MILDEW

Mildew is a fungus growth that looks like dirt. Vinyl coated polyester fabrics are mildew resistant because of a chemical biocide in the vinyl coating. Under ordinary conditions, mildew will not appear. However, in areas where high temperature and humidity are common, mildew can be a problem and require the material to be washed more frequently. Thoroughly rinse the fabric with clean water and allow to air dry completely before rolling up the awning.

POOLING

When water collects on the top of the fabric, this is known as "pooling". This can occur during inclement weather or if a running air conditioner discharges over the awning. The water is dumped when the awning is retracted. It is recommended that if water accumulates on the top; set the awning in the rain dump position (page 5) to dump the water. This will help prevent the fabric from stretching or distorting.

The effects of wind and rain on an awning are unpredictable. Severe damage to the awning and the vehicle may result. IF WIND OR EXTENDED PERIODS OF RAIN ARE EXPECTED, ROLL UP THE AWNING AND SECURE FOR TRAVEL.

LEAKING

On vinyl canopies, side hems and poly cords are stitched in with a sewing machine. On occasion, this stitching may allow water to seep or leak through the stitches. This is normal and not a defect covered by warranty. Treat the seams with a quality seam sealer.

RAFTER AND VERTICAL SUPPORT ARM CARE

The best method of keeping the arms and braces operating smoothly is to clean them. Dirt and debris can cause the channels not to slide easily.

Periodically wash out the channels with running water (i.e. a hose) to keep them clean. If the channels still do not slide easily, lightly spray the joints and inside the channels with a dry silicone lubricant after the arms have been cleaned and dried thoroughly.

HARDWARE MAINTENANCE

- Replace any parts that become damaged.
- Periodically check all mounting hardware, screws, lags, etc., and re-tighten when necessary.
- Locking knobs should be periodically loosened and removed then sprayed with a dry lubricant to prevent binding and locking.

SCREEN ROOM
OWNER'S MANUAL

INSTALLATION INSTRUCTIONS

READ THE ENTIRE CONTENTS OF THIS MANUAL PRIOR TO PERFORMING ANY PORTION OF THE INSTALLATION.

Step One: Inspect Breezeway Kit Contents

Closely inspect each component found in the kit. The Campout Breezeway Screen Room kit contains:

- | | |
|------------------------------|------------------------------|
| 1-Owner's Manual | 1-Wheel Filler Panel |
| 1-Storage Bag | 1-Bag of Plastic Spikes |
| 2-Horizontal Support Rafters | 1-Hardware bag |
| 1-Side Panel (Left) | consisting of: |
| 1-Side Panel (Right) | * 2-rafter brackets w/screws |
| 1-Skirting Panel | * button snap fasteners |
| | 2-Velcro Patches |

Step Two: Gather Tools and Supplies

TOOLS REQUIRED

- | | |
|-------------------|------------------------|
| * Tape Measure | * Drill Motor |
| * Step Ladder | * 7/64" Drill Bit |
| * 1/4" Nut Driver | * 5/16" Drill Bit |
| * Scissors | * Phillips Screwdriver |
| * Hammer | * Caulking Gun |
| * Flat File | * Round File |
| * Straight Edge | * Marking Pen |

SUPPLIES REQUIRED

- * Silicone Sealant (or equivalent)

Step Three: Fully Extend the Awning

A. Extend the Campout awning to its full open position. The lead bar of the awning can be left at a comfortable height during this portion of the installation.

B. Look closely at the end cap and slot on the lead bar positioned on the forward end of the awning. The two sections of the Breezeway Screen Room must slide into the slot on the lead bar.

Step Four: De-burr the Lead Bar Slot

A. Using a flat file or a round file, remove any sharp or jagged edges on the end cap and lead bar slot. Rough edges on the slot or cap can damage the panel.¹

Step Five: Drill Rafter Mounting Hole

A. At each end of the lead bar, measure over 5" from the edge of the canopy to a point centered in the channel of the lead bar and mark the location.

B. Carefully drill a 7/64" pilot hole in the lead bar channel.

C. Enlarge the hole to 5/16" to accept the straight pin on the Horizontal Rafter Support.

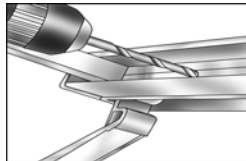

Tip: Position the awning at a comfortable height to eliminate the possibility of accidentally puncturing the awning canopy while using the drill motor.

D. Repeat this step at the opposite end of the lead bar assembly

Note: After drilling and enlarging these holes, be sure to raise the awning to its normal height.

Step Six: Install Horizontal Rafter Brackets

A. Position the Horizontal Rafter Support Bracket against the side of the RV at a point 5" in from the leading edge of the awning canopy.²

B. Align the top of the bracket to a position ^obelow the slot in the awning rail. (See illustration) Mark the mounting screw locations.

Warning: Do not install rafter brackets directly above or in line with intake or exhaust vents for any LP burning appliance.

Tip: For best results, mount the bracket to a surface that is as flat as possible.

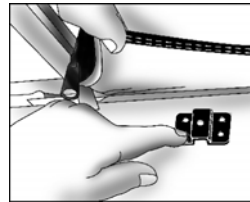

C. Pre-drill the mounting holes using a 7/64" drill bit.

D. Apply a liberal amount of silicone sealant or equivalent to the back of the bracket.

E. Secure the bracket using the supplied hex head mounting screws. Remove any excess sealant that may have squeezed out from behind the bracket.

F. Repeat this step for the other Horizontal Rafter Bracket.

Step Seven: Install Velcro Patches

Note: Self-adhesive Velcro patches are provided to prevent the campout awning storage bag from rubbing against the Horizontal Rafter Brackets while traveling.

A. Peel the protective paper from the reverse side of the Velcro patch.

B. Position the patch, Velcro side against the rafter bracket as illustrated.

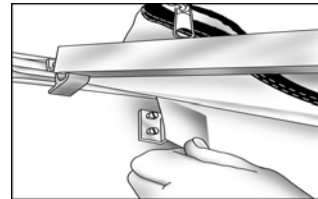

C. Press the Campout storage bag against the sticky surface of the Velcro patch as it is being held against the bracket.

D. Firmly smooth the patch onto the storage bag.

E. Repeat this step at the opposite end of the bag.

Note: The patches should remain on the bottom side of the storage bag as illustrated.

Tip: Be sure the area of the storage bag where the patch will be installed is clean and dry.

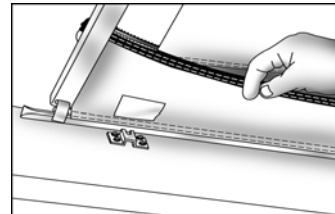

¹Damage to the screen room caused by non-compliance with Step Four is not warrantable.

²If the screen panel interferes with other brackets or components on the side of the camper, the rafter bracket can be mounted to within 1" from the edge of the canopy

Section One

Step Eight: Insert the Left Panel

A. Carefully slide the left panel into the lead bar until the notched upper corner of the room reaches the 5/16" hole in the lead bar.

Note: The left panel, when completely installed, forms the left side of the enclosure as well as the rear-most section of the front panel.

Caution: Extreme care must be taken not to puncture the front panel during this step!

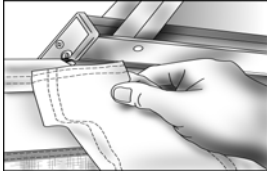

Tip: Silicone spray lubricant makes this task easier.

Step Nine: Install Right Panel

A. Carefully slide the right panel into the lead bar until it reaches the previously installed left section.

Note: The right panel, when completely installed, forms the right side of the enclosure as well as the forward-most section of the front panel.

Caution: Extreme care must be taken not to puncture the front panel during this step!

Tip: Silicone spray lubricant makes this task easier.

B. At the center of the awning, zip the two panels together and center the connected sections in the lead bar between the two previously drilled 5/16" holes.

Step Ten: Install Horizontal Rafters

A. Assemble the rafters by inserting the poles with the spring loaded buttons into the larger diameter poles with a hole in one end so that they line up. The remaining pole goes into the other end of the larger diameter pole. On some 7 models there will only be a 2 piece pole with no spring loaded buttons.

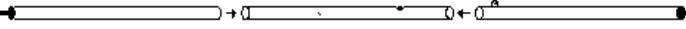

B. Carefully insert each rafter into the pocket on the top of the side panels, with the longest pin going toward the awning lead bar. (See illustration).

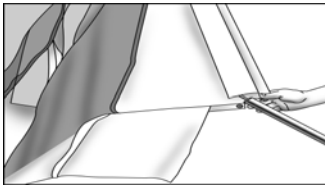

Caution: Extreme care must be taken not to puncture the side panels during this step!

C. Carefully maneuver the rafter into the channel section of the lead bar and push each Horizontal Rafter into the mounting bracket against the side of the RV.

Tip: This is easier if the awning support arm is temporarily removed from the bottom bracket and positioned vertically below the lead bar during this step.

D. Then fully insert the straight pin on the Horizontal Rafter into the hole located in the lead bar. (See illustration)

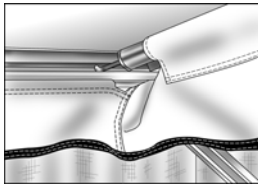

Tip: Be sure the side sections of the right and left panels are positioned inside of the awning support arms.

E. Repeat this step for remaining Horizontal Rafter.

Step Eleven: Mount Button Snap Fasteners

A. Fold the side Panel flap outward.

B. Mark the uppermost fastener location.

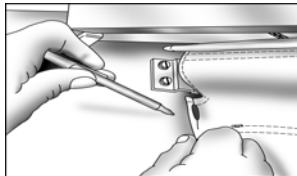

Installation Instructions

C. Mark the fastener mounting holes and pre-drill each hole using a 7/64" drill bit.

D. Apply silicone sealant to the back of the button snap fastener and secure the upper-most fastener to the side of the RV.

E. Pull the side panel straight and taut, then mark the remaining fastener locations.

F. Pre-drill and install the remaining fasteners.

G. Repeat this step for the other side panel fasteners.

Step Twelve: Trim Roof Support Flap Seal

Note: The roof support flap seal is located on the coach side of both panels and is designed to wrap around the vertical roof support member as equipped on most pop-up tent trailers. In some instances the flaps will need to be trimmed for an exact fit between the roof section and the main body section of the RV.

A. From inside the screen room, wrap the flap behind the vertical roof support member and pull it through to the outside of the side panel. Mark the point where the bottom edge of the roof section intersects with the vertical edge of the side panel.

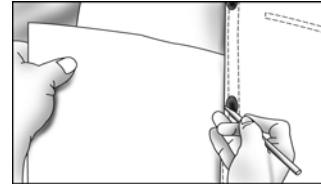

B. Using a straight edge, mark a horizontal line from this point to the outside edge of the flap.

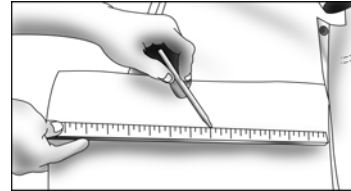

C. Carefully cut along the horizontal line from the edge of the flap to the stitching of the hem. Then cut up along the hem to remove the excess portion of the flap.

Caution: Care must be taken during this step. Do not cut into the stitching, just up to it.



D. In the same manner, mark and cut the bottom portion of the RV.

E. From inside the room, the flap seal can now be tucked neatly behind the vertical support member, (wrapped from outside to inside), and secured with the attached Velcro straps.

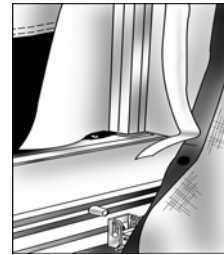

Note: Velcro straps can either be tucked behind the seal or trimmed.

F. Repeat step twelve for the other roof support flap seal.

Step Thirteen: Install the Skirting Fasteners

A. Center the skirting so each end extends beyond the panels.

Warning! Skirting must not interfere with LP appliance vents.

B. Mark a fastener location at one end of the skirting at a point just below the entry door,³ then install a button snap fastener as before.

C. Pull the skirting horizontally taut and level, then mark the remaining snap fastener locations.

³The top edge of the skirting must not extend above the bottom edge of the entry door frame.

Section One

- D. Pre-drill and install the remaining fasteners as before.
- E. Using the same procedures, mount the fasteners for the Wheel Filler Panel. Make sure it overlaps the top edge of the skirting, or is tucked behind it.
- Step Fourteen: Slit Skirting for Entry Step**
- Note: The entry step should remain in the "down" or "extended" position while installing and using the Campout Breezeway Screen Room.*
- A. Locate the upper-most portion of the extended entry step supports by "feeling through" the skirting as illustrated.

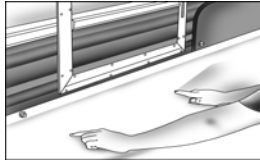

- B. Mark the inner and outer edges of the step hardware on each side of the entry step.

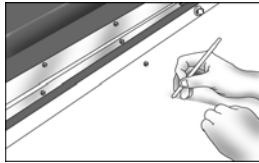

- C. Measure the overall height of the step hardware and add 1/4" to this measurement.

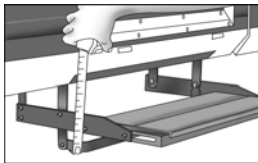

Installation Instructions

- D. Mark the skirting correspondingly. the result will be two triangular shapes as illustrated.



- E. Using a straight edge, connect and mark the bottom tips of the triangles.



- F. Carefully cut out each triangle completely, then cut along the line between the triangles.

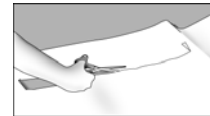

Tip: Use a sharp knife or the point of the scissors to puncture the skirting inside each triangle. Then, carefully cut along the marked lines.

- G. Allow the step to protrude through the skirting. Tuck the flap into a position behind the step tread.



This completes the installation procedures for the Campout Breezeway Screen Room. For final details concerning securing the sections of the room see Section Two, Operational Instructions.

Section Two

Step One: Fully Extend the Awning

- A. Extend the awning to its full open position. Be sure the awning is raised to a position that does not interfere with the opening and closing of the entry door or screen door.

Tip: Once the correct angle is achieved, file a notch, or otherwise mark each awning arm so subsequent set-ups will be identical.

Step Two: Insert Left Panel

- A. Carefully slide the left panel into the slot in the lead bar until the notched upper corner of the panel reaches the 5/16" hole in the lead bar.

Caution: Extreme care must be taken not to puncture the left panel during this step!

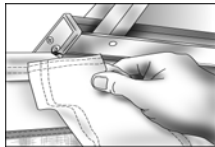

Tip: Silicone spray lubricant makes this task easier.

Step Three: Install Right Panel

- A. Carefully slide the right panel into the lead bar until it reaches the previously installed left section.

Caution: Extreme care must be taken not to puncture the panel during this step!

Tip: Silicone spray lubricant makes this task easier.

- B. At the center of the awning, zip the two panels together and center the connected sections in the lead bar between the two previously drilled 5/16" holes.

Operational Instructions

Step Four: Install Horizontal Rafters

- A. Assemble the rafters by inserting the poles with the spring loaded buttons into the larger diameter poles with a hole in one end so that they line up. The remaining pole goes into the other end of the larger diameter pole. On some 7' models there will only be a 2 piece pole with no spring loaded buttons.

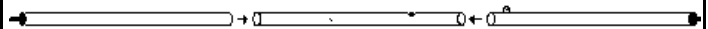

- B. Carefully insert each rafter into the pocket on the top of the side panels, with the longest pin going toward the awning lead bar. (See illustration).

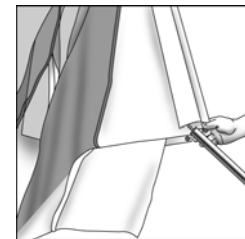

Caution: Extreme care must be taken not to puncture the side panels during this step!

- C. Carefully maneuver the rafter into the channel section of the lead bar and push each Horizontal Rafter into the mounting bracket against the side of the RV.

Tip: This is easier if the awning support arm is temporarily removed from the bottom bracket and positioned vertically below the lead bar during this step.

Section Two

D. Then fully insert the straight pin on the Horizontal Rafter into the hole located in the lead bar. (See illustration)

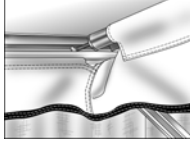

Tip: Be sure the side sections of the right and left panels are positioned inside of the awning support arms.

E. Repeat this step for remaining Horizontal Rafter.

Step Five: Mount Skirting

A. Manually lower the entry step to its extended position.

B. Attach the skirting utilizing the button snap fasteners located along the bottom edge of the RV.

C. Allow the step to protrude through the skirting. Tuck the flap into a position behind the step tread.

D. Fold any excess skirting material into the room and secure the bottom edge to the ground using the supplied anchoring spikes.

Installation Instructions

E. In the same manner, secure the wheel filler panel to the side of the RV.

Step Six: Secure Side Panels to RV

A. Fold the Side Panel flaps outward and the roof support flap seals inward.

B. Attach the panel to the side of the RV using the button snap fasteners located on the roof section and body section of the RV.

C. Wrap the roof support flap seal behind and around the vertical support member, (*outside to inside*), and secure with the Velcro straps.

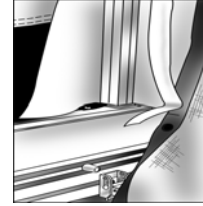

D. Repeat step six for the other side panel.

Step Seven: Secure Room to the Ground

A. As with the skirting, fold the excess material at the bottom of the screen room and secure to the ground with the supplied anchoring spikes.

Section Three

FOLDING INSTRUCTIONS

1. Lay one of the panels face up and flat on a clean and dry surface.
2. Square off the panel by folding the upper pie of wedge shape inward.
3. Fold the panel in half laterally by bringing the bottom edge up to the top portion.
4. Fold laterally in half again by folding the top half down to the bottom edge of the previous fold.

Operational Instructions

5. Starting at one end, fold over in sections of about 12".
6. Repeat Steps one through five for the other screen section.

Section Four

- Periodically clean the fabric using a mild laundry detergent or an approved aftermarket awning or vinyl cleaner.
- Use only a soft brush for cleaning or scrubbing.
- Be sure to clean both sides of the fabric and to rinse thoroughly.

Maintenance

- Allow the fabric to dry completely before storing your Campout Breezeway Screen Room.
- Do not use oil based cleaners or any caustic, granulated, or abrasive type cleaners on your Campout Breezeway Screen Room.
 - Replace any parts that become damaged.