

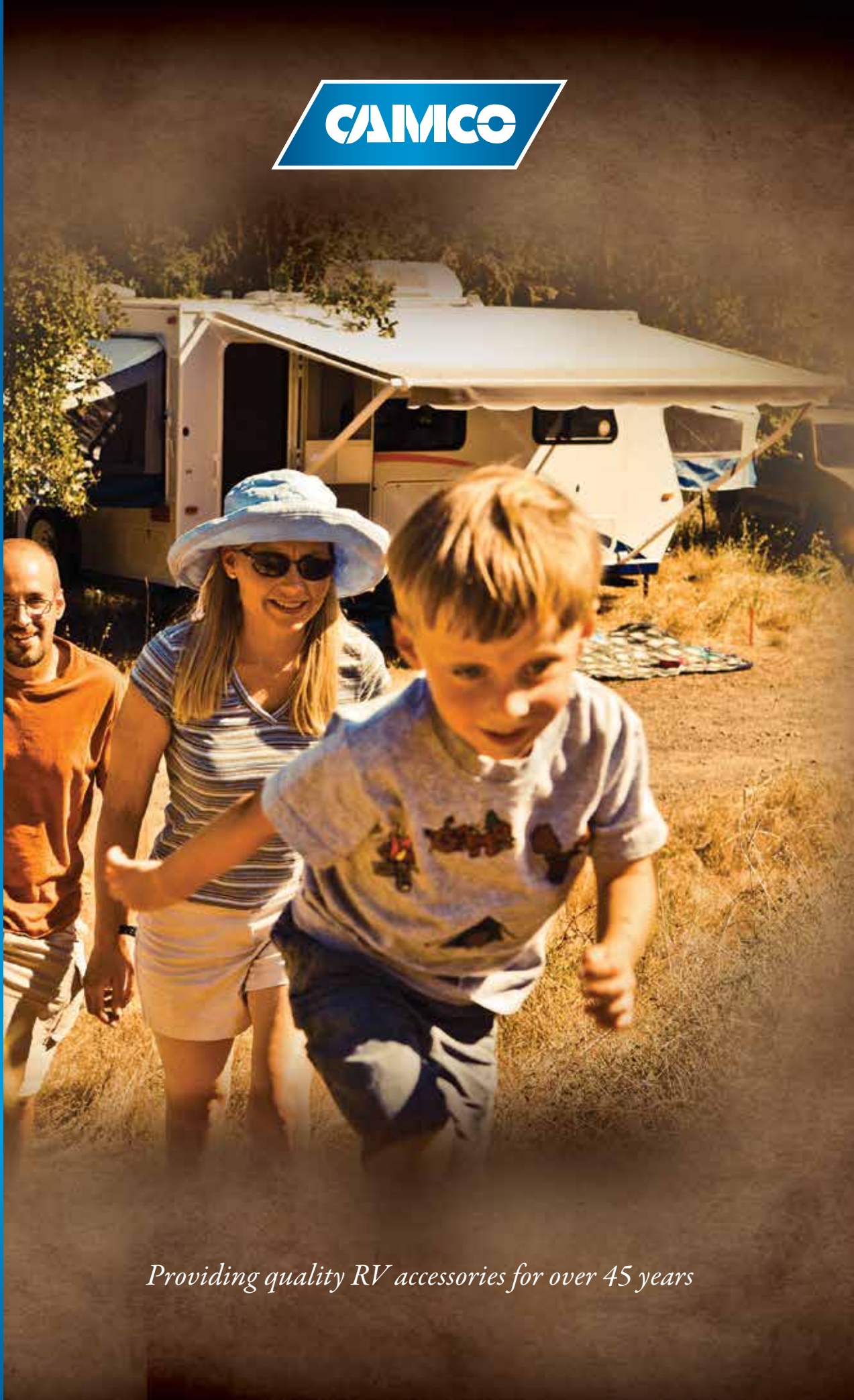

RV ACCESSORIES



Providing quality RV accessories for over 45 years



Welcome



Albany, OR



Leominster, MA



Beilun, China



Elkhart, IN



Reidsville, NC



Sriracha, Thailand



Headquarters, Greensboro, NC



Quality, innovation and customer service aren't just catch phrases at Camco - they're our goals. And we work toward them every day, in every department from the front office to shipping. Each of our more than 800 employees stands behind the products that bear the Camco name.

When Camco began in 1968 with one employee and one product, there was little indication that we would experience the phenomenal growth that resulted in our being named to the North Carolina Top 100 by Business North Carolina for six years in a row. Hard work, determination and adherence to these ideals have enabled us to achieve great success.

We take pride in providing outstanding service. Most orders received by noon are shipped the same day. Our friendly, knowledgeable customer service staff stands ready to assist our customers with any questions.

Camco is a small, privately-held company with big aspirations. When you place an order with us, we'll demonstrate this with our actions. Let us help make your business as successful as it can be.

Don Caine
Founder/CEO

Contents



2	Awning & Outdoor
26	Camping Essentials
36	Grills & Accessories
46	RV Covers
52	Housewares
68	Hardware
76	LP Gas
86	Appliances
96	Winterizing
102	Fresh Water
112	Sanitation
132	RV Cleaning & Care
140	RV Towing
160	Leveling & Stabilizing
170	Electrical
190	Starter Kits
193	Index
198	Numeric Index



Awning & Outdoor

Featured products:



Outdoor Mats
page 7



Tipsy Stix[®]
page 12



Big Red Campfire[™]
page 18



Outdoor Chairs
Propane Campfires
Party Lights

Party Light Holders
Rugs and Mats
Stabilizers

De-Flappers™
Replacement Parts



3 Awning & Outdoor



NEW



A

A. Zero Gravity Recliners are stylish and comfortable. The frame is constructed of powder coated steel. The fabric is weather resistant and UV protected to provide years of use. They feature a dual locking system so that you can stay in the position that is most comfortable for you. These zero gravity recliners also fold to 5" for easy storage and transport.

- 51810 Black Swirl
- 51811 Green Swirl
- 51812 Tan Fern
- 51813 Red Swirl
- 51820 Black Swirl - padded
- 51821 Green Swirl - padded
- 51822 Tan Fern - padded



C

B. Zero Gravity Wide Recliners have the same quality and style as our regular recliners, plus 4 inches of extra width for added comfort.

- 51830 Black Swirl
- 51831 Green Swirl
- 51832 Tan Fern
- 51833 Red Swirl
- 51840 Black Swirl - padded
- 51841 Green Swirl - padded
- 51842 Tan Fern - padded



B



C

C. Folding Directors Chairs Stylish, comfortable chairs include a 14" x 9" wide table that folds up conveniently for storage. Lightweight aluminum frame makes it easy to transport. Features padded arm rests and weather-resistant, UV protected fabric.

- 51800 Black Swirl
- 51801 Green Swirl
- 51802 Tan Fern
- 51803 Red Swirl

D. Chair Bag Protect your folding or recliner chairs during storage in this reinforced carry bag. Heavy-duty zippered top allows easy access. Shoulder straps and grab handle make it easy to carry your folding chairs comfortably. Vented design helps prevent mold and mildew growth. Fits either two standard chairs or one recliner.

- 45431 Chair Bag



D



ZERO GRAVITY RECLINERS



ZERO GRAVITY WIDE RECLINERS



ZERO GRAVITY PADDED RECLINERS



ZERO GRAVITY PADDED WIDE RECLINERS

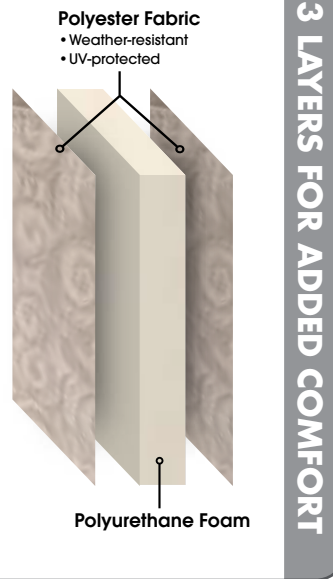

FOLDING DIRECTORS CHAIRS



A. Premium Quality Awning & Leisure Mat This attractive 7' x 15' mat is made from a heavy-duty woven polymeric material which allows snow and rain to drain through. Reinforced corners with rust resistant grommets provide an easy way to secure it using included ground stakes. Helps keep dirt from being tracked into your RV. Easily cleaned with soap and water. Comes with heavy canvas bag for storage and transport.

42811 brown - 7' x 15'

42812 gray - 7' x 15'

B. Awning/Leisure Mat Helps keep dirt from being tracked into your RV. Great for picnics and beach outings. 7' x 15' mat cleans easily with soap and water. Made of durable, mildew resistant materials, with rust resistant grommets and ground stakes included. Dark green woven design allows snow and rain to drain through mat. Includes handy strap for easy storage.

42810 7' x 15' mat



C. Awning Mat Cleans easily with soap and water. Made of durable, mildew resistant materials, with rust resistant grommets and ground stakes included. Woven design allows snow and rain to drain through mat. Helps keep dirt from being tracked into your RV. Also useful for picnics and beach outings. 6' x 9' or 9' x 12'.

42880 green - 6' x 9'

42881 blue - 6' x 9'

42882 burgundy - 6' x 9'

42883 brown - 6' x 9'

42820 green - 9' x 12'

42821 blue - 9' x 12'



D. Awning Mat Anchors Keep your awning mat flat with Awning Mat Anchors. Get rid of the rocks that you've been using to keep your awning mat from "bunching up" or blowing away. Set of four white plastic clips with hold-down nails will keep the awning mat flat on the ground. Low profile molded plastic.

45631 set of 4

A. Open Air™ Outdoor Mats are reversible, lightweight and easy to clean. Mold and mildew resistant; perfect for putting by your RV, at your campsite or on your patio. Four styles, each available in green, blue, burgundy or charcoal. Mats fold easily for storage.

- 42870 Green Stripe - 6' x 9'
- 42871 Blue Stripe - 6' x 9'
- 42872 Burgundy Stripe - 6' x 9'
- 42873 Charcoal Stripe - 6' x 9'
- 42850 Green Oriental - 9' x 12'
- 42851 Blue Oriental - 9' x 12'
- 42852 Burgundy Oriental - 9' x 12'
- 42853 Charcoal Oriental - 9' x 12'
- 42830 Green Botanical - 8' x 20'
- 42831 Blue Botanical - 8' x 20'
- 42832 Burgundy Botanical - 8' x 20'
- 42833 Charcoal Botanical - 8' x 20'
- 42840 Green Swirl - 8' x 16'
- 42841 Blue Swirl - 8' x 16'
- 42842 Burgundy Swirl - 8' x 16'
- 42843 Charcoal Swirl - 8' x 16'

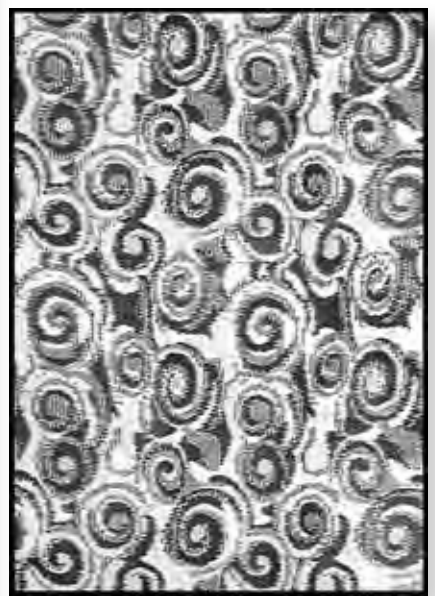
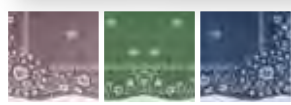



Party Lights available in ten fun designs

PARTY LIGHTS

Add a festive glow to your outdoor living area with these party light sets. Each 8-foot strand contains **10 lights**, and connector for hooking strands together. Each set includes two spare bulbs and a spare fuse. 120 V with overload protection. UL certified for indoor and outdoor use.



A. Party Lights - Stars Patriotic Star Party Light set.
42656 Stars

B. Party Lights - Motorhomes Whimsical Motorhome Party Light set.
42653 Motorhomes

C. Party Lights - Retro Motorhomes Nostalgic Retro Motorhome Party Light set.
42654 Retro Motorhomes

D. Party Lights - Retro Travel Trailer Nostalgic Retro Travel Trailer Party Light set.
42655 Retro Travel Trailer

E. Party Lights - Flags & Ribbons Patriotic Flags and Ribbons Party Light set.
42657 Flags and Ribbons

F. Party Lights - Race Flags & Tires Race-inspired Flag and Tire Light set.
42658 Race Flags and Tires

G. Party Lights - Chili & Cactus Jaunty Chili and Cactus Party Light set.
42659 Chili & Cactus

H. Party Lights - Fuzzy Dice Nostalgic "Fuzzy" Dice Light set.
42660 Fuzzy Dice

I. Party Lights - Bottles & Mugs Spirited Bottles and Mugs Light set.
42661 Bottles and Mugs

J. Party Lights - Flamingos and Palm Trees Tropical fun Party Light set.
42662 Flamingos and Palm Trees



A. RV Awning Hanger Clips Hang lights, flags, banners and more from your RV's awning channel with Camco's Awning Hangers. Our innovative design allows two hangers to clip together giving you even more hanging options. 8 pack. Patented.

42720 8/pack

B. Fits-All™ RV Party Light Holders

Hang party lights, signs, plants and more from your awning roller bar. The Fits-All™ RV party light holders slide easily into roller bar channel, and each hanger can support up to 15 pounds. Each holder has two sizes of channel insets; fits all automatic roll out awning roller bar channels. Patented.

42693 7/pack

C. RV Party Light Holders Hang party lights quickly and easily. Strong, flexible vinyl holders slide securely into the awning roller bar channel. Seven 8" lanyards with metal hooks included in each pack to allow party lights to hang below RV awning valance.

42703 7/pack

D. Fabric Party Light Holders

Sturdy sewn fabric tabs with grommets slide easily into your roller bar channel to hold lights, wind chimes and more. When storing awning, just remove the hooks; tabs can be left in place. Includes 7 tabs and hooks.

42733 7/pack

E. Lantern Snaps Attach patio lights, screens, canvas or poly film to your awning quickly and easily. Open one end, snap to awning fabric, then snap the other end to the lights, or push the flexible tabs into the awning roller bar channel and attach the snaps to the tabs. Durable metal construction.

42713 4/pack

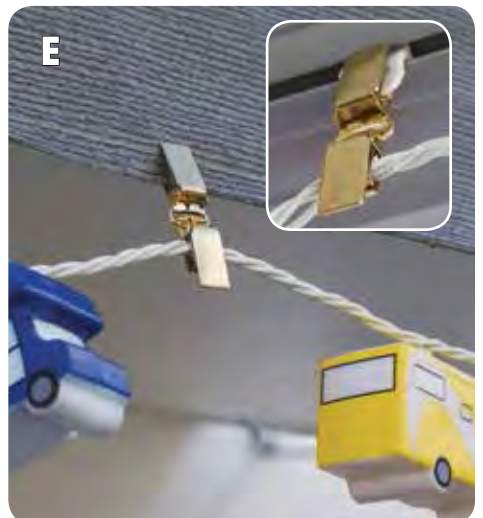
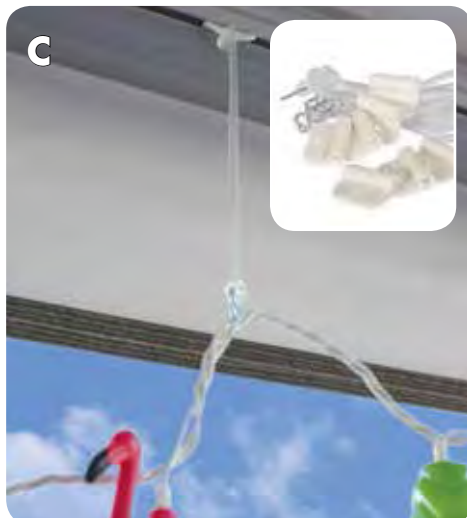

A



A. Aluminum Step Platforms with adjustable- or fixed-height legs. Each stool has a 19 × 14½ inch platform. Easy to set up; supports up to 1000 pounds. Strong and sturdy construction with non-slip rubber feet. Legs fold for easy storage (storage height: 2¾ inches). Adjustable-leg stool adjusts between 7 and 8 ½ inches tall. Fixed-height stool is 8 inches tall.

43676 Step Platform, Adjustable Legs

43677 Step Platform, Fixed Legs

B. Step Stools Small stool supports up to 300 lb. Large stool supports up to 400 lb. Patent Pending. Platform dimensions: Small: 9 × 9⅞ × 15⅞ inches, Large: 9¼ × 10⅞ × 17⅜ inches.

43460 Stool, Plastic, Small

43470 Stool, Plastic, Large

NEW



B

C. RV Extra Step Heavy-duty steel-frame stool. Folding legs lock open to 7" height. Extra-wide 8" × 19" platform with angled legs to provide stability. Gripper strips on platform. Folds to only 2" wide for storage. Supports up to 300 lb.

43675 RV Extra Step



C



D. Fold-Away Step Stool This small, sturdy stool is perfect for all those little jobs around the RV. Opens to 11-1/2" tall. Lightweight aluminum construction. Supports up to 300 lb.

43672 Folding Stool

E. RV Wrap Around Step Rug

For manual or electric RV steps. Adjusts to fit almost any RV step. Just wrap around existing step and hook springs into the holes that fit your step. No screws, glue or tools needed. Helps to keep your RV clean by cutting down on tracked-in dirt. 18" wide.

42921 brown

42923 Green

42924 Blue

42925 Grey

D



E, F

F. Step Rug XL is designed to fit larger manual or electric RV steps. 23" wide.

42935 Grey

42931 brown

42933 Green

42934 Blue

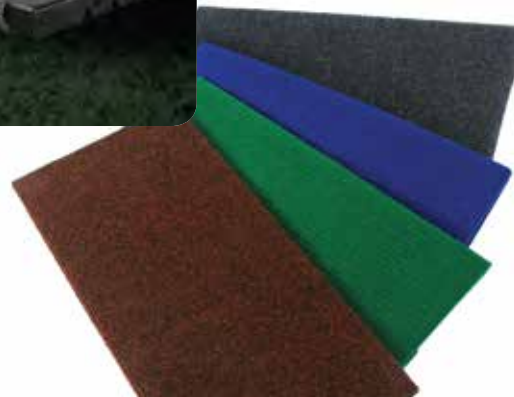

A. Telescoping RV Easy Reach Awning Opener Easily extend your awning with this handy tool with an extended length of up to 47". Easy to store: telescopes down to 12". Stainless steel.

42544 RV Awning Opener - 20/ctn

B. RV Awning Pull Straps Open awnings with ease. RV Awning Pull Strap slides into your RV Awning's Channel and can stay there for storage to have an easy way to roll your awning out or retract every time.

42504 Window Awning Straps - 2 pack

42505 Patio Awning Strap

C. Awning Door Roller Open your door without the worry of damaging your awning. Camco's RV Awning Door Roller™ mounts directly on your door to protect your awning from wear and tear. Innovative roller-ball design rotates 360° to follow the arch of the door. Includes Screen Door Slider.

42005 Awning Roller Ball

D. Screen Door Awning Savers

Snap the plastic Awning Saver on the corner of the screen door to help prevent ruined awnings. Snaps on quickly and easily without tools.

42073 2/pack

E. Awning Roller with Screen Door Slider

Roller mounts directly onto door to protect awnings from wear and tear without marring the awning. Zinc-plated housing provides years of peak performance.

42003 Awning Roller

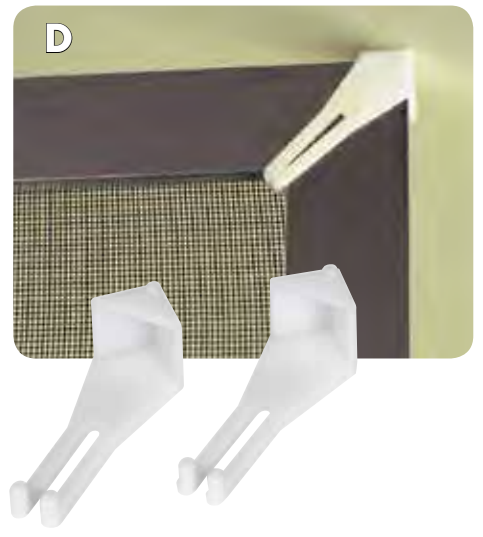
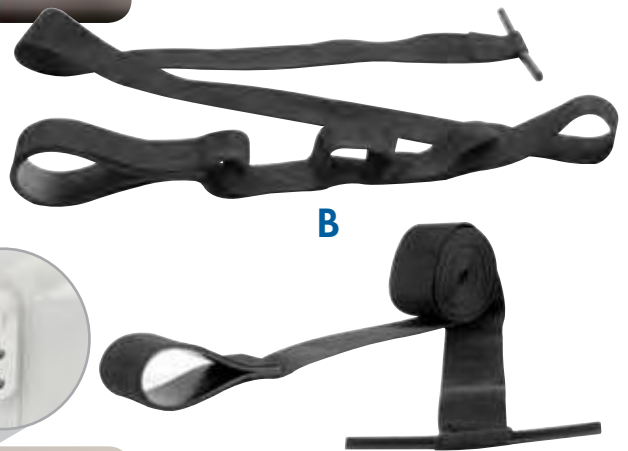

A



NEW

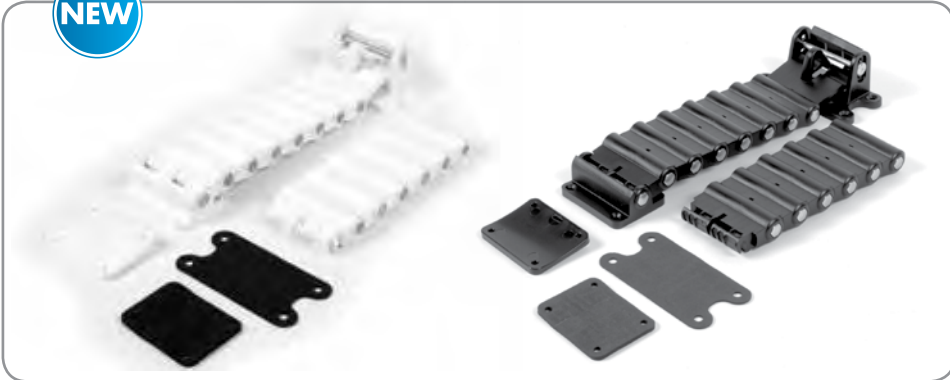

B



A. RV Awning-Clamp™ was developed by a team of engineers to overcome the inherent problem of awnings unfurling during travel. By clamping the middle of the awning, you take away the power developed by strong micro-bursts of air and keep your awning securely in place. The adjustable links ensure a perfect fit on any awning. RV Awning-Clamp allows you to travel without worry. Latch and unlatch your awning in seconds using a standard awning wand. Adjustable links for a perfect fit on all awnings; Three RV mounting options: roof, wall or radius mount.

- 42551 white
- 42556 Black

B. Topsy Stix® Holds a variety of beverages and snacks. Beverage holders lock in two ways for standard size beverages. Bonus snack holder holds bowls and plates. Great for outdoor parties and activities. Patent Pending.

- 51463 Topsy Stix

A. Awning Anchor Kit Sturdy strap and springs provide even distribution of tension and make securing your awning easy. Extra holding power of spiral stakes works well in all kinds of soil and makes this unit ideal for use in sandy soil. Perfect for use at the beach. Kit stores compactly and fits all awning sizes.

42593 Anchor Kit

B. Awning Stabilizer Kit Secure your awning economically. Spiral stakes work well in all kinds of soil and are ideal for securing in sandy soil. Tension units keep ropes securely taut. Easy-to-use kit stores compactly and fits all awning sizes.

42563 Stabilizer Kit

C. RV Awning Hold Down Strap Kit Secure awnings in breezy conditions through evenly distributed tension. Sturdy strap is wrinkle resistant with triangle rings to hold it flat and neat. Fits awnings up to 25'. Includes two steel 15" awning stakes. Once assembled, the unit is easily stored with no danger of lost parts.

42514 Awning Hold Down Strap Kit

D. Awning Spring This 7" spring replaces worn or corroded awning springs or stake frame canopy springs.

42532 7" spring

E. Awning Stake Sturdy awning stakes secure your awning hold down strap. Made of durable steel. Zinc-plated for corrosion resistance.

42522 15" stake



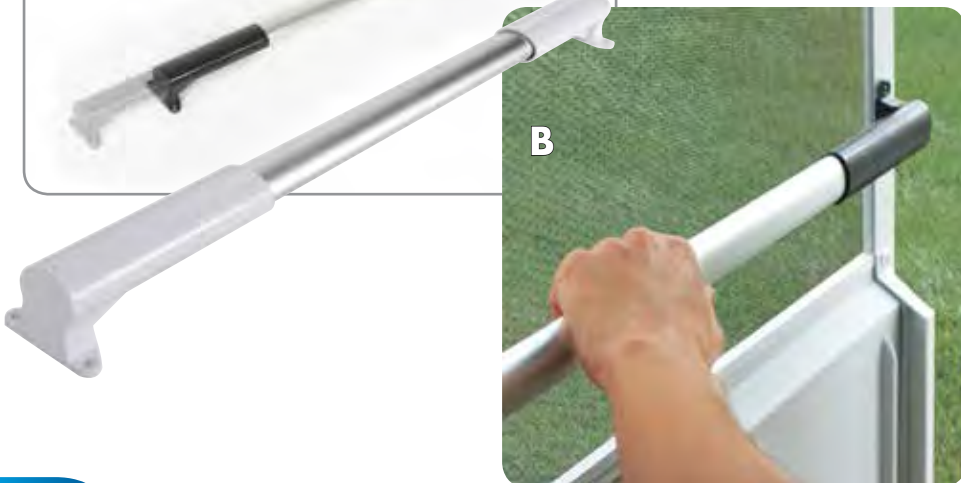

A. Screen Door Push Bar and Grille

Sturdy Push Bar and Screen Door Grilles combine to allow for easier exit and protection of your RV screen door. Adds a sturdy feel to your door and saves repairs to screens. Helps prevent children and pets from pushing through screen. Push Bar and Deluxe Grille both adjust from 20" - 32"; Standard Grille adjusts from 20" - 29". Easy installation, hardware included.

- 43971 Push Bar - aluminum
- 43977 Push Bar - white
- 43991 Deluxe Grille - aluminum
- 43997 Deluxe Grille - white
- 43993 Deluxe Grille - Black
- 43980 Standard Grille - aluminum

B. Screen Door Cross Bar

Allows for easier exit and protection of your RV screen door. Adds a sturdy feel to your door and saves repairs to screens. Aluminum bar with black or white molded handles. Easy installation, hardware included. Adjusts from 21-1/4" to 28-5/8". Patented.

- 42183 Screen Door Cross Bar - Black
- 42186 Screen Door Cross Bar - white

C. Screen Door Handles

For easy access in and out of your screen door, use this top / bottom mounted Screen Door Handle. Designed to fit between the RV door and the screen door. Made of molded plastic. Two-sided tape is provided for attaching to the most convenient location on your door. Set of 2.

- 45551 Screen Door Handles, white

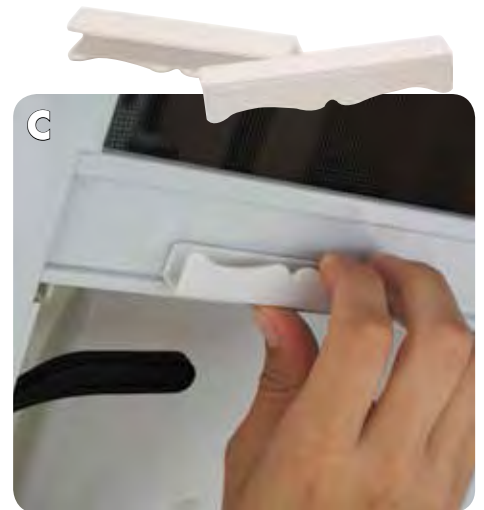

A. De-Flapper™ Protect your RV awning from costly rips and tears while preventing noisy wind flapping. De-Flapper™ holds securely with hook-and-loop fastener straps. Made of durable nylon with UV stabilizers, chemically resistant and rust proof. Universal fit. Soft, non-marring grippers protect awning fabric. Can be used with screen room in place. Patented.

42061 2/pack

42083 13" replacement straps 2/pack

B. De-Flapper™ MAX This larger version of the original DeFlapper™ with wider grippers keeps awnings even more stable in wind or rain.

42251 2/pack

42243 Replacement straps 2/pack

C. Awning Arm Anchor Awning arms stay securely on the ground in carport position with Awning Arm Anchors. Holds awning arm in carport position more securely than regular stakes. Rust-resistant zinc-coated steel.

42021 Awning Arm Anchor

D. Tail Gate Screen Door is a great option for trailers without a factory-installed screen door. It fits almost all toy trailers on the market, letting you stay bug-free and keep your privacy with the tailgate down. Designed to work with spring type or cabled doors; magnetic floor tabs keep it in place. Includes detachable privacy panels. Made of mold- and mildew-resistant fabric. Simple to install; requires no drilling. Hook-and-loop fasteners make set-up fast and easy.

45141 Tail Gate Screen Door

E. Power Hook™ Awning Tensioner Reduce the noise of flapping fabric without stakes or anchors. Tensioner pulls awning roller taut. Easy installation requires no tools and attaches to all existing awning hardware. Patented.

42013 Power Hook

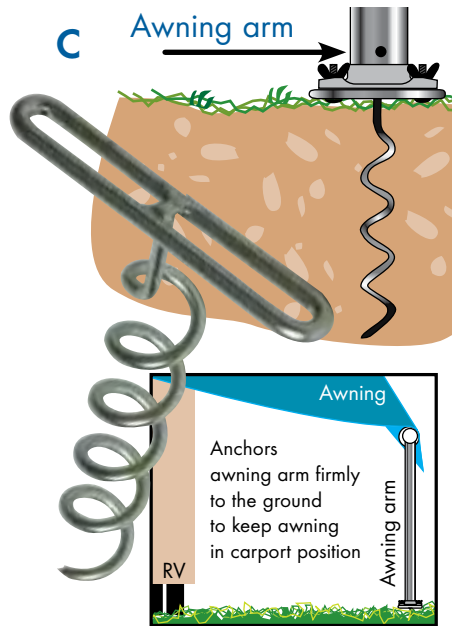
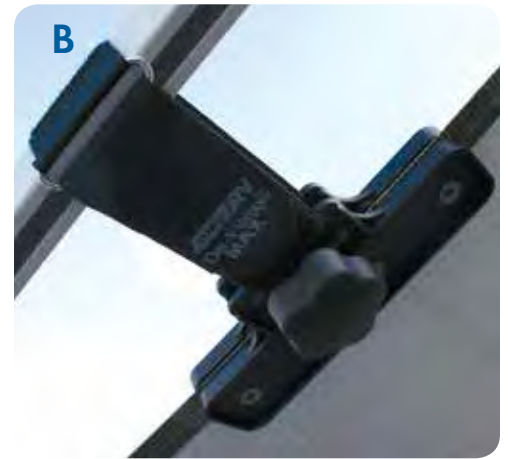

E



A

A. Screw-in Triple Flag Holder

Holds flags with 3/8" or smaller staffs. Durable white plastic. Screws are provided for easy installation. 3" x 5".

45504 Screw-In Triple Flag Holder

B. U.S. Flag A fabric, full detail printed flag, mounted on a 1/4" wooden staff with gilded spear. Finished edges. 12" x 18".

45491 US Flag

C. Happy Hour Flag A white fabric 12" x 18" flag with a beer mug, martini glass and the words "Happy Hour" in red. This flag will let your friends know that after a hard day at the RV park, you're ready to relax and enjoy the evening.

45492 Happy Hour Flag



B



C

D. Suction Cup Flag Holders Easy to use; no drilling. Each suction cup holds up to three pounds. When moistened, suction cups stick to any smooth, clean nonporous surface. Remove before traveling. 3" x 5" 3-hole style holds flags with staffs up to 3/8". White ABS plastic.

45502 3-Flag Holder

E. RV Single Flag Holder For small staffs. Holds on windy days. Installs to any existing screw on your rig. Durable plastic with tapered 2-inch shaft. Set of two.

45501 Single Flag Holders - set of two



D



E



A. 20' Telescoping Flagpole with Car-Foot Flag Holder Fly your flag anywhere you park your RV. Rust-proof anodized aluminum pole extends to 20' (6 m) and collapses to 64" (1.63 m). Hardware allows you to fly up to two flags at once, or fly a flag at half mast. Both include tire-anchored flag holder, storage bag and bonus 3' x 5' American Flag. 51605 also includes permanent residential mount.

- 51600 20' Flagpole w/car foot
- 51605 20' Flag Pole
w/car foot and Residential Mount

B. Fiberglass Flagpole Fly your flag anywhere you park your RV. Unlike aluminum poles, fiberglass flagpoles will not conduct electricity. Extends to 16' (4.8 m) and collapses to 48" (123 cm) for storage. Hardware allows you to fly up to two flags at once, or fly a flag at half mast. Includes a durable tire stand, residential mount and storage bag.

- 51606 Fiberglass Flagpole

C. Hitch-Mount Flagpole Holder Fits standard 2" hitch receivers. Holds flagpoles up to 2-11/32" in diameter, and includes thumbscrew to hold pole in place. Durable power-coated finish.

- 51611 Hitch-Mount Flagpole Holder





A



A. Little Red Campfire™ Take your fire with you! Our compact, portable campfire is great for campsites with restrictions against in-ground fires. Take it tailgating, or put it on the patio...its size is convenient for wherever you need a fire. Realistic log pieces and full 9.5" diameter ring burner help create the natural look and ambiance of from-scratch campfires. Sturdy lid and security latches make it safe and easy to transport. Includes 8' propane hose for use with standard LP gas cylinders. RV campground approved. 11.25" fire tray diameter. 65,000 BTU/HR.

- 58031 Little Red Campfire™
- Replacement Parts for Little Red Campfire™
- 58032 Replacement Log set
- 58034 Replacement Hose w/Regulator



B



NEW

B. Big Red Campfire Take your fire with you! Our Big Red Portable Campfire is great for campsites with restrictions against in-ground fires. Take it tailgating, or put it on the patio...its size is convenient for wherever you need a fire. Updated realistic log piece and full 9.5" diameter ring burner help create the natural look and ambiance of from-scratch campfires. Sturdy lid and security latches make it safe and easy to transport. Self storing lid can also serve as a Campfire base. Includes 10' propane hose for use with standard LP gas cylinders. RV campground approved. 13.25" fire tray diameter. 65,000 BTU/HR.

- 58035 Big Red Campfire



C



C. Little Red Campfire™ Cook Top Now you can cook with your Little Red Campfire. Unfold the legs of the Little Red Campfire Cook Top to create a cooking platform for pots and pans at the perfect height. Legs fold for convenient storage in the included bag.

- 58033 Campfire Cook Top



D

D. Campfire Propane Adapter Safely and easily installs to one of Camco's propane connection kits (59103, 59123 or 59143) to use the onboard propane supply to fuel your Campfire. Can also be used to convert any appliance from a Type I ACME to a 1"-20 Throwaway connection for use with a disposable 1-lb bottle of LP Gas.

- 59213 Propane Adapter



NEW

A. Portable Propane Campfire

Features like an elevated fire tray and heat resistant base make this Portable Campfire perfect for use in campgrounds with fire restrictions; great for residential porch and patio use as well. Large 14½-inch burner ring allows for even distribution of gas and flame. 8-ft hose and adjustable regulator allows easy control of desired fire size up to 65,000 BTUs per hour with no ash, no mess and no smoke. Includes two bags of lava rocks. Legs fold completely under to fit into included storage bag.

58041 Propane Campfire

B. Collapsible Fire Ring Safely contain your campfire with Camco's Portable Campfire Ring. The large, 27-inch-wide steel ring will accommodate your natural wood-burning fire. Six-piece hinged design unfolds and assembles easily with no tools required. Tree cut-outs create a captivating ambiance. Folds flat for easy storage. Includes a zippered bag for easy transportation.

51090 Folding Fire Ring

C. Telescoping Roaster The perfect tool for cooking marshmallows, hotdogs or sausages over an open fire. Stainless steel—Extends up to 34". The roaster is intended for use over an open wood fire.

44014 Telescoping Roaster



NEW



A

NEW



A. Aluminum Folding Tables

combine lightweight materials with a durable design. Perfect for RVing, camping, tailgating or out on the porch or patio.

Tables set up without tools in seconds and folds to only 2" wide for compact storage.

Small table has a 12" x 10" top, opens to 16.5" tall and supports up to 130 lb. Folded dimensions: 18.5" x 12" x 2".

Large table has a 19.5 x 19" top, opens to 23.7" tall and supports up to 110 lb. Folded dimensions: 28.25 x 19.5 x 2".

FOLD-AWAY TABLES

51890 Folding Side Table, 12" x 10"

51891 Folding Table, 19.5 x 19"



B. Aluminum Roll-up Table

Lightweight functional design makes this table portable, easy to set-up and break down with storage bag included. Hollow, aluminum slat top attaches easily to cross-support bars and segmented legs. Seats 4-6 people. No tools required. The roll-top feature makes the table and bag compact for easy storage.

51892 Roll-Up Table w/Carrying Bag



AWNING & OUTDOOR



A

A. Handy Mat This Handy Mat is perfect to take with you wherever you go. Includes built-in handles and convenient pockets on both sides. Folds out to 60 × 78 inches and folds to a compact 10.5 × 15 inches. Perfect for picnics, beaches, RVing and outings. Durable polypropylene may is weather-proof and mold- and mildew-resistant. UV stabilized for years of use. Easily cleans with soap and water.

42805 Handy Mat

B. Picnic Blankets Great for picnics, tailgating, camping or an emergency blanket in your RV or car. Durable waterproof backing with foam cushioning adds comfort and insulation. Folds compactly and hook-and-loop fastener keeps blanket folded for storage. Soft, insulated surface is easy to clean. Acrylic face; expanded PE foam inner liner; PVA back face. 51 inch × 59 inch.

42800 Black/Yellow

42801 Red/white

C. Tablecloth Clamps Hold tablecloths securely under the windiest conditions. Red plastic clamps won't rust or corrode. Use on tables from 1/2" to 2" thick.

44003 4/card

NEW



B



C



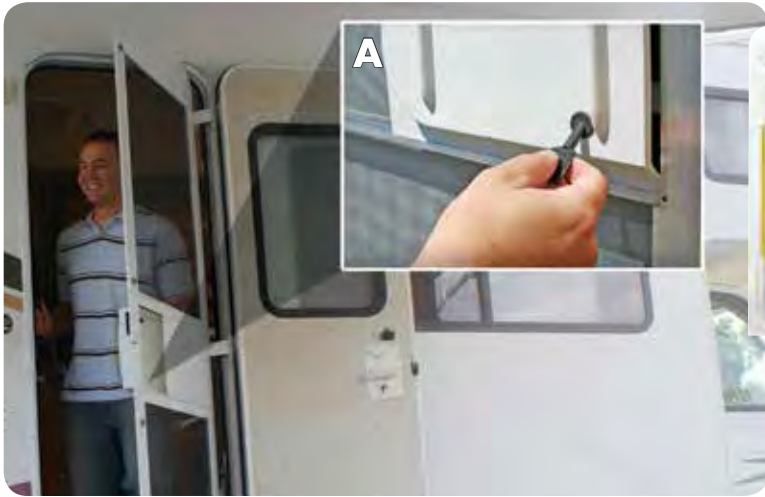

A. Screen Door Opener Install this handy timesaver using just a drill. Now you can open the screen door, keep the slide closed and keep the bugs outside. Just pull up to open the screen door. Patented.

43953 Screen Door Opener

B. Screen Door Slides Replace your missing or damaged screen door slide.

- 45511** 12" × 11.5", beige
- 45512** 12" × 11.5", Clear
- 45513** 12" × 11.5", white
- 45514** 12" × 11.5", Black
- 45521** 12" × 8", beige
- 45522** 12" × 8", Clear
- 45531** 9" × 11.25", white
- 45532** 9" × 11.25", beige
- 45533** 9" × 11.25", Black
- 45534** 9" × 11.25", Clear

C. Stationary Pieces Replacement Stationary Piece for the flat (non-sliding) part of the screen door opening.

- 45561** 12" × 13", beige
- 45562** 12" × 13", Clear
- 45563** 12" × 13", white
- 45564** 12" × 13", Black
- 45571** 12" × 16", beige
- 45572** 12" × 16", Clear
- 45573** 12" × 16", white

D. 12" Screen Door Stops Designed to fit Camco 12" Screen Door Slides. A screen door "Stop" is required to block the opening between the slide and door frame. Buy this Stop when purchasing 12" slide or 12" slide set. Not needed on all doors.

- 45541** beige
- 45542** Clear
- 45543** white
- 45544** Black

E. Screen Door Slide Sets 12" sets include Slide and Stationary Piece. 9" sets include Slide, Stationary Piece and Stop.

- 45581** 12" × 24", Clear
- 45582** 12" × 24", beige
- 45583** 12" × 24", white
- 45584** 12" × 24", Black
- 45591** 12" × 28", Clear
- 45592** 12" × 28", beige
- 45593** 12" × 28", white
- 45601** 9" × 24", Clear
- 45602** 9" × 24", beige
- 45603** 9" × 24", white



A. Clamp-N-Carry™ Chair and Bike Rack

Securely hold four or more chairs (depending on chair style) on most standard 1" and 7/8" diameter ladders (adapters included). Glass-filled nylon construction with UV protectants and zinc-plated hardware. Lockable rack won't rust or corrode, and swings out of the way quickly for ladder access. Includes an adjustable strap to stabilize chairs while traveling.

51430 Clamp-N-Carry™

B. Chair and Bike Rack Sturdy vinyl-covered steel construction. Easy to install to create more external storage. Fits all RV ladders and holds up to four folding lawn chairs.

51490 Chair and Bike Rack

C. Spiral Anchor Secure your pet outside. Works well in all kinds of soil; ideal for securing in sandy areas. Swivel ring helps prevent your pet's chain from becoming wrapped around the stake.

42572 Spiral Anchor

D. RV Window Thermometers

Mount 3" square thermometers on exterior of window panes (one on each side of your RV). This will allow you to compare temperature readings in sun and shade wherever you are parked. Two-pack for sun & shade readings.

44313 2-pack





A



B

A. Folding Rake Keep your campsite neat with this full-size compactible rake. Opens to 60" long with a 22" wide rake end. Folds down to 29" x 8" to easily fit in a storage compartment.

42171 Folding Rake

B. Pop-Up XL Container

XL Container is ideal for storage, yard work and more. Extra handle at bottom for easy lifting. Includes toggles for a secure close. Heavy duty canvas construction with padded handles and durable liner. Fits 30 gallon trash bags. Stands 28" tall and 22" in diameter. Stores 2.5" high.

42895 XL Container



C



C. Pop-Up Recycle Container

Features three compartments labeled bottles, cans and paper for your convenience. Collapses to 2.5" high with padded handles, durable liner and zipper lid. Includes storage bag and stake.

42983 Recycle Container



D

D. Pop-Up Utility Container A sturdy frame for 33 gallon bags that can be easily moved around to accommodate needs inside or out. Features a durable liner, padded handles, a lid that zips closed, and a stake to secure it in place against wind, pets and people. Constructed for rugged, heavy duty use, this tear resistant container is lightweight and flexible. Stands two feet tall, and collapses in seconds to store at just 2-1/2" high in its zippered storage bag.

42893 Container

E. RV Collapsible Bucket The perfect size for RVing, camping, fishing, [boating](#) and more. 3 gallon (11 liter) capacity.

Opens easily to 9.25" (23.5 cm) tall and folds to less than 2" (3.5 cm) for compact storage. Zippered storage bag included.

42993 Bucket



E



F

F. Mini Pop-Up Utility Container

Collapses to 2.5" high with built-in storage strap. Hook-and-loop tape on base to help hold in place.

42903 Mini Pop-Up Container

A. Non-Slip Tape for RV Steps

Help prevent slips and falls with this self-adhesive tape. Use for added safety on steps, ladders and walkways. Available in black or black/yellow safety stripe. 2" x 15'.

25401 Non-Slip Tape, Black

25405 Non-Slip Tape, Black & yellow

B. Replacement Awning Knobs

Exact replacements for Faulkner, A & E or Carefree awnings.

42303 Faulkner/A & E - 2/card

42363 Carefree - 2/card

C. Awning Straps

Replace worn or lost awning straps. For use on awning arms. 12" lengths. Velcro® straps with pull-through buckles. Also useful for securing all sorts of items around your RV.

42503 2/card

D. Awning Locking Pins

A universal fit for Carefree, A & E and Omni brands. Beveled for easy insertion.

42403 2/card

E. RV Awning Repair Tape

Permanent repair for rips and punctures. Aggressive adhesive; resists tearing in any direction. Use for RV awnings, boat sails, canvas, tents, rain wear, backpacks, pool covers and liners, seat covers, auto soft tops, pop-up campers and more.

42613 Awning Repair Tape - 3" x 15'

42623 Awning Repair Tape - 5" x 15'

F. RV Screen Door Closer Kit

Keep your screen door shut with the RV Screen Door Closer Kit. Dual spring action pulls door closed with evenly distributed tension. Installs easily on standard (square corner), radius corner (such as Winnebago) or fold-down tent camper doors. Patented.

44133 Screen Door Closer Kit



Faulkner / A & E

Carefree

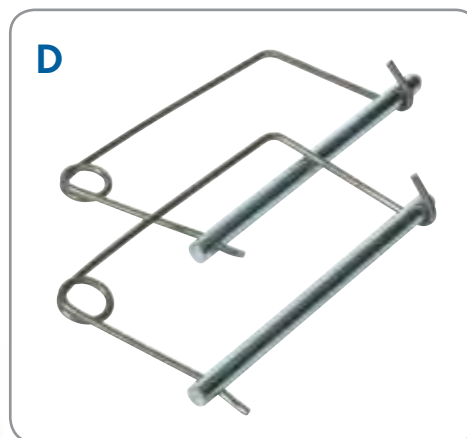



Camping Essentials

Featured products:



Camp Griddle
page 29



Camp Saw
page 30



Lantern Hanger
page 32



Cookware

Saws

Fasteners

Repair Kits

Tools

Stakes and Pegs



NEW

Camping Essentials

27



A



A. Tripod Grill and Lantern Holder

Cook over an open fire with handy tripod grill. Seventeen-inch-diameter chrome-plated grilling surface is height-adjustable for better control of cooking temperatures. Or use it to hold your lantern for hands-free light. Fast and easy setup; compact storage.

51078 Tripod Grill and Lantern Holder



B

B. Expandable Water Carrier

Camping water carrier holds 8 liters (2.1 gallons) of water. Screw-on spigot cap allows easy filling and controlled dispensing. Built-in handle for easy carrying. Great for camping or tailgating.

51084 Water Carrier with tap

C



C. Egg Carriers These clean, compact and unbreakable egg carriers help prevent eggs from breaking.

51012 Holds 6 Eggs

51014 Holds 12 Eggs

D. Food Cover Tight mesh cover opens like an umbrella to keep your picnic safe from bothersome flies and insects. Cover measures 12 x 12 inches when open.

51302 Food Cover



D



E

E. Tablecloths - Red & White Vinyl

Available as tablecloth (52" x 84") only or tablecloth (54" x 84") with two bench covers (18" x 84"). Vinyl material makes for easy cleanup.

51018 Tablecloth

51020 w/bench covers

F. Knife Sharpener Molded of sturdy ABS with special ceramic sharpening surfaces to quickly and easily reshape a dull blade. Small enough to fit on a keychain.

51028 Knife Sharpener

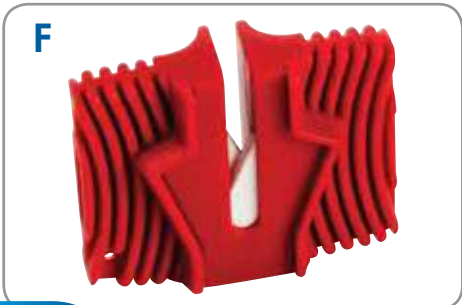

F



G

G. Deluxe Tablecloth Clamps

are Spring loaded for a more secure hold. Tablecloth clamps fit picnic- or patio tables up to 1.5 inches thick. Set of four.

51076 Deluxe Tablecloth Clamps



A. Camping Cook Set Anodized aluminum nesting set with folding handles includes travel bag. Contains pot, saucepan, frying pan, three plastic bowls, a plastic spoon, plastic scoop with folding handle and a scrubber.

51312 Camping Cook Set

B. Campers' Salt and Pepper Shaker Convenient travel size. All-in-one design is moisture-proof and spill-proof. Unscrew ends to fill, unscrew from center to use.

51056 Salt and Pepper Shaker

C. Camp Stove Toaster Rack Foldable compact design. Great for use with gas camping stoves. Toast up to 4 slices of bread at one time. 19 inch x 22 inch

51034 Toaster Rack

D. Camp Griddle Non-stick-coated aluminum griddle is perfect for making breakfast under the open sky. 10" x 16.5".

51048 Camp Griddle

E. Can Openers Compact, lightweight can openers are easy to use, and fold down to fit in a pocket. Nickel-plated hardened carbon steel stays sharp for many years. Set of two.

51040 Can Openers - set of two

F. Fuel Funnel Fuel funnel with built-in screen for use with camp stoves and lanterns. 2.5 inch diameter.

51050 Fuel Funnel

G. Telescoping Fork The perfect portable tool for roasting hot dogs or marshmallows over an open wood campfire. Extends out to 26 inches, telescopes down to a compact 13 inches for easy carrying.

51304 Telescoping Fork

H. Safety Fork 41-inch-long safety fork with stay-cool wooden handle has the tines turned inward. This helps prevent accidental injuries, and helps keep the food from sliding off into the fire.

51308 Safety Fork

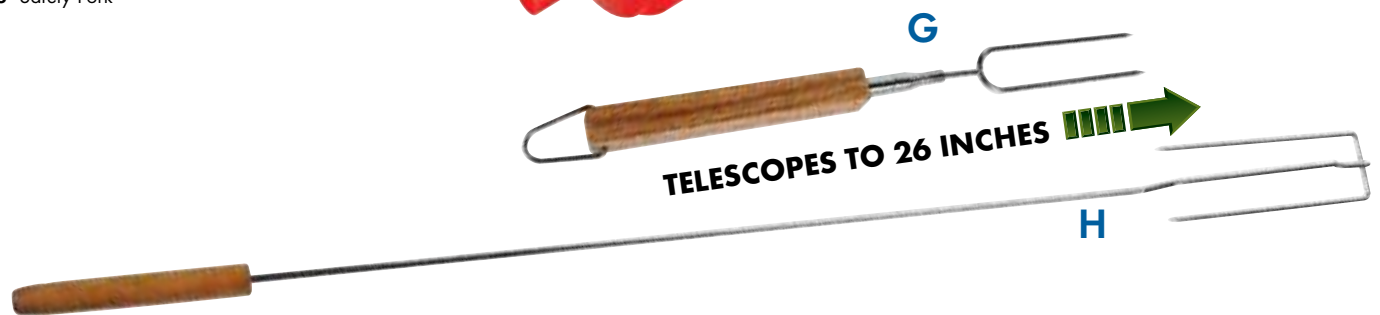

A



A. Camp Saw 10-inch triple-edge blade makes this an ideal saw for camping or home. Cuts natural and synthetic wood, plywood, drywall, PVC pipe and more.

51026 Saw w/sheath

B



B. Folding Saw Folding saw with triple-edge blade offers high-quality performance. Features comfortable ergonomic handle and a two-position locking blade for safety.

51352 Folding Saw

C



C. Pocket Saw Handy wire saw is over 20 inches long, but rolls up easily to fit in a pocket. Strong enough to cut through wood, bone, plastic and soft metals.

Wire length: 20.75 inches

51354 Pocket Saw

D



D. Camp Axe A durable camp axe is a must-have tool for every campsite. Use while camping, hiking, backpacking or in the yard. This durable, heavy-duty axe has drop-forged steel head, a steel shaft and non-slip ergonomically designed handle for superior grip. Use the blade to split firewood or help clear areas for camping. Use the blunt side to help drive tent stakes. The included plastic sheath makes it safe to transport when not in use.

51082 Camp Axe

E



E. Tent Stakes Made of heavy-duty steel with durable plastic T-stopper.

51010 Tent Stakes, 10 inch, 2 pack

51086 Tent Stake, bilingual - Bulk

F



F. Tent Pegs For tents, awnings, sports nets and more. Made of tough ABS plastic with large non-slip hook. High-visibility color. Set of six 9-inch or 12-inch pegs.

51044 Tent Pegs - 9 inch - set of 6

51042 Tent Pegs - 12 inch - set of 6

G



G. Tent Stake Puller Plated-steel tent peg puller with comfortable grip allows easy removal of tent pegs.

51058 Tent Peg Puller

A. Foldable Camp Shovel Foldable shovel with heavy-duty steel blade. Features serrated edge and locking collar. Folds compactly to carry along in its own storage pouch.

51074 Camp Shovel

B. Multi-Function Tool Stainless steel tool folds up to fit in pocket or pack. Includes three knife blades, two screwdrivers, can opener, bottle opener, mini-saw, grip teeth, pliers, wire cutters and two rulers. Includes carrying case.

51080 Multi-Function Tool

C. Multi-Purpose Scissors

Multi-purpose scissors are the ideal tool for camping or home. Detachable stainless steel blades and a variety of useful tools; scissors, screwdriver, can opener, wrench, fish scaler, nutcracker, jar wrench, wire stripper, wire cutter, bottle opener and knife.

51038 Multi-Purpose Scissors

D. Lensatic Compass Don't get lost while camping! Use this handy compass to find your position using a map and three landmarks.

51362 Lensatic Compass

E. 6-Function Survival Whistle

Includes a safety whistle, magnifier, compass, ultra-bright led, signal mirror and Fahrenheit/Celsius thermometer, all in one compact, easy-to-carry tool.

51364 Survival Whistle

F. Folding Scissors Compact folding scissors tuck easily into your pocket, purse or pack. Ideal for fishing, camping or travel.

51060 Folding Scissors

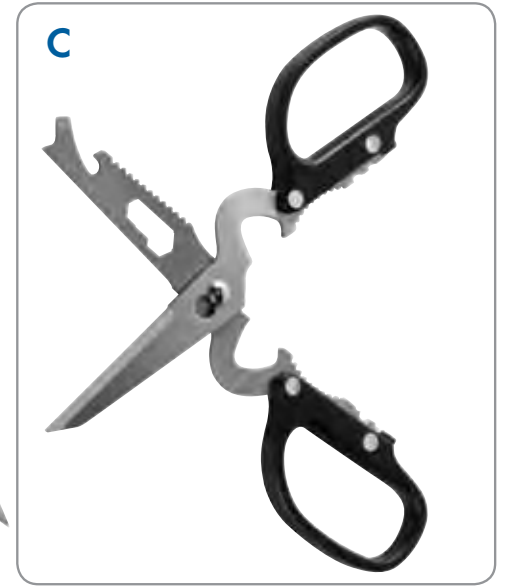
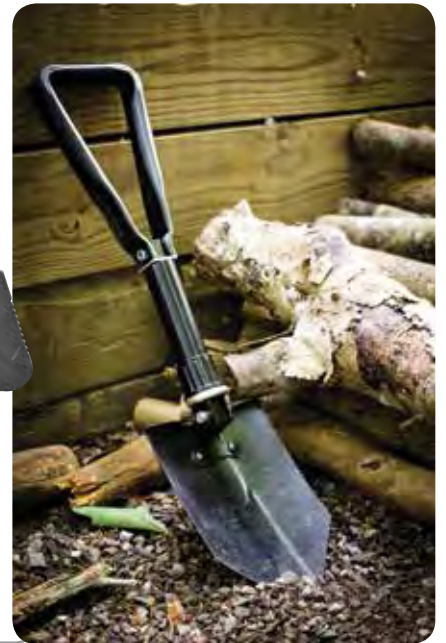



A

A. Emergency Blanket Waterproof and windproof reflective mylar blanket helps retain body heat. Opens to 52 × 84 inches, folds down small enough to fit in a pocket.

51322 Emergency Blanket

B. Magnesium Fire Starter Scrape off magnesium shavings, mix with tinder and strike the fire-steel with the attached sparker. The shavings will burn hot, even when damp, making fire-starting in wet conditions much easier. Compact starter is fireproof when solid.

51332 Magnesium Fire Starter

C. Lighter Flints Replacement flints for lantern lighter or camp stove. Comes with resealable storage bag.

51024 Lighter Flints, 10 pack

D. Firestarter Sticks Quick and safe way to start fires. Burn completely without odor. Non-toxic and waterproof. Easy to carry and store.

51016 Firestarter Sticks, 12 pack

E



E. Carabiners Aluminum biner clips with key rings. Set of two Three-inch clips in assorted colors. Perfect for attaching light equipment to your backpack or belt. Not for climbing.

51346 Carabiners - set of two

B



C



D



F



F. Lantern Hanger Campground-approved lantern hanger won't damage trees. Helps keep bugs up and away from campsite, and works on trees or posts up to 20 inches in diameter.

51054 Lantern Hanger



A. Dunk Bag Nylon mesh Dunk Bag will not rot or retain odors. Handy all-purpose bag with sewn-in drawstring is great for laundry or storage.

51030 Dunk Bag

B. Sewing Kit Travel-size sewing kit contains 50 yards (45.7 m) assorted thread, 5 needles, needle tube, needle threader, thimble, 8 buttons, 2 snaps, 5 safety pins, 2 straight pins, measuring tape, scissors and plastic box.

51052 Sewing Kit

C. Laundry Bag Lightweight fabric laundry bag with mesh vent has a side pocket that doubles as a zippered pouch to hold the bag when its not in use.

51338 Laundry Bag

D. Laundry Reel Lightweight, compact laundry reel is easy to set up. Contains 21 feet of laundry line and two hooks for easy mounting. Wind-up reel for easy storage.

51064 Laundry Reel

E. Ditty Bag Set Great for organizing camping or home items. Made of water-repellent nylon and features a push-button draw string. Set contains 3 sizes: 6 x 12.5 inch, 5 x 11 inch, 4.25 x 9 inch

51008 Ditty Bag Set - Nylon, 3 pack

F. Waterproof Pouches Triple-fold pouch tops with hook-and-loop closure and handy strap keep the water out so your valuables stay dry. Three sizes to accommodate everything from cell phones and keys to books and maps. 10.5 x 13.5, 6.75 x 10 and 4.75 x 7 inches.

51340 Waterproof Pouches, set of 3

G. Tent Whisk with Dust Pan

Travel-sized tent whisk snaps into dustpan to keep them together for convenience.

51032 Whisk w/dust pan

H. Soap Dish Covered soap dish with a securely snapping lid closure and vent holes in the bottom.

51356 Soap Dish



A



B



A. Vinyl Repair Tape For quick repair of rubber or vinyl gear, ground sheets, waders, rain gear and more. Contains four pieces of self-adhesive vinyl.

One each: 3 × 6 inch; 3 × 7 inch; 3 × 8 inch and 3 × 9 inch

51326 Vinyl Repair Tape

B. Tarp Clips Two-piece clips work on tarps, plastic sheeting, tents and awnings to create an extra tie-down point without punching a hole in the fabric.

51344 Tarp Clips - Set of 4

C

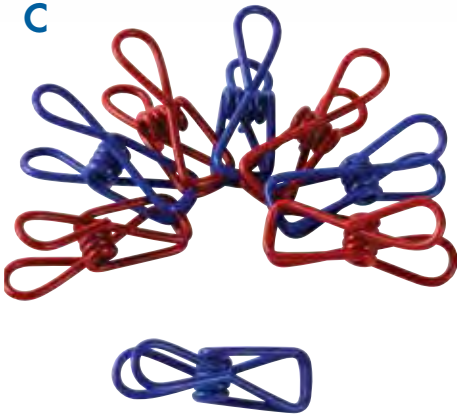

D



C. Utility Clips Set of eight clips with protective coating. Permanently string clips onto your 3/16 inch (4.8 mm) or smaller clothes line, so they won't get lost. Can also be used to hang patio lights, or as snack bag clips.

51036 Utility Clips - set of 8

D. Plastic Grommets Grommets for use with plastic or canvas sheets. Just snap together and tap to seal. Set of eight.

51046 Tap-In Grommets - 8-pack

E



F



E. Snap Fastener Kit Comes with a flaring tool and setting base. Everything you need to add or replace snap fasteners. For tarps, tents, car or boat covers, awnings and more.

51006 Snap Fastener Kit, 10 Sets

F. Mosquito Coil Holder Securely holds burning mosquito coils and keeps the ash contained. Can be hung up or placed flat on a table.

51062 Mosquito Coil Holder

G



H



G. Citronella Candle Citronella candle in a convenient metal container with lid for easy storage and transport. Helps keep the bugs away from your camping area.

51022 Citronella Candle

H. Tick Remover Remove ticks easily and safely with this tool. Special design holds securely with minimum risk of damaging tick during removal.

51316 Tick Remover



A

A. Utility Straps Durable 1-inch-wide polypropylene straps are ideal for camping or outdoor use. Attached buckle for securing the straps.

- 51066 Utility Strap - 4 ft
- 51068 Utility Strap - 6 ft
- 51070 Utility Strap - 8 ft
- 51072 Utility Strap - 10 ft



B

B. Sleeping Bag Straps Set of two durable 4-ft, 3/4-inch-wide polypropylene straps are ideal for securing sleeping bags, tents and other camping equipment. Attached buckle for fastening the straps.

- 51348 Sleeping Bag Straps



C

C. Stretch Cord Ideal for camping and outdoor use. Coated hardened-steel hooks. Flexible rubber core. Weather-resistant outer layer. 50 inches long.

- 51000 Stretch Cord, 50 inch, 1-Pack

D

D. 20-inch Stretch Cords Set of two durable stretch cords. Ideal for camping and outdoor use. Weather-resistant outer layer. Coated hardened-steel hooks and flexible rubber core.

- 51342 Stretch Cords, 20-inch, set of 2

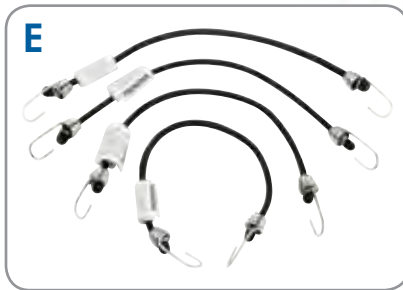

E

E. Mini Stretch Cords Set of four mini cords; ideal for camping and outdoor use. Hardened-steel hooks. Flexible rubber core. Weather-resistant outer layer.

- 51002 Mini Stretch Cords, 10 inch, 4-Pack

F. Braided Poly Cord Polypropylene shell with polyester core. Wound around a reusable plastic spool.

- 51004 Braided Poly Cord, 50 ft, Green

F



G

G. 50 ft Rope Sturdy polypropylene braided rope for medium-duty camping use. Great around the house as well.

- 51350 50 ft Rope



Grills & Accessories

Featured products:



Olympian™ Hybrid Grill
page 40



**Olympian™ 5500
Stainless Steel Grill**
page 41



**Deluxe
Folding Grill Table**
page 42



Gas Grills
Grill Tables

Gas Hoses
Gas Accessories

Gas Matches
Sparkers



Grills & Accessories

37

PREMIUM GRILLS

Olympian grills are designed specifically for RVing, tailgating and patio or deck grilling.

- RV mountable
- Quality materials
- Quick-Connect available
- New Hybrid model runs off standard LP or electricity



Olympian 3500-C Electric Grill:
The perfect portable grill for the chef with limited storage space.

Electric

The Olympian 3500-C Electric Grill is designed specifically for RVing and tailgating as well as patio and deck grilling—It's compact, portable and powerful. Constructed of high-quality stainless steel, the Olympian 3500-C comes fully assembled and ready to plug into any standard 120V electrical outlet. The 145-square-inch cooking surface heats up to 700° F and is regulated by a simple control knob. Grilling on any flat surface is easy with the integrated fold-away legs, or it can be mounted to your RV mounting rail with the Olympian RV mounting rail bracket (sold separately). Additional features: A removable grease tray to help ease cleaning and stay-cool handle.

57240 Olympian 3500-C Electric



ELECTRIC

The Olympian 4500 Grill:

An outstanding grill that offers premium-quality construction and convenient portability.

High Pressure Gas

Designed specifically for RVing, tailgating as well as patio or deck grilling, the Olympian 4500 Grill features a spacious 160-square-inch grilling surface, which is perfect for a family of 4 to 5. The 4500's latching lid and stay-cool handle make it easy to transport. Integrated fold-away legs enable easy grilling on any flat surface or, with the Olympian RV Mounting Bracket (sold separately), it can be mounted to your existing RV mounting rail.

57251 Olympian 4500 Gas



INCLUDES MOUNTING BRACKET



The Olympian 6500 Grill:

Designed specifically for RVing, and tailgating as well as patio or deck grilling—ideal for the grilling enthusiast on the go

LP Valve/Quick-Connect

The Olympian 6500 Grill is the top of the line and features all of the best Olympian has to offer. The Olympian 6500 offers a 316-square-inch cooking surface for full-size grilling power in a convenient, compact size. Features a simple control knob for precise heat control and integrated fold-away legs enable easy grilling on any flat surface. Additional features include removable warming rack, built-in thermometer, push-button igniter, removable Lift-and-Clean™ liner, grease tray, latching lid and stay-cool handle. Includes RV Grill Mounting bracket.

57245 w/LP Valve and Quick-Connect hose



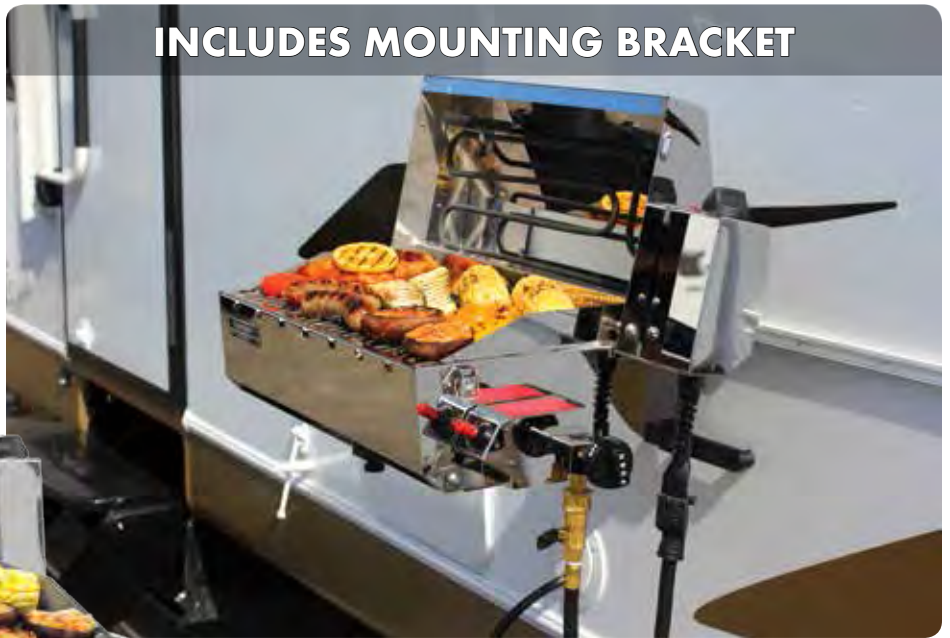

Olympian Hybrid Grill:

You choose—gas or electric. Either way, you will have great-tasting grilled food in minutes.

Electric/LP Gas Valve

Grill with gas or grill with electricity—with Olympian’s Hybrid Grill, it’s up to you! Runs off of your RV’s built-in gas supply or—if you choose—you can save your propane and use park power. The Olympian Hybrid Grill connects to the propane supply on any RV or trailer that has a built-in quick-connect LP gas connection. To use electricity, simply plug the grill into any standard 120V electrical outlet. The Olympian Hybrid is constructed of high-quality stainless steel, comes fully assembled and has a 160-square-inch grilling area. Additional features include; integrated folding legs, piezo igniter, removable Lift-and-Clean™ liner, grease tray, latching lid and stay-cool handle. Includes RV mounting bracket and LP Quick-Connect hose.

57252 Olympian Hybrid



RV Grill Mount is designed to mount your grill to the existing RV Mounting Rail. Thumbscrews make the mount easy to install. Rubber feet help prevent scratches. Fits Olympian 5500 (2014 and later), and Olympian 3500-C, 4500 and 6500, and all Kuuma Brand Grills. Made of durable stainless steel and anodized aluminum for a lasting finish.

58090 Universal Grill Mount

No ashes or mess
Smoker plate replaces lava rock
More-even heat distribution

cast iron smoker plate

A. Olympian™ 5500 Stainless Steel RV Grill Designed for RV and outdoor use, this high quality lightweight stainless steel barbecue increases flavor without flare-ups. Grilling on any flat surface is easy with the integrated fold-away legs, or it can be mounted to your RV mounting rail with the Olympian RV mounting rail bracket (sold separately). Smoker plate is designed to offer the fullest flavor while minimizing grease fires. Includes Quick-Connect hose and valve to use the propane supply on an RV or trailer that has a built-in low pressure Quick-Connect propane connection. Quick and easy to assemble.

57305 Olympian 5500 SS RV Grill

B. RV Mounting Rail Used for hanging portable grills or other accessories on the side of your RV. This support must be installed by a qualified RV dealer.

57268 Mounting Rail

C. 4100 Tabletop Gas Barbecue Grill Designed for RV and outdoor use, this high quality heavy duty cast aluminum barbecue increases flavor without flare-ups. Cast Iron smoker plate is designed to offer the fullest flavor while minimizing grease fires. After the grill is preheated, the food drippings fall onto the smoker plate, where they vaporize and turn into flavorful smoke, producing great barbecue flavor. Quick and easy to assemble. Uses standard disposable LP cylinders. 22-3/4" w x 17-1/2" d x 8-1/2" h.

57301 Olympian™ 4100 Tabletop Grill



Limited Quantities

Olympian™



A. Folding Grill Stand Use with the 4100 Grill or other appliances. Steel stand folds flat for storage. Powder coated for rust resistance. 14" x 20" x 28". Black.

57321 Universal BBQ Stand

B. Olympian Grill Bag Heavy-Duty weather resistant polyester grill bag provides long lasting protection in every storage environment. Keeps grill free from dust, dirt and scratches.

57632 Olympian Grill Bag

C. Barbecue Adapter Hose No more disposable cylinders. High-pressure hose with adapter for use with Olympian 4100 and 5100 Elite Gas Grills. Male P.O.L. x 1"-20 Throwaway Cylinder Thread. Allows you to connect a full size propane gas bottle to your portable grill.

57636 5' High-Pressure LP Hose

59833 12' High-Pressure LP Hose



D. Deluxe Folding Grill Table

Spacious grill table has a lightweight, high strength steel frame and aluminum table top. Quick and easy to set up. Great for picnics, camping, sporting events and backyards. 57.75" w x 19" d x 32" h. Folds to fit durable carrying case (37" x 20" x 6" - included).

57293 Deluxe Folding Grill Table

89

Olympian™

Grill and accessories not included.



A. 4100 Low Pressure Conversion

Kit Convert an Olympian™ 4100 grill to work with on-board low pressure LP Quick Connect gas supply. Kit is rated for 14" w.c. (0.5 psi max.) of inlet pressure. Includes Quick-Connect grill valve and 10' hose.

57638 Low Pressure Conversion Kit

B. LP Gas Control Valve with Quick-Connect

Replacement part for 5500 SS RV Grill. For using propane supply on an RV or trailer that has a built-in Quick-Connect propane connection. Rated for 14" w.c. (0.5 psi max.) of inlet pressure.

57274 LP Gas Control Valve

C. Quick-Connect to Quick-Connect LP Gas Hose

For using propane supply on an RV or trailer that has a built-in Quick-Connect propane connection. Rated for 14" w.c. (0.5 psi max.) of inlet pressure. Replacement part for 5500 SS RV Grill.

57280 Quick-Connect Hose - 39 in

57282 Quick-Connect Hose - 10 ft

Kits below can also be used to connect any Quick-Connect equipped grill to standard disposable LP cylinders.

D. Female Quick-Connect to ACME Propane Hose

Hook up a quick-connect grill valve to a 5- or 20-lb propane cylinder. Designed to be used only with low-pressure gas appliances (i.e. 14" w.c.) such as our 5500 Grill. Six-foot regulator hose with shut-off valve. Gas bottle not included.

57629 LP Hose Quick-Connect to Acme for use with 5- or 20-lb propane cylinders

E. Female Quick-Connect to Throwaway Propane Hose with Stabilizing Base

Hook up a quick-connect grill valve to a 1-lb throwaway propane cylinder or propane accessory tee. Includes cylinder base and six-foot regulator hose with shut-off valve. Designed to be used only with low-pressure gas appliances (i.e. less than 14" w.c.) such as our 5500 Grill. Gas bottle not included.

57628 Throwaway Cylinder Adapter Kit

A



B



C



D



E



Olympian™



A



B



C



D



E



A. CAMPLighter™ Butane Matches

Heavy-duty child resistant matches available in 8" or 3.5" lengths. Adjustable flame, refillable. Looks like a match, works like a lighter. A nice gift for anyone with a BBQ or a fireplace. CPSC certified.

- 57570 8" CAMPLighter 24/ctn
- 58012 3.5" Pocket Match 24/ctn

B. CAMPLighter™ Elite

Open a bottle and light your grill or heater with one handy and stylish tool. Matte aluminum finish with black accents. Textured back for a sure grip. Adjustable flame; refillable. CPSC certified.

- 58023 CAMPLighter™ Elite Opener/Lighter

C. GM9 GasMatches™

Great for barbecues, fireplaces, pilot lights, kerosene heaters and candles. 11" long. Safety lock, CPSC certified, adjustable flame, fuel viewing window. Refillable with butane lighter fluid. Packaged two per card.

- 57473 Olympian™ GM9 GasMatch™

D. GM4 GasMatch™

Our most popular mid-sized model. Piezo electric ignition, fully adjustable flame, safety lock, fuel viewing window, thousands of lights. CPSC certified. Refillable with butane lighter fluid. 11" long.

- 57453 Olympian™ GM4 GasMatch™

E. Butane Refills

Multi-fill injectors in 78 gram and 165 gram sizes.

- 57416 78 gram butane fuel
- 57496 165 gram butane fuel



A

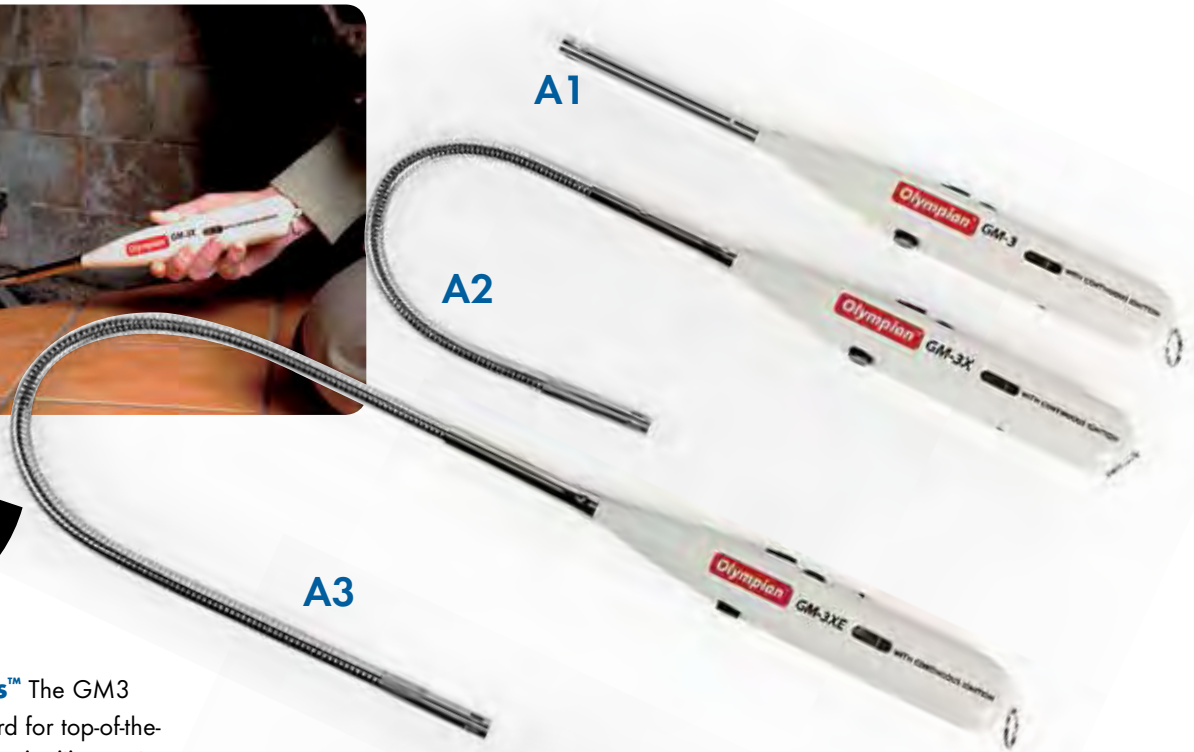

A1

A2

A3

A. GM3 GasMatches™ The GM3 GasMatch sets the standard for top-of-the-line features. The continuous ignition system means that the flame will never blow out. Long slender design lets you get at hard-to-reach places with total safety. Features safety lock, fully adjustable flame and fuel viewing window. 10,000 starts. Refillable with butane lighter fluid. Uses one AA battery, included. CPSC certified.

A1 57433 GM3™ - 14-3/4"

A2 57543 GM3X™ - 26" (15" flex extender)

A3 57684 GM3XE™ - 40-3/4" (26" flex extender)

B. GM12 Continuous Ignition Multi-Sparker This handy igniter is the one designed exclusively for igniting gas appliances. No butane to refill. The continuous electric sparker assures a large and immediate continuous spark. The automatic illumination micro-light and curved nozzle make tough lighting jobs easy. Uses one C battery (included).

B1 57533 GM12 - 13" long (7" pipe)

B2 57561 GM12X - 26" long (20" pipe)



B1

B2





RV Covers

Featured products:



UltraGuard Covers
page 49



Vinyl Tire Protectors
page 51



Wiper Stand-off Wedges
page 51



RV Covers

Windshield Covers

Window Covers

Wheel and Tire Covers

Accessory Covers



RV Covers

47

CAMICO

3 YEAR LIMITED WARRANTY

PREMIUM LIGHTWEIGHT PROTECTION

WOVEN POLYESTER

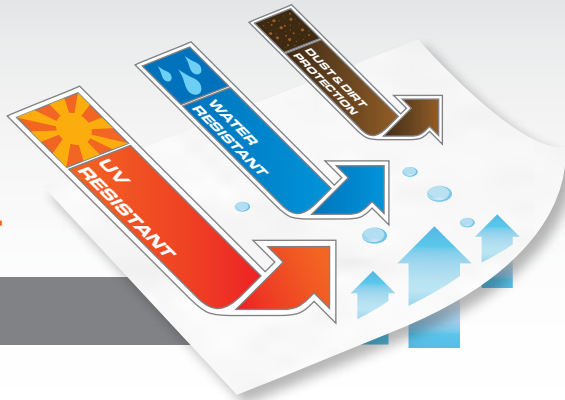

20% LIGHTER EASY TO INSTALL



Vented design improves air circulation which reduces lofting and inside moisture. Exclusive self-adjusting hold down strap system holds cover securely to prevent flapping.

HEAVY DUTY ZIPPERS

Integrated zippers for easy access to doors and storage with cover in place!



Toy hauler ready!

ULTRASHIELD™

- Recommended for warm, sunny regions.
- The lightest weight cover in the industry!
- Woven material allows the cover to slide on easily.
- Fully breathable design resists mold and mildew growth.
- Vented flaps reduce wind lofting and inside moisture.
- Tear resistant.
- Storage bag included.

A. Class A Covers

- 45700 28'
- 45701 30'
- 45702 32'
- 45703 34'
- 45704 36'
- 45705 38'
- 45706 40'
- 45707 42'

B. Class C/Travel Trailer Covers

- 45710 22'
- 45711 24'
- 45713 28'
- 45714 30'
- 45715 32'
- 45716 34'
- 45717 36'

C. 5th Wheel Covers

- 45720 24'
- 45721 26'
- 45722 28'
- 45723 30'
- 45724 32'
- 45725 34'
- 45726 36'
- 45727 38'
- 45728 40'
- 45729 42'

D. UltraShield Patch Kit Repair your UltraShield RV Cover with this 9" x 6' self-adhesive woven polyester patch kit.

45790 UltraShield Patch Kit

Ladder Cover for UltraShield or UltraGuard Not shown.

45796 Ladder Cover

A



ULTRASHIELD CLASS A

B



ULTRASHIELD CLASS C/TRAVEL TRAILER

C



ULTRASHIELD 5TH WHEEL

ULTRAGUARD™

- Recommended for cold, snowy regions
- Triple layer SFS top panel beads water on contact providing maximum resistance to rainfall and snow.
- Heavy duty polypropylene fabric around sides.
- Tough interlocking seams.
- Storage bag included

2 YEAR LIMITED WARRANTY

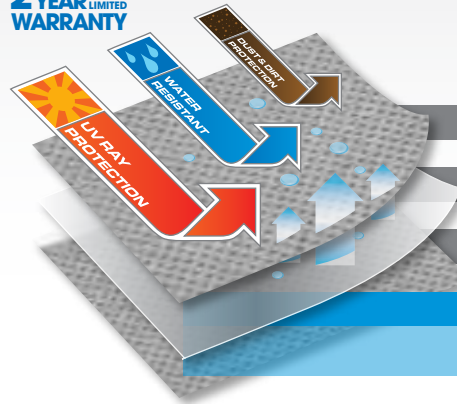

3 HIGH-TECH LAYER PROTECTION

SPUN BOND POLYPROPYLENE

MICROPOROUS FILM BREATHABLE

SPUN BOND POLYPROPYLENE

MICROPOROUS BREATHABLE FILM

High-tech breathable middle layer repels rain and snow while allowing trapped moisture to escape.

A. Class A Covers

- 45730 28'
- 45731 30'
- 45732 32'
- 45733 34'
- 45734 36'
- 45735 38'
- 45736 40'
- 45737 42'

B. Class C/Travel Trailer Covers

- 45740 22'
- 45741 24'
- 45742 26'
- 45743 28'
- 45744 30'
- 45745 32'
- 45746 34'
- 45747 36'



HEAVY DUTY ZIPPERS

Integrated zippers for easy access to doors and storage with cover in place!



Vented design improves air circulation which reduces lofting and inside moisture. Exclusive self-adjusting hold down strap system holds cover securely to prevent flapping.

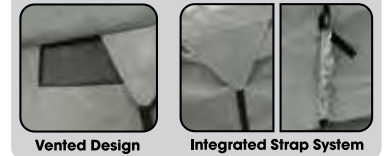

C. 5th Wheel Covers

- 45750 24'
- 45751 26'
- 45752 28'
- 45753 30'
- 45754 32'
- 45755 34'
- 45756 36'
- 45757 38'
- 45758 40'
- 45759 42'

Toy hauler ready!

D. Pop-Up Camper Covers

- 45760 6' to 8'
- 45761 8' to 10'
- 45762 10' to 12'
- 45763 12' to 14'
- 45764 14' to 16'
- 45765 16' to 18'

E. Slide-In Camper Covers

- 45770 18'
- 45771 16.5'
- 45773 19.5'

F. Van Covers

- 45780 Standard: to 18'
- 45781 Extended: to 22'
- 45782 HiTop: to 19'

G. UltraGuard Patch Kit Repair your UltraGuard RV Cover with these 9" x 6' self-adhesive patch kits. Not shown.

- 45791 SFS for top
- 45795 Polypropylene for sides





A. Vinyl AC Covers Vinyl covers protect your air conditioner from dirt, leaves and weather. Locking draw cord ensures a perfect fit. Helps keep out cold drafts.

Arctic white –

45391 Fits Coleman Mach I, II and III TSR models except model #7100 (includes aerodynamic shroud)

45392 Fits Dometic and Brisk Air

Colonial white –

45393 Fits Coleman Mach I, II and III TSR models except model #7100 (includes aerodynamic shroud)

45394 Fits DuoTherm 54608, 54612, 57915; Brisk-Air: 10.5" High/55908, 12.5" High/55912, 12.5" High/55915

45395 Fits Dometic SL Series, Emerson EQK 1100 & 1350*
* Limited Quantities

45396 Fits DuoTherm Penguin "I" & "II", Dometic Low Profile CA Series

45397 Fits Coleman Mini and Super Mach

45398 Fits Dometic and Brisk Air models 57912, 57915, 58915, 58935, 59016, 59036, 59046
Manufactured after 6/1/90

B. Vinyl Windshield Covers

White leather-grained vinyl cover ensures privacy and provides shade. Easy no-drill installation; anti-theft tabs lock in doors.

Arctic white –

45231 Ford '92–Present

45232 Ford thru '91

45233 Chevy/GMC '73-96

Colonial white –

45241 Ford '92–Present

45242 Ford thru '91

45243 Chevy/GMC '73-96

45244 Chevy/GMC '97–Present

45245 Dodge '93–Present

C. Vinyl Spare Tire Covers

Vinyl cover helps keep dirt, rain and sun away from spare tire. Heavy nylon thread helps ensure weatherproofing of seams.

Arctic white –

45340 34" Diameter

45341 32-1/4" Diameter

45342 31-1/4" Diameter

45343 29-3/4" Diameter

45344 29" Diameter

45345 28" Diameter

45346 27" Diameter

45347 25-1/2" Diameter

45348 24" Diameter

45349 21-1/2" Diameter

Colonial white –

45350 34" Diameter

45351 32-1/4" Diameter

45352 31-1/4" Diameter

45353 29-3/4" Diameter

45354 29" Diameter

45355 28" Diameter

45356 27" Diameter

45357 25-1/2" Diameter

45358 24" Diameter

45359 21-1/2" Diameter

A. Wiper Stand-off Wedges Over time, pressure on your wiper blades during storage can cause them to break down and crack. Camco's Wiper Stand-off Wedges™ lift the wipers and remove the pressure, helping to extend the life of your wiper blades.

45456 Wiper Stand-off Wedges

B. Vinyl LP Tank Covers keep tanks weatherproofed and easily accessible. Covers help protect tanks from dirt, sun and rain. Heavy-duty zipper and rigid top insert gives extra strength to tank cover. (Single tank bottle covers have hook-and-loop closure and no top insert.)

arctic white —

45301 20 Single Tank

45302 20 Double Tank

45303 30 Double Tank

45304 40 Double Tank

colonial white —

45312 20 Double Tank

45313 30 Double Tank

45314 40 Double Tank

C. Vinyl Tire Protectors Vinyl covers protect your tires and wheels from sun, dirt, corrosion and all types of weather while your vehicle is parked.

arctic white —

45321 24-26"

45322 27-29"

45323 30-32"

45324 33-35"

45325 36-39"

45326 40-42"

colonial white —

45331 24-26"

45332 27-29"

45333 30-32"

45334 33-35"

45335 36-39"

45336 40-42"

D. Reflective Window Covers

Protect the interior of your coach from UV rays and assist with temperature control. Air-filled cells encapsulated in lightweight, flexible polypropylene between two layers of reflective film. Collapses for storage and attaches with hook-and-loop fasteners for simple installation.

Window Covers

45161 50 x 26"

45162 50 x 30"

45163 62 x 26"

45164 62 x 30"

Window Covers - BULK

45165 24 x 120"

45166 48 x 120"

Window Cover for Doors

45167 16 x 24"



A

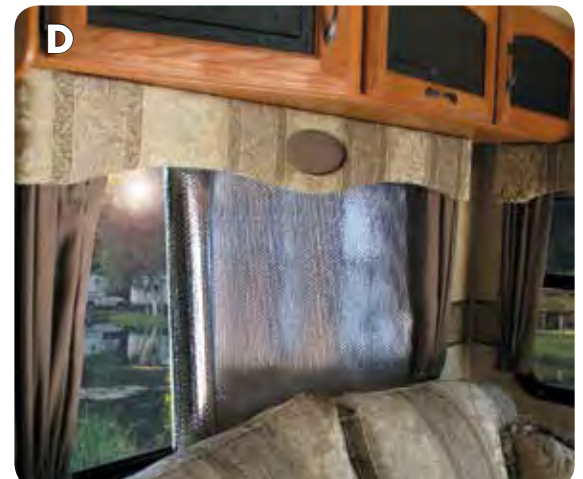

Housewares

Featured products:



Bamboo Cutting Boards
page 55



Mini Dish Drainer
page 60



Showerheads and Kits
page 67



Kitchen Accessories
Oak Accents

Cutting Boards
Pop-A Products

Picnic Helpers
Replacement Parts



Housewares

53



A

Hardwood organizers add elegance to your RV. You will feel right at home amid these solid hardwood products that enhance any decor while helping you make the most of the limited space in your RV.

A. Oak Accents™ Magazine Rack

Accent and organize with this solid oak-finish hardwood magazine rack. Stores magazines, maps, directories and more in one convenient place. Super-hard, non-toxic gloss finish. (12" x 13" x 3-1/4")

43411 Magazine Rack

B. Oak Accents™ Organizer

Organize papers, remote controls, mail, maps or anything you need to keep neat and at hand. Mounts easily on almost any surface. Solid oak-finish hardwood. (8-3/8" x 4-5/8" x 2-13/16")

43483 Organizer



B



C

C. Oak Accents™ Remote Holder

Have remote controls and other items near at hand with this easily installed, wall-mounted holder. Solid oak-finish hardwood complements any decor. (5" x 4" x 1-3/4")

43533 Remote Holder

D. Oak Accents™ Countertop Extension

Add an extra 12" to your counter top. Solid oak-finish hardwood extension mounts to your existing countertop with a metal piano hinge. Pulls up easily and is secured by a metal drop-leaf table brace. Folds down when not in use. Super-hard, non-toxic gloss finish. Mounting hardware included. (12" x 13-1/2" x 3/4")

43421 Countertop Extension



D



E

E. Oak Accents™ Sink Cover

Add more counter space with the sink cover that comes with a lifetime warranty. Super-hard, non-toxic gloss finish for extra moisture protection. Solid oak-finish hardwood. Board size is 13" x 15". Stabilized with adjustable rubber feet to fit sinks 10" x 14", 11" x 13-1/4" and 12" x 14".

43431 Sink Cover



A. Universal Silent Top™ Silence annoying stovetop rattles while adding valuable counter space to your RV. Solid oak-finish hardwood stovetop cover hides and protects burners. Non-toxic gloss finish for extra moisture protection. (19-5/8" x 17-1/2") Patented. Includes bonus Flexible Cutting Mat.

43521 Oak Accents™ Silent Top™



A



B. RV Hardwood Stove Topper/Cutting Board Hide burners, eliminate rattles, and add an attractive cutting board to your RV kitchen. Board doubles as a serving tray. Won't nick or dull knives. Non-skid backing holds board in place. Selected hardwoods are treated to preserve and enhance natural wood beauty. Built-in juice groove. Fits 3 or 4 burner stoves. Patented. (17" x 19-1/2" x 3/4") Includes bonus Flexible Cutting Mat.

43753 Hardwood Stove Topper

C. Bamboo Cutting Boards Handy bamboo cutting boards sized right for the RV kitchen. Three sizes and styles to meet your cooking needs.

- Finger-hole style (7-7/8" x 7-1/8" x 1/2")
- Handle style (7-7/8" x 11-13/16" x 1/2")
- Footed style with juice groove (11-13/16" x 10" x 13/16")

43542 Cutting Board with finger hole

43544 Cutting Board with handle

43546 Cutting Board with feet



B



NEW

C

C

NEW

NEW

C



A. Decor-Mate Stove Topper

Quiet stovetop rattle and add much-needed counter space in your RV kitchen. Sits directly on stovetop grates or over an existing stove cover. Stays firmly in place with non-skid backing. Durable polyethylene—cleans easily with soap and water. Patented. (17" x 19-1/2" x 1/2")

- 43704 Black
- 43707 white
- 43709 almond



B. Sink Mate Cutting Board

Increase kitchen work space with a sturdy polyethylene cutting board. Ideal for cleaning, carving and chopping. Fits right on RV sink; adjustable feet adapt to sink size. Won't nick or dull knives. With cut corner for scraps and built-in juice groove. Measures 12-1/2" x 14-1/2"; Fits sinks 10" x 14", 11" x 13-1/4" and 12" x 14". Patented.

- 43857 white
- 43859 almond



C. Stowaway Flexible Cutting Mat

Protect RV countertops from nicks, cuts and stains. Natural-colored mat eliminates spills by bending for easy pouring. Made of sturdy, lightweight recyclable plastic. Bend or roll for compact storage. Non-toxic and dishwasher safe. 11-1/2" x 15". Patented.

- 43770 Flexible Cutting Mat



D. Microwave Cooking Covers

Prevent spattering and reduce cooking time while venting steam automatically. Dishwasher safe. Set of two includes one 7" x 7" and one 9" x 9".

- 43790 2/pack

A. RV Universal Fit Stove Top Cover

Protect and hide burners and add counter space in your RV. Cover acts as a splash guard between burners and wall when folded back. Flip up one side to use two burners or fold and store it away compactly when you need all four burners. 20-gage steel with powder-coated finish.

43559 almond

43554 Black

43557 white



A

B. RV/Marine Splash Guard Protect your countertop from cooking spatter. Installs easily. High-impact clear plastic with clear anodized trim. Measures 20-1/4" along the counter, 11" up the wall.

44253 Splash Guard



C. Magic Chef® Grommets

Rubberized silicone grommets protect your stove top from scratches caused by the grate. Specially sized for Magic Chef brand grates.

43614 4/pack

D. Gas Stove Burner Liners Keep RV stovetop burners clean and hide pitted or rusted burner wells. Liners make clean-up easier. Fits Wedgewood, Magic Chef® and most other RV gas stoves. Easy installation. 7-1/2" diameter.

43800 4/pack



B

Limited Quantities



D



C

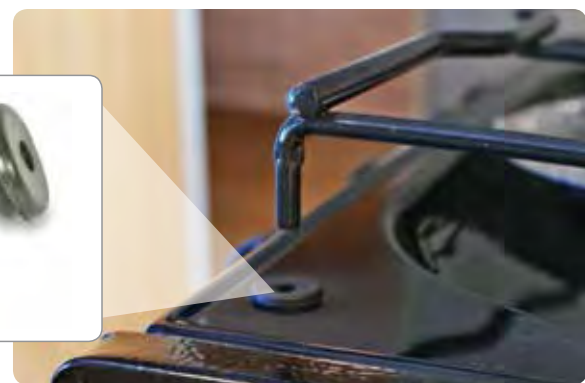



Make the most of limited storage and keep paper products clean and accessible. All products install easily in various locations and fit most standard packaging and product sizes.

A. Pop-A-Plate® Save space and store nine-inch paper or plastic plates under your cabinet or shelf. Mounts easily.

57001 white

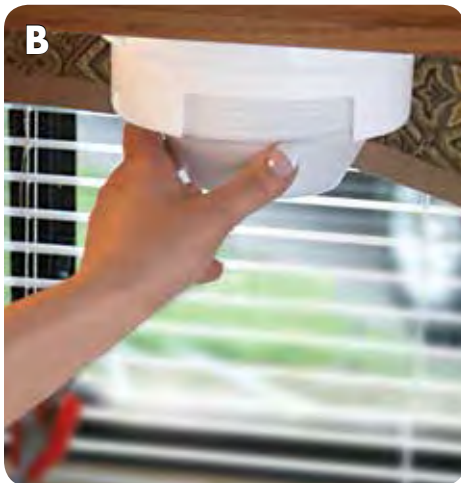

B. Pop-A-Bowl™ Save space by storing 6-inch disposable bowls or plates under your cabinet or shelf or next to the microwave. Mounts easily with screws (included).

57211 white



C. Pop-A-Napkin™ Keep napkins handy and clean. Napkin dispenser installs easily under cabinet or shelf. Easy to refill.

57041 white



D. Pop-A-Towel™ Keep paper towels clean and conveniently located. Holder can be permanently mounted on cabinet door, wall or under cabinet. Slides off the mounting bracket to stand alone or carry as needed.

57111 white



E. Pop-A-Wrap™ Keep plastic wrap, aluminum foil or wax paper close at hand with easily-installed holder. Mounts under cabinet or shelf with screws. Serrated edge makes tearing fast and easy.

57131 white

Limited Quantities

works with cone
or basket style filters



A. Pop-A-Filter™ Keep 6" basket or cone coffee filters at your fingertips. Works with disposable plates and bowls too. Installs easily under cabinet or shelf.

57081 white

B. Coffee Filter Dispenser Keep basket-style coffee filters at your fingertips. Just push the button and open to easily dispense one filter at a time. Installs easily under cabinet or shelf.

43653 Coffee Filter Dispenser

C. Pop-A-Bag™ Store grocery bags, trash bags and dryer sheets efficiently. Plastic bag holder/dispenser mounts easily on wall or inside cabinet with screws or double-sided tape. Holds up to 25 grocery bags.

57061 white

D. Pop-A-Tissue™ Keep facial tissues handy in wall- or cabinet-mounted dispenser. Installs easily with screws or double-sided tape. Can dispense upward or downward. Fits most boutique tissue brands.

57101 clear





A

Roughing it doesn't mean you have to do without. Camco's housewares products are designed and sized for RV kitchens, helping you make the most of valuable storage and work space.

A. Mini Dish Drainer Fits most RV sinks, and is sized just right for limited counter space. Sloped drainer tray keeps counters dry. Drain tray snaps on top of rack for handy storage. Durable heavy-duty construction.

43511 Dish Drainer



B. RV/Marine Mini Dishpan

Designed to fit most RV sinks. Durable translucent polypropylene with easy-lift handles. Holds nine quarts. Camco's Mini Dish Drainer fits perfectly inside for easy storage. Fits 10½" x 12¾"-inch and larger sinks.

43516 Mini Dishpan



B

C. RV & Marine Sink Mat Cushion and protect glassware and dishes. Small size vinyl mat is specifically engineered for RV & Marine sinks. Multiple drain holes allow water to flow freely through mat. Mildew resistant. 10" x 11-3/4".

43720 Sink Mat - white



C

D. RV Sink-Shower Strainers

Help prevent clogs with these stainless steel strainers. These strainers easily fit into your drain to keep food out of your plumbing. Bonus 3-pack for both sink and shower drains.

42273 Sink Strainers



D



Break-resistant Beverage Sets

No more broken glassware! BPA-free polypropylene glasses have the look and feel of real glass, and the advantage of being shatter-resistant. Available in wine, pilsner, juice, tumbler, martini and margarita styles. Sold in boxed pairs. Top shelf dishwasher safe.

A. Wine Glass 9 oz. Set of 2.

43861 - Wine

B. Pilsner Glass 22 oz. Set of 2.

43891 - Pilsner

C. Juice Glass 7 oz. Set of 2.

43881 - Juice

D. Tumbler 7 oz. Set of 2.

43871 - Tumbler

E. Martini Glass 10 oz. Set of 2.

43901 - Martini

F. Margarita Glass 12 oz. Set of 2.

43902 - Margarita





A. Refrigerator and Cupboard Bars Keep order in your RV refrigerator and cupboards during travel. Spring loaded bars keep items in place. Cupboard bars extend from 10" to 17"; Refrigerator bars extend from 16" to 28".

- 44073 double refrigerator bar - white
- 44053 refrigerator bars 3/pk - white
- 43823 refrigerator bars 3/pk - oak-look
- 43833 cupboard bars 3/pk - oak-look
- 44093 double cupboard bar - white
- 44063 cupboard bars 3/pk - white (not shown)

B. Slip-Stop® Keep everything safe and secure by preventing slipping and sliding. Washable, easily trimmed material works in tool boxes, rugs, van floors, shelves, dash boards or anywhere things slide around or rattle in your RV. Use as a liner between plates, cups and appliances.

- 43277 cream 1' x 12' roll
- 43278 slate blue 1' x 12' roll



C. Grease Bin Here's an easy way to dispose of cooking grease and fat, and save your drains from nasty clogs. Hot cooking grease can be poured directly into the foil-lined bag. Container keeps odors in so you can use the bag until it's full, and then just toss it out with the trash. Includes three foil liner bags. Five-pack of replacement bags also available. Patented.

- 42281 Grease Bin
- 42285 Replacement Bags - 5/pk



A. Stack-A-Plate™ with non-slip backing. Use in your cabinet to keep plates organized, and to stop them from sliding and rattling. Plates stay in place while traveling and are more protected from breakage. Set of two—one fits plates up to 7-1/4"; the other fits plates up to 10-1/4". Bright white. Dishwasher safe.

43601 Stack-A-Plate

B. Adjustable Cutlery Tray Sized to fit into RV and Marine drawers. Slides out from both sides for an easy custom fit. Adjusts from 9" to 13". Patented.

43503 Cutlery Tray

C. Knife Safe™ Frees up valuable drawer and counter space. Gives you convenient, safe access to your kitchen knives. Holds seven knives up to 2" wide.

43581 white

43583 beige

D. Cutlery Tray Economical cutlery tray fits easily into RV drawers to keep your flatware organized. Compact 7" x 11" size.

43508 Cutlery Tray

E. Adjustable Drink Holder Prevent spills with the adjustable drink holder. Mounts quickly and easily in RVs, cars, vans, trucks and boats. Arms easily adjust to hold almost any size bottle, can or mug. Mounts with tape or screws (included).

44044 Black

44043 brown





A. Fridge Door Stay Keeps your refrigerator door held open during storage. Improves air circulation and helps prevent mold and odor build-up.

45641 Door Stay



B. Fridge Airator™ Cool your RV fridge evenly and keep food fresher. High-volume air circulator absorbs odors with replaceable activated charcoal filter. Battery operated.

44123 Fridge Airator

42093 Replacement charcoal packs



C. Mini Ice Cube Trays Small trays fit perfectly into RV, marine or dorm freezers. Provides small size cubes for quick freezing. Set of two. (9" x 4" x 1")

44100 2/bag



D. Fridge Brace™ Keep food from sliding as you go down the road. Helps keep cartons upright to reduce the risk of messy spills. Two pack. Patented.

44033 Fridge Brace

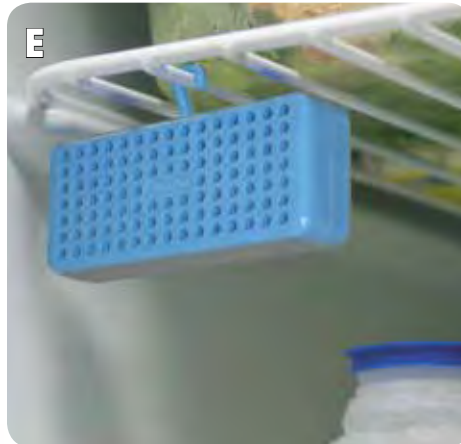

E. Fridge Odor Absorber This space-saving refrigerator freshener packs a lot of odor-absorbing power into a small space. Perfect for compact RV, marine and dorm refrigerators. Patented.

44184 Fridge Odor Absorber



F. Odor Absorber Naturally activated charcoal helps absorb odors caused by mold, mildew and other pollutants. Use for long term storage of boats, RVs and cabins. Works great in refrigerators, crawl spaces, closets, basements and other locations. Helps control pet odors, kitchen smells, musty odors, tobacco and much more. Each individually wrapped X-Odor Eliminator lasts up to four months. 3-pack.

44191 Odor Absorbers - 3/pack





A



A. RV Wall Clock Bracket mounts securely to the wall of RV. Clock slides into bracket and locks in place. It won't rattle or fall during travel, and slides easily off for battery change. Quartz movement; solid wood frame with brushed metal trim. Uses one AAA battery; not included. Patented.

43781 RV Wall Clock



Limited Quantities



B. Stainless Steel Trash Can

Stainless steel trash can includes an easy-to-remove insert and features a hands-free pedal operated lid that fits tightly to contain odors. Rectangle shape saves space in RVs and boats. Can be used free standing or wall mounted. 1 gallon size.

43931 Stainless Steel Trash Can

C. Wall-Mount Trash Can Compact trash can mounts to wall or inside cabinet. Features swing-top lid. Patented.

43961 Wall-Mount Trash Can



D. Mini Dehumidifier Compact moisture absorber reduces moisture which could lead to odors. Works to remove dampness from the air, helping to reduce mildew, mold and musty odors.

44195 Mini Dehumidifier

D





A. Pop-A-Toothbrush™ Protect and store toothbrushes with this easily-installed holder that guards against dust and germs. Cover opens automatically when toothbrush is pulled forward. Vented for quick drying. Double-sided tape allows for permanent mounting.

57203 white

B. Dust Pan and Whiskbroom

Small size makes it easy to keep this handy duo close at hand. Whiskbroom snaps into dustpan when not in use. Hanger-hole for convenient storage.

43945 Dust Pan and Whiskbroom

C. RV/Marine Broom and Dustpan

Full size (52" long) broom telescopes down to just 24" for compact storage. Soft-bristled head adjusts to different angles for maximum cleaning power. Handle length is adjustable, too! Handy dustpan clips onto broom handle for storage. Patented.

43623 Broom

D. Folding Ironing Board

Tabletop ironing board with pressed-board top and quality fabric cover is small and easy to use. Features sturdy chrome-wire iron rest. Measures 32" x 12" when set up. Legs fold under and board folds to 16" x 12" for easy storage.

43904 Ironing Board



A. RV/Marine Showerhead Enjoy longer showers with this ergonomically designed, handheld showerhead. Handy on/off switch allows you to pause water flow while shampooing, greatly reducing the amount of water used. No more rushing your shower to conserve water. Choice of four spray patterns from a drenching rain to a gentle massage; you can personalize your shower with your favorite comfort settings. Heavy-duty construction for years of use. Washers included.

- 43710 chrome
- 43711 white
- 43712 off-white
- 43763 Showerhead Gasket (10/pk)

B. RV/Marine Showerhead Kit

The same showerhead described in item A, packaged with a flexible 60" shower hose. Kit includes showerhead, flex hose, washers, wall mount and hardware. Shower Flex Hose features built-in connectors for easy installation to a standard 1/2" shower arm and reinforced construction to eliminate hose kinking. Heavy-duty construction for years of use.

- 43713 chrome
- 43714 white
- 43715 off-white

C. Showerhead Mounts

Adjustable chrome showerhead wall mount gives you great flexibility in positioning your showerhead. Two-position chrome showerhead wall mount gives you a choice of two angles for your showerhead. Hardware included.

- 43718 Two-position
- 43719 Adjustable

D. RV/Marine Shower Flex Hose

Flexible 60" replacement hose with built-in connectors for easy installation to a standard 1/2" shower arm. Reinforced construction eliminates hose kinking. Washers included.

- 43716 chrome
- 43717 white

E. Outdoor Showerhead

Easy-to-install showerhead fits in RV's outdoor shower area. This high flow showerhead has a convenient on-off switch to help conserve water.

- 44023 Outdoor Showerhead





Hardware

Featured products:



Vent Cover
page 70



Roof Vent Kit
page 72



Gutter Extensions
page 75







Camco Vent Cover Leave your vent open rain or shine. The Camco Vent Cover offers high-flow ventilation in an aerodynamic design. Removable louvers for easy cleaning. Mounts to existing 14" x 14" roof vents. UV stabilized resin for years of rugged use. Replacement Screen available in white only.

- 40431 Camco Vent Cover-white 10/ctn
- 40433 Camco Vent Cover-white 5/ctn

Available in colors (5/ctn)

- 40443 Camco Vent Cover-Black
- 40453 Camco Vent Cover-Smoke
- 40463 Camco Vent Cover-champagne
- 40473 Camco Vent Cover-Silver
- 40439 Replacement Screen-white



Replacement Screen



White

OPENS FOR CLEANING



Black



Smoke



Champagne



Silver

Aero-flo™ RV Roof Vent Cover Get high-flow fresh air ventilation and light into your RV, rain or shine. Streamlined cover has 30% more open vent area than other brands. Swing-open design makes cleaning easy. Made of rugged UV stabilized resin. Instructions and hardware included. Installs easily by mounting to existing 14" x 14" roof vent. Installed size is 22.5" l x 20" w x 9" h. Patented.

40421 white



*Works great
with high-powered fans*

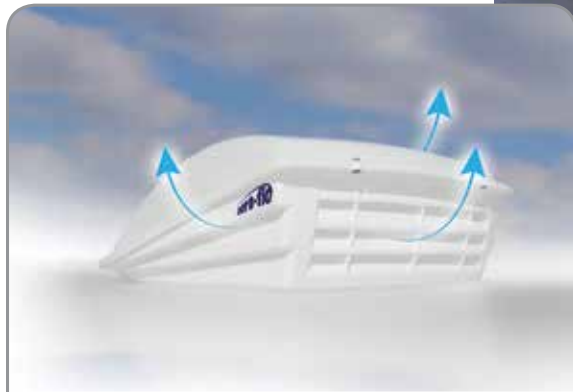

**30% More
Open Vent Area**



**Easy Access
for Cleaning**





A

NEW

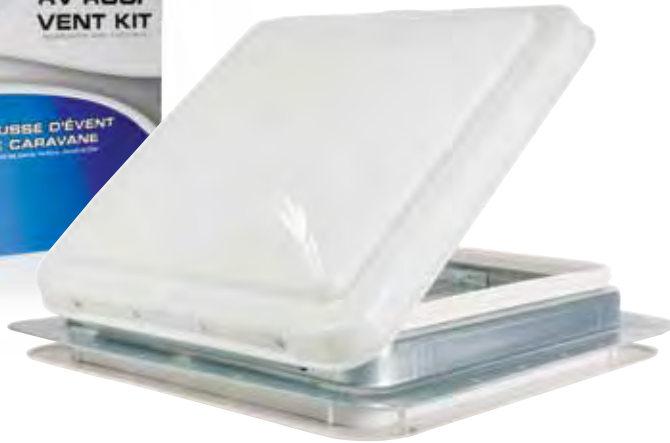

A. Roof Vent Kit One-piece seamless frame vent kit is leak resistant and weather tight. Built-in screen allows air through, keeps insects out. UV-resistant translucent lid.

40480 RV Roof Vent Kit

B. Polypropylene Replacement Vent Lids Impact-resistant vent lids come pre-assembled and include all mounting hardware for quick, easy installation on all 14" x 14" RV vents. Hardware is rust resistant. Replaces models as shown

white

40151 Ventline (starting with 2008)

40153 Jensen for metal vent metal vent (starting with 2004)

40154 Jensen - pin hinge (prior to 1994)

40155 Ventline (prior to 2008), Elixir (starting with 1994)

40156 Elixir (prior to 1994)

Smoke

40147 Jensen - pin hinge (prior to 1994)

40148 Ventline (prior to 2008), Elixir (starting with 1994)



Jensen for metal vent (starting with 2004)



Jensen - pin hinge (prior to 1994)



**Ventline (prior to 2008)
Elixir (starting with 1994)**



Elixir (prior to 1994)

C. Unbreakable Polycarbonate Vent Lids Unbreakable 14" x 14" vent lids are pre-assembled and include rust-resistant mounting hardware for quick, easy installation. Five-year warranty. Replaces models as shown.

40160 Jensen - pin hinge (prior to 1994)

40161 Ventline (prior to 2008), Elixir (starting with 1995)

40162 Elixir (prior to 1994)



Ventline (starting with 2008)

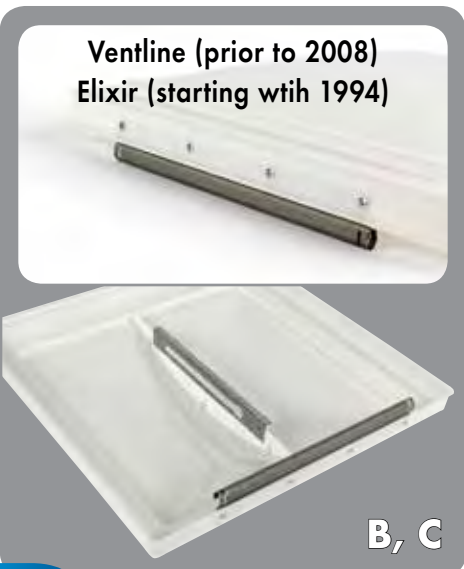

B, C



B, C

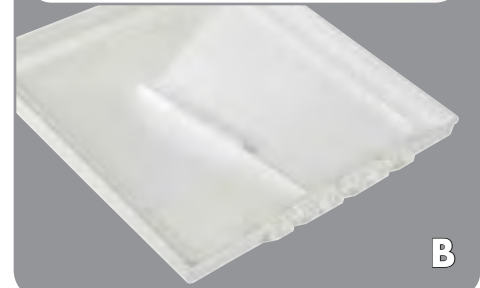

B

A. Lights Out™ Vent Shade Prevent light from shining into RV sleeping quarters. Easily mounts to ceiling and retracts into the space-efficient housing to allow light inside. Opens to 14-1/8" x 19". Durable, lightweight vinyl's reflective finish reflects heat to keep RV cool.

42913 Lights Out

B. RV Vent Insulator Fits snugly in vent opening to help stop heat transfer, keeping your RV cooler in summer and warmer in winter. Fits standard 14" vents. Removable synthetic fleece cover.

45192 Insulator w/reflective (not shown)

45195 Insulator

C. RV Vent Cover Increase your RV's AC and heating efficiency. Sunshield's reflective surfaces block 100% of the sun's damaging rays, helping to keep your RV cooler in summer and warmer in winter. Reflective thermal barrier mounts securely with hook-and-loop strips. 17.5" x 17.5"

45191 RV Vent Cover

D. Insulated Dual Vent Cover lets air in or blocks it off. It will disperse air in four directions, reducing draft. Catches condensation, rain and outside dust when the vent is left open. Reflective Sunshield surface blocks 100% of the sun's damaging rays. Dual clips and screws install into existing vent mounting holes. Fits 14" x 14" vents.

45651 Dual Vent Cover

E. Super Grommets Two-piece snap-together grommets work on tarps, plastic sheeting, tents and awnings to create an extra tie-down point without punching a hole in the fabric.

45461 Super Grommets - Set of 4

F. Locking T-Handle Replaces most garage door, camper and RV locking handles.

44393 Locking T-Handle



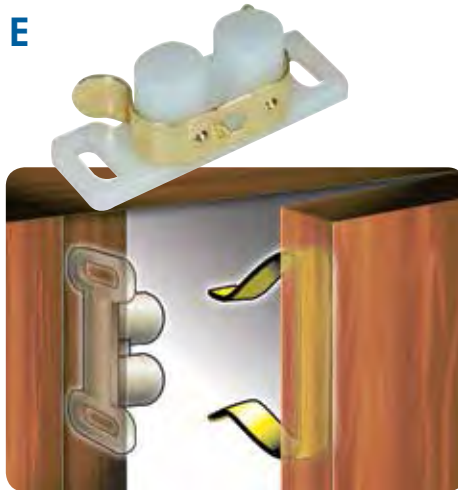

A. Pro-Tec™ Rubber Roof Patch Kit

The fast, easy way to mend your rubber roof. Just peel and seal for a permanent no-leak repair. A quick fix that will last for years! Also for metal and vinyl surfaces.

41461 Rubber Roof Patch Kit

B. Vinyl Trim Insert Replace cracked and stained trim inserts with easy-to-install inserts for aluminum roof edge, trim molding and truck camper shells. (Not for windows, entry doors, compartment doors or vents.) UV inhibitors for longer life.

- 25093** beige 1" x 25'
- 25103** white 1" x 25'
- 25113** black 1" x 25'
- 25123** colonial white 1" x 25'
- 25133** brown 1" x 25'
- 25143** colonial white 3/4" x 25'
- 25153** beige 3/4" x 25'
- 25163** white 3/4" x 25'
- 25173** black 3/4" x 25'
- 25192** beige 1" x 100'
- 25202** white 1" x 100'
- 25212** black 1" x 100'
- 25222** colonial white 1" x 100'
- 25232** brown 1" x 100'
- 25242** colonial white 3/4" x 100'
- 25252** beige 3/4" x 100'
- 25262** white 3/4" x 100'
- 25272** black 3/4" x 100'
- 25292** beige 1" x 1000'
- 25302** white 1" x 1000'
- 25312** black 1" x 1000'
- 25322** colonial white 1" x 1000'

C. Cam Locks Keep your storage compartments secure. Ideal for new or replacement installations on RVs. Easy-turn thumb operated or key-locking styles. Each contains one offset and one straight cam.

- 44323** 7/8" Thumb operated
- 44333** 5/8" Thumb operated
- 44340** 5/8" Baggage Lock
- 44353** 7/8" Baggage Lock
- 44363** 1-1/8" Baggage Lock
- 44368** 1-3/8" Baggage Lock
- 44303** 7/8" ACE Key Baggage Lock
- 44293** 5/8" ACE Key Baggage Lock

D. Baggage Door Catches Durable ABS plastic. Keep baggage compartments open while loading and unloding for easy access. Easily mounts directly on RV.

- 44163** colonial white 2/pack
- 44173** polar white 2/pack

E. Cabinet Catches Barrel-style replacement catches. Screws included.

- 44203** Side mount 6/pk

F. Coaxial Cable 75 ohm, 18 AWG center conductor cable for use with Satellite or cable TV and cable modems.

- 64760** 25 ft cable
- 64761** 50 ft cable



A. Camper Mounting Tape Self-Adhesive vinyl foam. 30 foot roll: Enough to install a large camper or canopy. Seals out dust, drafts and water; cushions to quiet rattles and vibrations. Length - 30 feet (9.14 m) × Width - 1-1/4 inch (3.17 cm) × Thickness - 3/16 inch (4.76 mm).

25084 Camper Mounting Tape

B. Slide-Out Corner Guards

A simple solution to the danger posed by sharp corners on your slide-outs. Place these soft, flexible guards on each exterior corner of your slide-out to provide a cushion zone. Constructed of advanced UV stabilized resin for long life. Installation is quick and easy—no tools required! Patented.

42193 white
42203 Black



C. Universal Vent Installation Kits

Replace or install roof vents, side mount vents, plumbing stacks and refrigerator vents. 3/4" x 8' kits include screws and instructions.

25003 Kit with gray putty tape for aluminum or other metal roofs
25013 Kit with white butyl tape for rubber roofs



D. Gutter Extensions Direct rain water runoff away from the sides of your RV to help prevent black streaks. Extensions clip onto your existing RV gutters. Patented.

42123 white 4/pk
42110 Black 4/pk

E. Gutter Spouts with Extensions

Replace shorter or worn OEM rain spouts, or can be used on RVs that do not have existing gutters on the drip rail. Help prevent black streaks by directing rain water runoff away from the sides of your RV. Patented.

42134 white 4/pk
42323 Black 4/pk





LP Gas

Featured products:



Propane Tank Covers
page 78



Gen-turi™
page 79



Propane Accessory Kits
page 80



Gen-turi
Gauges

Hoses
Regulators

Hose Kits
Tank Covers



77 LP Gas



Colonial White



Bronze



Champagne



Black

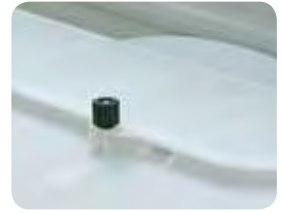

A. Heavy Duty Propane Tank Cover

Heavy duty polypropylene cover protects propane gas bottles from flying debris while streamlining the look of your rig. Slip the custom molded, assembled unit over bottles for a safe, secure fit and UV protection against sun damage. Updated design provides easier access to gas valves and changeover valves. Patented.

Fits 20 lb or 30 lb steel double tanks
(will not fit 30 lb aluminum tanks)

- 40532 colonial white
- 40542 polar white
- 40530 bronze
- 40531 champagne
- 40539 Black

Fits 20 lb steel double tanks

- 40523 polar white
- 40525 colonial white
- 40529 brown

Cap Replacement Kits for Tank Covers

- 40533 colonial white
- 40543 polar white
- 40548 bronze
- 40549 Black
- 40550 champagne

- 40534 Old-Style - colonial white
- 40544 Old-Style - polar white

Replacement Thumbscrews

- 40547 Thumbscrew Replacements - set of 2

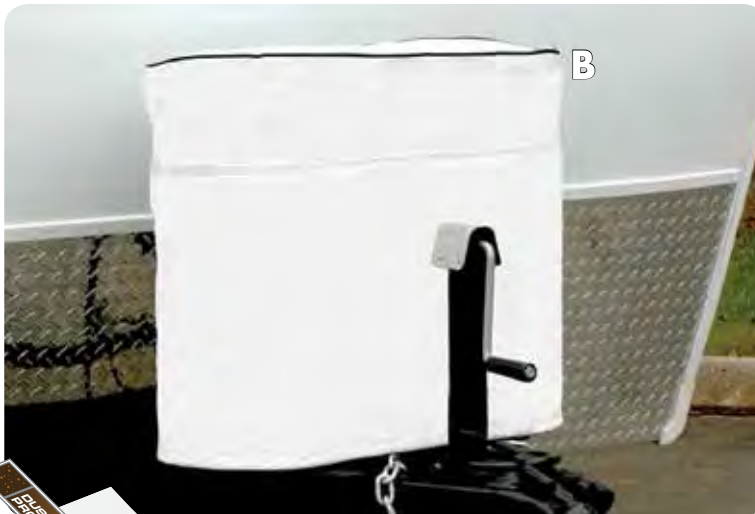

B. Vinyl Propane Tank Covers

help protect tanks from dirt, sun and rain. Keeps tanks fully weatherproof and easily accessible. Heavy duty zipper allows for easy access. Insert allows tank cover to hang evenly for a more finished look.

- 45301 20 Single Tank, arctic white
- 45302 20 Double Tank, arctic white
- 45303 30 Double Tank, arctic white
- 45304 40 Double Tank, arctic white
- 45312 20 Double Tank, colonial white
- 45313 30 Double Tank, colonial white
- 45314 40 Double Tank, colonial white

C. Cylinder Stabilizing Base

Help prevent accidental tipping of your propane cylinder, especially during transport. For use with 20- or 30-lb propane tanks. Impact resistant base easily attaches to tank to keep cylinder in place during storage or travel. Patented.

- 57236 Cylinder Base



Cylinder not included

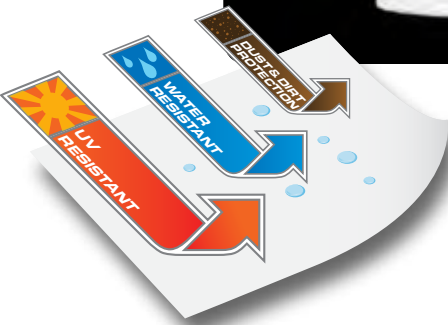

See page 50-51 for more vinyl cover products to protect your tires, air conditioners and more.



A. Gen-turi™ air-cooled venturi generator exhaust system Close quarters at rallies and tailgate parties create a need for noise and exhaust fume reduction. Gen-turi diverts nasty fumes away from the ground, so they won't be inhaled by neighboring RVers. Be a good neighbor. Weighing only nine pounds, Gen-turi installs easily and disconnects quickly. Includes storage bag. Patented.

44461 Gen-turi

B. Gen-turi replacement parts
(not shown)

- 44802 Gen-turi 30" emt straight
- 44812 Gen-turi 30" emt 90° bend
- 44822 Gen-turi 1-1/2" muffler clamp
- 44842 Gen-turi 1-5/8" coupler
- 44845 Gen-turi 1-3/4" coupler w/clamp
- 44848 Gen-turi 2" coupler w/clamp
- 44852 Gen-turi 1" split bushing
- 44862 Gen-turi 8" 30° emt
- 44872 Gen-turi 18" extension with coupler
- 44892 Gen-turi Aluminum Hooks w/tape-2 pk
- 44894 Gen-turi Bungee with S-Hooks

C. Gen-turi Transfer Kit If you need to move your Gen-turi™ from one motorhome to another, this kit contains all the hardware you'll need. (not shown)

44881 Gen-turi Transfer Kit



Sturdy Construction



Lightweight



Storage Bag Included



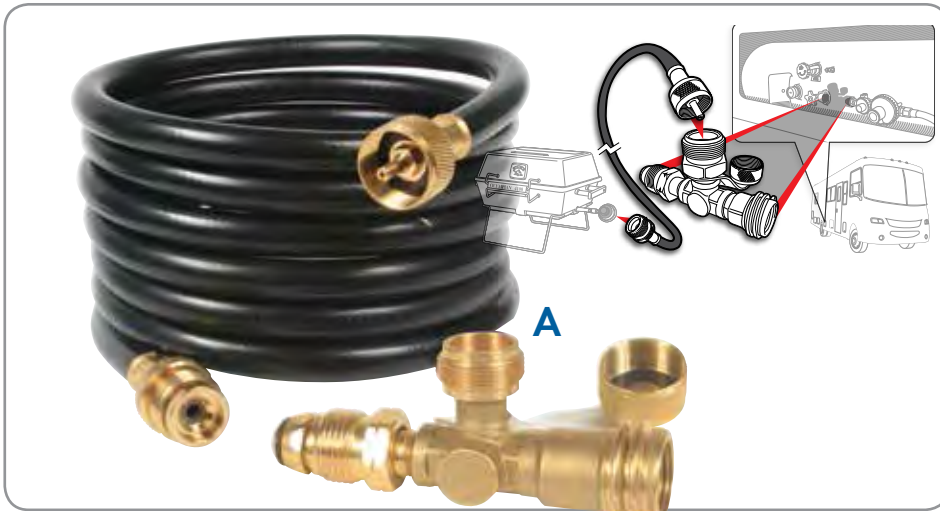

A

Find the Propane Connection Kit that best fits your needs.

A. Brass Tee with Three Ports and 12' Hose Mounts in-line between supply and regulator on a motorhome to allow connection of an additional propane appliance such as a tabletop grill, camp stove or lantern. Provides excess flow protection in case of broken gas line. Includes propane tee (Female P.O.L./Male Acme Thread x excess flow soft nose P.O.L. x 1"-20 male throwaway cylinder thread) and 12 ft extension hose with male x female swivel 1"-20 female throwaway cylinder threads.

- 59103 3-Port Tee and Hose
- 59093 3-Port Tee only

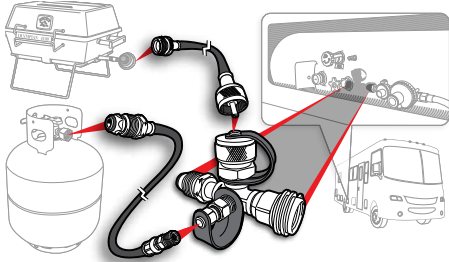

B



B. Brass Tee with Four Ports, 5' Hose and 12' Hose Mounts in-line between supply and regulator on a motorhome to allow hook-up of an auxiliary propane cylinder and the connection of an additional propane appliance such as a tabletop grill, camp stove or lantern. Provides excess flow protection in case of broken gas line. Includes propane tee (Female P.O.L./Male Acme Thread x excess flow soft nose P.O.L. x 1"-20 male throwaway cylinder thread x 1/4" inverted flare), 12 ft extension hose with male x female swivel 1"-20 female throwaway cylinder threads and 5 ft supply hose with excess flow soft nose P.O.L. x 1/4" inverted male flare connections.

- 59123 4-Port Tee and Hoses
- 59113 4-Port Tee only

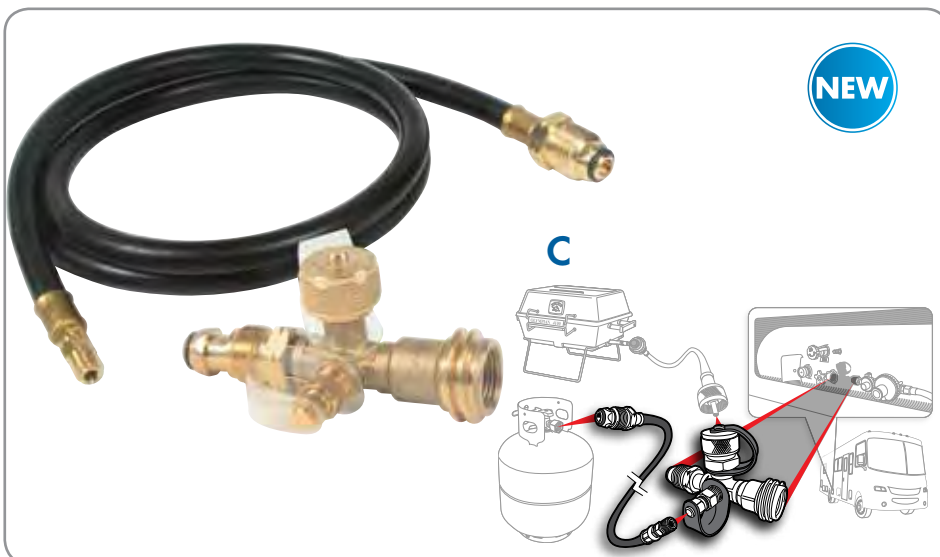

C

C. Brass Tee with Four Ports and 5' Hose Mounts in-line between supply and regulator on a motorhome to allow hook-up of an auxiliary propane cylinder. Provides excess flow protection in case of broken gas line. Includes propane tee (Female P.O.L./Male Acme Thread x excess flow soft nose P.O.L. x 1"-20 male throwaway cylinder thread x 1/4" inverted flare), and 5 ft supply hose with excess flow soft nose P.O.L. x 1/4" inverted male flare connections. (Allows connection of an additional propane appliance that requires a high-pressure source with the addition of a 59043 or 59045 propane extension hose - sold separately).

- 59125 4-Port Tee with 5' hose

A. 90° Propane Tee with 12' Hose

Connects to camper or trailer propane cylinder to allow connection of an additional propane appliance such as a tabletop grill, camp stove or lantern. Provides thermal protection in case of fire and excess flow protection in case of broken gas line. Includes propane tee (Type 1 Acme nut x female P.O.L. and male acme thread x 1"-20 male throwaway cylinder thread) and 12 ft extension hose with male x female swivel 1"-20 female throwaway cylinder threads.

- 59143 90° Tee and Hose
- 59133 90° Tee only

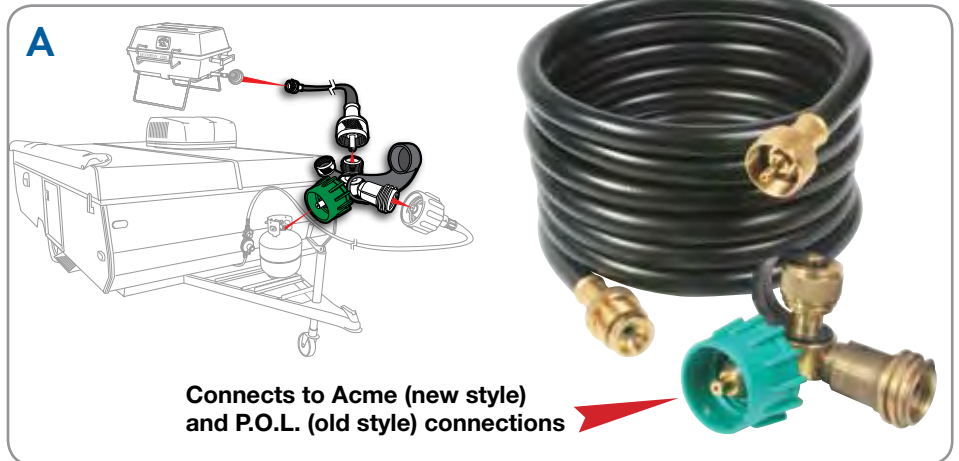

B. Propane Supply Hose

Replacement for hose in Propane Kits #59123 and #59125. Excess Flow Soft Nose P.O.L. x 1/4" Inverted Male Flare. Connects a propane cylinder to any device that has a 1/4" inverted female flare connection.

- 59033 5'
- 59035 12'

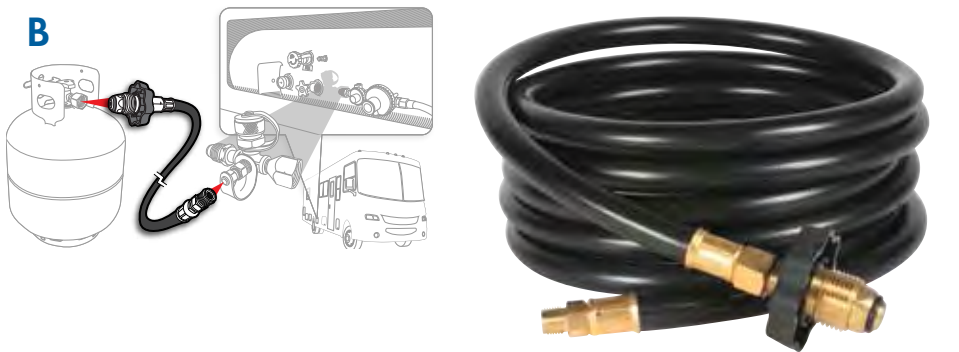

C. Propane Hose Assembly

For use with an existing gas supply to connect an appliance equipped with a 3/8" male flare. 3/8" female flare x 3/8" female flare.

- 59913 3'



D. Propane Extension Hose

Replacement for 12' hose in the following Propane Connection Kits: #59123 (4-Port Tee with 12' Hose and 5' Hose) #59103 (3-Port Tee with 12' Hose) #59143 (90° 4-Port Tee with 12' Hose) M x F swivel 1"-20 female throwaway cylinder threads.

- 59045 5'
- 59043 12'

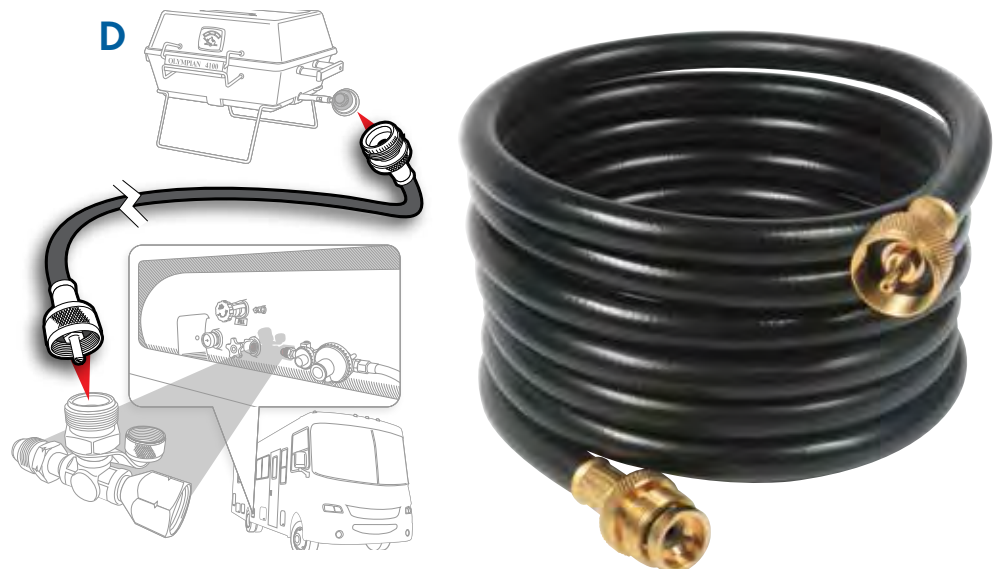

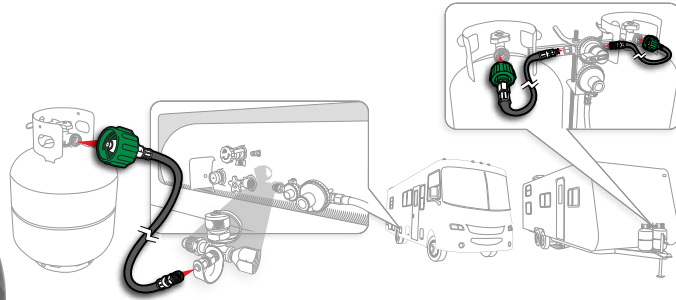

A. Pigtail Propane Hose Connectors with Male Inverted Flare For connecting propane cylinder to RV or trailer propane regulator. Rated for 200,000 BTUs per hour. Provides thermal protection in case of fire and excess flow protection in case of broken gas line. Type 1 ACME nut x 1/4" inverted male flare.

- 59053 12" Pigtail Connector
- 59065 15" Pigtail Connector
- 59073 20" Pigtail Connector
- 59153 24" Pigtail Connector
- 59163 30" Pigtail Connector
- 59173 36" Pigtail Connector
- 59183 48" Pigtail Connector
- 59193 60" Pigtail Connector

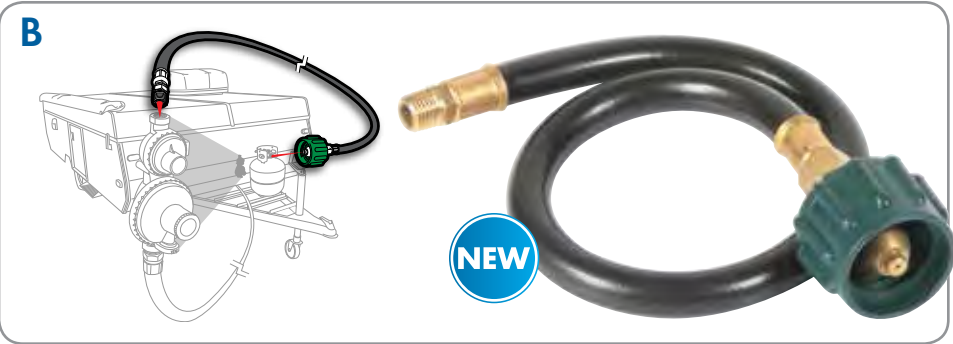

B. Pigtail Propane Hose Connector with Male NPT For connecting a 20- or 30-lb refillable propane tank to the regulator on a camper. Provides thermal protection in case of fire and excess flow protection in case of broken gas line. Type 1 ACME nut x 1/4" Male NPT.

- 59843 20" Pigtail Connector



C. Propane Hose Assembly High-pressure hose with easy-grip Acme nut for connecting an appliance designed to use a 1 lb disposable cylinder to a 20- or 30-lb refillable propane tank. Provides thermal protection in case of fire and excess flow protection in case of broken gas line.

- 59823 5'
- 59825 12'



D. Propane Appliance Extension Hose For use on a 20- or 30-lb refillable propane tank to provide an extension for portable propane appliances. 1/4" Male NPT x 1/4" Female NPSM.

- 59883 5'

A. Automatic Changeover Two-Stage Regulator For RVs with dual propane tank hookup. Regulator maintains constant gas pressure and automatically changes from empty tank to full one. Allows removal of empty cylinder for refill without interrupting propane supply. Inlet: 1/4" SAE inverted flare. Outlet: 3/8". NPT female. BTU rating: service cylinder: 210,000 BTU/hr; reserve cylinder: 130,000 BTU/hr.

59005 Automatic Changeover Regulator

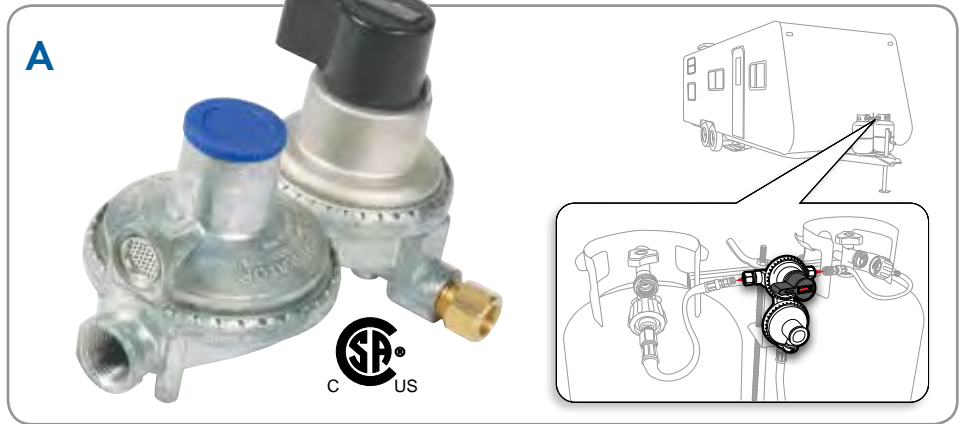

B. Single Stage Propane Regulator For connecting a free-standing gas bottle to a grill or other low-pressure gas appliance. Maintains a constant 11" w.c. propane pressure. 200,000 BTU/HR.

59013 Single Stage Regulator

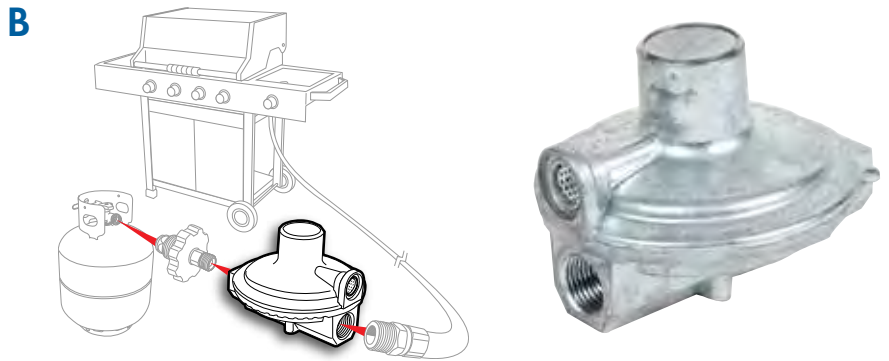

C. Two Stage Propane Regulator Integral first and second stages ensure a smoother, more consistent flow of gas to all appliances. CSA Listed. Inlet: 1/4" NPT. Outlet: 3/8" NPT. Outlet pressure: 11" WC. BTU Capacity (propane): 160,000 BTU/HR.

59313 Vertical

59323 Horizontal

59333 Horizontal with P.O.L.

59344 Covers for Two Stage Regulators (set of 2)

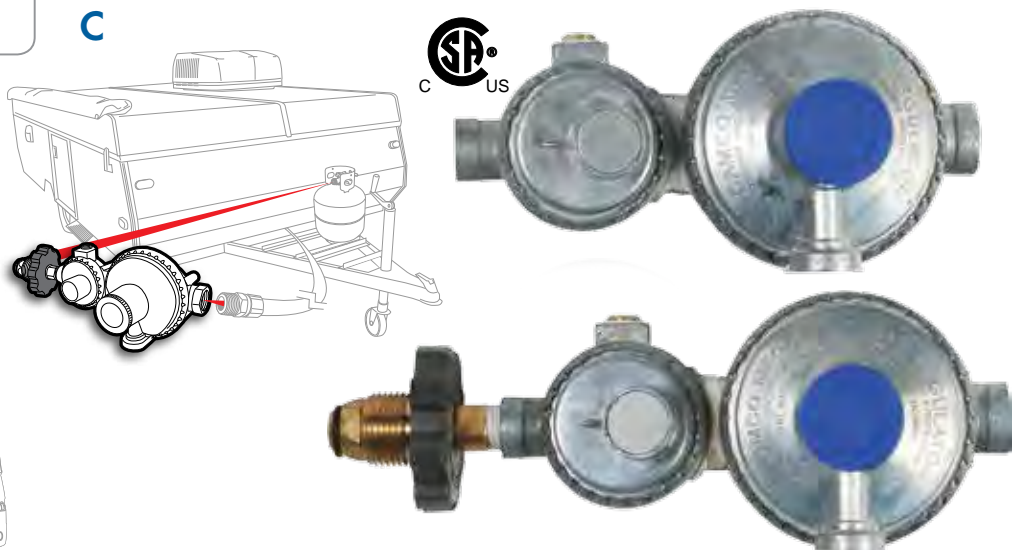
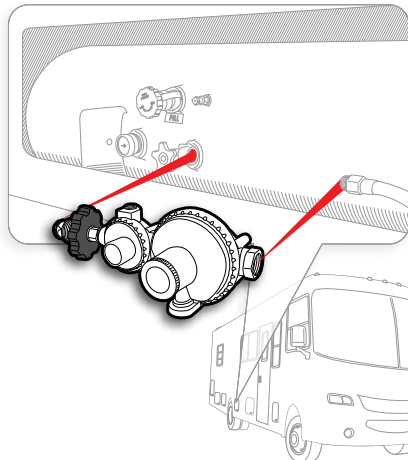
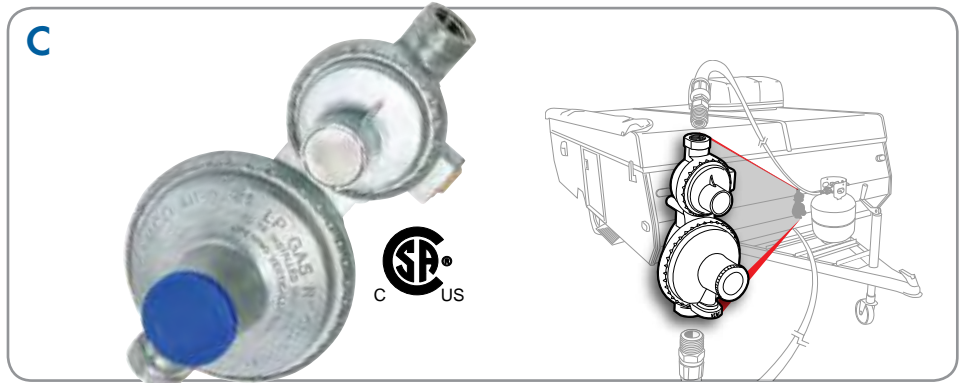

A

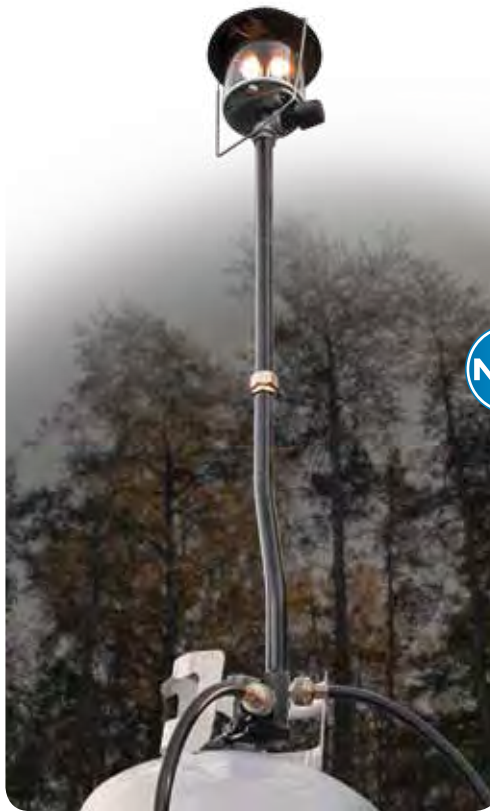

NEW



A. Propane Distribution Post with Storage Bag Use up to three propane appliances simultaneously—with just one tank! Lantern, Portable Campfire, Grill, Camp Stove/Griddle, Heater and more. Includes: One 15-inch Propane Distribution Post: Excess Flow, Soft-Nose P.O.L. Propane Tank Connection and THREE—1"-20 Male Throwing Cylinder—Appliance connections and one 15-inch Propane Distribution Post Extension: 1"-20 Male/Female Throwing Cylinder Threads. All outlets feature auto-shutoff.

51095 Propane Distribution Post

B

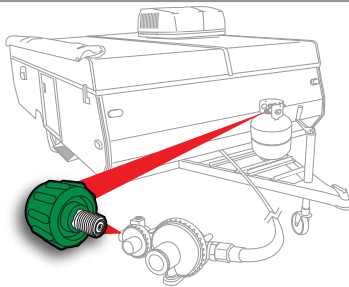

B. Green Propane Acme Nut

200,000 BTU/hour. For use on a 20- or 30-lb refillable propane tank to connect to a regulator/hose assembly. Provides thermal protection in case of fire and excess flow protection in case of broken gas line. Acme nut x 1/4" NPT.

59923 200,000 BTU Acme Nut

C

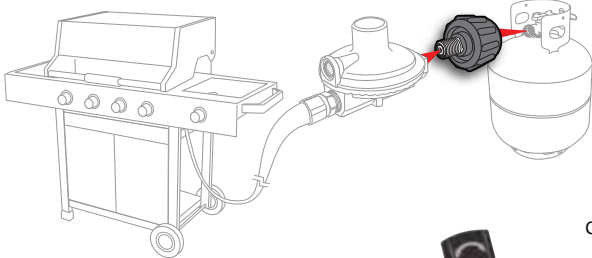

C. Black Propane Grill Acme Nut

70,000 BTU/hour. For use on a 20- or 30-lb refillable propane tank to connect to a regulator/hose assembly. Provides thermal protection in case of fire and excess flow protection in case of broken gas line. Acme nut x 1/4" NPT.

59933 70,000 BTU Acme Nut

D

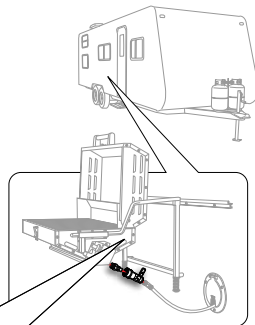
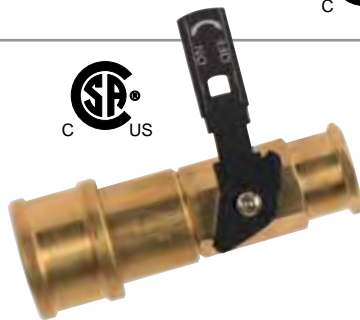

E

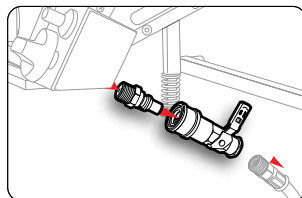

D. Propane Quick-Connect Kit

For use in low-pressure propane systems to add a convenient connect/disconnect method or to add an additional safety shut-off. Valve: 1/4" Female NPT x Female Quick Connect; Full Flow Plug: 1/4" Male NPT x Male Quick-Connect.

59853 Quick-Connect Kit

E. Quick-Connect Full-Flow Plug

For use in low-pressure propane systems to add a convenient connect/disconnect method. 1/4" Male NPT x Male Quick-Connect.

59903 Full-Flow Quick-Connect Plug

A. Propane Y Adapter with Handwheel For use on a 20- or 30-lb refillable propane tank. Allows you to operate two appliances such as a Campfire and a grill at once from the same cylinder. Provides excess flow protection in case of broken gas line. Male Soft-Nose P.O.L. x Two 1"-20 Male Throwing Cylinder Thread Connections.

59893 Propane Y Adapter

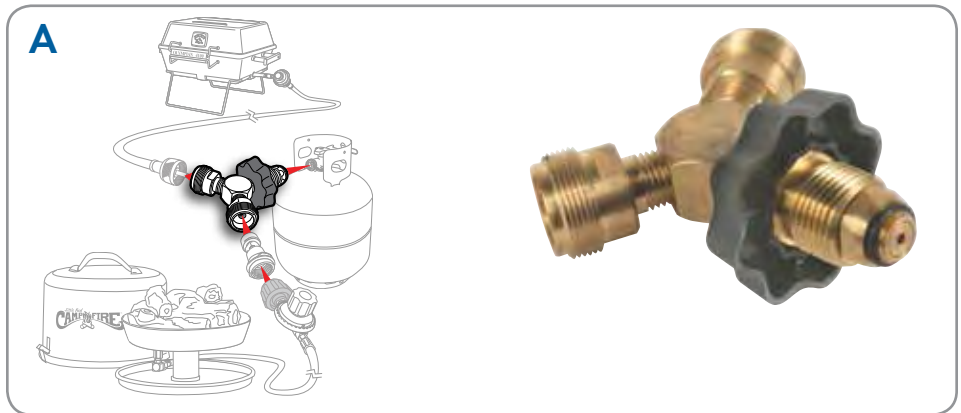

B. Propane Cylinder Adapter For use with any appliance designed to use a 1-lb throwaway cylinder. With this handy adapter, you can power your small LP appliance directly from a 20- or 30-lb refillable tank. Provides excess flow protection in case of broken gas line. Soft Nose P.O.L. x 1"-20 Male Throwing Cylinder Thread.

59943 Propane Cylinder Adapter

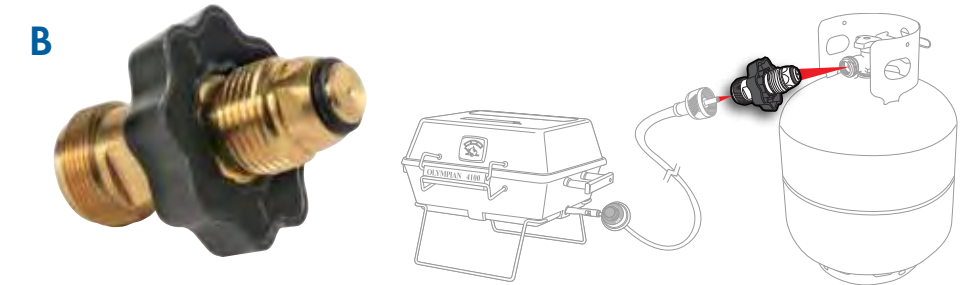

C. P.O.L. Plug Adapter For use on a 20- or 30-lb refillable tank to connect cylinder to regulator. Converts 1/4" NPT to female P.O.L. Provides excess flow protection in case of broken gas line. Soft Nose P.O.L. x 1/4" Male NPT.

59203 P.O.L. Plug Adapter

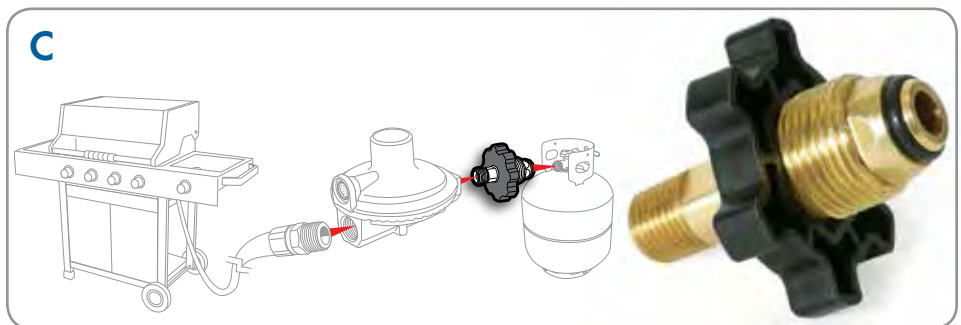

D. Gas Gauge/Leak Detector See at a glance when your propane level is low. Type 1 for gas grills, RVs and boats. Fits all propane tanks manufactured after 1995. Provides thermal protection in case of fire and excess flow protection in case of broken gas line. Acme Nut x Acme Thread and Female P.O.L.

59023 Gas Leak Detector

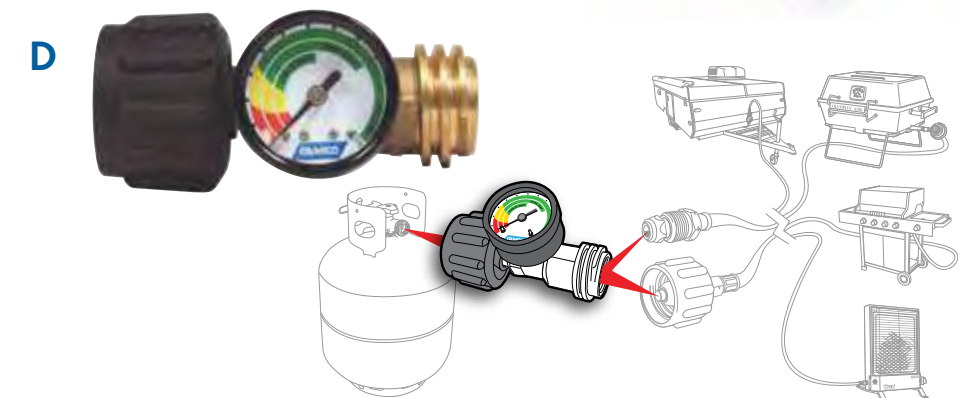

E. Propane Fitting For use on some regulators to allow connection of a propane pigtail with 1/4" inverted flare connection to a regulator that has female 1/4" NPT port(s). 1/4" Male NPT x 1/4" Female Inverted Flare.

59953 NPT 1/4" Fitting

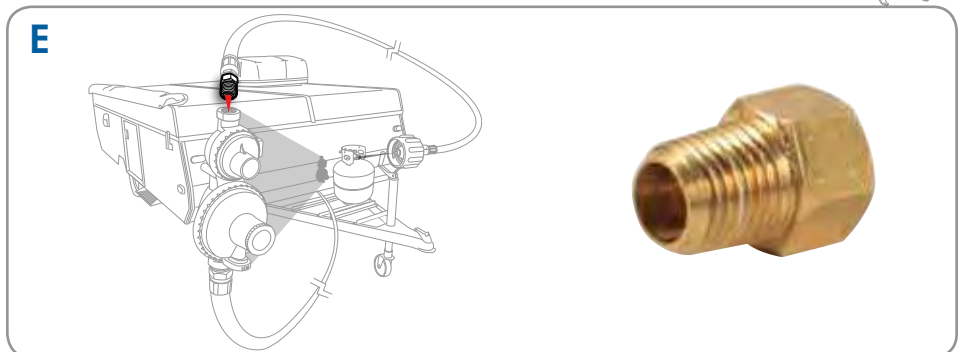



Appliances

Featured products:



Wave™ Heaters
page 88



Refrigerator Vent System
page 91



**RV Water Heater
Drain Plug Kit**
page 92



Olympian™ Heaters

RV Water Heater
Repair Parts

Insect Screens

AC Gaskets
and Wall Thermostats

Refrigerator Vent Covers





A1



A2



A3

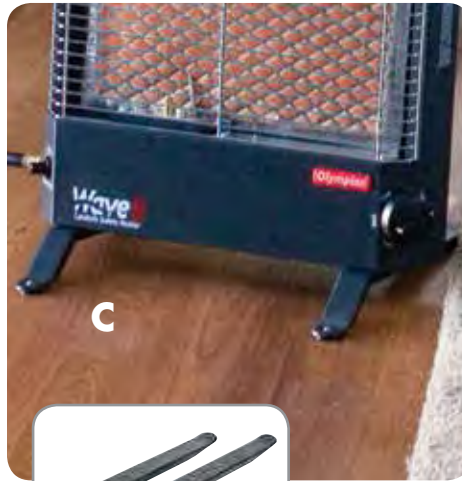

C



D

B



Flame-type heaters waste up to 45% of all heat produced. Catalytic heating is over 96% efficient, resulting in a more efficient and low-cost heat.

Refer to the chart below to choose the correct size heater for your RV

A. Olympian™ Wave™ Catalytic Safety Heaters An ideal primary or secondary heating source. Wave™ heaters operate on low pressure LP gas, and can be wall mounted or used as portables. Equipped with an integral safety shut-off valve to help prevent accidental non-ignition fuel discharge. The built-in Piezo electric spark starter will last for 20,000 starts. No electrical drain or battery connection. Leg stands not included.

- A1 57331 Olympian™ Wave 3
Adjustable from 1600 to 3000 BTUs
- A2 57341 Olympian™ Wave 6
Adjustable from 3200 to 6000 BTUs
- A3 57351 Olympian™ Wave 8
Adjustable from 4200 to 8000 BTUs

B. Custom Fitted Dust Covers

- 57706 Wave 3/3100 Dust Cover
- 57713 Wave 6/6100 Dust Cover
- 57715 Wave 8/8100 Dust Cover
- 57722 Wave 3 Dust Cover (portable)
- 57723 Wave 6 Dust Cover (portable)
- 57724 Wave 8 Dust Cover (portable)

C. Leg Stands for Wave Heaters

- 57701 Black, set of 2

D. 90° Connector Elbow

- 3/8" swivel flare female x 3/8" flare male.
- 57633 Elbow with full 360° swivel

E. LP Gas Regulator with hose For use with all Olympian LP gas fired heaters.

- 57703 Regulator with 6' hose
- 57704 Regulator with 8' hose
- 57721 Regulator with 12' hose
- 59863 Regulator with 22" hose

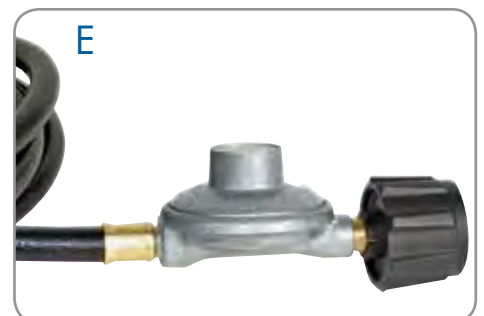

E

	BTU Output	Room Area Heated	Size of RV
Wave 3 Catalytic Safety Heater	1600 to 3000	130 sq. ft.	12 ft.
Wave 6 Catalytic Safety Heater	3200 to 6000	230 sq. ft.	18 ft.
Wave 8 Catalytic Safety Heater	4200 to 8000	290 sq. ft.	23 ft.

The Olympian™ Catalytic Heating Element

features a low-density spongy texture which allows for perfect transport of the oxygen needed for combustion. The catalytic heating element is evenly impregnated with platinum, guaranteeing optimal oxidation of gas and elimination of the mix of dangerous gas emissions.

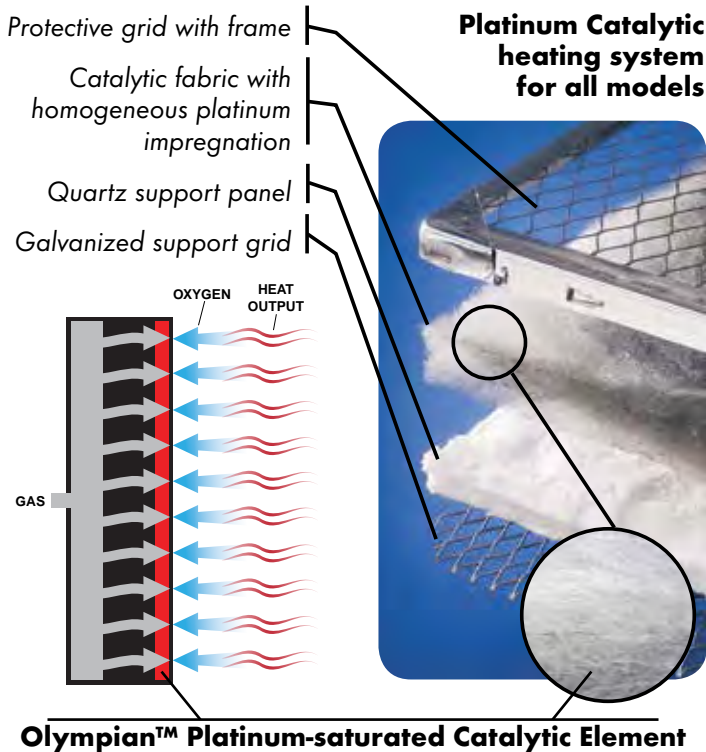

Other brands use higher density supports which obstruct proper oxygen transport. Platinum distribution in their supports is not homogenous. Part of the gas can be released without burning, resulting in serious health hazards.

Other brand's catalytic heating system

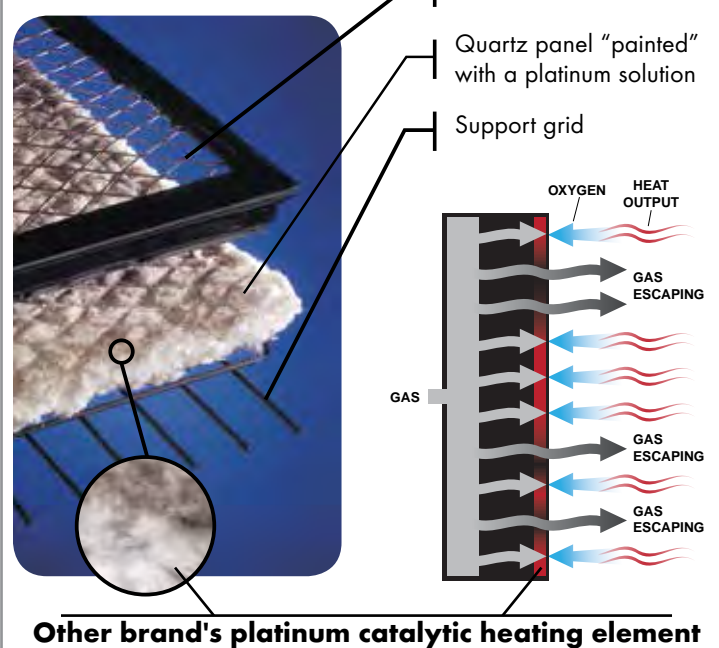

CHOOSE THE WAVE HEATER THAT'S RIGHT FOR YOU

	WAVE 3	WAVE 6	WAVE 8
Low pressure LP gas	•	•	•
BTU Output	1600 to 3000	3200 to 6000	4200 to 8000
Fuel Consumption at maximum output	1/8 lb/hr.	1/4 lb/hr.	1/3 lb/hr.
Gas Connection	3/8" SAE Flare	3/8" SAE Flare	3/8" SAE Flare
Height	11-3/4"	17-7/8"	21-1/4"
Width	10-1/4"	12-13/16"	15"
Depth	3-1/2"	4"	4"
Weight	6 lbs.	12 lbs.	14 lbs.
Typical RV Size *	up to 12'	up to 18'	up to 23'
Room Area Heated ¹ *	130 sq. ft.	230 sq. ft.	290 sq. ft.
Ignition	Piezo Spark	Piezo Spark	Piezo Spark
Vertical Wall Hung	•	•	•
Horizontal Wall Hung	•	•	•
Vertical Recessed	•	•	•
Horizontal Recessed	•	•	•
Portable Leg Stands	•	•	•
Warranty	3 year	3 year	3 year

*The heated areas depends greatly on insulation R-Factor and outside temperature. All "heated area" specifications were based on outside temperature of 35°F and R-Factor of 17.



Flying Insect Screens Wasps, mud daubers, birds and rodents pose a serious threat to your RV water heater, furnace and stove. They can enter through vents and openings and cause serious damage by building nests that interfere with air flow. Protect your valuable investment by purchasing and installing Camco's Flying Insect Screens. These easy-to-install screens will help ensure that your vents stay free from costly invasion by unwanted pests. All except C, I, J and M-O include installation tool.

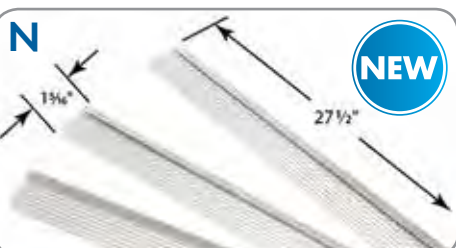
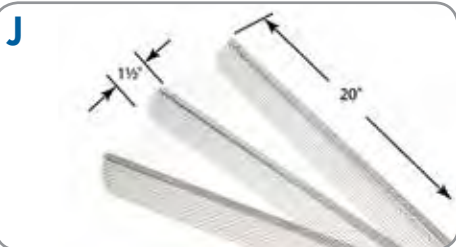
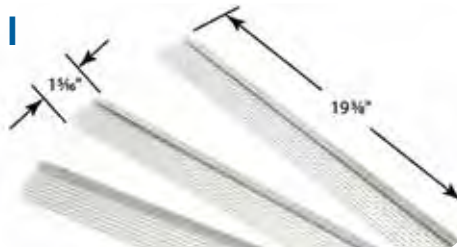
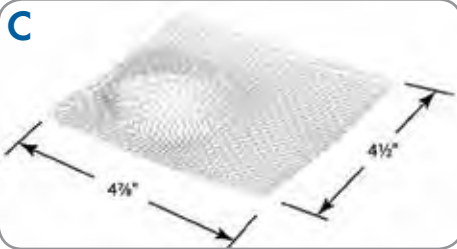

- A. 42140** FUR100 for Furnace Vents Sol-Aire, Coleman, Hydroflame, Suburban
- B. 42141** FUR200 for Furnace Vents Duo-Therm and Suburban
- C. 42142** FUR300 for Furnace Vents Hydroflame series
- D. 42143** FUR400 for Furnace Vents Suburban DD Series
- E. 42144** FUR500 for Furnace Vents Atwood / Hydroflame with no access door
- F. 42145** WH500 for Water Heater Vents Atwood 6 and 10 gallon, Suburban 6 gallon
- G. 42146** WH600 for Water Heater Vents Suburban 10 to 16 gallon
- H. 42147** ST500 for Louver-type RV stove vents
- I. 42148** RS500 for RV Refrigerator Vents with 19-3/4" Louver openings - except Dometic
- J. 42149** RS600 for Dometic RV Refrigerator Vents with 20" Louver openings
- K. 42150** WH200 for Water Heater Vents Suburban furnace vents; models 8535, 8531, 8525, 8940 DC, and 8940 AC, Suburban louvered water heater vents as well as most battery vents.
- L. 42151** WH400 for Water Heater Vents Suburban 6 Gal Flush Mount
- M. 42152** PL100 for 4-prong type Plumbing Vents
- N. 42153** RS700 for Norcold Refrigerator with 27.5" louver openings, 3 pk
- O. 42154** RS800 for Dometic Refrigerator with 8.13" louver openings, 6 pk

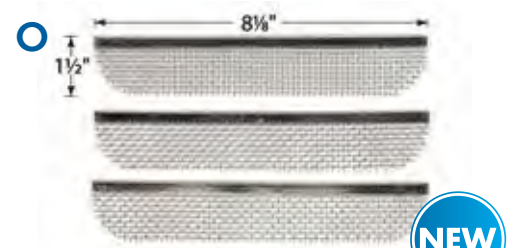



A. RV Refrigerator Vent Cover

Use the power of the sun to ventilate your refrigerator. Fits Dometic, Camco and newer Norcold bases. Refrigerator Vent Cover is available with fan and built-in solar panel. Made from UV stabilized, durable polypropylene plastic. Cap mounts to base with included hardware. Patented.

- 42160 Vent Only (no solar panel)
- 42161 Refrigerator Vent Base
- 42162 Solar panel and fan
- 42165 Vent System w/ solar panel & fan
Vent Base not included



B. Universal Roof Air Conditioner Gasket Kit

Install a roof AC with confidence with this 14" x 14" kit, the best available. Includes a self-adhesive picture frame gasket and two self-adhesive foam leveling pads (7/8" x 1-7/16" x 18" and 5/16" x 1-7/16" x 18") for a universal fit.

- 25071 AC Gasket Kit

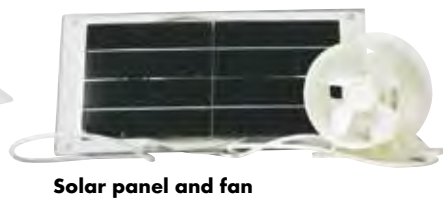

C. Wall Thermostats

- 09221 Heat and Cool wall thermostat
single-stage only; not designed for
multi-speed air conditioners
- 09231 Heat Only thermostat



D. RV Water Heater Hybrid Heat™

Easily converts any RV LP gas water heater to 120V electricity on demand, helping to conserve propane. Stainless steel heating cartridge heats the water to temperatures ranging from 90° to 150° F. Includes power switch with mounting bracket and adjustable thermostat. Factory preset to 120° F. All necessary power cords and color-coded wire assemblies are included. 15 A/120 V electrical service required for use.

- 11673 6 gallon with 425 Watt Element
- 11773 10 gallon with 725 Watt Element
- 11674 6 gallon Replacement Element
- 11774 10 gallon Replacement Element



SWITCH FROM PROPANE TO 120 V ELECTRIC ANY TIME WITH THE RV WATER HEATER HYBRID HEAT™.



A

B

C

D

E

F

G

H

NEW

A. Water Heater Replacement Elements

Replace the heating element in your RV water heater with a UL recognized HWD replacement kit.

Detailed instructions included.

- 02103 Screw-in element 1000W-120V
- 02143 Screw-in element 1500W-120V
- 04363 Universal element 1500W-120V

B. Screw-in Element Wrench

Remove and replace screw-in elements with ease. Zinc-plated element wrench goes where other wrenches can't. Works with your screwdriver and fits all standard screw-in type elements and 1-1/2" nuts.

- 09883 Element Wrench

C. Professional Element Socket

Fits standard 1/2" socket drive to make easy work of replacing screw-in water heater elements. Chrome-plated.

- 09951 Element Socket - Bulk
- 09953 Element Socket - Clamshell

D. Water Heater Tank Rinsers

Helps extend the life of your water heater. Water Heater Tank Rinsers lift sediment that collects at the bottom of your water heater and washes it out of your water heater tank.

- 11691 Water Heater Tank Rinsers

E. Water Heater Continuity Tester

Test your water heater elements and circuits with ease.

- 10023 Tester

F. Cam Locks

Replace broken door latches quickly and easily. Camlocks replace water heater door latch assemblies or gas bottle cover access door latches.

- 09203 Plastic Cam Locks - 2/card
- 09213 Steel Cam Locks - 2/card

G. Water Heater Thermostat

Replacement Therm-O-Disc style single element thermostat with High Limit Control.

- 08143 TOD single element thermostat

H. RV Water Heater Drain Plug Kit

Specifically designed for use with RV water heater drain plugs. Angled design conveniently fits in tight spaces and includes prongs for rusted drain valves. Fits both 7/8" and 15/16" drain plugs. Includes two replacement 1/2-14 NTP drain plugs and Teflon® tape.

- 11633 Water Heater Drain Plug Kit
- 11630 Water Heater Drain Plugs, set of 2
- 11632 Water Heater Drain Plug, 50/box



A. Temperature and Pressure Relief Valves Protect your RV water heater from excessive temperature and water pressure with corrosion-resistant metal T & P valves. Factory set at 150 PSI and 210° F. Crafted with no gaskets, and epoxy-coated probes to prevent corrosion buildup.

- 10423 1/2" valve with 4" probe 4/ctn
- 10421 1/2" valve with 4" probe - Bulk
- 10463 3/4" valve with 1" probe 12/ctn
- 10473 3/4" valve with 4" probe 12/ctn
- 10471 3/4" valve with 4" probe - Bulk

B. Universal T & P Valve Remover Replace T & P valves faster and more safely. Valve Remover gives you better access to the water heater housing, reducing injuries. Fits Atwood and Suburban (Mor-Flo) water heaters.

- 10552 T & P Valve Remover

C. Water Heater Drain Valve Wrench Open or close stubborn water heater drain valves without scraping your knuckles. Heavy duty, high-impact plastic wrench has an adjustable handle that lets you get at hard-to-reach valves with leverage to loosen stubborn valves. Open handle allows hot water to flow to front of heater, preventing pooling.

- 11653 Drain Valve Wrench

D. Anode Rods Anode rods extend the life of a water heater by attracting corrosive elements in the water, protecting your tank and elements from corrosion.

- 11553 Magnesium - for Atwood
1/2" NTP .50" dia. 4-1/2" long/Patented
- 11552 Magnesium - for Atwood - Bulk
- 11593 Magnesium - for 10-gal Atwood
1/2" NTP .60" dia. 9.5" long/Patented
- 11563 Aluminum - for Suburban (Mor-Flo)
3/4" NTP .75" dia. 9-1/2" long
- 11562 For Suburban (Mor-Flo) - bulk

E. Water Heater Drain Valves Replace water heater valves with sturdy, easily-installed durable brass replacements.

- 11663 1/4" drain valve
- 11683 3/8" drain valve
- 11703 1/2" drain valve

F. RV Water Heater Anode Rod with Drain Patented magnesium anode rod for aluminum water heaters (Atwood style) preserves the life of your water heater by corroding itself so your water heater tank doesn't. Replace your 1/2" pipe thread drain plug with the Camco RV Water Heater Anode Rod to extend the life of your RV's water heater. Internal drain valve allows you to drain your water heater without tools.

- 11533 Anode Rod with drain, 1/2 NTP

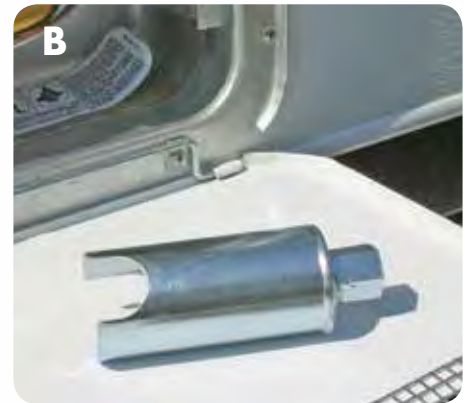

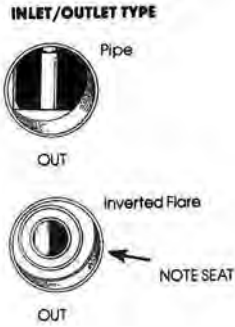
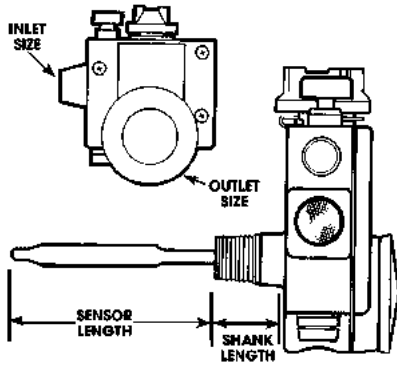

RV Gas Controls				
Part#	Style	Inlet	Outlet	Shank
08601	RV-50A	3/8" Inverted Flare	3/8" Female NPT	1-5/8"
08621	RV-50C	1/2" Female NPT	3/8" Female NPT	1-1/4"
08631	RV-50D	3/8" Inverted Flare	3/8" Inverted Flare	1-1/4"
08641	RV-50G	3/8" Inverted Flare	3/8" Inverted Flare	1-3/8"
08651	RV-50J	3/8" Female NPT	3/8" Female NPT	1-1/2"

A1



A2

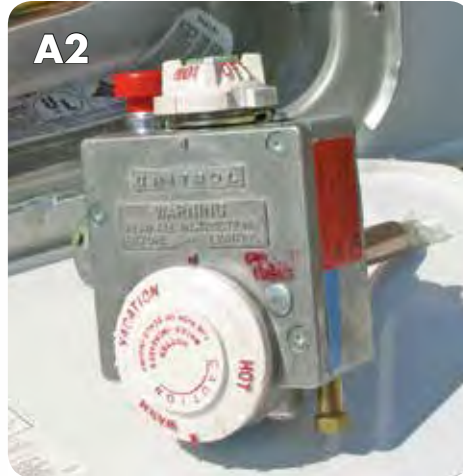

A3



A4



A5



B

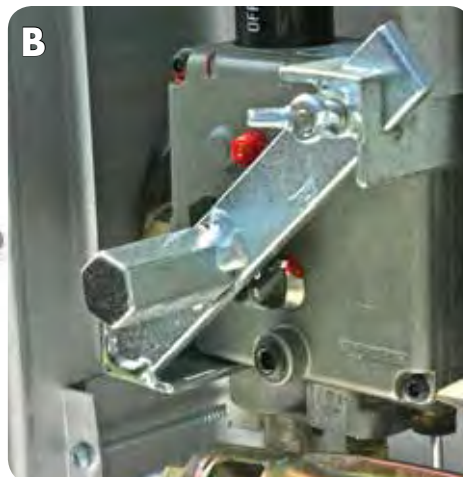

A. Gas Control Replacements

Camco's gas controls are designed specifically for use on recreational vehicles. Custom made for use with LP gas to an 11" water column. All are adjustable from 120° to 160°F.

- A1 **08601** RV-50A (3/8" inv. flare x 3/8" Female NPT)
- A2 **08621** RV-50C (1/2" x 3/8" Female NPT)
- A3 **08631** RV-50D (3/8" inv. flare x 3/8" inv. flare)
- A4 **08641** RV-50G (3/8" inv. flare x 3/8" inv. flare)
- A5 **08651** RV-50J (3/8" x 3/8" Female NPT)

B. Gas Control Wrench Install gas controls with a durable, universal gas control wrench. Has a case-hardened adjustable screw for durability.

09963 Gas Control Wrench

C. RV Gas Pilot Assemblies Direct factory replacements with complete step-by-step instructions.

- C1 **08763** 9" Mor-Flo/Suburban
- C2 **08773** 9" Atwood
- C3 **08783** 11-1/2" Atwood

C1 C2 C3



A. Gas Pressure Test Kit Test your gas system for leaks and system pressure, at an appliance or at the gas controls. Easy-to-read gauge comes mounted in a durable case with a 30" hose and a brass pressure tap fitting.

- 10389 Test kit
- 10399 Replacement nipple for kit
- 10409 Replacement hose for kit

B. Thermocouples Replace your thermocouple with confidence. Universal thermocouple kits with positioning adapters fit RV gas water heaters and furnaces.

- 09253 12" universal kit
- 09273 18" universal kit
- 09293 24" universal kit
- 09313 30" universal kit
- 09333 36" universal kit
- 09353 48" universal kit

C. Gas Burner Tube Cleaner

Keep gas RV water heaters, stoves and grill burner tubes working properly. Clean away spider webs and corrosive weather deposits to keep appliances running more efficiently and help prolong equipment life.

- 09103 Burner Tube Cleaner

D. Gas Leak Detector Help protect your RV from gas leaks. Gas Leak Detector bubbles at the problem area when gas is escaping.

- 10324 with sprayer 8 oz bottle
- 10325 with dauber 8 oz bottle
- 10367 gallon bottle (not shown)
- 10368 55 gallon drum (not shown)

E. Boiler Antifreeze -100° A premium heat transfer fluid with special corrosion inhibitors. For use in traditional boilers and closed boiler and solar systems. Can be used with Aqua-Hot and Hydra-Hot systems.

- 30027 gallon
- 30029 5 gallons
- 30028 55 gallons
- 35116 Concentrate, 32 oz

Boiler Antifreeze AL (not shown)

Same great features as our regular Boiler Antifreeze, with an advanced formula that's safe for aluminum containing systems.

- 33116 3.5 gallons
- 33119 5 gallons
- 33118 55 gallons

F. Antifreeze pH Test Strips Test the pH of your antifreeze solution to indicate the level of corrosion protection.

- 36011 pH Test Strips

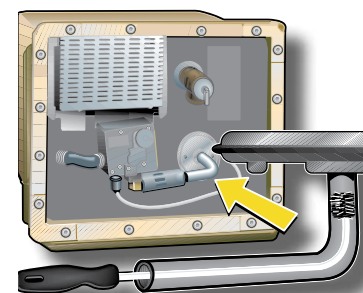



Winterizing

Featured products:

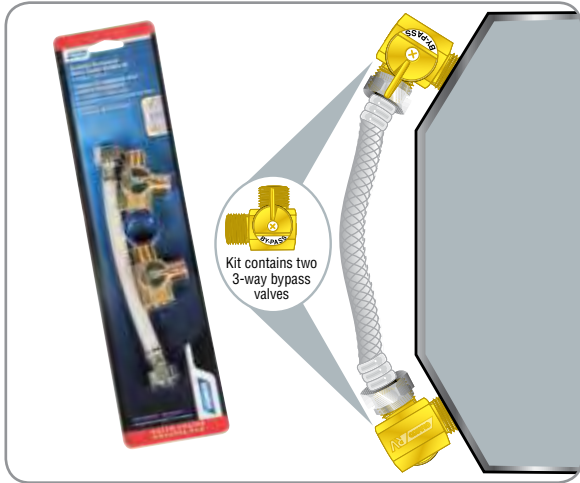

By-Pass Kits
page 98



RV & Marine Antifreeze
page 99



Hand Pump Kit
page 100



Windshield Washer Fluids
Winterizing Accessories

By-Pass Kits
RV Fresh Water Antifreeze



Winterizing

97

Camco offers a complete line of by-pass kits for a lifetime of durable performance. By-pass kits save antifreeze by allowing your water heater to be bypassed when winterizing.

A



B



C



A. Supreme Permanent By-Pass Kit

Simple, permanent installation of this kit reduces the amount of antifreeze required to winterize by bypassing your RV water heater. Save gallons of antifreeze by not filling your water heater with antifreeze when you winterize. Brass valves provide non-restrictive flow. Comes with kink-resistant nylon reinforced hose.

35953 With 8" hose for 6 gallon tank

35963 With 12" hose for 10 gallon tank

37463 3-Way by-pass valve replacement

B. Seasonal By-Pass Kit

This temporary by-pass kit allows you to hook up in the fall for winterizing and remove in the spring for reconnecting the system. Comes with kink-resistant nylon reinforced hose.

35713 Seasonal By-Pass Kit

C. Quick-Turn Permanent By-Pass Kit

Save on antifreeze when you winterize with this easily-installed water heater by-pass kit. Sturdy, brass backflow preventer and 100% shut-off valve lets you bypass the water heater with a single turn. Patented.

35983 Quick-Turn Kit

D. Boiler Antifreeze AL (not shown)

Advanced formula is safe for aluminum containing systems. A premium heat transfer fluid with special corrosion inhibitors for multi-metal corrosion protection. For use in traditional boilers and closed boiler and solar systems. Can be used with Aqua-Hot and Hydra-Hot systems.

33119 Boiler Antifreeze AL - 5 Gallon

33118 Boiler Antifreeze AL - 55 Gallon

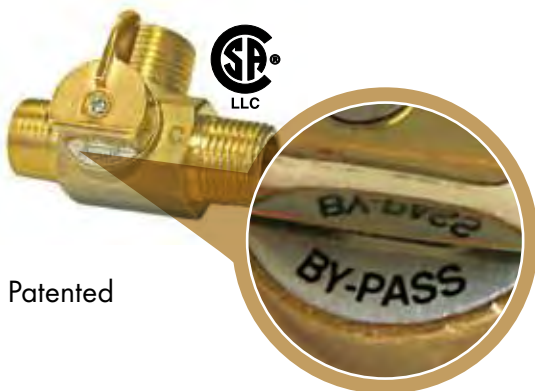

Patented

A

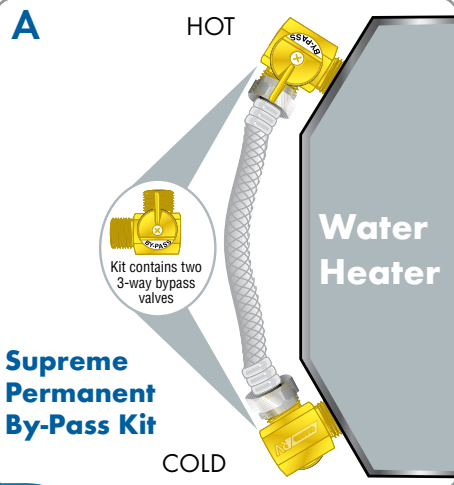

B

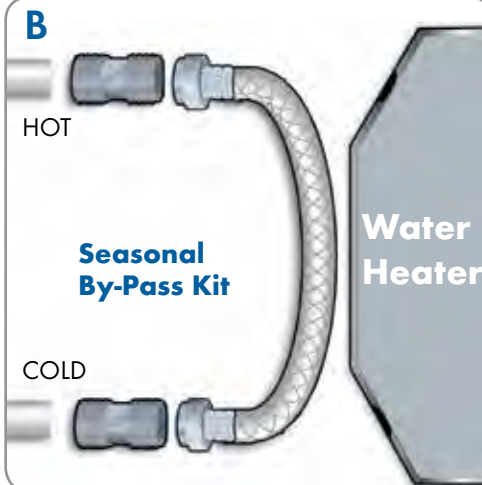

C

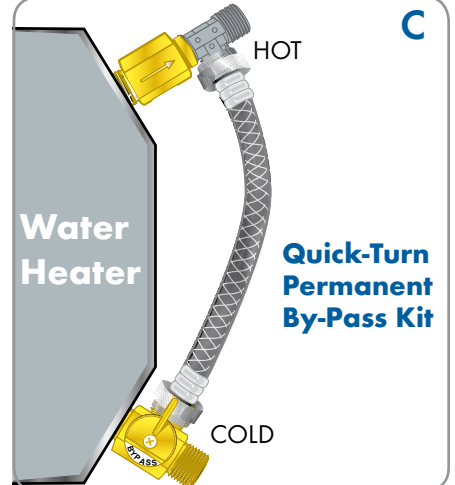

A. Ice Cutter™ Spray Thick formula stays where you spray for a more accurate and controlled application. Spray directly on windshield or other areas with frost and ice buildup for rapid melting power. Also helps protect against refreezing.

30522 32 oz Spray

B. Boiler Antifreeze -100° Premium heat transfer fluid with special corrosion inhibitors. For use in traditional boilers and closed boiler and solar systems. Can be used with Aqua-Hot and Hydra-Hot systems.

30027 1 Gallon
 30029 5 Gallon
 30028 55 Gallon
 35116 Concentrate 32 oz

C. Antifreeze pH Test Strips Test the pH of your Boiler Antifreeze solution to indicate the level of corrosion protection.

36011 Bottle of 50 strips

D. RV & Marine Antifreeze Protect your RV's potable water system from freeze damage. Camco antifreezes inhibit fouling and corrosion while helping to lubricate pumps and valves throughout the system. Choose a temperature-specific product designed for your winterizing needs. Safe and tasteless.

30626 Premium Ban Frost 2000® 32 oz
 30767 Freeze Ban -50 1 Gallon
 30769 Freeze Ban -50 5 Gallon
 30768 Freeze Ban -50 55 Gallon
 30787 Winter Ban -100 1 Gallon
 30788 Winter Ban -100 55 Gallon
 30647 Winter Ban -50 1 Gallon

E. BanFrost 2000® Marine Engine Antifreeze Low toxicity biodegradable engine protection. Use for winter storage of raw water cooled engines and as a permanent antifreeze/coolant for fresh water cooled systems. Replaces ethylene glycol: safer for people, pets and wildlife. All season/all purpose propylene glycol formula with CAM-3 inhibitor package offers superior corrosion protection.

30627 1 Gallon
 30629 5 Gallon
 30628 55 Gallon



A



A. Hand Pump Kit with Hose

Pump antifreeze directly into your RV waterlines and supply tanks. Kit includes flexible connecting line with city water connection.

36003 Hand Pump Kit

B



B. Pump Converter Winterizing Kit

Winterize your RV annually with ease. This permanent kit installs with an adjustable wrench and comes complete with brass valve, siphon hose, Teflon tape and pump adapters. Patented.

36543 Pump Converter



C. Blow-out Plugs

Completely clear your water lines with RV blow-out plugs. Screw the plug into the city water inlet, open all drains and faucets, attach and activate air pump until all lines are clear. Patented.

36103 Plastic 6/ctn

36104 Plastic 50/ctn

36153 Brass

36143 Quick-Connect Style

D. Freeze Check Refractometer

An economical, highly accurate instrument for testing the point at which antifreeze solutions begin to solidify. No charts, graphs or conversions. Eliminates guesswork, reassuring the user that the system is protected to the desired level. Saves money by eliminating over-use of antifreeze and verifying proper protection. Recommended for use with winterization methods where propylene glycol based antifreezes are used.

65401 Refractometer

C



D

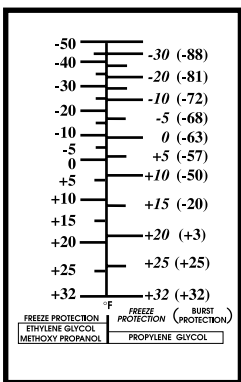

WINTERIZING YOUR RV WATER SYSTEM

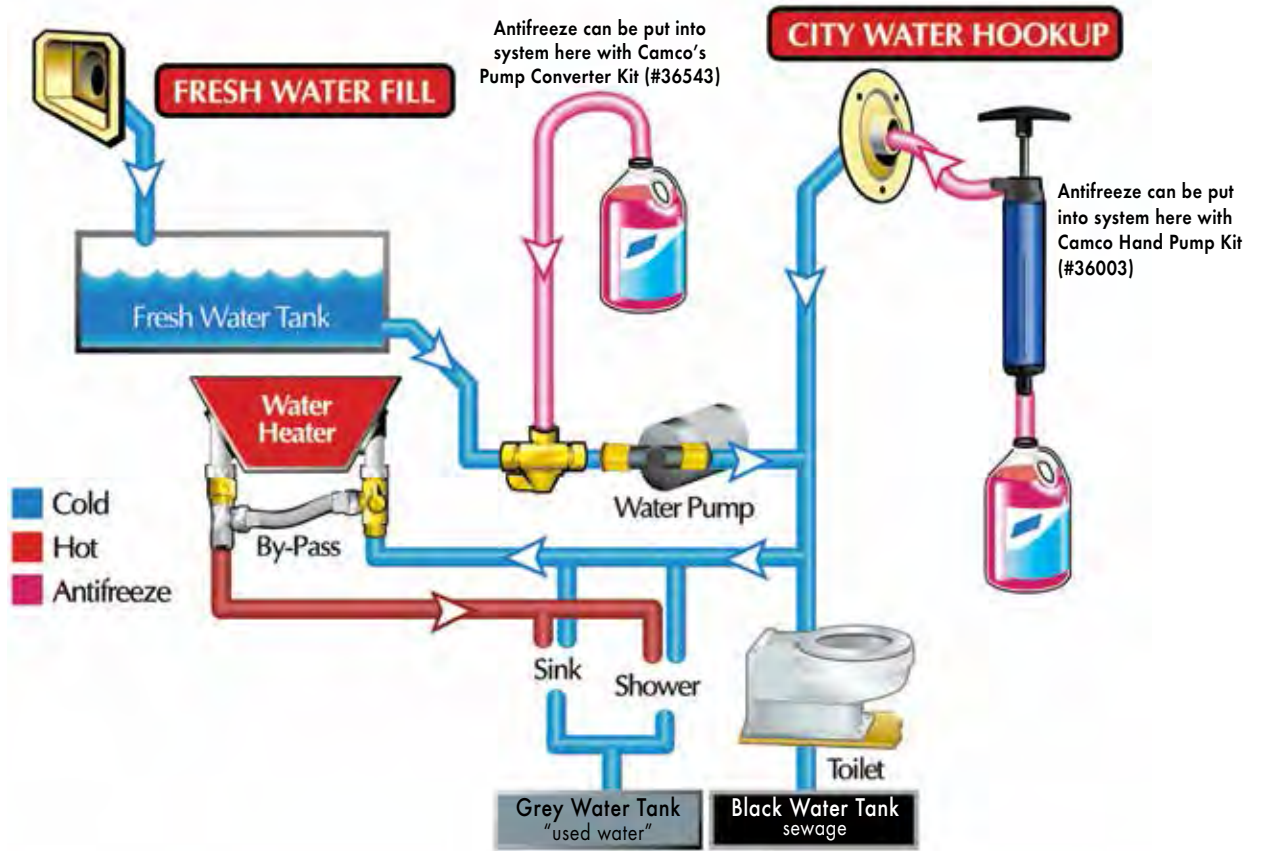

A. DIY Boat Winterizer Quickly and efficiently service inboard/outboard marine engines. The Do-It-Yourself Winterizer allows flushing and preparation of boat engine for winter storage with just five gallons of antifreeze and your flusher. Save time and money season after season. Great for technicians, too. For front mounted raw water pump systems use the Flush Adapter, sold separately.

65501 DIY Winterizer

65493 Flush Adapter for Engine Mounted Raw Water Pump





Fresh Water

Featured products:



EVO™ Premium Water Filter
page 104



**Premium
Drinking Water Hose**
page 106



**Brass Water Pressure
Regulator**
page 108

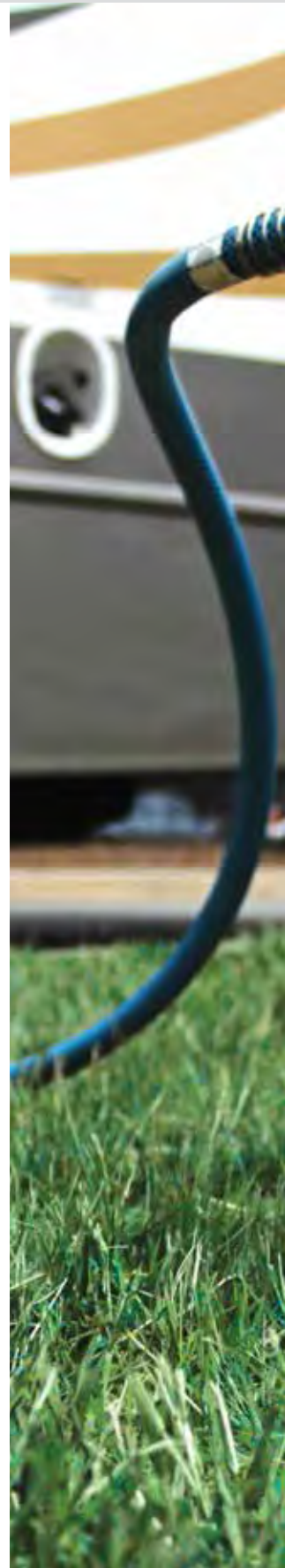

Filtration
Water Treatment

Fresh Water Hoses
Accessories



Fresh Water

103



A



B

Filter Stand sold separately

A. Evo™ Premium Water Filter with replaceable cartridge

Reduces bad taste, odors, sediments, bacteria, chlorine and much more. Includes filter housing, one extension hose and one replaceable premium spun polypropylene filter cartridge. Filtration begins with water traveling through a porous shell with openings no greater than 5 microns in diameter. Filtered water then passes through a bed of KDF® and GAC (Granulated Activated Carbon) for further filtration and bacteria control. The result is fresh, clean, great tasting drinking water straight from your tap. For exterior use.

- 40631 Evo™ Premium Water Filter
- 40621 Evo™ Spun PP Cartridge
- 40635 Evo™ Mounting Bracket

B. Water Filter Stand Hold your water filter upright and off the ground. Foot bar makes it easier to secure the stand in the ground. Lightweight. Zinc coated to inhibit rust.

- 40772 Water Filter Stand



C



C. Evo™ Premium Water Filter VOC Replacement Cartridge

Designed as a replacement cartridge for Camco's Evo Water Filter housing. Filtration begins with water traveling through a porous shell with openings no greater than 5 microns in diameter. Filtered water then passes through a bed of KDF® and GAC (Granulated Activated Carbon) for further filtration and bacteria control. *Contains premium carbon with a high microporosity level for absorbing harmful VOCs (Volatile Organic Compounds).* The result is fresh, clean, safe, great tasting drinking water straight from your tap.

- 40624 Evo™ VOC Water Filter Cartridge



D



D. TastePURE™ RV & Marine Water Filter

Improve the taste and smell of your drinking water for up to 120 days. Filters down to 150 microns.

- 40645 Water Filter



E



E. TastePURE™ KDF®/Carbon Water Filter

Larger capacity filter lasts an entire season. Greatly reduces bad taste, odor, chlorine and sediment in drinking water with a 100 micron filter. Durable in-line, exterior mount filter has a wider body to increase flow. Includes flexible hose protector to minimize kinking that impedes water flow.

- 40043 Filter with hose protector
- 40045 Two-pack (filters only)



TastePURE™ Water Filter Guide



	RV/MARINE Carbon Water Filter #40645	RV/MARINE KDF®/Carbon Water Filter #40043/40045	EVO™ RV/MARINE KDF®/Carbon Water Filter #40631/40621	EVO™ VOC RV/MARINE KDF®/Carbon Replacement Filter #40624
	<ul style="list-style-type: none"> • 150 micron barrier • Full-size, short-term use filter • Carbon media • Disposable 	<ul style="list-style-type: none"> • 100 micron barrier • High-flow carbon filter with KDF® to help prevent bacteria growth • Disposable • Includes anti-kink connector 	<ul style="list-style-type: none"> • 5.0 micron barrier • High-flow carbon filter with KDF® to prevent bacteria growth • Cartridge is replaceable • Includes hose extension 	<ul style="list-style-type: none"> • 5.0 micron barrier • High-flow carbon filter with KDF® to prevent bacteria growth • Cartridge is replaceable • Includes hose extension
Filter Media	Granular Activated Carbon (GAC)	Granular Activated Carbon (GAC) and KDF® mixture	Granular Activated Carbon (GAC) and KDF® with a Spun Polypropylene barrier	Superior Grade Granular Activated Carbon (GAC) and KDF® with a Spun Polypropylene barrier
Recommended Usage	120 days	One camping season	One camping season	One camping season
Micron Rating	150	100	5.0	5.0
Installation	Point-of-entry–Exterior	Point-of-entry–Exterior	Point-of-entry–Exterior	

Helps Protect Against >>

	RV/MARINE Carbon Water Filter #40645	RV/MARINE KDF®/Carbon Water Filter #40043/40045	EVO™ RV/MARINE KDF®/Carbon Water Filter #40631/40621	EVO™ VOC RV/MARINE KDF®/Carbon Replacement Filter #40624
VOCS* <small>* Volatile Organic Compounds</small>				✓
:: Aluminum	✓	✓	✓	✓
:: Bacteria		✓	✓	✓
:: Bad Taste	✓	✓	✓	✓
:: Cadmium		✓	✓	✓
:: Fungus		✓	✓	✓
:: Heavy Metals	✓	✓	✓	✓
:: Hydrogen Sulfide	✓	✓	✓	✓
:: Iron	✓	✓	✓	✓
:: Lead	✓	✓	✓	✓
:: Mercury	✓	✓	✓	✓
:: Mold	✓	✓	✓	✓
:: Odor	✓	✓	✓	✓
:: Turbidity (Cloudiness)	✓	✓	✓	✓
:: Sediment	✓	✓	✓	✓

This is just a partial list of contaminants removed by the TastePURE™ line of water filters.

A. Cold Weather Water Hose Keep your water supply flowing even in freezing temperatures. Camco's Heated Water Hose combines a drinking-water-safe hose with a self-regulating heat source which is encapsulated in an all-weather, PVC coating for durability. Features machined and Nickel-plated fittings for maximum corrosion protection. Includes a female-to-male adapter for connection of the water source to either end of the hose; depending on the location of your electrical connection.

- 22900 12 ft Cold Weather Hose
- 22902 25 ft Cold Weather Hose
- 22903 50 ft Cold Weather Hose

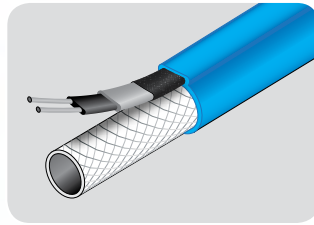

B. TastePURE™ Drinking Water Hoses Reinforced hoses for maximum kink resistance. Made with NSF certified hose. Lead-free, drinking water safe. BPA-free, phthalate-free formulation. No strong plastic taste is imparted to the drinking water. UV-stabilized for long life. Made in USA.

- 22763 4' Fresh Water Hose (1/2" ID)
- 22743 10' Fresh Water Hose (1/2" ID)
- 22733 25' Fresh Water Hose (1/2" ID)
- 22753 50' Fresh Water Hose (1/2" ID)
- 22783 25' Fresh Water Hose (5/8" ID)
- 22793 50' Fresh Water Hose (5/8" ID)
- 22803 75' Fresh Water Hose (5/8" ID)

C. Premium Drinking Water Hoses Heavy duty reinforced 5/8" ID drinking water hoses are 20% thicker than standard hoses. Anti-kink design features machined fittings and strain-relief ends for added durability. Lead-free, drinking water safe. BPA-free, phthalate-free formulation. No strong plastic taste is imparted to the drinking water. UV-stabilized for long life. Made with NSF certified hose. Made in USA.

- 22823 10' Premium Drinking Water Hose
- 22833 25' Premium Drinking Water Hose
- 22843 35' Premium Drinking Water Hose
- 22853 50' Premium Drinking Water Hose



D. TastePURE™ Spring Fresh™ One-step, no-measure solution requires no mixing or preparation. Good for periodic cleaning, freshening and deodorizing. Clean and deodorize or dewinterizer RV fresh water systems with this safe, biodegradable formula. One gallon cleans and freshens up to a 100-gallon tank.

- 40207 gallon



E. TastePURE™ Drinking Water Freshener Eliminate algae and slime buildup from drinking water tanks. Just one ounce helps remove bad smells and taste from 20 gallons of water.

- 40206 16 oz

F. TastePURE™ Fresh Tabs Clean, deodorize and dewinterize your entire fresh water system the easy way. Use for major cleaning of the fresh water tank and system before re-activating for use. One tablet per 15 gallons of tank capacity.

- 40193 6/pack



A. 90° Water Faucet Get an extra outside water source right at your RV's side with this lightweight plastic faucet. Lets your fresh water hose hang without kinking. Use as a pressure release valve during disconnection.

22463 90° Water Faucet

B. Water Diverter Provides an extra faucet at your water source. Threaded faucet attaches to a standard garden hose, allowing you to use the hose without disconnecting the RV water hook-up. Also acts as a pressure release during disconnection.

22475 Water Diverter

C. Hose Elbows Prevent hose kinking and strain, and extend hose life. 90° and 45° elbows eliminate unnecessary stress and strain on all RV water intake hose fittings. Perfect for RVs, or just around the house. Made of brass for years of trouble-free use.

22505 90° Hose Elbow

22605 45° Hose Elbow

D. Water Bandit Hook this 3-1/4" connector to any standard-size, unthreaded faucet or those with stripped threads and attach your garden hose. Stop wasting water due to poor connections.

22484 Water Bandit

E. Flexible Hose Protector with Easy Gripper Coiled attachment eliminates hose kinking at the faucet. Comes complete with Easy Gripper for effortless attachment to the faucet.

22703 Hose Protector

**Connects to
RV at fresh water inlet**
to provide an outside water faucet at the RV.



**Connects to
fresh water supply faucet**
to provide an outside water faucet
while RV is connected to water source.





A. Water Pressure Regulators

Stop damage to your RV water hose, pump or internal lines from inconsistent water pressure in campgrounds. Reduce water pressure to a safe, consistent 40–50 PSI of operational pressure. Protects equipment and prevents hose failure, helping to prolong equipment life. Available in durable ABS plastic or brass. (3/4" Male x Female Garden Hose Threads) Patented.

- 40143 Plastic Regulator 3/4" 6/ctn
- 40055 Brass Regulator 3/4" 6/ctn
- 40052 Brass Regulator 3/4" -Bulk



B. Stop Leak Connector

Connect bent hose ends. This versatile connector includes a built-in, one-piece, flow-through, flexible washer. Recommended for connecting damaged hose couplings and for new hoses to protect hose threads. Fits male or female end of a 3/4" garden hose.

- 20213 6/ctn



C. Water Pressure Regulator with gauge

Helps protect RV plumbing and hoses from damage that can be caused by high-pressure city water. Attaches easily with convenient 3/4" garden hose threads. Easy-to-read dial. Pressure is factory pre-set at 40-50 PSI. Patented.

- 40064 Regulator with gauge

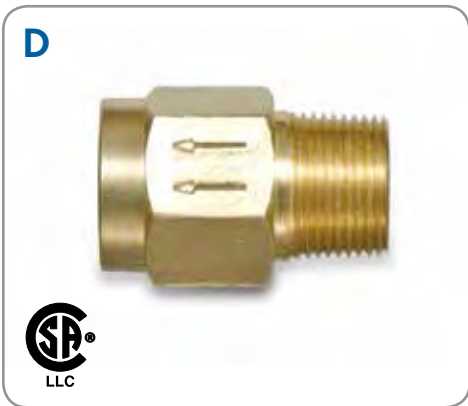

D. Backflow Preventers

Allows fluid to only flow in one direction. Prevents backflow. Heavy duty brass body with stainless spring. 1/2" or 3/4" (Male x Female NPT).

- 23303 1/2" skinpack (CSA approved) 6/ctn
- 23402 3/4" bulk 50/ctn



E. Filter Washers

Filter trash and debris from your water system. Washer fits any standard garden hose female coupling. Stainless steel 60 x 50 mesh traps dirt particles before they enter your RV system. Ideal for washing machine hookup at home.

- 20183 1" Washers 3/card



F. Hose Washers

Stop your garden hose from leaking at the faucet and hose connections. Self-locking tabs prevent loss of washer when hose is disconnected.

- 20153 10/card

A. Quick Hose Connects

Attach hoses quickly and easily for RV or residential hook-up. Choose a solid brass model with automatic shut-off when disconnected, or a sturdy plastic model with convenient built-in shut-off valve.

- A1 20103 Plastic connector with shut-off
- A2 20135 Brass connector with auto-shut-off
- A3 20143 Brass connector / flow-through



A1



A2



A3



B. Shut-Off Valves

Control water flow with a quarter-turn pressure seated valve. Y-style converts a single-line hose to two directions. Each side is valve controlled to easily adjust flow and pressure. Made of resilient plastic; wye also available in metal.

- 20113 Metal Y-valve
- 20073 Plastic Y-valve
- 20003 Plastic straight valve



C. Brass Shut-Off Valves

Solid brass housing with non-corrosive stainless-steel quarter-turn pressure seated shut-off valves. Features easy-grip valve handles and hose connection.

- 20123 Brass Y-Valve
- 20173 Brass 45° Valve



C



D. Quick Hose Connect Value Pack

includes two extra male connectors. Connect/Disconnect quickly between water hose and multiple attachments such as spray nozzle, sprinkler, water hose, pressure washer and many more! Shuts off automatically when disconnected. Use at your home, RV, boat or campsite—anywhere with a standard water hose hookup! Solid brass construction provides years of service.

- 20136 Quick Hose Connect Value Pack



D





A



B



C

A. Flexible Camper Drain Complete rust-proof drain system designed especially for campers and RVs. Drain trap is made of durable, chemical resistant polypropylene, evacuation flange is made of durable ABS construction with UV stabilizers. Includes 25' of 3/4" ID hose.

37420 Flexible Camper Drain

B. Camper Drain Trap Camper drain trap is designed especially for campers and RVs. Made of durable, chemical resistant polypropylene; won't rust. Barbed for 3/4" ID hose.

37262 polar white

C. Evacuation Flange Durable ABS construction with UV stabilizers; won't rust. Barbed for 3/4" ID hose. Use with camper drain trap for a complete drain system.

37271 polar white

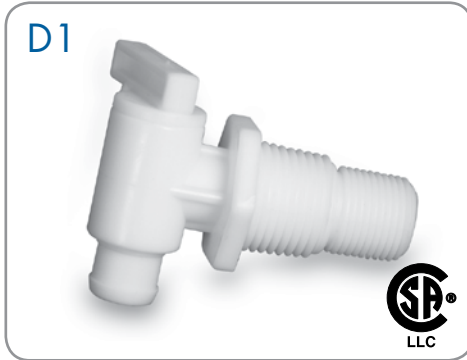

D1

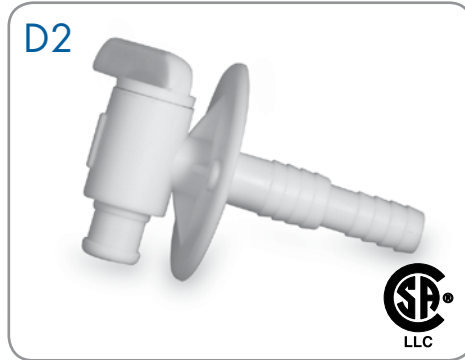

D2



D. Dual Size Drain Valves Easily drain your RV fresh water tank. Available with or without flange, each valve is graduated for use with 1/2" or 3/4" vinyl tubing. Durable plastic construction.

D1 22243 Dual size drain valve without flange
3/8" or 1/2" Male NPT thread

D2 22223 Dual size drain valve with flange
3/8" or 1/2" barb



E

E. Replacement Hose Plugs and Caps Replacement 3/4" hose plugs and caps to keep dust and dirt out of your water system. Each comes with an easily attached lanyard to help prevent the loss of your cap or plug.

22103 Male plug with lanyard

22204 Female dust cap with lanyard

F. Lanyards help prevent lost caps and plugs. Use with male or female plugs or dust cap.

22062 Snap-Fit lanyard, clear

22072 New Style lanyard, clear



New Style Lanyard



Snap-Fit Lanyard

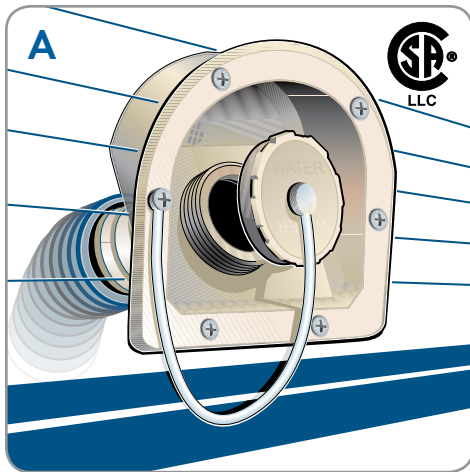

A. Replacement Recessed Water Fill Replace your cracked or broken RV water fill with an original replacement part. Durable white plastic construction—will not rust or corrode.

37221 25/ctn

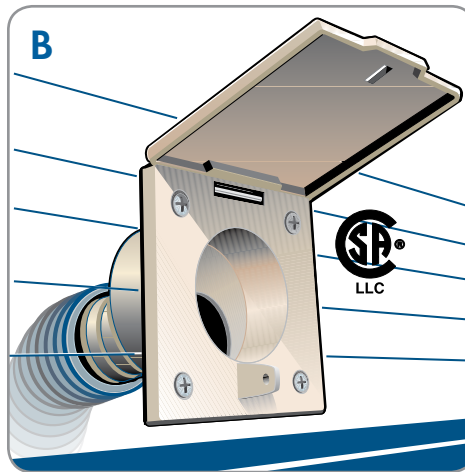

B. Fill Spout with Door Fill spout with door is designed with a loop and slot for pin or lock to ensure secure closure. Colonial white. Door is spring-loaded snap-shut design.

37102 25/ctn



C. Flush Mount Fill Spout Flush mount fill spout is designed to mount flush with RV side. Top-fill door is secured with sliding lock. Colonial white.

37002 25/bulk

D. Water Tank Fillers Fill your water tank in a fraction of the usual time and eliminate “bubble-back.” Large 5/8" fill tube allows you to fill your camper, trailer or motorhome water tank at or near full pressure while minimizing line backflow. Quarter-turn pressure-sealed valve allows you to selectively control water flow.

40003 Filler with shut-off valve

40023 Filler without shut-off valve



E. Plastic Water Fill Hose Ten foot hose for connecting a fill spout or city water fill to a water tank. 1-1/4" diameter. FDA non-toxic formulation, IAPMO® TSC 31-90 and TSC 7-90 compliant, IAPMO® listed file No. T-3334. Will not kink.

36601 Water Fill Hose





Sanitation

Featured products:



TST™
page 115



RhinoFLEX™
page 120



Sidewinder™
page 128



TST™ Toilet Treatments
Sewer Hoses
Sewer Hose Fittings

Sewer Hose Supports
Tank & Sewer Hose
Cleaners

Grey Water Tank
Maximizer™



Sanitation

113

A



For over 40 years RVers have trusted the odor-stopping power of TST™. The name TST™ still guarantees the highest quality in sanitation treatments that contain no formaldehyde, are non-staining and are safe for septic tanks. 100% biodegradable and environmentally safe.

A. TST™ liquid Original formula takes only 4 ounces to treat an entire 40-gallon tank in any season. Also available in an easy-to-use bottle with a convenient built-in reservoir for measuring. Eliminates odors and lubricates sensors. Safe for all septic tanks.

- 40227 gallon
- 40224 32 oz measuring bottle
- 40225 64 oz (not shown)
- 40226 32 oz



C



B



B. TST™ Singles Single-dose treatments require no mixing or measuring. Each 4-oz bottle treats 40 gallons. Eight bottles/pack.

- 40221 8 treatments

C. TST™ Drop-INS™ Handy, convenient individual dose pouches come in an easy-to-use resealable bag. One pouch treats an entire tank. Dissolves instantly, eliminates odors on contact. Contains 15 treatments.

- 40264 Drop-INS™ 15/bag

D



D. TST™ Tabs Deodorize black and grey water tanks with these compact tablets. One tab treats up to 40 gallons. Use in portable and RV toilets and grey water tanks.

- 41152 6 tabs/pack

E



E. RV & Marine Toilet Tissue

Fast-dissolving, clog-resistant toilet tissue is biodegradable and septic tank safe. Contains no dyes or perfumes. 1- or 2-ply.

- 40276 1 Ply/4 per bag, 280 sheets/roll
- 40274 2 Ply/4 per bag, 500 sheets/roll



A

C

A. TST™ Ultra Concentrated Harness the power of citrus to stop odors and break down waste in your RV or marine waste holding tank. Ultra concentrated formula—just 2 ounces treats a 40-gallon tank.

- 41197 gallon
- 41192 32 oz
- 41195 64 oz

B



B. TST™ Ultra Concentrated Singles Single-dose treatments require no mixing or measuring. Each 4-oz bottle treats 40 gallons. Eight bottles/pack.

- 41191 8 treatments

C. TST™ Ultra Concentrated Drop-INS™ Resealable bag contains 15 Drop-INS; one Drop-IN treats a 40 gallon tank. Easy-to-use, ultra-concentrated granular formula. Environmentally Safe!

- 41189 Drop-INS™ 15/bag

D



D. TST™ Grey Water Odor Control Remove grease buildup in your grey water tank, sink and shower drain lines with this concentrated treatment. Only four ounces per 40 gallons eliminates foul odors, leaving a fresh lemon scent.

- 40252 32 oz
- 40256 64 oz

The most natural solution
100% Biodegradable

A



A. TST™ Blue Enzyme Toilet Treatment

Specially blended enzyme formulation digests waste and tissue. Helps suspend waste and reduce potential system clogs. Takes only 4 ounces to treat an entire 40-gallon tank in any season. Cleans holding tank surfaces and probes. Safe for all septic tanks.

- 41501 Eight 4 oz Singles
- 41502 32 oz
- 41506 64 oz
- 41507 Gallon
- 41529 Blue Enzyme Drop-INS - 10/bag

B



B. TST™ Drain Valve Lube™ Lubricate plumbing lines while you drive. Prevents sticking valves with coconut oil, making equipment last longer. Recommended for all applications: waste holding tanks, black and grey water systems.

- 40246 16 oz

C



C. TST™ Probe Cleaner

Restore accurate sensor readings with a super-concentrated formula that attacks residue on probes. Works in black and grey water tanks.

- 41146 32 oz

D



D. Rhino Enzyme RV Holding Tank Treatment

features a Bacteria/Enzyme formula to digest waste and break down tissue for easy biodegradation. Natural formulation digests waste, tissue, fats and proteins. Activates only in the presence of material requiring digestion. *Advanced formula is stable, with a long shelf life and is not temperature sensitive.* Also contains a buffering agent to prevent acid formation and septic odors. This product harnesses the natural process by which nature digests waste. Environmentally friendly and biodegradable. Fresh pine scent. 2 ounces treats 40 gallons.

- 41512 16 oz
- 41514 64 oz
- 41511 Eight 4-oz Singles
- 41515 One 4-oz Single

Camco HTS™ sewer hoses are made from a **high tensile strength** formula vinyl to minimize pinholes and other leaks caused by the rough scrapes and abrasions of everyday use and transportation. **Three wraps of vinyl** and a **steel-wire core** offer the best protection for the price, with the convenience of collapsible storage.

A. Standard RV Sewer Hose

12 mils of black HTS™ vinyl, created for the occasional RVer. The 10' hose compresses to 14"; the 20' hose to 27-1/2" for storage.

39601 10' (6/ctn)
39611 20' (3/ctn)

B. Heavy Duty RV Sewer Hose

15 mils of brown HTS™ vinyl, created for the seasonal RVer who makes weekend trips during the summer camping season. The 10' hose compresses to 16"; the 15' to 26"; and the 20' hose to 32" for storage.

39621 10' (6/ctn)
39661 15' (3/ctn)
39631 20' (3/ctn)

C. Super Heavy Duty RV Sewer Hose 18 mils of gray HTS™ vinyl, created for the full-time RVer who lives on the road. The 10' hose compresses to 25"; the 20' hose compresses to 52" for storage.

39641 10' (6/ctn)
39651 20' (6/ctn)

D. Self-Clamping™ RV Sewer Hose

Designed for quick, simple hookup with all types of sewer hose adapters. Fittings slip on easily and clamp securely. This 15' super heavy duty hose is tough enough to stand up to all kinds of weather conditions. Built-in clamp keeps fittings securely in place. Compresses to 34" for storage. Patented.

39901 15'

E. Heavy Duty RV Sewer Hose with pre-attached fitting Heavy duty 15' sewer hose comes with attached bayonet fitting for easy, convenient hookup. Compresses to 27" for storage.

39691 15' (6/ctn)

A Standard RV Sewer Hose



For occasional camping
 With 12 mils of HTS™ vinyl
 Contains more wire and vinyl
 than other standard sewer hoses

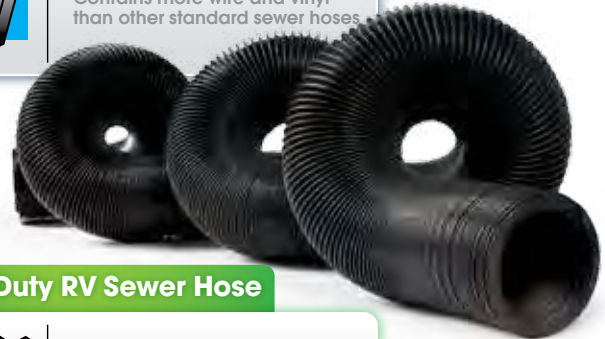

B Heavy Duty RV Sewer Hose

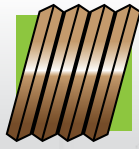

For seasonal camping
 With 15 mils of HTS™ vinyl
 Contains 25% more vinyl than
 other heavy duty sewer hoses



C Super Heavy Duty RV Sewer Hose



For full time camping
 The ultimate collapsible hose —
 18 mils of UV stabilized HTS vinyl.

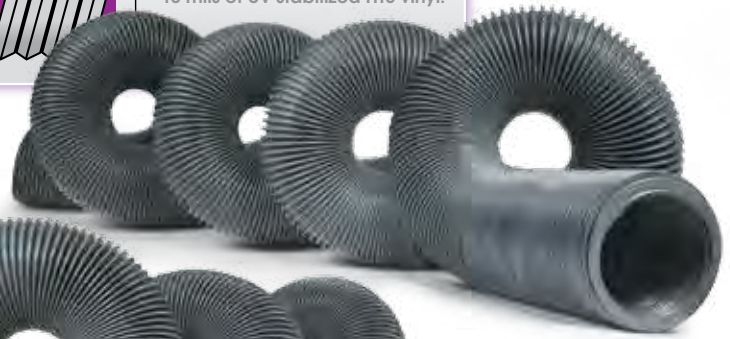

D



E



Camco's sewer hoses are designed to stand up to hot and cold weather for trouble-free camping. Whether you camp a few weekends a year or are exploring the country full time in your RV, Camco has a hose to fit your needs.



A. RhinoEXTREME 15' Sewer Hose

The same exceptional hose used in the 39861 and 39865 kits listed below, offered here without the fittings.

39862 15' RhinoEXTREME Sewer Hose



B. RhinoEXTREME RV Sewer Kits

All of the features that RVers are looking for in a complete kit. RhinoEXTREME hose will not dent or rust and will not crush if accidentally stepped on. Offers superior abrasion resistance for maximum protection against pinholes and leaks. The 10-ft kit includes a RhinoEXTREME hose with pre-attached Rhino bayonet and lug swivel fittings and 4-in-1 Elbow with adapter, plus four reusable locking rings and storage caps. The 20-ft kit includes all of the above, plus an additional hose with fittings, rings and caps as shown. Ready to use! Patent pending.

39861 RhinoEXTREME Kit - 15 ft

39867 RhinoEXTREME Kit - 20 ft



C. RhinoEXTREME Sewer Hose Extensions

Extend the reach of your RhinoFLEX or other* sewer hose with this handy kit. Includes 5 or 10 foot RhinoFLEX hose with pre-attached swivel lug and bayonet fitting featuring a reusable locking ring so that fittings can be moved to a new RhinoFLEX hose. Patent pending. The removable 4-in-1 adapter allows you to store in 4" square bumpers.

*Works with any sewer hose that has a bayonet fitting.

39865 5' Extension (not shown)

39863 10' Extension

A



Hose Support not included

A. Revolution™ Swivel RV Sewer Kit is the complete hose kit that comes with everything you need for a quick, reliable hook-up. Features new pre-attached fittings that rotate 360 degrees. Includes two 10 lb heavy duty vinyl sewer hoses with pre-attached swivel lug and swivel bayonet fittings and 4 storage caps. Other features include translucent elbow and wire guards to protect your hands. Patent pending. Also available: 10' Extension with pre-attached swivel lug and swivel bayonet fittings.

- 39625 Revolution Kit
- 39623 Revolution 10' Extension

B. Revolution Swivel Fittings

Add a 360° swivel to any RV sewer hose. Bayonet fitting and Lug fitting include a Twist-It™ clamp for securing fitting to hose. Patent pending.

- B1 39471 Revolution Elbow w/4-in-1 Adapter
- B2 39481 Revolution Bayonet Fitting with Twist-it Clamp
- B3 39491 Revolution Lug Fitting with Twist-it Clamp

C. Sewer Hose Storage Caps

Set of two; one each for bayonet and elbow fittings. Can be used with Revolution, Easy Slip and RhinoFLEX fittings. Patented.

- 39753 Sewer Hose Storage Caps



A



Camco RhinoFLEX™ hoses are made of heavy-duty polyolefin reinforced with steel wire.

B

(15 foot Kit shown)



A. RhinoFLEX™ RV Sewer Hose

The world's toughest sewer hose retains its shape once it's set until unhooked and stored. Made with 23 mils of heavy duty polyolefin reinforced with steel wire. 10' hose compresses to 32" and the 15' hose compresses to 45" for storage.

39671 10'
39681 15'

B. RhinoFLEX™ RV Sewer Kits with pre-attached fittings

At the RV end of the hose, there is a super-tough bayonet fitting with 4 bayonets for a more secure fit. At the dump-station end we've added a translucent elbow that separates from the 4-in-1 adapter for easy storage. These are ready-to-use kits made with the toughest hose you can buy. Pre-attached swivel fittings feature locking rings so that your fittings stay secured. Bayonet cap and elbow cap also included. Patent Pending.

39761 RhinoFLEX Sewer Kit - 15'
39741 RhinoFLEX Sewer Kit - 20'

C

(5-foot Extension shown)



C. 5' RhinoFLEX™ Extension Kits

Extend the reach of your RhinoFLEX or other* sewer hose with this handy kit. Includes RhinoFLEX hose with pre-attached swivel lug and bayonet fitting featuring a reusable locking ring so that fittings can be moved to a new RhinoFLEX hose. Patent pending.

*Works with any sewer hose that has a bayonet fitting.

39765 Extension Kit - 5'
39764 Extension Kit - 10'

D



D. RhinoFLEX™ Locking Rings

Reusable locking rings work with new and original RhinoFLEX Elbow, Bayonet, Lug or Coupler fittings, allowing fittings to be moved to a new RhinoFLEX hose. Set of two. Patent pending.

39803 Locking Rings

RhinoFLEX sewer hose fittings are designed to work with the RhinoFLEX hose. Made with UV stabilized resin for long life. Each of the three easy-to-use fittings features a **reusable locking ring** so that fittings can be moved to a new RhinoFLEX hose.

A. RhinoFLEX™ RV Sewer Hose Swivel Elbow Fitting with 4-in-1 Adapter takes the trouble out of connecting to the dump station. Elbow locks and seals into adapter for a secure and odortight connection, and **still swivels when connected**. Translucent elbow detaches from 4-in-1 adapter to store with hose in 4" bumper. Complete with reusable locking ring. Patent pending.

39733 RhinoFLEX Elbow

B. RhinoFLEX™ RV Sewer Hose Swivel Lug Allows you to connect your RhinoFLEX hose to any sewer hose that has a bayonet fitting. Reusable locking ring provides a secure odortight connection without hose clamps. Stores in 4" bumper. Patent pending.

39773 RhinoFLEX Lug

C. RhinoFLEX™ RV Sewer Hose Swivel Bayonet Fitting is designed with four sturdy prongs that lock into position. Easy-grip wings for quick connect and disconnect. Built-in gasket for an odortight connection without hose clamps. Stores in 4" bumper. Complete with reusable locking ring. Patent pending.

39783 RhinoFLEX Bayonet

D. RhinoFLEX™ RV Sewer Hose Swivel Coupler is the easiest way to connect two RhinoFLEX hoses. It provides a secure odortight connection without hose clamps. Stores in 4" bumper. Patent Pending.

39821 RhinoFLEX Coupler

E. RhinoFLEX™ Wye Allows two hoses with lug fittings to be connected to the same dump station. Perfect for a motorhome has two separate holding tank valves. Patent pending.

39812 RhinoFLEX Wye

F. RhinoFLEX™ Swivel Fittings Transparent or semi-translucent fittings connect sewer hose to waste valve fitting. Features swivel lug and bayonet fittings for a secure connection. Available in 45° or 90° style. Patent pending.

39842 45° Translucent Fitting

39852 90° Translucent Fitting

39847 45° Clear Fitting

39857 90° Clear Fitting





Patented Easy Slip™ sewer hose fittings are the most user-friendly fittings available today. Camco's Easy Slip™ fittings are made in the USA of engineering-grade resins for strength and durability.

**No clamps
or tools needed.**



All Easy Slip™ fittings have Camco's patented Spin-Lock™ rings that rotate directly onto sewer hose wire for a secure hold. Just pull hose onto the fitting, turn the Spin-Lock™ rings around the hose to tighten, and you have a secure, airtight seal that eliminates odors and leaks. **There's no need for clamps or tools.** No other fitting gives you the ease, convenience and security you get every time you hook up with Spin-Lock.

A

B



A. Easy Slip™ RV Straight Hose Adapter Connect hose to RV quickly with an airtight odor and leak seal. Tapered ends accept all 3" sewer hoses. Stores with hose in standard 4" bumper. Non-restrictive, allows free flow. Patented.

39172 bulk (6/ctn)
39173 clamshell

B. Easy Slip™ RV Internal Hose Coupler Connects two sewer hoses together. Tapered ends accept all 3" sewer hoses and slip-over fittings. Allows for quick, secure and airtight connection. Stores with hose in standard 4" bumper. Non-restrictive, allows free flow. Patented.

39162 bulk (6/ctn)
39163 clamshell



A. Easy Slip™ 4-in-1 Sewer Adapter with Elbow Connects hose to dump station. The elbow's tapered end accepts all 3" hoses and slip-over fittings. Adapter fits into 3" slip or 3", 3-1/2" and 4" threaded pipe. Larger inside diameter allows for faster dumping. Elbow separates from adapter for storage in bumper. Patented.

39144 4-in-1 Elbow

B



B. Easy Slip™ Grey Water Drain Adapter Connect your garden hose between the dump valve and this adapter to drain your grey water tank, or attach it to the sewer hose to rinse hose out. Adapter with Easy Gripper provides airtight odor and leak seal. Fits Camco Easy Slip™ 4-in-1 threaded sewer adapter or standard sponge ring.

39111 Grey Water Drain Adapter



C. Grey Water Seal Get an airtight odor and leak seal when you drain grey water into campground sewer system. With Easy Gripper. Made in USA.

39322 Grey Water Seal

C

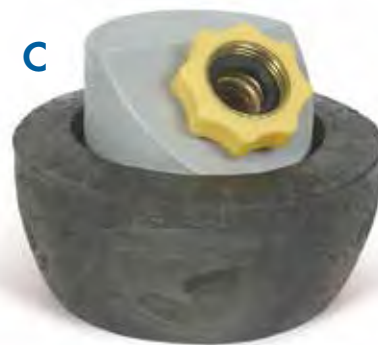

D. RV Sewer Hose Fitting Gaskets Get an odortight connection every time with fitting gaskets. Works with all Camco elbow and bayonet fittings. Includes two bayonet and two elbow gaskets.

39834 Gaskets

D



E. RV Sanitation Gloves with mountable dispenser. Keep your hands clean from the messy tasks of RVing. These durable all-purpose gloves are perfect for everything from sanitation hose connections to messy clean-ups and pet care. Made of latex-free and powder-free material that grips in wet or dry conditions. Disposable, one size fits all. 50 pair. Patented.

40285 Sanitation Gloves



E



A



Hose Support not included



A. Easy Slip™ Ready-to-Use RV Sewer Kit This complete sewer kit comes assembled with everything you'll need for a quick, reliable sewer hook up. Non-restrictive for free flow and faster dumping. Includes 10' HTS™ sewer hose, Easy Slip™ bayonet straight hose adapter and Easy Slip™ sewer elbow with 4-in-1 adapter. Hose Support not included. Patented.

39551 Easy Slip Sewer Kit

B



Hose Support not included

B. Easy Slip™ Travel Pak™ 20

Get everything you need in one kit. Travel Pak™ comes with a 20' HTS™ sewer hose, pre-installed Easy Slip™ fittings, vented end plugs and storage clamps. Storage tube protects against pinholes and stores in 4" bumper or basement storage compartment. Patented.

40571 Easy Slip Travel Pak





A. Cyclone™ Plumbing Vent Use the power of the wind to draw holding tank odors out of your RV. Even a gentle breeze works with the dynamically engineered shape of the Cyclone™ to create a powerful vortex that pulls odors up and away. Attaches easily to any RV plumbing vent. Patented.

40595 Cyclone Plumbing Vent



B. Portable Toilets are designed for camping, RVing, boating or any other recreational activity. Sturdy polyethylene construction is compact and lightweight. The holding tank is detachable and includes a sealing slide valve to lock in odors and protect against leakage. It includes two side latches to secure the tank to the toilet and a carrying handle for easy transport. The toilet employs an easy-to-use bellow-type flush and pull slide valve for easy flushing. Includes a packet of Camco's TST biodegradable toilet chemical.

2.5-gallon (12.5"H x 16.25"W x 14.5"D);
5.6-gallon (16.38"H x 13.75"W x 16.13"D)

41531 2.5-gallon

41541 5.6-gallon

C. Replace-All Plumbing Vent Kit

Replace damaged plumbing vents with quality original factory replacement vents. Kit fits 1" to 2-3/8" O.D. pipe and includes vent plus all hardware and putty tape needed for installation.

40133 beige 3/ctn

40033 polar white 3/ctn

40132 Vent Only - beige 72/bulk

40032 Vent Only - polar white 72/bulk

D. Replace-All Plumbing Vent Cap

Separate cap fits up to a 2" pipe. Features spring tension attachment, which eliminates the need to replace the entire vent just because of a lost cap top. Patented.

40134 beige 6/ctn

40034 polar white 6/ctn

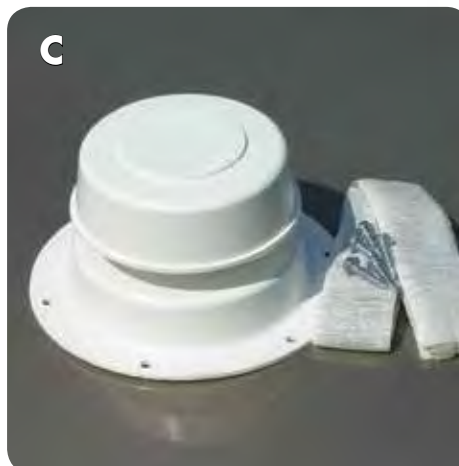



A



Keep your holding tank clean. Our convenient line of holding tank rinsers will dislodge and flush stubborn waste deposits and odor-causing particles. Periodic rinsing is essential for proper sensor probe function.

A. Tornado™ Rotary Tank Rinsers

Reach every area of your holding tank. This permanent tank rinser with a 360° rotating head and ten high-pressure nozzles is the easiest, most sanitary way to clean your holding tank. No need for hoses through the windows or devices stuck down toilets. Has built-in a backflow preventer and a vacuum breaker. Kit comes with an exterior access hose for quick hose connection with no mess. Patented.

- 40126 Tornado Kit with 6' hose
- 40128 Tornado without hose



B



B. Quickie Flush™ Thoroughly flush your holding tank without bringing a hose through the window. Permanently installed built-in backflow preventer keeps sewage from contaminating water line. Just hook garden hose to the connection (outside RV).

- 40123 with 8' hose

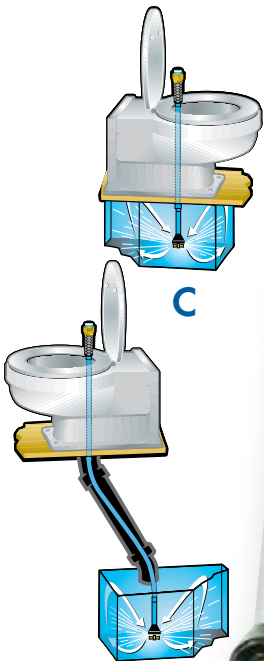

C



C. RV Swivel Stik™ Tank Rinsers

Patented holding tank rinsers with shut-off valves dislodge and flush stubborn waste deposits and odor-causing particles left after holding tank is emptied. Powerful rotary cleaning action reaches corners and walls of tank. One-quarter turn shut-off valve at your fingertips. All brass moving parts. Flexible Swivel Stik™ has a flexible 55-1/2" reach for basement holding tanks.

- 40094 Swivel Stik™
- 40074 Flexible Swivel Stik™ - Patented.

D. Holding Tank Rinsers

Completely flush out your holding tank. Easy grip handle and quarter-turn pressure-sealed valve allow complete control of water flow. Side jets clean and rinse the smallest, hard to reach places. Rinser kit includes holding tank rinser plus a 8' hose and Faucet Adapter. Patent pending.

- 40103 Rinser with valve
- 40113 Rinser Kit
- 40083 Faucet Adapter only (carded)

D

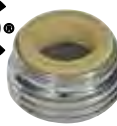

faucet adapter

Camco takes the guess work out of cleaning your system. Clear, break-resistant polycarbonate adapters make it easy to see when the tank is done rinsing.



A. Dual Flush™ PRO Clean your entire septic system with this reverse flush valve. Forces water back up into plumbing lines to break up clogs in pipes. Allows you to backfill and flush black and grey water tanks, then reverse valve and flush sewer drain hose. Anti-siphon valve and complete valve assembly included. Patented.

39062 Dual Flush PRO

B. Dual Flush™ Sprays water into lines to clear out clogged pipes. Get two-way jet cleaning action with this unique holding tank and sewer hose rinser. Transparent 5" long polycarbonate fitting attaches between sewer hose and RV, then hooks to any standard water hose to create a powerful spray that helps reduce odors and malfunctions in RV holding tanks and hoses. Patented.

39072 Dual Flush



C. Sewer Hose Rinse Cap

Thoroughly rinse your sewer hose before storing. Locks onto bayonet fitting securely, and connects to a garden hose. Fits Easy Slip™, RhinoFLEX™ and standard sewer fittings. Can be left in place as a hose cap during storage.

39533 Sewer Hose Rinse Cap



D. C-Do™ 45° Hose Adapter

Know when your system is clean with this see-through hose adapter made of break-resistant polycarbonate.

39432 45° Hose Adapter



SIDE WINDER



A



Sewer hose and fittings not included

A. Sidewinder™ Sewer Hose Support

Sidewinder™ Sewer Hose Supports were designed to go around any obstacle and allow proper drainage. Sturdy, lightweight plastic support with strong snap-fit hinges has deep cradles to hold sewer hose in place without straps. No staples to rust. Easily positions around obstacles and stays where you put it. Won't creep closed. 43031, 43041 and 43051 come with a convenient handle; 43061 comes with a carrying strap, to make storage even easier. Patented and patent pending.

- 43031 holds 10' hose
- 43041 holds 15' hose
- 43051 holds 20' hose
- 43061 holds 30' hose

B. Aluminum Folding Sewer Hose Support

Lightweight all-aluminum stand keeps sewer hose secure over the most uneven terrain. This durable support has been sold for over twenty years, and has more than a million satisfied users. Telescopes to 6'; folds to 6" for easy, compact storage. Provides stability for trouble-free drainage. Set up and storage take just seconds. Rust resistant. Solid brass rivets. Includes strap kit to hold hose securely in place. Lifetime warranty.

- 40351 Sewer Hose Support

C. Sewer Hose Support Strap Kit

Hold the sewer hose securely to the cradle and keep the hose from rolling off. Strap kit works with Camco folding sewer hose support (#40351). Clips are durable chrome-plated steel. Straps are UV stabilized vinyl.

- 40553 3 pack

B

Sewer Hose and fittings not included



C





A



A. RhinoFLEX™ Sewer Cleanout Plug Wrench Universal wrench allows you to loosen and remove any cleanout plug with ease. Works with any Camco 4-in-1 adapter. Patent pending.

39755 Sewer Cleanout Wrench

B. RV Twist Connect Kit Connect two hoses quickly and easily for added length. Fits all 3" sewer hoses.

39543 Twist Connect Kit

C. RV Sewer Hose Twist-IT™ Clamps Make fast work of connecting sewer hoses with easy-to-use Twist-It Clamps. No tools required—just position the clamp and twist the convenient thumb grip to tighten! Durable construction features 3" rust-resistant clamps and UV stabilized resin thumb grips.

39553 2 pack

D. Multi-Clamp™ Secure objects of almost any shape or size with no tools. Each clamp holds objects between 1/2" and 4" in diameter. Made of flexible hardened plastic with UV inhibitors. Won't rust; resistant to most chemicals. Join two or more together for larger jobs.

39103 Multi-Clamp



B



C



D

A



You can count on Camco for all the fittings and accessories you'll need to make the right sanitation connections.



A. Bumper Caps with Insect Screens

Replace lost or damaged RV bumper caps with Camco's RV Bumper Caps featuring vent holes and squeeze grip for easy installation and removal. Holes allow ventilation while keeping flying insects out. Constructed of durable polyethylene. Patent pending.

- 40322 Bulk
- 40324 Single Cap with Saver
- 40325 2/pack

B



C



B. Bumper Caps RV 4" bumper caps have vented hole for air circulation and easy removal. Durable lifetime polyethylene construction. Cap with saver allows for easy removal and attaches to bumper so it won't be left behind.

- 40303 2/pack
- 40302 225/bulk

D



C. 3" Permanent Plumbing Adapter

Allows hookup of standard RV bayonet connection to 3" threaded plumbing pipe.

- 39422 Permanent Plumbing Vent

E



D. 90° Sewer Hose Splicer Elbow

For joining two hoses to go around a corner.

- 39232 90° Splicer Elbow

F



F



E. 3" Sewer Hose Wye Allows connection of two hoses to the same dump station.

- 39272 Sewer Hose Wye

F. Clear Sewer Hose Adapters

Straight hose adapters attach directly to your RV's sewer connection, allowing you to extend your sewer hose outlet for easier, more convenient hose connection. Because they are clear, they help during tank cleaning by letting you to see when your system is fully rinsed.

- 39572 5" Straight Adapter
- 39582 7" Straight Adapter
- 39592 9" Straight Adapter

Hose couplers and adapters allow you to connect hoses to the RV, to the dump station or to other hoses.



A. RV 45° Hose Adapter

Connects sewer hose to RV.

- 39403 45° Hose Adapter
- 39402 24/bulk

B. RV Straight Hose Adapter

Connects sewer hose to RV.

- 39413 Straight Hose Adapter
- 39412 24/bulk

C. RV Sewer Caps Cap your sewer connection to prevent leaks. Cap with hose connection allows you to drain grey water tank easily.

- C1 39452 cap 24/bulk
- C2 39463 cap with hose connection
- 39462 cap with hose connection 24/bulk

D. RV Internal Hose Coupler

Connects two sewer hoses together.

- 39203 Internal Hose Coupler
- 39202 (24/bulk)

E. 3" RV Waste Valve

- 39513 Waste Valve

F. RV Sewer Hose Seal 4" x 3" sponge ring works with the grey water seal or directly on sewer hose for an odor proof connection to dump station.

- 39313 Sewer Hose Seal
- 39312 (24/bulk)

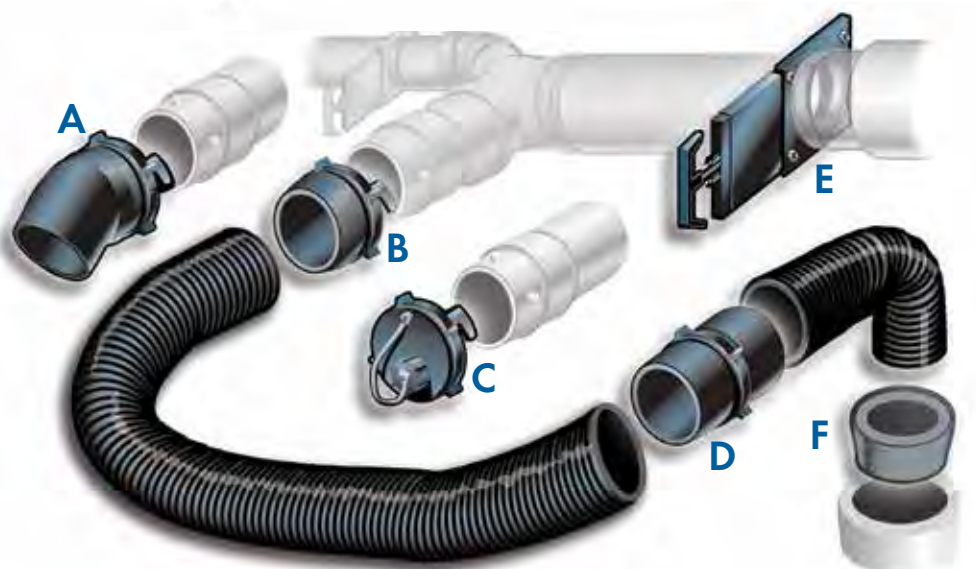



RV Cleaning & Care

Featured products:



**Black Streak
Remover**
page 134



Wash Brushes
page 137



**RV Rubber Roof
Care System**
page 139



RV Cleaning Products
Slide Out Care

Rubber Roof Care
Protectants

Cleaning Tools



RV Cleaning & Care

133

CAMCO**100%**
POWERFUL
100%
BIODEGRADABLE

Camco's professional-strength RV care products are powerful, dependable cleaners that save you money and time. They dramatically reduce cleaning time and leave a showroom finish every time.

A. Black Streak Remover Power away stubborn black streaks caused by window and door sealant and roof coatings. Great for interior cleaning too.

41002 32 oz
41004 gallon

B. Rubber Roof Cleaner & Conditioner Deep clean and condition your rubber roof to extend its life. One application of this blend of surfactants and conditioners gets rid of black streaks, oxidation and road grime.

41062 32 oz

C. RV Awning Cleaner Remove mold stains, mildew stains, dirt, tree sap and road grime with the industrial strength formula that's safe for all awning fabrics.

41022 32 oz
41027 gallon



D. Armada® Carnauba Wash & Wax Cleans, Shines & Protects in one easy step!

This non-toxic and biodegradable wash & wax is a premium grade cleaner for fiberglass, metal and painted surfaces and is the only boat soap available with real carnauba wax. Replenish your wax while you wash so that your sparkling shine lasts in between washings and reduces the frequency waxing needed.

40914 AquaBlock™ - 22 oz

E. Armada® AquaBlock™ Waterproofing & Stain Repellent Contains UV and Mildew Resistant Agents. Most mills, including Sunbrella®*, apply a fluorocarbon polymer to the cloth at the factory for waterproofing and stain repellency. This is the most durable and effective waterproofing technology currently known. A polymer is like Teflon® for cloth. Armada AquaBlock uses virtually the same fluorocarbon technology as the mills do to last an entire season. Application is therefore more effective, durable and easier to use than a less compatible agent. AquaBlock has been independently laboratory tested against the three leading waterproofing products in the marine industry and was found superior.

40922 Carnauba Wash & Wax - 32 oz

40927 Carnauba Wash & Wax - gallon

*Sunbrella® is a registered trademark of Glen Raven Inc.

A. Trailer Glitter™ Bring back the luster to those dull exteriors and clean all the surfaces in your RV—metal, wood, plastic, fiberglass, paint—with just one product.

40602 32 oz

40607 gallon

B. RV Wax Sealant Beads better, shines brighter and lasts longer than other liquid waxes! Just apply to a clean surface with a damp sponge or soft cloth and let dry to a haze. Then buff off with a clean cloth for a showroom high-gloss shine.

41010 RV Wax Sealant

C. RV Wash & Wax Give your RV a clean finish and a hand-polished look without buffing.

40492 32 oz

40497 gallon

D. RV Mildew Stain Remover

Just spray on to remove mildew stains on contact! Perfect for renewing the look of awnings, headliners, vinyl covers, chair cushions and more without scrubbing.

41092 32 oz

E. Color & Finish Restorer Restore shine and make the paint sparkle again on dull and weathered RVs. Non-abrasive formula also cleans stripping and trim.

41040 32 oz

F. RV Wash Sponge Curved shape for an easy grip while washing your RV. 7" x 4.5" x 2" - yellow.

44710 RV Wash Sponge

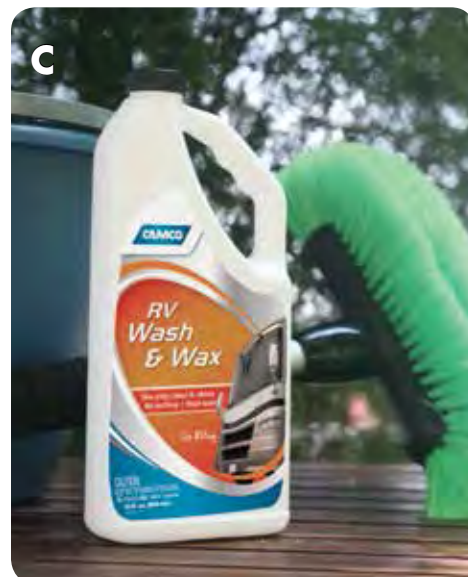



A

EXTENDS TO 71 INCHES
STORES IN 43 INCHES

WATER HOSE CONNECTION

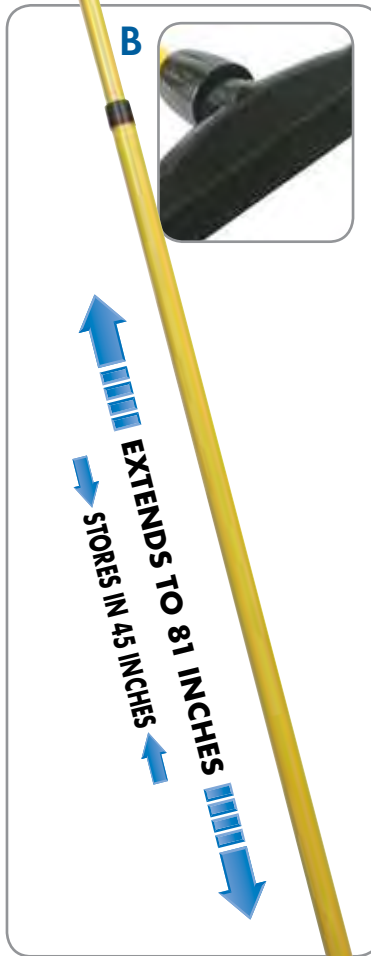

B

EXTENDS TO 81 INCHES
STORES IN 45 INCHES

A. Adjustable RV Wash Brush

Adjusts from 43" up to 71" long. Built-in ON/OFF switch provides full water control. Versatile brush features an 11" wide cleaning head with two types of bristles for maximum cleaning power: white bristles lift dirt and gray bristles brush it away!

43633 Wash Brush

B. 21" Wide Ultimate Squeegee

Strong, lightweight, flexible squeegee won't scratch RV finish. Acid-resistant, non-corroding polypropylene frame. Features a splash guard and 4" black twin foam rubber blade.

43733 Ultimate Squeegee with handle
43742 Ultimate Squeegee / no handle

C. XL Collapsible Bucket

Over 18" wide for ease of use with large wash brushes. Collapses to 2-3/4" tall to fit in its own easy-to-carry storage bag (included). Made with durable watertight fabric. Extra-large 18-1/4" x 9-1/2" x 10-1/2" bucket has a 5-gallon capacity.

42973 XL Collapsible Bucket

D. Blast-Out Pressure Washer Concentrate

Powerful pressure-washer cleaner specially formulated for RV and boat cleaning. Removes dirt, oil, grease and mildew stain. Use with a pressure washer or clean manually with a cloth, sponge or soft brush. Phosphate-free; contains no bleach or ammonia.

41867 Boat/RV Wash

E. Blast-Out Degreaser

Fast-acting formula dissolves grease on contact. Super-concentrated cleaner safely removes grease, oil and dirt from driveways, garage floors, tires, engines, grills and more. Phosphate-free, and safe for plants and pets; contains no bleach or ammonia. Easy to use: just spray on and wash off.

41892 32 oz
41897 gallon



C



D

NEW



E

RV CLEAN



NEW

Ergonomic Tear-Drop Design



MULTI-PURPOSE HANDLES AND ACCESSORIES

A. Adjustable Multi-Purpose Handle Teardrop profile. Anodized aluminum construction. Two TPE hand grips. Patented.

- 41910 2'-4'
- 41912 3'-6'
- 41914 5'-9'
- 41916 6'-11'

B. Fixed-length Multi-Purpose Handle Teardrop profile. Anodized aluminum construction. TPE hand grip. Patented.

- 41900 2'
- 41902 4'

C. Multi-Purpose Handle Brush Head Attachments 7"-wide brush head. Rubber perimeter bumper. Available in 4 textures.

- 41920 Extra soft, light blue
- 41922 Soft, dark blue
- 41924 Medium, yellow
- 41926 Stiff, white



D. Multi-Purpose Handle Accessory Attachments

D1. Wash Head with Synthetic Wool Pad

- 41930 Wash head w/Pad
- 41932 Replacement Pad

D2. Wash Head with Microfiber Pad

- 41948 Wash Head w/Pad
- 41950 Replacement Pad

D3. PVA Mop Head

- 41934 Mop Head

D4. Squeegee

- 41936 Squeegee -Patented
- 41938 Squeegee Adapter





A. RV Awning Waterproofer

waterproofs and protects fabrics. Also great for outdoor furniture, pop-up campers, RV covers and tents. Restores water repellent qualities to fabric; lasts through several washings.

41072 22 oz

B. Aluminum Care Wash Restores the sheen on dull exterior surfaces. Use on RVs, horse trailers, siding, wheels, canoes and more. Cleans metal, plastic, fiberglass and painted surfaces.

40612 Aluminum Care Wash, 32 oz

C. Bug & Tar Cutter™ Cut through bugs and tar buildup from everyday driving. Thicker formula clings to the surface wherever it's sprayed for concentrated power. Safe for all exterior vehicle surfaces, including clearcoat and gelcoat. Biodegradable.

41392 32 oz

D. RV Citrus Multi-Purpose Cleaner™

Safely clean all surfaces, including wood, plastics, vinyl tile, ceramic and painted surfaces. Specially formulated multi-surface cleaner and degreaser powers away stains, dirt and grease, leaving a clean citrus scent.

41422 32 oz

E. Hand Brush Ergonomic shape and non-slip handle make this brush ideal for many RV and household cleaning tasks.

43631 Hand Brush

F. 210® Plastic Cleaner/Polish

The professionals' choice for protecting and maintaining isinglass, plexiglas and vinyl. Seals the pores in all plastics, leaving a protective coating with UV inhibitors to prevent browning and hardening. Anti-static, anti-fog and non-streaking. Provides plastics with a clear, lustrous look.

40931 210®, 7 oz aerosol

40934 210®, 14 oz aerosol

G. 210® Plus Plastic Scratch Remover

Remove surface scratches and blemishes. One-step formula is an extremely mild abrasive compound with anti-static and anti-fog properties. Water soluble and easy to use with superior results.

40944 210® Plus, 15 oz

A. Slide Out Lube & Protectant

Make slide outs operate smoothly without sticking. Spray-on lube leaves a dry film that repels dirt and grime and protects against rust and corrosion.

41105 15 oz aerosol

B. Slide Out Rubber Seal Conditioner

Protect and condition the seals on your slide outs. Shields against UV rays and decreases friction, making rubber seals last longer.

41135 16 oz aerosol

C. Rain Cutter Rain Repellent Glass Cleaner

Our exclusive formula sheds rain faster than the national brand. Premium product cuts road grime fast for cleaner windshields.

41782 32 oz spray

D. Multi-Surface Indoor/Outdoor Cleaner

is formulated to remove tough food stains, grease, mildew stains and soap scum. Cleans kitchen and bathroom surfaces including: stove tops, counters, sinks, tubs, toilets and tile. Leaves a clean, fresh orange scent.

41872 Indoor/Outdoor Spray - 32 oz

E. Multi-Surface Degreaser is a heavy-duty cleaning formula and is packed with powerful degreasing solvents that quickly and easily remove the toughest grease, dirt and grime. Leaves a clean, fresh lime scent.

41882 Degreaser Spray - 32 oz

F. Pro-Tec™ RV Rubber Roof Care System

This innovative 2-step Roof Care System is a must-have for every RV owner! Protects your rubber roof against the elements to reduce roof chalking and minimize maintenance. Contains a gallon of Pro-Tec™ Rubber Roof Cleaner and a gallon of Pro-Tec™ Rubber Roof Protectant.

41451 RV Rubber Roof Care System

Also available separately:

41067 Rubber Roof Cleaner - gallon

41447 Rubber Roof Protectant - gallon

41065 Rubber Roof Cleaner - 32 oz

41442 Rubber Roof Protectant - 32 oz



See page 74 for
Rubber Roof Patch Kit



RV Towing

Featured products:



Trekker™
Adaptive Sway Hitches
page 142



Gooseneck Adapters
page 143



**Weight Distribution
Hitch Kits**
page 146



Ball Mounts and Shanks

Towing Accessories

Reversible Ball Mounts

Sway Controls

Towed Vehicle Protection

Trailer Connectors

Wiring Harnesses

Weight Distributing Hitches

Tow Bars

Towing Wire

5th Wheel Hitches



RV Towing

141

No other hitch comes close.

Trekker



Innovative Weight Distributing Hitch with Adaptive Sway Technology

- Adaptive sway resistance
- Noise suppressed



Easy On/Off Sway Control

- Distribution bars are easy to move into place
- Turns off quickly for dangerous road conditions

Automatic Sway Control Disengagement

- Disengages for tight maneuvering
- Decreases wear

Eaz-Lift's Trekker hitch is designed with Adaptive Sway Technology

Sway resistance is instant when driving on the highway. Trekker reacts and increases resistance as needed when challenged with wind gusts and passing trucks. When taking sharper turns or tight maneuvering where sway control is unnecessary, Trekker disengages sway for improved handling.

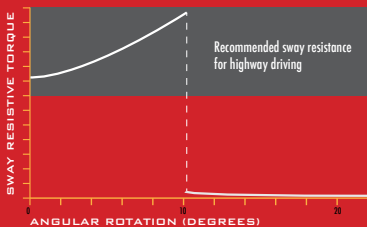

Eaz-Lift Trekker is the perfect combination of premium weight distribution and sway control in an easy-to-install hitch. Trekker utilizes adaptive sway technology which goes above and beyond that of the competitors' weight distribution hitches. When towing and challenged with wind gusts and passing trucks, the Trekker reacts and increases resistance as needed! During sharp turns and maneuvering, when sway control is unnecessary, the Trekker disengages sway control completely for improved handling. When towing in dangerous conditions, such as slippery or icy roads, sway control is unwanted. Trekker's easy on/off sway control makes it a breeze to manually disengage. This feature also comes in handy when hooking-up and unhooking. Includes High-Low Shank.

- 48701 Trekker Hitch, 600 lb
- 48703 Trekker Hitch, 1,000 lb
- 48704 Trekker Hitch, 1,200 lb

eaz lift
Since 1952

**eaz
lift**
Since 1952™

INNOVATIVE, CONVENIENT & REMOVABLE TOWING SOLUTIONS.



Gooseneck System

- Adapts 5th wheel trailer to fit gooseneck trailer hitch*
- Rated up to 30,000 lb.
- Available in 12-, 15- and 17-inch heights
- Easy to install
- Tow a 5th wheel trailer without a large hitch taking up the bed of your truck

*Works in most cases

A. Eaz-Lift Gooseneck Adapters

will convert most standard fifth-wheel trailers to a gooseneck trailer. This allows you to have the convenience of towing two types of trailers with only one truck. You will also enjoy towing a fifth-wheel trailer without having a large hitch taking up the bed of your truck. Eaz-Lift's Gooseneck adapters feature an automatic latching coupler for a simple hookup and disconnect. They have a 30,000 lb tow rating and are available in 12, 15 and 17 inch heights for your specific truck and trailer setup. Easy to install and each adapter comes with all of the parts and hardware needed for installation.

48490 17" Gooseneck Adapter

48500 12" Gooseneck Adapter

48501 15" Gooseneck Adapter

48572 Bolt Pack for Gooseneck Adapter

B. Gooseneck Ball & Plate Ball plate with 2 5/16" ball spins in and out. 30,000 lb. rating. (7,500 lb vertical load). Requires only one 3" hole in truck bed.

48561 Ball and Plate w/wrench



Innovative, convenient and **REMOVABLE** Towing Solutions

Your truck bed is more than just a place for your fifth wheel hitch...



- 18,000 lb (4,500 lbs vert.)
- No drilling required in truck frame
- Leaves truck bed free of hardware when not towing
- 10 degree side-to-side pivot with urethane cushions
- Adjustable height from 13" to 17"
- Automatic locking jaws
- Durable powder coated finish



A. Free Ride™ Fifth Wheel Hitch

There when you need it, not when you don't. Your truck bed is more than just a place for your Fifth Wheel hitch. That's why when you're not towing, the Free Ride removes completely, leaving your bed flat and clear.

Free Ride Fifth Wheel Hitch (Eaz-lift)

- 48600 Fifth Wheel Head Assembly, Fits All Models
- 48601 Fifth Wheel Hitch Base w/hdw, Wrench & Feet (Eaz-lift)

B&W Adapted Free Ride Fifth Wheel Hitch

- 48600 Fifth Wheel Head Assembly, Fits All Models
- 48602 Fifth Wheel Base w/Hdw & Wrench (B&W)
- 48519 Free Ride Stabilizing Feet (2) (B&W)



- 18,000 lb (4,500 lbs vert.)
- Adjustable fifth wheel height from 16.5" to 18.5"
- 10 degree side-to-side pivot with urethane cushions
- Removes easily and completely allowing full use of bed
- Easy to install—No drilling into your truck frame
- 9" Extra cab clearance for short bed trucks
- The world's most convenient short bed adjustable slider



B. Rail Rider™ Hitch The only slider that fits both fifth wheel and gooseneck trailers and leaves no rails behind. Compact, lightweight and durable Rail Rider is easy to install with no drilling into your truck frame. And it's easy to remove, leaving your truck bed completely free and clear. With Rail Rider's locking pin technology, backing your short bed truck has never been easier.

Rail Rider Fifth Wheel Slider Hitch

- 48600 Fifth Wheel Head Assembly, Fits All Models
- 48523 Rail Rider Slider Base w/Hardware (Eaz-lift)
- 48522 Rail Rider Fifth Wheel Base w/Slide Plate (Fits both Rail Rider models)
- 48525 Rail Rider Tailgate Stabilizing Foot

B&W Adapted Fifth Wheel Slider Hitch

- 48600 Fifth Wheel Head Assembly, Fits All Models
- 48524 Rail Rider Slider Base w/Hardware (B&W)
- 48522 Rail Rider Fifth Wheel Base w/Slide Plate (Fits both Rail Rider models)
- 48525 Rail Rider Tailgate Stabilizing Foot

Rail Rider Gooseneck Slider Hitch

- 48523 Rail Rider Slider Base w/Hardware (Eaz-lift)
- 48526 Gooseneck Ball Slide with Slide Plate and Safety Cables

B&W Adapted Gooseneck Slider Hitch

- 48524 Rail Rider Slider Base w/Hardware (B&W)
- 48526 Gooseneck Ball Slide with Slide Plate and Safety Cables

MAIN PLATE

HARDWARE/BRACKETS

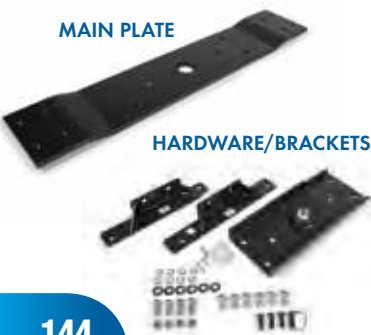

Free Ride/Rail Rider Hitch Install Kits

Kit for Dodge 1997 - 2002

- 48538 Main Plate for Installation Kit
- 48539 Mounting Brackets/Accessories

Kit for Dodge 2003 to 2014

- 48542 Main Plate for Installation Kit
- 48543 Mounting Brackets/Accessories

Kit for Dodge 3500 2013 to 2014

- 48552 Mounting Brackets/Accessories
- This Kit does not use a main plate/bed rail; it is integrated into the frame of 1 ton Dodge trucks.

Kit for Ford 1999 to 2010

- 48540 Main Plate for Installation Kit
- 48541 Mounting Brackets/Accessories

Kit for Ford 2011 to 2014

- 48546 Main Plate for Installation Kit
- 48547 Mounting Bracket/Accessories

Universal Kit for 34" Cab and Chassis (Fabrication Required)

- 48550 Main Plate for Installation Kit
- 48551 Mounting Brackets/Accessories

Kit for Chevy/GMC 2005 to 2010

- 48544 Main Plate for Installation Kit
- 48545 Mounting Brackets/Accessories

Kit for Chevy/GMC 2011 to 2014

- 48548 Main Plate for Installation Kit
- 48549 Mounting Brackets/Accessories



18K

5th Wheel Hitch



18KS

5th Wheel Hitch *Slider*

Eaz-Lift's 18K and 18KS Fifth Wheel Hitches

Eaz-Lift quality on a standard base-rail-style bracket system. The 18K-stationary- and 18KS-slider Fifth Wheel Hitches' universal design allows them to be mounted to any existing base rails or to Eaz-Lift's heavy-duty rails. Ideal for a truck with a short bed, the 18KS utilizes the slider system to avoid truck and trailer damage by allowing additional turning clearance.

- 48620 Fifth Wheel Head Crossmember & bolt pack
- 48621 Fifth Wheel Stationary Legs (set of 2)
- 48622 Fifth Wheel, Slider & bolt pack

- 48595 Adapter Kit, 4-Bolt Fifth Wheel, Dodge 1500 '09-'10, Bracket/Hdw
- 48594 Adapter Kit, 4-Bolt Fifth Wheel, Dodge 1500 '02-'08, Brackets
- 48593 Adapter Kit, 4-Bolt Fifth Wheel, Ford F-150 '04-'11, Bracket/Hdw
- 48592 Adapter Kit, 4-Bolt Fifth Wheel, Ford F-250/350/450, Brackets/Hdw
- 48591 Install Kit, 4-Bolt Fifth Wheel, Universal, Brackets/Hdw
- 48590 Install Kit, 4-Bolt Fifth Wheel, Universal, Brackets/Hdw/Bed Rail

18K and 18KS Features:

- Mounts to industry standard 4- and 10-bolt bed rails
- 11 degree side-to-side pivot w/urethane cushions
- 32 degree, front-to-back pivot
- Automatic locking jaws
- Durable, powder-coated finish
- 18,000 lb (4,500 lbs vertical)
- Secondary handle lock to ensure jaws have been locked closed

18K Stationary

- Adjustable height from 14.5" to 18"

18KS Slider

- Adjustable height from 17.5" to 21"
- Displaces hitch 9 inches toward tailgate for tight maneuvering
- Visible flag on each rail to show the slider has locked in either towing or maneuvering positions
- Secondary lock pin ensures primary locking mechanism is fully secured
- Fully enclosed rollers and locking mechanism to minimize debris build-up



18K
5th Wheel Hitch



NEW

NEW

18KS
5th Wheel Hitch *Slider*

18KS
5th Wheel Hitch *Slider*





Ready to Tow Hitch Kits

Pre-installed components save installation time

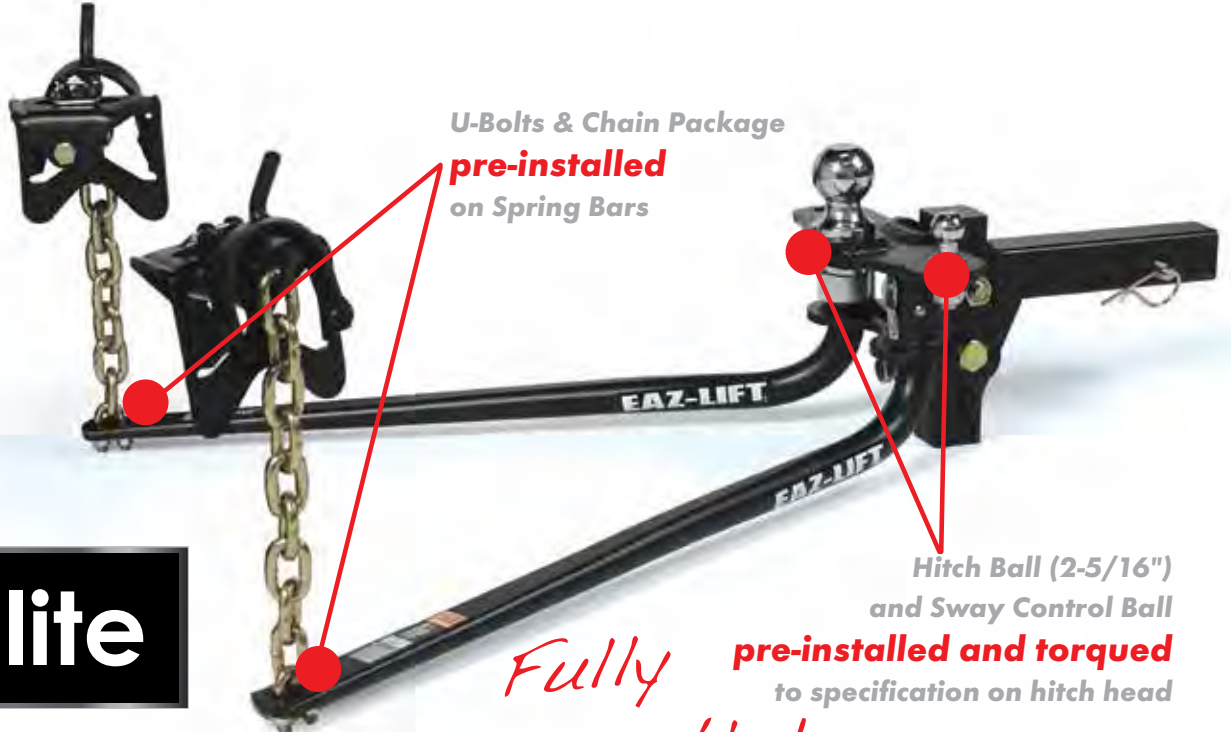

Fully Assembled



**Round Bar WDH
with Shank
+
SWAY CONTROL
+
Hitch Ball
=
Quicker Set-up**



Round Bar Weight Distributing Ready-to-Tow Hitch Kits

Part #	Description	Maximum Vertical Hitch Capacity	Maximum Gross Weight Rating
48056	Elite Hitch Kit	600 lb	10,000 lb
48057	Elite Hitch Kit	800 lb	10,000 lb
48058	Elite Hitch Kit	1000 lb	10,000 lb
48069	Elite Hitch Kit	1200 lb	12,000 lb

Do not overload any part of your towing system. Consult the vehicle manual for towing recommendations and limitations.

Hitch ball not included; sold separately. See page 135.

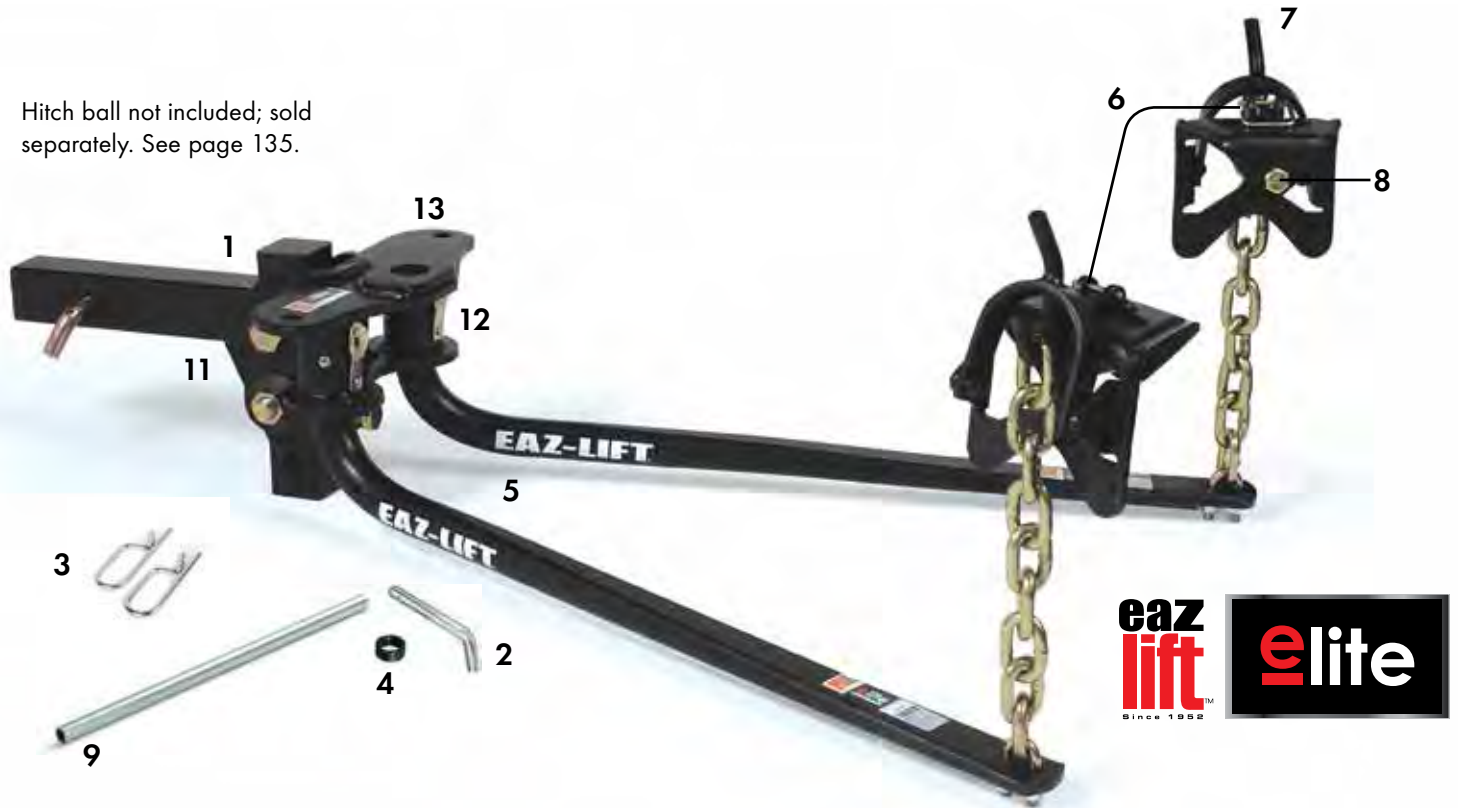

Round Bar Weight Distributing Hitches Over five decades ago, Eaz-lift became the first patented weight distributing system in North America. Designed with fewer parts, forge tapered round spring steel bars provide a smoother ride with interchangeable bars that have positive latching action for operation. Eaz-Lift has a broad selection of weight distributing hitches that include right and left hand sway control mounts and bolt together ball mounts providing adjustability of ball height and ball mount angle. Each hitch includes hook-up brackets, spring bars, chains, ball mount, shank and hitch pin, clip and bolt package for adjustable hitches.

Do not overload any part of your towing system. Consult the vehicle manual for towing recommendations and limitations.

Weight Distributing Hitches with bolt-together adjustable shank

Part #	Description	Maximum Vertical Hitch Capacity	Maximum Gross Weight Rating
48051	With Adjustable Ball Mount and Shank	600 lb	10,000 lb
48052	With Adjustable Ball Mount and Shank	800 lb	10,000 lb
48053	With Adjustable Ball Mount and Shank	1000 lb	10,000 lb
48059	With Adjustable Ball Mount and Shank	1200 lb	12,000 lb
48054	With Adjustable Ball Mount and Shank	1400 lb	14,000 lb

Weight Distributing Hitches bolt-together without shank

Part #	Description	Maximum Vertical Hitch Capacity	Maximum Gross Weight Rating
48061	With Adjustable Ball Mount	600 lb	10,000 lb
48062	With Adjustable Ball Mount	800 lb	10,000 lb
48063	With Adjustable Ball Mount	1000 lb	10,000 lb
48064	With Adjustable Ball Mount	1400 lb	14,000 lb

Replacement Parts

Part	Description
1	48081 Ball Mount, Adjustable for 2" square size shank (hitch bar) (600-800-1000-1200-1400 lb)
2	48021 Hitch Pin 5/8"
3	57527 Spring Clip
4	48023 Bushing 1-1/4" to 1"
5	48091 Spring Bar 600 Rating
	48092 Spring Bar 800 Rating
	48093 Spring Bar 1000 Rating
	48097 Spring Bar 1200 Rating
	48094 Spring Bar 1400 Rating
6	48028 Hook-Up Wire Clip for 48029
7	48029 Quick Hook-Up
8	48100 Set Screw (for Quick Hook-Up 48029)
9	48031 Hook-Up Handle (Comes w/Hitch)
10	48101 Bolt Package for Adjustable Ball Mount - 600-800-1000-1200-1400
11	48103 Set Screw for Adjustable Ball Mount 600-800-1000-1200-1400
12	48104 Spring Bar Locking Device Repair Kit Contains two each pins, retainers and screws
12	48113 Spring Bar Locking Device Repair Kit Contains one each pins, retainers and screws
13	48110 Elite Ball Mount Kit for 600,800,1000,1400

Why Eaz-Lift Sway Controls are better

than cam-action type sway controls:

- Eaz-Lift Sway Controls do not create noise problems as does the cam action type.
- Eaz-Lift Sway Controls do not reduce road clearance.
- Eaz-Lift Sway Controls are easily released when road conditions do not warrant their use...unlike cam action type sway controls that depend upon hitch weight to operate and cannot be released on icy and oily road conditions where straight line action would possibly impair driving control.
- Eaz-Lift Sway Controls do not lose sway control ability in turns.

Since 1952™



A

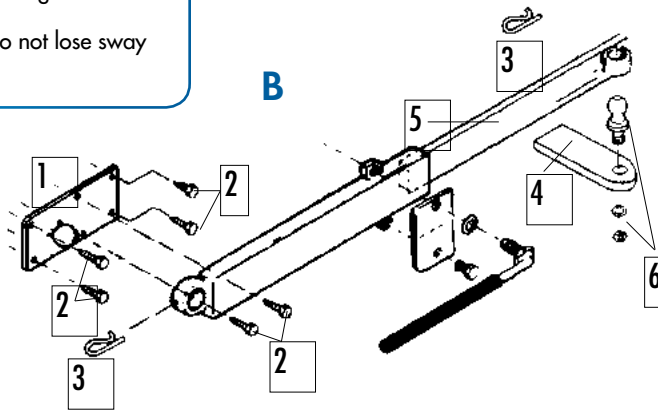

B

A. Eaz-Lift Sway Controls

minimize sway caused by passing trucks and sudden wind gusts, and they do not lose sway control ability in turns. Double friction pads provide constant sway abatement. Eaz-Lift Sway Controls attach with easy socket and spring clip connectors remove for easy storage. **NOT FOR USE ON TRAILERS WITH SURGE BRAKES.** Trailers over 25 feet long or smaller broad-sided trailers may require two Sway Controls. Use left hand Sway Control part number 48381.

- 48380** Screw-On Sway Control - Right-mounted passenger side
- 48381** Screw-On Sway Control - Left-mounted driver side (includes one 48390 Ball Mount Bar.)

B. Sway Control Parts Replacement parts for Eaz-Lift 48380 and 48381.

- 1 48388** Trailer Tongue Ball Plate
- 2 48389** Self Tap Screw 3/8" x 1 (6 pk)
- 2 48114** Self Tap Screw 3/8" x 1
- 3 57527** Spring Clip
- 4 48390** Ball Mount Bar
- 5 48391** Slide Bar 3/8" (48380 & 48381)
- 6 48404** Ball, Washer, Nut

C

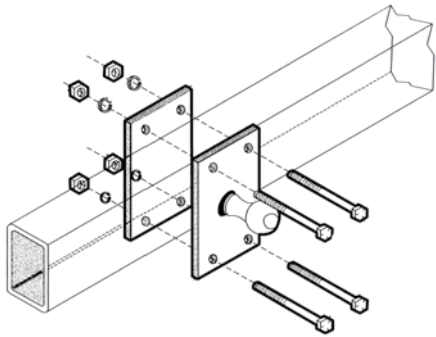

C. Clamp-on Sway Control Adapter

Bolt-together adapter with no-weld installation prevents damage to wiring enclosed in framework. May be used on right or left side of 2 x 3 inch "A-frame" trailers. **Not for use on trailers with surge brakes.**

- 48385** Sway Control Adapter 2" x 3" Clamp-on

D



D. Sway Control Adapter Bolt-together adapter fits most 2" ball mounts with 1" ball shank hole. Can be used on left or right side. Durable powder coat finish (Except on balls and utility ball mounts).

- 48386** Left or Right Ball Mount Adapter - 2"

A. Chrome-Plated Steel Hitch

Ball of solid, machined steel. To choose the correct hitch ball for your towing need, check the inside of your coupler and the desired length of the shank on the ball needed. Hitch balls are marked with size and rating; it is important to match coupler size with hitch ball size.

Part #	Ball Dia.	Shank Dia.	Shank Length	Gross Wt. Rating
48213	2-5/16"	1-1/4"	2-1/2"	10,000 lb

B. Ball Cover UV resistant cover protects ball from nicks and allows for storage of lubricant in top cover.

48231 2-3/8", 12/ctn

C. Bushing Variation in hitch ball holes requires bushings to adjust for the variation of hitch ball shanks.

48023 Reduces 1-1/4" to 1"

D. Chain Loop Safety chain for use with fabricated receiver and hitches. Small Loops for Class I and II. Large Loops for Class III and IV.

48180 Small

48181 Large

E. Combo Bar 2" x 2" x 1/4" wall with collared tube, used to create under-car receivers for vehicles where standard or frame hitches are not available. Can be bolted or welded to vehicles undercarriage. Sized and punched to fit all common weight distributing hitch ball mounts or utility ball mounts. *Wt. Dist. only with 24" to 48" combo bar when properly installed. Fits 2"x 2" receiver.

48170 6" Shank

48171 10" Shank

48172 12" Shank

*48173 24" Shank

*48174 36" Shank

*48175 48" Shank

F. Eaz-Lift™ Trailer Hitch Lubricant

Reduces friction and corrosion. Resistant to fresh and salt water. Will hold up through high temperatures. Will not oxidize or break down. Non-toxic.

44610 Trailer Hitch Lubricant

G. Grease Gun Perfect size for weight distribution hitches. Features adjustable nozzle to come out of the front or top. Includes lithium based grease designed for light duty application requiring long grease life. Can be conveniently reloaded with refill cartridges.

44616 Grease Gun

44619 2-pack replacement cartridge



Ball Mounts

Ball mounts are 2" x 2" and are used to convert a receiver from a weight distributing to a weight carrying hitch. Ball mounts create a ball platform for attaching a hitch ball. The ball mounts or utility hitch bar length are determined by measuring from the center of the pull pin to the center of the hitch ball hole. The drop or rise is determined by measuring from the top of the mount to the top of the tongue (See ball mount selection chart). All 2" x 2" ball mount shank holes are 1", except 48280 and 48282, which have a 3/4" hole. (DURABLE POWDER COAT FINISH)

A (Not reversible)

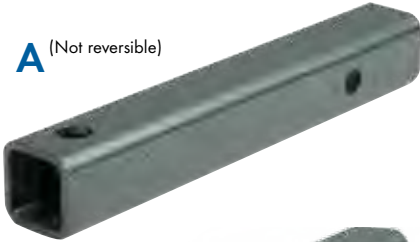

B



C



D



E



F



G



H



48386

Left & Right Sway Control Adapter
See page 148 for more information

Straight & Angle, Drop/Rise, Reversible Ball Mounts

Fits 2" X 2" Receiver, Rated MGTWR/MTW 6000/600 All ball mounts are unboxed. Hitch ball not included.

Style	Part #	Length	Drop	Lift
A*	48282	8-3/4"	-	-
B	48286	9"	2"	3/4"
	48290	13"	2"	3/4"
C	48292	9"	4"	2-3/4"
	48294	11"	4"	2-3/4"
D	48296	13"	4"	2-3/4"
	48298	9"	7"	5-3/4"
E	48300	11"	7"	5-3/4"
	48312	13"	2"	3/4"
F	48314	8"	2"	3/4"
	48324	10-1/2"	1-1/2"	1/4"
G	48326	10-1/2"	2"	3/4"
	48304	10-1/2"	3-1/4"	2"
H	48316	7"	3-1/4"	2"
	48306	11-1/2"	6"	4-3/4"
G	48318	9"	5-1/4"	4"
	48320	10-1/2"	5-1/4"	4"
H	48302	10"	8"	6-3/4"

*Rated MGTWR/MTW 3500/350—NOT REVERSIBLE



A. Adjustable Ball Mount Shanks

Used in either the up or down position to match the ball mount to any coupler height. Long hi/low shanks provide the extra length sometimes needed to obtain clearance from bumper interference. Fits 2"x 2" Receiver.

A1. Hi/Low Shank

2-1/2" Drop, 5-1/2" Rise

- 48120 12" Shank
- 48121 14" Shank
- 48122 16" Shank
- 48123 18" Shank

A2. Extra Hi/Low Shank

5-3/4" Drop, 8-3/4" Rise

- 48130 12" Shank (MOST POPULAR SELLER)
- 48131 14" Shank
- 48133 16" Shank

A3. Extra Low Shank 9-1/2" Drop
(BALL MOUNT AND SHANK TO BE USED IN THE LOW POSITION ONLY)

- 48132 12" Shank

B. Adjustable Utility Ball Mount and Shank

Ideal for those who have more than one trailer or tow vehicle. Rated for trailer weights up to 5,000 lb. and tongue weights up to 500 lb. Powder coat baked-on finish. 1" Ball Hole, 8-1/2" Drop, 7-1/4" Rise, Fits 2"x 2" receiver.

- 48270 14" Shank
- 48271 16" Shank
- 48272 18" Shank

C. Tri-ball Adjustable Hitch Kit

Includes Adjustable Hi/Low Ball Mount Shank (48120) and durable, forged hitch balls. Ball sizes: 1-7/8", 2", 2-5/16". Load capacity ratings: 1-7/8" ball-6,000 lb, 2" ball-7,500 lb, 2-5/16" ball-10,000 lb.

- 48461 Tri-Ball Adjustable Hitch Kit
- 48465 Tri-Ball Adjustable Hitch Kit with Hook (not shown)



A1



A2



A3



Extra Low Ball Mount and Shank to be used in low position ONLY

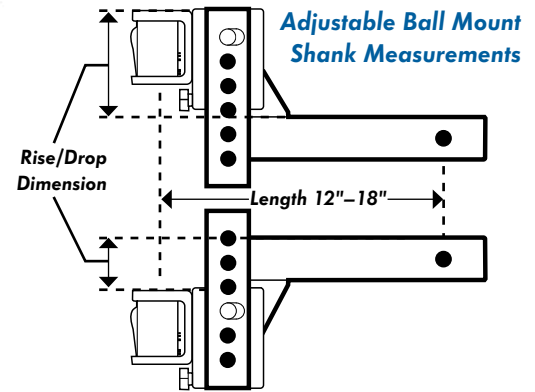

B

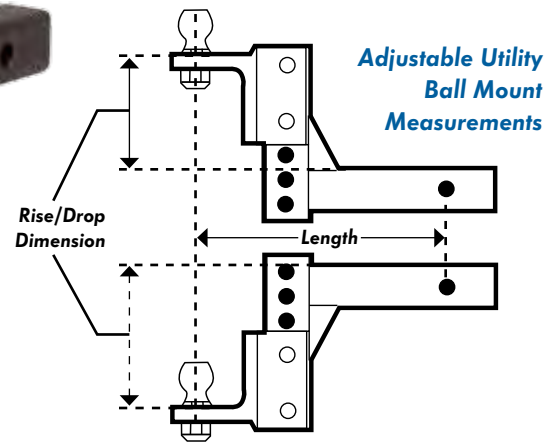

C



NOTE: THIS TOW BAR IS TO BE INSTALLED BY A PROFESSIONAL INSTALLER/FABRICATOR EXPERIENCED IN SELECTING VEHICLE ATTACHMENT AREAS WITH ADEQUATE STRENGTH.

Note: some vehicles require custom base plates.

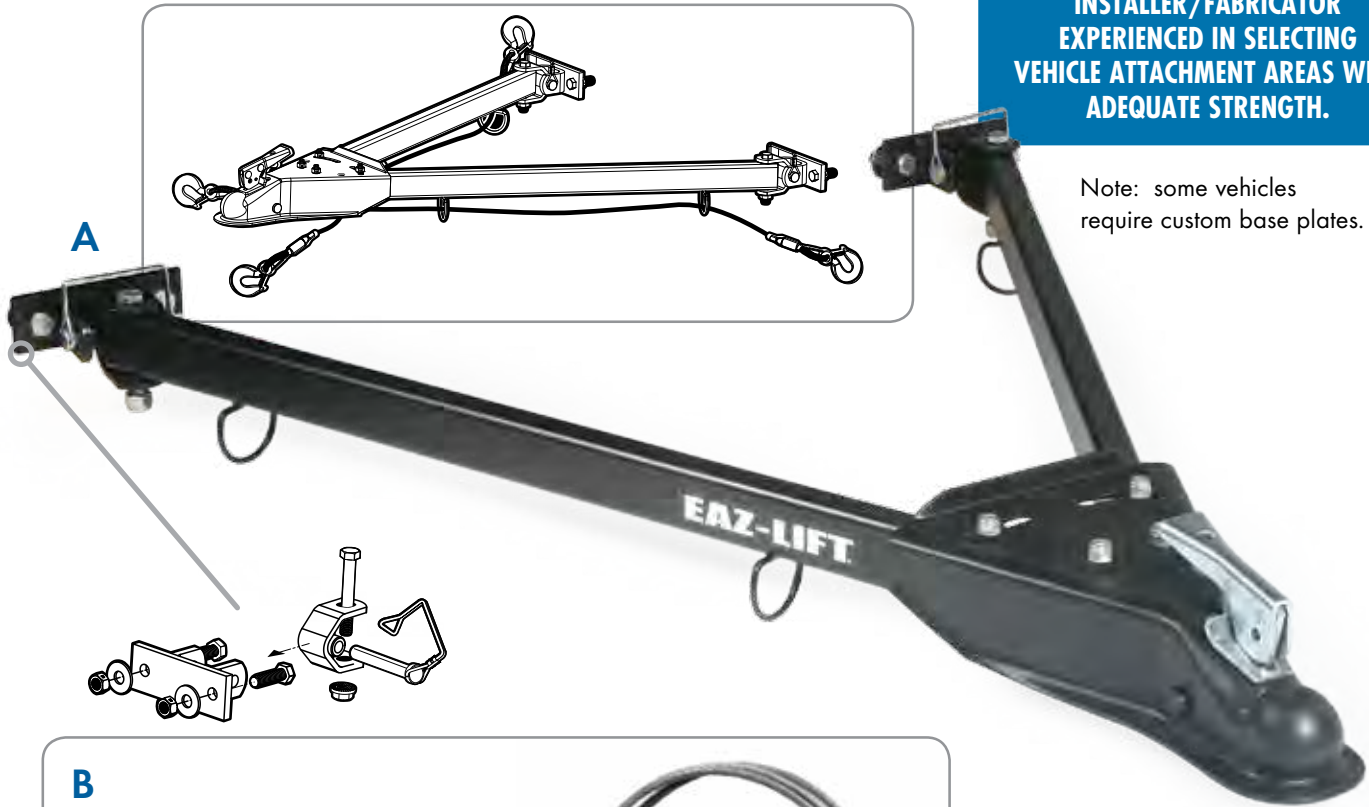

A. Tow Bar Rated at 5,000 lb GVW for towing pick-ups, cars and multi-purpose vehicles. Designed and constructed for universal fit, with adjustable arms that extend from 24" to 41". The Tow Bar comes with all zinc-plated hardware. The quick disconnect pull pins allow for easy removal and the collapsing side arms afford trunk storage. A 2" ball is required. The Tow Bar is boxed, completely assembled.

- 48350 Tow Bar without cables
- 48352 Tow Bar Kit with cables
- 48372 Tow Bar U-Joint Assembly

B. Tow Bar Safety Cables Tow safer with Eaz-Lift's Tow Bar Safety Cables. Corrosion resistant vinyl coated cables include heavy duty self-latching snap hooks that install quickly and hold securely. Includes two 6 foot cables. Tow Rating = 5000 lb.

- 48353 Tow Bar Safety Cables

C. 5th Wheel Lube Plates Cushions vibrations and helps protect your 5th Wheel against friction and wear. Constructed from high-density wear-resistant plastic. No drilling or tools required for installation.

- 44664 10"
- 44674 12"

Two-Conductor Jacketed Brake Wire

Specifications:

Two general purpose PVC insulated primary wires with bare copper conductors extruded side by side. Heavy plastic red jacket. Meets SAE J1128 standards. Rated at 80° C, 60 volts.



Package	Red Jacketed Wire	Grey Jacketed Wire		RV Red Jacketed Wire
	Color Coded Black and White	Color Coded Black and White		Color Coded Black and Blue
	14 Gage	12 Gage	10 Gage	12 Gage
100 ft Spool	64581	64587	64592	64597

Trailer Cable

Black PVC Jacket

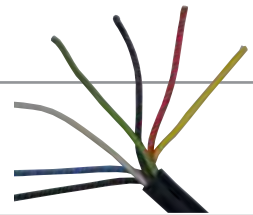

Package	7 Conductor	14 Gage		16 Gage	Multi-Gage - 7 Conductor	
	Diameter .60; Copper wires color coded: yellow, red, green, brown, black, white and blue.	6 Conductor	4 Conductor	6 Conductor	1-10, 6-12 Ga.	2-10, 1-12, 4-14 Ga.
		Diameter .520; Copper wires color coded: yellow, red, green, brown, black and white.	Diameter .44; Copper wires color coded: yellow, red, green and brown.	Diameter .44; Copper wires color coded: yellow, red, green, brown, black and white.	Diameter .69; Copper wires color coded: 1-10 ga-white, 6-12 ga - yellow, red, green, brown, blue and black.	Diameter .69; Copper wires color coded for RV: 2-10 ga-black and white, 1-12 ga-blue, 4-14 ga-yellow, red, green and brown.
25 ft Spool	64650	-	-	-	-	64673
50 ft Spool	64651	-	64661	-	64668	64674
100 ft Spool	64652	64658	64662	64665	64669	64675
250 ft Spool	64653	-	-	-	64670	64676
500 Bulk Reel	64654	64659	64663	64666	-	64677

Battery Cable

Polyvinyl chloride insulated with bare copper conductors. Made to meet SAE J1127 standards and is rated at 80° C. Resistant to abrasions, acids, and oil.

64685 25 ft Spool / 4-Gage Red



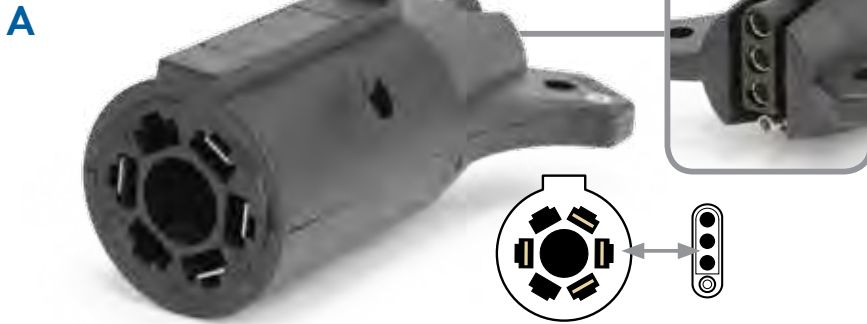
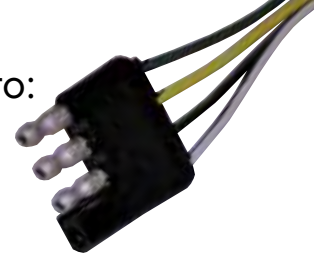

A. Trailer Adapter, Heavy Duty Blade 7-Way to 4-Way Flat Trailer Adapter 7-way male end plugs into your existing female end and converts it to a standard 4-way flat female connector.
64786 1-card

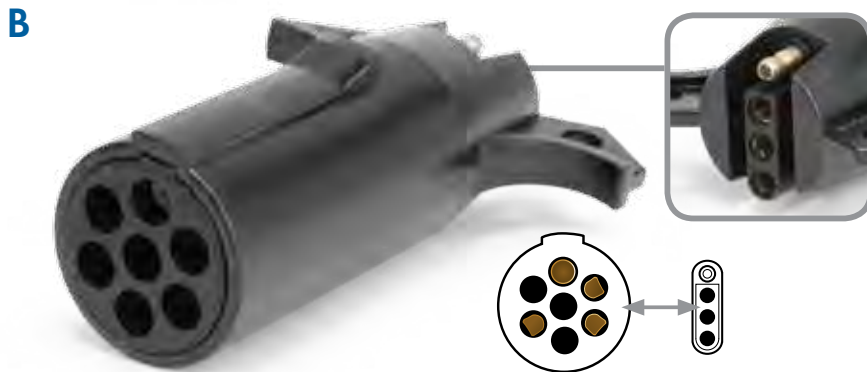

B. Trailer Adapter, Plastic 7-Way Round Pin to 4-Way Flat 7-way male end plugs into your existing female end and converts it to a standard 4-way flat female connector.
64788 1-card



C. Trailer Adapter, 6-Way Round Pin to 4-Way Flat 6-way male end plugs into your existing female end and converts it to a standard 4-way flat female connector.
64790 1-card

D. Frame Clips
65070 Small-3/16" ID, 1-card
65072 Medium-1/4" ID, 1-card
65074 Large-3/8" ID, 1-card



E. 7-Way RV Blade Hardware Kit Make your vehicle trailer-ready with this complete kit. Comes complete with pre-wired plastic 7-Way Trailer Connector bracket, circuit breakers, electrical connectors, wire, nuts, bolts, washer and even cable ties. Enjoy the convenience of having everything you need to finish the job right at your fingertips.
63938 7-Way RV Blade Hardware Kit

Trailer Connectors

A. Trailer Connectors, Complete

(Male and Female Ends), 12"

- A1 **2-Way, Flat** 18 ga wire, 12" long
64830 Bulk
64858 1/bag
- A2 **3-Way, Flat** 18 ga wire, 12" long
64831 Bulk
64859 1/bag
- A3 **4-Way, Flat** 18 ga wire, 12" long
64834 Bulk
64835 1/bag
- A4 **5-Way, Flat** 18 ga wire, 60" long
64855 Bulk
64856 1/bag
- A5 **6-Way, Square** 16 ga wire, 12" long
64833 Bulk
64860 1/bag

B. 4-Way Wishbone Trailer Harness

1/bag (Male/Plug)

- 64839 12-inch
- 64841 24-inch
- 64843 36-inch
- 64845 48-inch
- 64837 25-foot
- 64847 30-foot

C. 4-Way Tow Vehicle End

(Female/Socket)

- 64849 12" Pigtail, Bulk
- 64850 12" Pigtail, 1/bag
- 64852 48" Wishbone Harness, 1/bag
- 64853 60" Bonded Harness, Bulk
- 64854 60" Bonded Harness, 1/bag

D. 4-Way Trailer Test Light Trailer light problems are easily identified by plugging this tester into your existing car-end connector. Also helps to properly install a 4-way connector without a trailer attached.

- 64776 1/bag

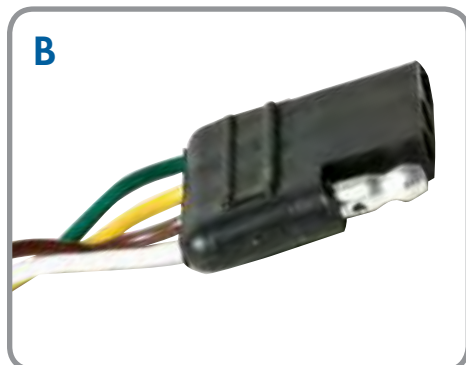
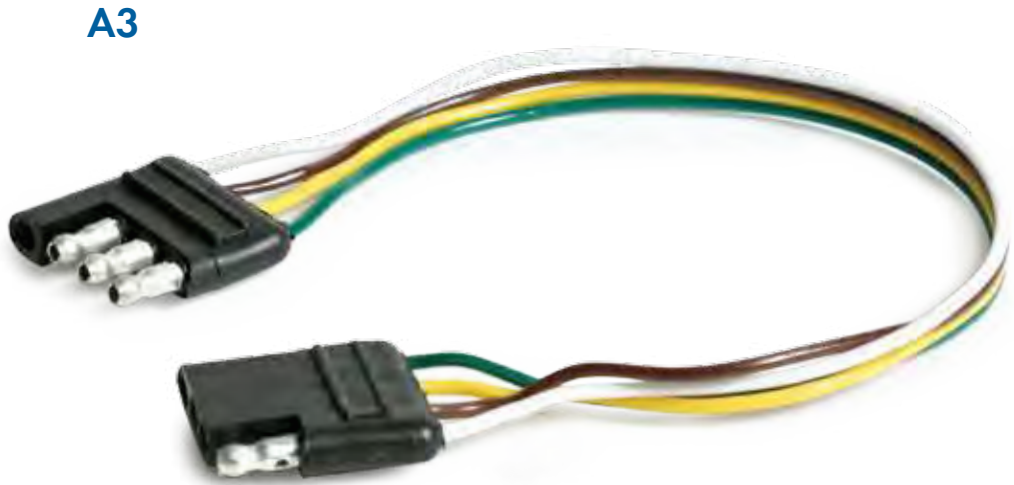

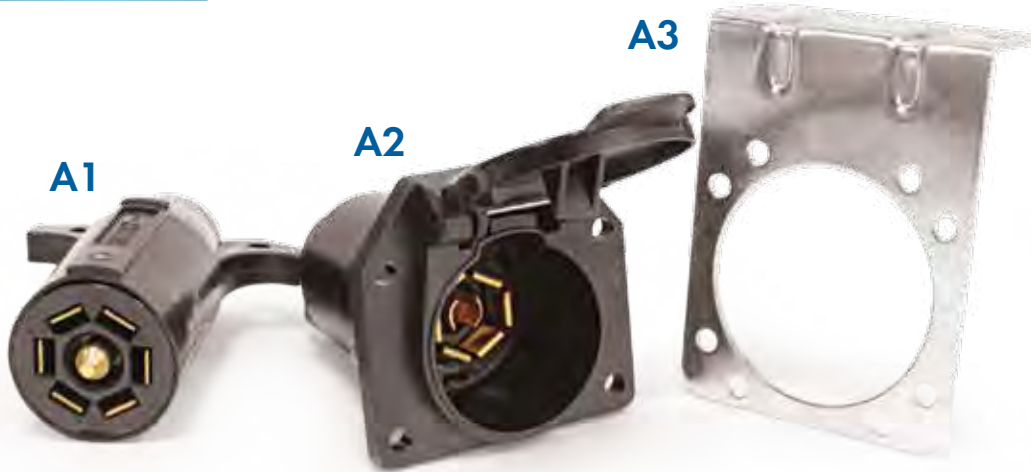

eaz lift
Since 1952

Trailer Connectors

A. 7-Way Plastic Blade-Type Connector Features dual grips for easy removal. Vinyl inserts keep out dirt and moisture. Safety latch prevents damage from accidental pull-away.

- A1 64815 Plug, Trailer-end - 1/card
- A2 64816 Socket, Car-end - Bulk
- 64817 Socket, Car-end - Boxed
- A3 64811 Mounting Bracket - Bulk



B. 7-Way Plastic Round Pin Connector Corrosion-proof glass-filled nylon. Easy alignment and maximum contact. Accepts 8 ga to 14 ga wire. Plug is waterproof when boot (64802) is added.

- B1 64820 Socket, Car-end - Bulk
- B2 64804 Mounting Bracket - Bulk



C. 6-Way Metal Connector Heavy duty die cast with rugged interiors. Unique cable clamp gives more support and saves installation time. Dust and water resistant. Interchangeable with Berg and Cole-Hersee.

- C1 64824 Plug Trailer End
- C2 64826 Socket Car End
- C3 64818 Mounting Bracket



D. 4-Way Metal Connector The industry's most popular 4-way connector. Polarized, chrome plated housing and spring-loaded cover.

- D1 64828 Plug Trailer End
- D2 64829 Socket Car End
- 64857 Complete (car & trailer ends)
- D3 64818 Mounting Bracket



A. Tow-N-See™ Power Mirror Extender Don't spend money on expensive aftermarket power mirror extensions. Tow-N-See Mirror moves along with your power mirrors so you can adjust your view while sitting in the driver's seat. Installs in just seconds with a twist of the knob, leaving no marks and making it easy to transfer from one vehicle to the next. *Tow-N-See...The one that works! Patented.*

25668 Convex
25663 Flat

B. Convex Blind Spot Mirror Can be installed on either side view mirror to help eliminate blind spots. 4" x 5.5"

25603 Convex Mirror

C. Convex Blind Spot Mirror Can be installed on either side view mirror to help eliminate blind spots. 3.75" Round.

25613 Convex Round Mirror

D. Wide Angle Blind Spot Mirror Can be installed on either side view mirror to help eliminate blind spots. 3.25" x 3.25"

25623 Wide Angle Mirror

E. 360° Blind Spot Mirror Wide angle mirror can be installed on either side-view mirror to help eliminate blind spots. Adjustable 360° mirror rotates for different driving positions. Large 3.75" diameter mirror effectively increases viewing angles.

25643 360° Blind Spot Mirror

F. Xtra View Mirror Can be mounted on top of driver's or passenger's side mirror to help eliminate blind spots. Patented.

25633 Xtra View Mirror

G. Blind Spot Mirrors Convex wide angle mirrors can be installed on rearview or side-view mirrors to help eliminate blind spots. Adjustable 360° mirror rotates for different driving positions. Large 2" diameter mirror surface effectively increases viewing angles.

25593 2/pack

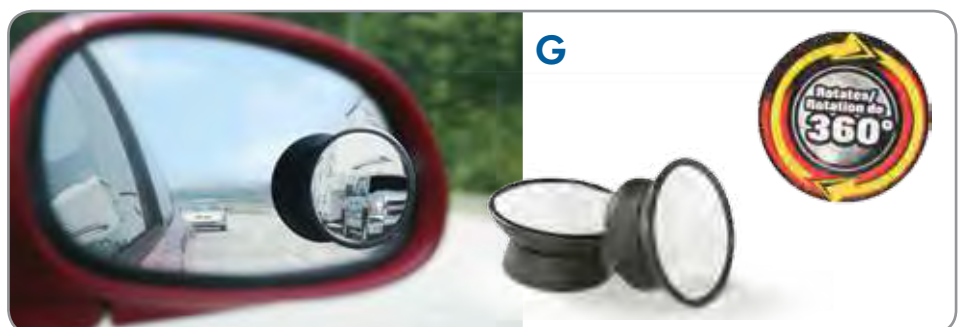
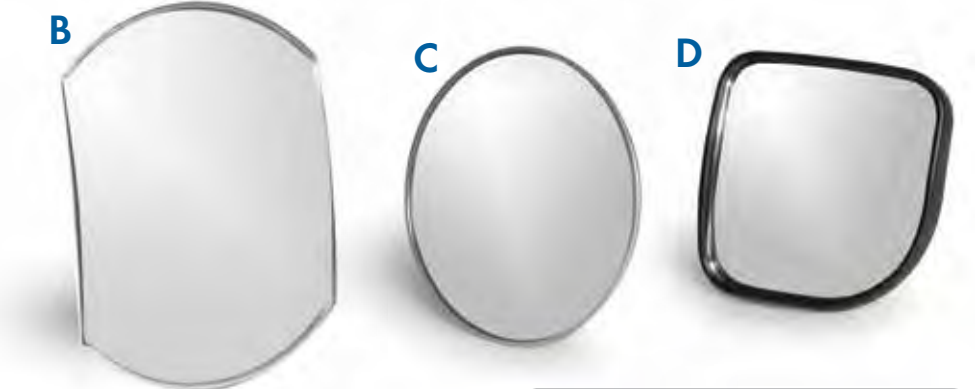

- 1** Drive your good tire onto the Trailer-Aid. This will lift your flat tire off the ground.



- 2** Remove your flat tire and mount your spare tire.



- 3** Drive off the Trailer-Aid and you're on your way.



Trailer-Aid® is a fast, safe, easy way to change your trailer's flat tire without having to unload your trailer.

A flat tire never happens at a good time, usually when you are by yourself on a busy highway, with a full trailer. Trailer-Aid® allows anyone to change a flat tire anywhere, anytime—without help, without a jack and without unloading.

Trailer-Aid® can withstand weights up to 15,000 lbs., and is waterproof and rustproof. Trailer-Aid® is made from a high-tech polymer which is both lightweight and strong as steel.

The front holes and rear slot allow for easy handling and access. Small and lightweight (only 5 lb), Trailer-Aid® stores easily and unobtrusively. It is light enough to be carried on the finger tips, and has clean edges that won't snag clothing or hurt your hands.

Trailer-Aid PLUS® is engineered specifically for recreational trailers. It gives your tire an extra 1" lift for performing maintenance on brakes, wheels and axles.

Both styles of Trailer-Aid come with a lifetime guarantee.



A. Trailer-Aid® Trailer-Aid is the fast, safe and easy way to change a trailer's flat tire. Made from lightweight super strong polymer, Trailer-Aid is easy to travel with and makes changing your trailer tire simple, even if you're alone.

- 21 Yellow
- 22 Black
- 01 Yellow - Bulk
- 02 Black - Bulk
- 44487 Yellow - bilingual package



B. Trailer-Aid® PLUS Trailer-Aid PLUS is designed specifically for recreational trailers and gives an additional 1" lift. The extra 1" lift makes Trailer-Aid PLUS handy when performing maintenance on brakes, wheels, and axles.

- 23 Yellow
- 24 Black
- 03 Yellow - Bulk
- 04 Black - Bulk



C. Trailer-Aid® Holder Secure your Trailer-Aid or Trailer-Aid RV with this metal holder. Designed to mount on the wall of your trailer

- 55 Trailer-Aid Holder

D. Tow Car Windshield Protector helps protect windshield from chips and cracks. Fast and easy installation and removal with no hardware required. Simply place vinyl cover on windshield, open doors, put end flaps inside car and close doors. Elastic cord holds cover firmly in place. Universal cover fits most windshields.

- 45401 Windshield Protector



E. Adjustable Sway Control

Diminishes sway from windy conditions or passing vehicles. Provides constant and adjustable sway reduction. Features dual brake pad system. Comes complete with slide bar, crank handle, spring clips, friction plate, ball tongue plate and chrome tongue ball. Detaches quickly for storage.

- 57521 Sway Control





Leveling & Stabilizing

Featured products:



Leveling Blocks
page 164



**Metal Locking
Wheel Stop™**
page 165



RV EZ Level
page 168

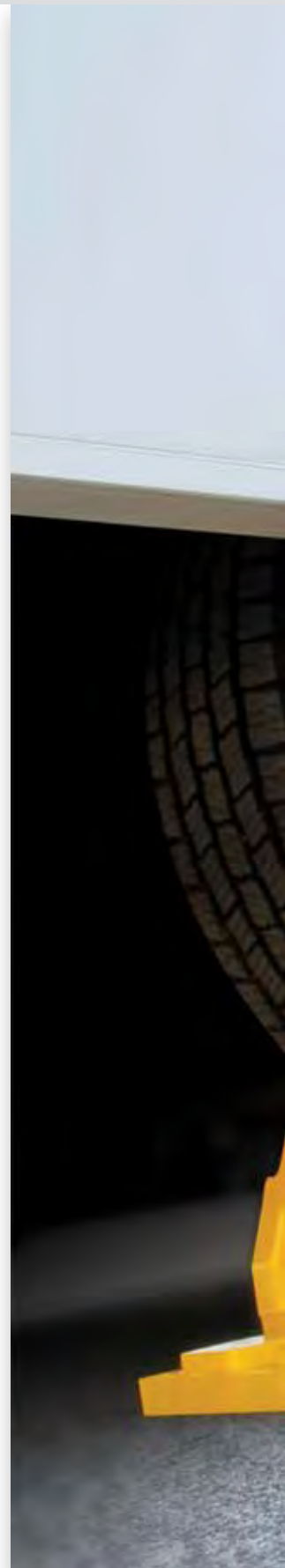

Jacks / Levels
Slide-Out Supports

Wheel Chocks
Stabilizers



Leveling & Stabilizing

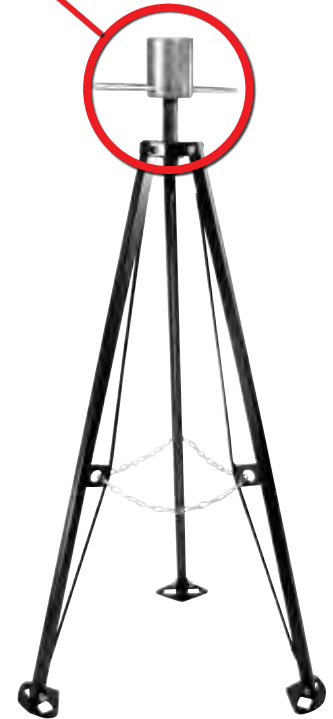

A. King Pin 5th Wheel Stabilizing Jack

Major height adjustments are made by simply moving the adjustable foot pads inward or outward; minor adjustments are made at the screw level with the provided stabilizing adjusting lever. Designed for use with 5th wheel trailers whose coaches have a king pin height of 39" to 50". Fully assembled with steel tube construction and zinc-plated chain. Lockable for added security. Designed to allow use of padlock to secure Stabilizing Jack to trailer. 5000 lb maximum load capacity.

57391 King Pin Stabilizing Jack

B. Gooseneck Stabilizer Jack

Reduces movement on trailer; works with horse trailers and 5th wheel trailers with gooseneck adapter installed. Heavy duty steel construction; powder coated for maximum rust protection. Features zinc-plated chain and large foot pads. Hooks up to Gooseneck Adapter (sold separately). Adjustable from 30 to 44 inches. Maximum load: 7500 lb.

57382 Gooseneck Stabilizer Jack

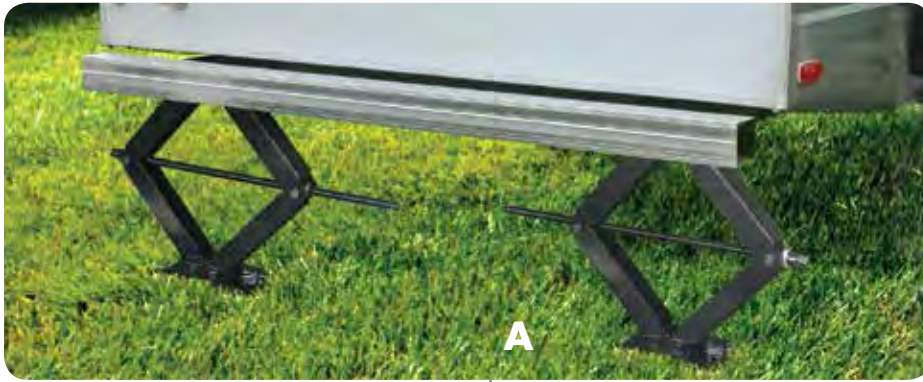

A. Leveling Scissor Jacks Fits pop-ups and trailers and allows for either bolt-on or weld-on installation. Powder coated for maximum rust protection. See listing below for load capacities.

- 48800 20" Scissor Jacks, 5000 lb, 2 pk
- 48810 24" Scissor Jacks, 5000 lb, 1 pk
- 48820 24" Scissor Jacks, 5000 lb, 2 pk
- 48830 24" Scissor Jacks, 7500 lb, 2 pk
- 48840 30" Scissor Jacks, 5000 lb, 2 pk
- 57874 Crank Handle



A1 57363 3/4" Scissor Jack Socket

B. Telescopic Stabilizing Jacks Zinc-plated inner tube and screw assembly. **Adjustable from 16" to 30"**. Sturdy steel construction, powder coated for maximum rust protection. 6000 lb load capacity. Set of 2.

57371 Telescopic Jack 2/pk

C. Stabilizing Trailer Jacks Features include a heavy duty non-corroding cast aluminum base with steel screw assembly and a permanent handle. **Adjustable from 11" to 17"**. 6000 lb load capacity.

- 44561 Aluminum jack stands-2/pk
- 44560 Aluminum jack stands-4/pk

D. Stabilizer Base Pads For use with most cross-frame or "T" type stabilizing jacks. Wide pad construction for greater stability. Installation hardware and anti-rattle rubber grommet included. Set of four.

57883 Stabilizer Base Pads 4/pk





A

A. Leveling Blocks Heavy duty blocks are safe and easy to use. They offer many options for leveling single wheels, dual wheels, hydraulic jacks, tongue jacks, stabilizer jacks, 5th wheel jacks and tandem axles. Customize your levels: Stack interlocking blocks to desired height. Strong and durable blocks are available in a ten-block set and a four-block build-up set. Patented.

- 44505 10-Block Set
- 44501 4-Block Set



B. Leveling Block Caps Securely join a single layer of Leveling Blocks, or create a flat surface on top of a larger stack.

- 44500 Leveling Block Caps - Set of 4

B

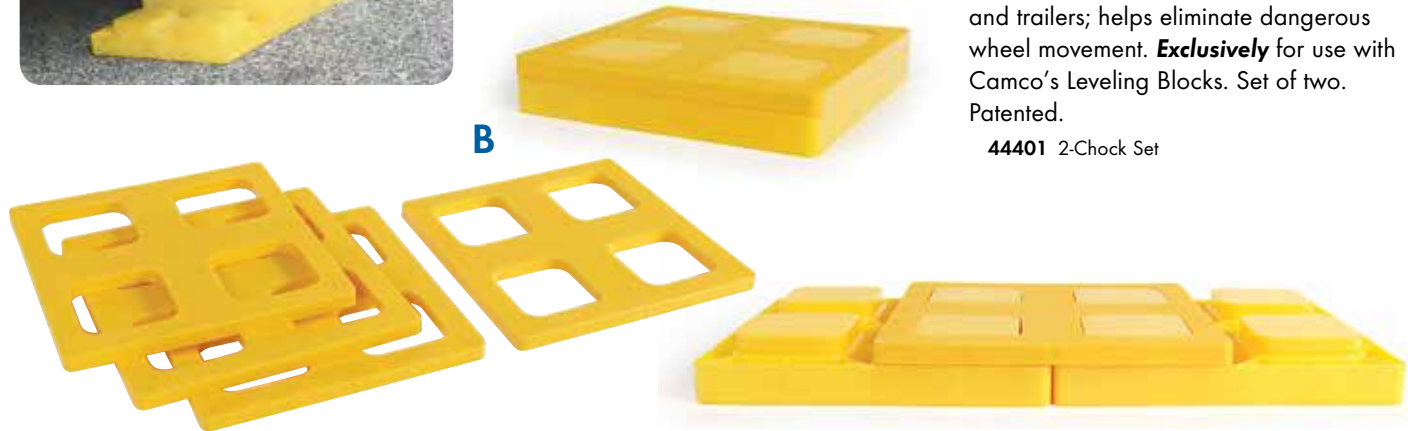

C. Leveling Block Wheel Chocks

Make stabilizing and centering wheels easier; connect to Camco's Leveling Blocks to level and chock simultaneously. Sized for larger vehicle wheels. Ideal for RVs, trucks and trailers; helps eliminate dangerous wheel movement. **Exclusively** for use with Camco's Leveling Blocks. Set of two. Patented.

- 44401 2-Chock Set

C



A. Metal Locking Wheel Stop with Wrench

Prevent tandem-tire shift using just one piece of equipment—Eaz-Lift's Premium Metal Wheel Stop. Zinc-plated for corrosion resistance, has raised ribs on the contact surface for increased traction which helps prevent tire shift/slippage between tandem tires spaced from 3-10 inches apart. It also includes a comfort-grip ratchet wrench for easy installation and a lock to keep it secure.

44662 Metal Locking Wheel Stop

B. Wheel Stop™ Stabilize your trailer with a single piece of equipment. Secure tandem tires to prevent movement while parked or re-hitching. Fits 26" to 30" diameter tires with tire spacing of 3-1/2" to 5-1/2" Patented.

44622 Wheel Stop

C. Small Wheel Stop™ A smaller version of the Wheel Stop, designed to fit 26" to 30" diameter tires with tire spacing of 1-1/2" to 3-1/2". Patented.

44652 Small Wheel Stop

D. Locking Wheel Stop™ with padlock Stabilize your trailer with a single piece of equipment. Secure tandem tires to prevent movement while parked or re-hitching. Locking model with padlock included. Fits 26" to 30" diameter tires with tire spacing of 3-1/2" to 5-1/2" Patented.

44642 Locking Wheel Stop

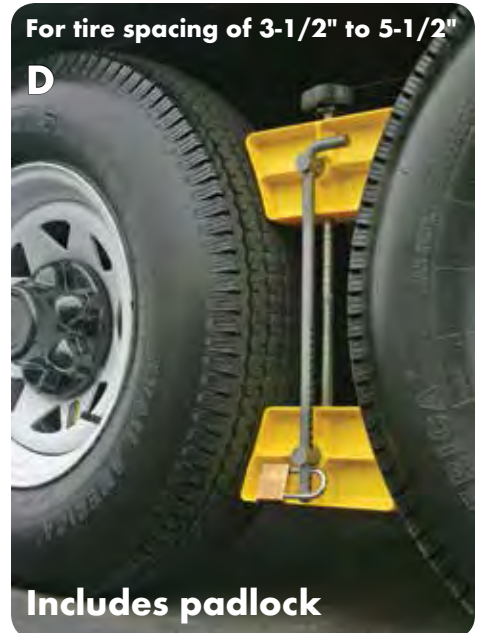
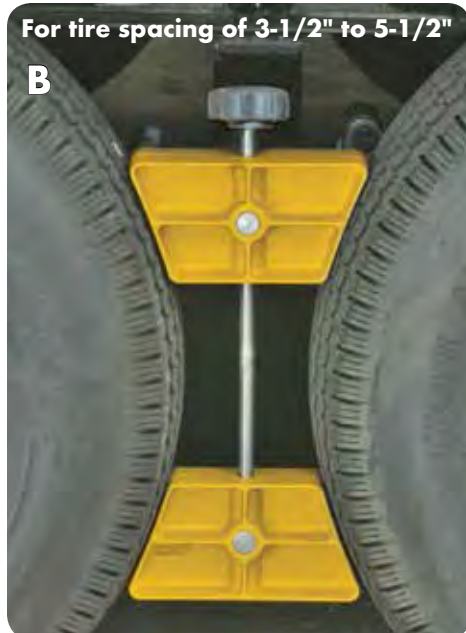



- One-person hook-up on the first try every time
- Guides extend to 50 inches for easy viewing
- Takes guesswork out of lining up your hitch
- Attach one guide to tow vehicle and one to trailer
- System works with virtually any tow vehicle and trailer

A

A. Magnetic Hitch Alignment Kit

Camco's Magnetic Hitch Alignment Kit is designed for one-person hook-up on the first try every time. Easily visible balls take the guesswork out of linking up your hitch. Attach one guide to the tow vehicle and one to the trailer. Guides extend to 50 inches for easy viewing, and a swivel base allows the guides to be positioned directly above hitch and receiver. This system works with virtually any tow vehicle and any trailer: gooseneck trailers, fifth wheel trailers, horse trailers and boat trailers.

44603 Hitch Alignment Kit

NEW





A. Tri-Leveler™ Raise your RV up to 3-7/8" on any tire for a more level position. Helps appliances and tanks operate more efficiently. Lightweight, durable resin has a non-slip surface. Each Tri-Leveler has a load capacity of 4000 pounds. Patented.

44573 Tri-Leveler

B. Stabilizer Jack Pads Specifically designed for use with stack jacks, fifth wheel stabilizers, swing down stabilizers and awning arms to keep them from sinking into soft ground. Interlocking for convenient storage with handy strap. Built-in handle for ease of use. Solidly constructed of durable polypropylene with UV inhibitors. Patented.

44595 small 6.2" x 6.2" pad, 4/pack

44541 large 14.0" x 1 1.7" pad, 2 pack



B

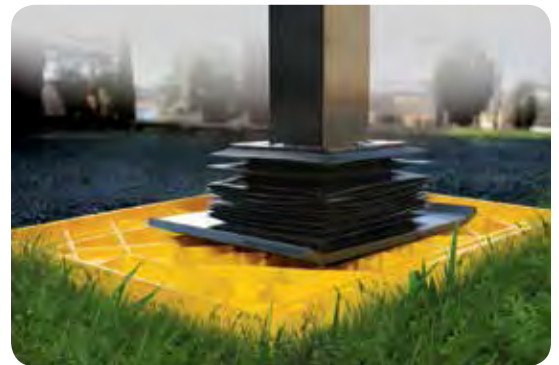

C. Super Wheel Chock Keep your vehicle and trailer from moving. Keep your trailer in place and re-hitch with confidence. Solidly constructed of durable polypropylene with UV inhibitors.

44492 Super Wheel Chock



D. Wheel Chock Chocks keep your trailer in place so you can re-hitch with confidence. Solidly constructed of durable hard plastic with UV inhibitors. Also sold with rope for convenient placement and removal from the wheel.

44412 6/ctn

44432 36/ctn

44472 Wheel Chock with rope



E. Wheel Dock™ Prevent your trailer tongue wheel from rolling on the pavement or sinking into soft ground. Heavy duty, durable dock is easy to store and transport.

44632 Wheel Dock



D



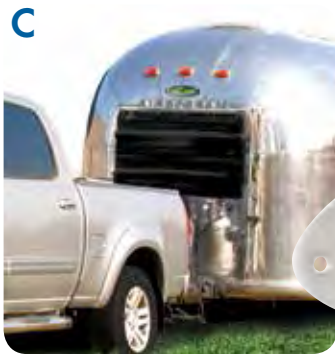

A. RV EzLevel™ Just place our new factory-calibrated RV EzLevel in the center of the RV for fast, accurate and easy leveling of the entire RV, ensuring not only a level refrigerator but a good night's sleep. Built with solid state electronics to level both axes simultaneously. Easy to stow. Batteries included.

25505 RV EzLevel

B. AccuLevel™ Mounts with screws to the front of the trailer and can be seen in mirrors. Large ball indicates side-to-side leveling, with second level for front-to-back. Brackets for mounting to fifth wheel pin boxes sold separately.

25563 AccuLevel™

25583 Brackets for AccuLevel™

C. Trailer Level Mounts with screws to the front of the trailer and can be seen in mirrors. Large ball indicates side-to-side leveling, with second level for front-to-back. Lightweight plastic construction. Patented.

25533 Trailer Level

D. Precision Curved Ball Levels

Screw-mountable level has graduated markings for accurate leveling.

25553 2/card

E. Bullseye Level Round domed level reads 360° at once.

25573 1/card

F. Standard Levels Screw-mounted level for front-to-back or side-to-side leveling.

25523 2/card

G. Utility Trailer Levels Mount with screws or self-adhesive tape. Graduated markings help you to determine how much to adjust your vehicle. Patented.

25503 Utility Trailer Levels - 2/card

H. T Level Screw-mounted level provides front-to-back and side-to-side leveling.

25543 1/card

A. Slideout Supports Sturdy, lightweight, reliable. Spring loaded to absorb shock. Clamping ring with handle allows easy installation and adjustment. Self adjusting foot for all terrains. Black powder coated to inhibit rust. Standard adjusts from 23" to 35". Large adjusts from 30" to 50".

44681 Slideout Supports, Standard

44691 Slideout Supports, Large

B. Adjustable Stabilizer 6" x 6" HD Use under front or rear of trailer for greater stability. Large reinforced base for better ground contact. 5000 lb capacity. Adjusts from 9 to 14 inches.

44531 Adjustable Stabilizer

C. Sav-A-Step Brace Place under RV entry steps for safety. Stabilizes steps and helps keep the coach from rocking. Helps prevent sag and wear. Heavy-gauge steel with a 3/4 inch solid metal screw thread. 1000 lb limit.

43681 4 $\frac{5}{8}$ "-8"

43691 7 $\frac{5}{8}$ "-14"

D. Self-Stor Step Support Mount under RV entry steps for safety. Swings up and stores securely under RV Step. Stabilizes steps and helps keep the coach from rocking. Helps prevent sag and wear. Heavy-gauge steel with a 3/4 inch solid metal screw thread. 1000 lb limit.

43671 Self-Stor Step Support





Electrical

Featured products:



**Power Grip
Dogbone Adapters**
page 172



Power Defenders
page 178



**Energy-Saving
LED Light Bulbs**
page 179



Power Grip™
Cords and Plugs

Bulbs
Solderless Connectors



Electrical

171

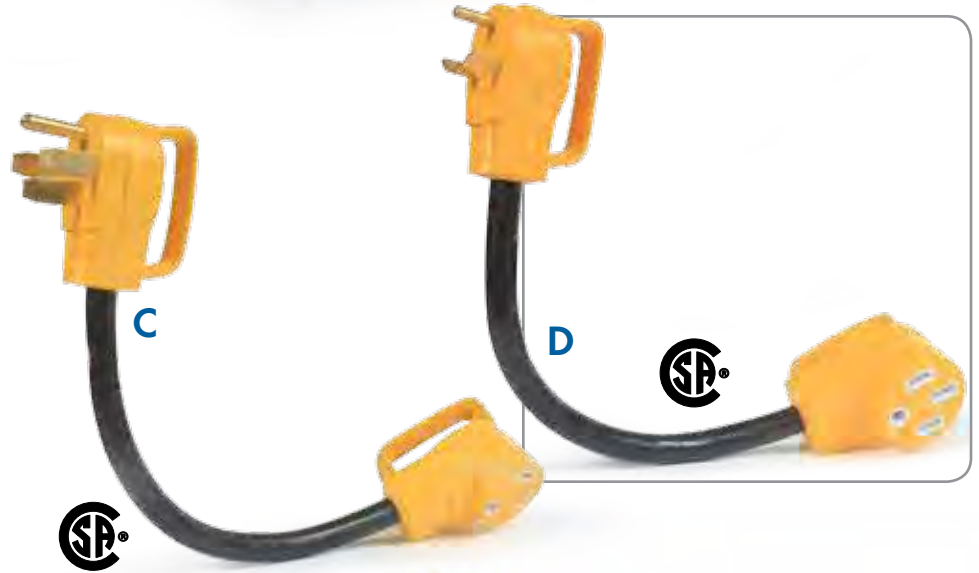
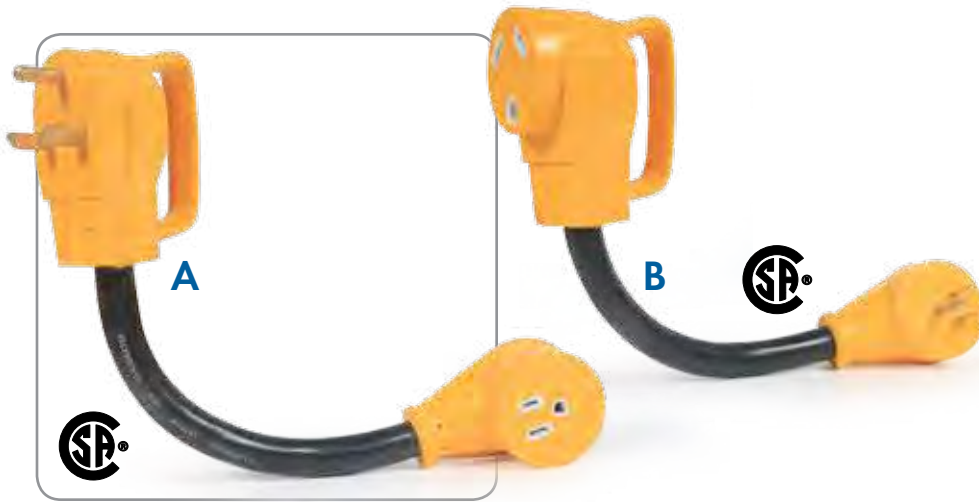

Patented

Power Grip™ Dogbone Adapters with handles

A. 30 Amp Male to 15 Amp Female
125V-1875W - TT-30P/5-15R

55155 30 Amp Male to 15 Amp Female

B. 15 Amp Male to 30 Amp Female
125V-1875W - TT-30P/TT-30R

55165 15 Amp Male to 30 Amp Female

C. 50 Amp Male to 30 Amp Female
125V-3750W - 14-50P/TT-30R

55175 50 Amp Male to 30 Amp Female

D. 30 Amp Male to 50 Amp Female
125V-3750W - TT30P/14-50R

55185 30 Amp Male to 50 Amp Female

E. 15 Amp Male to 50 Amp Female
125V-1875W - 5-15P/14-50R

55168 15 Amp Male to 50 Amp Female

Power Grip™ Electrical Adapters with contoured shape for easy removal from outlet.

F. 15 Amp Male to 30 Amp Female
125V-1875W - 5-15P/TT-30R.

55223 15 Amp Male to 30 Amp Female

55222 15 to 30 - Bulk

G. 30 Amp Male to 15 Amp Female
125V-1875W - TT-30P/5-15R

55233 30 Amp Male to 15 amp Female

55232 30 to 15 - Bulk

H. 15 Amp Male to 30 Amp Female — 90° 125V-1875W - 5-15P/TT-30R.

55325 15 Amp Male to 30 Amp Female



Patented

A. Power Maximizer™ Get up to 45 amps combined power. When connecting to your RV's 50 Amp power cord, don't be limited to just 15 or 30 amps. Camco's Power Grip™ Power Maximizer draws the combined power from a 15- and a 30-amp outlet, which allows your RV to receive up to 45 amps. Will not work when plugged into GFI type outlets and must be used in conjunction with properly sized circuit breakers. Patented. TT-30P + 5-15P/14-50R

55025 Power Maximizer

B. Power Grip™ Extenders Connect extenders to your RV power cord and enjoy the ease and convenience of our Power Grip™ handles when connecting to a matching amperage outlet box. Extenders are 18" long. Patented.

B1 55205 30 amp Extender - TT-30P/TT-30R

B2 55215 50 amp Extender - 14-50P/14-50R





A

A

55272
3-prong for L5-30
Locking Plug

55382
4-prong for L14-30
Locking Plug



B

A. Power Grip Generator Adapter—30 Amp Dogbones

12" adapters for connecting a generator with a L5-30 or L14-30 locking plug receptacle to a recreational vehicle that uses a standard RV cord set (TT-30) to connect to 120V AC shore power. 125V/3750W. Patented.

- 55272 3-prong for L5-30 Locking
- 55382 4-prong for L14-30 Locking

B. Power Grip Generator Adapter—30 to 50 Amp Dogbones

12" adapters for connecting a generator with a L5-30 or L14-30 locking plug receptacle to a recreational vehicle that uses a standard RV cord set (14-50) to connect to 120V AC shore power. 125V/3750W. Patented.

- 55412 3-prong for L5-30 Locking Plug
- 55422 4-prong for L14-30 Locking Plug



C

C. Power Grip Generator Adapter

For connecting a generator with a L5-30 or L14-30 locking plug receptacle to a recreational vehicle that uses a standard RV cord set (TT-30) to connect to 120V AC shore power. Patented.

- Comfort grip with non-slip grooves
- One-piece heavy duty construction
- 55333 3-Prong Generator Adapter
- 55338 4-Prong Generator Adapter



D

D. Power Grip Y Generator Adapters

Adapt 30 amp generator plug receptacles to two 15 Amp receptacles. Models available for 3 and 4 prong 30-amp generator plug receptacles.

- 55433 3 Prong - L5-30/5-15(2)
- 55438 4 Prong L14-30/ 5-15(2)



A. Power Grip™ Extension Cords with handles 50- or 30-amp styles. All cords feature the patented Power Grip handles for ease of use. Each cord also includes a convenient carrying strap. Patented.

- A1 **55191** 30 amp - 25 feet 125V-3750W 10 Ga grounded STW - TT30P/TT-30R
- A2 **55197** 30 amp - 50 feet 125V/3750W 10 Ga, grounded STW - TT30P/TT-30R
- A3 **55194** 50 amp - 15 feet - 125-250V/12500W 6/8 Ga 14-50P/14-50R
- A4 **55195** 50 amp - 30 feet 125V/250V 12500W 6/3 + 8/1 STW - 14-50P/14-50R

B. Electrical Cord Storage Handle
Carry and store power cords easily. Keeps your power cord neatly coiled, and makes it easier to carry.

55001 Cord Storage Handle

C. RV Outdoor 30'/15 Amp Extension Cord For RV, mobile home and household use. Heavy-duty. 14-Gage wire construction. Polarized cord set with ground. 15 Amps / 125 Volts /1875W stw jacket. 5-15P/5-15R.

- 55142** 30-ft Extension Cord
- 55143** 50-ft Extension Cord (not shown)





A1



A2



A. Locking Electrical Adapters

For hooking your marine-style 30- or 50-Amp RV power inlet to a standard power source. Threaded locking ring helps to create a weatherproof connection. Patented.

A1 55501 30 F Locking/M Std Power Grip, 25' TT-30P/L5-30R

A2 55512 30 F Locking/M Std Power Grip, 18" TT-30P/L5-30R

A3 55542 50 F Locking/M Std Power Grip, 25' 14-50P/SS2-50R

A4 55552 50 F Locking/M Std Power Grip, 18" 14-50P/SS2-50R

A3



A4



B. 90° Locking Electrical Adapters

For hooking your marine-style 30- or 50-Amp RV power inlet to a standard power source. 90° connector reduces strain on the cord and allows easier connection in tight places. Threaded locking ring helps to create a weatherproof connection. Patented and patent pending.

B1 55522 30 F Locking/M Std Power Grip, 18", 90° TT-30P/L5-30R

B2 55562 50 F Locking/M Std Power Grip, 18", 90° 14-50P/SS2-50R

B1



B2

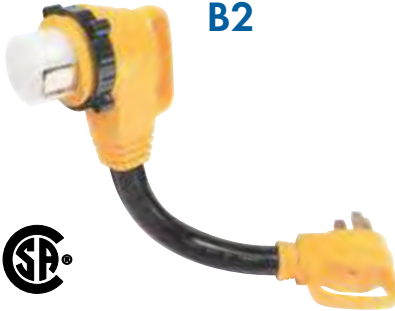

C. 90° Locking Electrical Cords

For hooking your marine-style 30- or 50-Amp RV power inlet to a marine-style power source. 90° connector reduces strain on the cord and allows easier connection in tight places. Threaded locking ring helps to create a weatherproof connection. Patent pending.

C1 55532 30 F/M Locking Adapter, 18", 90° L5-30P/L5-30R

C2 55572 50 F/M Locking Adapter, 18", 90° SS2-50P/SS2-50R

C1



C2



D. 90° 30A/50A Locking Adapter

For hooking your marine-style 50-Amp RV power inlet to a standard 30-Amp power source. 90° head reduces strain on the RV connection and allows easier connection in tight places. Simply lock the 50-Amp head onto the power inlet of the RV and connect the 30-Amp plug to a standard 30-Amp power cord. Threaded locking ring helps to create a weatherproof connection. Patented.

55582 Adapter - TT-30P/SS2-50R

D



E



E. Replacement Locking Rings

For use with Power Grip Locking Adapters to help protect against moisture.

55537 Replacement Locking Ring, 30 A

55577 Replacement Locking Ring, 50 A

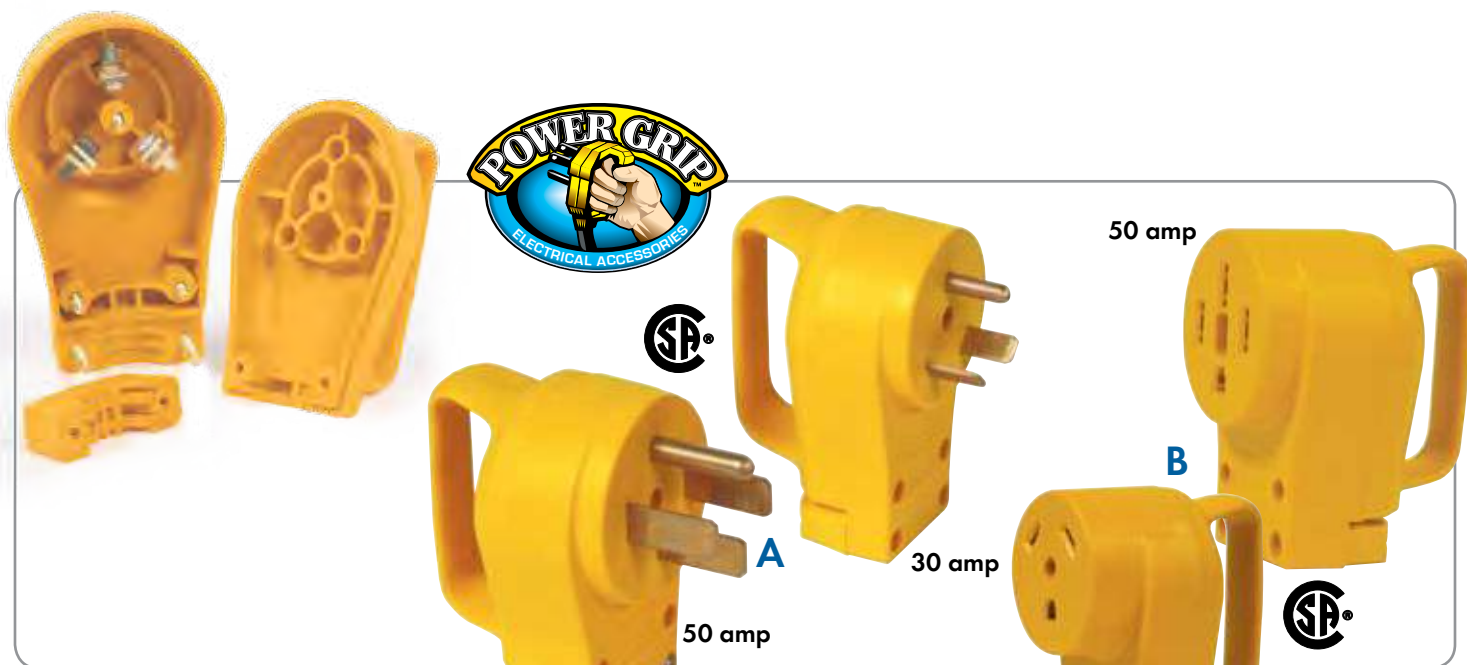

Power Grip™ Replacement Plugs and Receptacles

Replace your power cord plugs and receptacles using the Power Grip™ replacements with handle for ease of use.

A. Replacement Plugs Patented

- 55245 30 amp - TT-30P
- 55242 30 amp - TT-30P
- 55255 50 amp - 14-50P
- 55252 50 amp - 14-50P

B. Replacement Receptacles Patented.

- 55343 30 amp - TT-30R
- 55353 50 amp - 14-50R

C. 30 AMP Mini Power Grip™ Plug

Replacement plug fits completely inside RV's cord cable hatch, so door can be closed during travel. Sturdy handle makes it easy to remove plug from power outlet. Patented.

- 55283 30 Amp Mini - TT-30P

D. 120 Volt Line Monitor Designed to plug into any 120V wall receptacle and provide a continuous, accurate reading of the AC line voltage.

- 55263 120V Line Monitor - 5-15P

E. Standard Replacement Plug

- 55132 30 Amp, 125V-3750W - TT-30P

F. Power Grip™ Electrical Protectant & Lube Use on any electrical connector to improve conductivity and protect from oxidation. Also helps make connectors easier to insert and remove. Perfect for use with Camco's Power Grip™ Adapters and Extension Cords.

- 55013 Electrical Protectant & Lube

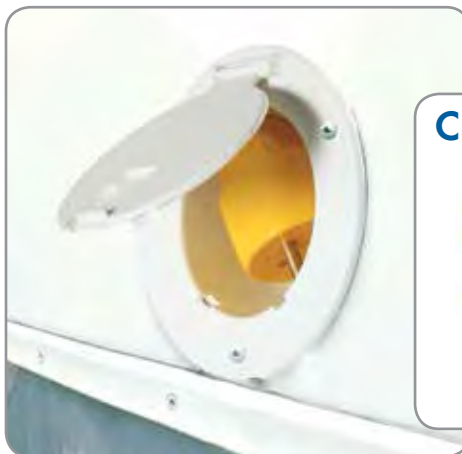



A

NEW

A. Power Defender™ with PowerGrip™ handles

Helps protect your RV from damaging low/high voltage levels and power spikes and surges. Camco's Power Guardians monitor incoming power, automatically disconnecting it when dangerous voltage levels are detected and automatically reconnecting once it stabilizes between 102-132 VAC. Reconnect Delay protects sensitive equipment, such as AC units, by not rapidly cycling power. Includes diagnostic lights for visual indication of faults. Water resistant unit incorporates integrated multilevel surge protection and diagnostic lights for visual indication of faults. Available in 30 and 50 AMP.

- 55301 30 Amp
- 55306 50 Amp



B

NEW

B. 30 Amp Circuit Analyzer

Help protect your RV from improperly wired electrical boxes. Diagnostic lights indicate faults before you connect your electrical cord. Also includes integrated surge protection.

- 55310 Circuit Analyzer



C

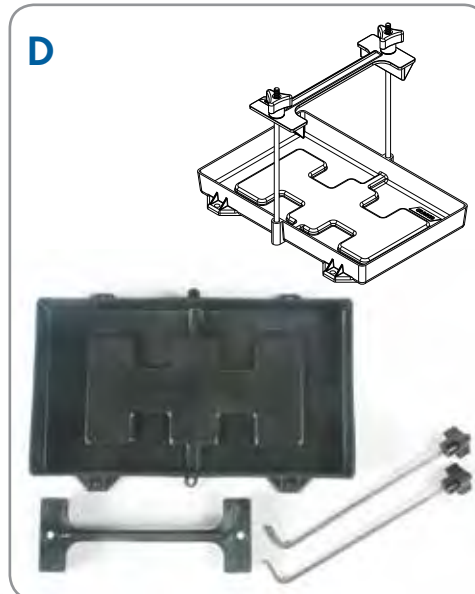

D

C. Battery Boxes Lightweight, heavy-duty, corrosion-resistant polypropylene boxes are designed to secure and protect your battery. Both sizes include lift-off lid, durable woven hold-down strap, foot clamps and stainless steel screws. Choose small for group size 24 batteries or large for group sizes 27, 30 and 31. Both boxes meet USCG CFR 183.420 and ABYC E-010.7 specifications. Inside dimensions with lid (l x w x h) Small: 11.33" x 7.84" x 9.9"; Large: 13.87" x 7.87" x 10.9". Patented.

- 55362 Standard
- 55372 Large
- 55364 Replacement Strap

D. Battery Hold-Down Trays

Made from heavy duty acid resistant plastic with stainless steel hardware. Meets USCG CFR 183.420 and ABYC E-10.7 specifications. Patented.

- 55394 Standard
- 55404 Large



E

CSA
US

E. Replacement Dome Lights

12V replacement dome lights in double or single style. Double light measures 12" x 4.25" x 1.5" (l x w x h). Single light measures 7" x 4.25" x 1.5" (l x w x h). Instructions and bulbs included.

- 41320 Double Replacement Dome Light
- 41330 Single Replacement Dome Light

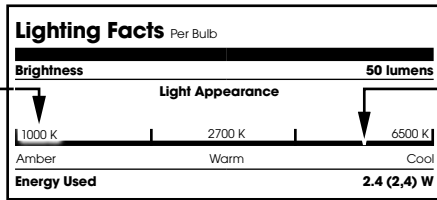

Amber Bulbs
1000 K-
1500 K

Clear and
Frosted Bulbs
4000 K-
4500 K

Energy-Saving RV/Marine LED Bulbs Long-lasting, energy-saving 12-Volt LED bulbs for RV and Marine use. Color temperature for clear and frosted bulbs is 4000-4500 K. Color temperature for the Amber bulb(54618) is 1,000-1,5000 K.

Part #	Description	Lumens	Watts	Qty
--------	-------------	--------	-------	-----

A. Replaces: 1003, 1073, 1093, 1141, 1156, 1159, 1295, 3497, 5007, 5008, 7506, 7527

Base: BA15s - Single Contact Bayonet

54600	1003/1093-LED Swivel, w/White Housing	150	1.9	1 pk
54602	1003/1093-LED Swivel, w/Black Housing	150	1.9	1 pk
54604	1141-LED Swivel, w/White Housing	200	2.4	1 pk
54606	1141-LED Swivel, w/Black Housing	200	2.4	1 pk
54608	1156/1073-LED Swivel, Frosted Lens, w/White Housing	180	3.6	1 pk
54610	1156/1073-LED Swivel, w/White Housing	230	3.6	1 pk
54612	1156/1073-LED Swivel, w/Black Housing	230	3.6	1 pk

B. Replaces: 93, 1003, 1073, 1093, 1141, 1156, 1159, 1295, 3497, 5007, 5008, 7506, 7527 **Base:** BA15s - Single Contact Bayonet

54614	5008-LED	170	1.4	2 pk
-------	----------	-----	-----	------

C. Replaces: 1383 **Base:** BA15s - Single Contact Bayonet

54616	1383-LED	150	2.4	1 pk
54618	1383A-LED, Amber	50	2.4	1 pk

D. Replaces: 516, 579, 904, 906, 912, 916, 917, 918, 920, 921, 922, 923

Base: W2.1 X 9.5d - Wedge

54620	912-LED, Frosted Lens	100	2.4	1 pk
54622	921-LED, Frosted Lens	200	3.8	1 pk

E. Replaces: G4 Bulb **Base:** G4 - Bi-pin

54624	G4-LED	160	1.1	1 pk
54626	G4-LED	205	2.2	1 pk

F. Replaces: Fluorescent Bulb **Base:** T5-Fluorescent / T8-Fluorescent

54628	T5-LED, 12" Fluorescent Bulb	400	5.8	1 pk
54630	T8-LED, 18" Fluorescent Bulb	700	11.3	1 pk

G. Replaces: 68, 94, 847, 1004, 1020, 1076, 1142, 1152, 1171, 1176, 1196

Base: BA15d - Double Contact Bayonet

54632	1076-LED	200	2.4	1 pk
-------	----------	-----	-----	------

H. Replaces: 1016, 1034, 1154, 1157, 2057, 2357, 2397, 3496, 7528

Base: BA15d - Indexed Double Contact Bayonet

54634	1157-LED	40/170	0.3	2 pk
-------	----------	--------	-----	------

I. Replaces: 211, 212, 6411, 6413, 6429, 6451, 7576, 6475

Base: V8.5-8 - Festoon

54636	212-LED	20	0.2	2 pk
-------	---------	----	-----	------

J. Replaces: 194, 516, 579, 901, 904, 906, 912, 918, 920, 923, 928

Base: W2.1 X 9.5d (T10) - Wedge

54638	906-LED	70	1.2	2 pk
-------	---------	----	-----	------

K. Replaces: Any bulb with the bases: BA15s, BA15d, G4, W2.1 x 9.5d, SV8.5-8

Base: BA15s, BA15d, G4, W2.1 x 9.5d, SV8.5-8

54640	Universal LED	200	2.4	1 pk
54642	Universal LED	300	3.6	1 pk

L. Load Resistor

54644	Load Resistor Kit for LED Bulb, 6Ω	-	50	2 pk
-------	------------------------------------	---	----	------



LIGHT BULBS

Camco offers both clamshell and bulk packages and we are committed to providing you a well designed product that has been developed through rigid adherence to product specifications. The nominal voltage for most of our bulbs is 12.0.

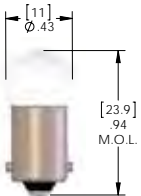

Figure 1



Figure 2



Figure 3

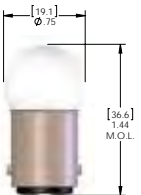

Figure 4

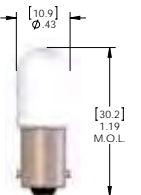

Figure 5

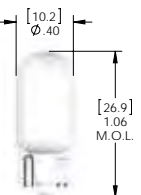

Figure 6

- DESIGN VOLTS:** The voltage at which the lamp is designed for rated amperage, candlepower and life characteristics.
- CANDLEPOWER:** The average value of total light output of miniature lamps at design volts.
- LIFE HOURS:** The rated average life to be expected when operated at design volts. Actual service life can vary depending upon application.
- SERVICE DESC.:** The major applications for each bulb. In most cases they can be used in many other applications.
- FIG. NUMBER:** Refers to the diagrams on page sides.

Fig #	Part #	Description	Design Volts	Amps	Watts	Candle Power	Life Hrs	Package
1	54710	53 Auto Instrument	14.4	.12	1.7	1	1000	10/box
	54711	53 Auto Instrument	14.4	.12	1.7	1	1000	2/pk
2	54712	55 Auto Instrument	7	.41	2.87	2	200	10/box
	54714	57 Auto Instrument	14	.24	3.4	2	500	10/box
	54715	57 Auto Instrument	14	.24	3.4	2	500	2/pk
	54836	1895 Auto Instrument	14	.27	3.78	2	2000	10/box
	54837	1895 Auto Instrument	14	.27	3.78	2	2000	2/pk
3	54717	63 Auto Instrument	7	.63	4.41	3	1000	2/pk
	54720	67 Auto License	13.5	.59	7.97	4	5000	10/box
	54721	67 Auto License	13.5	.59	7.97	4	5000	2/pk
	54727	89 Auto Interior	13	.58	7.54	6	750	2/pk
4	54722	68 Auto/Marine	13.5	.59	7.97	4	5000	10/box
	54723	68 Auto/Marine	13.5	.59	7.97	4	5000	2/pk
	54728	90 Auto/Marine Interior	13	.58	7.5	6	750	10/box
	54729	90 Auto/Marine Interior	13	.58	7.5	6	750	2/pk
5	54830	1816 Aviation/Auto Instrument	13	.33	4.29	3	1000	10/box
	54834	1893 HD Auto Instrument	14	.33	4.62	2	7500	10/box
	54835	1893 HD Auto Instrument	14	.33	4.62	2	7500	2/pk
6	54750	194 HD Auto Instrument	14	.27	3.8	2	2500	10/box
	54751	194/158 HD Auto Instrument	14/14	.27/.24	3.78/3.36	2	2500/500	2/pk
	54752	194A Auto Side Marker	14	.27	3.78	1.5	2500	10/box
	54753	194A Auto Side Marker	14	.27	3.78	1.5	2500	2/pk



Figure 7

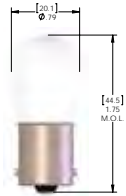

Figure 8



Figure 9



Figure 10



Figure 11



Figure 12

Fig #	Part #	Description	Design Volts	Amps	Watts	Candle Power	Life Hrs	Package
7	54762	906 Auto/RV Interior	13.5	.69	9.3	6	1000	10/box
	54763	906 Auto/RV Interior	13.5	.69	9.3	6	1000	2/pk
	54765	906F RV Interior	13.5	.69	9.3	6	1000	2/pk
	54766	912 Auto/RV/Marine Interior	12.8	1	12.8	12	1000	10/box
	54767	912 Auto/RV/Marine Interior	12.8	1	12.8	12	1000	2/pk
	54768	921 Auto 3rd Brake Lamp	12.8	1.41	18.048	21	1000	10/box
	54769	921 Auto 3rd Brake Lamp	12.8	1.41	18.048	21	1000	2/pk
8	54772	1003 Auto/RV Interior	12.8	.94	12.03	15	200	10/box
	54773	1003 Auto/RV Interior	12.8	.94	12.03	15	200	2/pk
9	54774	1004 Auto/RV Interior	12.8	.94	12.03	15	200	10/box
	54775	1004 Auto/RV Interior	12.8	.94	12.03	15	200	2/pk
10	54730	93 Auto	12.8	1.04	13.31	15	700	10/box
	54731	93 Auto	12.8	1.04	13.31	15	700	2/pk
	54788	1141 Auto/RV Back Up	12.8	1.44	18.43	21	1000	10/box
	54789	1141 Auto/RV Back Up	12.8	1.44	18.43	21	1000	2/pk
	54791	1141IF Inside Frosted	12.8	1.44	18.43	21	1000	2/pk
	54793	1141NA Auto/RV/Marine Exterior	12.8	1.44	18.43	-	1000	2/pk
	54802	1156 Auto Back Up	12.8	2.1	26.9	32	1200	10/box
	54803	1156 Auto Back Up	12.8	2.1	26.9	32	1200	2/pk
	54818	1295 Auto Cornering	12.5	3	37.5	50	200	10/box
	54829	1651 Lantern 4F Cells - Clear	5	.6	3	3	20	2/pk
11	54798	1154 Auto Park/Tail/Signal	6.3/7	2.63/.75	16.57/5.25	21/3	200/1000	10/box
	54799	1154 Auto Park/Tail/Signal	6.3/7	2.63/.75	16.57/5.25	21/3	200/1000	2/pk
	54806	1157 Auto Park/Tail/Signal	12.8/14.0	2.1/.59	26.88/8.26	32/3	1200/5000	10/box
	54807	1157 Auto Park/Tail/Signal	12.8/14.0	2.1/.59	26.88/8.26	32/3	1200/5000	2/pk
	54810	1157A Auto Park/Tail/Signal	12.8/14.0	2.1/.59	26.88/8.26	24	1200/5000	10/box
	54811	1157A/1034A Auto Park/Tail	12.8/14.0	2.1/.59	26.88/8.26	24	1200/5000	2/pk
	54838	2057 Auto Park/Tail/Signal	12.8/14.0	2.1/0.48	26.88/6.72	32/2	1200/5000	10/box
	54839	2057 Auto Park/Tail/Signal	12.8/14.0	2.1/0.48	26.88/6.72	32/2	1200/5000	2/pk
54841	2057NA Auto Park/Tail/Signal	12.8/14.0	2.1/0.48	26.88/6.72	24/1.5	1200/5000	2/pk	
12	54733	94 Auto/Marine	12.8	1.04	13.31	15	700	2/pk
	54794	1142 Auto/RV/Marine Exterior	12.8	1.44	18.432	21	1000	10/box
	54795	1142 Auto/RV/Marine Exterior	12.8	1.44	18.432	21	1000	2/pk
	54780	1076 Auto/RV/Marine Signal	12.8	1.8	23.04	32	200	10/box
	54781	1076 Auto/RV/Marine Signal	12.8	1.8	23.04	32	200	2/pk
	54812	1176 Stop/Tail/Park	12.8/14	1.34/.59	17.15/8.26	21/6	300/1500	10/box
	54813	1176 Stop/Tail/Park	12.8/14	1.34/.59	17.15/8.26	21/6	300/1500	2/pk



Figure 13



Figure 14



Figure 15

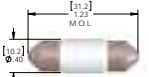

Figure 16

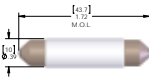

Figure 17



Figure 18



Figure 19



Fig #	Part #	Description	Design Voltage	Amps	Watts	Candle Power	Life Hours	Package
13	54786	1139IF RV/Marine/Truck Interior	12.8	1.04	13.3	15	700	10/box
	54787	1139IF RV/Marine/Truck Interior	12.8	1.04	13.3	15	700	2/pk
	54796	1143IF RV/Marine Inside Frosted	12.5	1.98	24.75	2.5/32	400	10/box
	54797	1143IF RV/Marine Inside Frosted	12.5	1.98	24.75	2.5/32	400	2/pk

14	54820	1383 Auto/RV Reading	13	1.5	19.5	-	300	1/box
	54822	1383TF Auto/RV Reading §	13	1.5	19.5	-	300	1/box
	54823	1383TF Auto/RV Reading §	13	1.5	19.5	-	300	1/pk

§ 1383TF bulbs are shatter-resistant

15	54706	20-99 RV Cosmetic Frosted	12	1.08	12.96	-	300	10/box
	54707	20-99 RV Cosmetic Frosted	12	1.08	12.96	-	300	1/pk
	54708	20-99 RV Cosmetic Clear	12	1.08	12.96	-	300	10/box
	54709	20-99 RV Cosmetic Clear	12	1.08	12.96	-	300	1/pk

16	54858	3175 Auto Interior	12	.83	9.96	9.5	400	10/box
	54859	3175 Auto Interior	12	.83	9.96	9.5	400	2/pk

17	54754	211-2 Auto Interior	12.8	.97	12.41	12	1000	10/box
	54755	211-2 Auto Interior	12.8	.97	12.41	12	1000	2/pk
	54756	212-2 Auto/Marine	13.5	.74	10	6	2000	10/box
	54757	212-2 Auto/Marine	13.5	.74	10	6	2000	2/pk
	54758	214-2 RV Refrig/Auto Interior	13.5	.52	7	4	1000	10/box
	54759	214-2 RV Refrig/Auto Interior	13.5	.52	7	4	1000	2/pk

18	54704	C7 1/2 Clear Patio Decor	120	.056	7	3.2	3000	10/box
	54705	C7 1/2 Clear Patio Decor	120	.056	7	3.2	3000	2/pk

19	54824	1414 Auto/RV	14	.46	6.44	6	500	10/box
	54825	1414 Auto/RV	14	.46	6.44	6	500	2/pk
	54827	1416 Marine	12.8	.8	10.24	8	1000	2/pk

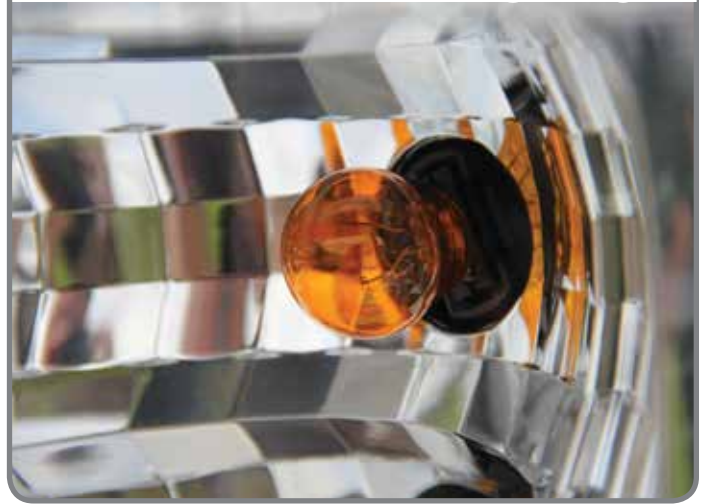

Figure 20

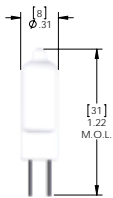

Figure 21

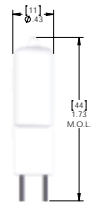

Figure 22

Fig #	Part #	Description	Design Volts	Amps	Watts	Candle Power	Life Hours	Package
20	54847	3057 Auto Park/Tail/Signal	12.8/14	2.1/.48	26.88/6.72	32/2	1200/5000	2/pk
	54849	3057NA Auto Park/Tail/Signal	12.8/14	2.1/.48	26.88/6.72	24/1.5	1200/5000	2/pk
	54850	3156 Auto	12.8	2.1	26.88	32	1200	10/box
	54854	3157 Auto Park/Tail/Signal	12.8/14	2.1/.59	26.88/8.26	32/3	1200/5000	10/box
	54855	3157 Auto Park/Tail/Signal	12.8/14	2.1/.59	26.88/8.26	32/3	1200/5000	2/pk
	54857	3157NA Auto Park/Tail/ Signal	12.8/14	2.1/.59	26.88/8.26	24/2.2	1200/5000	2/pk
21	54702	JC-10 Halogen Fog/Driving	12	.83	9.96	9.5	2000	1/box
	54902	JC-10 Halogen Fog/Driving	12	.83	9.96	9.5	2000	2/pk
22	54703	JC-35 Halogen, 12V 35W	12	2.92	35	47.7	2000	1/box
	54903	JC-35 Halogen, 12V 35W	12	2.92	35	47.7	2000	2/pk



The No-Wiring Trailer Hook-Up.

Kit contains two style 1157 tow lights and four bullet connectors. Instructions included.

Part #	Description	Design Voltage	Amps	Watts	Candle Power	Life Hrs	Pkg
54700	Tow Light Kit	2.1	2.1	2.1	32	1200	1 kit

12 Volt Flasher

Two terminal 552/536 (short) flasher. Flashes 2 to 3 standard or long-life turn signal lamps and 2 to 6 hazard lamps.

65260 12 V Flasher



Sealed Beam Bulb

Part #	Description	Design Voltage	Amps	Watts	Life Hrs	Pkg
54870	Bulb 4411	12.8	2.73	34.94	300	1 kit



**Screw-Base
12V Bulbs**

Part #	Description	Type	Wattage	Life Hours	Package
54871	A-19 75W/12V House Type	House	75	2500	6/box
54872	A-19 75W/12V House Type	House	75	2500	2/pk
54874	A-19 100W/12V House Type	House	100		2/pk
54890	A-15 15W/12V Oven Type	Oven	15		1/pk
54892	A-19 25W/12V House Type	House	25		2/pk
54894	A-19 50W/12V House Type	House	50		2/pk



12V Fluorescent Bulb Fits standard screw-in socket. Perfect for use with solar-power panels. Save energy-15W Fluorescent bulb delivers the lighting power of a 60W incandescent

Part #	Package
41313	1/pk

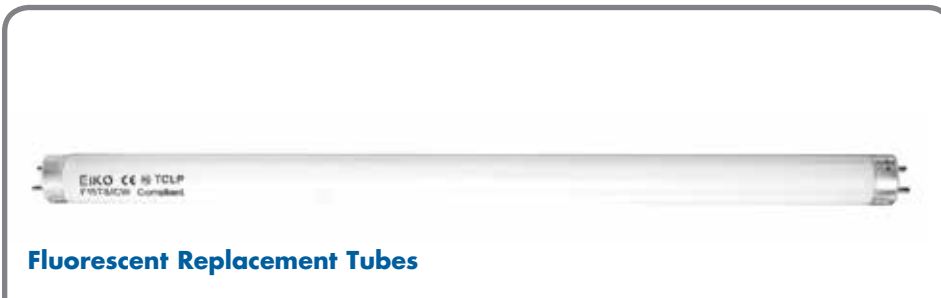

Fluorescent Replacement Tubes

Part #	Description	Length	Wattage	Life Hours	Package
54877	F15T8/CW 15 Watt - 18"	18 inch	15	7500	Bulk
54878	F15T8/CW 15 Watt - 18"	18 inch	15	7500	2/pk
54879	F8T5/CW 8 Watt - 12"	12 inch	8	7500	Bulk
54880	F8T5/CW 8 Watt - 12"	12 inch	8	7500	2/pk
54881	F13T5/CW 13 Watt - 21"	21 inch	13	7500	Bulk
54882	F13T5/CW 13 Watt - 21"	21 inch	13	7500	2/pk
54896	F4T5/CW 4 Watt - 6"	6 inch	4	6500	2/pk
54898	F6T5/CW 6 Watt - 9"	9 inch	6	7500	2/pk



RV/Marine DC Fluorescent Replacement Tubes 22W, Cool-White, 4-pin style FC8T9 with circular tube. 12000 Life Hours.

Part #	Package
54875	Bulk
54876	1/pk

Insulated Ring Terminals



AWG	Stud	Ins.	Pkg.	Part #
22-18	#10	Vinyl	100/Bag	63114
22-18	1/4 in	Vinyl	100/Bag	63124
22-18	3/8 in	Vinyl	100/Bag	63144
22-18	#10	Nylon	5/Card	63116
22-18	1/4 in	Nylon	5/Card	63126
16-14	#10	Vinyl	25/Bag	63167
16-14	#10	Vinyl	100/Bag	63169
16-14	1/4 in	Vinyl	25/Bag	63177
16-14	1/4 in	Vinyl	100/Bag	63179
16-14	5/16 in	Vinyl	25/Bag	63187
16-14	5/16 in	Vinyl	100/Bag	63189
16-14	3/8 in	Vinyl	25/Bag	63197
16-14	#10	Nylon	5/Card	63171
16-14	1/4 in	Nylon	5/Card	63181
16-14	5/16 in	Nylon	5/Card	63191
12-10	#10	Vinyl	25/Bag	63207
12-10	#10	Vinyl	100/Bag	63209
12-10	1/4 in	Vinyl	25/Bag	63217
12-10	1/4 in	Vinyl	100/Bag	63219
12-10	5/16 in	Vinyl	25/Bag	63227
12-10	3/8 in	Vinyl	25/Bag	63237
12-10	3/8 in	Vinyl	100/Bag	63239
12-10	1/2 in	Vinyl	25/Bag	63247
12-10	#10	Nylon	5/Card	63211
12-10	1/4 in	Nylon	5/Card	63221
12-10	5/16 in	Nylon	5/Card	63231

Heat Shrink Ring Terminals



AWG	Stud	Ins.	Pkg.	Part #
22-18	#10	Heat Shrink	100	63863
16-14	#10	Heat Shrink	100	63875
12-10	#10	Heat Shrink	100	63887
22-18	#8	Heat Shrink	3	65872
16-14	#8	Heat Shrink	3	65884
16-14	5/16 in	Heat Shrink	3	65890
16-14	3/8 in	Heat Shrink	3	65893
12-10	#8	Heat Shrink	3	65896
12-10	5/16 in	Heat Shrink	3	65902
12-10	3/8 in	Heat Shrink	3	65905

1. Non-skid ridge—tool slides to end for proper crimp.
2. Beveled leading edge for easy wire entry.
3. FUNNEL BARREL CONSTRUCTION for positive and easy wire insertion.
4. Crimp ridge for centering and locating tool on terminal barrel.
5. INJECTION MOLDED, 105° C RATED insulation of electrical grade vinyl plastic for uniform wall thickness and interface.
6. Multiple "V" grooves in #22 AWG to #4 AWG for maximum holding power and current flow.
7. Barrel-to-pad transition designed to maximize strength and minimize bending.
8. One piece, burr-free construction for maximum electrical conductivity. Electro-tin plating for maximum corrosion resistance.

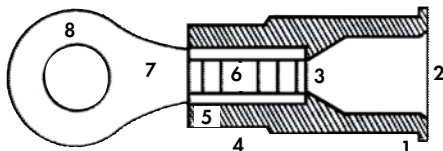

Heavy Duty, Insulated Ring Terminals

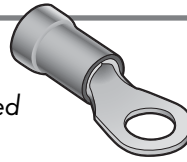

AWG	Stud	Ins.	Pkg.	Part #
8	#10	Vinyl	25	63262
8	1/4"	Vinyl	25	63265
8	5/16"	Vinyl	100	63267
8	5/16"	Vinyl	25	63268
8	3/8"	Vinyl	25	63271
6	#10	Vinyl	25	63277
6	5/16"	Vinyl	25	63283
6	3/8"	Vinyl	25	63286

Heat Shrink Butt Connectors



AWG	Ins.	Pkg.	Part #
22-18	Heat Shrink	3	63868
22-18	Heat Shrink	25	63869
22-18	Heat Shrink	100	63871
16-14	Heat Shrink	3	63880
16-14	Heat Shrink	25	63881
16-14	Heat Shrink	100	63883
12-10	Heat Shrink	3	63892
12-10	Heat Shrink	25	63893
12-10	Heat Shrink	100	63895

Insulated Butt Connectors

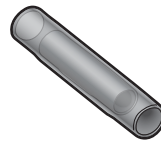

AWG	Ins.	Pkg.	Part #
22-18	Vinyl	25	63477
22-18	Vinyl	100	63479
16-14	Vinyl	25	63487
16-14	Vinyl	100	63489
12-10	Vinyl	25	63497
12-10	Vinyl	100	63499
22-18	Nylon	5	63481
22-18	Nylon	25	63482
22-18	Nylon	100	63484
16-14	Nylon	5	63491
16-14	Nylon	25	63492
16-14	Nylon	100	63494
12-10	Nylon	5	63501
12-10	Nylon	25	63502
12-10	Nylon	100	63504

Heavy Duty, Insulated Butt Connectors

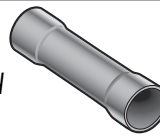

AWG	Ins.	Pkg.	Part #
8	Vinyl	25	63522
8	Vinyl	100	63521
6	Vinyl-	25	63525

Insulated Spade Terminals



AWG	Stud	Ins.	Pkg.	Part #
16-14	#8	Nylon	6	63742
16-14	#10	Nylon	6	63745
12-10	#10	Nylon	5	63754
12-10	#10	Nylon	100	63756

Vinyl Insulated Disconnects

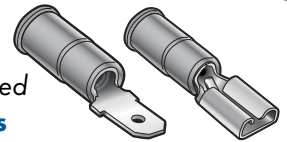

AWG	Gender	Tab size	Pkg.	Part #
22-18	Male	.250	100	63564
22-18	Female	.250	25	63567
22-18	Female	.250	100	63569
16-14	Female	.187	25	63582
16-14	Male	.250	25	63592
16-14	Male	.250	100	63594
16-14	Female	.250	25	63602
16-14	Female	.250	100	63604
12-10	Male	.250	25	63612
12-10	Female	.250	25	63617

Nylon Insulated Bullet Disconnects

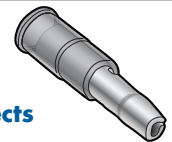

AWG	Gender	Bullet Dia.	Pkg.	Part #
16-14	Male	.157	2	63662
16-14	Male	.157	25	63648

Insulated Pigtail Connectors



AWG	Ins.	Pkg.	Part #
16-14	Nylon	5	63670
16-14	Nylon	100	63673
12-10	Nylon	5	63675
12-10	Nylon	25	63676
8	Nylon	25	63681

Insulated Piggyback Slip-ons



AWG	Ins.	Pkg.	Part #
16-14	Vinyl	100	63686

Self-Tapping IDC Connectors

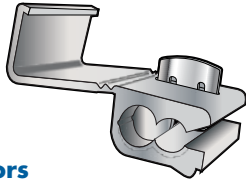

Part #	AWG	Pkg.
63801	18-14	5
63802	18-14	50
63804	18-14	100
63806	18-14	5
63807	18-14	50
63809	18-14	100
63811	12-10	3
63812	12-10	50



Black Split Loom

Corrugated polyethylene tubing. Holds groups of wires together. Guards wires against abrasion and crushing. Tubing is slit for easy insertion of wires.

	1/4"	3/8"	1/2"	5/8"	3/4"	1"	1-1/4"
50 ft	-	64976	64979	-	-	-	-
100 ft	64972	64975	64978	64981	64984	64987	64990

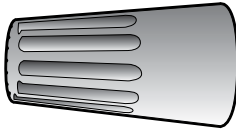

Wire Nuts

Part #	AWG	Rating	Pkg.
63831	22-18	300 V / 105 °C	5
63832	22-18	300 V / 105 °C	100
63834	22-14	300 V / 105 °C	5
63835	22-14	300 V / 105 °C	100
63837	18-14	600 V / 105 °C	5
63838	18-14	600 V / 105 °C	100
63840	18-10	300 V / 105 °C	5
63841	18-10	300 V / 105 °C	100
63843	14-10	300 V / 105 °C	5
63844	14-10	300 V / 105 °C	100
63853 winged	18-8	300 V / 105 °C	100



Heat Shrink Tubing

125° C flexible polyolefin tubing. Recovers to 50% of its original diameter when heated. Use for splices, wire bundling, markets, harnessing, stress relief, terminations, etc. Provides excellent resistance to chemicals, corrosion, oil, and heat.

Package	1/8" 20-18 Ga Red	3/16" 16-14 Ga Blue	1/4" 12-10 Ga Yellow	3/8" 14-18 Ga Clear	1/2" 8-2 Ga Black
6" (12/Header Bag)	64997	65000	65003	65009	65012

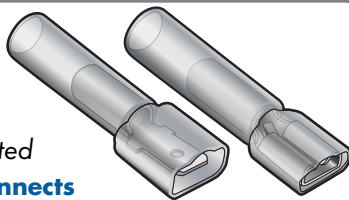

Insulated Disconnects

	Gender	Ins.	Pkg.	Part #
22-18	M	Nylon	5	63701
22-18	F	Nylon	5	63706
16-14	M	Nylon	5	63711
16-14	F	Nylon	5	63716
16-14	F	Nylon	25	63717
16-14	F	Nylon	100	63719
12-10	M	Nylon	5	63721
12-10	M	Nylon	25	63722
12-10	F	Nylon	5	63726
12-10	F	Nylon	25	63727

Adhesive Lined Heat Shrink Tubing

Crosslinked polyolefin tubing with an internal meltable sealant. Recovers to 33% of its original diameter. As it shrinks, the internal sealant melts and physically encapsulates the covered item. This tubing is especially useful as a moisture barrier in high humidity and corrosive environments. Used for strain relief, wire splices, breakouts, connections, solder joints, delicate wire terminations and end sealing of cables and tubing.



Size (in.)	1/2" 10-6 Ga Black	3/4" 8-1 Ga Black
6" Bulk	65020	65023
Twelve 6" pieces (Header Bag)	65022	65025

AGC / Glass Fuses

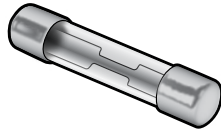

AGU Glass Fuses

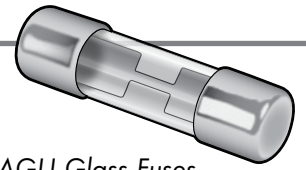

AMP	1	2.5	4	5	7.5	10	15	20	25	30	35	30	40	50	60
5-pk	65091	65093	65095	65097	65099	65101	65103	65105	65107	65109	65111	65176	65178	65180	65182
65112 Assortment (2 ea: 10, 15, 20, 25 & 30 AMP)															

Blade Fuses

Mini-Blade Fuses



ATC/ATO Blade Fuses

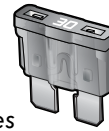

Max-Blade Fuses

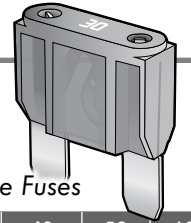

AMP	5	7.5	10	15	20	25	30	3	5	7.5	10	15	20	25	30	20	30	40	50	60
Color	Tan	Brown	Red	Blue	Yellow	Clear	Green	Violet	Tan	Brown	Red	Blue	Yellow	Clear	Green	Yellow	Green	Orange	Red	Blue
2-pk	65141	65143	65145	65147	65149	65151	65153	65121	65123	65125	65127	65129	65131	65133	65135	65161	65163	65165	65167	65169
100	65422	-	65423	65424	65425	65426	65427	-	-	-	-	65418	65419	65420	65421	-	65431	65429	-	-
65136 Assortment (2 ea: 5, 10, 15, 20 & 30 AMP)																				

Automatic-Reset Circuit Breaker

6-24 Volt application.
Straight-Mount



AMP	1/card
10	65218
15	65220
20	65222
30	65224
50	65226

Automatic-Reset Circuit Breaker

6-24 Volt application.
90°-mount



AMP	1/card
10	65192
15	65194
20	65196
30	65198
40	65200
50	65202

Blade Terminals

Heavy duty replacement for ATO and ATC blade type fuses. Special snap off feature provides three lengths from .30-.75 long.



AMP	10	15	20	25	30
1-pk	65231	65233	65235	65239	65237

FUSE HOLDERS

ATO/ATC/Blade Fuse Holder



	16 AWG / 20 AMP	12 AWG / 25-30 AMP
1/card	65250	65252

AGC/Glass Fuse Holder

6" wire (Fuse included)



	16 AWG / 20 AMP	12 AWG / 30 AMP	10 AWG / 30 AMP
1/card	65241	65246	65248



ATC Fuse Tap Adapter

Tap the hot side of flat automotive fuse blocks to easily create an additional circuit for a radio or other add-on accessory.

65186 2 pack

Mini-Blade Fuse Holder

Weather resistant cover



	16 AWG / 5-20 AMP
Bulk	65253

ATO/ATC/Blade Fuse Holder

Weather resistant - 6" wire (Fuse included)



	12 AWG / 25-30 AMP
Bulk	65257

Max-Blade Fuse Holder

Weather resistant



	8 AWG / 60 AMP
Bulk	65255

Bonded Wire

Specifications: General purpose thermoplastic wire made with bare copper conductors and polyvinyl chloride insulation to SAE J1128 standards. Rated at 80° C, 90V.

Two, three, or four wires extruded side by side.

Colors: Two Conductor - Red and Black;

Four Conductor -

White, Brown, Yellow, Green



Bonded Wire	Two Conductor		Four Conductor		
	12 Gage 100 ft Spool	18 Gage 1000 ft Spool	16 Gage 100 ft Spool	14 Gage 100 ft Spool	14 Gage 25 Foot Card
	64534	64478	64509	64529	64528

General Purpose Primary Wire

Specifications: General purpose thermoplastic wire made with bare copper conductors and polyvinyl chloride insulation to SAE J1128 standards. Rated at 80° C, 90V. Used in automotive, trailer, RV and other low-voltage applications.



GTP Wire	100 Foot Spool			
	18 Gage Red	18 Gage Black	16 Gage Red	12 Gage Black
	63952	64021	63958	64039

Copper Lugs Made from 95% copper.

Copper Lugs

Package	8 Gage			6 Gage		4 Gage		2 Gage		1 Gage	1/0 Gage	2/0 Gage
	#10	#5/16	#3/8	#1/4	#3/8	#5/16	#3/8	#5/16	#3/8	#3/8	#3/8	#3/8
25/bag	65800	65823	65824	65801	65822	65803	65804	65806	65807	65820	65809	65812



Tin Plated Copper Lugs

Package	8 Gage		6 Gage		4 Gage			2 Gage		1 Gage		1/0 Gage		2/0 Gage		
	#5/16	#1/4	#3/8	#1/4	#5/16	#3/8	#5/16	#3/8	#1/2	#5/16	#3/8	#5/16	#3/8	#5/16	#3/8	#1/2
25/bag	65849	65827	65848	65828	65829	65830	65832	65833	65836	65851	65846	65834	65835	65837	65838	65839

Quickee Circuit Tester

One-hand operation to test circuits in hard-to-reach areas. Works two ways—captures and pierces wire with unique hook design or it can be used as an “ice pick” type tester.

63928 1/card



Circuit Tester 6-12V

Tests ground circuit continuity of lamps, wiring, fuses, switches, battery cable circuits, etc.

63925 Bulk

63926 1/card



Self-Adjusting Wire Stripper

Cuts and strips 26 to 10 AWG wire and crimps insulated and uninsulated terminals. Strips multi-lead trailer wire in one motion without harming strands.

63924 1/card



Ratcheting Crimper Tool

Crimps 22 to 18, 16 to 14 and 12 to 10 Gage terminals in three separate crimping nests. Makes two crimps—electrical and weather resistant—all in one motion.

63929 1/card



All-Purpose Handtool

Standard duty construction. Crimps and strips 22 to 10 Gage wire. Also features wire and bolt cutters.

63920 Bulk

63921 1/card



Cable Ties

Miniature / Intermediate



	4" Length x .10" Width 1/16" to 7/8" Bundle Dia. 18 lbs tensile strength		5.5" Length x .13" Width 1/16" to 1-1/4" Bundle Dia. 30 lbs tensile strength		8.5" Length x .13" Width 1/16" to 2" Bundle Dia. 40 lbs tensile strength		14.5" Length x .146" Width 1/16" to 4" Bundle Dia. 40 lbs tensile strength	
	Natural	Black	Natural	Black	Natural	Black	Natural	Black
25/Header Bag	64876	-	-	64885	64888	-	-	-
100 count	64877	64880	64883	64886	-	-	64896	-

Standard



	5.5" Length / .187" width 1/16" to 1" Bundle Dia. 50 lb tensile strength		8" Length / .187" width 1/16" to 1-3/4" Bundle Dia. 50 lb tensile strength		11.1" Length / .187" width 1/16" to 3" Bundle Dia. 50 lb tensile strength		14.1" Length / .187" width 1/16" to 4" Bundle Dia. 50 lb tensile strength	
	Natural	Black	Natural	Black	Natural	Black	Natural	Black
25/Header Bag	-	64904	64907	-	-	-	-	-
100 count	64899	64905	64908	64911	64914	64918	-	-

Heavy Duty



	15" Length - .30" width 3/16" to 4" Bundle Dia. 120 lb tensile strength	
	Natural	Black
25/Header Bag	-	-
100 count	64926	64928

Mounting Cable Ties



	6" L - .14" W - #8 Stud 1/16" to 1-1/4" Bundle Dia. 40 lbs tensile strength		7.5" L - .185" W - #10 Stud 1/16" to 1-3/4" Bundle Dia. 50 lbs tensile strength		11.1" L - .187" W - #10 Stud 1/16" to 3" Bundle Dia. 50 lbs tensile strength		14.5" L - .187" W - #10 Stud 1/16" to 4" Bundle Dia. 50 lbs tensile strength	
	Natural	Black	Natural	Black	Black	Black	Black	
25/Header Bag	-	-	64944	64947	-	-	-	
100 count	64939	64942	64945	64948	64954	64954	64960	

Mounting Bases for Cable Ties

Molded nylon. Adhesive backed with screw mount. Natural color.

64966 Mounting Bases - 100 count

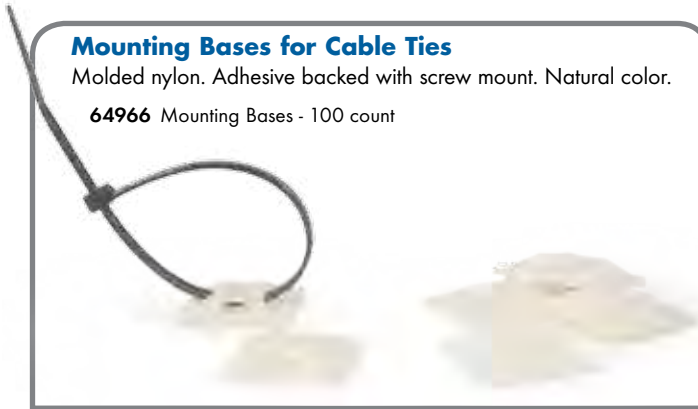

Lead Battery Terminals

Made with lead alloy, composed of antimony. Tensile strength and hardness will meet your heavy electrical demands. Tin is added to prevent corrosion and oxidation.



Package	Universal Emergency Recessed staked-in zinc plated nuts.	Marine Universal Zinc plated to resist corrosion.
2/card	65276	65280

Nylon Clamps / #10 Stud



Package	3/16"	1/4"	3/8"	1/2"	3/4"
25/Header Bag	65054	65057	65060	65063	65068

Rubber-Coated Metal Clamps



Package	5/16" ID 3/8" Stud	1" ID 3/8" Stud
25/Header Bag	65042	65048

Frame Clips

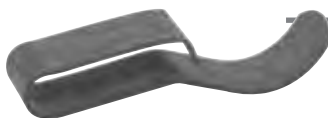

Package	Small - 3/16" ID	Medium - 1/4" ID
100 ct	65070	65072

PVC Electrical Tape

All-Weather UL and CSA approved electrical tape. 3/4" x 60'.

65085 Electrical Tape



RV Starter Kit Buckets

SELECT FROM 8 OPTIONS

RV Starter Kits provide the new RVer with just the right products to get started in the camping life. And experienced RVers, upgrading to bigger units, can drive away with new items to enhance their purchase. Each kit includes a sheet of valuable coupons for Camco products.



Starter Kit Bucket - I

- TST Orange Drop-Ins, 3/bag
- 10-ft Standard Sewer Hose with pre-attached fitting
- RV Toilet Tissue - 1 Ply -4 Pack
- 15M/30F Amp Power Grip Adapter
- TastePURE 10 ft Drinking Water Hose
- Wash & Wax - 32 oz
- RV Wash Sponge

44760 Starter Kit Bucket - I

Starter Kit Bucket - II

- TST Orange Drop-Ins, 3/bag
- 10-ft Standard Sewer Hose with pre-attached fitting
- RV Toilet Tissue - 1 Ply -4 Pack
- 15M/30F Amp Power Grip Adapter
- TastePURE 25 ft Drinking Water Hose
- Wash & Wax - 32 oz
- RV Wash Sponge

44763 Starter Kit Bucket - II

Starter Kit Bucket - III

- TST Orange Drop-Ins, 3/bag
- 10-ft Standard Sewer Hose with pre-attached fitting
- RV Toilet Tissue - 1 Ply -4 Pack
- 15M/30F Amp Power Grip Adapter
- TastePURE 25 ft Drinking Water Hose
- Plastic Water Pressure Regulator
- Wash & Wax - 32 oz
- RV Wash Sponge

44742 Starter Kit Bucket - III

Starter Kit Bucket - IV

- TST Orange Drop-Ins, 3/bag
- 10-ft Standard Sewer Hose with pre-attached fitting
- RV Toilet Tissue - 1 Ply -4 Pack
- 15M/30F Amp Power Grip Adapter
- TastePURE 25 ft Drinking Water Hose
- Plastic Water Pressure Regulator
- Wash & Wax - 32 oz
- RV Wash Sponge

Two Standard Levels
44743 Starter Kit Bucket - IV



Starter Kit Bucket - V

TST Orange Drop-Ins, 3/bag
 20-ft Standard Sewer Hose, Bulk
 RV Straight Hose Adapter
 Stainless Steel Hose Clamp
 RV Toilet Tissue - 1 Ply -4 Pack
 15M/30F Amp Power Grip Adapter
 TastePURE 25-ft Drinking Water Hose
 Wash & Wax - 32 oz
 RV Wash Sponge

44744 Starter Kit Bucket - V

Starter Kit Bucket - VI

TST Orange Drop-Ins, 3/bag
 20-ft Standard Sewer Hose,
 RV Straight Hose Adapter
 Disposable Dump Gloves - 100 count
 Stainless Steel Hose Clamp
 RV Toilet Tissue - 1 Ply -4 Pack
 15M/30F Amp Power Grip Adapter
 TastePURE 25-ft Drinking Water Hose
 Water Pressure Regulator Plastic
 Two Standard Levels

44745 Starter Kit Bucket - VI

Starter Kit Bucket - VII

TastePURE 25-ft Drinking Water Hose
 15-ft Standard Sewer Hose with
 pre-attached fitting
 TST Orange Drop-Ins, 3/bag
 Brass Water Pressure Regulator Brass
 (2010 Comp)
 RV Toilet Tissue - 1 Ply -4 Pack
 15M/30F Amp Power Grip Adapter

44746 Starter Kit Bucket - VII

Starter Kit Bucket - VIII

TST Orange Drop-Ins, 3/bag
 10-ft Standard Sewer Hose with
 pre-attached fitting
 15M/30F Amp Power Grip Adapter
 RV Toilet Tissue - 2 Ply - 4 Pack,
 TastePURE 25-ft Drinking Water Hose
 Brass Water Pressure Regulator Brass
 (2010 Comp)
 Wash & Wax - 32 oz
 RV Wash Sponge

44762 Starter Kit Bucket - VIII

Boxed Starter Kits

RV Starter Kits provide the new RVer with just the right products to get started in the camping life. And experienced RVers, upgrading to bigger units, can drive away with new items to enhance their purchase. Each kit includes a sheet of valuable coupons for Camco products.

Pop-Up Camper Kit

- 10-ft drinking water hose
- 15M/30F Amp Power Grip Adapter
- Water pressure regulator
- Grey water seal
- 45° hose elbow (2010 compliant)

44721 Pop-Up Camper Starter Kit

Standard Kit

- 10-ft drinking water hose
- 15M/30F Amp Power Grip Adapter
- TST™ MAX Drop-INS (3/pack)
- 10-ft Standard Sewer Hose with pre-attached fitting
- RV Toilet Tissue - 1 Ply -4 Pack

44761 Standard Starter Kit

Deluxe Kit

- 25-ft drinking water hose
- Water pressure regulator
- 15M/30F Amp Power Grip Adapter
- TST™ MAX Drop-INS (5/pack)
- 10-ft Standard Sewer Hose with pre-attached fitting
- RV Toilet Tissue - 1 Ply -4 Pack

44771 Deluxe Starter Kit

Premium Kit

- 25-ft drinking water hose
- Brass water pressure regulator
- 15M/30F Amp Power Grip Adapter
- Heavy Duty 10' sewer hose
- Easy Slip® 4-in-1 elbow and adapter
- Easy Slip® straight hose adapter
- TST Orange Drop-Ins, 15/bag
- RV Toilet Tissue - 1 Ply -4 Pack

44781 Premium Starter Kit

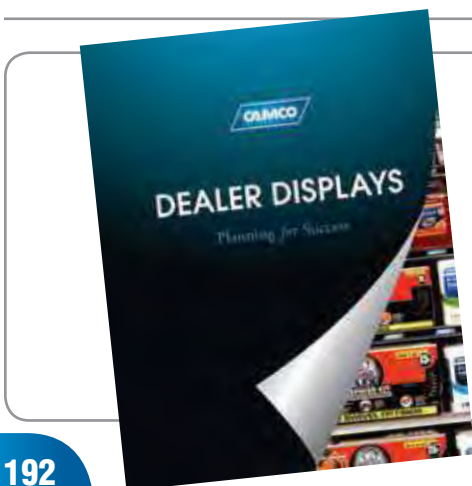

Camco offers you expertise and experience

Would you like to benefit from our expertise in effective merchandising? Would you like to profit from our credibility as the nation's leading manufacturer of high quality RV Products? If so, you will quickly see that Camco has the answers to help you succeed as an RV retailer.

A

AC Covers, Vinyl.....	50	Battery Cable.....	153	Can Openers.....	29
AccuLevel™.....	168	Battery Hold-Down Trays.....	178	Carabiners.....	32
Acme Nut, Black, Propane Grill.....	84	Battery Terminals.....	189	Carnauba Wash & Wax.....	134
Acme Nut, Green, Propane.....	84	Black Streak Remover.....	134	C-Do2™ 45° Hose Adapter.....	127
Aero-flo™ RV Roof Vent Cover.....	71	Blade Fuse Holder.....		Chain Loop.....	149
Air Conditioner Gasket Kit.....	91	ATO/ATC.....	187	Chair and Bike Rack.....	23
Aluminum Care Wash.....	138	ATO/ATC - Weather resistant.....	187	Chair and Bike Rack, Clamp-N-Carry™.....	23
Anode Rods.....	93	Max - Weather resistant.....	187	Chair Bag.....	4
Anode Rod with Drain.....	93	Mini - Weather resistant.....	187	Chairs.....	
Antifreeze.....		Blade Terminals.....	187	Folding Directors Chairs.....	4
Ban Frost 2000 Marine Engine.....	99	Blast-Out Degreaser.....	136	Zero Gravity Recliners.....	4
Boiler.....	95	Blast-Out Pressure Washer Concentrate.....	136	Zero Gravity Wide Recliners.....	4
Boiler, AL.....	95, 98	Blind Spot Mirror, 360°.....	157	Circuit Analyzer, 30 Amp.....	178
pH Test Strips.....	95, 99	Blind Spot Mirrors.....	157	Circuit Breakers.....	
Water System Antifreeze.....	99	Blow-out Plugs.....	100	Automatic-Reset.....	187
AquaBlock™ Waterproof & Stain Repellent.....	134	Boat Winterizer, DIY.....	101	Circuit Tester 6-12V.....	188
Awning Anchor Kit.....	13	Boiler Antifreeze.....	95	Circuit Tester, Quicke.....	188
Awning Arm Anchor.....	15	Boiler Antifreeze -100°.....	99	Citronella Candle.....	34
RV Awning-Clamp™.....	12	Boiler Antifreeze AL.....	95, 98	Citrus Cleaner, RV.....	138
Awning Cleaner.....	134	Bolt Package for Adj. Ball Mount.....	147	Clamps.....	
Awning Door Roller Ball.....	11	Broom, Adjustable.....	66	Multi-Clamp.....	129
Awning Hanger Clips.....	9	Brush, Adjustable RV Wash.....	136	Sewer Hose Twist-It™ Clamps.....	129
Awning Hold Down Strap Kit.....	13	Brush Head Attachment.....	137	Class A Covers.....	48, 49
Awning Knobs, Replacement.....	25	Bucket.....		Class C/Travel Trailer Covers.....	48, 49
Awning Locking Pins.....	25	Collapsible.....	24	Clock.....	65
Awning Mat Anchors.....	6	XL Collapsible.....	136	Coaxial Cable.....	74
Awning Mats.....		Bug and Tar Cutter™.....	138	Coffee Filter Dispenser.....	59
Awning/Leisure Mat.....	6	Bulb, 12V Fluorescent.....	184	Cold Weather Water Hose.....	106
Awning & Leisure Mat, Premium.....	6	Bulbs, 12V Screw-Base.....	184	Combo Bars.....	149
Awning Mat.....	6	Bulb, Sealed Beam.....	183	Compass, Lensatic.....	31
Awning Opener, Easy Reach.....	11	Bullseye Level.....	168	Container, Mini Pop-Up.....	24
Awning Pull Straps.....	11	Bumper Caps.....	130	Container, Recycle, Pop-Up.....	24
Awning Repair Tape.....	25	Bumper Caps with Insect Screens.....	130	Container, XL, Pop-Up.....	24
Awning Roller.....	11	Burner Liners, Gas Stove.....	57	Continuity Tester, Water Heater.....	92
Awning Savers, Screen Door.....	11	Burner Tube Cleaner, Gas.....	95	Convex Blind Spot Mirror.....	157
Awning Spring.....	13	Bushing.....	149	Cooking Covers, Microwave.....	56
Awning Stabilizer Kit.....	13	Bushing 1-1/4" to 1".....	147	Corner Guards, Slide-Out.....	75
Awning Stake.....	13	Butane Lighters.....	44, 45	Countertop Extension, Oak Accents™.....	54
Awning Straps.....	25	Butane refills.....	44	Covers, AC.....	50
Awning Waterproof, RV.....	138	By-Pass Kits.....		Covers, Class C Windshield.....	50
Axe.....	30	Quick-Turn Permanent.....	98	Covers, RV UltraGuard.....	49

B

Backflow Preventers.....	108
Baggage Door Catches.....	74
Ball Cover.....	149
Ball Mount, Adjustable.....	147
Ball Mount Bar.....	148
Ball Mount Kit, elite.....	147
Ball Mount Shanks.....	151
Ball Mounts, Hitch.....	150
Ball, Washer, Nut.....	148
Bamboo Cutting Boards.....	55
BanFrost 2000® Marine Engine.....	99
Ban Frost 2000®, Premium.....	99
Barbecue Adapter Hose.....	42
Base Pads, Stabilizing.....	163
Battery Boxes.....	178

C

Cabinet Catches.....	74
Cable Tie Mounting Bases.....	189
Cable Ties.....	189
Cam Locks.....	74
Cam Locks, Water Heater.....	92
Camper Drain, Flexible.....	110
Camper Drain Trap.....	110
Camper Mounting Tape.....	75
Campfire, Big Red.....	18
Campfire, Little Red.....	18
Campfire, Portable Propane.....	19
Campfire Replacement Log Set.....	18
Camping Cook Set.....	29
CAMPLighter™ Butane Matches.....	44
CAMPLighter™ Elite.....	44

D

Crack Handle.....	163
Crimper Tool, Ratcheting.....	188
Cross Bar, Screen Door.....	14
Cutlery Tray.....	63
Cutlery Tray, Adjustable.....	63
Cutting Boards.....	
Bamboo.....	55
Sink Mate.....	56
Stowaway Flexible Cutting Mat.....	56
Cyclone™ Plumbing Vent.....	125

De-Flapper™.....	15
De-Flapper™ MAX.....	15
Dehumidifier, Mini.....	65

Dish Drainer, Mini.....	60
Dishpan, Mini.....	60
Display Catalog.....	192
Ditty Bag Set.....	33
Dogbone Adapters, Power Grip™.....	172
Dome Lights, 12V replacement.....	178
Door Grill, Screen Door.....	14
Drain Plugs, Water Heater.....	92
Drain Trap, Camper.....	110
Drain Valves	
Water Heater.....	93
Drain Valves, Dual Size.....	110
Drain Valve Wrench, Water Heater.....	93
Drink Holder, Adjustable.....	63
Drinking Water Freshener.....	106
Drinking Water Hoses.....	106
Drinkware, BPA-free	
Juice Glass.....	61
Margarita Glass.....	61
Martini Glass.....	61
Pilsner Glass.....	61
Tumbler.....	61
Wine Glass.....	61
Dual Flush™.....	127
Dual Flush™ PRO.....	127
Dunk Bag.....	33
Dust Covers, Heater.....	88
Dust Pan and Whiskbroom.....	66

E

Easy Slip™ Fittings.....	122
Egg Carriers.....	28
Elbow & 4-in-1 Adapter, Easy Slip®.....	123
Electrical Adapter, 90°.....	172
Electrical Adapter Locking Rings.....	176
Electrical Adapters.....	172
Electrical Adapters, 90° Locking.....	176
Electrical Adapters, Locking.....	176
Electrical Clamps, Nylon.....	189
Electrical Clamps, Rubber coated.....	189
Electrical Connectors	
Bullet Disconnects, Insulated.....	185
Butt Connectors, Heat Shrink.....	185
Butt Connectors, Heavy Duty, Insulated.....	185
Butt Connectors, Insulated.....	185
Disconnects, Vinyl Insulated.....	185
Insulated Disconnects.....	186
Piggyback Slip-ons, Insulated.....	185
Pigtail Connectors, Insulated.....	185
Ring Terminals, Heat Shrink.....	185
Ring Terminals, Heavy Duty, Insulated, Vinyl.....	185
Ring Terminals, Insulated.....	185
Self-Tapping	
IDC Connectors.....	186
Spade Terminals, Insulated.....	185
Wire Nuts.....	186
Electrical Cords, 90° Locking.....	176
Electrical Cord Storage Handle.....	175

Electrical Dogbone Adapters.....	172
Electrical Line Monitor, 120 Volt.....	177
Electrical Lube.....	177
Electrical Lugs.....	188
Element Socket.....	92
Elements, Water Heater.....	92
Elite Hitch Kits.....	146
Emergency Blanket.....	32
Evacuation Flange.....	110
Evo™ Premium Water Filter.....	104
Evo™ Premium Water Filter VOC Cartridge.....	104
Extension Cord, 15 Amp.....	175
Extension Cord, Outdoor - 30'/15 Amp.....	175
Extension Cords, Power Grip™.....	175

F

5th Wheel Covers.....	48, 49
Fifth Wheel Hitches - Eaz-Lift.....	145
Fifth Wheel Hitch, Free Ride™.....	144
5th Wheel Lube Plates.....	152
5th Wheel Stabilizing Jack, King Pin.....	162
Fill Spout with Door.....	111
Filter Washers.....	108
Fire Ring, Collapsible.....	19
Fire Starter, Magnesium.....	32
Firestarter Sticks.....	32
Flag Holders.....	16
Flagpole, Fiberglass.....	17
Flagpole Holder, Hitch-Mount.....	17
Flagpole, Telescoping.....	17
Flags	
Happy Hour.....	16
U.S. Flag.....	16
Flashers, 12v.....	183
Flints - 10 pack.....	32
Fluorescent Replacement Tubes.....	184
Fluorescent Replacement Tubes, RV/Marine.....	184
Flush Mount Fill Spout.....	111
Flying Insect Screens.....	90
Food Cover.....	28
Fork, Safety.....	29
Fork, Telescoping.....	29
Frame Clips.....	154, 189
Freeze Ban -50.....	99
Fresh Tabs.....	106
Fridge Airator™.....	64
Fridge Brace™.....	64
Fridge Door Stay.....	64
Fridge Odor Absorber.....	64
Fuel Funnel.....	29
Fuse Holder, AGC/Glass.....	187
Fuses	
AGC / Glass.....	187
ATC/ATO Blade.....	187
Max-Blade.....	187
Mini-Blade.....	187
Fuses, Blade.....	187
Fuse Tap Adapter, ATC.....	187

G

Gas Burner Tube Cleaner.....	95
Gas Control Replacements.....	94
Gas Control Wrench.....	94
Gas Gauge/Leak Detector.....	85
Gasket Kit, AC.....	91
Gas Leak Detector.....	95
GasMatches.....	44
Gas Pilot Assemblies, RV.....	94
Gas Pressure Test Kit.....	95
Generator Adapter.....	174
Generator Adapter, Dogbone.....	174
Gen-turi™.....	79
Replacement parts.....	79
Transfer Kit.....	79
Gloves, Sanitation.....	123
Gooseneck Adapters.....	143
Gooseneck Ball & Plate.....	143
Gooseneck Stabilizer Jack.....	162
Grease Bin.....	62
Grease Gun.....	149
Grey Water Seal.....	123
Griddle.....	29
Grill Accessories	
Grill Bag, Olympian.....	42
Grill Stand, Folding.....	42
Grill Table, Deluxe Folding.....	42
Hose, Barbecue Adapter.....	42
Quick-Connect	
4100 Low Pressure Conversion Kit.....	43
Gas Control Valve.....	43
RV Grill Mount.....	40
RV Mounting Rail.....	41
Throwaway Cylinder Adapter Kit.....	43
Grill and Lantern Holder, Tripod.....	28
Grills	
Olympian 4100 Grill.....	41
Olympian 4500 Gas Grill.....	39
Olympian 5500 SS RV Grill.....	41
Grommets, Plastic.....	34
Gutter Extensions.....	75
Gutter Spouts w/Extensions.....	75

H

Hand Pump Kit.....	100
Handtool, All-Purpose.....	188
Handy Mat.....	21
Heaters, Catalytic.....	89
Wave™.....	88
Heaters, Catalytic Safety.....	89
Heat Shrink Tubing, Adhesive Lined.....	186
Hitch Alignment Kit.....	166
Hitch Ball.....	149
Hitch Install Kits, Free Ride/Rail Rider.....	144
Hitch Kit, Tri-ball Adjustable.....	151
Hitch Pin 5/8".....	147
Holding Tank Rinsers.....	126
Hook-Up Handle (Comes w/Hitch).....	147
Hook-Up Wire Clip for 48029.....	147

Hose Elbows.....	107
Hose Plug and Cap Replacements.....	110
Hose Protector, Flexible.....	107
Hoses, Fresh Water.....	106
Premium.....	106
Hose Washers.....	108
Hose, Water Fill.....	111
Hybrid Heat™.....	91

I

Ice Cube Trays, Mini.....	64
Ice Cutter™ Spray - 32 oz.....	99
Ironing Board, Folding.....	66

J

Jacks, Scissor.....	163
Juice Glass, BPA-free.....	61

K

Knife Safe™.....	63
Knife Sharpener.....	28

L

Ladder Cover.....	48
Lantern Hanger.....	32
Lantern Snaps.....	9
Lanyards.....	110
Laundry Bag.....	33
Laundry Reel.....	33
LED Bulbs, 12V RV/Marine.....	179
Leg Stands for Wave Heaters.....	88
Leveling Block Caps.....	164
Leveling Blocks.....	164
Leveling Block Wheel Chocks.....	164
Levels	
AccuLevel.....	168
Bullseye Level.....	168
Precision Curved Ball Level.....	168
Standard Level.....	168
T Level.....	168
Trailer Level.....	168
Trailer Levels, Utility.....	168
Light Bulbs.....	180
Lighters	
GasMatches.....	44, 45
GM12 Multi-Sparkers.....	45
Lights, 12V Replacement Dome.....	178
Lights Out!™ Vent Shade.....	73
Little Red Campfire™.....	18
Little Red Campfire™ Cook Top.....	18
Little Red Campfire™ Hose w/Regulator.....	18
Locking Adapter, 30 to 50.....	176
LP Gas Hose, Quick-Connect.....	43
LP Hose, Quick-Connect x ACME.....	43
LP Tank Covers, Vinyl.....	51
Lube Plates, 5th Wheel.....	152
Lubricant, Trailer Hitch.....	149
Lugs, Copper.....	188

M

Magazine Rack, Oak Accents.....	54
Magic Chef® Grommets.....	57
Margarita Glass, BPA-free.....	61
Marine Engine Antifreeze.....	99
Martini Glass, BPA-free.....	61
Microwave Cooking Covers.....	56
Mildew Stain Remover, RV.....	135
Mini Power Grip™ Plug - 30 Amp.....	177
Mirrors, Blind Spot.....	157
Mop Head.....	137
Mosquito Coil Holder.....	34
Multi-Function Tool.....	31
Multi-Purpose Handles.....	137
Multi-Purpose Scissors.....	31
Multi-Surface Degreaser.....	139
Multi-Surface Indoor/Outdoor Cleaner.....	139

N

90° Electrical Adapter.....	172
Non-Slip Tape.....	25

O

Oak Accents™	
Countertop Extension.....	54
Magazine Rack.....	54
Organizer.....	54
Remote Holder.....	54
Sink Cover.....	54
Universal Silent Top™.....	55
Odor Absorber.....	64
Organizer, Oak Accents™.....	54
Outdoor Mat, Open Air™.....	7

P

Party Light Holders	
Fabric Party Light Holders.....	9
Fits-All™ Party Light Holders.....	9
Lantern Snaps.....	9
RV Party Light Holders.....	9
Party Lights.....	8
Bottles & Mugs.....	8
Chili & Cactus.....	8
Flags & Ribbons.....	8
Fuzzy Dice.....	8
Motorhomes.....	8
Race Flags & Tires.....	8
Retro Motorhomes.....	8
Retro Travel Trailers.....	8
Stars.....	8
Party Lights - Flamingos and Palm Trees.....	8
Patch Kit, UltraGuard.....	49
Patch Kit, UltraShield.....	48
Picnic Blankets.....	21
Pilot Assemblies, Gas.....	94
Pilsner Glass, BPA-free.....	61
Plastic Cleaner/Polish, 210®.....	138

Plastic Scratch Remover, 210® Plus.....	138
Plate Holder, Stack-A-Plate™.....	63
Plug, 30 amp Standard Replacement.....	177
P.O.L. Plug Adapter.....	85
Poly Cord.....	35
Pop-A-Bag™.....	59
Pop-A-Bowl™.....	58
Pop-A-Filter™.....	59
Pop-A-Napkin™.....	58
Pop-A-Plate®.....	58
Pop-A-Tissue™.....	59
Pop-A-Toothbrush™.....	66
Pop-A-Towel™.....	58
Pop-A-Wrap™.....	58
Pop-Up Camper Covers.....	49
Pouches, Waterproof.....	33
Power Cord Receptacles, Replacement.....	177
Power Defender™ with PowerGrip™ handles.....	178
Power Grip Extenders.....	173
Power Hook™ Awning Tensioner.....	15
Power Maximizer™.....	173
Power Plugs, Replacement.....	177
Precision Curved Ball Levels.....	168

Propane

Hose Connectors, Pigtail.....	82
Quick-Connect Kit, Low Pressure.....	43
Regulator, Two Stage.....	83
Regulator, Two Stage, Covers.....	83
Tee, 3-Port.....	80
Tee, 90°.....	81
Tee w/Hose, 3-Port.....	80
Tee w/Hose, 90°.....	81
Tee w/Hoses, 4-Port.....	80
Propane 90° Connector Elbow.....	88
Propane Adapter.....	18
Propane Appliance Extension Hose.....	82
Propane Connection Kits.....	80
Propane Cylinder Adapter.....	85
Propane Cylinder Stabilizing Base.....	78
Propane Distribution Post.....	84
Propane Extension Hose.....	81
Propane Fitting - NPT 1/4".....	85
Propane Hose Assembly.....	81, 82
Propane Hoses.....	43
Propane Quick-Connect Kit.....	84
Propane Supply Hose.....	81
Propane Tank Cover, Heavy Duty.....	78
Propane Tank Covers, Vinyl.....	78
Propane Y Adapter.....	85
Protectors, Vinyl Tire.....	51
Pump Converter Winterizing Kit.....	100
Push Bar, Screen Door.....	14

Q

Quick-Connect	
4100 Low Pressure Conversion Kit.....	43
Gas Control Valve.....	43
Quick-Connect Full-Flow Plug.....	84

Quick Hook-Up for hitch	147
Quick Hose Connects, Fresh Water.....	109
Quick Hose Connect Value Pack.....	109
Quickie Flush.....	126

R

Rail Rider™ Hitch	144
Rain Repellent Glass Cleaner.....	139
Rake, Folding	24
Refractometer, Freeze Check.....	100
Refrigerator & Cupboard Bars.....	62
Refrigerator Vent Cover, RV.....	91
Regulator, Automatic Changeover.....	83
Regulator, Single Stage Propane.....	83
Regulator with hose, LP Gas.....	88
Remote Holder, Oak Accents™.....	54
Revolution™ Swivel RV Sewer Kits	119
RhinoEXTREME RV Sewer Kit.....	118
RhinoEXTREME Sewer Hose.....	118
RhinoEXTREME Sewer Hose Extensions.....	118
RhinoFLEX™ sewer hoses and fitting	
Extension Kit-5'	120
RV Sewer Hose.....	120
RV Sewer Kit.....	120
Swivel Bayonet Fitting.....	121
Swivel Elbow Fitting.....	121
Swivel Fittings.....	121
Swivel Lug Fitting.....	121
Wye Fitting.....	121
Roaster, Telescoping.....	19
Roof Vent Kit, RV.....	72
Rope, 50 feet.....	35
Rubber Roof Care System, RV.....	139
Rubber Roof Cleaner and Conditioner.....	134
Rubber Roof Patch Kit.....	74
RV Blade Hardwire Kit.....	154
RV EzLevel™.....	168

S

Salt and Pepper Shaker.....	29
Sav-A-Step Brace.....	169
Saw	
Camp.....	30
Folding.....	30
Pocket.....	30
Scissor Jacks.....	163
Scissors	
Folding.....	31
Multi-Purpose.....	31
Screen Door Awning Savers.....	11
Screen Door Closer Kit, RV.....	25
Screen Door Cross Bar.....	14
Screen Door Grill.....	14
Screen Door Handles.....	14
Screen Door Opener.....	22
Screen Door Push Bar.....	14
Screen Door Slides.....	22
Screen Door Slide Sets.....	22

Screen Door Stationary Pieces.....	22
Screen Door Stops.....	22
Screen Door, Tail Gate.....	15
Screens, Flying Insect.....	90
Self-Clamping™ Sewer Hose.....	117
Self-Stor Step Support.....	169
Self Tap Screw.....	148
Set Screw for Adjustable Ball Mount.....	147
Set Screw (for Quick Hook-Up 48029).....	147
Sewer Cleanout Plug Wrench.....	129
Sewer Fittings	
Clear Sewer Hose Adapters.....	130
Easy Slip®	
Elbow & 4-in-1 Adapter.....	123
Grey Water Drain Adapter.....	123
Ready-to-Use RV Sewer Kit.....	124
RV Internal Hose Coupler.....	122
RV Straight Hose Adapter.....	122
Grey Water Seal.....	123
Internal Hose Coupler, RV.....	131
Plumbing Adapter, 3" Permanent.....	130
Revolution.....	119
RhinoFLEX™.....	121
Swivel Hose Coupler.....	121
Sewer Caps, RV.....	131
Sewer Hose Adapter, RV 45°.....	131
Sewer Hose Seal.....	131
Sewer Hose Splicer Elbow, 90°.....	130
Sewer Hose Wye, 3".....	130
Straight Hose Adapter.....	131
Twist Connect Kit.....	129
Waste Valve, 3" RV.....	131
Sewer Hose Fitting Gaskets.....	123
Sewer Hose Rinse Cap.....	127
Sewer Hoses, RV	
Easy Slip® Travel Pak™.....	124
Heavy Duty.....	117
Heavy Duty with attached fitting.....	117
Revolution™.....	119
RhinoEXTREME.....	118
RhinoFLEX™.....	118
5' Extender Kit with Coupler.....	120
Hose.....	120
RV Sewer Kit.....	120
Self-Clamping™.....	117
Standard.....	117
Super Heavy Duty.....	117
Sewer Hose Storage Caps.....	119
Sewer Hose Supports	
Folding Aluminum.....	128
Hose Support Strap Kit.....	128
Sidewinder™.....	128
Sewing Kit.....	33
Shovel, Foldable.....	31
Shower Flex Hose, RV/Marine.....	67
Showerhead Kits, RV/Marine.....	67
Showerhead Mounts.....	67
Showerhead, Outdoor.....	67

Showerheads, RV/Marine.....	67
Silent Top™, Hardwood, Universal.....	55
Sink Cover, Oak Accents™.....	54
Sink Mat, RV & Marine.....	60
Sleeping Bag Straps.....	35
Slide-In Camper Covers.....	49
Slide Out Lube & Protectant.....	139
Slide Out Rubber Seal Conditioner.....	139
Slideout Supports.....	169
Slip-Stop®.....	62
Snap Fastener Kit.....	34
Soap Dish.....	33
Spare Tire Covers, Vinyl.....	50
Spiral Anchor.....	23
Splash Guard, RV/Marine.....	57
Split Wire Loom.....	186
Sponge, RV Wash.....	135
Spring, Awning.....	13
Spring Bar.....	147
Spring Bar Locking Device Repair Kit.....	147
Spring Clip.....	147, 148
Spring Fresh™.....	106
Squeegee attachment.....	137
Squeegee, Ultimate.....	136
Stabilizer, Adjustable.....	169
Stabilizer Jack Pads.....	167
Stack-A-Plate™.....	63
Stake, Awning.....	13
Standard Levels.....	168
Starter Kits	
Box Kits.....	192
Bucket Kits.....	190, 191
Step Platforms, Aluminum.....	10
Step Rug.....	10
Step Rug XL.....	10
Step Stool	
RV Extra Step.....	10
Step Stool, Fold-Away.....	10
Step Stools.....	10
Stop Leak Connector.....	108
Stove Top Cover, RV Universal Fit.....	57
Stove Toppers	
Decor Mate.....	56
Hardwood.....	55
Stowaway Flexible Cutting Mat.....	56
Strainers, RV Sink-Shower.....	60
Straps, Utility.....	35
Stretch Cord.....	35
Stretch Cords, 20-inch.....	35
Stretch Cords, Mini.....	35
Super Grommets.....	73
Super Wheel Chock.....	167
Survival Whistle.....	31
Sway Control Adapter.....	148
Sway Controls.....	148, 159
Sway Control Slide Bar.....	148
Swivel Stik® Tank Rinsers.....	126

T

Tablecloth Clamps.....	21
Tablecloth Clamps, Deluxe.....	28
Tablecloths.....	28
Table, Roll-up, Aluminum.....	20
Tables, Folding Aluminum.....	20
Tail Gate Screen Door.....	15
Tank Cover Cap Replacement Kits.....	78
Tank Cover Replacement Thumbscrews.....	78
Tape, Awning Repair.....	25
Tape, Electrical.....	189
Tape, Non-Slip.....	25
Tarp Clips.....	34
TastePURE™ Evo™ Premium Water Filter.....	104
Tee, 4-Port.....	80
Tee with 5' hose, 4-Port.....	80
Telescopic Jacks.....	163
Tent Pegs.....	30
Tent Stake Puller.....	30
Tent Stakes.....	30
Tent Whisk with Dust Pan.....	33
T-Handle, Locking.....	73
Thermocouples.....	95
Thermometers, RV Window.....	23
Thermostat, Water Heater.....	92
Tick Remover.....	34
Tipsy Stix®.....	12
Tire Protectors, Vinyl.....	51
T Level.....	168
Toaster Rack for Camp Stoves.....	29
Toilets, Portable.....	125
Toilet & Tank Treatment	
Rhino Enzyme.....	116
TST™	
Drain Valve Lube™.....	116
Drop-INS™.....	114
Grey Water Odor Control.....	115
Liquid.....	114
Probe Cleaner.....	116
Singles.....	114
Tabs.....	114
TST™ Blue Enzyme.....	116
TST™ Ultra Concentrated	
Drop-INS™.....	115
Liquid.....	115
Singles.....	115
Toilet Tissue, RV & Marine.....	114
Tornado Rotary Holding Tank Rinser.....	126
Tow Bar.....	152
Tow Bar Safety Cables.....	152
Tow Bar U-Joint Assembly.....	152
Tow Light Kit.....	183
T & P Relief Valves.....	93
T & P Valve Remover.....	93
Trailer Adapters	
6-Way Round Pin to 4-Way Flat.....	154
7-Way Round Pin to 4-Way Flat.....	154
Blade 7-Way to 4-Way Flat.....	154

Trailer Cable.....	153
Trailer Connector Mounting Bracket.....	156
Trailer Connectors.....	155, 156
4-way.....	156
4-Way Tow Vehicle End.....	155
6-Way.....	156
7-Way Plastic Blade-Type.....	156
7-Way Plastic Round Pin.....	156
Trailer Glitter™ RV Wash.....	135
Trailer Harness, 4-Way Wishbone.....	155
Trailer Hitch Lubricant.....	149
Trailer Jacks.....	163
Trailer Level.....	168
Trailer Test Light, 4-Way.....	155
Trailer Tongue Ball Plate.....	148
Trash Can, Stainless Steel.....	65
Trash Can, Wall-Mount.....	65
Trekker Hitches.....	142
Tri-Leveler™.....	167
Tripod Grill and Lantern Holder.....	28
Tubing, Heat Shrink.....	186

U

Ultimate Squeegee.....	136
UltraGuard Patch Kit.....	49
UltraGuard RV Covers.....	49
UltraShield Patch Kit.....	48
UltraShield RV Covers.....	48
Utility Ball Mount and Shank, Adjustable.....	151
Utility Clips.....	34
Utility Trailer Levels.....	168

V

Valves, Garden Hose Shut-Off.....	109
Valves, Shut-Off.....	109
Van Covers.....	49
Vent Cover.....	73
Vent Cover, Insulated Dual.....	73
Vent Cover Replacement Screen.....	70
Vent Cover, RV Refrigerator.....	91
Vent Covers, RV.....	70
Vent Installation Kits.....	75
Vent Insulator, RV.....	73
Vent Lids.....	72
Vent Lids, Polycarbonate.....	72
Vent Shade, Lights Out™.....	73
Vents & Vent Caps, Plumbing	
Cyclone™ Plumbing Vent.....	125
Plumbing Vent Cap, Replace-All.....	125
Plumbing Vent Kit, Replace-All.....	125
Vinyl Repair Tape.....	34
Vinyl Trim Insert.....	74

W

Wash, Aluminum Care.....	138
Wash Brush, Adjustable RV.....	136
Wash Head - Microfiber Pad.....	137
Wash Head - Synthetic Wool Pad.....	137

Wash & Wax, RV.....	135
Waste Valve, 3" RV.....	131
Water Bandit™.....	107
Water Carrier, Expandable.....	28
Water Diverter.....	107
Water Faucet, 90°.....	107
Water Fill Hose.....	111
Water Fill Replacement.....	111
Water Filter, KDF®/Carbon.....	104
Water Filter, RV/Marine.....	104
Water Filter Stand.....	104
Water Heater	
Anode Rods.....	93
Anode Rod with Drain.....	93
Continuity Tester.....	92
Drain Valves.....	93
Elements.....	92
Screw-in Element Wrench.....	92
Water Heater Drain Plug Kit.....	92
Water Heater Hybrid Heat™.....	91
Water Heater Tank Rinser.....	92
Water Heater Thermostat.....	92
Water Hoses, Drinking.....	106
Water Pressure Regulator.....	108
Water Pressure Regulator with gauge.....	108
Waterproof, RV Awning.....	138
Water Tank Fillers.....	111
Wave™ Catalytic Safety Heaters.....	88
Wax Sealant, RV.....	135
Weight Distributing Hitches.....	146, 147
Wheel Chocks.....	167
Wheel Chock, Super.....	167
Wheel Chock with rope.....	167
Wheel Dock™.....	167
Wheel Stop™.....	165
Wheel Stop™, Locking.....	165
Wheel Stop™, Metal.....	165
Whiskbroom and Dust Pan.....	66
Wide Angle Blind Spot Mirror.....	157
Window Covers, Reflective.....	51
Windshield Covers, Class C.....	50
Windshield Protector, Tow Car.....	159
Wine Glass, BPA-free.....	61
Winter Ban -50.....	99
Winter Ban -100.....	99
Wiper Stand-Off Wedges.....	51
Wire	
Bonded.....	188
Brake.....	153
Primary.....	188
Wire Stripper, Self-Adjusting.....	188
Wrench, Water Heater Drain Valve.....	93

X

Xtra View Mirror.....	157
-----------------------	-----

01	Trailer Aid®, Yellow.....	159	11562	Anode rod for Suburban (Mor-Flo).....	93	23303	Backflow Preventer - 1/2".....	108
02	Trailer Aid®, Black.....	159	11563	Anode rod for Suburban (Mor-Flo).....	93	23402	Backflow Preventer - 3/4".....	108
03	Trailer Aid® Plus, Yellow.....	159	11593	Anode Rod for 10-gal Atwood.....	93	25003	Vent Installation Kit for metal roofs.....	75
04	Trailer Aid® Plus, Black.....	159	11630	Water Heater Drain Plugs, set of 2.....	92	25013	Vent Installation Kit for rubber roofs.....	75
21	Trailer Aid®, Yellow.....	159	11632	Water Heater Drain Plug, Bulk.....	92	25071	Roof Air Conditioner Gasket Kit.....	91
22	Trailer Aid®, Black.....	159	11633	Water Heater Drain Plug Kit.....	92	25084	Camper Mounting Tape.....	75
23	Trailer Aid® Plus, Yellow.....	159	11653	Water Heater Drain Valve Wrench.....	93	25093	Vinyl Trim Insert - beige.....	74
24	Trailer Aid® Plus, Black.....	159	11663	1/4" Water Heater Drain Valve.....	93	25103	Vinyl Trim Insert - white.....	74
55	Trailer Aid® Holder.....	159	11673	RV Water Heater Hybrid Heat™ - 6 gal.....	91	25113	Vinyl Trim Insert - black.....	74
02103	Screw-in Water Heater Element.....	92	11674	6 gal. Hybrid Heat Element.....	91	25123	Vinyl Trim Insert - colonial white.....	74
02143	Screw-in Water Heater Element.....	92	11683	3/8" Water Heater Drain Valve.....	93	25133	Vinyl Trim Insert - brown.....	74
04363	Universal Water Heater Element.....	92	11691	Water Heater Tank Rinser.....	92	25143	Vinyl Trim Insert - colonial white.....	74
08143	TOD Water Heater Thermostat.....	92	11703	1/2" Water Heater Drain Valve.....	93	25153	Vinyl Trim Insert - beige.....	74
08601	Gas Control RV-50A.....	94	11773	RV Water Heater Hybrid Heat™ - 10 gal.....	91	25163	Vinyl Trim Insert - white.....	74
08621	Gas Control RV-50C.....	94	11774	10 gal. Hybrid Heat Element.....	91	25173	Vinyl Trim Insert - black.....	74
08631	Gas Control RV-50D.....	94	20003	Shut-Off Valve-Plastic straight.....	109	25192	Vinyl Trim Insert - beige.....	74
08641	Gas Control RV-50G.....	94	20073	Shut-Off Valve-Plastic Y.....	109	25202	Vinyl Trim Insert - white.....	74
08651	Gas Control RV-50J.....	94	20103	Plastic Quick Hose Connect.....	109	25212	Vinyl Trim Insert - black.....	74
08763	RV Gas Pilot Assembly 9".....	94	20113	Shut-Off Valve - Metal Y.....	109	25222	Vinyl Trim Insert - colonial white.....	74
08773	RV Gas Pilot Assembly 9".....	94	20123	Shut-Off Valve - Brass Y.....	109	25232	Vinyl Trim Insert - brown.....	74
08783	RV Gas Pilot Assembly.....	94	20135	Brass Quick Hose Connect.....	109	25242	Vinyl Trim Insert - colonial white.....	74
09103	Gas Burner Tube Cleaner.....	95	20136	Quick Hose Connect Value Pack.....	109	25252	Vinyl Trim Insert - beige.....	74
09203	Plastic Water Heater Cam Locks.....	92	20143	Brass Water Connector/flow-through.....	109	25262	Vinyl Trim Insert - white.....	74
09213	Steel Water Heater Cam Locks.....	92	20153	Hose Washers.....	108	25272	Vinyl Trim Insert - black.....	74
09221	Heat and Cool Wall Thermostat.....	91	20173	Shut-Off Valve - Brass 45°.....	109	25292	Vinyl Trim Insert - beige.....	74
09231	Heat Only Wall Thermostat.....	91	20183	1" Filter Washers.....	108	25302	Vinyl Trim Insert - white.....	74
09253	12" Universal Thermocouple Kit.....	95	20213	Stop Leak Connector.....	108	25312	Vinyl Trim Insert - black.....	74
09273	18" Universal Thermocouple Kit.....	95	22062	Snap-Fit Lanyard.....	110	25322	Vinyl Trim Insert - colonial white.....	74
09293	24" Universal Thermocouple Kit.....	95	22072	New Style Lanyard.....	110	25401	Non-Slip Tape, black.....	25
09313	30" Universal Thermocouple Kit.....	95	22103	Male plug with lanyard.....	110	25405	Non-Slip Tape, black & yellow.....	25
09333	36" Universal Thermocouple Kit.....	95	22204	Female dust cap with lanyard.....	110	25503	Utility Trailer Levels.....	168
09353	48" Universal Thermocouple Kit.....	95	22223	Dual size drain valve w/flange.....	110	25505	RV EzLevel.....	168
09883	Screw-in Element Wrench.....	92	22243	Dual Size Drain Valve w/o flange.....	110	25523	Standard Level.....	168
09951	Professional Element Socket.....	92	22463	90° Water Faucet.....	107	25533	Trailer Level.....	168
09953	Professional Element Socket - Clamshell.....	92	22475	Water Diverter.....	107	25543	T Level.....	168
09963	Gas Control Wrench.....	94	22484	Water Bandit.....	107	25553	Precision Curved Ball Levels.....	168
10023	Water Heater Continuity Tester.....	92	22505	90° Hose Elbow.....	107	25563	AccuLevel™.....	168
10324	Gas Leak Detector w/sprayer - 8 oz.....	95	22605	45° Hose Elbow.....	107	25573	Bullseye Level.....	168
10325	Gas Leak Detector w/dauber - 8 oz.....	95	22703	Flexible Hose Protector.....	107	25583	Brackets for AccuLevel™.....	168
10367	Gas Leak Detector - gal.....	95	22733	25' Fresh Water Hose.....	106	25593	Blind Spot Mirrors.....	157
10368	Gas Leak Detector - 55 gal.....	95	22743	10' Fresh Water Hose.....	106	25603	Convex Blind Spot Mirror.....	157
10389	Gas Pressure Test Kit.....	95	22753	50' Fresh Water Hose.....	106	25613	Convex Round Mirror.....	157
10399	Replacement nipple for GPT Kit.....	95	22763	4' Fresh Water Hose.....	106	25623	Wide Angle Mirror.....	157
10409	Replacement hose for GPT Kit.....	95	22783	25' Fresh Water Hose.....	106	25633	Xtra View Mirror.....	157
10421	1/2" T & P Valve with 4" probe.....	93	22793	50' Fresh Water Hose.....	106	25643	360° Blind Spot Mirror.....	157
10423	1/2" T & P Valve with 4" probe.....	93	22803	75' Fresh Water Hose.....	106	25663	Tow-N-See™ Flat.....	157
10463	3/4" T & P Valve with 1" probe.....	93	22823	10' Premium Drinking Water Hose.....	106	25668	Tow-N-See™ Convex.....	157
10471	3/4" T & P Valve with 4" probe.....	93	22833	25' Premium Drinking Water Hose.....	106	30027	Boiler Antifreeze -100° - gal.....	95, 99
10473	3/4" T & P Valve with 4" probe.....	93	22843	35, Premium Drinking Water Hose.....	106	30028	Boiler Antifreeze -100° - 55 gal.....	95, 99
10552	T & P Valve Remover.....	93	22853	50' Premium Drinking Water Hose.....	106	30029	Boiler Antifreeze -100° - 5 gal.....	95, 99
11533	Water Heater Anode Rod with Drain.....	93	22900	12 ft Cold Weather Hose.....	106	30522	Ice Cutter™ Spray - 32 oz.....	99
11552	Anode rod for Atwood.....	93	22902	25 ft Cold Weather Hose.....	106	30626	Premium Ban Frost 2000®.....	99
11553	Anode rod for Atwood.....	93	22903	50 ft Cold Weather Hose.....	106	30627	BanFrost 2000® Marine Engine Antifreeze - gal.....	99

30628 BanFrost 2000® Marine Engine Antifreeze - 55 gal.....	99	39462 RV Sewer Cap with hose connection.....	131	40045 Water Filters - 2 pack.....	104
30629 BanFrost 2000® Marine Engine Antifreeze - 5 gal.....	99	39463 RV Sewer Cap with hose connection.....	131	40052 Water Pressure Regulator - 3/4" Brass.....	108
30647 Winter Ban -50 - gal.....	99	39471 Revolution Elbow with 4-in-1 Adapter.....	119	40055 Water Pressure Regulator - 3/4" Brass.....	108
30767 Freeze Ban -50 - gal.....	99	39481 Revolution Bayonet Fitting.....	119	40064 Water Pressure Regulator with gauge.....	108
30768 Freeze Ban -50 - 55 gal.....	99	39491 Revolution Lug Fitting.....	119	40074 RV Flexible Swivel Stik™.....	126
30769 Freeze Ban -50 - 5 gal.....	99	39513 3" RV Waste Valve.....	131	40083 Faucet Adapter.....	126
30787 Winter Ban -100 - gal.....	99	39533 Sewer Hose Rinse Cap.....	127	40094 RV Swivel Stik™.....	126
30788 Winter Ban -100 - 55 gal.....	99	39543 RV Twist Connect Kit.....	129	40103 Holding Tank Rinser with valve.....	126
33116 Boiler Antifreeze AL - 3.5 gal.....	95	39551 Easy Slip® Ready-to-Use RV Sewer Kit.....	124	40113 Holding Tank Rinser Kit.....	126
33118 Boiler Antifreeze AL - 55 gal.....	95, 98	39553 RV Sewer Hose Twist-It™ Clamps.....	129	40123 Quickie Flush™ with 8' hose.....	126
33119 Boiler Antifreeze AL - 5 gal.....	95, 98	39572 5" Clear Sewer Hose Adapter.....	130	40126 Tornado™ Rotary Tank Rinser Kit with 6' hose.....	126
35116 Boiler Antifreeze Concentrate, 32 oz.....	95, 99	39582 7" Clear Sewer Hose Adapter.....	130	40128 Tornado™ Rotary Tank Rinser without hose.....	126
35713 Seasonal By-Pass Kit.....	98	39592 9" Clear Sewer Hose Adapter.....	130	40132 Replace-All Plumbing Vent - beige.....	125
35953 Supreme Permanent By-Pass Kit for 6 gal.....	98	39601 Standard RV Sewer Hose - 10'.....	117	40133 Replace-All Plumbing Vent Kit - colonial white.....	125
35963 Supreme Permanent By-Pass Kit for 10 gal.....	98	39611 Standard RV Sewer Hose - 20'.....	117	40134 Replace-All Plumbing Vent Cap - beige.....	125
35983 Quick-Turn Permanent By-Pass Kit.....	98	39621 Heavy Duty RV Sewer Hose - 10'.....	117	40143 Water Pressure Regulator - 3/4" Plastic.....	108
36003 Hand Pump Kit.....	100	39623 Revolution 10' Extension.....	119	40147 Polypropylene Vent Lid.....	72
36011 Antifreeze pH Test Strips.....	95, 99	39625 Revolution RV Sewer Kit.....	119	40148 Polypropylene Vent Lid.....	72
36103 Blow-out Plugs-Plastic.....	100	39631 Heavy Duty RV Sewer Hose - 20'.....	117	40151 Polypropylene Vent Lid.....	72
36104 Blow-out Plugs-Plastic.....	100	39641 Super Heavy Duty RV Sewer Hose - 10'.....	117	40153 Polypropylene Vent Lid.....	72
36143 Blow-Out Plug, Quick-Connect Style.....	100	39651 Super Heavy Duty RV Sewer Hose - 20'.....	117	40154 Polypropylene Vent Lid.....	72
36153 Blow-out Plugs-Brass.....	100	39661 Heavy Duty RV Sewer Hose - 15'.....	117	40155 Polypropylene Vent Lid.....	72
36543 Pump Converter Winterizing Kit.....	100	39671 RhinoFLEX™ RV Sewer Hose - 10'.....	120	40156 Polypropylene Vent Lid.....	72
36601 Plastic Water Fill Hose.....	111	39681 RhinoFLEX™ RV Sewer Hose - 15'.....	120	40160 Polycarbonate Vent Lid.....	72
37002 Flush Mount Fill Spout.....	111	39691 Heavy Duty RV Sewer Hose with fitting - 15'.....	117	40161 Polycarbonate Vent Lid.....	72
37102 Fill Spout with Door.....	111	39733 RhinoFLEX™ Swivel Elbow Fitting.....	121	40162 Polycarbonate Vent Lid.....	72
37221 Recessed Water Fill.....	111	39741 RhinoFLEX Sewer Kit - 20'.....	120	40193 TastePURE™ Fresh Tabs 6/pack.....	106
37262 Camper Drain Trap.....	110	39753 Sewer Hose Storage Caps.....	119	40206 TastePURE™ Drinking Water Freshener - 16 oz.....	106
37271 Evacuation Flange.....	110	39755 Sewer Cleanout Wrench.....	129	40207 TastePURE™ Spring Fresh™ - gal.....	106
37420 Flexible Camper Drain.....	110	39761 RhinoFLEX Sewer Kit - 15'.....	120	40221 TST™ Singles-8 treatments.....	114
37463 3-Way By-Pass Valve replacement.....	98	39764 RhinoFLEX™ Extension Kit - 10'.....	120	40224 TST™ liquid - 32 oz. measuring bottle.....	114
39062 Dual Flush™ PRO.....	127	39765 RhinoFLEX™ Extension Kit - 5'.....	120	40225 TST™ Liquid - 64 oz.....	114
39072 Dual Flush™.....	127	39773 RhinoFLEX™ Swivel Lug Fitting.....	121	40226 TST™ liquid - 32 oz.....	114
39103 Multi-Clamp™.....	129	39783 RhinoFLEX™ Swivel Bayonet Fitting.....	121	40227 TST™ liquid - gal.....	114
39111 Easy Slip® Grey Water Drain Adapter.....	123	39803 RhinoFLEX Locking Rings.....	120	40246 TST™ Drain Valve Lube™ - 16 oz.....	116
39144 Easy Slip® 4-in-1 Sewer Adapter.....	123	39812 RhinoFLEX Wye.....	121	40252 TST™ Grey Water Odor Control - 32 oz.....	115
39162 Easy Slip® RV Internal Hose Coupler.....	122	39821 RhinoFLEX™ RV Sewer Hose Coupler.....	121	40256 TST™ Grey Water Odor Control - 64 oz.....	115
39163 Easy Slip® RV Internal Hose Coupler.....	122	39834 Sewer Hose Fitting Gaskets.....	123	40264 TST™ Drop-INS™-15/bag.....	114
39172 Easy Slip® RV Straight Hose Adapter.....	122	39842 45° RhinoFLEX Fitting.....	121	40274 RV & Marine Toilet Tissue-2 Ply.....	114
39173 Easy Slip® RV Straight Hose Adapter.....	122	39847 45° RhinoFLEX Clear Fitting.....	121	40276 RV & Marine Toilet Tissue-1 Ply.....	114
39202 RV Internal Hose Coupler.....	131	39852 90° RhinoFLEX Fitting.....	121	40285 RV Sanitation Gloves.....	123
39203 RV Internal Hose Coupler.....	131	39857 90° RhinoFLEX Clear Fitting.....	121	40302 Bumper Caps - Bulk.....	130
39232 90° Sewer Hose Splicer Elbow.....	130	39861 RhinoEXTREME Kit - 15 ft.....	118	40303 Bumper Caps - 2/pack.....	130
39272 3" Sewer Hose Wye.....	130	39862 RhinoEXTREME Sewer Hose.....	118	40322 Bumper Cap w/Insect Screen - Bulk.....	130
39312 RV Sewer Hose Seal.....	131	39863 RhinoEXTREME Extension - 10'.....	118	40324 Bumper Cap w/Insect Screen - Cap w/Saver.....	130
39313 RV Sewer Hose Seal.....	131	39865 RhinoEXTREME Extension - 5'.....	118	40325 Bumper Cap w/Insect Screen - 2-pack.....	130
39322 Grey Water Seal.....	123	39867 RhinoEXTREME Kit - 20 ft.....	118	40351 Aluminum Folding Sewer Hose Support.....	128
39402 RV 45° Hose Adapter.....	131	39901 Self-Clamping™ RV Sewer Hose - 15'.....	117	40421 Aero-flo™ RV Roof Vent Cover - white.....	71
39403 RV 45° Hose Adapter.....	131	40003 Water Tank Filler w/shut-off valve.....	111	40431 Camco Vent Cover - white.....	70
39412 RV Straight Hose Adapter.....	131	40023 Water Tank Filler w/o shut-off valve.....	111	40433 Camco Vent Cover - white.....	70
39413 RV Straight Hose Adapter.....	131	40032 Replace-All Plumbing Vent - polar white.....	125	40439 Vent Cover Replacement Screen.....	70
39422 3" Permanent Plumbing Adapter.....	130	40033 Replace-All Plumbing Vent Kit - polar white.....	125	40443 Camco Vent Cover - black.....	70
39432 C-Do2™ 45° Hose Adapter.....	127	40034 Replace-All Plumbing Vent Cap - polar white.....	125	40453 Camco Vent Cover - smoke.....	70
39452 RV Sewer Cap - bulk.....	131	40043 TastePURE™ KDF® Carbon Water Filter.....	104	40463 Camco Vent Cover - champagne.....	70

40473 – 42654

40473 Camco Vent Cover - silver.....	70	41191 TST™ Ultra Concentrated Singles-8 treatments.....	115	42083 DeFlapper Replacement Straps.....	15
40480 RV Roof Vent Kit.....	72	41192 TST™ Ultra Concentrated - 32 oz.....	115	42093 Replacement charcoal packs for Fridge Airator™.....	64
40492 Wash & Wax - 32 oz.....	135	41197 TST™ Ultra Concentrated - gal.....	115	42110 Gutter Extensions - black.....	75
40497 Wash & Wax - gal.....	135	41263 Bulb, 93 Auto.....	181	42123 Gutter Extensions - white.....	75
40523 Heavy Duty Propane Tank Cover - polar white.....	78	41273 Bulb, 1141 Auto Dome.....	181	42134 Gutter Spouts with Extensions - white.....	75
40525 Heavy Duty Propane Tank Cover - colonial white.....	78	41313 12V Fluorescent Bulb.....	184	42140 Flying Insect Screen FUR100.....	90
40529 Heavy Duty Propane Tank Cover - brown.....	78	41320 Double Replacement Dome Light.....	178	42141 Flying Insect Screen FUR200.....	90
40531 Heavy Duty Propane Tank Cover - champagne.....	78	41330 Single Replacement Dome Light.....	178	42142 Flying Insect Screen FUR300.....	90
40532 Heavy Duty Propane Tank Cover - bronze.....	78	41392 Bug & Tar Cutter™ - 32 oz.....	138	42143 Flying Insect Screen FUR400.....	90
40532 Heavy Duty Propane Tank Cover - colonial white.....	78	41422 RV Citrus Multi-Purpose Cleaner™ - 32 oz.....	138	42144 Flying Insect Screen FUR500.....	90
40533 Tank Cover Replacement Cap - colonial white.....	78	41442 Rubber Roof Protectant - 32 oz.....	139	42145 Flying Insect Screen WH500.....	90
40534 Tank Cover Replacement Cap - colonial white.....	78	41447 RV Roof Protectant - gal.....	139	42146 Flying Insect Screen WH600.....	90
40539 Heavy Duty Propane Tank Cover - black.....	78	41451 Pro-Tec™ RV Rubber Roof Care System.....	139	42147 Flying Insect Screen ST500.....	90
40542 Heavy Duty Propane Tank Cover - polar white.....	78	41461 Pro-Tec™ Rubber Roof Patch Kit.....	74	42148 Flying Insect Screen RS500.....	90
40543 Tank Cover Replacement Cap - polar white.....	78	41501 TST™ Blue Enzyme Singles.....	116	42149 Flying Insect Screen RS600.....	90
40544 Tank Cover Replacement Cap - polar white.....	78	41502 TST™ Blue Enzyme 32 oz.....	116	42150 WH200 Insect Screen.....	90
40547 Propane Tank Thumbscrew Replacements.....	78	41506 TST™ Blue Enzyme 64 oz.....	116	42151 WH400 Insect Screen.....	90
40548 Tank Cover Replacement Cap - bronze.....	78	41507 TST™ Blue Enzyme Gallon.....	116	42152 PL100 Insect Screen.....	90
40549 Tank Cover Replacement Cap - black.....	78	41511 Rhino Enzyme Singles.....	116	42153 RS700 Insect Screen.....	90
40550 Tank Cover Replacement Cap - champagne.....	78	41512 Rhino Enzyme 16 oz.....	116	42154 RS800 Insect Screen.....	90
40553 Sewer Hose Support Strap Kit.....	128	41514 Rhino Enzyme 64 oz.....	116	42160 Refrigerator Roof Vent Cover.....	91
40571 Easy Slip® Travel Pak™ 20.....	124	41515 Rhino Enzyme Single.....	116	42161 Refrigerator Vent Base.....	91
40593 Cyclone™ Plumbing Vent.....	125	41529 TST™ Blue Enzyme Drop-INS 10/bag.....	116	42162 Solar Panel and Fan.....	91
40602 Trailer Glitter™ - 32 oz.....	135	41531 2.5-gallon Portable Toilet.....	125	42165 Fridge Roof Vent System w/solar panel & fan.....	91
40607 Trailer Glitter™ - gal.....	135	41541 5.6-gallon Portable Toilet.....	125	42171 Folding Rake.....	24
40612 Aluminum Care Wash.....	138	41782 Glass Cleaner - 32 oz.....	139	42183 Screen Door Cross Bar - Black.....	14
40621 Evo™ Spun PP Cartridge.....	104	41867 Pressure Washer Boat/RV Wash.....	136	42186 Screen Door Cross Bar - White.....	14
40624 Evo™ VOC Water Filter Cartridge.....	104	41872 Indoor/Outdoor Cleaner - 32 oz.....	139	42193 Slide-Out Corner Guards - white.....	75
40631 Evo™ Premium Water Filter.....	104	41882 Degreaser - 32 oz.....	139	42203 Slide-Out Corner Guards - black.....	75
40635 Evo™ Mounting Bracket.....	104	41892 Blast-Out Degreaser - 32 oz.....	136	42243 DeFlapper MAX replacement straps.....	15
40645 TastePURE™ RV & Marine Water Filter.....	104	41897 Blast-Out Degreaser - gallon.....	136	42251 De-Flapper™ MAX.....	15
40772 Water Filter Stand.....	104	41900 Multi-Purpose Handle - 2'.....	137	42273 RV Sink-Shower Strainers.....	60
40914 AquaBlock™ Waterproofing - 22 oz.....	134	41902 Multi-Purpose Handle - 4'.....	137	42281 Grease Bin.....	62
40922 Carnuba Wash & Wax - 32 oz.....	134	41910 Multi-Purpose Handle - 2'-4'.....	137	42285 Grease Bin Replacement Bags.....	62
40927 Carnuba Wash & Wax - gallon.....	134	41912 Multi-Purpose Handle - 3'-6'.....	137	42303 Awning Knobs - Faulkner/A & E.....	25
40931 210® Plastic Cleaner/Polish, 7 oz.....	138	41914 Multi-Purpose Handle - 5' - 9'.....	137	42323 Gutter Spouts with Extensions - Black.....	75
40934 210® Plastic Cleaner/Polish, 14 oz.....	138	41916 Multi-Purpose Handle - 6'-11'.....	137	42363 Awning Knobs - Carefree.....	25
40944 210® Plus Plastic Scratch Remover, 15 oz.....	138	41920 Brush Head - Extra soft.....	137	42403 Awning Locking Pins.....	25
41002 Black Streak Remover - 32 oz.....	134	41922 Brush Head - Soft.....	137	42503 Awning Straps.....	25
41004 Black Streak Remover - gal.....	134	41924 Brush Head - Medium.....	137	42504 Window Awning Straps.....	11
41010 RV Wax Sealant.....	135	41926 Brush Head - Stiff.....	137	42505 Patio Awning Strap.....	11
41022 Awning Cleaner - 32 oz.....	134	41930 Wash head w/Pad.....	137	42514 Awning Hold Down Strap Kit.....	13
41027 Awning Cleaner - gal.....	134	41932 Replacement Pad.....	137	42522 Awning Stake.....	13
41040 Color & Finish Restorer - 32 oz.....	135	41934 Mop Head.....	137	42532 7" Awning Spring.....	13
41062 Rubber Roof Cleaner & Conditioner - 32 oz.....	134	41936 Squeegee.....	137	42544 Easy Reach RV Awning Opener.....	11
41065 Rubber Roof Cleaner - 32 oz.....	139	41938 Squeegee Adapter.....	137	42551 RV Awning-Clamp™ - White.....	12
41067 RV Roof Cleaner - gal.....	139	41948 Wash Head w/Pad.....	137	42556 RV Awning-Clamp™ - Black.....	12
41072 RV Awning Waterproofing.....	138	41950 Replacement Pad.....	137	42563 Awning Stabilizer Kit.....	13
41092 RV Mildew Stain Remover.....	135	42003 Awning Roller.....	11	42572 Spiral Anchor.....	23
41105 Slide Out Lube & Protectant.....	139	42005 Awning Door Roller Ball.....	11	42593 Awning Anchor Kit.....	13
41135 Slide Out Rubber Seal Conditioner.....	139	42013 Power Hook™ Awning Tensioner.....	15	42613 Awning Repair Tape - 3" x 15'.....	25
41146 TST™ Probe Cleaner - 32 oz.....	116	42021 Awning Arm Anchor.....	15	42623 Awning Repair Tape - 5" x 15'.....	25
41152 TST™ Tabs.....	114	42061 De-Flapper™.....	15	42653 Motorhome Party Lights.....	8
41189 TST™ Ultra Concentrated Drop-INS™.....	115	42073 Screen Door Awning Savers.....	11	42654 Retro Motorhome Party Lights.....	8

42655 Retro Travel Trailer Party Lights.....	8	42983 Recycle Container.....	24	43733 Ultimate Squeegee with handle.....	136
42656 Star Party Lights.....	8	42993 RV Collapsible Bucket.....	24	43742 Ultimate Squeegee / no handle.....	136
42657 Flag and Ribbon Party Lights.....	8	43031 Sidewinder™ for 10' hose.....	128	43753 Hardwood Stove Topper/Cutting Board.....	55
42658 Race Flag and Tire Party Lights.....	8	43041 Sidewinder™ for 15' hose.....	128	43763 Showerhead Gasket.....	67
42659 Chili & Cactus Party Lights.....	8	43051 Sidewinder™ for 20' hose.....	128	43770 Stowaway Flexible Cutting Mat.....	56
42660 Fuzzy Dice Party Lights.....	8	43061 Sidewinder™ for 30' hose.....	128	43781 RV Wall Clock.....	65
42661 Bottles and Mugs Party Lights.....	8	43277 Slip-Stop®, 1' x 12' roll - cream.....	62	43790 Microwave Cooking Covers.....	56
42662 Party Lights - Flamingos and Palm Trees.....	8	43278 Slip-Stop®, 1' x 12' roll - slate blue.....	62	43800 Gas Stove Burner Liners.....	57
42693 Fits-All™ RV Party Light Holders.....	9	43411 Oak Accents™ Magazine Rack.....	54	43823 Refrigerator Bars - oak look.....	62
42703 RV Party Light Holders.....	9	43421 Oak Accents™ Countertop Extension.....	54	43833 Cupboard Bars - oak look.....	62
42713 Lantern Snaps.....	9	43431 Oak Accents™ Sink Cover.....	54	43857 Sink Mate Cutting Board - white.....	56
42720 RV Awning Hanger Clips.....	9	43460 Stool, Plastic, Small.....	10	43859 Sink Mate Cutting Board - almond.....	56
42733 Fabric Party Light Holders.....	9	43470 Stool, Plastic, Large.....	10	43861 Wine Glasses - BPA-free.....	61
42800 Picnic Blanket - Black/Yellow.....	21	43483 Oak Accents™ Organizer.....	54	43871 Tumbler style Glasses - BPA-free.....	61
42801 Picnic Blanket - Red/White.....	21	43503 Adjustable Cutlery Tray.....	63	43881 Juice Glasses - BPA-free.....	61
42805 Handy Mat.....	21	43508 Cutlery Tray.....	63	43891 Pilsner Glasses - BPA-free.....	61
42810 Awning/Leisure Mat.....	6	43511 Mini Dish Drainer.....	60	43901 Martini Glasses - BPA-free.....	61
42811 Premium Awning Mat - Brown.....	6	43516 Mini Dishpan.....	60	43902 Margarita Glasses - BPA-free.....	61
42812 Premium Awning Mat - Gray.....	6	43521 Oak Accents™ Silent Top™.....	55	43904 Folding Ironing Board.....	66
42820 Awning Mat - green - 9' x 12'.....	6	43533 Oak Accents™ Remote Holder.....	54	43931 Stainless Steel Trash Can.....	65
42821 Awning Mat - blue - 9' x 12'.....	6	43542 Bamboo Cutting Board with finger hole.....	55	43945 Dust Pan and Whiskbroom.....	66
42830 Outdoor Mat - Green Botanical.....	7	43544 Bamboo Cutting Board with handle.....	55	43953 Screen Door Opener.....	22
42831 Outdoor Mat - Blue Botanical.....	7	43546 Bamboo Cutting Board with feet.....	55	43961 Wall-Mount Trash Can.....	65
42832 Outdoor Mat - Burgundy Botanical.....	7	43554 Stove Top Cover - black.....	57	43971 Push Bar - aluminum.....	14
42833 Outdoor Mat - Charcoal Botanical.....	7	43557 Stove Top Cover - white.....	57	43977 Push Bar - white.....	14
42840 Outdoor Mat - Green Swirl.....	7	43559 Stove Top Cover - almond.....	57	43980 Standard Grille - aluminum.....	14
42841 Outdoor Mat - Blue Swirl.....	7	43581 Knife Safe, white.....	63	43991 Deluxe Grille - aluminum.....	14
42842 Outdoor Mat - Burgundy Swirl.....	7	43583 Knife Safe, beige.....	63	43997 Deluxe Grille - white.....	14
42843 Outdoor Mat - Charcoal Swirl.....	7	43601 Stack-A-Plate.....	63	44003 Tablecloth Clamps.....	21
42850 Outdoor Mat - Green Oriental.....	7	43614 Magic Chef® Grommets.....	57	44014 Telescoping Roaster.....	19
42851 Outdoor Mat - Blue Oriental.....	7	43623 RV/Marine Broom and Dustpan.....	66	44023 Outdoor Showerhead.....	67
42852 Outdoor Mat - Burgundy Oriental.....	7	43633 Adjustable RV Wash Brush.....	136	44033 Fridge Brace™.....	64
42853 Outdoor Mat - Charcoal Oriental.....	7	43653 Coffee Filter Dispenser.....	59	44043 Adjustable Drink Holder - brown.....	63
42870 Outdoor Mat - Green Stripe.....	7	43671 Self-Stor Step Support.....	169	44044 Adjustable Drink Holder - black.....	63
42871 Outdoor Mat - Blue Stripe.....	7	43672 Folding Stool.....	10	44053 Refrigerator Bars - white.....	62
42872 Outdoor Mat - Burgundy Stripe.....	7	43675 RV Extra Step.....	10	44063 Cupboard Bars - white.....	62
42873 Outdoor Mat - Charcoal Stripe.....	7	43676 Step Platform, Aluminum, Adjustable Legs.....	10	44073 Double Refrigerator Bar - white.....	62
42880 Awning Mat - green - 6 x 9.....	6	43677 Step Platform, Aluminum, Fixed Legs.....	10	44093 Double Cupboard Bar - white.....	62
42881 Awning Mat - blue - 6 x 9.....	6	43681 Sav-A-Step Brace.....	169	44100 Mini Ice Cube Trays.....	64
42882 Awning Mat - burgundy - 6 x 9.....	6	43691 Sav-A-Step Brace.....	169	44123 Fridge Airator™.....	64
42883 Awning Mat - brown - 6 x 9.....	6	43704 Decor-Mate Stove Topper - black.....	56	44133 Screen Door Closer Kit.....	25
42893 Pop-Up Utility Container.....	24	43707 Decor-Mate Stove Topper - white.....	56	44163 Baggage Door Catches - colonial white.....	74
42895 XL Container.....	24	43709 Decor-Mate Stove Topper - almond.....	56	44173 Baggage Door Catches - polar white.....	74
42903 Mini Pop-Up Container.....	24	43710 RV/Marine Showerhead - chrome.....	67	44184 Fridge Odor Absorber.....	64
42913 Lights Out™ Vent Shade.....	73	43711 RV/Marine Showerhead - white.....	67	44191 Odor Absorber.....	64
42921 Step Rug - brown.....	10	43712 RV/Marine Showerhead - off-white.....	67	44195 Mini Dehumidifier.....	65
42923 Step Rug - green.....	10	43713 RV/Marine Showerhead Kit - chrome.....	67	44203 Side Mount Cabinet Catches.....	74
42924 Step Rug - blue.....	10	43714 RV/Marine Showerhead Kit - white.....	67	44253 RV/Marine Splash Guard.....	57
42925 Step Rug - grey.....	10	43715 RV/Marine Showerhead Kit - off-white.....	67	44293 ACE Key Baggage Lock - 5/8".....	74
42931 Step Rug XL - Brown.....	10	43716 RV/Marine Shower Flex Hose - chrome.....	67	44303 ACE Key Baggage Lock - 7/8".....	74
42933 Step Rug XL - Green.....	10	43717 RV/Marine Shower Flex Hose - white.....	67	44313 RV Window Thermometers.....	23
42934 Step Rug XL - Blue.....	10	43718 Showerhead Mount - Two-Position.....	67	44323 Cam Locks 7/8" - thumb operated.....	74
42935 Step Rug XL - grey.....	10	43719 Showerhead Mount - Adjustable.....	67	44333 Cam Locks 5/8" - thumb operated.....	74
42973 XL Collapsible Bucket.....	136	43720 RV & Marine Sink Mat.....	60	44340 Baggage Lock - 5/8".....	74

44353 – 45593

44353	Baggage Lock - 7/8"	74	44872	Gen-turi™ 18" extension with coupler	79	45352	Spare Tire Cover	50
44363	Baggage Lock - 1-1/8"	74	44881	Gen-turi™ Transfer Kit	79	45353	Spare Tire Cover	50
44368	1-3/8" Baggage Lock	74	44892	Gen-turi Aluminum Hooks w/tape	79	45354	Spare Tire Cover	50
44393	Locking T-Handle	73	44894	Gen-turi Bungee	79	45355	Spare Tire Cover	50
44401	Leveling Block Wheel Chocks	164	45141	Tail Gate Screen Door	15	45356	Spare Tire Cover	50
44412	Wheel Chock	167	45161	Reflective Window Cover	51	45357	Spare Tire Cover	50
44432	Wheel Chock	167	45162	Reflective Window Cover	51	45358	Spare Tire Cover	50
44461	Gen-turi™	79	45163	Reflective Window Cover	51	45359	Spare Tire Cover	50
44472	Wheel Chock with rope	167	45164	Reflective Window Cover	51	45391	AC Cover	50
44487	Trailer-Aid - Yellow	159	45165	Reflective Window Cover	51	45392	AC Cover	50
44492	Super Wheel Chock	167	45166	Reflective Window Cover	51	45393	AC Cover	50
44500	Leveling Block Caps	164	45167	Reflective Window Cover	51	45394	AC Cover	50
44501	4 Leveling Block Set	164	45191	RV Vent Cover	73	45395	AC Cover	50
44505	10 Leveling Block Set	164	45192	RV Vent Insulator w/reflective	73	45396	AC Cover	50
44531	Adjustable Stabilizer	169	45195	RV Vent Insulator	73	45397	AC Cover	50
44541	Stabilizer Jack Pads, large	167	45231	Windshield Cover	50	45398	AC Cover	50
44560	Aluminum Trailer Jacks	163	45232	Windshield Cover	50	45401	Tow Car Windshield Protector	159
44561	Aluminum Trailer Jacks	163	45233	Windshield Cover	50	45431	Chair Bag	4
44573	Tri-Leveler™	167	45241	Windshield Cover	50	45456	Wiper Stand-off Wedges	51
44595	Stabilizer Jack Pads, small	167	45242	Windshield Cover	50	45461	Super Grommets	73
44603	Hitch Alignment Kit	166	45243	Windshield Cover	50	45491	U.S. Flag	16
44610	Trailer Hitch Lubricant	149	45244	Windshield Cover	50	45492	Happy Hour Flag	16
44616	Grease Gun	149	45245	Windshield Cover	50	45501	RV Single Flag Holders	16
44619	Grease Gun Replacement cartridges	149	45301	Vinyl Propane Tank Cover - arctic white	51, 78	45502	3-Flag Holder	16
44622	Wheel Stop™	165	45302	Vinyl Propane Tank Cover - arctic white	51, 78	45504	Screw-In Triple Flag Holder	16
44632	Wheel Dock™	167	45303	Vinyl Propane Tank Cover - arctic white	51, 78	45511	Screen Door Slide-beige	22
44642	Locking Wheel Stop™	165	45304	Vinyl Propane Tank Cover - arctic white	51, 78	45512	Screen Door Slide-clear	22
44652	Small Wheel Stop™	165	45312	Vinyl Propane Tank Cover - colonial white	51, 78	45513	Screen Door Slide-white	22
44662	Metal Locking Wheel Stop	165	45313	Vinyl Propane Tank Cover - colonial white	51, 78	45514	Screen Door Slide-black	22
44664	5th Wheel Lube Plate - 10"	152	45314	Vinyl Propane Tank Cover - colonial white	51, 78	45521	Screen Door Slide-beige	22
44674	5th Wheel Lube Plate - 12"	152	45321	Tire Protectors	51	45522	Screen Door Slide-clear	22
44681	Slideout Supports, Standard	169	45322	Tire Protectors	51	45531	Screen Door Slide-white	22
44691	Slideout Supports, Large	169	45323	Tire Protectors	51	45532	Screen Door Slide-beige	22
44710	RV Wash Sponge	135	45324	Tire Protectors	51	45533	Screen Door Slide-black	22
44721	Pop-Up Camper Starter Kit	192	45325	Tire Protectors	51	45534	Screen Door Slide-clear	22
44742	Starter Kit Bucket - III	190	45326	Tire Protectors	51	45541	Screen Door Stop-beige	22
44743	Starter Kit Bucket - IV	190	45331	Tire Protectors	51	45542	Screen Door Stop-clear	22
44744	Starter Kit Bucket - V	191	45332	Tire Protectors	51	45543	Screen Door Stop-white	22
44745	Starter Kit Bucket - VI	191	45333	Tire Protectors	51	45544	Screen Door Stop-black	22
44746	Starter Kit Bucket - VII	191	45334	Tire Protectors	51	45551	Screen Door Handles	14
44760	Starter Kit Bucket - I	190	45335	Tire Protectors	51	45561	Stationary Piece-beige	22
44761	Standard Starter Kit	192	45336	Tire Protectors	51	45562	Stationary Piece-clear	22
44762	Starter Kit Bucket - VIII	191	45340	Spare Tire Cover	50	45563	Stationary Piece-white	22
44763	Starter Kit Bucket - II	190	45341	Spare Tire Cover	50	45564	Stationary Piece-black	22
44771	Deluxe Starter Kit	192	45342	Spare Tire Cover	50	45571	Stationary Piece-beige	22
44781	Premium Starter Kit	192	45343	Spare Tire Cover	50	45572	Stationary Piece-clear	22
44802	Gen-turi 30" emt straight	79	45344	Spare Tire Cover	50	45573	Stationary Piece-white	22
44812	Gen-turi™ 30" emt 90° bend	79	45345	Spare Tire Cover	50	45581	Screen Door Slide Set-clear	22
44822	Gen-turi™ 1-1/2" muffler clamp	79	45346	Spare Tire Cover	50	45582	Screen Door Slide Set-beige	22
44842	Gen-turi™ 1-5/8" coupler	79	45347	Spare Tire Cover	50	45583	Screen Door Slide Set-white	22
44845	Gen-turi 1-3/4" coupler w/clamp	79	45348	Spare Tire Cover	50	45584	Screen Door Slide Set-black	22
44848	Gen-turi 2" coupler w/clamp	79	45349	Spare Tire Cover	50	45591	Screen Door Slide Set-clear	22
44852	Gen-turi 1" split bushing	79	45350	Spare Tire Cover	50	45592	Screen Door Slide Set-beige	22
44862	Gen-turi™ 8" 30° emt	79	45351	Spare Tire Cover	50	45593	Screen Door Slide Set-white	22

45601 – 48501

45601 Screen Door Slide Set-clear.....	22	45757 5th Wheel Cover-38'.....	49	48130 Ball Mount Shank, 12".....	151
45602 Screen Door Slide Set-beige.....	22	45758 5th Wheel Cover-40'.....	49	48131 Ball Mount Shank, 14".....	151
45603 Screen Door Slide Set-white.....	22	45759 5th Wheel Cover-42'.....	49	48132 Ball Mount Shank, 12".....	151
45631 Awning Mat Anchors.....	6	45760 Pop-Up Camper Cover-6' to 8'.....	49	48133 Ball Mount Shank, 16".....	151
45641 Fridge Door Stay.....	64	45761 Pop-Up Camper Cover-8' to 10'.....	49	48170 Combo Bar, 6".....	149
45651 Insulated Dual Vent Cover.....	73	45762 Pop-Up Camper Cover-10' to 12'.....	49	48171 Combo Bar, 10".....	149
45700 Class A Cover-28'.....	48	45763 Pop-Up Camper Cover-12' to 14'.....	49	48172 Combo Bar, 12".....	149
45701 Class A Cover-30'.....	48	45764 Pop-Up Camper Cover-14' to 16'.....	49	48173 Combo Bar, 24".....	149
45702 Class A Cover-32'.....	48	45765 Pop-Up Camper Cover-16' to 18'.....	49	48174 Combo Bar, 36".....	149
45703 Class A Cover-34'.....	48	45770 Slide-In Camper Cover-18'.....	49	48175 Combo Bar, 48".....	149
45704 Class A Cover-36'.....	48	45771 Slide-In Camper Cover-16.5'.....	49	48180 Chain Loop, Small.....	149
45705 Class A Cover-38'.....	48	45773 Slide-In Camper Cover-19.5'.....	49	48181 Chain Loop, Large.....	149
45706 Class A Cover-40'.....	48	45780 Van Cover-Standard: to 18'.....	49	48213 Hitch Ball, Chrome.....	149
45707 Class A Cover-42'.....	48	45781 Van Cover-Extended: to 22'.....	49	48231 Hitch Ball Cover.....	149
45710 Class C/Travel Trailer Cover-22'.....	48	45782 Van Cover-HiTop: to 19'.....	49	48270 Ball Mount and Shank, 14".....	151
45711 Class C/Travel Trailer Cover-24'.....	48	45790 UltraShield Patch Kit.....	48	48271 Ball Mount and Shank, 16".....	151
45713 Class C/Travel Trailer Cover-28'.....	48	45791 UltraGuard Top Patch Kit.....	49	48272 Ball Mount and Shank, 18".....	151
45714 Class C/Travel Trailer Cover-30'.....	48	45795 UltraGuard Side Patch Kit.....	49	48282 Ball Mount.....	150
45715 Class C/Travel Trailer Cover-32'.....	48	45796 Ladder Cover.....	48	48286 Ball Mount.....	150
45716 Class C/Travel Trailer Cover-34'.....	48	48021 Hitch Pin 5/8".....	147	48290 Ball Mount.....	150
45717 Class C/Travel Trailer Cover-36'.....	48	48023 Bushing.....	149	48292 Ball Mount.....	150
45720 5th Wheel Cover-24'.....	48	48023 Bushing 1-1/4" to 1".....	147	48294 Ball Mount.....	150
45721 5th Wheel Cover-26'.....	48	48028 Hook-Up Wire Clip for 48029.....	147	48296 Ball Mount.....	150
45722 5th Wheel Cover-28'.....	48	48029 Quick Hook-Up (for hitch).....	147	48298 Ball Mount.....	150
45723 5th Wheel Cover-30'.....	48	48031 Hook-Up Handle (Comes w/Hitch).....	147	48300 Ball Mount.....	150
45724 5th Wheel Cover-32'.....	48	48051 Adj. Weight Distributing Hitch.....	147	48302 Ball Mount.....	150
45725 5th Wheel Cover-34'.....	48	48052 Adj. Weight Distributing Hitch.....	147	48304 Ball Mount.....	150
45726 5th Wheel Cover-36'.....	48	48053 Adj. Weight Distributing Hitch.....	147	48306 Ball Mount.....	150
45727 5th Wheel Cover-38'.....	48	48054 Adj. Weight Distributing Hitch.....	147	48312 Ball Mount.....	150
45728 5th Wheel Cover-40'.....	48	48057 Elite Hitch Kit - 800 lb.....	146	48314 Ball Mount.....	150
45729 5th Wheel Cover-42'.....	48	48058 Elite Hitch Kit - 1000 lb.....	146	48316 Ball Mount.....	150
45730 Class A Cover-28'.....	49	48059 Adj. Weight Distributing Hitch.....	147	48318 Ball Mount.....	150
45731 Class A Cover-30'.....	49	48061 Adj. Weight Distributing Hitch.....	147	48320 Ball Mount.....	150
45732 Class A Cover-32'.....	49	48062 Adj. Weight Distributing Hitch.....	147	48324 Ball Mount.....	150
45733 Class A Cover-34'.....	49	48063 Adj. Weight Distributing Hitch.....	147	48326 Ball Mount.....	150
45734 Class A Cover-36'.....	49	48064 Adj. Weight Distributing Hitch.....	147	48350 Tow Bar without cables.....	152
45735 Class A Cover-38'.....	49	48069 Elite Hitch Kit - 1200 lb.....	146	48352 Tow Bar with cables.....	152
45736 Class A Cover-40'.....	49	48081 Adjustable Ball Mount.....	147	48353 Tow Bar Safety Cables.....	152
45737 Class A Cover-42'.....	49	48091 Spring Bar-600 Rating.....	147	48372 Tow Bar U-Joint Assembly.....	152
45740 Class C/Travel Trailer Cover-22'.....	49	48092 Spring Bar-800 Rating.....	147	48380 Sway Control - Screw-On right mounted.....	148
45741 Class C/Travel Trailer Cover-24'.....	49	48093 Spring Bar-1000 Rating.....	147	48381 Sway Control - Screw-On left mounted.....	148
45742 Class C/Travel Trailer Cover-26'.....	49	48094 Spring Bar-1400 Rating.....	147	48385 Sway Control Adapter - 2" x 3" Clamp-on.....	148
45743 Class C/Travel Trailer Cover-28'.....	49	48097 Spring Bar 1200 Rating.....	147	48386 Left or Right Ball Mount Adapter - 2".....	148
45744 Class C/Travel Trailer Cover-30'.....	49	48100 Set Screw.....	147	48386 Left & Right Sway Control Adapter.....	150
45745 Class C/Travel Trailer Cover-32'.....	49	48101 Bolt Package for Adj. Ball Mount.....	147	48388 Trailer Tongue Ball Plate.....	148
45746 Class C/Travel Trailer Cover-34'.....	49	48103 Set Screw for Adj. Ball Mount.....	147	48389 Self Tap Screw 3/8" x 1 (6 pk).....	148
45747 Class C/Travel Trailer Cover-36'.....	49	48104 Spring Bar Locking Device Repair Kit.....	147	48390 Ball Mount Bar.....	148
45750 5th Wheel Cover-24'.....	49	48110 Elite Ball Mount Kit.....	147	48391 Slide Bar 3/8".....	148
45751 5th Wheel Cover-26'.....	49	48113 Spring Bar Locking Device Repair Kit.....	147	48404 Ball, Washer, Nut.....	148
45752 5th Wheel Cover-28'.....	49	48114 Self Tap Screw 3/8" x 1.....	148	48461 Tri-Ball Adjustable Hitch Kit.....	151
45753 5th Wheel Cover-30'.....	49	48120 Ball Mount Shank, 12".....	151	48465 Tri-Ball Adjustable Hitch Kit with Hook.....	151
45754 5th Wheel Cover-32'.....	49	48121 Ball Mount Shank, 14".....	151	48490 17" Gooseneck Adapter.....	143
45755 5th Wheel Cover-34'.....	49	48122 Ball Mount Shank, 16".....	151	48500 12" Gooseneck Adapter.....	143
45756 5th Wheel Cover-36'.....	49	48123 Ball Mount Shank, 18".....	151	48501 15" Gooseneck Adapter.....	143

48519 — 54703

48519 Free Ride™ Hitch Stabilizing Feet.....	144	51020 Tablecloth w/bench covers.....	28	51364 Survival Whistle.....	31
48522 Rail Rider 5th Wheel Hitch Base.....	144	51022 Citronella Candle.....	34	51430 Clamp-N-Carry™ Chair and Bike Rack.....	23
48523 Rail Rider Hitch Slider Base.....	144	51024 Lighter Flints.....	32	51463 Tippy Stix.....	12
48524 Rail Rider Hitch Slider Base.....	144	51026 Camp Saw w/sheath.....	30	51490 Chair and Bike Rack.....	23
48525 Rail Rider Hitch Tailgate Stabilizing Foot.....	144	51028 Knife Sharpener.....	28	51600 Telescoping Flagpole w/Car-Foot.....	17
48526 Gooseneck Ball Slide.....	144	51030 Dunk Bag.....	33	51605 20' Flag Pole w/car foot and Residential Mount.....	17
48538 Main Plate for Hitch Installation Kit.....	144	51032 Whisk w/dust pan.....	33	51606 Fiberglass Flagpole.....	17
48539 Hitch Mounting Brackets.....	144	51034 Toaster Rack.....	29	51611 Hitch-Mount Flagpole Holder.....	17
48540 Main Plate for Hitch Installation Kit.....	144	51036 Utility Clips.....	34	51800 Folding Directors Chair - Black Swirl.....	4
48541 Hitch Mounting Brackets.....	144	51038 Multi-Purpose Scissors.....	31	51801 Folding Directors Chair - Green Swirl.....	4
48542 Main Plate for Hitch Installation Kit.....	144	51040 Can Openers.....	29	51802 Folding Directors Chair - Tan Fern.....	4
48543 Hitch Mounting Brackets.....	144	51042 Tent Pegs - 12 inch.....	30	51803 Folding Directors Chair - Red Swirl.....	4
48544 Main Plate for Hitch Installation Kit.....	144	51044 Tent Pegs - 9 inch.....	30	51810 Zero Gravity Recliner - Black Swirl.....	4
48545 Hitch Mounting Brackets.....	144	51046 Tap-In Grommets.....	34	51811 Zero Gravity Recliner - Green Swirl.....	4
48546 Main Plate for Hitch Installation Kit.....	144	51048 Camp Griddle.....	29	51812 Zero Gravity Recliner - Tan Fern.....	4
48547 Hitch Mounting Bracket.....	144	51050 Fuel Funnel.....	29	51813 Zero Gravity Recliner - Red Swirl.....	4
48548 Main Plate for Hitch Installation Kit.....	144	51052 Sewing Kit.....	33	51820 Zero Gravity Recliner - Black Swirl - padded.....	4
48549 Hitch Mounting Brackets.....	144	51054 Lantern Hanger.....	32	51821 Zero Gravity Recliner - Green Swirl - padded.....	4
48550 Main Plate for Installation Kit.....	144	51056 Salt and Pepper Shaker.....	29	51822 Zero Gravity Recliner - Tan Fern - padded.....	4
48551 Mounting Brackets/Accessories.....	144	51058 Tent Peg Puller.....	30	51830 Zero Gravity Wide Recliner - Black Swirl.....	4
48552 Hitch Mounting Brackets.....	144	51060 Folding Scissors.....	31	51831 Zero Gravity Wide Recliner - Green Swirl.....	4
48561 Gooseneck Ball and Plate w/wrench.....	143	51062 Mosquito Coil Holder.....	34	51832 Zero Gravity Wide Recliner - Tan Fern.....	4
48572 Bolt Pack for Gooseneck Adapter.....	143	51064 Laundry Reel.....	33	51833 Zero Gravity Wide Recliner - Red Swirl.....	4
48590 Install Kit, 4-Bolt Fifth Wheel Hitch.....	145	51066 Utility Strap - 4 ft.....	35	51840 Zero Gravity Wide Recliner - Black Swirl - padded.....	4
48591 Install Kit, 4-Bolt Fifth Wheel Hitch.....	145	51068 Utility Strap - 6 ft.....	35	51841 Zero Gravity Wide Recliner - Green Swirl - padded.....	4
48592 Adapter Kit, 4-Bolt Fifth Wheel Hitch.....	145	51070 Utility Strap - 8 ft.....	35	51842 Zero Gravity Wide Recliner - Tan Fern - padded.....	4
48593 Adapter Kit, 4-Bolt Fifth Wheel Hitch.....	145	51072 Utility Strap - 10 ft.....	35	51890 Fold-Away Side Table, Small.....	20
48594 Adapter Kit, 4-Bolt Fifth Wheel Hitch.....	145	51074 Camp Shovel.....	31	51891 Fold-Away Side Table, Large.....	20
48595 Adapter Kit, 4-Bolt Fifth Wheel Hitch.....	145	51076 Deluxe Tablecloth Clamps.....	28	51892 Roll-up Table w/Carrying Bag.....	20
48600 5th Wheel Hitch Head Assembly.....	144	51078 Tripod Grill and Lantern Holder.....	28	54600 1003/1093-LED Swivel, w/White Housing.....	179
48600 Fifth Wheel Hitch Head Assembly.....	144	51080 Multi-Function Tool.....	31	54602 1003/1093-LED Swivel, w/Black Housing.....	179
48601 Fifth Wheel Hitch Base.....	144	51082 Camp Axe.....	30	54604 1141-LED Swivel, w/White Housing.....	179
48602 Fifth Wheel Hitch Base.....	144	51084 Water Carrier with tap.....	28	54606 1141-LED Swivel, w/Black Housing.....	179
48620 Fifth Wheel Hitch, Head, Crossmember, 4-bolt, Kit.....	145	51086 Tent Stake - Bulk.....	30	54608 1156/1073-LED Swivel, Frosted w/White Housing.....	179
48621 Fifth Wheel Hitch, Fixed Channel Leg, 4-bolt, Kit.....	145	51090 Folding Fire Ring.....	19	54610 156/1073-LED Swivel, w/White Housing.....	179
48622 Fifth Wheel Hitch, Slider, 4-bolt, Kit.....	145	51095 Propane Distribution Post.....	84	54612 156/1073-LED Swivel, w/Black Housing.....	179
48701 Trekker Adaptive Sway Hitch, 600 lb.....	142	51302 Food Cover, Folding.....	28	54614 5008-LED.....	179
48703 Trekker Adaptive Sway Hitch, 1,000 lb.....	142	51304 Telescoping Fork.....	29	54616 1383-LED.....	179
48704 Trekker Adaptive Sway Hitch, 1,200 lb.....	142	51308 Safety Fork.....	29	54618 383A-LED, Amber.....	179
48800 20" Scissor Jacks, 5000 lb, 2 pk.....	163	51312 Camping Cook Set.....	29	54620 912-LED, Frosted Lens.....	179
48810 24" Scissor Jacks, 5000 lb, 1 pk.....	163	51316 Tick Remover.....	34	54622 912-LED, Frosted Lens.....	179
48820 24" Scissor Jacks, 5000 lb, 2 pk.....	163	51322 Emergency Blanket.....	32	54624 G4-LED.....	179
48830 24" Scissor Jacks, 7500 lb, 2 pk.....	163	51326 Vinyl Repair Tape.....	34	54626 G4-LED.....	179
48840 30" Scissor Jacks, 5000 lb, 2 pk.....	163	51332 Magnesium Fire Starter.....	32	54628 T5-LED, 12" Fluorescent Bulb.....	179
51000 Stretch Cord.....	35	51338 Laundry Bag.....	33	54630 T8-LED, 18" Fluorescent Bulb.....	179
51002 Mini Stretch Cords - 4-Pack.....	35	51340 Waterproof Pouches.....	33	54632 1076-LED.....	179
51004 Poly Cord - 50 foot.....	35	51342 20-inch Stretch Cords.....	35	54634 1157-LED.....	179
51006 Snap Fastener Kit.....	34	51344 Tarp Clips.....	34	54636 212-LED.....	179
51008 Ditty Bag Set.....	33	51346 Carabiners.....	32	54638 906-LED.....	179
51010 Tent Stakes - 10 inch.....	30	51348 Sleeping Bag Straps.....	35	54640 Universal LED.....	179
51012 Egg Holder - 6 Eggs.....	28	51352 Folding Saw.....	30	54642 Universal LED.....	179
51014 Egg Holder - 12 Eggs.....	28	51354 Pocket Saw.....	30	54644 Load Resistor Kit for LED Bulb, 6Ω.....	179
51016 Firestarter Sticks.....	32	51356 Soap Dish.....	33	54702 JC-10 Halogen Fog/Driving.....	183
51018 Tablecloth.....	28	51362 Lensatic Compass.....	31	54703 JC-35 Halogen, 12V 35W.....	183

54704 C7 1/2 Clear Patio Decor.....	182	54797 1143IF RV/Marine Inside	182	55001 Cord Storage Handle.....	175
54705 C7 1/2 Clear Patio Decor.....	182	54798 1154 Auto Park/Tail/Signal.....	181	55013 Power Grip™ Electrical Protectant & Lube.....	177
54706 20-99 RV Cosmetic Frosted	182	54799 1154 Auto Park/Tail/Signal.....	181	55025 Power Maximizer™.....	173
54707 20-99 RV Cosmetic Frosted	182	54802 1156 Auto Back Up.....	181	55132 Standard Replacement Plug-30 AMP.....	177
54708 20-99 RV Cosmetic Clear	182	54803 1156 Auto Back Up.....	181	55142 RV Outdoor 30'/15 Amp Extension Cord.....	175
54709 20-99 RV Cosmetic Clear	182	54806 1157 Auto Park/Tail/Signal.....	181	55143 50-ft Outdoor Extension Cord	175
54710 53 Auto Instrument.....	180	54807 1157 Auto Park/Tail/Signal.....	181	55155 Power Grip™ Dogbone Adapter, 30M to 15F.....	172
54711 53 Auto Instrument.....	180	54810 1157NA Auto Park/Tail/Signal	181	55165 Power Grip™ Dogbone Adapter, 15M to 30F.....	172
54712 55 Auto Instrument.....	180	54811 1157NA/1034NA Auto Park/Tail	181	55168 Power Grip™ Dogbone Adapter, 15M to 50F.....	172
54714 57 Auto Instrument.....	180	54812 1176 Stop/Tail/Park.....	181	55175 Power Grip™ Dogbone Adapter, 50M to 30F.....	172
54715 57 Auto Instrument.....	180	54813 1176 Stop/Tail/Park.....	181	55185 Power Grip™ Dogbone Adapter, 30M to 50F.....	172
54717 63 Auto Instrument.....	180	54818 1295 Auto Cornering.....	181	55191 Power Grip™ Extension Cord-30 AMP.....	175
54720 67 Auto License.....	180	54820 1383 Auto/RV Reading	182	55194 Power Grip™ Extension Cord-50 amp.....	175
54721 67 Auto License.....	180	54822 Bulb, 1383TF Auto/RV Reading.....	182	55195 Power Grip™ Extension Cord-50 AMP.....	175
54722 68 Auto/Marine.....	180	54823 Bulb, 1383TF Auto/RV Reading.....	182	55197 Power Grip™ Extension Cord-30 amp.....	175
54723 68 Auto/Marine.....	180	54824 1414 Auto/RV.....	182	55205 Power Grip™ 30 amp Extender	173
54727 89 Auto Interior.....	180	54825 1414 Auto/RV.....	182	55215 Power Grip™ 50 amp Extender	173
54728 90 Auto/Marine Interior.....	180	54827 1416 Marine	182	55222 Power Grip™ Electrical Adapter, 15M to 30F.....	172
54729 90 Auto/Marine Interior.....	180	54829 1651 Lantern 4F Cells - Clear.....	182	55223 Power Grip™ Electrical Adapter, 15M to 30F.....	172
54730 93 Auto.....	181	54830 1816 Aviation/Auto Instrument.....	180	55232 Power Grip™ Electrical Adapters, 30M to 15F.....	172
54731 93 Auto.....	181	54834 1893 HD Auto Instrument.....	180	55233 Power Grip™ Electrical Adapters, 30M to 15F.....	172
54733 Bulb, 94 Auto/Marine.....	181	54835 1893 HD Auto Instrument.....	180	55242 Power Grip Plug-30 AMP.....	177
54750 194 HD Auto Instrument.....	180	54836 1895 Auto Instrument.....	180	55245 Power Grip Plug-30 AMP.....	177
54751 194/158 HD Auto Instrumen.....	180	54837 1895 Auto Instrument.....	180	55252 Power Grip Plug-50 AMP.....	177
54752 194A Auto Side Marker.....	180	54838 2057 Auto Park/Tail/Signal.....	181	55255 Power Grip Plug-50 AMP.....	177
54753 194A Auto Side Marker.....	180	54839 2057 Auto Park/Tail/Signal.....	181	55263 120V Line Monitor.....	177
54754 211-2 Auto Interior.....	182	54841 2057NA Auto Park/Tail/Signal	181	55272 Power Grip™ Generator Adapter Dogbone.....	174
54755 211-2 Auto Interior.....	182	54847 3057 Auto Park/Tail/Signal.....	183	55283 30 Amp Mini Replacement Plug.....	177
54756 212-2 Auto/Marine.....	182	54849 3057NA Auto Park/Tail/Signal.....	183	55301 30 Amp PowerGrip Surge/Voltage Protector.....	178
54757 212-2 Auto/Marine	182	54850 3156 Auto.....	183	55306 50 Amp PowerGrip Surge/Voltage Protector.....	178
54758 214-2 RV Refrig/Auto Interior.....	182	54854 3157 Auto Park/Tail/Signal	183	55310 Circuit Analyzer - 30 Amp	178
54759 214-2 RV Refrig/Auto Interior.....	182	54855 3157 Auto Park/Tail/Signal	183	55325 Power Grip™ 90° Electrical Adapter, 15M to 30F.....	172
54762 906 Auto/RV Interior	181	54857 3157NA Auto Park/Tail/ Signal	183	55333 Power Grip™ Generator Adapter	174
54763 906 Auto/RV Interior	181	54858 3175 Auto Interior.....	182	55338 4-Prong Generator Adapter.....	174
54765 906F RV Interior.....	181	54859 3175 Auto Interior.....	182	55343 Power Grip Receptacle-30 AMP.....	177
54766 912 Auto/RV/Marine Interior.....	181	54870 Sealed Beam Bulb	183	55353 Power Grip Receptacle-50 AMP.....	177
54767 912 Auto/RV/Marine Interior.....	181	54871 A-19 75W/12V House Type.....	184	55362 Battery Box-standard	178
54768 921 Auto 3rd Brake Lamp	181	54872 Bulb, A-19 75W/12V House Type.....	184	55364 Battery Box Replacement Strap.....	178
54769 921 Auto 3rd Brake Lamp	181	54874 A-19 100W/12V House Type.....	184	55372 Battery Box-large.....	178
54772 1003 Auto/RV Interior.....	181	54875 DC Fluorescent Replacement Tubes	184	55382 Power Grip™ Generator Adapter Dogbone	174
54773 1003 Auto/RV Interior.....	181	54876 DC Fluorescent Replacement Tubes	184	55394 Battery Tray-standard	178
54774 1004 Auto/RV Interior.....	181	54877 LF15T8/CW 15 Watt - 18".....	184	55404 Battery Tray-large.....	178
54775 1004 Auto/RV Interior.....	181	54878 LF15T8/CW 15 Watt - 18".....	184	55412 3-prong for L5-50 Locking Plug	174
54780 1076 Auto/RV/Marine Signal	181	54879 LF8T5/CW 8 Watt - 12".....	184	55422 4-prong for L-14-50 Locking Plug	174
54781 1076 Auto/RV/Marine Signal	181	54880 LF8T5/CW 8 Watt - 12".....	184	55433 3 Prong To 2 - 15 Amp Outlet Adapter	174
54786 1139IF RV/Marine/Truck Interior	182	54881 LF13T5/CW 13 Watt - 21".....	184	55438 4 Prong To 2 - 15 Amp Outlet Adapter	174
54787 1139IF RV/Marine/Truck Interior	182	54882 LF13T5/CW 13 Watt - 21".....	184	55501 30A Power Grip Locking Electrical Adapter.....	176
54788 1141 Auto/RV Back Up.....	181	54890 1A-15 15W/12V Oven Type.....	184	55512 30A Power Grip Locking Electrical Adapter.....	176
54789 1141 Auto/RV Back Up.....	181	54892 A-19 25W/12V House Type.....	184	55522 30A Power Grip Locking Electrical Adapter-90°	176
54791 1141IF Inside Frosted.....	181	54894 A-19 50W/12V House Type.....	184	55532 30A Power Grip Locking Electrical Cord	176
54793 1141NA Auto/RV/Marine Exterior.....	181	54896 LF4T5/CW 6 Watt - 6".....	184	55537 Replacement Locking Ring, 30 A	176
54794 1142 Auto/RV/Marine Exterior	181	54898 LF4T5/CW 6 Watt - 9".....	184	55542 50A Power Grip Locking Electrical Adapter.....	176
54795 1142 Auto/RV/Marine Exterior	181	54902 Bulb, JC-10 Halogen Fog/Driving.....	183	55552 50A Power Grip Locking Electrical Adapter.....	176
54796 1143IF RV/Marine Inside Frosted.....	182	54903 Bulb, JC-35 Halogen, 12V 35W.....	183	55562 50A Power Grip Locking Electrical Adapter-90°	176

55572 – 63501

55572 50A Power Grip Locking Electrical Cord.....	176	57704 LP Gas Regulator with 8' hose.....	88	59893 Propane Y Adapter.....	85
55577 Replacement Locking Ring, 50 A.....	176	57706 Wave™ 3/3100 Dust Cover.....	88	59903 Full-Flow Quick-Connect Plug.....	84
55582 30/50F A Std/Locking Adapter, 90°, 18".....	176	57713 Wave™ 6/6100 Dust Cover.....	88	59913 3' Propane Hose Assembly.....	81
57001 Pop-A-Plate®-white.....	58	57715 Wave™ 8/8100 Dust Cover.....	88	59923 200,000 BTU Acme Nut.....	84
57041 Pop-A-Napkin™-white.....	58	57721 LP Gas Regulator with 12' hose.....	88	59933 70,000 BTU Acme Nut.....	84
57061 Pop-A-Bag™-white.....	59	57722 Wave™ 3 Dust Cover (portable).....	88	59943 Propane Cylinder Adapter.....	85
57081 Pop-A-Filter™-white.....	59	57723 Wave™ 6 Dust Cover (portable).....	88	59953 NPT 1/4" Fitting.....	85
57101 Pop-A-Tissue™-clear.....	59	57724 Wave™ 8 Dust Cover (portable).....	88	63114 Insulated Ring Terminals.....	185
57111 Pop-A-Towel™-white.....	58	57874 Crank Handle.....	163	63116 Insulated Ring Terminals.....	185
57131 Pop-A-Wrap™-white.....	58	57883 Stabilizer Base Pads.....	163	63124 Insulated Ring Terminals.....	185
57203 Pop-A-Toothbrush™-white.....	66	58012 3.5" Pocket Match.....	44	63126 Insulated Ring Terminals.....	185
57211 Pop-A-Bowl™-white.....	58	58023 CAMPLighter™ Elite Opener/Lighter.....	44	63144 Insulated Ring Terminals.....	185
57213 Propane Adapter.....	18	58031 Little Red Campfire™.....	18	63167 Insulated Ring Terminals.....	185
57236 Propane Cylinder Base.....	78	58032 Replacement Log set.....	18	63169 Insulated Ring Terminals.....	185
57240 3500-C Electric Grill.....	38	58033 Campfire Cook Top.....	18	63171 Insulated Ring Terminals.....	185
57245 6500 Grill w/LP Valve with Quick-Connect.....	39	58034 Replacement Hose w/Regulator.....	18	63177 Insulated Ring Terminals.....	185
57251 4500 Gas Grill.....	39	58035 Big Red Campfire.....	18	63179 Insulated Ring Terminals.....	185
57252 Hybrid Gas/Electric Grill.....	40	58041 Propane Campfire.....	19	63181 Insulated Ring Terminals.....	185
57268 RV Mounting Rail.....	41	58090 Universal Grill Mount.....	40	63187 Insulated Ring Terminals.....	185
57269 LP Hose Quick-Connect to Acme.....	43	59005 Propane Automatic Changeover Regulator.....	83	63189 Insulated Ring Terminals.....	185
57274 LP Gas Control Valve.....	43	59013 Single Stage Propane Regulator.....	83	63191 Insulated Ring Terminals.....	185
57280 Quick-Connect Hose - 39".....	43	59023 Gas Gauge/Leak Detector.....	85	63197 Insulated Ring Terminals.....	185
57282 Quick-Connect Hose - 10 ft.....	43	59033 5' Propane Supply Hose.....	81	63207 Insulated Ring Terminals.....	185
57293 Deluxe Folding Grill Table.....	42	59035 12' Propane Supply Hose.....	81	63209 Insulated Ring Terminals.....	185
57301 4100 Tabletop Grill.....	41	59043 12' Propane Extension Hose.....	81	63211 Insulated Ring Terminals.....	185
57305 5500 SS RV Grill.....	41	59045 5' Propane Extension Hose.....	81	63217 Insulated Ring Terminals.....	185
57321 Universal BBQ Stand.....	42	59053 12" Pigtail Propane Connector.....	82	63219 Insulated Ring Terminals.....	185
57331 Olympian™ Wave 3.....	88	59065 15" Pigtail Propane Connector.....	82	63221 Insulated Ring Terminals.....	185
57341 Olympian™ Wave 6.....	88	59073 20" Pigtail Propane Connector.....	82	63227 Insulated Ring Terminals.....	185
57351 Olympian™ Wave 8.....	88	59093 3-Port Propane Tee.....	80	63231 Insulated Ring Terminals.....	185
57363 3/4" Scissor Jack Socket.....	163	59103 3-Port Propane Tee and Hose.....	80	63237 Insulated Ring Terminals.....	185
57371 Telescopic Stabilizing Jack.....	163	59113 4-Port Propane Tee.....	80	63239 Insulated Ring Terminals.....	185
57382 Gooseneck Stabilizer Jack.....	162	59123 4-Port Propane Tee and Hoses.....	80	63247 Insulated Ring Terminals.....	185
57391 King Pin 5th Wheel Stabilizing Jack.....	162	59125 4-Port Tee with 5' hose.....	80	63262 #10 8 Ga. Insul. Ring Terminals w/brazed seams.....	185
57416 Butane Fuel - 78 gram.....	44	59133 90° Propane Tee.....	81	63265 1/4" 8 Ga. Insul. Ring Terminals w/brazed seams.....	185
57433 GM3™ GasMatch - 14-3/4".....	45	59143 90° Propane Tee and Hose.....	81	63267 5/16" 8 Ga. Insul. Ring Terminals w/brazed seams ...	185
57453 Olympian™ GM4 GasMatch™.....	44	59153 24" Pigtail Propane Connector.....	82	63268 5/16" 8 Ga. Insul. Ring Terminals w/brazed seams ...	185
57473 Olympian™ GM9 GasMatch™ 2/pk.....	44	59163 30" Pigtail Propane Connector.....	82	63271 3/8" 8 Ga. Insul. Ring Terminals w/brazed seams.....	185
57496 Butane Fuel - 165 gram.....	44	59173 36" Pigtail Propane Connector.....	82	63277 #10 6 Ga. Insul. Ring Terminals w/brazed seams.....	185
57521 Sway Control.....	159	59183 48" Pigtail Propane Connector.....	82	63283 5/16" 6 Ga. Insul. Ring Terminals w/brazed seams ...	185
57527 Spring Clip.....	147, 148	59193 60" Pigtail Propane Connector.....	82	63286 3/8" 6 Ga. Insul. Ring Terminals w/brazed seams.....	185
57533 GM12 Multi-Sparker - 13".....	45	59203 P.O.L. Plug Adapter.....	85	63477 Insulated Butt Connectors.....	185
57543 GM3X™ GasMatch - 26".....	45	59313 Two Stage Propane Regulator-vertical.....	83	63479 Insulated Butt Connectors.....	185
57561 GM12X Multi-Sparker - 26".....	45	59323 Two Stage Propane Regulator-horizontal.....	83	63481 Butt Connectors.....	185
57570 8" CAMPLighter™.....	44	59333 Two Stage Propane Regulator-horiz. w/P.O.L.....	83	63482 Butt Connectors.....	185
57628 1 lb Throwaway Cylinder Adapter Kit.....	43	59344 Covers for Two Stage Regulators (set of 2).....	83	63487 Insulated Butt Connectors.....	185
57632 Olympian Grill Bag.....	42	59823 Propane Hose Assembly - 5'.....	82	63489 Insulated Butt Connectors.....	185
57633 Propane Elbow with full 360° swivel.....	88	59825 Propane Hose Assembly - 12'.....	82	63491 Insulated Butt Connectors.....	185
57636 High Pressure Gas Hose for Grill.....	42	59833 12' High-Pressure LP Hose.....	42	63492 Insulated Butt Connectors.....	185
57638 4100 Low Pressure Conversion Kit.....	43	59843 20" Pigtail Propane Connector.....	82	63494 Insulated Butt Connectors.....	185
57684 GM3XE™ GasMatch - 40-3/4".....	45	59853 Quick-Connect Kit.....	84	63497 Insulated Butt Connectors.....	185
57701 Leg Stands for Wave™ Heaters-black.....	88	59863 Regulator with 22" hose.....	88	63499 Insulated Butt Connectors.....	185
57703 LP Gas Regulator with 6' hose.....	88	59883 Propane Appliance Extension Hose - 5'.....	82	63501 Butt Connectors.....	185

63502 Insulated Butt Connectors.....	185	63844 14-10 Ga. Wire Nut Connectors	186	64685 25 ft Spool / 4-Gage Red Battery Cable	153
63504 Insulated Butt Connectors.....	185	63853 18-8 Ga. Winged Wire Nut Connectors.....	186	64760 25 ft coaxial cable	74
63521 Heavy Duty Insulated Butt Connectors.....	185	63863 #10 Ring 22-18 Ga. Heat Shrink Connectors	185	64761 50 ft coaxial cable	74
63522 Heavy Duty Insulated Butt Connectors.....	185	63868 Heat Shrink Butt Connectors	185	64776 4-Way Trailer Test Light	155
63525 Heavy Duty Insulated Butt Connectors.....	185	63869 Butt Conn. 22-18 Ga. Heat Shrink Connectors.....	185	64786 Trailer Adapter.....	154
63564 22-18 Ga. Insul. Disconnects - Vinyl .250 M.....	185	63871 Butt Conn. 22-18 Ga. Heat Shrink Connectors.....	185	64788 Trailer Adapter.....	154
63567 22-18 Ga. Insul. Disconnects - Vinyl .250 F.....	185	63875 #10 Ring 16-14 Ga. Heat Shrink Connectors.....	185	64790 Trailer Adapter.....	154
63569 22-18 Ga. Insul. Disconnects - Vinyl .250 F.....	185	63880 Heat Shrink Butt Connectors	185	64804 Trailer Connector Mounting Bracket	156
63582 16-14 Ga. Insul. Disconnects - Vinyl .187 F.....	185	63881 Butt Conn. 16-14 Ga. Heat Shrink Connectors.....	185	64811 7-Way Plastic Blade-Type Connector w/bracket.....	156
63592 16-14 Ga. Insul. Disconnects - Vinyl .250 M.....	185	63883 Butt Conn. 16-14 Ga. Heat Shrink Connectors.....	185	64815 7-Way Plastic Blade-Type Connector, Plug, Trailer-end	156
63594 16-14 Ga. Insul. Disconnects - Vinyl .250 M.....	185	63887 #10 Ring 12-10 Ga. Heat Shrink Connectors	185	64816 7-Way Plastic Blade-Type Connector, Socket.....	156
63602 16-14 Ga. Insul. Disconnects - Vinyl .250 F.....	185	63892 Heat Shrink Butt Connectors.....	185	64817 7-Way Plastic Blade-Type Connector, Socket.....	156
63604 16-14 Ga. Insul. Disconnects - Vinyl .250 F.....	185	63893 Butt Conn. 12-10 Ga. Heat Shrink Connectors.....	185	64818 6-Way Trailer Connector - Mounting Bracket.....	156
63612 12-10 Ga. Insul. Disconnects - Vinyl .250 M.....	185	63895 Butt Conn. 12-10 Ga. Heat Shrink Connectors.....	185	64818 Trailer Connector Mounting Bracket.....	156
63617 12-10 Ga. Insul. Disconnects - Vinyl .250 F.....	185	63920 All-Purpose Handtool.....	188	64820 7-Way Plastic Trailer Connector, Socket.....	156
63648 16-14 Gage .157 Insul. Bullet Receptacle - Nylon.....	185	63924 Self-Adjusting Wire Stripper.....	188	64824 6-Way Metal Trailer Connector - Plug.....	156
63662 16-14 Gage .157 Insul. Bullet Receptacle - Nylon.....	185	63925 Circuit Tester 6-12V.....	188	64826 6-Way Metal Trailer Connector - Socket.....	156
63670 16-14 Ga. Nylon Pigtales.....	185	63926 Circuit Tester 6-12V.....	188	64828 4-Way Trailer Connector - Plug.....	156
63673 16-14 Ga. Nylon Pigtales.....	185	63928 Quickee Circuit Tester.....	188	64829 4-Way Trailer Connector - Socket.....	156
63675 12-10 Ga. Nylon Pigtales.....	185	63929 Ratcheting Crimper Tool.....	188	64830 Trailer Connector, 2-Way Flat.....	155
63676 12-10 Ga. Nylon Pigtales.....	185	63938 7-Way RV Blade Hardwire Kit.....	154	64831 Trailer Connector, 3-Way Flat.....	155
63681 8 Ga. Nylon Pigtales.....	185	63952 18 Gage GPT Wire - red.....	188	64833 Trailer Connector, 6-Way Square	155
63686 16-14 Ga. Piggyback Slip-ons.....	185	63958 16 Gage GPT Wire - red.....	188	64834 Trailer Connector, 4-Way Flat.....	155
63701 Insulated Disconnects	186	64021 18 Gage GPT Wire - black.....	188	64835 Trailer Connector, 4-Way Flat.....	155
63706 Nylon Insul. Couplers 22-18 Ga. F.....	186	64039 12 Gage GPT Wire - black.....	188	64837 4-Way Wishbone Trailer Harness, 25 ft.....	155
63711 Nylon Insul. Couplers 16-14 Ga. M.....	186	64478 18 Ga. Two Conductor Bonded Wire	188	64839 4-Way Wishbone Trailer Harness, 12 in.....	155
63716 Nylon Insul. Couplers 16-14 Ga. F.....	186	64509 16 Ga. Four Conductor Bonded Wire.....	188	64841 4-Way Wishbone Trailer Harness, 24 in.....	155
63717 Nylon Insul. Couplers 16-14 Ga. F.....	186	64528 14 Ga. Four Conductor Bonded Wire.....	188	64843 4-Way Wishbone Trailer Harness, 36 in.....	155
63719 Nylon Insul. Couplers 16-14 Ga. F.....	186	64529 14 Ga. Four Conductor Bonded Wire.....	188	64845 4-Way Wishbone Trailer Harness, 48 in.....	155
63721 Nylon Insul. Couplers 12-10 Ga. M.....	186	64534 12 Ga. Two Conductor Bonded Wire	188	64847 4-Way Wishbone Trailer Harness, 30 ft.....	155
63722 Nylon Insul. Couplers 12-10 Ga. M.....	186	64581 14 Ga. Two Conductor Red-Jacketed Brake Wire.....	153	64849 12" Pigtail	155
63726 Nylon Insul. Couplers 12-10 Ga. F.....	186	64587 12 Ga. Two Conductor Grey-Jacketed Brake Wire	153	64850 12" Pigtail	155
63727 Nylon Insul. Couplers 12-10 Ga. F.....	186	64592 10 Ga. Two Conductor Grey-Jacketed Brake Wire	153	64852 48" Wishbone Harness	155
63742 Insulated Spade Terminals	185	64597 12 Ga. Two Conductor RV Red-Jacketed Brake Wire..	153	64853 60" Bonded Harness	155
63745 Insulated Spade Terminals	185	64650 14 Ga. 7-Conductor Trailer Cable.....	153	64854 60" Bonded Harness	155
63754 Insulated Spade Terminals	185	64651 14 Ga. 7-Conductor Trailer Cable.....	153	64855 Trailer Connector, 5-Way Flat.....	155
63756 Insulated Spade Terminals	185	64652 14 Ga. 7-Conductor Trailer Cable.....	153	64856 Trailer Connector, 5-Way Flat.....	155
63801 Self-Tapping (IDC) Connectors 18-14 AWG.....	186	64653 14 Ga. 7-Conductor Trailer Cable.....	153	64857 4-Way Trailer Connector - Complete	156
63802 Self-Tapping (IDC) Connectors 18-14 AWG.....	186	64654 14 Ga. 7-Conductor Trailer Cable.....	153	64858 Trailer Connector, 2-Way Flat.....	155
63804 Self-Tapping (IDC) Connectors 18-14 AWG.....	186	64658 14 Ga. 6-Conductor Trailer Cable.....	153	64859 Trailer Connector, 3-Way Flat.....	155
63806 Self-Tapping (IDC) Connectors 18-14 AWG.....	186	64659 14 Ga. 6-Conductor Trailer Cable.....	153	64860 Trailer Connector, 6-Way Square	155
63807 Self-Tapping (IDC) Connectors 18-14 AWG.....	186	64661 14 Ga. 4-Conductor Trailer Cable.....	153	64876 Cable Ties.....	189
63809 Self-Tapping (IDC) Connectors 18-14 AWG.....	186	64662 14 Ga. 4-Conductor Trailer Cable.....	153	64877 Cable Ties.....	189
63811 Self-Tapping (IDC) Connectors 12-10 AWG.....	186	64663 14 Ga. 4-Conductor Trailer Cable.....	153	64880 Cable Ties.....	189
63812 Self-Tapping (IDC) Connectors 12-10 AWG.....	186	64665 16 Ga. 6-Conductor Trailer Cable.....	153	64883 Cable Ties.....	189
63831 22-18 Ga. Wire Nut Connectors	186	64666 16 Ga. 6-Conductor Trailer Cable.....	153	64885 Cable Ties.....	189
63832 22-18 Ga. Wire Nut Connectors	186	64668 Multi-Gage - 7 Conductor Trailer Cable.....	153	64886 Cable Ties.....	189
63834 22-14 Ga. Wire Nut Connectors	186	64669 Multi-Gage - 7 Conductor Trailer Cable.....	153	64888 Cable Ties.....	189
63835 22-14 Ga. Wire Nut Connectors	186	64670 Multi-Gage - 7 Conductor Trailer Cable.....	153	64896 Cable Ties.....	189
63837 18-14 Ga. Wire Nut Connectors.....	186	64673 Multi-Gage - 7 Conductor Trailer Cable.....	153	64899 Cable Ties.....	189
63838 18-14 Ga. Wire Nut Connectors.....	186	64674 Multi-Gage - 7 Conductor Trailer Cable.....	153	64904 Cable Ties.....	189
63840 18-10 Ga. Wire Nut Connectors	186	64675 Multi-Gage - 7 Conductor Trailer Cable.....	153	64905 Cable Ties.....	189
63841 18-10 Ga. Wire Nut Connectors	186	64676 Multi-Gage - 7 Conductor Trailer Cable.....	153	64907 Cable Ties.....	189
63843 14-10 Ga. Wire Nut Connectors	186	64677 Multi-Gage - 7 Conductor Trailer Cable.....	153	64908 Cable Ties.....	189

64911 — 65905

64911 Cable Ties.....	189	65109 Glass Fuses.....	187	65260 12 Volt Flashers - Regular - 2 Prong.....	183
64914 Cable Ties.....	189	65111 Glass Fuses.....	187	65276 Universal Emergency Battery Terminal.....	189
64918 Cable Ties.....	189	65112 AGC / Glass Fuse Assortment.....	187	65280 Marine Universal Battery Terminal.....	189
64926 Cable Ties.....	189	65121 Fuses, Blade.....	187	65401 Freeze Check Refractometer.....	100
64928 Cable Ties.....	189	65123 Fuses, Blade.....	187	65418 ATC / ATO Blade Fuses - 15 amp.....	187
64939 Cable Ties.....	189	65125 Fuses, Blade.....	187	65419 ATC / ATO Blade Fuses - 20 amp.....	187
64942 Cable Ties.....	189	65127 Fuses, Blade.....	187	65420 ATC / ATO Blade Fuses - 25 amp.....	187
64944 Cable Ties.....	189	65129 Fuses, Blade.....	187	65421 ATC / ATO Blade Fuses - 30 amp.....	187
64945 Cable Ties.....	189	65131 Fuses, Blade.....	187	65422 Mini-Blade Fuses - 5 amp.....	187
64947 Cable Ties.....	189	65133 Fuses, Blade.....	187	65423 Mini-Blade Fuses - 10 amp.....	187
64948 Cable Ties.....	189	65135 Fuses, Blade.....	187	65424 Mini-Blade Fuses - 15 amp.....	187
64954 Cable Ties.....	189	65136 ATC / ATO Blade Fuse Assortment.....	187	65425 Mini-Blade Fuses - 20 amp.....	187
64960 Cable Ties.....	189	65141 Fuses, Blade.....	187	65426 Mini-Blade Fuses - 25 amp.....	187
64966 Cable Tie Mounting Bases.....	189	65143 Fuses, Blade.....	187	65427 Mini-Blade Fuses - 30 amp.....	187
64972 Split Wire Loom.....	186	65145 Fuses, Blade.....	187	65429 Max-Blade Fuses - 40 amp.....	187
64975 Split Wire Loom.....	186	65147 Fuses, Blade.....	187	65431 Max-Blade Fuses - 30 amp.....	187
64976 Split Wire Loom.....	186	65149 Fuses, Blade.....	187	65493 DIY Flush Adapter.....	101
64978 Split Wire Loom.....	186	65151 Fuses, Blade.....	187	65501 DIY Boat Winterizer.....	101
64979 Split Wire Loom.....	186	65153 Fuses, Blade.....	187	65800 Copper Lugs 8 ga. #10.....	188
64981 Split Wire Loom.....	186	65161 Fuses, Blade.....	187	65801 Copper Lugs 6 ga. #1/4.....	188
64984 Split Wire Loom.....	186	65163 Fuses, Blade.....	187	65803 Copper Lugs 4 ga. #5/16.....	188
64987 Split Wire Loom.....	186	65165 Fuses, Blade.....	187	65804 Copper Lugs 4 ga. #3/8.....	188
64990 Split Wire Loom.....	186	65167 Fuses, Blade.....	187	65806 Copper Lugs 2 ga. #5/16.....	188
64997 Heat Shrink Tubing - 1/8" 20-18 Ga. - red.....	186	65169 Fuses, Blade.....	187	65807 Copper Lugs 2 ga. #3/8.....	188
65000 Heat Shrink Tubing 3/16" 16-14 Ga. - blue.....	186	65176 Glass Fuses.....	187	65809 Copper Lugs 1/0 ga. #3/8.....	188
65003 Heat Shrink Tubing 1/4" 12-10 Ga. - yellow.....	186	65178 Glass Fuses.....	187	65812 Copper Lugs 2/0 ga. #3/8.....	188
65009 Heat Shrink Tubing 3/8" 14-18 Ga. - clear.....	186	65180 Glass Fuses.....	187	65820 Copper Lugs 1 ga. #3/8.....	188
65012 Heat Shrink Tubing 1/2" 8-2 Ga. - black.....	186	65182 Glass Fuses.....	187	65822 Copper Lugs 6 ga. #3/8.....	188
65020 Adhesive Lined Heat Shrink Tubing 1/2" - black.....	186	65186 ATC Fuse Tap Adapter.....	187	65823 Copper Lugs 8 ga. #5/16.....	188
65022 Adhesive Lined Heat Shrink Tubing 1/2" - black.....	186	65192 Circuit Breakers.....	187	65824 Copper Lugs 8 ga. #3/8.....	188
65023 Adhesive Lined Heat Shrink Tubing 3/4" - black.....	186	65194 Circuit Breakers.....	187	65827 Tin Plated Copper Lugs - 6 ga. #1/4.....	188
65025 Adhesive Lined Heat Shrink Tubing 3/4" - black.....	186	65196 Circuit Breakers.....	187	65828 Tin Plated Copper Lugs - 4 ga. #1/4.....	188
65042 Rubber-Coated Metal Clamps 5/16" ID.....	189	65198 Circuit Breakers.....	187	65829 Tin Plated Copper Lugs - 4 ga. #5/16.....	188
65048 Rubber-Coated Metal Clamps 1" ID.....	189	65200 Circuit Breakers.....	187	65830 Tin Plated Copper Lugs - 4 ga. #3/8.....	188
65054 3/16" Nylon Clamps.....	189	65202 Circuit Breakers.....	187	65832 Tin Plated Copper Lugs - 2 ga. #5/16.....	188
65057 1/4" Nylon Clamps.....	189	65218 Circuit Breakers.....	187	65833 Tin Plated Copper Lugs - 2 ga. #3/8.....	188
65060 3/8" Nylon Clamps.....	189	65220 Circuit Breakers.....	187	65834 Tin Plated Copper Lugs - 1/0 ga. #5/16.....	188
65063 1/2" Nylon Clamps.....	189	65222 Circuit Breakers.....	187	65835 Tin Plated Copper Lugs - 1/0 ga. #3/8.....	188
65068 3/4" Nylon Clamps.....	189	65224 Circuit Breakers.....	187	65836 Tin Plated Copper Lugs - 1/0 ga. #1/2.....	188
65070 Frame Clip, Small - 3/16" ID.....	189	65226 Circuit Breakers.....	187	65837 Tin Plated Copper Lugs - 2/0 ga. #5/16.....	188
65070 Small Frame Clips.....	154	65231 Blade Terminals.....	187	65838 Tin Plated Copper Lugs - 2/0 ga. #3/8.....	188
65072 Frame Clip, Medium - 1/4" ID.....	189	65233 Blade Terminals.....	187	65839 Tin Plated Copper Lugs - 2/0 ga. #1/2.....	188
65072 Medium Frame Clips.....	154	65235 Blade Terminals.....	187	65846 Tin Plated Copper Lugs - 1 ga. #3/8.....	188
65074 Large Frame Clips.....	154	65237 Blade Terminals.....	187	65848 Tin Plated Copper Lugs - 6 ga. #3/8.....	188
65085 PVC Electrical Tape.....	189	65239 Blade Terminals.....	187	65849 Tin Plated Copper Lugs - 8 ga. #5/16.....	188
65091 Glass Fuses.....	187	65241 Glass Fuse Holder.....	187	65851 Tin Plated Copper Lugs - 1 ga. #5/16.....	188
65093 Glass Fuses.....	187	65246 Glass Fuse Holder.....	187	65872 Heat Shrink Ring Terminals.....	185
65095 Glass Fuses.....	187	65248 Glass Fuse Holder.....	187	65884 Heat Shrink Ring Terminals.....	185
65097 Glass Fuses.....	187	65250 Blade Fuse Holder.....	187	65890 Heat Shrink Ring Terminals.....	185
65099 Glass Fuses.....	187	65252 Blade Fuse Holder.....	187	65893 Heat Shrink Ring Terminals.....	185
65101 Glass Fuses.....	187	65253 Blade Fuse Holder.....	187	65896 Heat Shrink Ring Terminals.....	185
65103 Glass Fuses.....	187	65255 Blade Fuse Holder.....	187	65902 Heat Shrink Ring Terminals.....	185
65105 Glass Fuses.....	187	65257 Blade Fuse Holder.....	187	65905 Heat Shrink Ring Terminals.....	185
65107 Glass Fuses.....	187	65260 12 V Flasher.....	183		

CAVICO**USA**

FEATURED PRODUCTS



Apartment-Sized Washer Drain Pan

White polypropylene plastic washer drain pan designed specifically for apartment-sized and stackable washers. Will not rust, corrode or crack. Includes 1¹/₂" PVC drain fitting Bottom or side outlet (not pre-cut) • 1¹/₂" drain can pass all codes

- Easy to install • Matte finish • OD 28" x 30"

20762

Water Heater Element Quick Change

Save time and water: Turn off water at the water heater to create a vacuum. Securely attach Water Heater Element Quick Change and place bucket handle in grooves of tool to catch excess water while replacing your water heater elements.

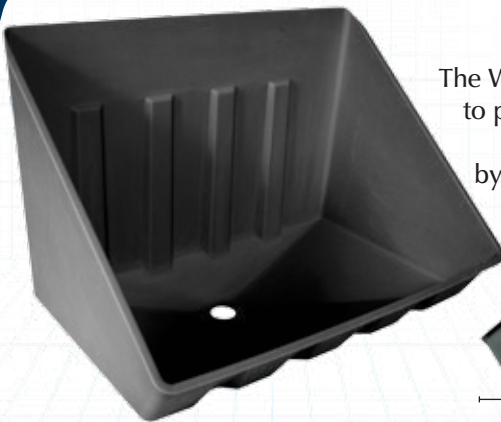
09973

Tankless Water Heater Drain Pans

The Wall Saver™ is made of injection-molded no-break polypropylene to provide superior strength and durability. Wall-mounted drain pan fits under most whole-house tankless water heaters; is required by building codes. Recyclable and non-toxic. U.S. Patents 8104634 and D653745. W: 21.5"; H: 16"; D: 13.4". Drain fitting included.

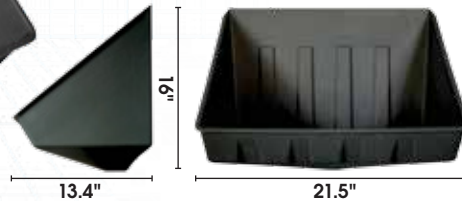

11470 with PVC Fitting
11476 with CPVC Fitting



Heavy Duty Contractor Hose

Reinforced, abrasion resistant hose for hot water use. Spring reinforced to reduce kinking. Stainless steel fittings. 5/8" diameter. Easier to clean; drinking water safe. 10-year limited replacement warranty Available in 25 ft, 50 ft & 100 ft lengths.

22863 25 ft Contractor Hose
22873 50 ft Contractor Hose
22883 100 ft Contractor Hose

Residential Water Heater Construction

Flexible stainless steel or copper connectors — connects to hot and cold water pipe system

Dielectric nipples or heat traps — with thermoplastic lining to prevent thread corrosion

Hot water outlet — water supply to house faucets

Anode rod — a rod composed of sacrificial metal that prevents deterioration of the steel tank and elements by controlling electrolysis

Upper thermostat — turns heating elements on or off to maintain preset or desired temperature; regulates power to the lower thermostat

Lower thermostat — controls lower heating element to maintain desired temperature

Drain valve — a metal or plastic valve used when draining heater for periodic cleaning or replacement of a defective water heater element

Temperature and pressure (T & P) valve — safety device to relieve excessive pressure and/or temperature buildup in tank

Cold water inlet — supplies water for heating to the tank

Run-off tube — carries water or steam safely to drain or drain pan if T & P valve activates

Cold water dip tube — a non-metallic tube that directs incoming cold water to the bottom of the tank

Steel tank with glass lining — to prevent corrosion

Insulation — helps maintain consistent water temperature

Heating element — a resistant type electrical component to generate heat

Drain pan — plastic or metal pan to collect and drain off leaking water or water from activated T & P valve; must be plumbed to drain

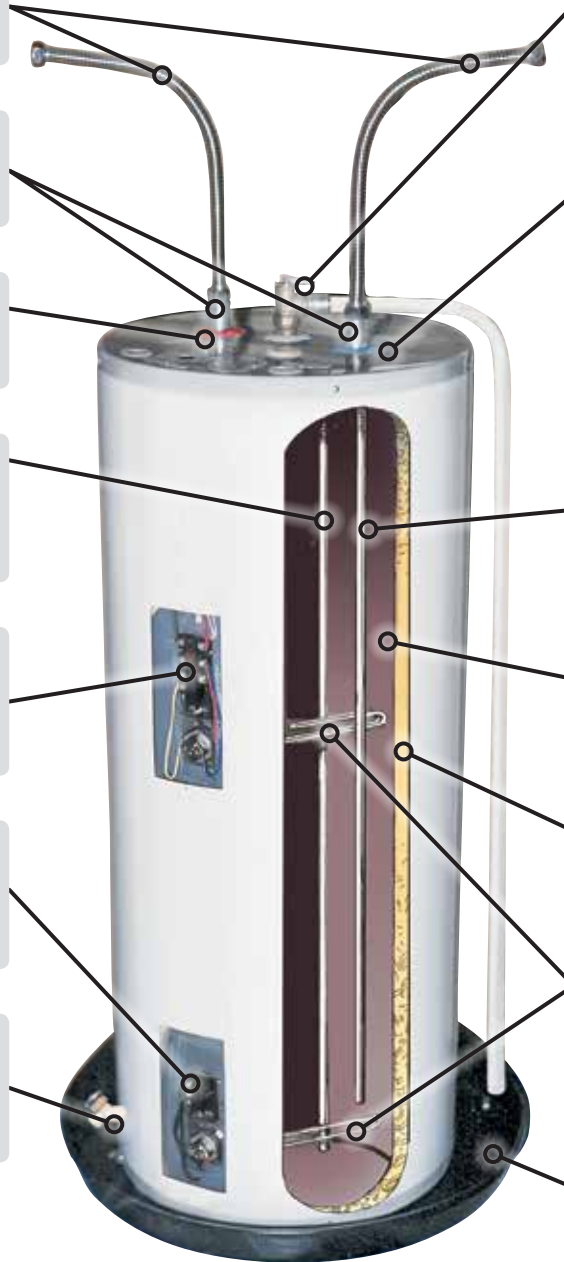

Water Heater Element Warranty



Limited Warranty: Elements will be replaced to the original purchaser if proven defective in materials or workmanship. No labor costs are included in this warranty. Complete warranty information available upon request. Warranty is void if element is installed in anything other than a residential hot water heater.

Standard and Better Elements — 1 year from purchase date.

Premium Elements — 5 years from purchase date.

No expressed or implied warranty is made with respect to this product including warranty of merchantability or fitness for a particular purpose. If an item is determined to be defective our return policy is limited to the replacement of original purchase.

Frequently Asked Questions About Water Heaters

Electric Water Heater Elements

I don't have hot water. How do I determine what is wrong?

Check the breaker or fuse box for a blown fuse or tripped breaker. If this is not the problem, shut off the power to the water heater. (IMPORTANT!) The problem may be caused by a defective or shorted element(s) or thermostat(s) or both. If you are experienced with plumbing and electrical tools, you can do the repairs yourself. Camco Mfg. provides a water heater tester (#10023) that lets you test the elements and thermostats while they remain installed on the heater. Instructions are included.

What causes water heater elements to fail, some sooner than others?

Several reasons: power surges, lightning, lime buildup and dry-firing (see below: *What is meant by the term "dry-firing?"*). Most water heaters are sold with high watt-density (HWD) elements. These are the least expensive and are the most susceptible to these problems. On a "Standard-Better-Premium" scale the HWD elements are STANDARD.

Why are some water heater elements folded back?

These are low watt-density (LWD) elements. The heat output (watts) per square inch of surface area is lower than that of a regular element. In order for total heat to be the same, the total surface has been increased. It is folded back so the length will fit the tank. Not all LWD elements are fold-backs. In areas with "hard" water, a LWD element resists lime build-up on its surface, thus extending its life. These elements are BETTER.

What are Lime Life elements?

These elements are PREMIUM. They are made of stainless steel and are ultra low watt-density. These features prevent lime build-up and extend the life of the element. A Lime Life element is resistant to dry-firing. These elements carry a limited 5-year warranty. Because of the low watt-density, these elements are folded back to reduce the length. Some are rippled to further reduce the length to fit the diameter of the tank.

What is meant by the term "dry-firing?"

High watt density and low watt-density are designed to function in water. If not surrounded by water, the intense heat they generate (dry fire) will cause them to burn out. The water tank must be full of water whenever the power is on. Dry-fire failure is not covered by any warranty. It is a human error. Dry-fired elements are easily detected. The element is soft and easily bent. In most cases, a hole is burned through the surface.

Can I replace the element in my water heater with higher wattage elements?

It is not recommended. The water heater is designed for that element size. Higher wattage might require heavier gauge wire and a larger capacity circuit breaker.

Can I use a water heater element in an application other than a water heater?

It is not recommended. These elements are designed specifically for residential water heaters. We have no experience or knowledge of other uses. You may do so at your own risk. Non-water heater use of our elements and thermostats voids all warranties.

I just installed a water heater element and now my heater makes a humming sound.

This is called a "harmonic." If the element is installed so that the loop is horizontal, the vibration from the electric current will cause the element to hum. This noise can be prevented by installing so that the loop is vertical. The flanged elements have markings on the flange indicating the vertical position of the loop. To eliminate the humming on screw-in elements, tighten the element another half turn. In some instances, less than a half turn will stop the harmonic.

Why aren't the two elements operating simultaneously?

In most residential water heaters only one element is on at any given time. The lower element does 90% or more of the heating. During periods of heavy use, the upper element clicks on (the lower switches off) and heats the upper part of the tank to 120°. It then shuts off, turns on the lower, and it heats the water to the setting of the lower thermostat.



Frequently Asked Questions About Water Heaters

Electric Water Heater Thermostats

Are water heater thermostats adjustable?

Most water heater thermostats provided by Camco are adjustable. They are factory set at 120°. On a two-element water heater, it is not recommended that the upper thermostat be adjusted. If a higher water temperature is desired, adjust the lower to a higher setting. Both may be lowered if a cooler temperature is desired. On thermostats without a degree dial, the temperature range is:

the Dot =	110° F
Hot=	120° F
A=	130° F
B=	140° F
C=	150° F
Very Hot=	160° F

I noticed that there are two styles of water heater thermostats. Are they interchangeable?

Yes, like models of the two thermostat manufacturers are interchangeable. Use caution in selecting the correct model for their position on the heater (upper, lower, single element T-stat).

How do I know which thermostat to buy?

A two-element water heater has two thermostats: an upper and a lower. Each must be replaced with a thermostat with the same function: upper for upper, lower for lower. They cannot be interchanged, as they perform specific functions. A single-element water heater has only one thermostat and that is called a "single element thermostat." The upper and lower thermostats for a two-element heater cannot be used on a single-element water heater and vice versa.

Other Miscellaneous Questions

I opened the drain valve and very little water flowed.

You probably have sediment and scale build-up on the bottom of the tank that is blocking the valve. In areas where the water is very "hard" or well water is used, lime build-up can occur. The high heat of the heater elements will cause scale and sediment to coat the elements and settle on the tank bottom. Light build-up of sediment may be removed by attaching a water hose to the drain valve. Drain the tank every 6-12 months, more often if necessary.

IMPORTANT: TURN OFF POWER FIRST OR IT COULD CAUSE ELEMENT BURN OUT.

The Temperature and Pressure relief valve has a threaded outlet. What attaches to it?

The T&P valve outlet must have a run-off tube attached to it. Most building codes require a tube that terminates 6" from the floor. If the T&P valve activates, water should flow into a drain or into a water heater pan that is plumbed to a drain. This run-off tube may be metal or plastic. Check local plumbing codes for correct material for your area.

What are dielectric fittings and connectors?

When fittings of unlike metals are joined together (copper with brass, brass with steel, etc.) the faint electrical current that is present in any water pipe system will cause erosion of the threads in one or both of the fittings and cause leaking. The plastic liner or sleeve in the dielectric fittings and connectors prevents this from happening. Note: Stainless steel fittings and connectors are naturally dielectric and do not need the plastic lining.

What is an anode rod?

It is a magnesium or aluminum rod inserted in the heater, from the top, in an opening of its own or as part of the outlet nipple. The metal is self-sacrificing (corrodes); this protects the tank and elements from corroding. Replacement anode rods are available and easy to install.

Are water heater drain pans necessary?

It depends on the plumbing codes in your area and the location of your water heater. If your heater is in a garage or a non-finished basement where leaking water would flow harmlessly into a drain, a pan is not necessary. However, if the heater is in or above a living space where leaking could cause extensive water damage, it is cheap insurance to protect your home from such an event.

What type of pan should be used?

Plastic pans should be used with electric water heaters, and metal pans should be used for gas water heaters and can be used with electric water heaters. Codes in some areas require metal pans for all heaters installed in a living space.

What is the purpose of a water heater stand?

A stand is used primarily with gas water heaters when installed in garages and basements where combustible fumes may exist. Gas heaters have an open flame, and tests have shown that placing a gas water heater at least 16" above the floor will offer some protection against combustion of volatile fumes.



Water Heater Elements

Fits most models: • American • A O Smith • Bradford White
 • Craftmaster • General Electric • GS Wood (some models)
 • Kenmore • Lochinvar • Maytag • Mor-Flo • Reliance
 • Rheem • Richmond • Ruud • Sears • State • Whirlpool

Premium - Lime Life Water Heater Elements - Ultra Low Watt Density - Our best immersion elements

UL listed & Canadian Listed - 5 year limited warranty Detailed instructions and gasket included with each packaged element

Made of the highest grade nickel and chromium incoloy - Ultra low watt density: burns at 50 watts per square inch - Resists dry firing - Best when water has high mineral content - Heats in lime and sand buildup that would burn out ordinary elements



Stock #	Watts @ 240v	Watts @ 208v	Watts @ 120v	Nominal Voltage	Type	Min. Tank Diameter	Case Qty.
---------	--------------	--------------	--------------	-----------------	------	--------------------	-----------

Screw-In Foldback (1" NPSM; Fits most screw in type water heaters.) includes gasket #06822

02853	-	-	1500w	120v	Ultra LWD	9"	12
02903	2500w	2000w	-	240v	Ultra LWD	12"	12
02913	3500w	2500w	-	240v	Ultra LWD	15"	12
02923	4500w	3500w	-	240v	Ultra LWD	15"	6
02933	5500w	4125w	-	240v	Ultra LWD	15"	12

Screw-In Ripple Foldback

(1" NPSM; Fits most screw in type water heaters.) includes gasket #06822

02953	4500w	3500w	-	240v	Ultra LWD	15"	6
02963	5500w	4125w	-	240v	Ultra LWD	15"	3

Universal Flange Foldback includes gasket #06882

04943	4500w	3500w	-	240v	Ultra LWD	15"	6
04963	5500w	4125w	-	240v	Ultra LWD	15"	6

Screw-In - Special Order Only

(1" NPSM; Fits most screw in type water heaters) includes gasket #06822

02152	1500w	1125w	-	240v	Ultra LWD	12"	12
02972	6000w	4500w	-	240v	Ultra LWD	24"	12



Better - Low Watt Density Elements - 1 year warranty

UL listed & Canadian Listed - 1 year limited warranty Detailed instructions and gasket included with each packaged element

Made of copper tubing with magnesium oxide and nickel plating - Low Watt Density: Burns at 73 watts per square inch

Stock #	Watts @ 240v	Watts @ 208v	Watts @ 120v	Nominal Voltage	Type	Min. Tank Diameter	Case Qty.
---------	--------------	--------------	--------------	-----------------	------	--------------------	-----------

Screw-In (1" NPSM; Fits most screw in type water heaters) includes gasket #06822

02463	-	-	1500w	120v	LWD	10"	12
-------	---	---	-------	------	-----	-----	----

Screw-In Foldback (1" NPSM; Fits most screw in type water heaters) includes gasket #06822

02493	2500w	2000w	-	240v	LWD	10"	12
02523	3500w	2500w	-	240v	LWD	11"	12
02583	4500w	3500w	-	240v	LWD	13"	12
02613	6000w	4500w	-	240v	LWD	17"	12

Flat Flange Foldback includes gasket #06842

04103	4500w	3500w	-	240v	LWD	13"	12
-------	-------	-------	---	------	-----	-----	----

Universal Flange Foldback includes gasket #06882

04703	4500w	3500w	-	240v	LWD	13"	12
-------	-------	-------	---	------	-----	-----	----

Screw-In Special Order Only - includes gasket #06822

Stock #	Watts @ 277v	Watts @ 240v	Watts @ 120v	Nominal Voltage	Type	Min. Tank Diameter	Case Qty.
04752	2000w	1500w	-	277v	LWD	9"	12
04762	4500w	3380w	-	277v	LWD	15"	12



Stock elements that end in 3 are cased. To order items in bulk, change the last digit of the stock number to 2. Minimum order quantity for bulk elements is 25.

Water Heater Elements

Fits most models: • American • A O Smith • Bradford White
 • Craftmaster • General Electric • GS Wood (some models)
 • Kenmore • Lochinvar • Maytag • Mor-Flo • Reliance
 • Rheem • Richmond • Ruud • Sears • State • Whirlpool

Standard - High Watt Density Elements - 1 year warranty

UL listed & Canadian Listed - 1 year limited warranty Detailed instructions and gasket included with each packaged element **Made of copper tubing with magnesium oxide and nickel plating** - High Watt Density: Burns at 150 watts per square inch

Stock #	Watts @ 240v	Watts @ 208v	Watts @ 120v	Nominal Voltage	Type	Min. Tank Diameter	Case Qty.
Screw-In (1" NPSM; Fits most screw in type water heaters.) includes gasket #06822							
02483	-	-	1650w	120v	HWD	7.5"	6
02103	-	-	1000w	120v	HWD	8"	12
02143	-	-	1500w	120v	HWD	9"	6
02163	1500w	1200w	-	240v	HWD	9"	12
02183	-	-	1750w	120v	HWD	9"	12
02203	-	-	2000w	120v	HWD	9"	12
02223	2000w	1500w	-	240v	HWD	9"	12
02243	2500w	2000w	-	240v	HWD	10"	12
02263	3000w	2250w	-	240v	HWD	12"	6
02283	3500w	2500w	-	240v	HWD	14"	12
02293	3800w	3000w	-	240v	HWD	15"	12
02303	4000w	3000w	-	240v	HWD	15"	12
02343	4500w	3500w	-	240v	HWD	15"	12
02862	-	5500w	-	208v	HWD	12"	1

Screw-In Foldback (1" NPSM; Fits most screw in type water heaters.) includes gasket #06822							
02363	5500w	4125w	-	240v	HWD	11"	12
02643	4500w	3500w	-	240v	HWD	9"	12

Flat Flange includes gasket #06842							
03743	-	-	1500w	120v	HWD	9"	12
03923	3500w	2500w	-	240v	HWD	14"	12
03943	4500w	3500w	-	240v	HWD	15"	12

Universal Flange includes gasket #06882							
04363	-	-	1500w	120v	HWD	9"	3
04383	1500w	1200w	-	240v	HWD	8"	12
04443	-	-	2000w	120v	HWD	9"	12
04483	2500w	2000w	-	240v	HWD	10"	6
04503	3000w	2250w	-	240v	HWD	12"	12
04523	3500w	2500w	-	240v	HWD	14"	12
04563	4000w	3000w	-	240v	HWD	15"	12
04603	4500w	3500w	-	240v	HWD	15"	6
04643	5500w	4125w	-	240v	HWD	11"	12

Universal Flange Foldback includes gasket #06882							
04803	4500w	3500w	-	240v	HWD	9"	12

Screw-In - Special Order Only includes gasket #06822							
Stock #	Watts @ 480v	Watts @ 277v	Watts @ 240v	Nominal Voltage	Type	Min. Tank Diameter	Case Qty.
02382	4500w	-	-	480v	HWD	12"	12
02352	5000w	-	-	480v	HWD	12"	12
02392	6000w	-	-	480v	HWD	14"	12
04732	-	4500w	3380w	277v	HWD	15"	12

Screw-In Foldback - Special Order Only includes gasket #06822							
04742	-	6000w	4500w	277v	HWD	13"	12

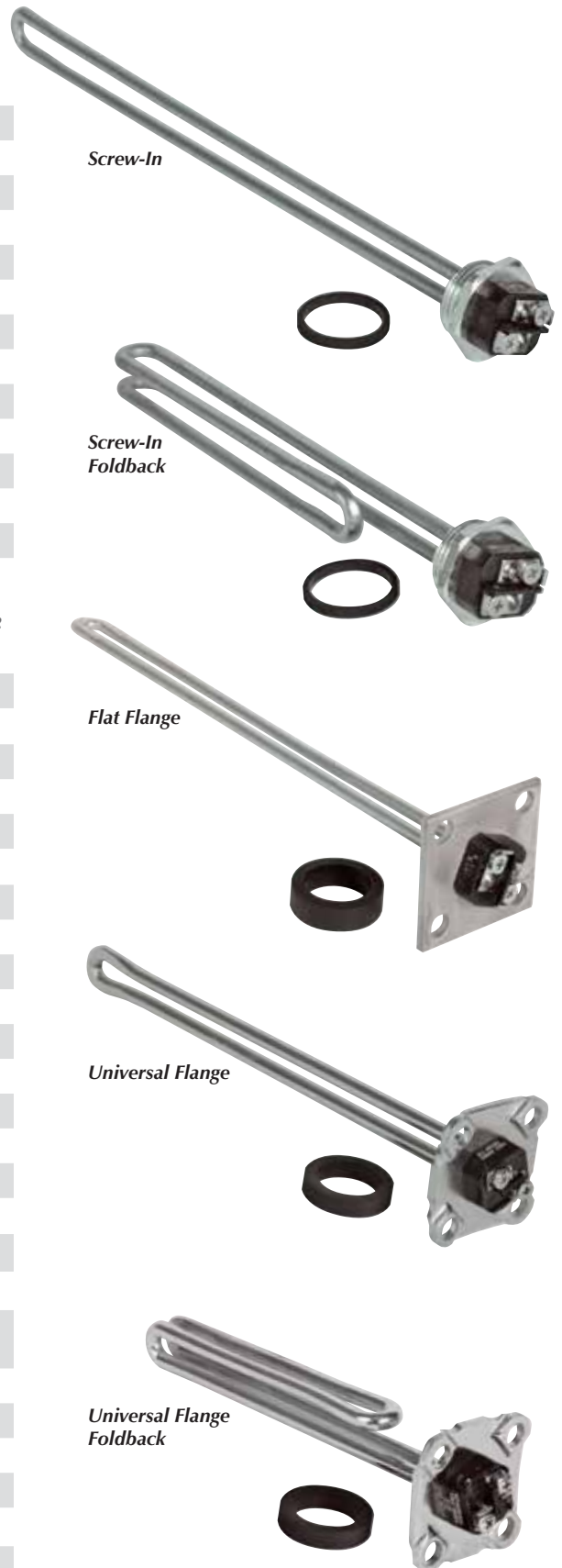

Stock elements that end in 3 are carded. To order items in bulk, change the last digit of the stock number to 2. Minimum order quantity for bulk elements is 25.

Water Heater Elements

Low Watt Density & Ultra Low Watt Density Duron® Elements

1-3/8" thread screw-in style elements for the State Industries manufactured Duron tank water heaters. Also used in Sears Duron tank water heaters. Each element includes two gaskets.

Stock #	Watts @ 240v	Watts @ 208v	Watts @ 120v	Nominal Voltage	Type	Min. Tank Diameter	Case Qty.
---------	--------------	--------------	--------------	-----------------	------	--------------------	-----------

Better - Screw-In Foldback 1 year limited warranty

02713	3800w	3000w	-	240v	LWD	13	12
02723	4500w	3500w	-	240v	LWD	13	12

Premium - Screw-In Ripple Foldback 5 year limited warranty

02753	4500w	3500w	-	240v	Ultra LWD	15	6
-------	-------	-------	---	------	-----------	----	---



1-3/8" Thread
Screw-In Foldback

For the State Industries manufactured Duron tank water heaters. Also used in Sears Duron tank water heaters.

Element Conversion Kit

Use a standard screw-in element to replace a flat, universal or round flange element using the Element Conversion Kit.

This adapter kit is intended for use with a screw-in type element to replace water heater elements that look like figures 1, 2 or 3.

Stock#	Description	Qty.
07223	Universal Adapter Kit	12

07223 contains: (1) 2-1/2" 4-bolt Adapt-a-Flange, (1) Four Hole Gasket, (4) 5/16" -18 5/8" Hex Washer-Head Bolts (1) Screw-In Gasket and (1) Thermostat Bracket

07222	2-1/2" 4-Hex Bolt Adapt-A-Flange only	50
-------	---------------------------------------	----



Directions:

Remove screws and discard old element and thermostat bracket.

Install screw-in element and gasket supplied with element into square adapter flange. Tighten firmly.

Install gasket (supplied with this kit) in element seat, being careful to ensure a good seat. See diagrams to determine which gasket to use.

Install element with new thermostat bracket using old screws or new ones provided. Be careful that screws are not too long and bottom out against the tank.

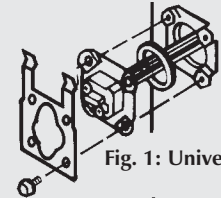

Fig. 1: Universal

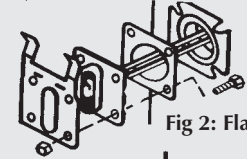

Fig 2: Flat

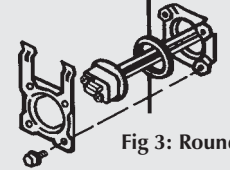
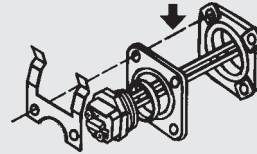

Fig 3: Round

Replacement gasket goes here.



Element Gaskets

Stock #	Description	OD	ID	Thickness	Qty
06822	Screw-In Element Gasket	1.425"	1.225"	0.165"	25
06842	Flat Flange Element Gasket	1.625"	1.1875"	0.50"	25
06882	Universal Flange Element Gasket	1.64"	1.13"	0.35"	25
06902	Four Hole Element Gasket	-	1.5625"	0.0625"	25
07133	Universal Gasket Kit (One each of 06822, 06882, 06902)				12



Open Coil Dry Water Heater Elements

Stock#	Watts	Volts	Insulators	Min. Tank Diameter	Pkg.	Qty.
--------	-------	-------	------------	--------------------	------	------

Better Heavy gauge nichrome wire with spot welded terminals

05741	1500w	120v	7	12 3/4"	Box	12
05742	1500w	120v	7	12 3/4"	Bulk	25
05761	1750w	120v	7	12 3/4"	Box	12
05762	1750w	120v	7	12 3/4"	Bulk	25
05781*	2000w	120v	7	12-3/4"	Box	12
05782*	2000w	120v	7	12-3/4"	Bulk	25
05801*	2000w	240v	7	12-3/4"	Box	12

Good Smaller gauge nichrome wire with spot welded terminals

05701*	1000w	120v	6	11"	Box	12
05901	1500w	120v	6	11"	Box	12
05902	1500w	120v	6	11"	Bulk	25

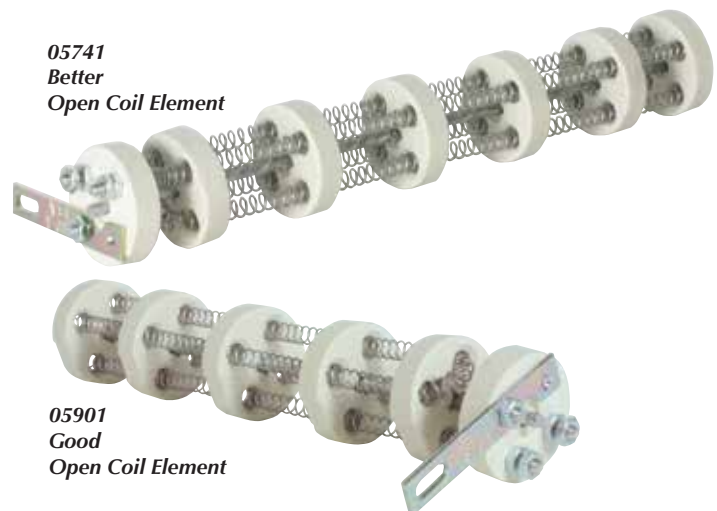

05741
Better
Open Coil Element

05901
Good
Open Coil Element

* Limited Quantities

Stock elements that end in 3 are carded. To order items in bulk, change the last digit of the stock number to 2. Minimum order quantity for bulk elements is 25.

Water Heater Repair

Water Heater Repair Kits for the DIY or professional plumber

All the parts needed to repair or renew an electric water heater system

Fits most models: • American • A O Smith • Bradford White • Craftmaster • General Electric • GS Wood (some models) • Kenmore • Lochinvar • Maytag • Mor-Flo • Reliance • Rheem • Richmond • Ruud • Sears • State • Whirlpool

Standard - With High Watt Density Elements

Stock #	Description	Qty
07013	Plumber's Pack w/Therm-O-Disc Style T-stats Contains: (2) #02342 High Watt Density Elements 4500w 240v (1) #08122 Therm-O-Disc lower thermostat (1) #08162 Therm-O-Disc upper thermostat	6
07023	Plumber's Pack w/Apcom Style Thermostats Contains: (2) #02342 High Watt Density Elements 4500w 240v (1) #07722 Apcom style lower thermostat w/protector (1) #07862 Apcom style upper thermostat w/protector	6

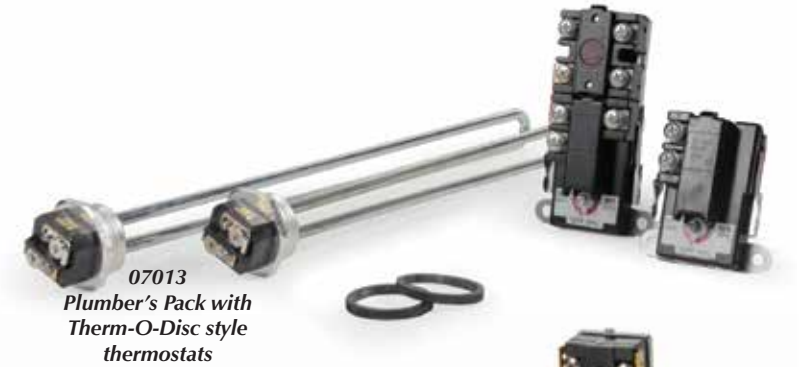

Better - With Low Watt Density Elements (not shown)

07033	Plumber's Pack w/Therm-O-Disc Style T-stats Contains: (2) #02582 Low Watt Density elements 4500w 240v (1) #08122 Therm-O-Disc lower thermostat (1) #08162 Therm-O-Disc upper thermostat	6
07043	Plumber's Pack w/Apcom Style Thermostats Contains: (2) #02582 Low Watt Density elements 4500w 240v (1) #07722 Apcom style lower thermostat w/protector (1) #07862 Apcom style upper thermostat w/protector	6



Stock items that end in 3 are carded.

Water Heater Element Quick Change

Save time and water: Turn off water at the water heater to create a vacuum. Securely attach Water Heater Element Quick Change and place bucket handle in grooves of tool to catch excess water while replacing your water heater elements.

09973

Collapsible Bucket

The perfect size for many around-the-house uses. Also great for RVing, camping, fishing and more. Great for use in tight spaces; under sink drain traps and water heater drain valves. Opens to 9.25 inches and folds down to less than 2 inches for compact storage. Zippered storage bag included.

42993



09973

NO NEED
to drain
your tank

42993



Water Heater Thermostats

Apcom Style

UL listed • Meets original specification lengths for American, AO Smith, Bradford White, GE, GSW, Kenmore, Maytag, Reliance, Rheem, Richmond, Rudd, Sears, State, Whirlpool

- Carded thermostats are packed in convenient cut cases and come complete with detailed instructions and wiring diagrams for easy installation
- Built-in safety switch to prevent overheating • Energy efficient range setting

Apcom Style Thermostats

Stock #	Description	Apcom Style	HLC	Terminal Protector	Application Voltage	Qty.
07863	Thermostat, Upper	WH10A	Yes	Yes	240/208/120	6
07723	Thermostat, Lower	WH9	-	Yes	240/208/120	6
07843	Thermostat, Single Element	WH9	Yes	Yes	240/208/120	6

Apcom Style Extended Shank

07853	Thermostat, Single Element	WH9	Yes	Yes	240/208/120	12
07733	Thermostat, Lower	WH9	-	Yes	240/208/120	6

HLC = High Limit Control

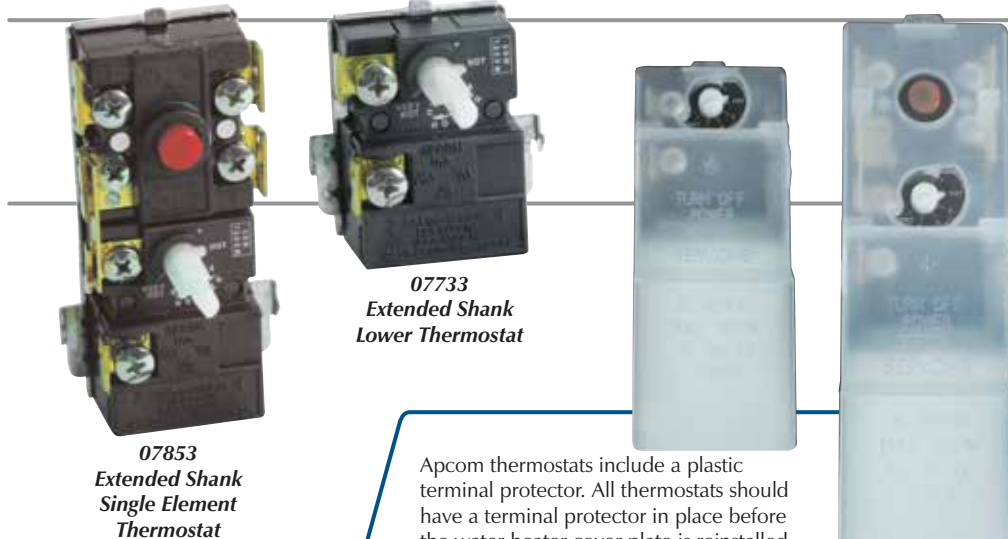
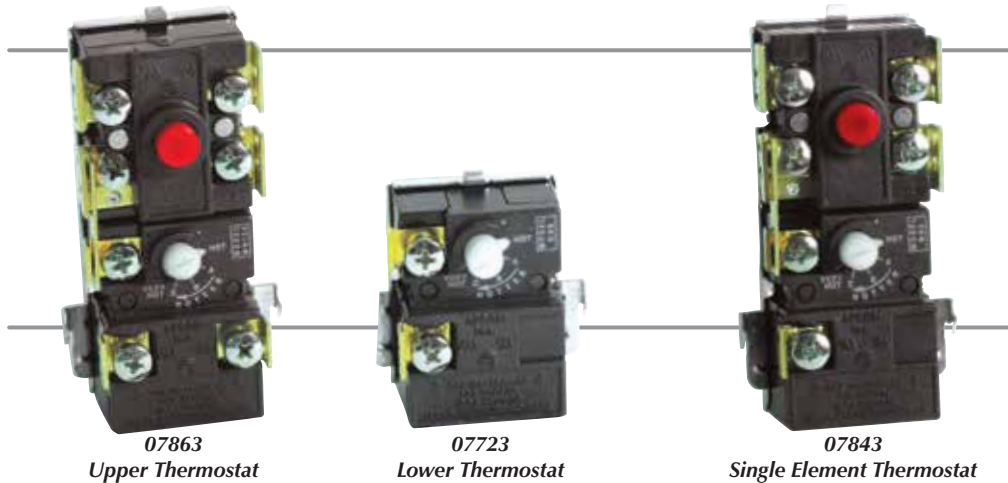

Stock thermostats that end in 3 are carded. To order items in bulk, change the last digit of the stock number to 2. Minimum order quantity for bulk items is 25.

Apcom Style Settings

Dot = 110°F B = 140°F
 Hot = 120°F* C = 150°F
 A = 130°F Very Hot = 160°F
 * Factory preset at 120°



Apcom Style

Wiring Diagram of Thermostats to Standard Water Heater Elements

Note: Wire color may vary on some water heaters, but connections remain the same.

Double Element Water Heaters

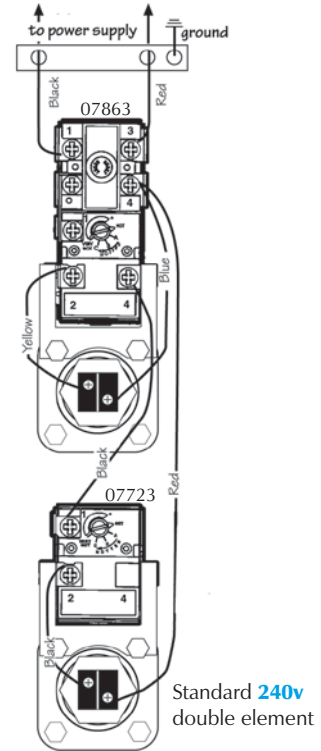

Single Element Water Heaters

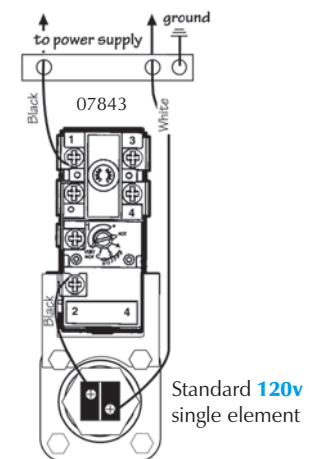
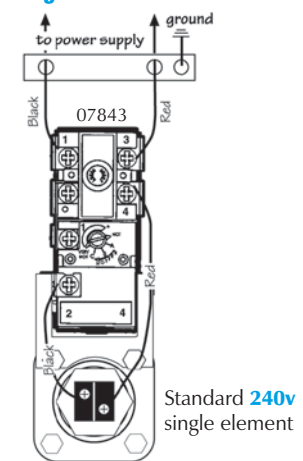

Water Heater Thermostats

Therm-O-Disc Style

UL listed • Meets original specification lengths for American, AO Smith, Bradford White, Craftmaster, GE, GSW, Kenmore, Maytag, Reliance, Rheem, Richmond, Rudd, Sears, State, Whirlpool

- Carded thermostats are packed in convenient cut cases and come complete with detailed instructions and wiring diagrams for easy installation
- Built-in safety switch on single and upper thermostats to prevent overheating • Energy efficient range setting

Therm-O-Disc Style Thermostats

Stock #	Description	Therm-O-Disc Style	HLC	Application Voltage	Qty.
08163	Thermostat, Upper	59T/66T	Yes	240/208/277/120/480	12
08123	Thermostat, Lower	59T	-	240/208/277/120/480	12
08143	Thermostat, Single Element	59T/66T	Yes	240/208/277/120/480	12
08013	Thermostat, Single Element 120V	59T/66T	Yes	120	12
08213	Thermostat, Upper	89T	Yes	240/208/277/120/480	12
08223	Thermostat, Single Element	89T	Yes	240/208/277/120/480	12

HLC = High Limit Control

Therm-O-Disc Style Terminal Protector

Stock #	Description	Qty.
08113	TOD Upper T-Stat Terminal Protector	12
08103	TOD Lower T-Stat Terminal Protector	12

Therm-O-Disc Style Thermostats do not include a Plastic Terminal Protector. Order 08113 or 08103 if shield is damaged or missing.



08163
Upper Thermostat



08123
Lower Thermostat



08143
Single Element
Thermostat



08013
Single Element
Thermostat



08213
Upper Thermostat



08223
Single Element
Thermostat



08113
Upper Thermostat
Protective Cover



08103
Lower Thermostat
Protective Cover

Stock thermostats that end in 3 are carded.
To order items in bulk, change the last digit of the stock number to 2.
Minimum order quantity for bulk items is 25.

Therm-O-Disc Style

Wiring Diagram of Thermostats to Standard Water Heater Elements

Note: Wire color may vary on some water heaters, but connections remain the same.

Double Element Water Heaters

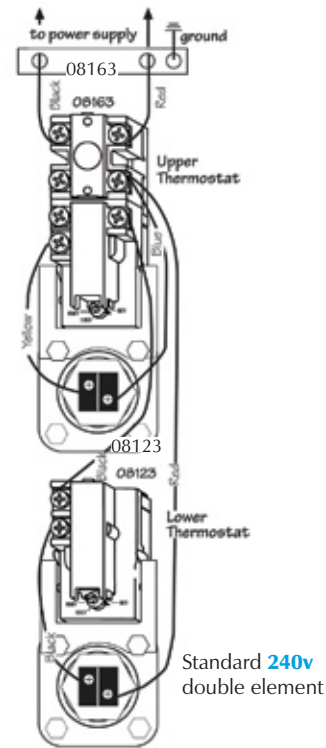

Single Element Water Heaters

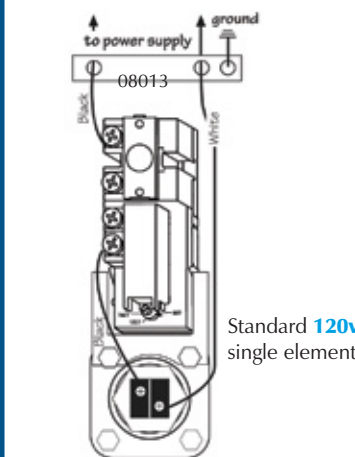
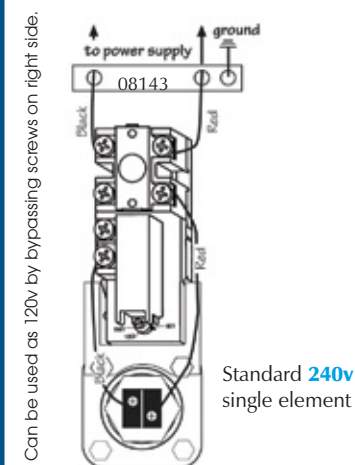

Water Heater Thermostats and Accessories

About Electric Water Heater Thermostats

Double Element Heaters

The majority of residential water heaters are designed with two elements controlled by two different thermostats. The upper thermostat is the "brain" of the water heater. It controls the heat generated by the upper element, and it controls power delivered to the lower thermostat. Most residential water heaters are designed to have the upper and lower thermostats work separately.

The upper and the lower thermostats never operate simultaneously. The upper thermostat has a safety device attached to it called a High Limit Control (HLC). It has a heat sensor that will shut down the power to the heater if the temperature of the tank exceeds safety limits. The button can be reset to restore power to the heater. **Do not reset the HLC until the problem causing the unit to trip is corrected.**

Operation Cycle of Double Element Heaters

1. The upper thermostat senses cold water and has energized the upper element. Although contacts on both thermostats are normally closed in response to the cold water, the double-throw upper thermostat completes the circuit only to the upper heating element. Because of the double throw action, power to the lower thermostat is cut off.
2. As the upper element operates, it heats the water above it (approximately one quarter of the tank's capacity).
3. The water in the upper quarter of the tank is heated until it reaches the temperature set on the upper thermostat. The upper thermostat then breaks the circuit to the upper heating element and completes the circuit to the lower thermostat.
4. The lower element then operates and heats the remainder of the water in the tank.
5. The lower thermostat breaks the circuit to the lower element when the water in the lower portion of the tank has been heated to its setting. The entire tank is now filled with hot water.
6. As hot water is drawn from the top of the tank, cold water is delivered to the bottom of the tank through the dip tube. The lower thermostat reacts to the entering cold water by closing its contacts, energizing the lower heating element and heating the water as it enters the tank.
7. Thermostats are factory preset at 120°.

Single Element Heaters (with high limit)

Most of the smaller water heaters and point-of-use heaters are designed with only one element and thus only one thermostat. Most of the single element water heaters are wired for 120v. Never connect or adapt a 120v water heater to a 240v system.

The high limit control is located on the thermostat. (See diagrams for proper wiring.)

NOTE: Because the HLC is attached to the single element thermostat, it looks similar to an upper thermostat for a two-element heater. Care should be taken in choosing the correct replacement thermostat. An upper thermostat will not work on a single element heater.

Therm-O-Disc Commercial Thermostats

Stock #	Description	T-O-D Style	HLC	Application Voltage	Qty.
08304	Upper Thermostat - 180° F	59T	Yes	480/240/208/120	6
08314	Lower Thermostat -180° F	59T	-	480/240/208/120	6

HLC = High Limit Control

For Commercial Use Only

UL Listed

These thermostats are for commercial use only, not to be used in a domestic setting.

Therm-O-Disc Style Thermostats are not supplied with a Protective Shield. Order 08113 or 08103 if shield is damaged or missing.



Water Heater Tester

Tests elements and thermostats while they are in the heater. May also be used to test continuity in fluorescent lights, fuses and all appliances. Sensitive enough to measure even the fine filament wire in a light bulb. Sensitive LED light indicates continuity. Unbreakable body with protective cover over light and probe. More useful than a circuit tester. Complete instructions and batteries included.

Stock #	Description	Case Qty
10023	Water Heater Continuity Tester	12
10025	Water Heater Continuity Tester Display (18 Testers per display)	1

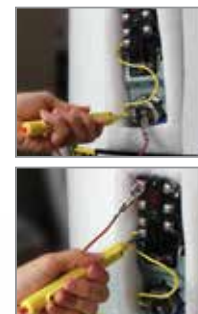

10023 Water Heater Tester



Gas Leak Testing

Gas Leak Detector

Safe, clean-drying gas leak detector fluid detects dangerous leaks in anything that can be tested with air or gas pressure. Just daub or spray on and look for bubbles.

Stock#	Description	Qty.
10324	Gas Leak Detector 8 oz. w/sprayer	6
10325	Gas Leak Detector 8 oz. w/dauber	6
10367	Gas Leak Detector gallon	6
10368	Gas Leak Detector (55 gallon)	1

Gas Leak Detector



10324 10325

Gas Pressure Test Kit

Tests LP and natural gas controls for correct pressure or leaks. 0-20 oz. PSI on inner reading; 0-35" of water column on outer reading. Easy to use and read with 2.5" dial. Includes brass pressure tap fitting and 30" soft hose.

Stock#	Description	Qty.
10389	Gas Pressure Test Kit	1
10399	GP Test Kit Tapered Rubber Nipple	1
10409	Gas Pressure Test Kit Hose	1



10389 Gas Pressure Test Kit

Gas Water Heater Parts & Accessories



08401
Natural Gas



08421
Natural Gas



08461
LP Gas

Natural Gas Controls

- 4" water column • 1-1/4" shank length • 1/2" NPT gas inlet by 1/2" inverted flare outlet
- Adjustable from 70° to 160° F

Stock#	Brand	Rating	Qty.
08401	White-Rodgers	42000 BTU	1
08421	Robertshaw	79000 BTU	1

LP Gas Controls

- 1/2" NPT gas inlet by 1/2" inverted flare outlet • Preset 10" water column - adjustable from 9" to 12"
- 1-5/8" shank length • Adjustable from 120° to 160° F • 100,000 BTU/HR

08461 | (Left Hand Threads) Robertshaw (for heaters manufactured after January 1986) | 1

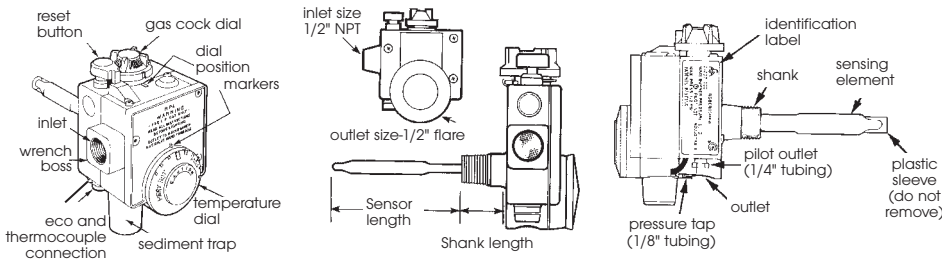

Gas Control Extender

- Adds shank length to gas controls • 2" overall length • 3/4" Male NPT x 3/4" Female NPT • Dielectric construction • Thermoplastic lining prevents corrosion

09072 | Gas Control Extender | 50



Universal Gas Control Wrench

For simple installation and removal of gas controls. Adjustable with positive-lock screw.

09963 | Gas Control Wrench | 2

09963 Gas Control Wrench



Thermocouples

Kits contain thermocouple and positioning adapters to fit all gas water heaters as well as gas appliances. Made with copper tubing.

Stock#	Description	Qty.
09253	12" Thermocouple Kit	6
09273	18" Thermocouple Kit	6
09293	24" Thermocouple Kit	6
09313	30" Thermocouple Kit	6
09333	36" Thermocouple Kit	6
09353	48" Thermocouple Kit	6



09253
Thermocouple

Gasket Replacement Kit (FVIR)

Fits Richmond, Rheem, Ruud, Vanguard and General Electric brand water heaters. Kits contain burner access door gasket, #20 Torx-head tool, four torx-head screws, and four J-style clip-on nuts. Kit 09294 also includes a 24-inch thermocouple.

Stock#	Description	Qty.
09423	Burner Access Door Kit	6
09294	Thermocouple Install Kit	6



09294
Gasket Replacement
Kit w/24"
Thermocouple

Gas Water Heater Stand

Many local building codes require a water heater stand for gas water heaters located in areas where the accumulation of combustible fumes may occur. Constructed of galvanized steel. Minimal assembly required. For use with most residential water heaters; Fits up to a 50 gallon water heater. 21" x 21" x 18"

11231 | Gas Water Heater Stand Kit | 1



11231
Gas Water Heater
Stand

Water Heater Connectors & Kits

3/4" Water Heater Connector Kits

Stock #	Description	Qty
10193	15" Copper Connector Kit - Gas or Electric	6
10223	15" x 3/4" Copper Connector Kit - Gas or Electric	6
10533	18" x 3/4" Copper Connector Kit - Gas or Electric	6
10775	18" x 3/4" Stainless Connector Kit - Gas or Electric	6
10795	15" x 3/4" Stainless Connector Kit - Gas or Electric	6
10183	15" Copper Connector Kit - Gas	6
10523	18" Copper Connector Kit - Gas	6
10785	15" Stainless Connector Kit - Gas	6
10765	18" Stainless Connector Kit - Gas	6

Kit Contains:

	Gas or Electric					Gas			
	10223	10193	10795	10533	10775	10183	10785	10523	10765
(2) Copper Flexible Water Connectors, 3/4" FIP	✓	✓		✓		✓		✓	
(2) Stainless Steel Flexible Water Connectors, 3/4" FIP			✓		✓		✓		✓
(2) Dielectric Nipples, 3/4" NPT x 2" Long	✓	✓	✓	✓	✓	✓	✓	✓	✓
(1) Roll Teflon Tape	✓	✓	✓	✓	✓	✓	✓	✓	✓
(2) Compression Fittings, 3/4" Compression x 3/4" Male NPT		✓	✓	✓	✓	✓	✓	✓	✓
(1) Stainless Steel Gas Connector, 1/2" OD x 24" 1/2" M X F (Tapped 3/8" Female NPT)						✓	✓	✓	✓

Use...	For Water Heater Installation/Replacement of...
10223	GAS or ELECTRIC where "cold" supply and "hot" distribution lines are Threaded and Flexible Gas Connector is not needed or allowed by codes.
10193 10795 10533 10775	GAS or ELECTRIC where "cold" supply or "hot" distribution lines are 3/4" copper (i.e. not threaded) and Flexible Gas Connector is not needed or not allowed by codes.
10183 10785 10523 10765	GAS where "cold" supply or "hot" distribution lines are 3/4" copper (i.e. not threaded) and codes allow use of Flexible Gas Connector.



10223
Copper Connector Kit
Gas or Electric

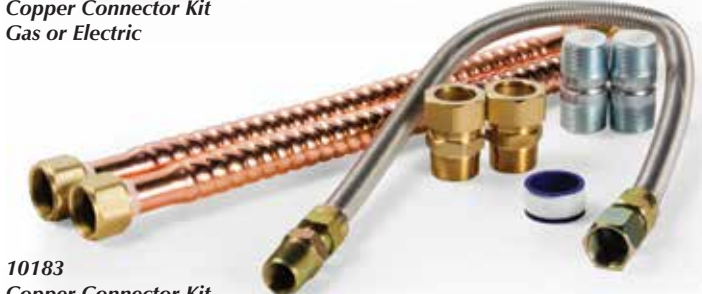

10183
Copper Connector Kit
Gas



10193
Copper Connector Kit
Gas or Electric

Compression Fittings

Stock#	Description	Qty.
10196	3/4" Compression x 3/4" NPT Fitting	6
10205	1/2" Compression x 3/4" NPT Fitting	6

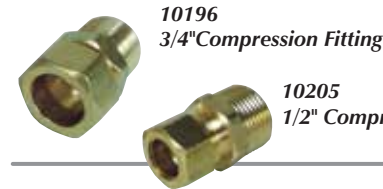

10196
3/4" Compression Fitting

10205
1/2" Compression Fitting

Flexible Water Connectors—Seamless Corrugated Copper

7/8" ID flexible water connectors -125 PSI maximum

10035	18" SWT x 3/4" FIP Cut Case	25
-------	-----------------------------	----

3/4" FIP x 3/4" FIP flexible water connectors-125 PSI maximum

10043	12" Water Connector - Card	12
10053	15" Water Connector - Card	12
10063	18" Water Connector - Card	12
10083	24" Water Connector - Card	12

Flexible Water Connectors—Corrugated Stainless Steel

3/4" FIP x 3/4" FIP flexible water connectors-125 PSI maximum

10735	15" Stainless Water Connector	25
10747	18" Stainless Water Connector	1
10755	24" Stainless Water Connector	12
10072	Washer For Water Connectors - Bulk	25

Flexible Gas Connector*

10232	24" x 1/2" OD Stainless Steel, Coated	25
-------	---------------------------------------	----

*Gas connectors are certified for household use to 1/2 PSI.

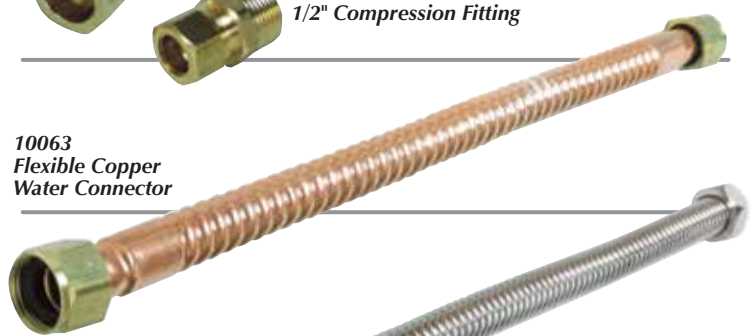

10063
Flexible Copper
Water Connector

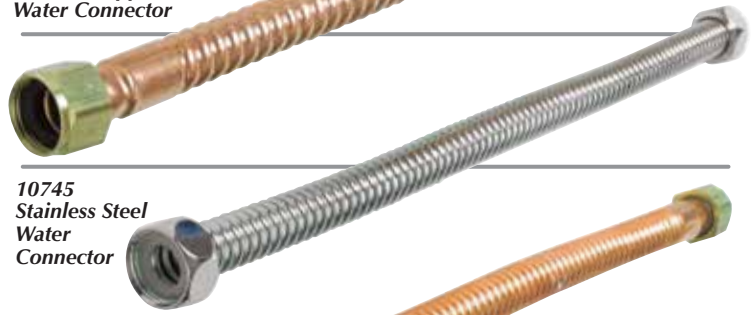

10745
Stainless Steel
Water
Connector

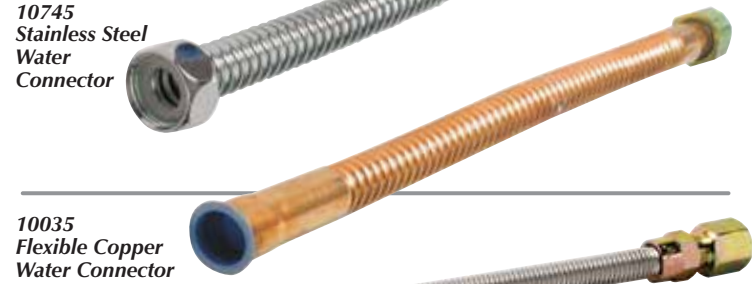

10035
Flexible Copper
Water Connector

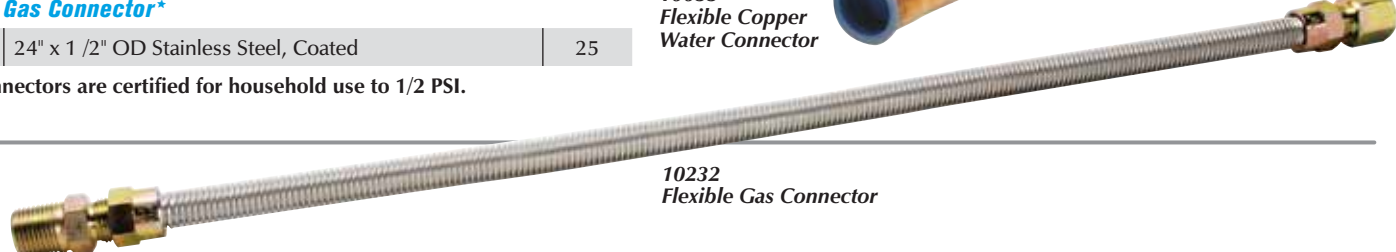

10232
Flexible Gas Connector

Water Heater Accessories

T & P Valves

• Setting: of 150 PSI / 210°F • Stainless steel spring • All brass body • ANS Z21.22 Design • AGA certified • Furnished with test lever • Epoxy coated extension probe

Stock #	Description	Qty
10421	1/2" Inlet/outlet T & P Valve w/4" Probe - Box	25
10423	1/2" Inlet/outlet T & P Valve w/4" Probe - Card	4
10463	3/4" Inlet/outlet T & P Valve w/1" Probe - Card	12
10471	3/4" Inlet/outlet T & P Valve w/4" Probe - Box	25
10473	3/4" Inlet/outlet T & P Valve w/4" Probe - Card	12
10491	3/4" Inlet/outlet Valve w/2-1/2" Shank - Box	25
10493	3/4" Inlet/outlet Valve w/2-1/2" Shank - Card	12

T & P Valve Remover

10552	Universal T & P Valve Remover - Card	1
-------	--------------------------------------	---

Heat Traps

• Prevents heat escape through the inlet and outlet while water heater is idle • 3/4" NPT x 3/4" NPT x 3" Length • Self-cleaning fittings prevent corrosion • Dielectric inert thermoplastic lining

Stock #	Description	Qty
01013	Dielectric Water Heater Heat Traps - 2/card	12
01022	Dielectric Water Heater Heat Traps - Bulk	24
01023	Dielectric Heat Trap- Flapper Style - 2/card	12

Dielectric Nipples

For water heater inlet and outlet hook-ups and other uses where dissimilar metals occur in piping and plumbing systems. Thermoplastic lining prevents corrosion. 3/4" NPT x 3/4" NPT x 2-1/2" Length

Stock #	Description	Qty
10622	Dielectric Nipples - 2.5" long - Bulk	50
10623	Dielectric Nipples - 2.5" long - 2/Card	12
10602	Dielectric Nipples - 3" long - Bulk	25

Element Wrenches

Zinc plated **Element Wrenches** fit all standard screw-in elements and 1-1/2" nuts. Works with your screwdriver. Goes into offsets where an adjustable wrench can't.

Stock #	Description	Qty
09882	5" Screw-In Element Wrench - Bulk	25
09883	5" Screw-In Element Wrench - Card	12
09942	4" Heavy Duty Element Wrench - Bulk	15
09943	4" Heavy Duty Element Wrench - Card	12

Chrome-plated **Element Socket** fits standard 1/2" socket drive to make easy work of replacing screw-in water heater elements.

Stock #	Description	Qty
09951	Professional Element Socket - Bulk	6
09953	Professional Element Socket - Clamshell	6

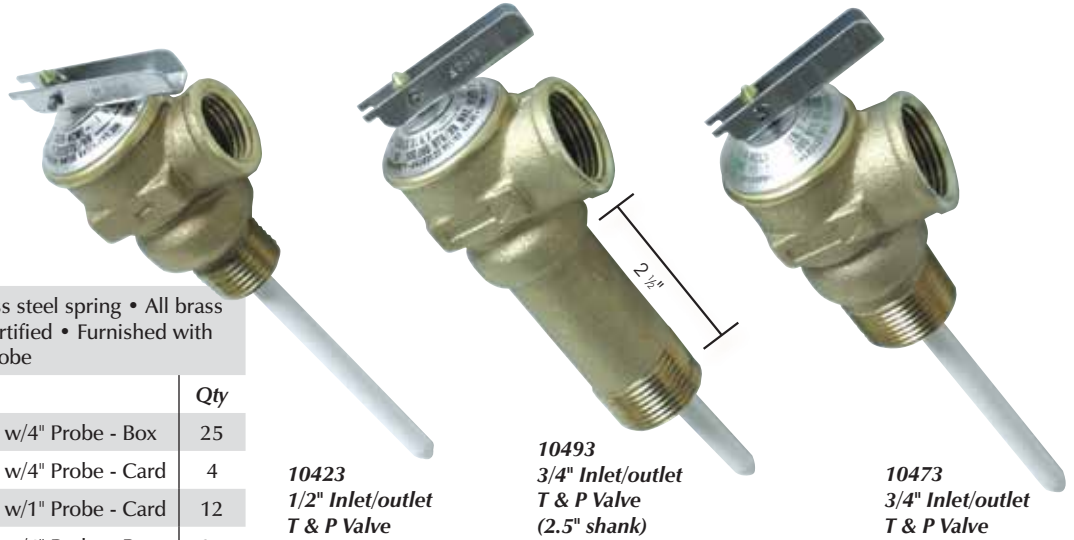

10423
1/2" Inlet/outlet
T & P Valve

10493
3/4" Inlet/outlet
T & P Valve
(2.5" shank)

10473
3/4" Inlet/outlet
T & P Valve

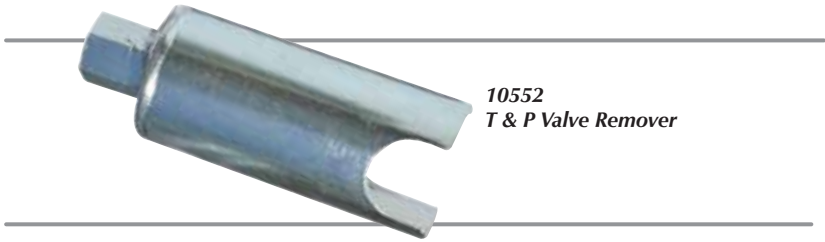

10552
T & P Valve Remover

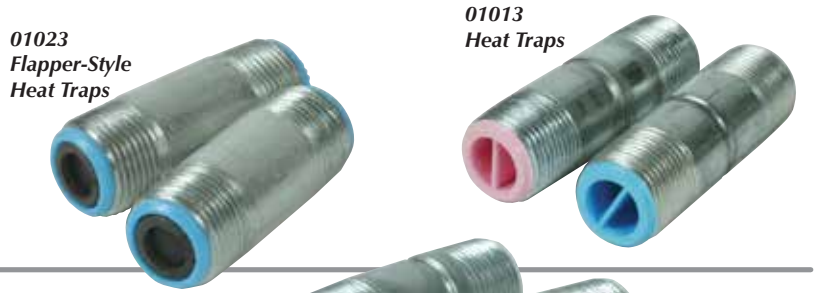

01023
Flapper-Style
Heat Traps

01013
Heat Traps

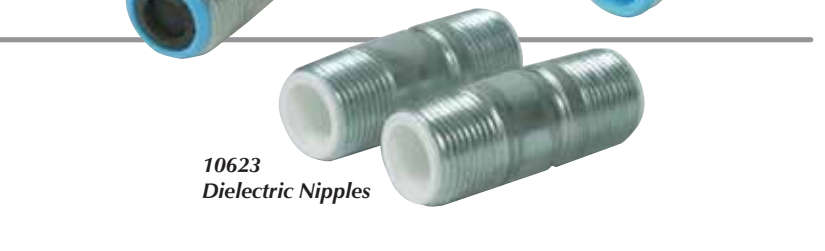

10623
Dielectric Nipples



09942
Element Wrench



09951
Professional
Element Socket

Anode Rods and Accessories



10962
Top Mount
Runoff Tube



10952
Center Top Mount
Runoff Tube



11162
Threaded
Dip Tube



10862
Side Mount
Runoff Tube



11062
Flared Dip Tube

Runoff Tubes

• Thermoplastic polypropylene runoff tubes present rigid surface for gripping with standard wrenches • Can be cut to length

Stock #	Description	Qty
10862	Side Mount Runoff Tube	12
10952	Center Top Mount Runoff Tube	12
10962	Top Mount Runoff Tube	12

Water Inlet Dip Tubes

Anti-siphon hole breaks damaging siphon action • Can be cut to length • Made of PEX • Gasket sold separately (#06912)

11062	Flared Dip Tube (52" vertical)	12
11061	Flared Dip Tube (52" vertical) with gasket	12
11162	Threaded Dip Tube (48" vertical)	25
06912	Dip Tube Gaskets - Bag of 25 (Special order only)	1

Residential Water Heater Anode Rods

11572	5/8" OD Anode Rod 42" Long Aluminum	6
11582	3/4" OD Anode Rod 42" Long Aluminum	6
11612	5/8" OD Anode Rod 42" Long Aluminum Flexible (3 Section)	6
11622	3/4" OD Anode Rod 42" Long Aluminum w/Dielectric Nipple	6

RV & Marine Water Heater Anode Rods (not shown)

11533	1/2" OD Anode Rod 4-1/2" long Magnesium with Drain - for Atwood water heaters	6
11553	1/2" OD Anode Rod 4-1/2" long Magnesium for Atwood water heaters (not shown)	6
11563	3/4" OD Anode Rod 9-1/2" long Aluminum for Suburban (Mor-Flo) water heaters (not shown)	6

Pipe Insulation Limited Quantities

3" wide R-5 fiberglass insulation and 1 roll vinyl outer wrap

12660	3' x 25' Fiberglass Pipe Insulation	24
-------	-------------------------------------	----

Dielectric Unions

Use wherever dissimilar metals occur in piping and plumbing systems. Use in water heaters, water storage tanks, water conditioners and water pumps. 3/4" FIP x 3/4" SWT

Stock #	Description	Qty
23503	Dielectric Union 3/4" FIP - Card 2/card	12

11622
3/4" Anode Rod
w/dielectric nipple



11572
5/8" Anode Rod



11612
Flexible
Anode
Rod

12660
Pipe Insulation
Limited quantities

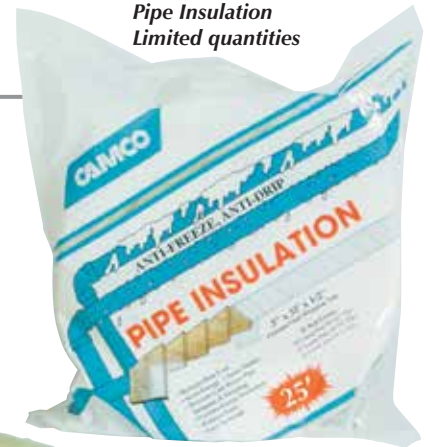

23503
Dielectric Union

Drain Valves and Contractor Hoses

Brass Water Heater Drain Valve w/Recirculation Elbow

Stock #	Description	Qty
11502	2010 Compliant Valve w/Recirculation Elbow - Bulk	25

Backflow Preventers with stainless steel spring

23303	1/2" Brass Backflow Preventer - Card	6
23402	3/4" Brass Backflow Preventer - Bulk	25

Brass Shut-Off Valves

Solid Brass housing with non-corrosive stainless steel quarter-turn pressure seated shut-off valves. Features easy-grip valve handles and hose connection. 2010 compliant.

20123	Brass Y-Valve	6
20173	Brass 45° Valve	6

Drain Valves

Permanent installation. Fits directly into water heater for easy draining. 3/4" NPT x 3/4" male hose thread. 2-1/2" long. Brass valves are 2010 Compliant.

11512	Water Heater Drain Valve- Brass - Bulk	25
11513	Water Heater Drain Valve- Brass - Card	12
11523	Water Heater Drain Valve- Plastic - Card	12

Water Pressure Regulators

Reduce water pressure to a safe, consistent 40–50 PSI of operational pressure. Protects equipment and prevents hose failure, helping to prolong equipment life. (3/4" M x F Garden Hose Threads) Patented. Brass regulator is 2010 Compliant.

40143	3/4" Plastic Water Pressure Regulator	6
40055	3/4" Brass Water Pressure Regulator	6



11502
Drain Valve with
Recirculation Elbow



23402
Backflow Preventer



20123
Brass Y-Valve



20173
Brass 45° Valve

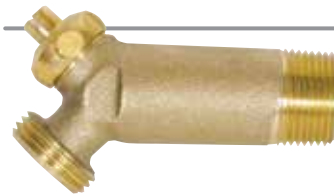

11513
Water Heater Drain Valve - Brass



11523
Water Heater Drain Valve - Plastic

40143 Plastic
Water Pressure
Regulator



40055 Brass
Water Pressure
Regulator

HEAVY DUTY CONTRACTOR HOSE

Heavy Duty 5/8 inch Contractor Hoses

Reinforced, abrasion resistant hose for hot water use. Easier to clean; drinking water safe. Spring reinforced to reduce kinking. Stainless steel fittings. 10-year limited replacement warranty. Available in 25 ft, 50 ft & 100 ft lengths.

Stock #	Description	Qty
22863	25 ft Contractor Hose	3
22873	50 ft Contractor Hose	3
22883	100 ft Contractor Hose	3

Drain Pans and Fittings

All pans on this page include
Dual-size 1" / 1.5" Drain Pan Fitting

Drain Pans and Fittings

Plastic—For electric water heaters ONLY • 2.63" high sides
• Durable no-break polypropylene pans will not rust, corrode or crack
• Pre-cut side opening for drain fitting • 1"/1.5" drain fitting included (#11452 or #11442)

Stock #	Description	Qty
11260	20" ID 2.63" Deep Plastic Drain Pan w/PVC Fitting	6
11266	20" ID 2.63" Deep Plastic Drain Pan w/CPVC Fitting	6
11460	22" ID 2.63" Deep Plastic Drain Pan w/PVC Fitting	6
11466	22" ID 2.63" Deep Plastic Drain Pan w/CPVC Fitting	6
11360	24" ID 2.63" Deep Plastic Drain Pan w/PVC Fitting	6
11366	24" ID 2.63" Deep Plastic Drain Pan w/CPVC Fitting	6
11400	26" ID 2.63" Deep Plastic Drain Pan w/PVC Fitting	6
11406	26" ID 2.63" Deep Plastic Drain Pan w/CPVC Fitting	6
11410	28" ID 2.63" Deep Plastic Drain Pan w/PVC Fitting	6
11416	28" ID 2.63" Deep Plastic Drain Pan w/CPVC Fitting	6
11420	30" ID 2.63" Deep Plastic Drain Pan w/PVC Fitting	6
11426	30" ID 2.63" Deep Plastic Drain Pan w/CPVC Fitting	6

Plastic Corner Pan—For electric water heaters ONLY • Will not rust, corrode or crack • 1"/1.5" drain fitting included (#11452 or #11442)

11480	24" ID 3" Deep Corner Plastic Drain Pan w/PVC Fitting	6
11486	24" ID 3" Deep Corner Plastic Drain Pan w/CPVC Fitting	6

Aluminum—For gas or electric water heaters • Will not rust, corrode or crack • 1"/1.5" drain fitting included (#11452 or #11442)
• Pre-cut side opening for drain fitting

20800	20" ID 2.25" Deep Aluminum Drain Pan w/PVC Fitting	6
20806	20" ID 2.25" Deep Aluminum Drain Pan w/CPVC Fitting	6
20840	22" ID 2.25" Deep Aluminum Drain Pan w/PVC Fitting	6
20846	22" ID 2.25" Deep Aluminum Drain Pan w/CPVC Fitting	6
20830	24" ID 2.25" Deep Aluminum Drain Pan w/PVC Fitting	6
20836	24" ID 2.25" Deep Aluminum Drain Pan w/CPVC Fitting	6
20833	24" ID 3" Deep Aluminum Drain Pan w/PVC Fitting	6
20810	26" ID 2.25" Deep Aluminum Drain Pan w/PVC Fitting	6
20816	26" ID 2.25" Deep Aluminum Drain Pan w/CPVC Fitting	6
20813	26" ID 3" Deep Aluminum Drain Pan w/PVC Fitting	6
20850	28" ID 2.25" Deep Aluminum Drain Pan w/PVC Fitting	6
20851	28" ID 2.25" Deep Aluminum Drain Pan w/CPVC Fitting	6
20860	30" ID 2.25" Deep Aluminum Drain Pan w/PVC Fitting	6
20866	30" ID 2.25" Deep Aluminum Drain Pan w/CPVC Fitting	6

Aluminum without drain hole—For gas or electric water heaters
• Will not rust, corrode or crack • 1"/1.5" drain fitting included (#11452)

20801	20" ID 2.25" Deep Aluminum Drain Pan w/PVC Fitting	6
20841	22" ID 2.25" Deep Aluminum Drain Pan w/PVC Fitting	6
20831	24" ID 2.25" Deep Aluminum Drain Pan w/PVC Fitting	6
20811	26" ID 2.25" Deep Aluminum Drain Pan w/PVC Fitting	6
20861	30" ID 2.25" Deep Aluminum Drain Pan w/PVC Fitting	6

Galvanized Square

For gas or electric heaters. 1"/1.5" drain fitting included

20922	24" x 24" x 4" Deep Heater Pan - Bulk	1
20932	30" x 30" x 6.25" Deep Heater Pan - Bulk	1

11360
Plastic Drain Pan



11480
Plastic Corner Drain Pan



20830
Aluminum Drain Pan



20922
Galvanized Square Pan



Drain Pan Fittings

Replacements for all Camco water heater and washing machine drain pans. Includes fitting, locknut and washer.

Stock #	Description	Qty
11442	Drain Pan Fitting Kit 1"/1.5" CPVC	25
11452	Drain Pan Fitting Kit 1"/1.5" PVC	25



Drain Pans and Fittings

Washing Machine Drain Pans

• White polypropylene plastic • Will not rust, corrode or crack • Includes 1"/1.5" PVC drain fitting (#11442) • Bottom or side outlet (not pre-cut) • 1"/1.5" drain can pass all codes • Easy to install • Matte finish • ID 27" x 30" x 2-1/8"

Stock #	Description	Qty
20752	30" x 32" OD Washing Machine Drain Pan - Bulk	6

Apartment-Sized Washing Machine Drain Pans

White polypropylene plastic washer drain pan designed and sized especially for apartment-sized washers. Will not rust, corrode or crack. Includes 1"/1.5" PVC drain fitting Bottom or side outlet (not pre-cut) • 1"/1.5" drain can pass all codes • Easy to install • Matte finish

20762	28" x 30" OD Washing Machine Drain Pan - Bulk	6
-------	---	---

Washing Machine Hoses

20500	5' Washing Machine Hose - Bag	12
20502	5' Washing Machine Hose - Bulk	25



20500
Washing Machine Hose

20752
Washing
Machine Pan



20762
Apartment-sized
Washing Machine Pan



Water Heater Drain Pans for Tankless Water Heaters

The Wall Saver™ allows for easier routine maintenance flushing and helps protect floors and walls from leaks, Made of injection-molded no-break polypropylene; will not rust, corrode or crack. Wall-mounted drain pan fits under most whole-house tankless water heaters and is required by building codes. Recyclable and non-toxic.

U.S. Patents 8104634 and D653745.

Each pan includes a dual-size 1-inch/1.5-inch drain fitting with gasket.

W: 21.5"; H: 16"; D: 13.4".



Drain Pans for Tankless Water Heaters

Stock #	Description	Qty
11470	Tankless Water Heater Drain Pan with PVC fitting	6
11476	Tankless Water Heater Drain Pan with CPVC fitting	6

Top Burners for Electric Ranges

UL listed

**GE / Hotpoint
Plug-in Style**



**Universal
Plug-in Style**



**GE/Hotpoint
with porcelain connector**



Delta Support



Y Support

Stock#	Description	Watts	Volts	Size	Turns	Support	Chromalox#	Qty.
GE/Hotpoint Plug-In								
00103	GE/Hotpoint Plug-in	1325w	240v	6"	5	Y	CH30x218	6
00113	GE/Hotpoint Plug-in	2350w	240v	8"	6	Y	CH30x219	6
GE/Hotpoint w/Porcelain Connector								
00183	GE/Hotpoint w/trim ring	1325w	240v	7"	5	GE	CH30x356	6
00193	GE/Hotpoint w/trim ring	2125w	240v	9"	6	GE	CH30x354	6
00283	GE/Hotpoint Plug-in w/o trim ring	1325w	240v	6"	5	GE	CH30x342	6
00293	GE/Hotpoint Plug-in w/o trim ring	2125w	240v	8"	6	GE	CH30x341	6
Economy Plug-In Universal								
00143	Universal Economy Plug-in	1250w	240v	6"	3	Y	SP12YA	6
00153	Universal Economy Plug-in	2100w	240v	8"	4	Y	SP21YA	6
00223	Universal Economy Plug-in	1250w	240v	6"	3	Delta	SP12MA	6
00233	Universal Economy Plug-in	2100w	240v	8"	4	Delta	SP21MA	6
Deluxe Plug-In Universal (Deluxe has more heating surface than Economy)								
00243	Universal Deluxe Plug-in	1500w	240v	6"	4	Y	MP15YA	6
00253	Universal Deluxe Plug-in	2100w	240v	8"	5	Y	MP21YA	6
00263	Universal Deluxe Plug-in	1500w	240v	6"	4	Delta	MP15MA	6
00273	Universal Deluxe Plug-in	2100w	240v	8"	5	Delta	MP21MA	6

Repair Parts

Stock#	Description	Qty.
00853	GE/Hotpoint Receptacle Block	6
Direct replacement for GE ranges. Includes: (1) metal/porcelain bracket, (2) machine screws, (1) sheet metal screw, (1) wire bracket and (1) nut		
00863	Universal Range Switch - Card	8
Includes: switch, mounting adapter parts, knob adapter		
00873	Universal Receptacle Block Kit	12
Fits most electric ranges except GE		

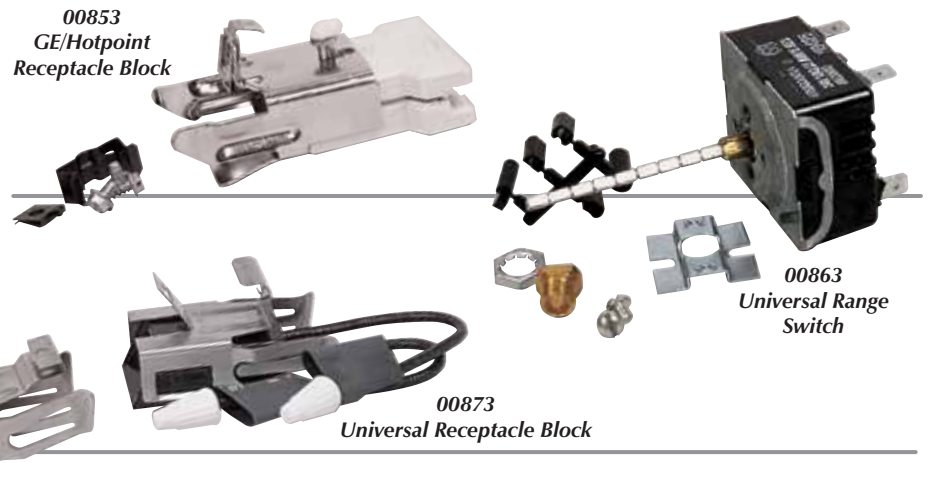

Stock items that end in 3 are packaged. To order items in bulk, change the last digit of the stock number to 2.

Pans, Bowls and Knob Kits



Bowl for plug-in elements
UNIVERSAL



Pan for hinged elements
EXCEPT GE / HOTPOINT —
UNIVERSAL



DEEP style bowl
for plug-in elements
GE / HOTPOINT TYPE



pan for hinged elements
GE / HOTPOINT TYPE

Universal Drip Pans and Bowls for Electric Ranges

Stock#	Description	Type	Qty.
00343	6" Chrome Trim Ring	-	12
00353	8" Chrome Trim Ring	-	12
00383	6" Chrome Drip Bowl	Plug-in	12
00393	8" Chrome Drip Bowl	Plug-in	12
00463	6" Chrome Drip Pan	Hinge	12
00473	8" Chrome Drip Pan	Hinge	12
00503	6" Black Porcelain Drip Bowl	Plug-in	12
00513	8" Black Porcelain Drip Bowl	Plug-in	12
00583	6" Black Porcelain Drip Pan	Hinge	12
00593	8" Black Porcelain Drip Pan	Hinge	12

Electric Knob Kit - 4/card

Stock#	Description	Qty.
00883	Electric Range Knobs-Top Burner - Black	12
00923	Electric Range Knobs-Top Burner - White	12
00903	Electric Range Knobs-Top Burner - Chrome	12

Electric Knob Kit - 1/card

00913	Electric Range Knob-Burner/Oven - Black	12
00893	Electric Range Knob-Burner/Oven - White	12
00933	Electric Range Knob-Burner/Oven - Chrome	12

Gas Knob Kit - 4/card

00943	Gas Range Knobs-Top Burner - Black	12
00983	Gas Range Knobs-Top Burner - White	12
00963	Gas Range Knobs-Top Burner - Chrome	12

Gas Knob Kit - 1/card

00973	Gas Range Knob-Burner/Oven - Black	12
00953	Gas Range Knob-Burner/Oven - White	12
00993	Gas Range Knob-Burner/Oven - Chrome	12

Drip Pans and Bowls for GE/Hotpoint Electric Ranges

Stock#	Description	Type	Qty.
00303	6" Chrome Trim Ring	-	12
00313	8" Chrome Trim Ring	-	12
00323	6" Black Porcelain Drip Bowl	Plug-in	12
00333	8" Black Porcelain Drip Bowl	Plug-in	12
00403	6" Chrome Drip Bowl	Plug-in	12
00413	8" Chrome Drip Bowl	Plug-in	12
00423	6" Chrome Drip Pan	Hinge	12
00433	8" Chrome Drip Pan	Hinge	12
00443	6" Blk Porcelain Drip Bowl 1990 - Present	Plug-in	12
00453	8" Blk Porcelain Drip Bowl 1990 - Present	Plug-in	12
00483	6" Chrome Drip Bowl 1990 - Present	Plug-in	12
00493	8" Chrome Drip Bowl 1990 - Present	Plug-in	12
00543	6" Black Porcelain Drip Pan	Hinge	12
00553	8" Black Porcelain Drip Pan	Hinge	12



Reflector Drip Pans for Gas Ranges

Stock#	Description	Type	Qty.
00363	Round Chrome Gas Drip Pan (7")	-	12
00373	Square Chrome Gas Drip Pan (7-3/4")	-	12



00933
Electric Range Knob



00973
Gas Range Knob

- Stock items that end in 3 are packaged with a hang card.
- For bulk items, change the last digit of the stock number to 2.
- Minimum order quantity for bulk rings, pans and bowls is 25.

Bake & Broil Elements

Stock#	Description	Watts	Volts	Qty.
Bake Elements				
00611	Bake Element	2400w	240v	6
00621	Bake Element	3000w	250v	6
00631	Bake Element	2700w	240v	6
00641	Bake Element	2500w	240v	6
00651	Bake Element	3000w	250v	6
00681	Bake Element	2585w	250v	6
00701	Bake Element	2600w	240v	6
00711	Bake Element	2585w	250v	6
00721	Bake Element	2475w	250v	6
00731	Bake Element	2200w	250v	6
00741	Bake Element	2585w	250v	6
00751	Bake Element	3100w	240v	6
00761	Bake Element	2400w	240v	6
00791	Bake Element	2500w	240v	6

Broil Elements

00771	Broil Element	3000w	250v	6
00801	Broil Element	3400w	250v	6
00811	Broil Element	3400w	240v	6
00831	Broil Element	3410w	250v	6

All elements include screw-in hardware.

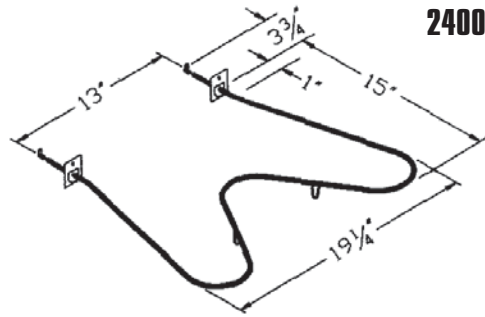

00611
2400w 240v Bake Element

KENMORE
1312853
1311298-0
WHIRLPOOL
865940
CHROMALOX
CH775

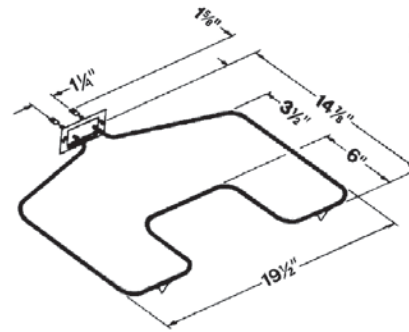

00621
3000w 250v Bake Element

GE
WB44x126
WB44x118
WB44x105
WB44x133
WB44x120
WB44x112
HOTPOINT
297B774G3
CHROMALOX
CH44x126

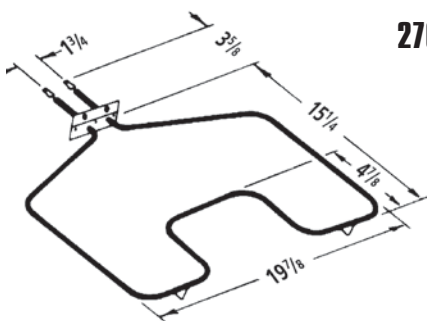

00631
2700w 240v Bake Element

KENMORE
296119
296565
301444
321667
CHROMALOX
CH2858

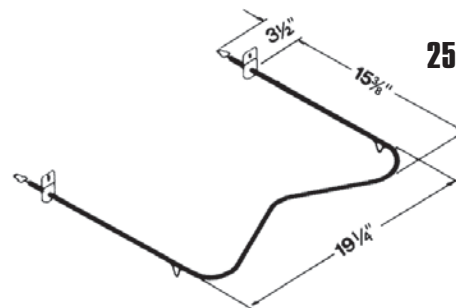

00641
2500w 240v Bake Element

KENMORE
282717
314620
319837
320421
301471
319529
319238
324186
320420
CHROMALOX
CH776

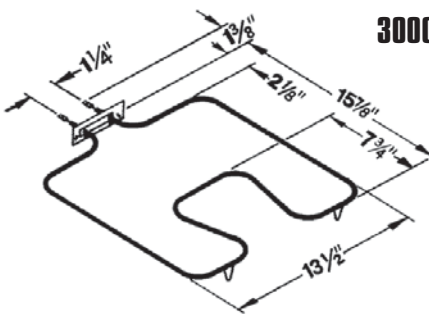

00651
3000w 250v Bake Element

GE
WB44x5043
WB44x5049
WB44x5078
WB44x5080
HOTPOINT
663130
664640
684729
CHROMALOX
CH44x5043

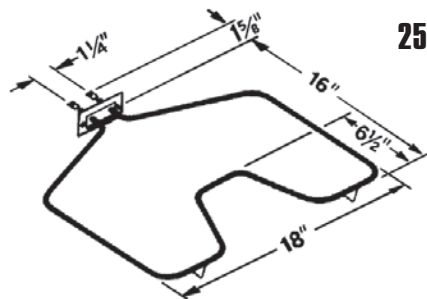

00681
2585w 250v Bake Element

GE
WB44x105
WB44x118
WB44x120
WB44x126
WB44x133
WB44x5061
WB44x5099
CHROMALOX
CH44x5099

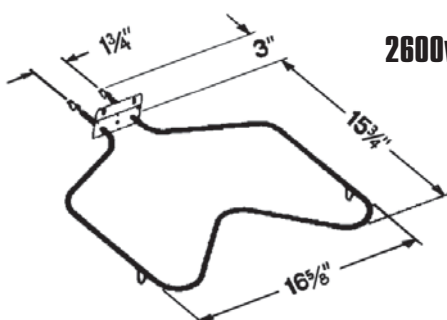

00701
2600w 240v Bake Element

WHIRLPOOL
308180
JENN-AIRE
202550
CHROMALOX
CH4836

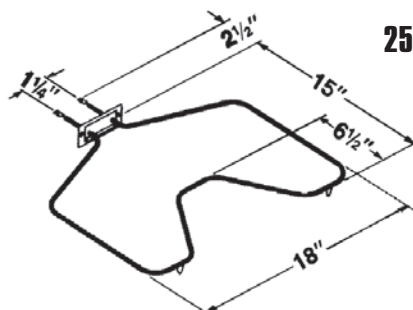

00711
2585w 250v Bake Element

GE
WB44x5061
WB44x5082
WB44x5072
CHROMALOX
CH44x5082

Bake & Broil Elements

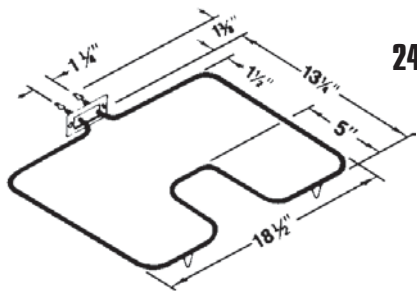

00721
2475w 250v Bake Element

FRIDGIDAIRE
632305 632306
633114 1133051
752576 7525781
7526491 7526492
752660 7532556
7532557 8004204
9950882

CHROMALOX
CH978

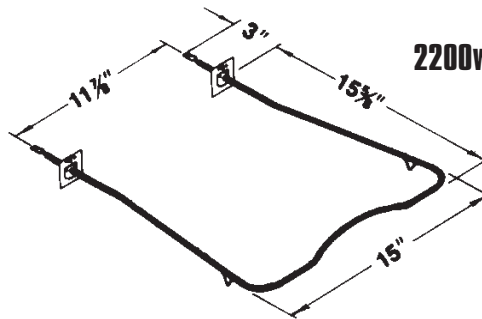

00731
2200w 250v Bake Element

WHIRLPOOL
255103; 257376;
257987; 326791

ROPER
326791

CHROMALOX
CH687

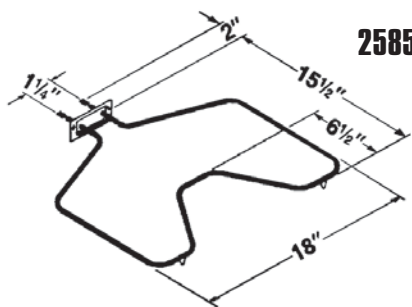

00741
2585w 250v Bake Element

GE
WB44x5083
WB44x5085

CHROMALOX
CH44x5083

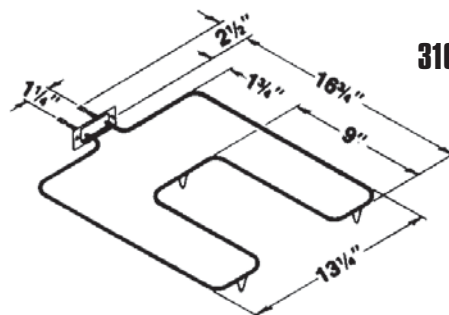

00751
3100w 240v Bake Element

GE
WB44x200;
WB44x160

CHROMALOX
CH44X200

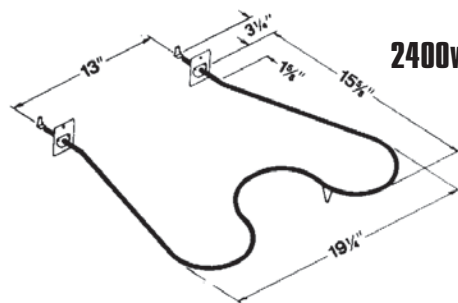

00761
2400w 240v Bake Element

FRIDGIDAIRE
8008245

KENMORE/KELVINATOR
1313171; 1313169

WHIRLPOOL
866375

CHROMALOX
CH4879

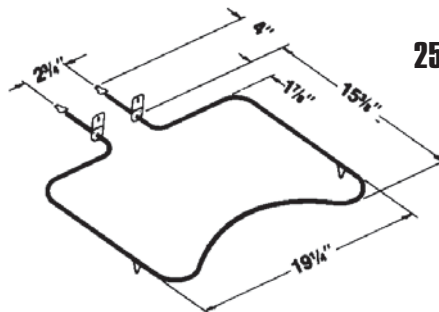

00791
2500w 240v Bake Element

ROPER/KENMORE
325883;
326365;
326364;
326366

GE
WB44x230

CHROMALOX
CH5853

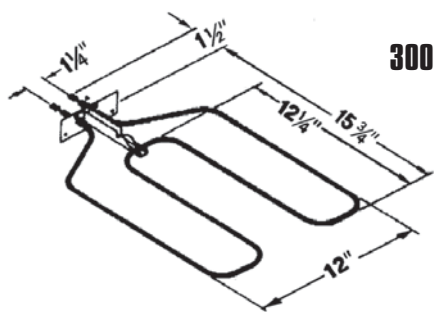

00771
3000w 250v Broil Element

GE
WB44x134

CHROMALOX
CH44x134

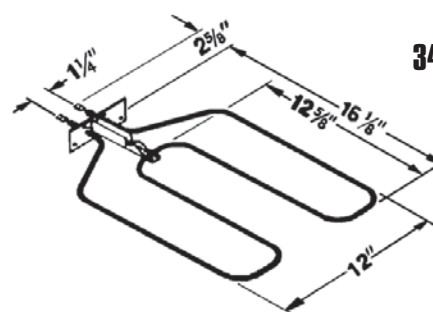

00801
3400w 250v Broil Element

GE
WB44x149
WB44x150
WB44x167
WB44x168
WB44x173
WB44x185
WB44x5064

CHROMALOX
CH44x185

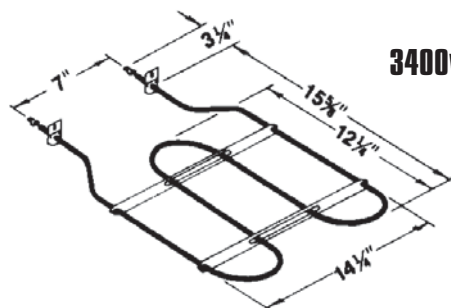

00811
3400w 240v Broil Element

ROPER/KENMORE
296121; 296566;
319487; 324163;
324249; 324251

CHROMALOX
CH2859

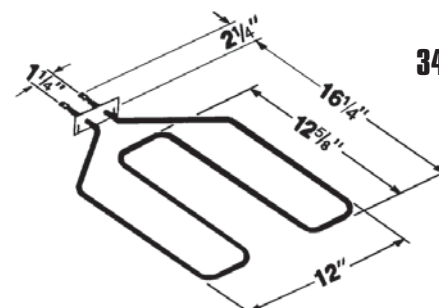

00831
3410w 250v Broil Element

GE
WB44x5074

CHROMALOX
CH44x5074

Windshield Washer Fluid

Xtreme Blue™ Windshield Washer Concentrate

Concentrated formula is better for the environment; takes less water and plastic to produce. Concentrated product must be diluted to comply with CARB (CA) regulations (Dilution chart is on product label).

Stock#	Description	Size	Qty.
30254	Windshield Washer Concentrate	16 oz	24
30256	Windshield Washer Concentrate	32 oz	6

Xtreme Blue™ Windshield Washer Fluid

Ready to use: no mixing required. Easily removes road grime, film and bugs. Excellent for all season use. Aids in melting frost, snow and ice.

Stock#	Description	Size	Qty.
30907	-20° Xtreme Blue™	1 gallon	6
30917	-25° Xtreme Blue™	1 gallon	6
30987	0° Xtreme Blue™	1 gallon	6
30977	+20° Xtreme Blue™	1 gallon	6

Ice Cutter -30 Windshield Washer Fluid

Melts frost and light ice on contact. No mixing required; excellent for all-season use. Easily removes road grime, film and bugs. Protect to -30° F.

Stock#	Description	Size	Qty.
30522	Ice Cutter™ Spray	32 oz	6
30527	-30° Ice Cutter™ Washer Fluid	1 gallon	6

Rain Cutter™ Windshield Washer Fluid

Our exclusive formula sheds rain faster than the national brand. Premium product cuts road grime fast for cleaner windshields. Available with freeze protection down to -25° F. High-visibility colors for greater consumer recognition in store displays.

Stock#	Description	Size	Qty.
31177	-25° Rain Cutter Washer Fluid	1 gallon	6
31178	-25° Rain Cutter Washer Fluid	55 gallon	1
41782	-25° Rain Cutter Spray Glass Cleaner & Rain Repellent	32 oz	4
32037	0° Rain Cutter Washer Fluid	1 gallon	6
31187	32° Rain Cutter Washer Fluid	1 gallon	6



30254
Windshield Washer
Concentrate



30256
Windshield Washer
Concentrate

30907
-20° F



Xtreme Blue
Windshield
Washer Fluid

30977
+20° F



30527
Ice Cutter



30522
Ice Cutter
Spray

31177
-25° F



Rain Cutter
Windshield Washer Fluid



41782
-25° F Spray

31187
+32° F



Antifreeze for potable water systems



Antifreeze for potable water systems

For use in winterization of fresh/potable water systems in campers, RVs and summer homes. High-grade formulas provide complete freeze protection down to -50° F. (-46 °C) with no mixing required. Use full strength—do not dilute. All ingredients are listed in the U.S. Federal Register (GRAS - generally regarded as safe). Not recommended for winterizing boat engines.

Easy Going™ -50

Virgin propylene glycol-based formula is safe, odorless and tasteless.

Stock#	Description	Size	Qty.
30757	Easy Going -50 Antifreeze	1 gallon	6
30759	Easy Going -50 Antifreeze	5 gallons	1
30758	Easy Going -50 Antifreeze	55 gallons	1

Arctic Ban™ -50

Ethyl alcohol/propylene glycol-based formula is safe, odorless and non-staining.

Stock#	Description	Size	Qty.
30807	Arctic Ban -50 Antifreeze	1 gallon	6
30809	Arctic Ban -50 Antifreeze	5 gallons	1
30808	Arctic Ban -50 Antifreeze	55 gallons	1

Trusted for 40 Years.

Protect your investment during cold winter months. Camco's Fresh Water Antifreeze has been tried and tested, offering premium protection from freeze damage. Safe for potable water systems.

100% Environmentally friendly
100% Biodegradable



CAMCO

Antifreeze & Accessories

Boiler Antifreeze

- For hydronic heating and cooling systems • Safe • Odorless • Tasteless
 - Protects to 100° below zero F (-73°C). A premium heat transfer fluid with special corrosion inhibitors added. For use in hot water and other closed boiler and solar systems. Concentrated, may be diluted to the desired burst protection level and flow temperature desired using the chart provided. Contains Propylene Glycol with corrosion inhibitor and inert ingredients. Non-Flammable
 - No mixing required. Boiling point: 1000mm ... 116°C ... 240°F
 - All ingredients are listed in the U.S. Federal Register (GRAS).*
- * Generally regarded as safe

Stock#	Description	Size	Qty.
30027	Boiler Antifreeze -100	1 gallon	6
30029	Boiler Antifreeze -100	5 gallons	1
30028	Boiler Antifreeze -100	55 gallons	1

Ready-to-Use Boiler Antifreeze

- All ingredients are listed in the U.S. Federal Register (GRAS).*
- * Generally regarded as safe

Stock#	Description	Size	Qty.
33129	Ready-To-Use (RTU) Boiler Antifreeze	5 gallons	1
33128	Ready-To-Use (RTU) Boiler Antifreeze	55 gallons	1

Boiler AL Antifreeze

Boiler AL (not shown) contains special corrosion inhibitors for use in boilers containing Aluminum.

Stock#	Description	Size	Qty.
33119	Boiler AL -100	5 gallons	1
33118	Boiler AL -100	55 gallons	1

Hydro-flo -100 Heat Transfer Fluid

Designed for Hydronic Heating, Geothermal and Solar Systems with special corrosion inhibitors added. All ingredients are generally recognized as safe as food additives by the FDA under Part 182 of the Food Additive Regulations, making HydroFLO an excellent choice for applications where there is a possibility of contact with potable water supplies.

Stock#	Description	Size	Qty.
30037	Hydro-Flo Heat Transfer Fluid	1 gallon	6
30039	Hydro-Flo Heat Transfer Fluid	5 gallons	1
30038	Hydro-Flo Heat Transfer Fluid	55 gallons	1

Inhibitor Re-Charge for Boiler Antifreeze

Replaces depleted corrosion inhibitors in antifreeze solutions to prevent corrosion problems. Can also be added to uninhibited antifreeze solutions. **Not for use with Boiler AL.**

35106	Inhibitor Re-Charge	32 oz.	6
-------	---------------------	--------	---

Boiler Antifreeze Test Strips

These strips test the pH of the solution to indicate the corrosion protection.

36011	Boiler Antifreeze Test Strips	50 strips	1
-------	-------------------------------	-----------	---

FreezeCheck Refractometer

Eliminates guesswork by reading freeze protection of ethylene glycol, methoxy propanol and propylene glycol, as well as actual burst protection of propylene glycol antifreezes. Rapid temperature compensation for accuracy in varying temperatures. Shock resistant design. Improved optics for ease of viewing. Completely immersible.

Stock#	Description	Size	Qty.
65401	Freeze-Check Refractometer	-	1

30029
Boiler Antifreeze



30027
Boiler Antifreeze



30037
Hydro-Flo Heat Transfer Fluid

35106
Inhibitor Re-Charge



36011
Antifreeze Test Strips



65401
Refractometer

Blast-Out™ Cleaners

Helps Prevent
BACK UPS!
Environmentally Safe



Plumbing
Blast-Out

Compare
to **RID-X®***

Plumbing Blast-Out™ Septic Tank Treatment

Compare to RID-X®* Septic treatment and pipe cleaner helps prevent back ups and is environmentally safe. Powerful all-natural enzyme formulation is safe for all septic systems. Use monthly to help prevent costly repairs. 32 oz contains four treatments; 64 oz contains eight treatments. • Breaks down paper, grease, protein & starches • Cleans septic system from toilet to drain field • Helps stop odors • Safe for septic tank and pipes.

* This product is not manufactured or distributed by Reckitt & Benckiser, owner of the registered trademark Rid-X®

Stock#	Description	Size	Qty.
41702	Blast-Out Septic Tank Treatment	32 oz	4
41706	Blast-Out Septic Tank Treatment	64 oz	4

* This product is not manufactured or distributed by Reckitt & Benckiser, owner of the registered trademark Rid-X®

Blast-Out
Pressure Wash Concentrate

Blast-Out™ Pressure Washer Concentrate Cleaners

Powerful pressure-washer cleaners with customized formulas for all your outdoor cleaning needs. Removes dirt, oil, grease and mildew stains. Use with a pressure washer, or clean manually with a cloth, sponge or soft brush. Phosphate free; contains no bleach or ammonia.

- Fast acting cleaners: just spray on and wash off
- Safe for use around plants and pets

Stock#	Description	Qty.
41807	Multi-Purpose Concentrate	4
41817	Deck & Fencing Concentrate	4
41827	Concrete & Driveway Concentrate	4
41837	House & Siding Concentrate	4
41847	Outdoor Furniture Concentrate	4
41867	Boat/RV Wash Concentrate	4



Blast-Out™ Degreaser

Fast acting formula dissolves grease on contact. Super concentrated cleaner safely removes grease, oil and dirt from driveways, garage floors, tires, engines, grills and more. Phosphate free, and safe for plants and pets; contains no bleach or ammonia. Easy to use: just spray on and wash off.

Stock#	Description	Size	Qty.
41892	Blast-Out Degreaser	32 oz	4
41897	Blast-Out Degreaser	gallon	4

Blast-Out
Concentrated Cleaner



Campfire, Gas Matches & Sparkers

58031
Little Red Campfire

Little Red Campfire™

Take your fire with you! Our compact, portable campfire is great for tailgating, or put it on the patio...its size is convenient for wherever you need a fire. Realistic log pieces and full 9.5" diameter ring burner help create the natural look and ambiance of from-scratch campfires. Sturdy lid and security latches make it safe and easy to transport. Includes 8' propane hose for use with standard LP gas cylinders. RV campground approved. 11.25" fire tray diameter. 65,000 BTU/HR

Stock #	Description	Qty
58031	Little Red Campfire™	1
58032	Replacement Log set	1
58034	Replacement Hose w/Regulator	1
59213	Propane Adapter (for use with 1-lb bottle)	6



59213
Propane
Adapter

GM3 GasMatches™

One of our finest and most popular lighters. Long slender design lets you get at hard-to-reach places with total safety. Features a continuous ignition system (requires one AA battery, included), safety lock, fully adjustable flame, fuel viewing window. Refillable with butane lighter fluid. ISO 9001 certified. CPSC certified.

57433	GM3 - 14 3/4"	12
57543	GM3X - 26" (15" flex extender)	12
57684	GM3XE - 40 3/4" (36" flex extender)	20



57433
GM3 GasMatch



57543
GM3X GasMatch

GM4 GasMatches™

Our most popular mid-sized model. Piezo electric ignition, fully adjustable flame, safety lock, fuel viewing window, thousands of lights. CPSC certified. Refillable with butane lighter fluid. 11" long.

57453	Olympian™ GM4 GasMatch	12
-------	------------------------	----



57453
GM4
GasMatch

CAMLighter Elite™ Butane Lighter and Bottle Opener

Open a bottle and light your grill or heater with one handy and attractive tool. Matte aluminum finish with black accents. Textured back for a sure grip. Adjustable flame; refillable. CPSC certified.

58023	CAMLighter Elite	12
-------	------------------	----



58023
CAMLighter
Elite

57473
GM9
GasMatches

GM9 2-pack Refillable GasMatches

Great for barbecues, fireplaces, pilot lights, kerosene heaters and candles. Safety lock, CPSC certified, adjustable flame, fuel viewing window. 11" long.

57473	Olympian™ GM9 GasMatches-2/card	12
-------	---------------------------------	----

Ronson® Butane

Multi-fill injectors in 78 gram and 165 gram sizes.

57416	Ronson 78 Gram Butane Fuel	12
57496	Ronson 165 Gram Butane Fuel	12

57533
GM12 Multi-Sparker



57416, 57496
Ronson Butane

GM12 Continuous Ignition Multi-Sparker

This handy igniter is the one designed exclusively for igniting gas appliances. No butane to refill. The continuous ignition piezo electric sparker assures a large and immediate continuous spark. The automatic illumination micro-light and curved nozzle make tough lighting jobs easy. Uses one C battery (included).

57533	GM12 - 13" long (7" pipe)	12
57561	GM12X - 26" long (20" pipe)	24
57591	GM12XE - 31" long (25" pipe)	24

57561
GM12X Multi-Sparker



57591
GM12XE Multi-Sparker

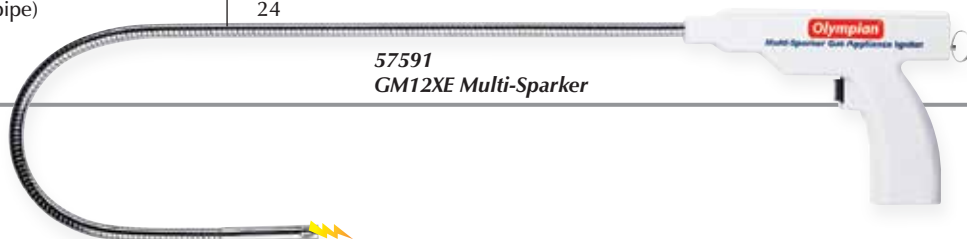

61605 Range Accessory Display



Stock #	Description	Qty	Stock #	Description	Qty
00103	GE/HP 6"x 5 Turn Plug-In Y Support	2	00463	Drip Pan Universal 6" Chrome Electric	4
00113	GE/HP 8"x 6 Turn Plug-In Y Support	2	00473	Drip Pan Universal 8" Chrome Electric	4
00143	Economy 6" x 3 Turn-Y Support	2	00503	Universal 6" Plug-In Reflect Bowl-Black Porc.	2
00153	Economy 8" x 4 Turn-Y Support	2	00513	Universal 8" Plug-In Reflect Bowl-Black Porc.	2
00243	Deluxe 6" Plug-In Y Support	2	00543	Drip Pan GE/HP 6" Black Porcelain Electric	2
00253	Deluxe 8" Plug-In Y Support	2	00553	Drip Pan GE/HP 8" Black Porcelain Electric	2
00263	Universal 6"x4 Trn Delta Supt 1500W 240V DLX Plug In	2	00863	Universal Range Switch	2
00273	Universal 8"x5 Trn Delta Supt 2100W 240V DLX Plug In	2	00873	Universal Receptacle Block Kit	2
00383	Universal 6" Plug-In Reflect Bowl	6	00883	Electric Range Top Burner Knob - Black -	2
00393	Universal 8" Plug-In Reflect Bowl	6	00903	Electric Range Knob Kit Top/Burner - Chrome -	2
00403	6" Drip Bowl GE/Hotpoint	4	00913	Electric Range Knob Kit Top/Oven - Black -	2
00413	8" Drip Bowl GE/Hotpoint	4	00933	Electric Range Knob Kit Top/Oven - Chrome -	2
00423	GE/HP 6" Hinged Reflect Pan	4	00943	Gas Range Top Burn Knob Kit - Black -	2
00433	GE/HP 8" Hinged Reflect Pan	4	00973	Gas Range Knob Kit Top/Oven - Black -	2

All displays can be customized to meet our customers' specific needs.

61585 Water Heater Repair Display

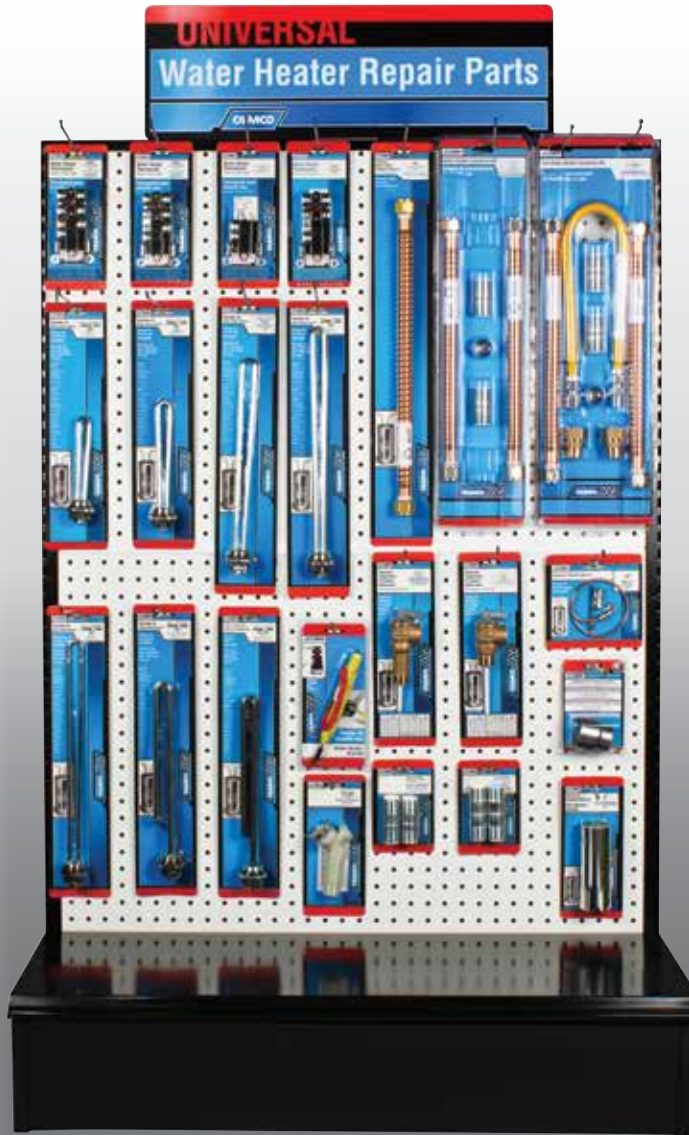

Stock #	Description	Qty	Stock #	Description	Qty
02143	1500w 120v Screw-In Element	4	09883	5" Screw-In Element Wrench	2
02203	2000w 120v Screw-In Element	2	09953	Professional Element Socket	4
02283	3800w 240v Screw-In Element	2	09973	Element Quick Change Tool	4
02343	4500w 240v Screw-In Element	4	10023	Water Heater Continuity Tester	2
02583	4500w 240v LWD/FB Screw-In Element	4	10063	18" Flex Water Connector	2
02923	4500w 240v Screw-In Lime Life Fold Back	4	10183	15" Water Heater Connector Kit -Gas	1
07223	Universal Adapter Kit	2	10193	15" Water Heater Connector Kit -Electric	1
08123	Therm-O-Disc Lower Thermostat	2	10473	3/4" T&P Valve 4" Coated	2
08143	Therm-O-Disc Single Element Thermostat	2	10623	Dielectric Nipples	2
08163	Therm-O-Disc Upper Thermostat	4	11523	Water Heater Drain Valve	2

All displays can be customized to meet our customers' specific needs.

61675 Water Heater Display (Apcom Thermostats)



Stock #	Description	Qty	Stock #	Description	Qty
02143	1500w 120v Screw-In Element	2	07843	Apcom Single Element Thermostat	2
02293	3800w 240v Screw-In Element	2	07863	Apcom Upper Thermostat	6
02343	4500w 240v Screw-In Element	4	09943	4" Heavy Duty Element Wrench	2
02583	4500w 240v LWD/FB Screw-In Element	2	09953	Professional Element Socket	4
02923	4500w 240v Screw-In Lime Life Fold Back	2	10623	Dielectric Nipples 3/4", 2/card	4
07023	Plumber's Pack Apcom Style	4	10023	Water Heater Continuity Tester	2
07723	Apcom Lower Thermostat	2			

Also available with Therm-O-Disc thermostats

All displays can be customized to meet our customers' specific needs.

61595 Water Heater Display (Therm-O-Disc Thermostats)



Stock #	Description	Qty	Stock #	Description	Qty
02143	1500w 120v Screw-In Element	2	08143	Single Element Therm-O-Disc Thermostat	2
02203	2000w 120v Screw-In Element	2	08163	Upper Therm-O-Disc Thermostat	4
02293	3800w 240v Screw-In Element	2	09883	5" Screw-In Element Wrench	2
02343	4500w 240v Screw-In Element	6	09953	Professional Element Socket	2
02583	4500w 240v LWD/FB Screw-In Element	4	09973	Quick Change Element Tool	2
02923	4500w 240v Screw-In Lime Life Fold Back	2	10023	Water Heater Continuity Tester	2
04603	4500w 240v Universal Element	2	10473	3/4" T&P Valve 4" Coated	2
07223	Universal Adapter Kit	2	10623	Dielectric Nipples	2
08123	Lower Therm-O-Disc Thermostat	2	11523	Water Heater Drain Valve	2

Also available with Apcom thermostats

All displays can be customized to meet our customers' specific needs.

BLAST-OUT™

Septic Tank Treatment

Compare
to RID-X®*

Helps Prevent
BACK UPS!
Environmentally Safe

Plumbing
**Blast
out™**



PREMIUM

Windshield Washer Fluid
Products

CAMICO



BLAST-OUT™

Degreaser

**Blast
out™**
Concentrated Cleaner





MARINE

ACCESSORIES



Featured products:



Boat Stands



Premium Boat Stand Tops



Wheel Chocks



Stabilization

POWERBOAT STAND BASES

Stackable feature helps save space when not being used. Color coded stickers help match with corresponding size swivel top.



BOAT STANDS

Strictly for stabilization, boat stands are to be placed after the boat's entire weight is supported by keel blocking. The boat should be blocked on stable land and then stands placed down the length of the boat.

It is recommended that two stands be placed horizontally across from each other on the port and starboard sides in the aft position and two horizontally placed forward. A minimum of 4 stands is recommended in addition to a vee-top stand under the bow for sailboats. Stands should be placed no less than every 8' of boat length; on both the port and starboard sides.

Camco boat stand bases are powder coated and constructed of solid, cold-rolled, steel tubing.

Camco stands have been independently 3rd-party tested to withstand weight loads of more than 30,000 lb.



40824 18"-25"



40823 25"-38"



40822 28"-46"



40821 33"-50"



40820 41"-58"

DETERMINING WHICH SIZE BOAT STAND BASE TO USE:

Camco sail and power boat stands are available in a range of sizes with minimum and maximum heights. The minimum stand height is the height from the ground to the topside of the plywood top when the steel threaded rod is rotated all the way into the stand with no threads showing.

The maximum height is from the ground to the topside of the plywood top when the steel rod is completely extended out of the base.

Best practice is to keep a minimum amount of threaded rod exposed and to keep the boat as low to the ground as possible depending on the depth of the keel.

A method commonly used to find the appropriate boat stand size is to subtract 6" from the boat's draft and the height of the blocking pile.

SAILBOAT STAND BASES

Nestable feature helps save space when not being used. Color coded stickers help match with corresponding size swivel top.



40830 79"-96"



40831 64"-81"



40832 48"-65"



40833 35"-52"



40834 23"-37"

Camco's Boat Stand Tops have threaded, zinc-plated steel rods that are hollow and cold-rolled rather than cut, offering a lightweight design without sacrificing weight-load capacity.



A1



A2



A3



A4

NEW

A. Boat Stand Tops

Our Vee Tops are designed specifically for front hull support on sailboats and some larger deep keel powerboats.

The Standard Swivel Top's thick plywood head is dip-painted and provides better rot resistance and cushion. Standard Swivel Tops and Premium Swivel Top Replacement Pad also feature counterbore screws which help prevent the chance of a screw coming in contact with the hull.

Premium Swivel Tops are made of high-density polyethylene with a non-marring TPE top to help protect hull.

A1 Vee Tops

40850 27.5" - Fits # 40820-40822 and 40830-40833

40851 22.5" - Fits # 40823 and 40834

40852 14.5" - Fits # 40824

A2 Standard Swivel Tops

40840 Yellow, 27.5"- Fits # 40820-40822 and 40830-40833

40841 Green, 22.5"- Fits # 40823 and 40834

40842 Burgundy, 14.5" - Fits # 40824

A3 Standard Swivel Top Replacement Heads

40845 Yellow, for use with 40840

40846 Green, for use with 40841

40847 Burgundy, for use with 40842

A4 Premium Swivel Tops

Patented

40861 14.5"

40862 22.5"

40863 27.5"

40860 Boat Stand Top, Pad Only

PREMIUM

BOAT STAND SWIVEL TOPS

NON-MARRING TOP INSERT

Made of Thermoplastic Elastomer (TPE Rubber) which helps protect hull.

CHANNELED SURFACE DESIGN

Helps facilitate rainwater removal.

ULTRA-STURDY HEXAGONAL PATTERN

Strong AND lightweight.

HIGH-DENSITY POLYETHYLENE

(HDPE) plastic tops last longer than standard wooden swivel tops.



ALL of Camco's Boat Stand Tops

feature threaded, zinc-plated steel rods that are hollow and cold-rolled rather than cut, offering a lightweight design without sacrificing weight-load capacity.

ADDITIONAL FEATURES:

Universal design—works with Camco's as well as other brands of boat stands

Rounded brackets help prevent cuts and scrapes

UV Stabilized for long life

Stainless hardware

Patented

Part #	PREMIUM SWIVEL TOP
40861	Assembly, 14.5-inch
40862	Assembly, 22.5-inch
40863	Assembly, 27.5-inch
40860	Replacement Pad Only

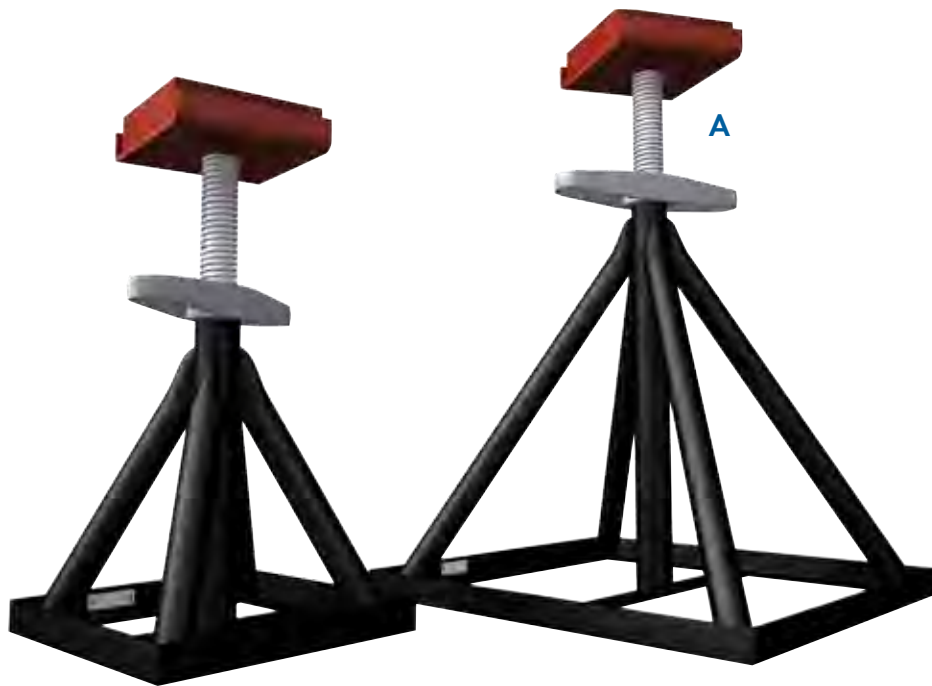

A. Keel Stand Bases & Top Use Camco keel stands instead of conventional wood blocking. Use one keel stand for each 10,000 pounds of boat weight. A minimum of two keel stands is recommended.

- 40800** Keel Stand Base 15"-23"
- 40801** Keel Stand Base 23"-30"
- 40802** Keel Stand Top 14"

B. Stabilizer Boat Stand Pads

Keep stands from sinking into soft ground, gravel or dirt. They interlock for convenient storage and have a built-in handle for ease of use. Constructed of durable polypropylene with UV inhibitors and an eggcrate design which allows water drainage.

- 44595** small 6.2" x 6.2" pad, 4/pack
- 44541** large 14.0" x 11.7" pad, 2 pack

C. Boat Stand Safety Chains

Help prevent boat stands from sliding up the boat's hull. This 3/16" zinc plated chain is placed in the safety chain notch of a sail boat stand and then passed under the keel to attach snugly to the opposite-side boat stand.

- 40810** 3/16" x 12' (3-pack)
- 40811** 3/16" x 10' (3-pack)
- 40812** 3/16" x 8' (3-pack)

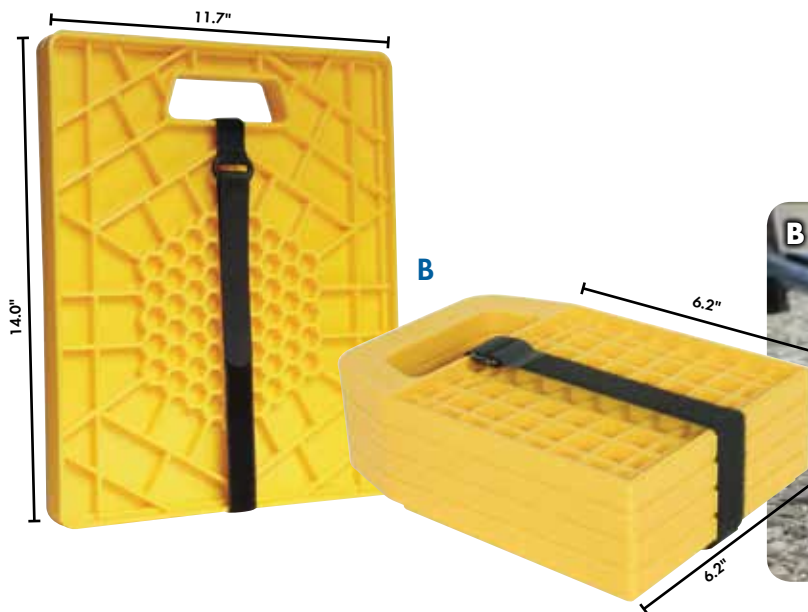

A. Metal Locking Wheel Stop with Wrench

Prevent tandem-tire shift using just one piece of equipment—Eaz-Lift's Premium Metal Wheel Stop. Zinc-plated for corrosion resistance and has raised ribs on the contact surface for increased traction which helps prevent tire shift/slippage between tandem tires spaced from 3–10 inches apart. It also includes a comfort-grip ratchet wrench for easy installation and a lock to keep it secure.

44662 Metal Locking Wheel Stop

B. Wheel Chock Keep your trailer in place so you can park with confidence. Constructed of durable hard plastic with UV inhibitors. Chock with rope attached also available for convenient placement and removal from the wheel. 9.3 x 5.4 x 15.2 inches.

44412 Chock 6/ctn (not shown)
44472 Chock with Rope 6/ctn

C. Super Wheel Chock Keep your vehicle and trailer from moving. Keep your trailer in place and park with confidence. Constructed of durable polypropylene with UV inhibitors. 5.5 x 8.5 x 10 inches.

44492

D. Wheel Stop™ Stabilize your trailer with a single piece of equipment. Secure tandem tires to prevent movement while parked or re hitching. Locking model with padlock included, also available. Patented.

- D1 44652 Fits 1-1/2" to 3-1/2" tire spacing
- D2 44622 Fits 3-1/2" to 5-1/2" tire spacing
- D3 44642 Locking model w/padlock
Fits 3-1/2" to 5-1/2" tire spacing

E. Wheel Dock™ Prevent your trailer tongue wheel from rolling on the pavement or sinking into soft ground. Heavy duty, durable dock is easy to store and transport.

44632

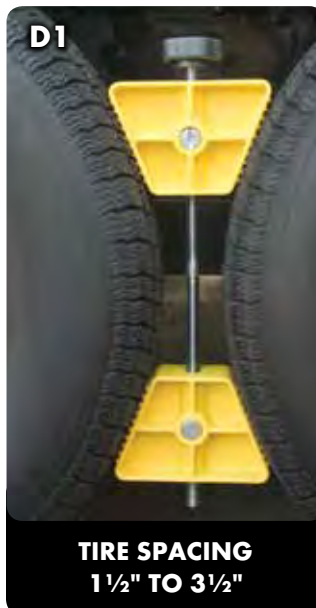

Featured products:



Trailer Connectors & Adapters



Trailer-Aid



Towing Mirrors



Towing

Ball Mounts Ball mounts come in popular sizes, 2" x 2", 1-1/4" x 1-1/4", and are used to convert a receiver from a weight distributing to a weight carrying hitch. Ball mounts create a ball platform for attaching a hitch ball. The ball mounts or utility hitch bar length are determined by measuring from the center of the pull pin to the center of the hitch ball hole. The drop or rise is determined by measuring from the top of the mount to the top of the tongue (See ball mount selection chart). All 2" x 2" ball mount shank holes are 1", except 48280 and 48282, which have a 3/4" hole. (DURABLE POWDER COAT FINISH)



A. Angle, Drop/Rise, Reversible Ball Mounts

Fits 2" X 2" Receiver, Rated MGTWR/MTW 6000/600 All ball mounts are unboxed. Hitch ball not included.

Style	Part #	Length	Drop	Lift
1	48286	9"	2"	3/4"
	48290	13"	2"	3/4"
2	48292	9"	4"	2-3/4"
	48294	11"	4"	2-3/4"
3	48296	13"	4"	2-3/4"
	48298	9"	7"	5-3/4"
4	48300	11"	7"	5-3/4"
	48312	13"	2"	3/4"
5	48314	8"	2"	3/4"
	48324	10-1/2"	1-1/2"	1/4"
6	48304	10-1/2"	3-1/4"	2"
	48316	7"	3-1/4"	2"
7	48306	11-1/2"	6"	4-3/4"
	48318	9"	5-1/4"	4"
	48320	10-1/2"	5-1/4"	4"
	48302	10"	8"	6-3/4"

A1



A2



A3



A4



A5



A6



A7



A. Adjustable Ball Mount Shanks

Used in either the up or down position to match the ball mount to any coupler height. Long hi/low shanks provide the extra length sometimes needed to obtain clearance from bumper interference. Fits 2"x 2" Receiver.

A1. Hi/Low Shank

2-1/2" Drop, 5-1/2" Rise

- 48120 12" Shank
- 48121 14" Shank
- 48122 16" Shank
- 48123 18" Shank

A2. Extra Hi/Low Shank

5-3/4" Drop, 8-3/4" Rise

- 48130 12" Shank (MOST POPULAR SELLER)
- 48131 14" Shank
- 48133 16" Shank

A3. Extra Low Shank 9-1/2" Drop (BALL MOUNT AND SHANK TO BE USED IN THE LOW POSITION ONLY)

- 48132 12" Shank

A1



A2



A3

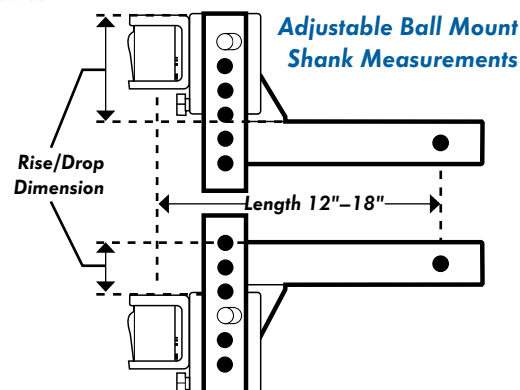

B. Adjustable Utility Ball Mount and Shank

Ideal for those who have more than one trailer or tow vehicle. Rated for trailer weights up to 5,000 lb and tongue weights up to 500 lb. Powder coat baked-on finish. 1" Ball Hole, 8-1/2" Drop, 7-1/4" Rise, Fits 2"x 2" receiver.

- 48270 14" Shank
- 48271 16" Shank

C. Chrome-Plated Steel Hitch Ball

of solid, machined steel. To choose the correct hitch ball for your towing need, check the inside of your coupler and the desired length of the shank on the ball needed. Hitch balls are marked with size and rating; it is important to match coupler size with hitch ball size.

Part #	Ball Dia.	Shank Dia.	Shank Length	Gross Wt. Rating
48213	2-5/16"	1-1/4"	2-1/2"	10,000 lb

D. Bushing Variation in hitch ball holes requires bushings to adjust for the variation of hitch ball shanks.

- 48023 Reduces 1-1/4" to 1"

B

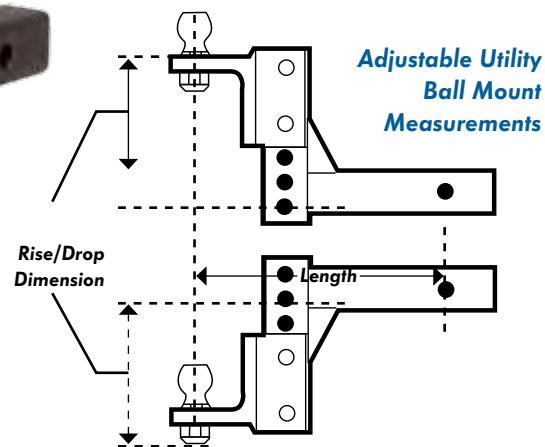

C



D



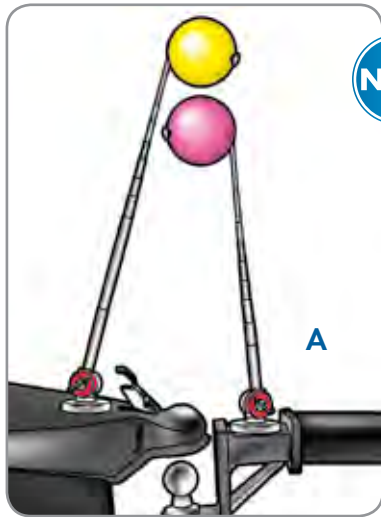

NEW

- One-person hook-up on the first try every time
- Guides extend to 50 inches for easy viewing
- Takes guesswork out of lining up your hitch
- Attach one guide to tow vehicle and one to trailer
- System works with virtually any tow vehicle and trailer



A. Magnetic Hitch Alignment Kit

Camco's Magnetic Hitch Alignment Kit is designed for one-person hook-up on the first try every time. Easily visible balls take the guesswork out of linking up your hitch. Attach one guide to the tow vehicle and one to the trailer. Guides extend to 50 inches for easy viewing, and a swivel base allows the guides to be positioned directly above hitch and receiver. This system works with virtually any tow vehicle and any trailer: boat trailers, gooseneck trailers, fifth wheel trailers and horse trailers.

44603 Hitch Alignment Kit



B

B. Combo Bar 2" x 2" x 1/4" wall with collared tube, used to create under-car receivers for vehicles where standard or frame hitches are not available. Can be bolted or welded to vehicles undercarriage. Sized and punched to fit all common weight distributing hitch ball mounts or utility ball mounts. *Wt. Dist. only with 24" to 48" combo bar when properly installed. Fits 2"x 2" receiver.

- 48170** 6" Shank
- 48171** 10" Shank
- 48172** 12" Shank
- ***48173** 24" Shank
- ***48174** 36" Shank
- ***48175** 48" Shank

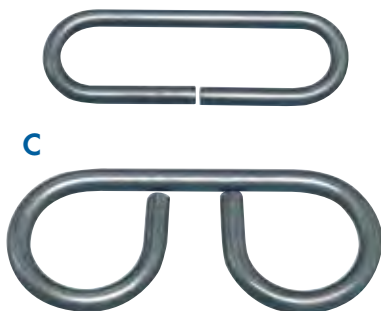

C

C. Chain Loop Safety chain for use with fabricated receiver and hitches. Small Loops for Class I and II. Large Loops for Class III and IV.

- 48180** Small
- 48181** Large



D

D. Grease Gun Perfect size for small engine spaces. Features adjustable nozzle to come out of the front or top. Easy to stow.

- 44616** Grease Gun
- 44619** 2-pack replacement cartridge

Trailer Cable

Black PVC Jacket

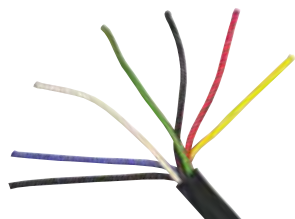

	7 Conductor Diameter .60; Copper wires color coded: yellow, red, green, brown, black, white and blue.	14 Gage 6 Conductor Diameter .520; Copper wires color coded: yellow, red, green, brown, black and white.	4 Conductor Diameter .44; Copper wires color coded: yellow, red, green and brown.	16 Gage 6 Conductor Diameter .44; Copper wires color coded: yellow, red, green, brown, black and white.	Multi-Gage - 7 Conductor 1-10, 6-12 Ga. Diameter .69; Copper wires color coded: 1-10 ga-white, 6-12 ga - yellow, red, green, brown, blue and black.	2-10, 1-12, 4-14 Ga. Diameter .69; Copper wires color coded for RV; 2-10 ga-black and white, 1-12 ga-blue, 4-14 ga-yellow, red, green and brown.
25 ft Spool	64650	64656	-	-	-	64673
50 ft Spool	64651	64657	64661	-	64668	64674
100 ft Spool	64652	64658	64662	64665	64669	64675
250 ft Spool	64653	-	-	-	64670	64676
500 ft Bulk Reel	64654	64659	64663	64666	-	64677

Trailer Connectors

A. 7-Way Plastic Round Pin Connector Corrosion-proof glass-filled nylon. Easy alignment and maximum contact. Accepts 8 ga to 14 ga wire. Plug is waterproof when boot (64802) is added.

A1. Plug, Trailer-end

- 64819 Plug, Bulk
- 64802 Boot, Bulk (not shown)

A2. Socket, Car-end

- 64820 Socket, Bulk
- 64801 Boot, Bulk (not shown)

A3. Mounting Bracket

- 64804 Bulk



B. 7-Way Plastic Blade-Type Connector Features dual grips for easy removal. Vinyl inserts keep out dirt and moisture. Safety latch prevents damage from accidental pull-away.

B1. Plug, Trailer-end

- 64814 Bulk
- 64815 1/card

B2. Socket, Car-end

- 64816 Bulk
- 64817 1/card

Complete, Trailer- and Car-ends
(64814 and 64816 only)

- 64812 Bulk
- 64813 1/card

B3. Mounting Bracket

- 64811 Bulk



C. 7-Way Blade-Type Circuit Tester Internally grounded tester fits 7 way blade-type connectors. Checks conductivity of circuits. LED lights glow when circuit is functioning correct.

- 64778 1/card
- 64777 Bulk



Trailer Adapters for connecting to:

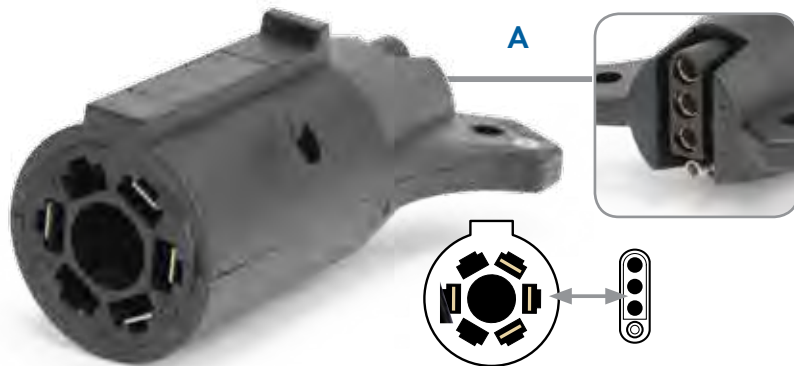

A. Trailer Adapter, Heavy Duty Blade 7-Way to 4-Way Flat Trailer Adapter 7-way male end plugs into your existing female end and converts it to a standard 4-way flat female connector.

64785 Bulk
64786 1-card

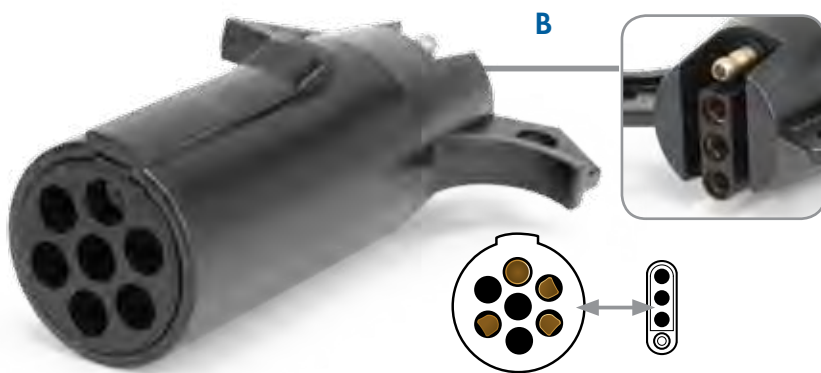

B. Trailer Adapter, Plastic 7-Way Round Pin to 4-Way Flat 7-way male end plugs into your existing female end and converts it to a standard 4-way flat female connector.

64787 Bulk
64788 1-card

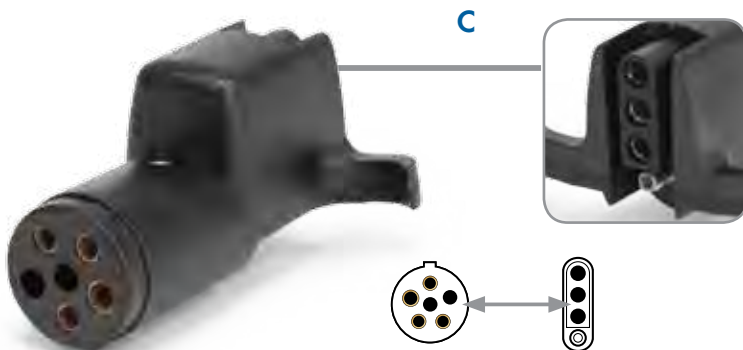

C. Trailer Adapter, 6-Way Round Pin to 4-Way Flat 6-way male end plugs into your existing female end and converts it to a standard 4-way flat female connector.

64789 Bulk
64790 1-card

D. Frame Clips

65070 Small-3/16" ID, 1-card
65072 Medium-1/4" ID, 1-card
65074 Large-3/8" ID, 1-card



Trailer Connectors

A. Trailer Connectors, Complete

(Male and Female Ends), 12"

A1. 2-Way, Flat

18 ga wire, 12" long

- 64830 Bulk
- 64858 1/bag

A2. 3-Way, Flat

18 ga wire, 12" long

- 64831 Bulk
- 64859 1/bag

A3. 4-Way, Flat

18 ga wire, 12" long

- 64834 Bulk
- 64835 1/bag

A4. 5-Way, Flat

18 ga wire, 60" long

- 64855 Bulk
- 64856 1/bag

A5. 6-Way, Square

16 ga wire, 12" long

- 64833 Bulk
- 64860 1/bag



A3

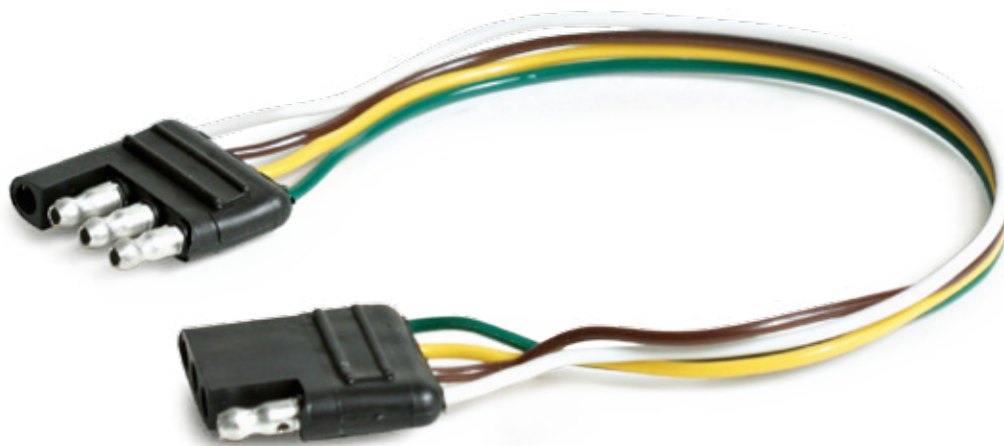

B. 4-Way Wishbone Vehicle End

Length	Bulk	1/bag
12-inch	64838	64839
24-inch	64840	64841
36-inch	64842	64843
48-inch	64844	64845
25-foot	64836	64837
30-foot	64846	64847

C. 4-Way Tow Trailer End

- 64849 12" Pigtail, Bulk
- 64850 12" Pigtail, 1/bag
- 64851 48" Wishbone Harness, Bulk
- 64852 48" Wishbone Harness, 1/bag
- 64853 60" Bonded Harness, Bulk
- 64854 60" Bonded Harness, 1/bag

D. 4-Way Trailer Test Light

Trailer light problems are easily identified by plugging this tester into your existing car-end connector. Also helps to properly install a 4-way connector without a trailer attached.

- 64775 Bulk
- 64776 1/bag

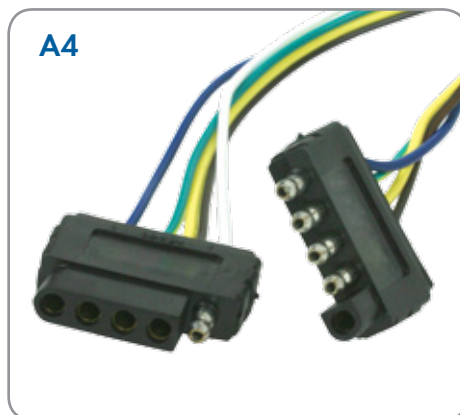



A. Trailer-Aid™ Trailer-Aid allows anyone to change a flat tire anywhere, anytime—without help and without a jack. Provides 4½ inches of lift, and can withstand weights up to 15,000 lb. Trailer-Aid is waterproof and rustproof; made from a lightweight, super-strong polymer.

- 21 Yellow
- 22 Black

B. Trailer-Aid™ PLUS Trailer-Aid PLUS is designed to give an additional 1" lift. The extra 1" lift makes Trailer-Aid PLUS handy when performing maintenance on brakes, wheels and axles. Can withstand weights up to 15,000 lb.

- 23 Yellow
- 24 Black

C. Trailer-Aid™ Holder Secure your Trailer-Aid or Trailer-Aid PLUS with this metal holder. Designed to mount on the wall of your trailer.

- 55

D. Tire Changing Tool Assists in lifting to easily mount and dismount tires while changing a spare. Lightweight and easy to travel with. Patented.

- 44511 Tire Changing Tool



A. Tow-N-See™ Power Mirror Extender

Don't spend money on expensive aftermarket power mirror extensions. Tow-N-See Mirror moves along with your power mirrors so you can adjust your view while sitting in the driver's seat. Installs in just seconds with a twist of the knob, leaving no marks and making it easy to transfer from one vehicle to the next.

Tow-N-See...The one that works! Patented.

25668 Convex (Passenger Side)

25663 Flat (Driver Side)

B. Convex Blind Spot Mirror Can be installed on either side view mirror to help eliminate blind spots. 4" x 5.5"

25603 Convex Mirror

C. Convex Blind Spot Mirror Can be installed on either side view mirror to help eliminate blind spots. 3.75" Round.

25613 Convex Round Mirror

D. Wide Angle Blind Spot Mirror Can be installed on either side view mirror to help eliminate blind spots. 3.25" x 3.25"

25623 Wide Angle Mirror

E. 360° Blind Spot Mirror Wide angle mirror can be installed on either side-view mirror to help eliminate blind spots. Adjustable 360° mirror rotates for different driving positions. Large 3.75" diameter mirror effectively increases viewing angles.

25643 360° Blind Spot Mirror

F. Blind Spot Mirrors Convex wide angle mirrors can be installed on rearview or side-view mirrors to help eliminate blind spots. Adjustable 360° mirror rotates for different driving positions. Large 2" diameter mirror surface effectively increases viewing angles.

25593 2/pack



Featured products:



Heat Shrink Terminals



Marine Safe Light Bulbs



Marine Shore Power Cords

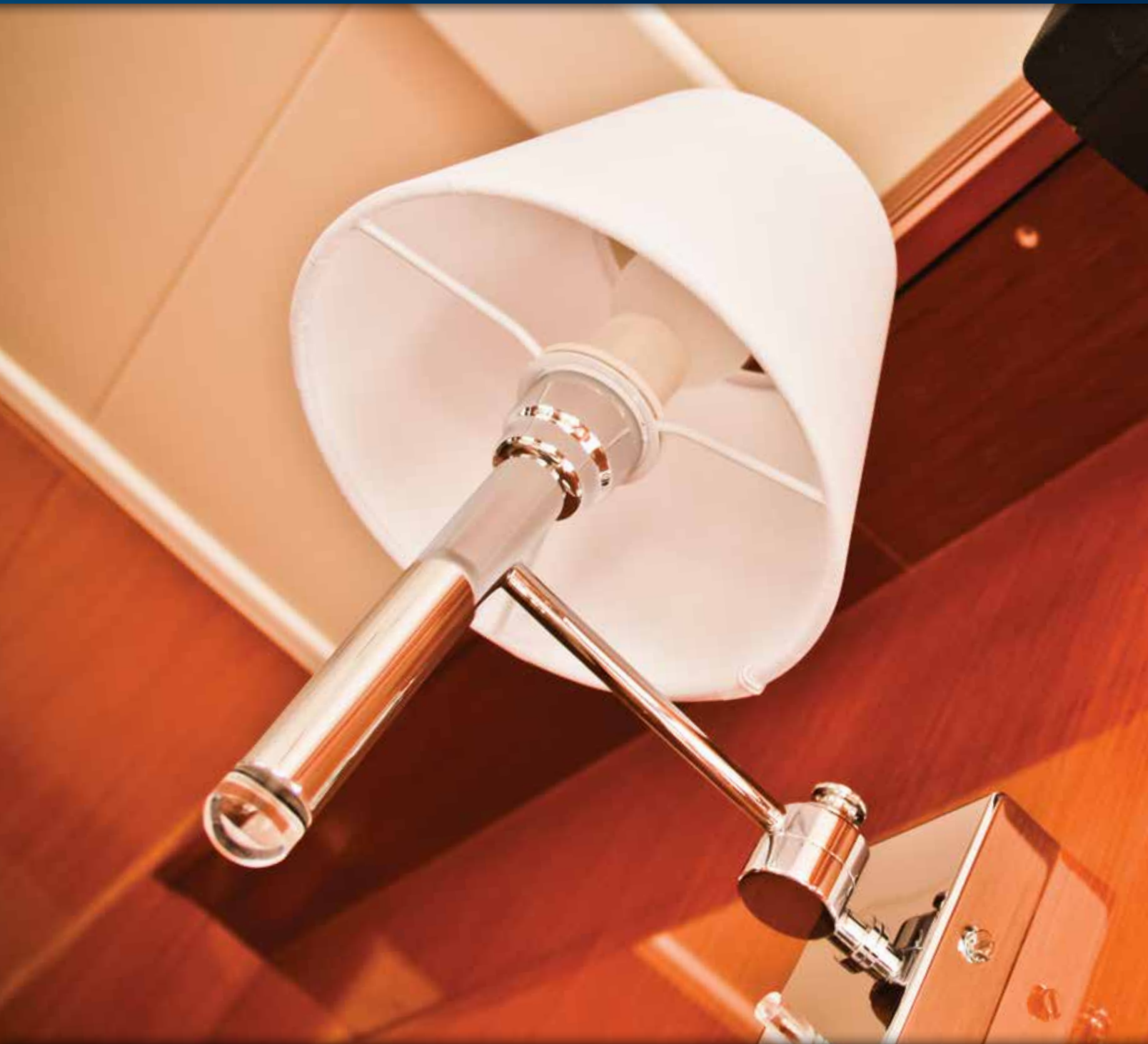





Electrical

SINGLE CONDUCTOR PRIMARY TINNED BOAT WIRE

Camco Premium Marine Quality wire is UL 1426 listed and manufactured to the highest ABYC standards. Heat resistant up to 105° C dry and available in gauges from 18 to 8.

Each strand of individually tinned wire provides the greatest protection against corrosion and oxidation available. Camco Primary Wire stays ultra flexible even in the most extreme conditions.



	AWG	Black	Dk. Blue	Brown	Green	Grey	Orange	Pink	Purple	Red	White	Yellow	
	18	35'*	46000	-	-	-	-	-	-	46080	-	-	
		100'	46001	-	-	-	-	-	-	46081	-	-	
	16	25'*	46120	46130	-	46150	-	-	-	46200	46210	46220	
		100'	46121	46131	46141	46151	46161	-	-	46191	46201	46211	46221
		1000'	46124	46134	46144	46154	-	-	-	46204	46214	46224	
	14	18'*	46240	-	-	46270	-	-	-	46320	46330	-	
		100'	46241	46251	46261	46271	46281	46291	46301	46311	46321	46341	
	12	12'*	46350	-	-	-	-	-	-	46430	-	-	
		100'	46351	46361	-	46381	-	-	-	46431	46441	46451	
		1000'	-	-	-	-	-	-	-	46434	-	-	
	10	100'	46461	-	-	-	-	-	-	46541	46551	-	

TINNED BATTERY CABLE

Camco Premium Marine Quality Battery Cable is UL 1426 listed and manufactured to the highest ABYC standards. Heat resistant up to 105° C dry and available in all gauges and ABYC recommended colors.

Each strand of individually tinned wire provides the greatest protection against corrosion and oxidation available. Camco's Type 3 boat cable wire stays ultra flexible even in the most extreme conditions.



	AWG	Black	Green	Red	White	
	8	25'	46620	-	46640	-
		50'	-	-	-	46651
		100'	46622	46632	46642	46652

	AWG	Black	Green	Red	
	6	25'	46670	46680	46690
		100'	-	46682	46692

	AWG	Black	-	Red	
	4	25'	46720	-	46730
		100'	46722	-	46732

	AWG	Black	Red	
	2	25'	46750	46760

	AWG	Black	Red	
	1	25'	46780	46790
		100'	46782	46792

	AWG	Black	Red	
	2/0	25'	46840	46850
		100'	46842	46852

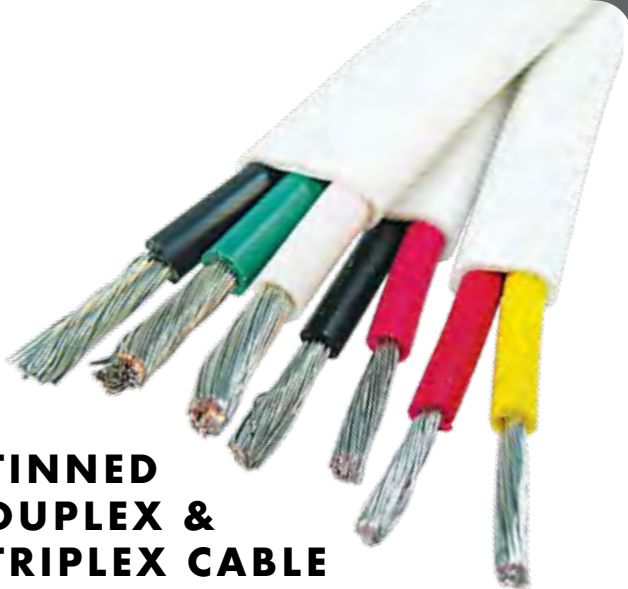

TINNED DUPLEX & TRIPLEX CABLE

Camco's Premium Marine Quality Specialty, Duplex and Triplex Type 3 Cables are UL 1426 listed and manufactured to the highest ABYC standards.

Camco's vinyl protective jacket provides the greatest protection against corrosion, abrasion and oxidation available. Color-coded to ABYC recommendations; Camco wire stays ultra-flexible even in the most extreme conditions. 

Duplex Cable, Safety, Flat -Red, yellow

	12/2	10/2
25'	-	46970
100'	46961	46971

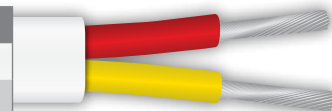

Duplex Cable, Standard, Flat -Red, black

	18/2	16/2	14/2	12/2	10/2
100'	47032	47042	47051	47061	47071
1000'	-	47045	-	-	-



Triplex Cable, Flat -White, black, green

	16/3	14/3	12/3
100'	47101	47111	47121

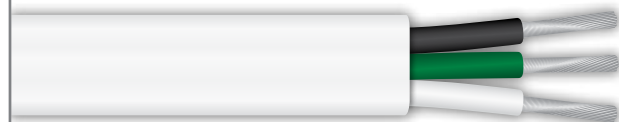

BATTERY CABLE & LUG ASSEMBLY

Camco's Premium Marine Quality Battery Cable & Lug Assembly is UL 1426 listed and manufactured to the highest ABYC standards.

Heat-resistant up to 105° C dry and available in black, red and yellow.

Pre-Assembled with Premium Marine Quality tin-plated, 95%-copper lugs, each strand of individually tinned wire provides the greatest protection against corrosion and oxidation available. Camco's Type 3 boat cable wire stays ultra flexible even in the most extreme conditions.



4 AWG, 5/16" Stud

	12"	18"	24"	32"	36"	48"	72"	96"
Black	47443	47440	47444	47441	47445	47442	47446	47447

2 AWG, 5/16" Stud

	12"	18"	24"	32"	36"	48"	72"	96"
Black	47473	47470	47474	47471	47475	47472	47476	47477

4 AWG, 3/8" Stud

	12"	18"	24"	32"	36"	48"	72"	96"
Red	47453	47450	47454	47451	47455	47452	47456	47457

2 AWG, 3/8" Stud

	12"	18"	24"	32"	36"	48"	72"	96"
Red	47483	47480	47484	47481	47485	47482	47486	47487

**Tin-Plated
Copper Lugs**
Made from
95% copper.



TIN-PLATED COPPER LUGS

Qty.	8 Gage			6 Gage		4 Gage		2 Gage	
	#10	#5/16	#3/8	#1/4	#3/8	#5/16	#3/8	#5/16	#3/8
2	47752	47746	47748	47710	47744	47714	47716	47720	47722

Qty.	1 Gage		1/0 Gage		2/0 Gage	
	#3/8	#5/16	#5/16	#3/8	#5/16	#3/8
2	47740	47750	47724	47726	47730	47732



Heat Shrink Ring Terminals



AWG	Stud	Ins.	Pkg.	Part #
22-18	#8	Heat Shrink	3	65872
22-18	#10	Heat Shrink	100	63863
16-14	#8	Heat Shrink	3	65884
16-14	#10	Heat Shrink	100	63875
16-14	5/16"	Heat Shrink	3	65890
16-14	3/8"	Heat Shrink	3	65893
12-10	#8	Heat Shrink	3	65896
12-10	#10	Heat Shrink	100	63887
12-10	5/16"	Heat Shrink	3	65902
12-10	3/8"	Heat Shrink	3	65905

Flanged, Insulated Spade Terminals

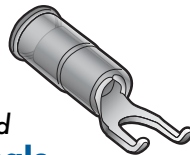

AWG	Stud	Ins.	Pkg.	Part #
16-14	#8	Nylon	6	63742
16-14	#10	Nylon	6	63745
12-10	5/16"	Nylon	6	63754
12-10	5/16"	Nylon	100	063756

Insulated Disconnects

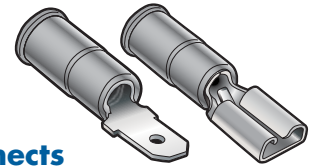

AWG	Gender	Ins.	Pkg.	Part #
22-18	Male	Vinyl*	4	63701
22-18	Female	Vinyl*	4	63706
16-14	Male	Vinyl*	4	63711
16-14	Female	Vinyl*	4	63716
12-10	Male	Vinyl*	3	63721
12-10	Female	Vinyl*	3	63726

*Limited quantities.

Insulated Butt Connectors



AWG	Ins.	Pkg.	Part #
22-18	Nylon	5	63481
22-18	Nylon	25	63482
16-14	Nylon	5	63491
16-14	Nylon	25	63492
12-10	Nylon	5	63501
12-10	Nylon	25	63502

Insulated Snap Plugs

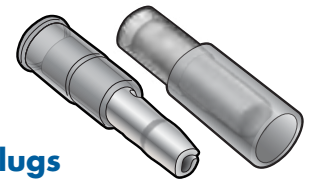

AWG	Gender	Ins.	Pkg.	Part #
16-14	Male	Nylon	25	47622

Insulated Ring Terminals



AWG	Stud	Ins.	Pkg.	Part #
22-18	#10	Nylon	6	63116
22-18	1/4"	Nylon	6	63126
16-14	#10	Nylon	5	63171
16-14	1/4"	Nylon	5	63181
16-14	5/16"	Nylon	5	63191
12-10	#10	Nylon	4	63211
12-10	1/4"	Nylon	4	63221
12-10	5/16"	Nylon	4	63231
12-10	3/8"	Nylon	4	63241



A



A. 3" Mini Torch 1500° continuous adjustable flame. Refillable with butane. Great for heat-shrink terminals and tubing. 1.5 hours of flame per tank.

63930 1/card

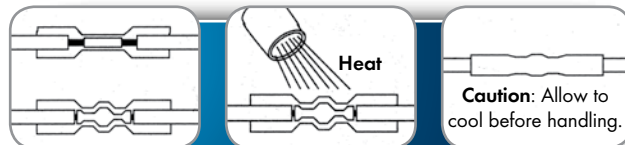

Crimping Instructions:

Strip the wire 1/4" and insert it into the barrel of the terminal. Match the color of the insulation with the color of the crimp cavity on the crimping tool. Heat the crimped device with a heat gun until the tubing recovers and the adhesive melts and flows.

Caution: Allow to cool before handling.

B. All-Purpose Hand tool Standard duty construction. Crimps and strips 22-10 AWG wire. Features wire and bolt cutters.

63921 1-card

B



C. Self-Adjusting Wire Stripper

Cuts and strips 26-10 AWG wire and crimps insulated and uninsulated terminals. Strips multi-lead trailer wire in one motion without harming strands.

63924 1-card

C

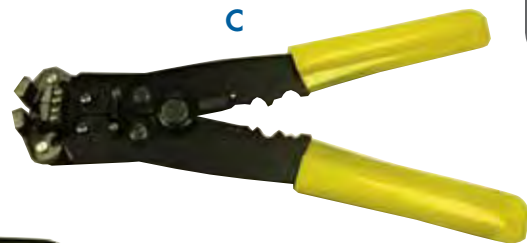

D. Ratcheting Crimper Tool Crimps 22-18, 16-14 and 12-10 AWG terminals in three separate crimping nests. Makes two crimps—electrical and weather resistant—all in one motion.

63929 1-card

D



E. Circuit Tester 6-12V Tests continuity of ground circuit of lamps, wiring, fuses, switches, battery cable circuits, etc.

63926 1-card

E



F. Quickee Circuit Tester One-hand operation to test circuits in hard-to-reach areas. Works two ways—captures and pierces wire with unique hook design or it can be used as an "ice pick" type tester.

63928 1-card

F



G. Power Grip™ Electrical Protectant & Lube Use on any electrical connector to improve conductivity and protect from oxidation. Also helps make connectors easier to insert and remove. Perfect for use with Camco's Power Grip™ Adapters and Extension Cords.

55013 Electrical Protectant & Lube

G



H. 120 Volt Line Monitor Designed to plug into any 120V wall receptacle and provide a continuous, accurate reading of the AC line voltage.

55263 120V Line Monitor

H



I. PVC Electrical Tape All-Weather UL and CSA approved electrical tape. 3/4" x 60'.

65085 bulk

I



Glass Fuses

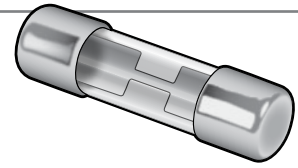
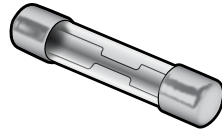

AGC / Glass Fuses

AGU Glass Fuses

AMP	1	2.5	4	5	7.5	10	15	20	25	30	35	30	40	50	60
5-pk	65091	65093	65095	65097	65099	65101	65103	65105	65107	65109	65111	65176	65178	65180	65182

Blade Fuses

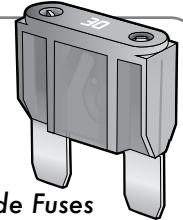

Mini-Blade Fuses

ATC/ATO Blade Fuses

Max-Blade Fuses

AMP	5	7.5	10	15	20	25	30	3	5	7.5	10	15	20	25	30	20	30	40	50	60
Color	Tan	Brown	Red	Blue	Yellow	Clear	Green	Violet	Tan	Brown	Red	Blue	Yellow	Clear	Green	Yellow	Green	Orange	Red	Blue
2-pk	65141	65143	65145	65147	65149	65151	65153	65121	65123	65125	65127	65129	65131	65133	65135	65161	65163	65165	65167	65169



ATC Fuse Tap Adapter Tap the hot side of flat automotive fuse blocks to easily create an additional circuit for a radio or other add-on accessory.

65186 2 pack

Blade Terminals Heavy duty replacement for ATO and ATC blade type fuses. Special snap off feature provides three lengths from .30-.75 long. Bulk packs (each).



AMP	10	15	20	25	30
1-pk	65231	65233	65235	65239	65237

FUSE HOLDERS

ATO/ATC/Blade Fuse Holder*



	16 AWG / 20 AMP	12 AWG / 25-30 AMP
1/card	65250	65252

AGC/Glass Fuse Holder

6" wire (Fuse included)



	16 AWG / 10 AMP	16 AWG / 20 AMP	12 AWG / 30 AMP	10 AWG / 30 AMP
1/card	-	65241	65246	65248

Mini-Blade Fuse Holder*

Weather resistant cover



	16 AWG / 5-20 AMP
Bulk	65253

Max-Blade Fuse Holder*

Waterproof



	8 AWG / 60 AMP
Bulk	65255

*Fuses not included.

CIRCUIT BREAKERS

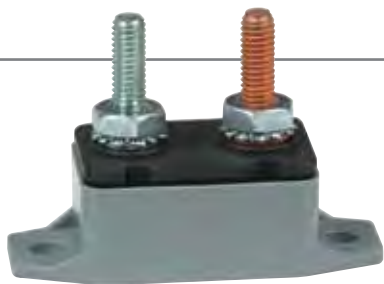

Automatic-Reset Straight-mount

6-24 Volt application.
No. 10 Nut and Lock Washer included.

AMP	1/card
10	65218
15	65220
20	65222
30	65224
50	65226

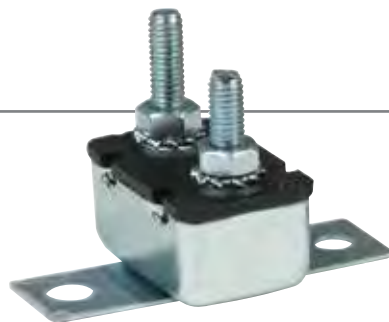

Automatic-Reset 90°-mount

6-24 Volt application. 6-24 Volt application.
No. 10 Nut and Lock Washer included.

AMP	1/card
10	65192
15	65194
20	65196
30	65198
40	65200
50	65202



Snap-in

12-Volt Remote reset breakers. Replace round glass style fuses in existing fuse blocks. Opens automatically on overload.

AMP	1/card
30	47690

LOOM & HEAT SHRINK TUBING

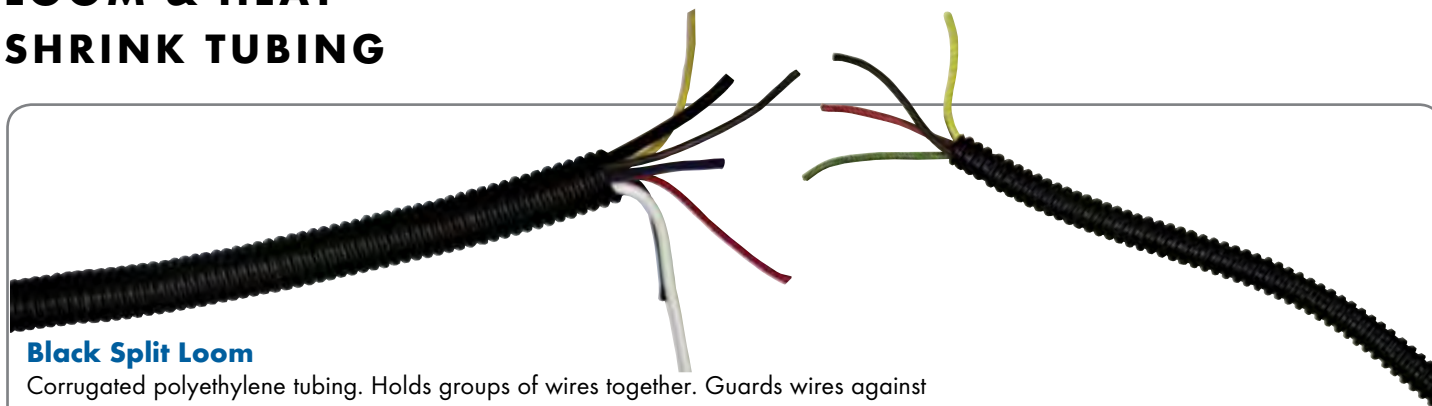

Black Split Loom

Corrugated polyethylene tubing. Holds groups of wires together. Guards wires against abrasion and crushing. Tubing is slit for easy insertion of wires.

	1/4"	3/8"	1/2"	5/8"	1"	1-1/4"
50 ft	-	64976	64979	-	-	-
100 ft	64972	64975	64978	64981	64987	64990



Adhesive Lined Heat Shrink Tubing

Crosslinked polyolefin tubing with an internal meltable sealant. Recovers to 33% of its original diameter. As it shrinks, the internal sealant melts and physically encapsulates the covered item. This tubing is especially useful as a moisture barrier in high humidity and corrosive environments. Used for strain relief, wire splices, breakouts, connections, solder joints, delicate wire terminations and end sealing of cables and tubing.

Size (in.) Wire Range (AWG)	1/8" 20-18	3/16" 20-12	1/4" 16-10	3/8" 12-8	1/2" 8-4	3/4" 6-2/0
3" (3-pack/clamshell)	47635	47637	47639	47641	47643	47645

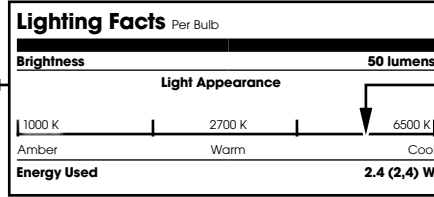

Amber Bulbs
1000 K-
1500 K

Clear and
Frosted Bulbs
4000 K-
4500 K



Energy-Saving RV/Marine LED Bulbs Long-lasting, energy-saving 12-Volt LED bulbs for RV and Marine use. Color temperature for clear and frosted bulbs is 4000–4500 K. Color temperature for the Amber bulb (54618) is 1,000–1,500 K.

Part #	Description	Lumens	Watts	Qty
A. Replaces: 1003, 1073, 1093, 1141, 1156, 1159, 1295, 3497, 5007, 5008, 7506, 7527				
Base: BA15s - Single Contact Bayonet				
54600	1003/1093-LED Swivel, w/White Housing	150	1.9	1 pk
54602	1003/1093-LED Swivel, w/Black Housing	150	1.9	1 pk
54604	1141-LED Swivel, w/White Housing	200	2.4	1 pk
54606	1141-LED Swivel, w/Black Housing	200	2.4	1 pk
54608	1156/1073-LED Swivel, Frosted Lens, w/White Housing	180	3.6	1 pk
54610	1156/1073-LED Swivel, w/White Housing	230	3.6	1 pk
54612	1156/1073-LED Swivel, w/Black Housing	230	3.6	1 pk
B. Replaces: 93, 1003, 1073, 1093, 1141, 1156, 1159, 1295, 3497, 5007, 5008, 7506, 7527				
Base: BA15s - Single Contact Bayonet				
54614	5008-LED	170	1.4	2 pk
C. Replaces: 1383 Base: BA15s - Single Contact Bayonet				
54616	1383-LED	150	2.4	1 pk
54618	1383A-LED, Amber	50	2.4	1 pk
D. Replaces: 516, 579, 904, 906, 912, 916, 917, 918, 920, 921, 922, 923				
Base: W2.1 X 9.5d - Wedge				
54620	912-LED, Frosted Lens	100	2.4	1 pk
54622	921-LED, Frosted Lens	200	3.8	1 pk
E. Replaces: G4 Bulb Base: G4 - Bi-pin				
54624	G4-LED	160	1.1	1 pk
54626	G4-LED	205	2.2	1 pk
F. Replaces: Fluorescent Bulb Base: T5-Fluorescent / T8-Fluorescent				
54628	T5-LED, 12" Fluorescent Bulb	400	5.8	1 pk
54630	T8-LED, 18" Fluorescent Bulb	700	11.3	1 pk
G. Replaces: 68, 94, 847, 1004, 1020, 1076, 1142, 1152, 1171, 1176, 1196				
Base: BA15d - Double Contact Bayonet				
54632	1076-LED	200	2.4	1 pk
H. Replaces: 1016, 1034, 1154, 1157, 2057, 2357, 2397, 3496, 7528				
Base: BA15d - Indexed Double Contact Bayonet				
54634	1157-LED	40/170	0.3	2 pk
I. Replaces: 211, 212, 6411, 6413, 6429, 6451, 7576, 6475				
Base: SV8.5 - 8 - Festoon				
54636	212-LED	20	0.2	2 pk
J. Replaces: 194, 516, 579, 901, 904, 906, 912, 918, 920, 923, 928				
Base: W2.1 X 9.5d (T10) - Wedge				
54638	906-LED	70	1.2	2 pk
K. Replaces: Any bulb with the bases: BA15s, BA15d, G4, W2.1 x 9.5d, SV8.5-8				
Base: BA15s, BA15d, G4, W2.1 x 9.5d, SV8.5-8				
54640	Universal LED	200	2.4	1 pk
54642	Universal LED	300	3.6	1 pk
L. Load Resistor				
54644	Load Resistor Kit for LED Bulb, 6Ω	-	50	2 pk

LIGHT BULBS

Camco offers both clamshell and bulk packages and we are committed to providing you a well designed product that has been developed through rigid adherence to product specifications. The nominal voltage for most of our bulbs is 12.0.

- DESIGN VOLTS:** The voltage at which the lamp is designed for rated amperage, candlepower and life characteristics.
- CANDLEPOWER:** The average value of total light output of miniature lamps at design volts.
- LIFE HOURS:** The rated average life to be expected when operated at design volts. Actual service life can vary depending upon application.
- SERVICE DESC.:** The major applications for each bulb. In most cases they can be used in many other applications.
- FIG. NUMBER:** Refers to the diagrams on page sides.

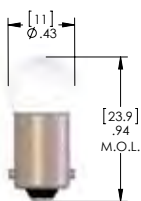

Figure 1

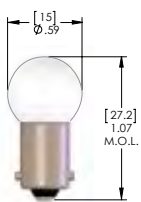

Figure 2



Figure 3



Figure 4

Fig #	Part #	Description	Design Volts	Amps	Watts	Candle Power	Life Hours	Package
1	54710	53 Auto Instrument	14.4	.12	1.7	1	1000	10/box
	54711	53 Auto Instrument	14.4	.12	1.7	1	1000	2/pk
2	54712	55 Auto Instrument	7	.41	2.87	2	200	10/box
	54714	57 Auto Instrument	14	.24	3.4	2	500	10/box
	54715	57 Auto Instrument	14	.24	3.4	2	500	2/pk
	54836	1895 Auto Instrument	14	.27	3.78	2	2000	10/box
	54837	1895 Auto Instrument	14	.27	3.78	2	2000	2/pk
3	54717	63 Auto Instrument	7	.63	4.41	3	1000	2/pk
	54720	67 Auto License	13.5	.59	7.97	4	5000	10/box
	54721	67 Auto License	13.5	.59	7.97	4	5000	2/pk
	54727	89 Auto Interior	13	.58	7.54	6	750	2/pk
	54734	97 HD Auto License	13.5	.69	9.315	4	5000	10/box
	54736	97A HD Auto Bulb	13.5	.69	9.315	-	5000	10/box
4	54718	64 Auto License Aviation	7	.63	4.41	3	1000	10/box
	54722	68 Auto/Marine	13.5	.59	7.97	4	5000	10/box
	54723	68 Auto/Marine	13.5	.59	7.97	4	5000	2/pk
	54724	82 Auto 6.5V	6.5	1.02	6.63	6	500	10/box
	54728	90 Auto/Marine Interior	13	.58	7.5	6	750	10/box
	54729	90 Auto/Marine Interior	13	.58	7.5	6	750	2/pk

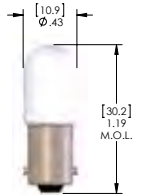

Figure 5

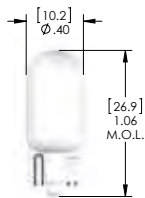

Figure 6

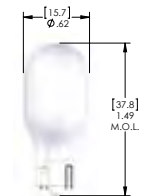

Figure 7



Figure 8



Figure 9



Figure 10

Fig #	Part #	Description	Design Volts	Amps	Watts	Candle Power	Life Hours	Package
5	54830	1816 Aviation/Auto Instrument	13	.33	4.29	3	1000	10/box
	54832	1889 Auto Instrument	14	.27	3.78	2	2000	10/box
	54834	1893 HD Auto Instrument	14	.33	4.62	2	7500	10/box
	54835	1893 HD Auto Instrument	14	.33	4.62	2	7500	2/pk
6	54742	158 Auto Instrument	14	.24	3.36	2	2500	10/box
	54744	161 HD Auto/Marine	14	.19	2.7	1	4000	10/box
	54746	168 Auto Instrument	14	.35	5	3	1500	10/box
	54748	193 Ex HD Auto Instrument	14	.33	4.62	2	15000	10/box
	54750	194 HD Auto Instrument	14	.27	3.8	2	2500	10/box
	54751	194/158 HD Auto Instrument	14/14	.27/.24	3.78/3.36	2.1	2500/500	2/pk
	54752	194A Auto Side Marker	14	.27	3.78	1.5	2500	10/box
	54753	194A Auto Side Marker	14	.27	3.78	1.5	2500	2/pk
7	54762	906 Auto/RV Interior	13.5	.69	9.3	6	1000	10/box
	54763	906 Auto/RV Interior	13.5	.69	9.3	6	1000	2/pk
	54765	906F RV Interior	13.5	.69	9.3	6	1000	2/pk
	54766	912 Auto/RV/Marine Interior	12.8	1	12.8	12	1000	10/box
	54767	912 Auto/RV/Marine Interior	12.8	1	12.8	12	1000	2/pk
	54768	921 Auto 3rd Brake Lamp	12.8	1.41	18.048	21	1000	10/box
	54769	921 Auto 3rd Brake Lamp	12.8	1.41	18.048	21	1000	2/pk
	54770	921F Auto 3rd Brake Lamp	12.8	1.41	18.048	-	300	10/box
8	54772	1003 Auto/RV Interior	12.8	.94	12.03	15	100	10/box
	54773	1003 Auto/RV Interior	12.8	.94	12.03	15	100	2/pk
9	54774	1004 Auto/RV Interior	12.8	.94	12.03	15	100	10/box
	54775	1004 Auto/RV Interior	12.8	.94	12.03	15	100	2/pk
10	54730	93 Auto	12.8	1.04	13.312	15	700	10/box
	54731	93 Auto	12.8	1.04	13.312	15	700	2/pk
	54788	1141 Auto/RV Back Up	12.8	1.44	18.432	21	1000	10/box
	54789	1141 Auto/RV Back Up	12.8	1.44	18.432	21	1000	2/pk
	54791	1141IF Special Service Inside	12.8	1.44	18.432	21	1000	2/pk
	54793	1141NA Auto/RV/Marine Exterior	12.8	1.44	18.432	-	1000	2/pk
	54802	1156 Auto Back Up	12.8	2.1	26.9	32	1200	10/box
	54803	1156 Auto Back Up	12.8	2.1	26.9	32	1200	2/pk
	54818	1295 Auto Cornering	12.5	3	37.5	50	300	10/box
	54829	1651 Lantern 4F Cells - Clear	5	.6	3	3	200	2/pk



Figure 11



Figure 12



Figure 13



Figure 14



Figure 15

Fig #	Part #	Description	Design Voltage	Amps	Watts	Candle Power	Life Hours	Package
11	54798	1154 Auto Park/Tail/Signal	6.3/7	2.63/.75	16.6/.53	21/3	200	10/box
	54799	1154 Auto Park/Tail/Signal	6.3/7	2.63/.75	16.6/.53	21/3	200	2/pk
	54806	1157 Auto Park/Tail/Signal	12.8/14.0	2.1/0.65	26.88/8.32	32/3	1200/5000	10/box
	54807	1157 Auto Park/Tail/Signal	12.8/14.0	2.1/0.65	26.88/8.32	32/3	1200/5000	2/pk
	54810	1157NA Auto Park/Tail/Signal	2.8/14.0	2.1/.59	26.88/8.26	24/2.2	1200/5000	10/box
	54811	1157NA/1034NA Auto Park/Tail	2.8/14.0	2.1/.59	26.88/8.26	24/2.2	1200/5000	2/pk
	54838	2057 Auto Park/Tail/Signal	12.8/14.0	2.1/0.48	26.88/6.72	32/2	1200/5000	10/box
	54839	2057 Auto Park/Tail/Signal	12.8/14.0	2.1/0.48	26.88/6.72	32/2	1200/5000	2/pk
	54841	2057NA Auto Park/Tail/Signal	12.8/14.0	2.1/0.48	26.88/6.72	24/1.5	1200/5000	2/pk

12	54733	94 Auto/Marine	12.8	1.04	13.312	15	700	10/box
	54780	1076 Auto/RV/Marine Signal	12.8	1.8	23.04	32	200	10/box
	54781	1076 Auto/RV/Marine Signal	12.8	1.8	23.04	32	200	2/pk
	54794	1142 Auto/RV/Marine Exterior	12.8	1.44	18.432	21	1000	10/box
	54795	1142 Auto/RV/Marine Exterior	12.8	1.44	18.432	21	1000	2/pk
	54812	1176 Stop/Tail/Park	12.8/14	1.34/0.59	17.15/8.26	21/6	300/1500	10/box
	54813	1176 Stop/Tail/Park	12.8/14	1.34/0.59	17.15/8.26	21/6	300/1500	2/pk

13	54786	1139IF RV/Marine/Truck Interior	12.8	1.04	13.3	15	700	10/box
	54787	1139IF RV/Marine/Truck Interior	12.8	1.04	13.3	15	700	2/pk
	54796	1143IF RV/Marine Inside	12.5	1.98	24.75	-	400	10/box
	54797	1143IF RV/Marine Inside	12.5	1.98	24.75	-	400	2/pk

14	54820	1383 Auto/RV Reading	13	1.5	19.5	-	300	1/box
	54822	1383TF Auto/RV Reading §	13	1.5	20	-	300	1/box
	54823	1383TF Auto/RV Reading §	13	1.5	20	-	300	1/pk

§1383TF Bulbs are shatter-resistant

15	54706	20-99 RV Cosmetic Frosted	12	1.08	12.96	-	300	10/box
	54707	20-99 RV Cosmetic Frosted	12	1.08	12.96	-	300	1/pk
	54708	20-99 RV Cosmetic Clear	12	1.08	12.96	-	300	10/box
	54709	20-99 RV Cosmetic Clear	12	1.08	12.96	-	300	1/pk

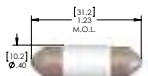
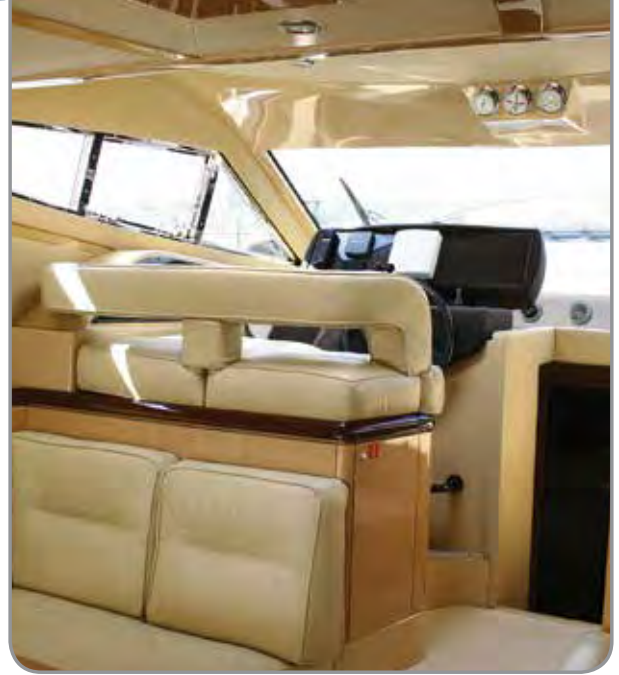

Figure 16

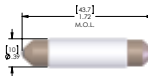

Figure 17



Figure 18



Figure 19



Figure 20

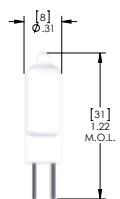

Figure 21

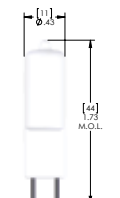

Figure 22

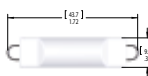
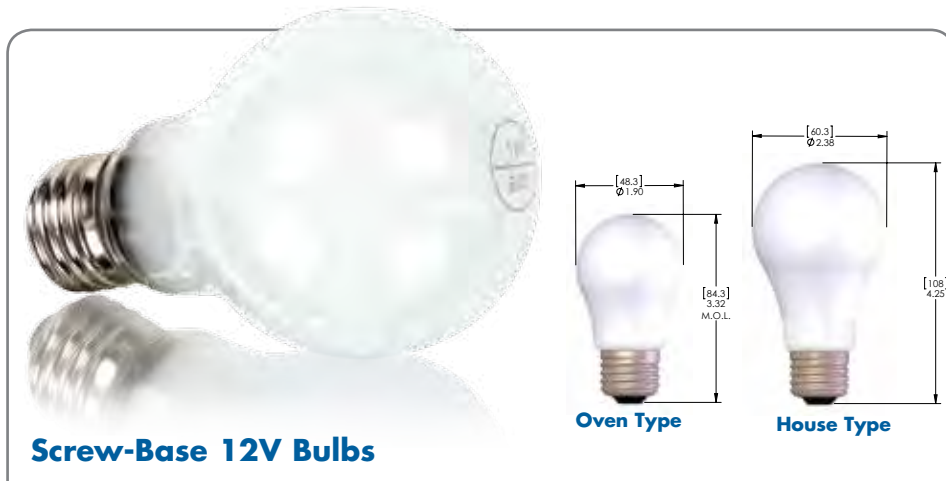

Figure 23

Fig #	Part #	Description	Design Voltage	Amps	Watts	Candle Power	Life Hours	Package
16	54858	3175 Auto Interior	12	.83	9.96	9.5	400	10/box
	54859	3175 Auto Interior	12	12	9.96	9.5	400	2/pk
17	54754	211-2 Auto Interior	12.8	.97	12.416	12	1000	10/box
	54755	211-2 Auto Interior	12.8	.97	12.416	12	1000	2/pk
	54756	212-2 Auto/Marine	13.5	.74	10	6	2000	10/box
	54757	212-2 Auto/Marine	13.5	.74	10	6	2000	2/pk
	54758	214-2 RV Refrigerator/Auto Interior	13.5	.52	7	4	1000	10/box
	54759	214-2 RV Refrigerator/Auto Interior	13.5	.52	7	4	1000	2/pk
18	54704	C7 1/2 Clear Patio Decor	120	0.56	7	3.2	3000	10/box
	54705	C7 1/2 Clear Patio Decor	120	0.56	7	3.2	3000	2/pk
19	54824	1414 Auto/RV	14	.46	6.44	6	500	10/box
	54825	1414 Auto/RV	14	.46	6.44	6	500	2/pk
	54827	1416 Marine	12.8	.8	10.24	8	1000	2/pk
20	54847	3057 Auto Park/Tail/Signal	12.8/14	2.1/0.48	26.8/6.7	32/2	1200/5000	2/pk
	54849	3057NA Auto Park/Tail/Signal	12.8/14	2.1/0.48	26.8/6.7	24/1.5	1200/5000	2/pk
	54850	3156 Auto	12.8	2.1	26.88	32	1200	10/box
	54854	3157 Auto Park/Tail/Signal	12.8/14.0	2.1/0.59	26.88/8.26	32/3	1200/5000	10/box
	54855	3157 Auto Park/Tail/Signal	12.8/14.0	2.1/0.59	26.88/8.26	32/3	1200/5000	2/pk
	54857	3157NA Auto Park/Tail/Signal	12.8/14.0	2.1/0.59	26.88/8.26	24/2.2	1200/5000	2/pk
21	54860	3357 Auto Tail, Stop, Signal	12.8/14	2.2/0.59	28.16/8.26	40/3	400/5000	10/box
	54702	JC-10 Halogen Fog/Driving	12	.83	9.96	9.5	2000	1/box
22	54703	JC-35 Halogen, 12V 35W	12	2.92	35	47.7	2000	1/box
23	54760	561 Dome Rigid Loop	12.8	1	12.8	12	1000	10/box



Screw-Base 12V Bulbs

Part #	Description	Package
54890	A-15 15W/12V Oven Type	1/pk
54871	A-19 75W/12V House Type	6/box
54873	A-19 100W/12V House Type	6/box
54892	A-19 25W/12V House Type	2/pk
54894	A-19 50W/12V House Type	2/pk



12V Fluorescent Bulb Fits standard screw-in socket. Perfect for use with solar-power panels. Save energy- 15W Fluorescent bulb delivers the lighting power of a 60W incandescent.

Part #	Package
41313	1/pk



Fluorescent Replacement Tubes

Part #	Description	Package
54877	LF15T8/CW 15 Watt - 18"	Bulk
54878	LF15T8/CW 15 Watt - 18"	2/pk
54879	LF8T5/CW 8 Watt - 12"	Bulk
54880	LF8T5/CW 8 Watt - 12"	2/pk
54881	LF13T5/CW 13 Watt - 21"	Bulk
54882	LF13T5/CW 13 Watt - 21"	2/pk
54896	LF4T5/CW 6 Watt - 6"	2/pk
54898	LF4T5/CW 6 Watt - 9"	2/pk

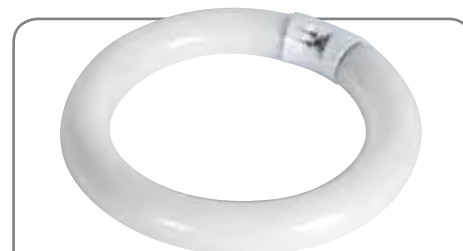

RV/Marine DC Fluorescent Replacement Tubes

22W, Cool-White, 4-pin style FC8T9 with circular tube. 12000 Life Hours.

Part #	Package
54875	Bulk
54876	1/pk



The No-Wiring Trailer Hook-Up.

Kit contains two style 1157 tow lights and four bullet connectors. Instructions included.

Part #	Description	Design Voltage	Amps	Watts	Candle Power	Life Hrs	Pkg
54700	Tow Light Kit	2.1	2.1	2.1	32	1200	1 kit



Sealed Beam Bulb

Part #	Description	Design Voltage	Amps	Watts	Candle Power	Life Hrs	Pkg
54870	Bulb 4411	12.8	2.73	34.94	-	300	1 kit



Miniature / Intermediate

	4" Length x .10" Width 1/16" to 7/8" Bundle Dia. 18 lb tensile strength		5.5" Length x .13" Width 1/16" to 1-1/4" Bundle Dia. 30 lb tensile strength		8.5" Length x .13" Width 1/16" to 2" Bundle Dia. 40 lb tensile strength		14.5" Length x .146" Width 1/16" to 4" Bundle Dia. 40 lb tensile strength	
	Natural	Black	Natural	Black	Natural	Black	Black	
25/Header Bag	64876	-	-	64885	64888	-	-	
100 count	64877	64880	64883	64886	-	64892	64896	



Standard

(50 lb tensile strength - .187" width)

	5.5" Length 1/16" to 1" Bundle Dia.		8" Length 1/16" to 1-3/4" Bundle Dia.		11.1" Length 1/16" to 3" Bundle Dia.		14.1" Length 1/16" to 4" Bundle Dia.	
	Natural	Black	Natural	Black	Natural	Black	Natural	Black
25/Header Bag	-	-	64904	64907	-	-	-	-
100 count	64899	-	64905	64908	64911	64914	64916	64918



Heavy Duty

(120 lb tensile strength)

Extra Heavy Duty

(175 lb tensile strength)

	8" Length - .30" width 3/16" to 2" Bundle Dia.		15" Length - .30" width 3/16" to 4" Bundle Dia.		36" Length - .30" width 3/16" to 9" Bundle Dia.		24" Length - .345" width 3/16" to 7.2" Bundle Dia.	
	Natural	Black	Natural	Black	Natural	Black	Natural	Black
100 count	64921	64924	64926	64928	-	-	64930	64932



Mounting Cable Ties

	6" L - .14" W - #8 Stud 1/16" to 1-1/4" Bundle Dia. 40 lb tensile strength		7.5" L - .185" W - #10 Stud 1/16" to 1-3/4" Bundle Dia. 50 lb tensile strength		11.1" L - .187" W - #10 Stud 1/16" to 3" Bundle Dia. 50 lb tensile strength		14.5" L - .187" W - #10 Stud 1/16" to 4" Bundle Dia. 50 lb tensile strength		14.5" L - .30" W - 1/4" Stud 1/16" to 4" Bundle Dia. 120 lb tensile strength	
	Natural	Black	Natural	Black	Natural	Black	Natural	Black	Natural	
25/Header Bag	-	-	64944	64947	-	-	-	-	-	
100 count	64939	64942	64945	64948	64951	64954	-	64960	64962	



Mounting Bases for Cable Ties

Molded nylon. Adhesive backed with screw mount.

	Natural
100 count	64966

A. Battery Boxes Lightweight, heavy duty corrosion-resistant polypropylene boxes are designed to secure and protect your battery. Both sizes include lift-off lid, durable woven hold-down strap, foot clamps and stainless steel screws. Choose small for group size 24 batteries or large for group sizes 27, 30 and 31. Both boxes meet USCG CFR 183.420 and ABYC E-010.7 specifications.

Inside dimensions with lid (l x w x h) Small: 11.33" x 7.84" x 9.9"; Large: 13.87" x 7.87" x 10.9". Patented.

55362 Standard

55372 Large

55364 Replacement Strap

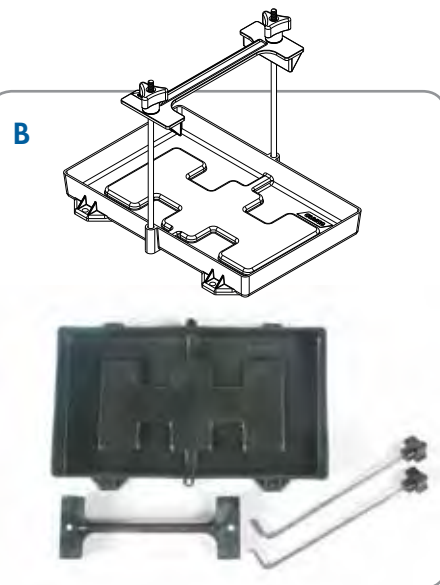

B. Battery Hold-Down Trays Made from heavy duty acid resistant plastic with stainless steel hardware. Meets U.S. Coast Guard CFR 183.420 and ABYC E-10.7 specifications. Patented.

55394 Standard

55404 Large

C. Shore Power Cords, 90° Locking

For shore power from your 30- or 50-Amp source. 90° connector reduces strain on the cord and allows easier connection in tight places. Threaded locking ring helps to create a weatherproof connection. Patent pending.

55532 30 F/M Locking Adapter, 18° 90°, L5-30P/L5-30R

55572 50 F/M Locking Adapter, 18° 90°, SS2-50P/SS2-50R



D. Electrical Cord Storage Handle

Carry and store power cords easily. Keeps your power cord neatly coiled, and makes it easier to carry.

55001 Cord Storage Handle



E. Coaxial Cable 75 ohm, 18 AWG center conductor cable for use with Satellite or cable TV and cable modems. Flat style for running through windows and doors.

64760 25 ft cable

64761 50 ft cable





A. Power Grip™ Adapters - 12" Marine Locking to Standard or Standard to Marine Locking

- B1 55635 15 Amp Male Standard / 30 Amp Female Locking - 5-15P / L5-30R
- B2 55616 30 Amp Male Locking / 15 Amp Female Standard - L5-30P / 5-15R

B. Power Grip™ Marine Locking Adapters - 12"

- 55625 50 Amp Male / 30 Amp Female SS2-50P / L5-30R (not shown)
- 55615 30 Amp Male to 50 Amp Female L5-30P / SS2-50R



B



A. Power Grip™ Marine Locking Adapters - 18" - 90°

55617 30 Amp Male / 30 Amp Female
L5-30P / L5-30R

55627 50 Amp Male / 50 Amp Female
SS2-50P / SS2-50R (not shown)

B. Power Grip™ Marine Locking Adapter Extension Cords - 30 Amp

B1 55611 30 Amp Male / 30 Amp Female - 25'
L5-30P / L5-30R

B2 55612 30 Amp Male / 30 Amp Female - 35'
L5-30P / L5-30R

B3 55613 30 Amp Male / 30 Amp Female - 50'
L5-30P / L5-30R

C. Power Grip™ Marine Locking Adapter Extension Cords - 50 Amp

C1 55620 50 Amp Male / 50 Amp Female - 12'
SS2-50P / SS2-50R

C2 55621 50 Amp Male / 50 Amp Female - 25'
SS2-50P / SS2-50R

C3 55623 50 Amp Male / 50 Amp Female - 50'
SS2-50P / SS2-50R



Featured products:



Kuuma Water Heaters



Catalytic Heaters



LP Accessories

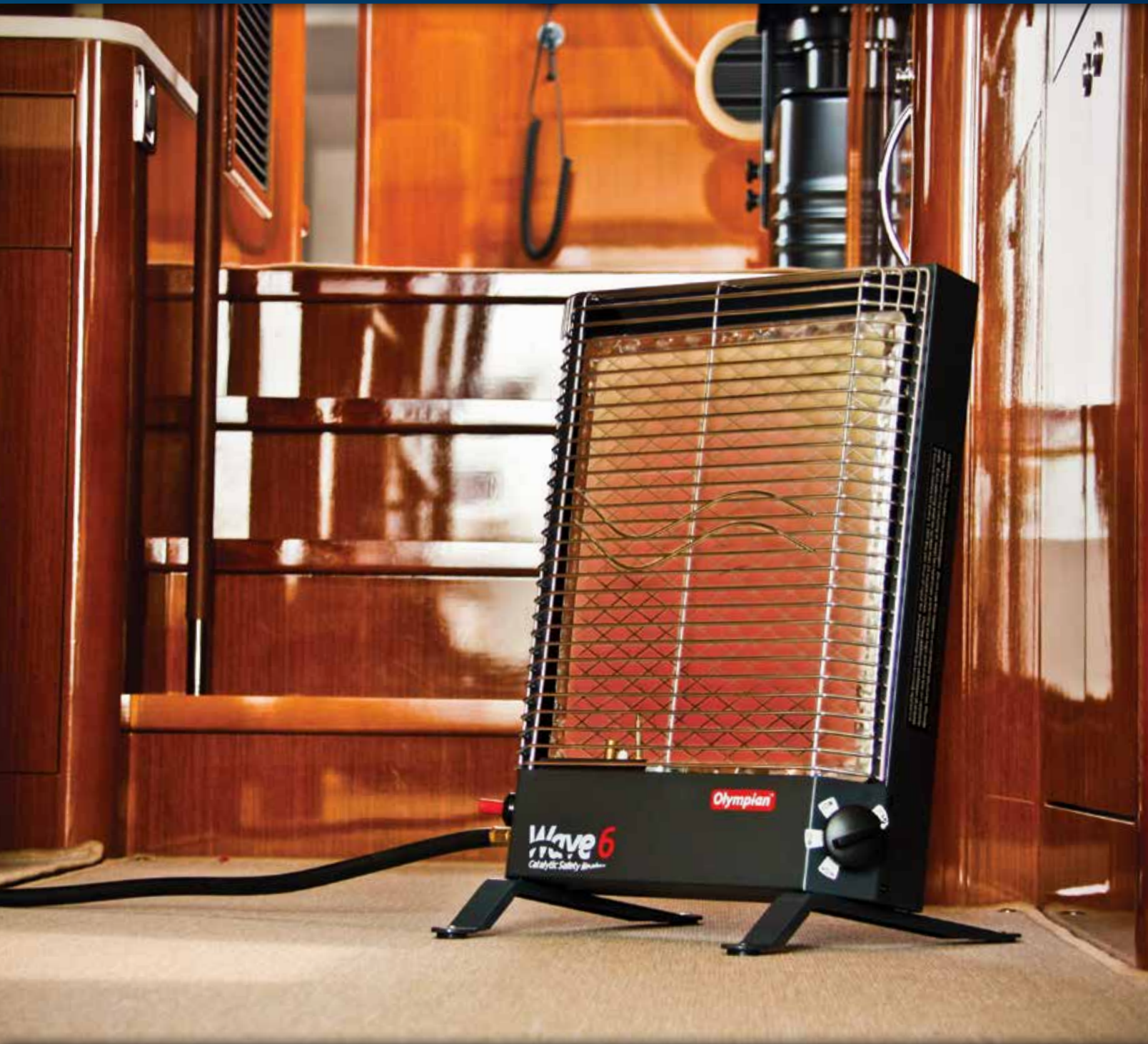

Appliances & LP Gas



PREMIUM WATER HEATERS

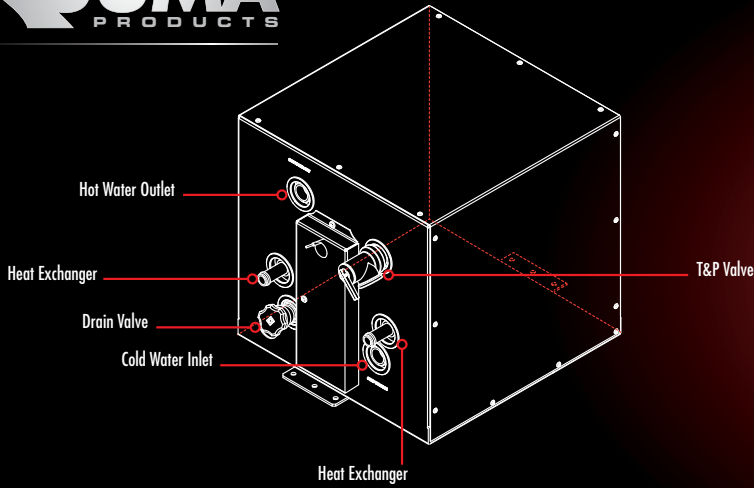

Marine-quality aluminum alloy case

The water heater of choice for many OEMs

ETL listed to UL 174

TIG welded



CHOOSING A WATER HEATER

1 SIZE

5
GALLON

6
GALLON

11
GALLON

20
GALLON
VERTICAL

2 MOUNT

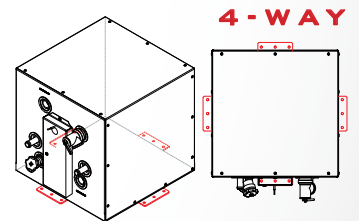
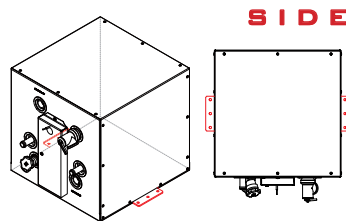
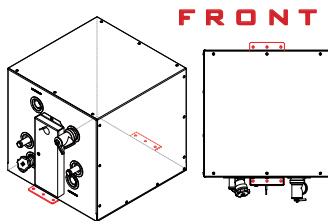

3 ELECTRICAL

120
US

240
US
L1 & L2

240
EU
L1N

4 HEAT EXCHANGE

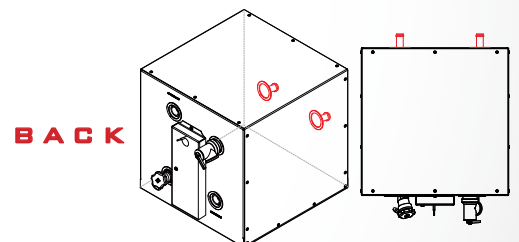
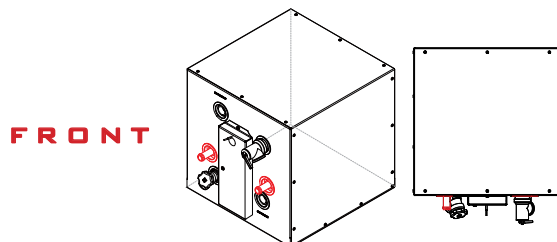

ITEM NUMBER	DIMENSIONS (IN) (WIDTH X HEIGHT X DEPTH)	MOUNT ARRANGEMENT	ELECTRICAL INPUT	WIRING CONFIGURATION	HEAT EXCHANGER POSITION/MATERIAL	T&P VALVE TYPE
-------------	---	-------------------	------------------	----------------------	----------------------------------	----------------

6 Gallon Capacity

11810	15.625x13.625x19.375	Side-Side	120V-60Hz/1500W	L1&N	Front/AL	150 psi & 210° F, CSA
11811	13.75x13.625x19.75	Front-Rear	120V-60Hz/1500W	L1&N	Front/AL	150 psi & 210° F, CSA
11812	13.75x13.625x19.75	Front-Rear	120V-60Hz/1500W	L1&N	Rear/AL	150 psi & 210° F, CSA
11820	15.625x13.625x19.375	Side-Side	240V-50Hz/1500W	L1&N	Front/AL	150 psi & 210° F, CSA
11821	13.75x13.625x19.75	Front-Rear	240V-50Hz/1500W	L1&N	Front/AL	150 psi & 210° F, CSA
11822	13.75x13.625x19.75	Front-Rear	240V-50Hz/1500W	L1&N	Rear/AL	150 psi & 210° F, CSA
11830	15.625x13.625x19.375	Side-Side	240V-60Hz/1500W	L1&L2	Front/AL	150 psi & 210° F, CSA
11831	13.75x13.625x19.75	Front-Rear	240V-60Hz/1500W	L1&L2	Front/AL	150 psi & 210° F, CSA
11832	13.75x13.625x19.75	Front-Rear	240V-60Hz/1500W	L1&L2	Rear/AL	150 psi & 210° F, CSA

11 Gallon Capacity

11840	18.875x16.25x21.625	Side-Side	120V-60Hz/1500W	L1&N	Front/AL	150 psi & 210° F, CSA
11841	16.25x16.25x23.25	Front-Rear	120V-60Hz/1500W	L1&N	Front/AL	150 psi & 210° F, CSA
11842	16.25x16.25x23.25	Front-Rear	120V-60Hz/1500W	L1&N	Rear/AL	150 psi & 210° F, CSA
11850	18.875x16.25x21.625	Side-Side	240V-50Hz/1500W	L1&N	Front/AL	150 psi & 210° F, CSA
11851	16.25x16.25x23.25	Front-Rear	240V-50Hz/1500W	L1&N	Front/AL	150 psi & 210° F, CSA
11852	16.25x16.25x23.25	Front-Rear	240V-50Hz/1500W	L1&N	Rear/AL	150 psi & 210° F, CSA
11860	18.875x16.25x21.625	Side-Side	240V-60Hz/1500W	L1&L2	Front/AL	150 psi & 210° F, CSA
11861	16.25x16.25x23.25	Front-Rear	240V-60Hz/1500W	L1&L2	Front/AL	150 psi & 210° F, CSA
11862	16.25x16.25x23.25	Front-Rear	240V-60Hz/1500W	L1&L2	Rear/AL	150 psi & 210° F, CSA

20 Gallon Capacity (Vertical)

11870	18.875x29.75x20.75	4-Way	120V-60Hz/1500W	L1&N	Front/AL	150 psi & 210° F, CSA
11880	18.875x29.75x20.75	4-Way	240V-50Hz/1500W	L1&N	Front/AL	150 psi & 210° F, CSA
11890	18.875x29.75x20.75	4-Way	240V-60Hz/1500W	L1&L2	Front/AL	150 psi & 210° F, CSA





Replacement Parts for Kuuma Water Heaters

A. Lime Life Elements Screw-in style elements with a 5-year limited warranty.

- 02152 1500W 240V Element
- 02858 1500W 120V Element (Straight)

B. Kuuma High-Temperature Limit Switches

- 11920 High-temp Limit Switch, 120V
- 11921 High-temp Limit Switch, 240V

C. Kuuma Thermostat

- 11930 T-stat for Kuuma Water Heater

D. Anode Rods for Kuuma water heaters. Anode rods extend the life of a water heater by attracting corrosive elements in the water, protecting your tank and elements from corrosion.

- 11916 Kuuma Anode Rod with drain
- 11919 Kuuma Anode Rod

E. Temperature and Pressure Relief Valve Corrosion-resistant metal T & P valves. Factory set at 150 PSI and crafted with no gaskets and epoxy-coated probes to prevent corrosion buildup.

- 10473 3/4" valve with 4" probe 12/ctn

F. Water Heater Drain Valve for Kuuma water heaters. Plastic, with 7/8" shank.

- 11943 Water Heater Drain Valve

A. Water Heater Drain Valves

Replace water heater valves with sturdy, easily-installed durable brass replacements.

- 11663 1/4" drain valve
- 11683 3/8" drain valve
- 11703 1/2" drain valve



B. Anode Rod with Drain Patented magnesium anode rod for aluminum water heaters (Atwood style) preserves the life of your water heater by corroding itself so your water heater tank doesn't. Replace your 1/2" pipe thread drain plug with the Camco Water Heater Anode Rod to extend the life of your boat's water heater. Internal drain valve allows you to drain your water heater without tools.

11533

C. Anode Rod Anode rods extend the life of a water heater by attracting corrosive elements in the water, protecting your tank and elements from corrosion. Patented.

- 11553 Magnesium rod for Atwood heaters
.50" dia. 4-1/2" long
- 11593 Magnesium - for 10-gal Atwood
1/2" NTP .60" dia. 9.5" long/Patented



D. Water Heater Drain Valve Wrench

Open or close stubborn water heater drain valves without scraping your knuckles. Heavy duty, high-impact plastic wrench has an adjustable handle that lets you get at hard-to-reach valves with leverage to loosen stubborn valves. Open handle allows hot water to flow to front of heater, preventing pooling.

11653



E. Universal T & P Valve Remover

Valve Remover gives you better access to the water heater housing, reducing injuries. Fits Atwood and Suburban (Mor-Flo) water heaters.

10552

F. Water Heater Continuity Tester

Test your water heater elements and circuits with ease.

10023 Tester



G. Professional Element Socket

Fits standard 1/2" socket drive for replacing screw-in water heater elements.

09951 Chrome-plated - bulk

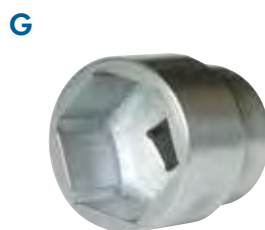

H. Element Wrenches Fits all standard screw-in elements and 1-1/2" nuts. Works with your screwdriver. Goes into offsets where an adjustable wrench can't.

- 09882 5" Screw-in Element Wrench, Bulk
- 09883 5" Screw-in Element Wrench, Card
- 09942 4" Screw-in Element Wrench, Bulk
- 09943 4" Screw-in Element Wrench, Card





A. Olympian™ Wave™ Catalytic Safety Heaters An ideal primary or secondary heating source. Wave™ heaters operate on low pressure LP gas, and can be wall mounted or used as portables. Equipped with an integral safety shut-off valve to prevent accidental non-ignition fuel discharge. The built-in automatic Piezo electric spark starter will last for 20,000 starts. No electrical drain or battery connection. Leg stands not included.

Refer to the chart to choose the correct size heater for your boat

- A1 **57331** Wave 3
Adjustable from 1600 to 3000 BTUs
- A2 **57341** Wave 6
Adjustable from 3200 to 6000 BTUs
- A3 **57351** Wave 8
Adjustable from 4200 to 8000 BTUs

B. Custom Fitted Dust Covers

- 57706 Wave 3 Dust Cover
- 57713 Wave 6 Dust Cover
- 57715 Wave 8 Dust Cover
- 57722 Wave 3 Dust Cover (portable)
- 57723 Wave 6 Dust Cover (portable)
- 57724 Wave 8 Dust Cover (portable)

C. Leg Stands for Wave Heaters

- 57701 Black, set of 2

D. 90° Connector Elbow 3/8" swivel flare female x with 3/8" flare male.

- 57633 Elbow with full 360° swivel

E. Propane Hose Assembly For use with an existing gas supply to connect an appliance equipped with a 3/8" male flare. 3/8" female flare x 3/8" female flare.

- 59913 3'

F. LP Gas Regulator with hose For use with all Olympian LP gas fired heaters.

- 57703 Regulator with 6' hose
- 57704 Regulator with 8' hose
- 57721 Regulator with 12' hose
- 59863 Regulator with 22" hose

B



C



D

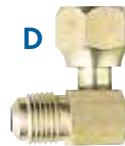

E

NEW



F



The Olympian™ Catalytic Heating Element

features a high porosity spongy texture which allows for perfect transport of the oxygen needed for combustion. The catalytic heating element is evenly impregnated with platinum, guaranteeing optimal oxidation of gas and elimination of the mix of dangerous gas emissions.

Platinum Catalytic heating system for all models

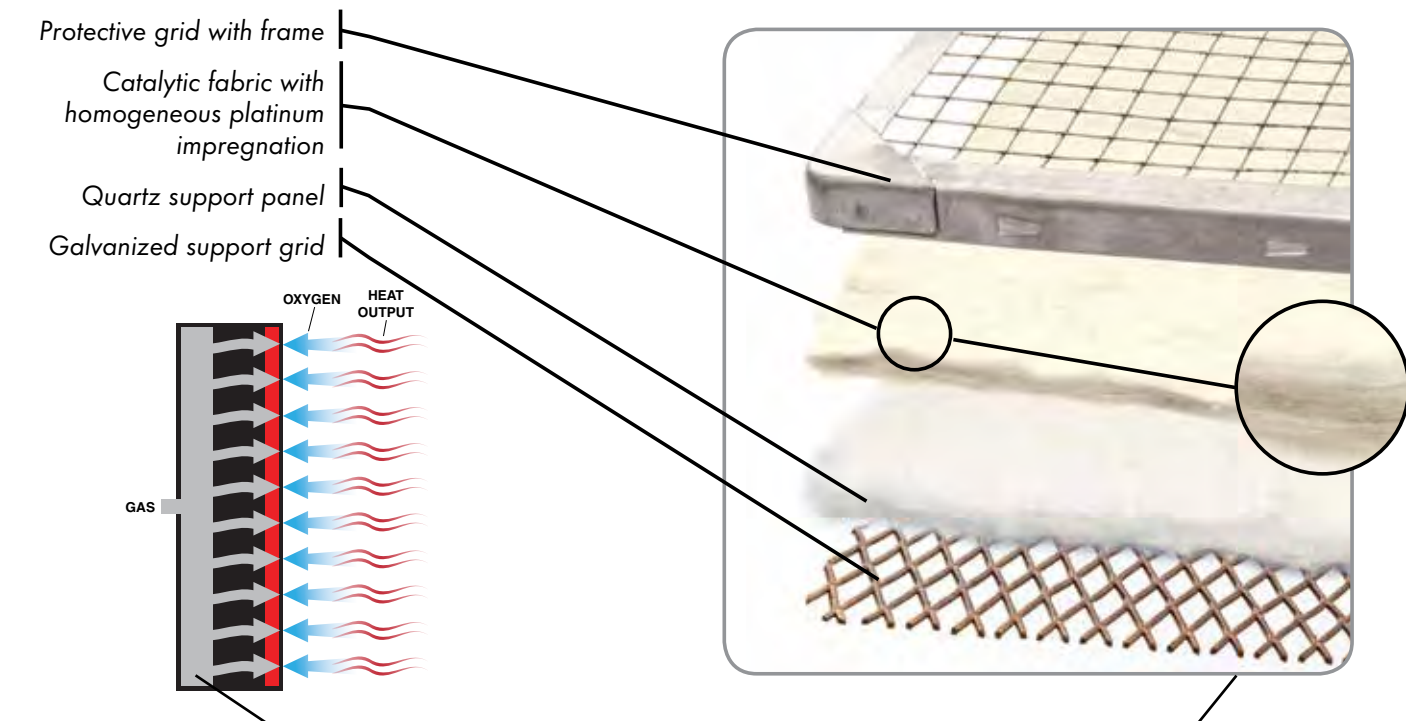

Olympian™ Platinum-saturated Catalytic Element

CHOOSE THE WAVE HEATER THAT'S RIGHT FOR YOU

	WAVE 3	WAVE 6	WAVE 8
Low pressure LP gas	•	•	•
BTU Output	1600 to 3000	3200 to 6000	4200 to 8000
Fuel Consumption at maximum output	1/8 lb/hr.	1/4 lb/hr.	1/3 lb/hr.
Gas Connection	3/8" SAE Flare	3/8" SAE Flare	3/8" SAE Flare
Height	11-3/4"	17-7/8"	21-1/4"
Width	10-1/4"	12-13/16"	15"
Depth	3-1/2"	4"	4"
Weight	6 lbs.	12 lbs.	14 lbs.
Typical RV Size*	up to 12'	up to 18'	up to 23'
Room Area Heated*	100 sq. ft.	200 sq. ft.	300 sq. ft.
Ignition	Piezo Spark	Piezo Spark	Piezo Spark
Vertical Wall Hung	•	•	•
Horizontal Wall Hung		•	•
Vertical Recessed		•	•
Horizontal Recessed		•	•
Portable Leg Stands	•	•	•
Warranty	3 year	3 year	3 year

*The heated areas depends greatly on insulation R-Factor and outside temperature. All "heated area" specifications were based on outside temperature of 35°F and R-Factor of 17.

A

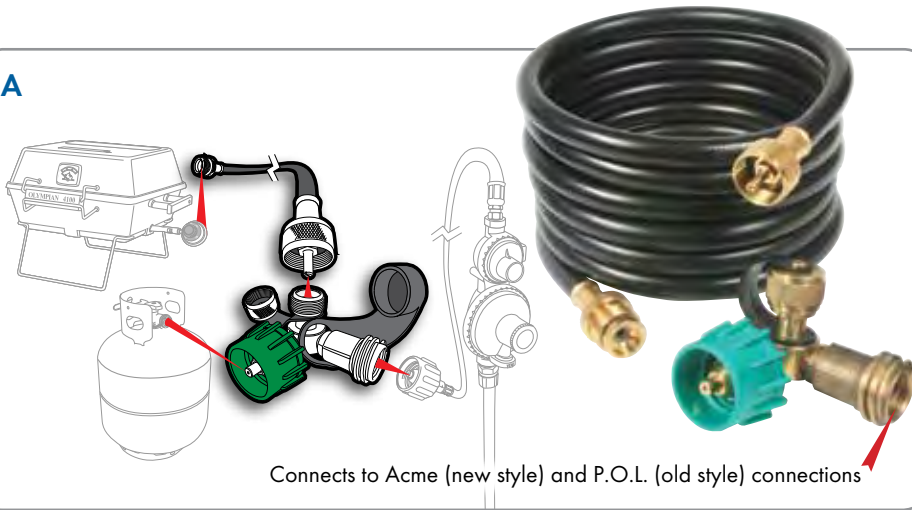

Connects to Acme (new style) and P.O.L. (old style) connections

A. 90° Propane Tee with 12'

Hose Connects to camper or trailer propane cylinder to allow connection of an additional propane appliance such as a tabletop grill, campstove or lantern. Provides thermal protection in case of fire and excess flow protection in case of broken gas line. Includes propane tee (Type 1 Acme nut x female P.O.L. and male acme thread x 1"-20 male throwaway cylinder thread) and 12 ft. extension hose with male x female swivel 1"-20 female throwaway cylinder threads.

- 59143 90° Tee and Hose Kit
- 59133 90° Tee only
- 59043 12' Extension/Replacement hose
- 59045 5' Extension/Replacement Hose

B

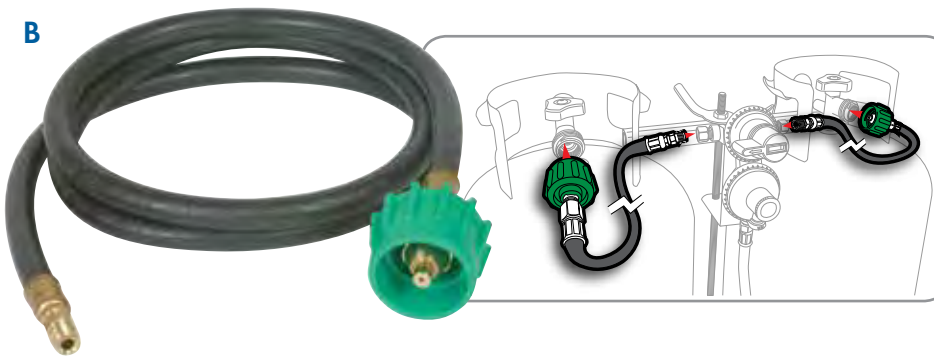

B. Pigtail Propane Hose Connectors with Male Inverted Flare

For connecting propane cylinder to boat, RV or trailer propane regulator. Rated for 200,000 BTUs per hour. Provides thermal protection in case of fire and excess flow protection in case of broken gas line. Type 1 ACME nut x 1/4" inverted male flare.

- 59053 12" Pigtail Connector
- 59065 15" Pigtail Connector
- 59073 20" Pigtail Connector
- 59153 24" Pigtail Connector
- 59163 30" Pigtail Connector
- 59173 36" Pigtail Connector
- 59183 48" Pigtail Connector
- 59193 60" Pigtail Connector

C



C. Propane Hose Assembly

High-pressure hose with easy-grip Acme nut for connecting an appliance designed to use a 1 lb disposable cylinder to a 20- or 30-lb refillable propane tank. Provides thermal protection in case of fire and excess flow protection in case of broken gas line.

- 59823 5'
- 59825 12'

D

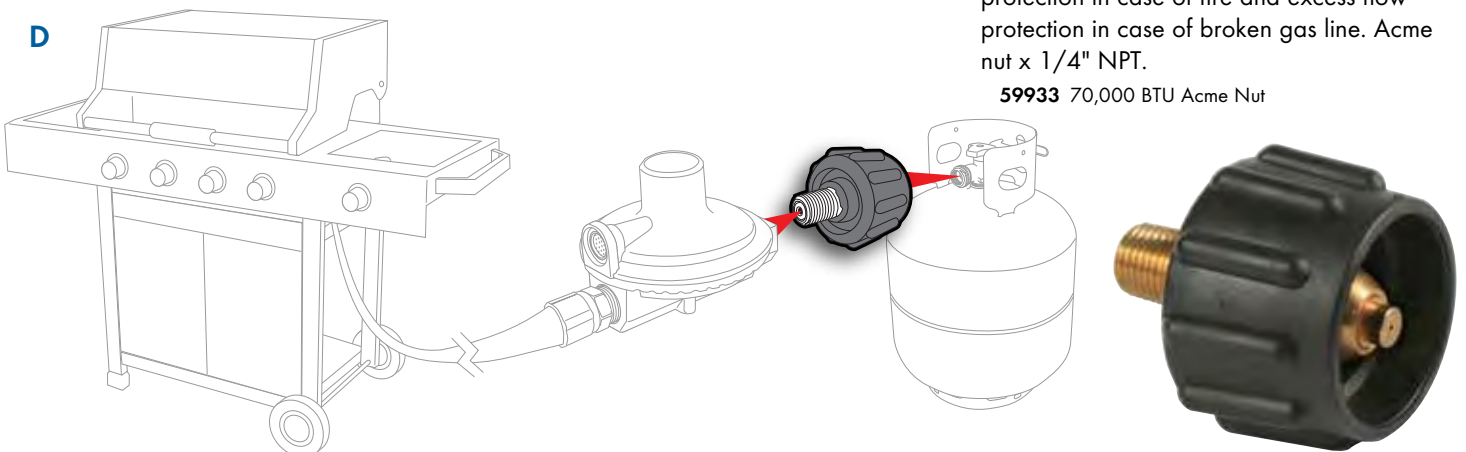

D. Black Propane Grill Acme Nut

70,000 BTU/hour. For use on a 20- or 30-lb refillable propane tank to connect to a regulator/hose assembly. Provides thermal protection in case of fire and excess flow protection in case of broken gas line. Acme nut x 1/4" NPT.

- 59933 70,000 BTU Acme Nut

A. Green Propane Acme Nut

200,000 BTU/hour. For use on a 20- or 30-lb refillable propane tank to connect to a regulator/hose assembly. Provides thermal protection in case of fire and excess flow protection in case of broken gas line. Acme nut x 1/4" NPT.

59923 200,000 BTU Acme Nut

B. Single Stage Propane Regulator

For connecting a free-standing gas bottle to a grill or other low-pressure gas appliance. Maintains a constant 11" w.c. propane pressure. 200,000 BTU/HR.

59013 Single Stage Regulator

C. Two Stage Propane Regulator

Integral first and second stages ensure a smoother, more consistent flow of gas to all appliances. CSA Listed. Inlet: 1/4" NPT. Outlet: 3/8" NPT. Outlet pressure: 11" WC. BTU Capacity (propane): 160,000 BTU/HR.

C1 59313 Vertical

C2 59323 Horizontal

C3 59333 Horizontal with P.O.L.

C4 59344 Covers for Two Stage Regulators (set of 2)

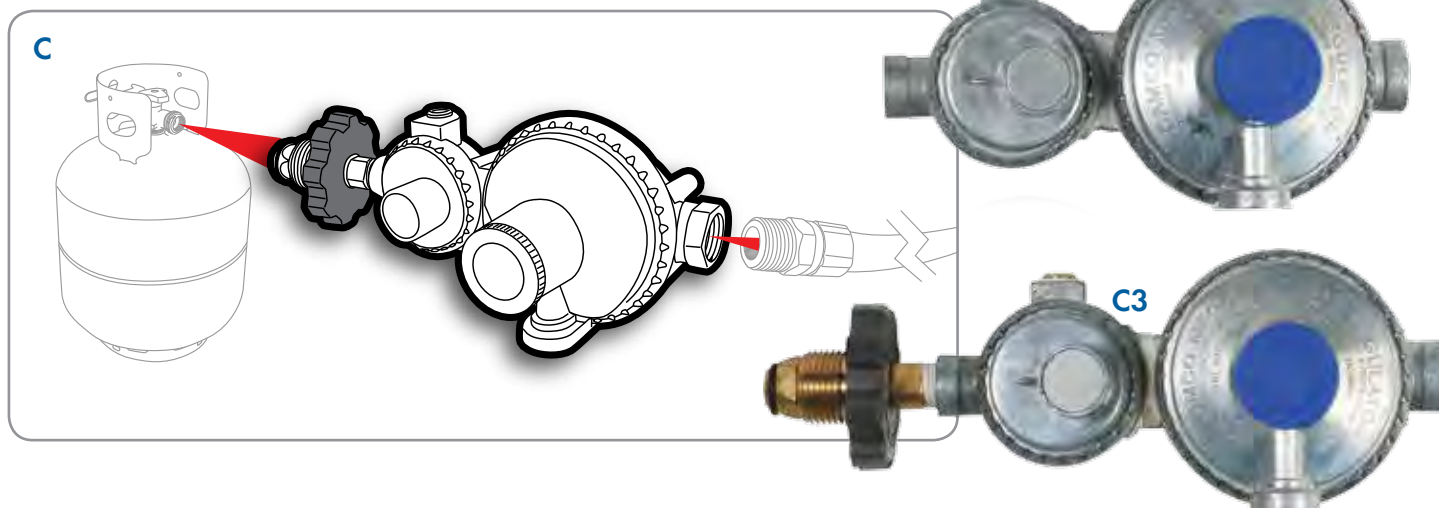
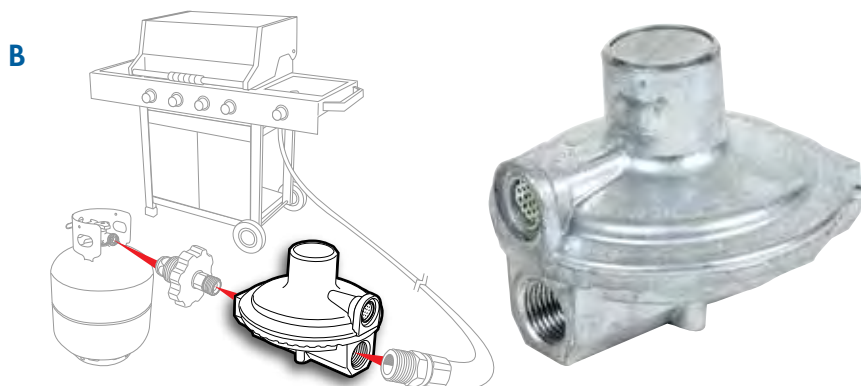
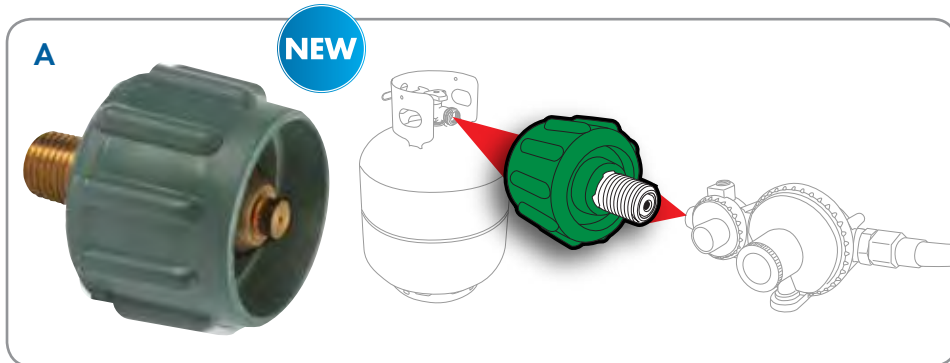

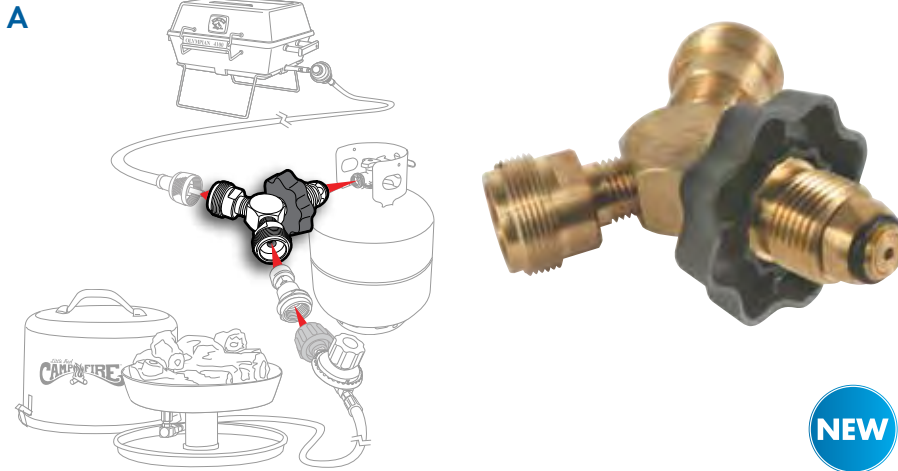

A. Propane Y-Adapter with Handwheel For use on a 20- or 30-lb refillable propane tank. Allows you to operate two appliances such as a Campfire and a grill at once from the same cylinder. Provides excess flow protection in case of broken gas line. Male Soft-Nose P.O.L. x Two 1"-20 Male Throwaway Cylinder Thread Connections.

59893 Propane Y Adapter

NEW

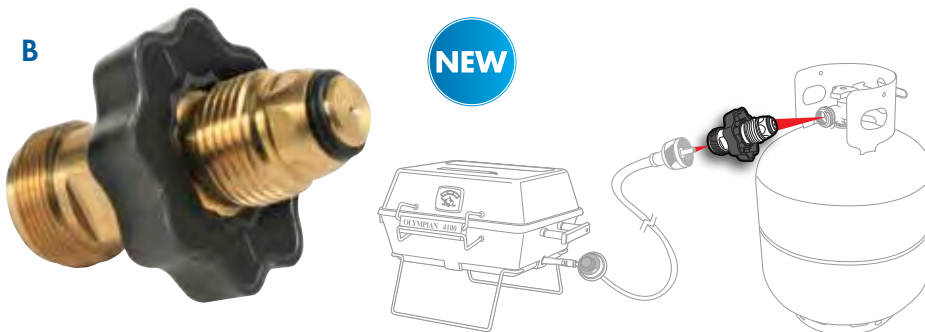

B. Propane Cylinder Adapter

For use with any appliance designed to use a 1-lb throwaway cylinder. With this handy adapter, you can power your small LP appliance directly from a 20- or 30-lb refillable tank. Provides excess flow protection in case of broken gas line. Soft Nose P.O.L. x 1"-20 Male Throwaway Cylinder Thread.

59943 Propane Cylinder Adapter

NEW

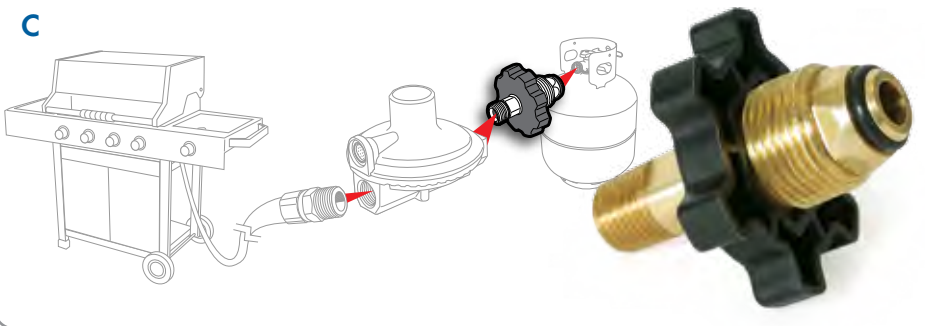

C. P.O.L. Plug Adapter For use on a 20- or 30-lb refillable tank to connect cylinder to regulator. Converts 1/4" NPT to female P.O.L. Provides excess flow protection in case of broken gas line. Soft Nose P.O.L. x 1/4" Male NPT.

59203 P.O.L. Plug Adapter

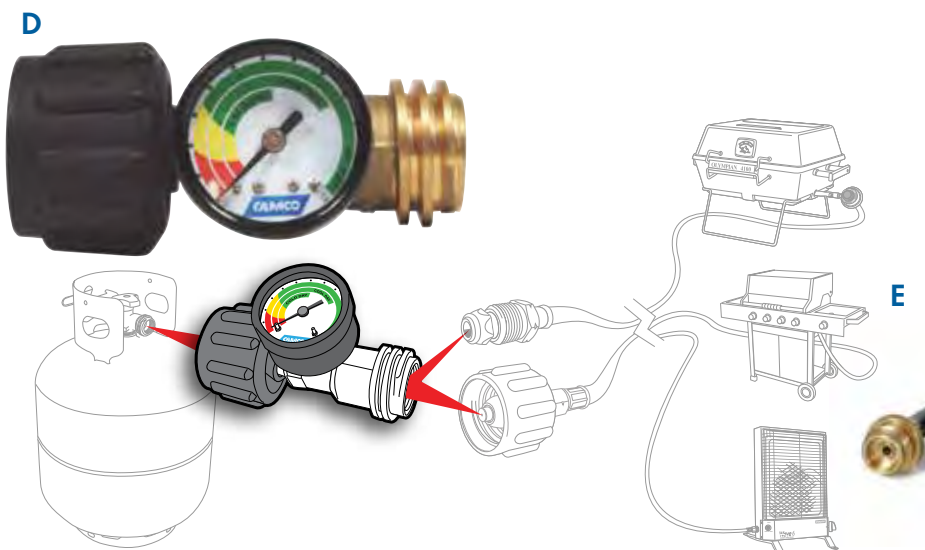

D. Gas Gauge/Leak Detector See at a glance when your propane level is low. Type 1 for gas grills, RVs and boats. Fits all propane tanks manufactured after 1995. Provides thermal protection in case of fire and excess flow protection in case of broken gas line. Acme Nut x Acme Thread and Female P.O.L.

59023 Gas Leak Detector

E. Barbecue Adapter Hose No more disposable cylinders. High-pressure hose with adapter for use with Olympian 4100 and 5100 Elite Gas Grills. Male P.O.L. x 1"-20 Throwaway Cylinder Thread. Allows you to connect a full size propane gas bottle to your portable grill.

57636 5' High-Pressure LP Hose

59833 12' High-Pressure LP Hose



A. Little Red Campfire™ Take your fire with you! Our compact, portable campfire is great for campsites with restrictions against in-ground fires. Take it tailgating, or put it on the patio...its size is convenient for wherever you need a fire. Realistic log pieces and full 9.5" diameter ring burner help create the natural look and ambiance of from-scratch campfires. Sturdy lid and security latches make it safe and easy to transport. Includes 8' propane hose for use with standard LP gas cylinders. 11.25" fire tray diameter. 65,000 BTU/HR.

- 58031 Little Red Campfire™
- Replacement Parts for Little Red Campfire™
- 58032 Replacement Log set
- 58034 Replacement Hose w/Regulator

B. Little Red Campfire™ Cook Top

Now you can cook with your Little Red Campfire. Unfold the legs of the Little Red Campfire Cook Top to create a cooking platform for pots and pans at the perfect height. Legs fold for convenient storage in the included bag.

- 58033 Campfire Cook Top

C. Campfire Propane Adapter

Safely and easily installs to one of Camco's propane connection kits (59103, 59123 or 59143) to use the onboard propane supply to fuel your Campfire. Can also be used to convert any appliance from a Type I ACME to a 1"-20 Throwaway connection for use with a disposable 1-lb bottle of LP Gas.

- 59213 Propane Adapter

D. Female Quick-Connect x Throwaway Propane Hose with Stabilizing Base

Hook up a quick-connect grill valve to a 1-lb throwaway propane cylinder or propane accessory tee. Includes cylinder base and six-foot regulator hose with shut-off valve. Designed to be used only with low-pressure gas appliances (i.e. less than 14" w.c.) such as our 5500 Grill. Gas bottle not included.

- 57628 1 lb Throwaway Cylinder Adapter Kit



Featured products:



Kuuma Elite Grills



Fillet Tables



**Grill Covers
Grill Mounts**



Kuuma grills are designed for use on boats and built to withstand harsh marine environments, but are also perfect for RVing, tailgating and patio or deck grilling. All Kuuma Grills are constructed of high-quality stainless steel and come fully assembled. Integrated fold-away legs enable easy grilling on any flat surface. Stow N' Go Grills feature a stay-cool handle, and they can be mounted to any Kuuma rail-, rod- or pedestal mount. Kuuma Grills are outstanding products that offer premium-quality construction and convenient portability.



KUUMATM
PRODUCTS

Grilling



ELITE

316

PREMIUM STAINLESS STEEL GRILL

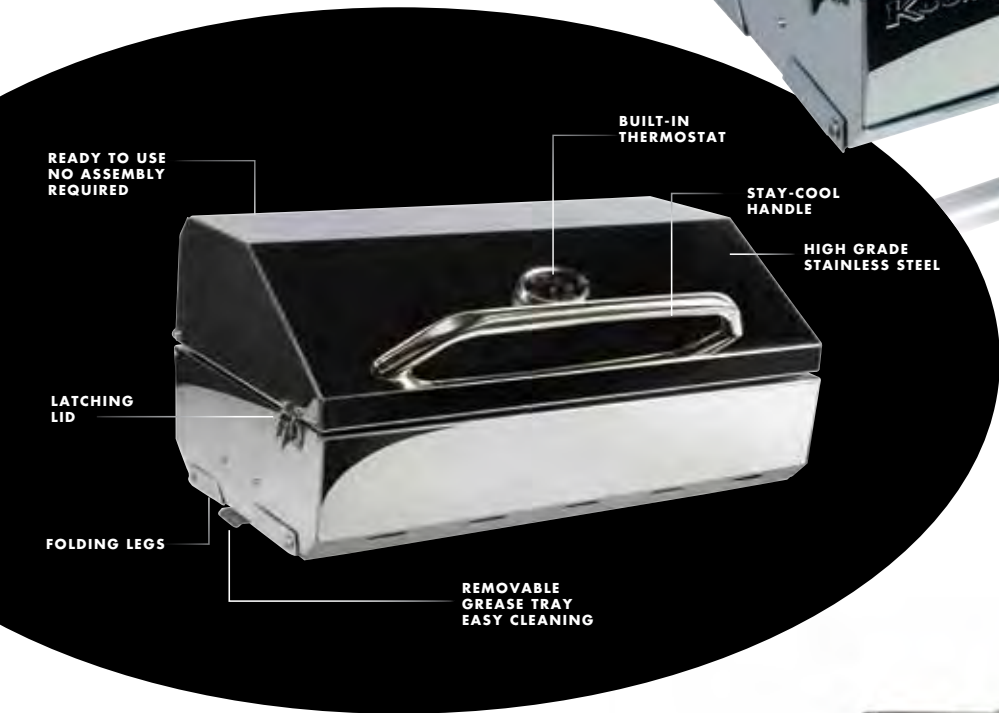

READY TO USE
NO ASSEMBLY
REQUIRED

BUILT-IN
THERMOSTAT

STAY-COOL
HANDLE

HIGH GRADE
STAINLESS STEEL

LATCHING
LID

FOLDING LEGS

REMOVABLE
GREASE TRAY
EASY CLEANING

The Kuuma Elite 316 Grill is a premium grill with all of Kuuma's features, ideal for the grilling enthusiast. The Elite 316 Grill features a simple control knob for precise heat control. Integrated fold-away legs enable easy grilling on any flat surface. Also features a removable warming rack, built-in thermometer, piezo igniter, removable Lift-and-Clean™ liner, grease tray, latching lid and stay-cool handle.

58173 Elite 316 Gas



316 Elite Gas with Regulator

Part Number: 58173

Dimensions: 27" x 15" x 13"

Cooking Surface Area: 316 Square Inches

1"-20 Throwaway Cylinder Threads

Designed for high pressure propane - disposable or larger refillable tanks



WARMING RACK



ELITE

216

PREMIUM STAINLESS STEEL GRILL



The Kuuma Elite 216 Grill is a more compact size grill with all the premium features of the Elite 316; simple control knob, integrated fold-away legs, removable warming rack, built-in thermometer, piezo igniter, removable Lift-and-Clean™ liner, grease tray, latching lid and stay-cool handle.

58155 Elite 216 Gas

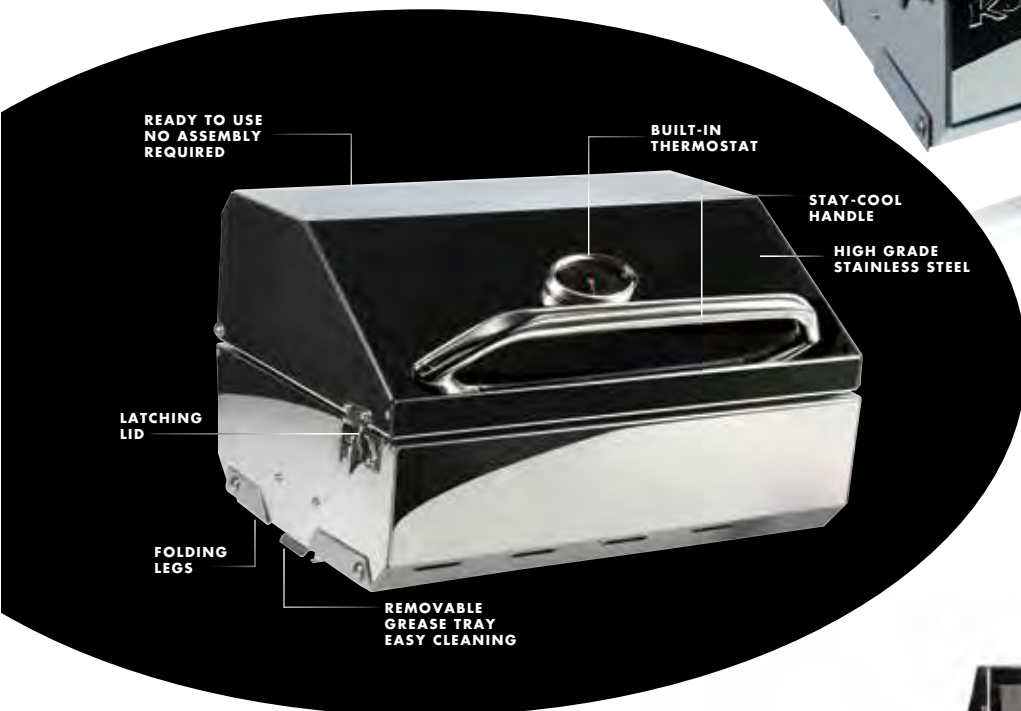

216 Elite Gas with Regulator

Part Number: 58155

Dimensions: 22" x 15" x 13"

Cooking Surface Area: 216 Square Inches

1"-20 Throwaway Cylinder Threads

Designed for high pressure propane - disposable or larger refillable tanks



STOW N' GO

160

PREMIUM STAINLESS STEEL GRILL



The Kuuma Stow N' Go 160 Grill is an outstanding grill that offers premium-quality construction and convenient portability. Stow N' Go grills can be easily transported and can also be mounted to any Kuuma rail-, rod- or pedestal mount for your boat, RV or home.

- 58110** 160 Charcoal
- 58130** 160 Gas
- 58131** 160 Gas/thermometer & igniter
- 58133** 160 Gas with LPV

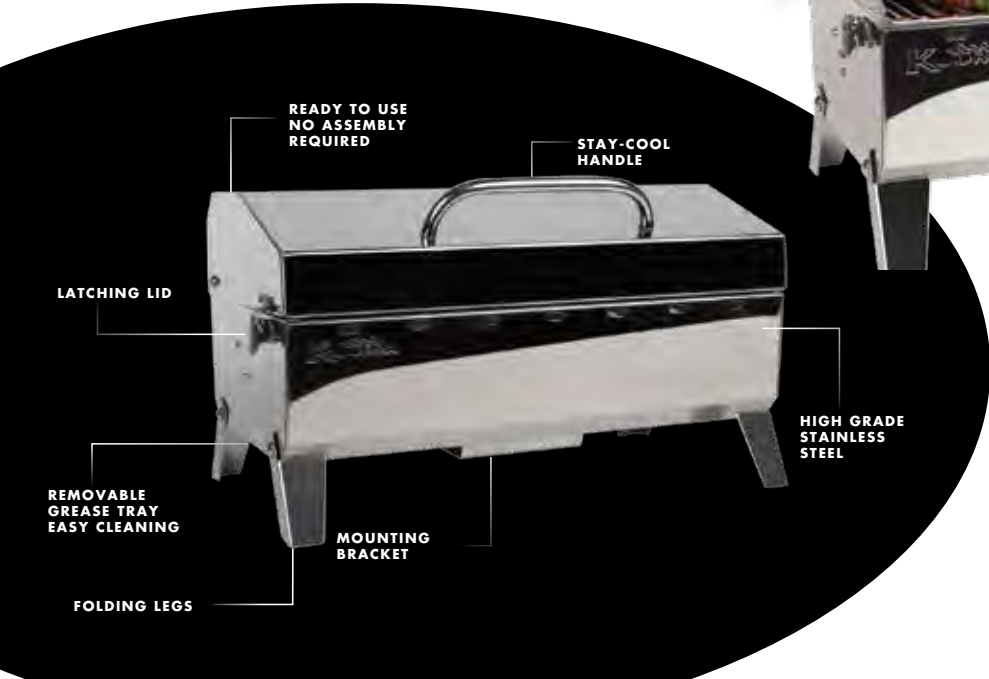

- READY TO USE
NO ASSEMBLY
REQUIRED
- STAY-COOL
HANDLE
- LATCHING LID
- HIGH GRADE
STAINLESS
STEEL
- REMOVABLE
GREASE TRAY
EASY CLEANING
- MOUNTING
BRACKET
- FOLDING LEGS

FOUR MODELS AVAILABLE:



Charcoal

Uses any standard charcoal. Includes inner lid liner to help protect cover from high-heat discoloration.

Stow N' Go 160 Charcoal
 Part Number: 58110
 Dimensions: 18.5" x 11.25" x 11"
 Cooking Surface Area: 160 Square Inches



1"-20 Throwaway Cylinder Threads

Designed for high pressure propane - disposable or larger refillable tanks

Stow N' Go 160 Gas with Regulator
 Part Number: 58130
 Dimensions: 23.25" x 11.25" x 11"
 Cooking Surface Area: 160 Square Inches



1"-20 Throwaway Cylinder Threads

Designed for high pressure propane - disposable or larger refillable tanks

Stow N' Go 160 Gas with Regulator, Thermometer and Igniter
 Part Number: 58131
 Dimensions: 23.25" x 11.25" x 11"
 Cooking Surface Area: 160 Square Inches



3/8 inch Male Flare Connection

Designed for use with regulated on-board low-pressure propane systems

Stow N' Go 160 Gas with Low Pressure Connection
 Part Number: 58133
 Dimensions: 23.5" x 11.25" x 11"
 Cooking Surface Area: 160 Square Inches

STOW N' GO

125

PREMIUM STAINLESS STEEL GRILL

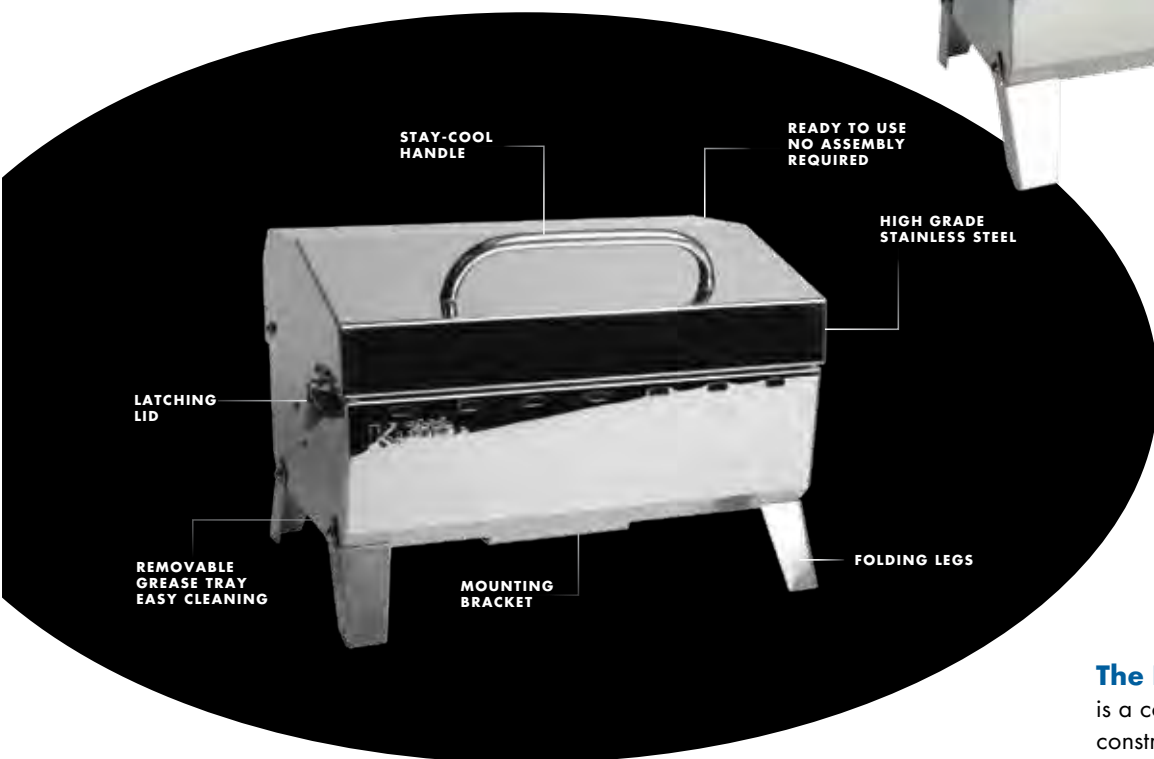

The Kuuma Stow N' Go 125 Grill

is a compact grill that offers premium-quality construction and convenient portability. Its compact size is perfect for when space is at a premium. Stow N' Go grills can be easily transported and can also be mounted to any Kuuma rail-, rod- or pedestal mount.

- 58140 125 Gas
- 58141 125 Gas with LPV

TWO MODELS AVAILABLE:



Stow N' Go 125 Gas with Regulator
 Part Number: 58140
 Dimensions: 19.75" x 11.25" x 11"
 Cooking Surface Area: 125 Square Inches

1"-20 Throwaway Cylinder Threads

Designed for high pressure propane - disposable or larger refillable tanks



Stow N' Go 125 Gas with Low Pressure Connection
 Part Number: 58141
 Dimensions: 20" x 11.25" x 11"
 Cooking Surface Area: 125 Square Inches

3/8 inch Male Flare Connection

Designed for use with regulated on-board low-pressure propane systems

216

PREMIUM STAINLESS STEEL GRILL



The Kuuma Profile 216 Grill is the perfect portable grill for the chef with limited storage space, but needs maximum grilling area. Its compact size is optimal for when space is at a premium. Profile grills can be easily transported and can also be mounted to any Kuuma rail-, rod- or pedestal mount.

58161 Profile 216 Gas

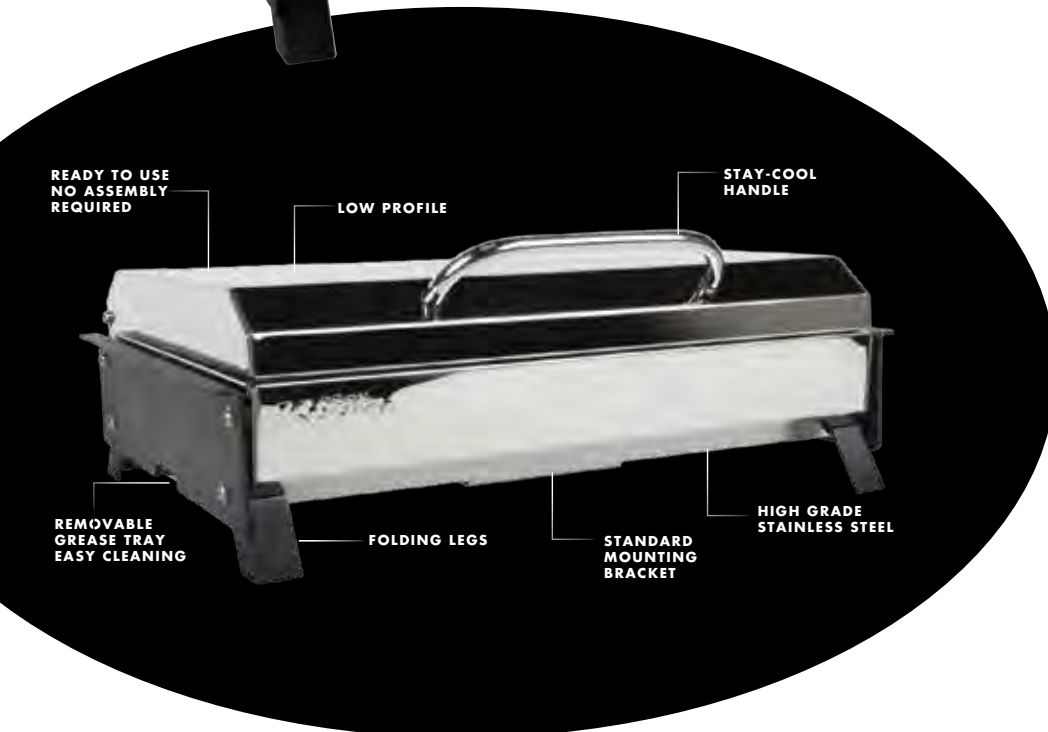

Profile 216 Gas with Regulator

Part Number: 58161

Dimensions: 24" x 12" x 8"

Cooking Surface Area: 180 Square Inches

1"-20 Throwaway Cylinder Threads

Designed for high pressure propane - disposable or larger refillable tanks



PROFILE

150

PREMIUM STAINLESS STEEL GRILL

The Kuuma Profile 150 Grill is the perfect portable grill for the chef with limited storage space. Its compact size is optimal for when space is at a premium. Profile grills can be easily transported and can also be mounted to any Kuuma rail-, rod- or pedestal mount.

58120 Profile 150 Electric

58121 Profile 150 Gas



READY TO USE
NO ASSEMBLY
REQUIRED

LOW PROFILE

STAY-COOL
HANDLE

REMOVABLE
GREASE TRAY
EASY CLEANING

FOLDING LEGS

STANDARD
MOUNTING
BRACKET

HIGH GRADE
STAINLESS STEEL



TWO MODELS AVAILABLE:



Profile 150 Electric

Part Number: 58120

Dimensions: 22" x 12" x 8"

Cooking Surface Area: 145 Square Inches

Electric, 110V, 15 AMP Circuit

700°F + on cooking surface
Designed for standard 120V electrical outlet



Profile 150 Gas with Regulator

Part Number: 58121

Dimensions: 24" x 12" x 8"

Cooking Surface Area: 145 Square Inches

1"-20 Throwaway Cylinder Threads

Designed for high pressure propane -
disposable or larger refillable tanks



A

A. Food Tray for Profile grills. Hooks onto the front of Profile grills to provide a convenient work surface. 18.25"x8".

58230 Food Tray for Profile Grill



B. Food Tray for Stow N' Go 125. Provide a convenient place to put your food while grilling. Slide the tray over the front lip of your grill to attach; slide off for storage. 6.75 x 12.13 x 1.5 inch size.

58231 Food Tray for Stow N' Go 125

C. Food Tray with hooks for Stow N' Go 160, 216 and 316. The perfect companion for your grill, providing a convenient place to put your food while grilling. Utensil hooks on the side of the tray provide a handy place for grilling tools. 17" x 6" x 1.5".

58233 Food Tray with hooks for Stow N' Go 160, 216, 316



B



B

6.75" x 12.13" x 1.5"



C



C

17" x 6" x 1.5"



Kuuma Fillet Tables Designed for use with Kuuma rail grill mounts. Perfect for filleting while at sea. Features a large drainage area and slots for filleting utensils. Flush cutting surface—Easy to clean. Easy assembly and installation—requires Kuuma grill mount, sold separately.

58400 20" Fillet Table

58405 30" Fillet Table



Attaches to rail with Kuuma Grill Mount; not included.

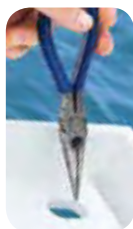

Flush cutting surface—Easy to clean



Easy assembly & installation—Requires Kuuma Grill Mount, sold separately

Slots for filleting utensils

Large drainage area

Slots for filleting utensils



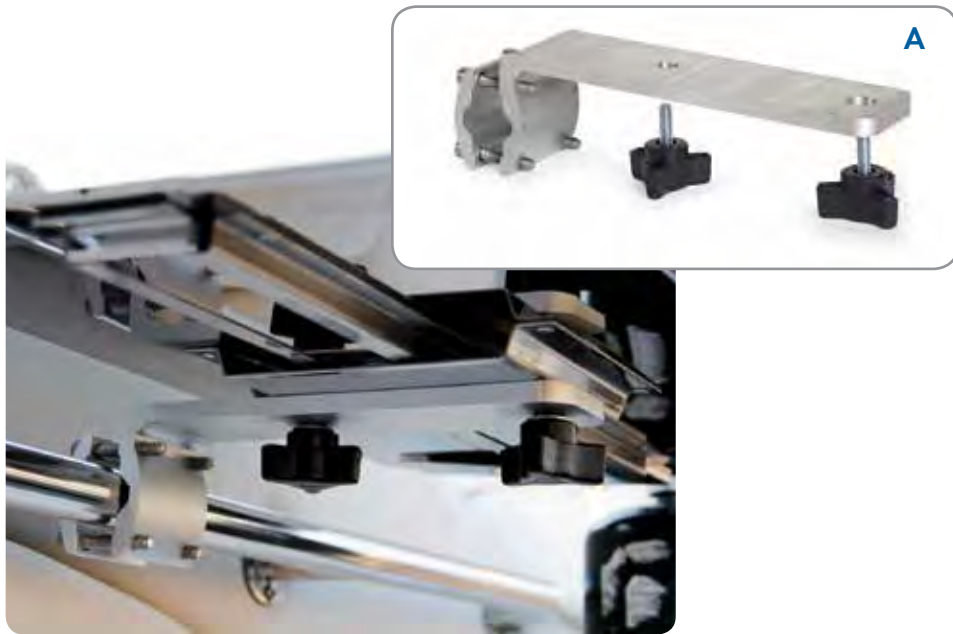

A. Rail Grill Mounts Designed to mount your Kuuma grill to your boat's railing. Made of anodized aluminum, with stainless steel hardware. For use with $\frac{7}{8}$ - to $1\frac{1}{4}$ -inch horizontal round or square rail. Inboard/outboard style mount is designed to allow your grill to hang outside the rail, helping to protect fiberglass from spills and splatters.

58182 Inboard/Outboard Rail Mount

B. Rod Holder Mount Works with most 60° rod holders with cross pins. Kuuma's rod holder mount enables you to turn any fishing rod holder into a grill mount. The rod holder mount has a 60-degree angle and an adjustable height. Made of anodized aluminum, with stainless steel hardware.

58180 60 Degree Rod Holder Mount



C. Universal Rail Grill Mount The Universal Rail Mount solves many standard mounting problems. Allows you to mount and level your Kuuma grill on any angle rail from vertical to horizontal. Works with $\frac{7}{8}$ - to $1\frac{1}{4}$ -inch square or round rails. Made of anodized aluminum with stainless steel hardware.

58183 Universal Single Axis Rail Mount



A. RV Grill Mount is designed to mount your grill to the existing RV Mounting Rail. Thumbscrews make the mount easy to install. Rubber feet help prevent scratches. Fits Olympian 5500 (2014 and later), and Olympian 3500-C, 4500 and 6500, and all Kuuma Brand Grills. Made of durable stainless steel and anodized aluminum for a lasting finish.

58090 RV Grill Mount

B. Pedestal Grill Mount Includes pedestal, hardware and base ring. Fits all Kuuma Grills. The perfect way to mount your Kuuma grill in stationary locations such as a dock, deck, swim platform or patio. 30" tall. Additional base rings sold separately for multiple mounting locations. The optional Floor Base allows use of the Pedestal Mount in locations where drilling to install a base ring is not possible.

B1 58184 Pedestal Mount

B2 58261 Mounting Ring

B3 58260 Pedestal Floor Base

A



B1



B2

B3





A. Kuuma Apron protects clothing from splatters. Wrap-around design with adjustable neck strap and back ties fits nearly everyone. Three roomy pockets to hold barbecue tools. Durable black cotton/polyester blend fabric with embroidered Kuuma Logo. 30" long.

58313 Kuuma Apron

B. Kuuma Towel Absorbent black 100% cotton hand towel with embroidered Kuuma logo. Towel has a sturdy metal grommet and includes a metal hanging ring. Generous 15½ x 23½ inch size.

58312 Kuuma Towel

C. Kuuma Grill Cover/Totes For use on a mounted grill as a cover or a portable grill as a tote. Heavy-duty weather resistant acrylic provides long lasting protection in every storage environment.

C1 58300 Cover for 125, 150, 160

C2 58303 Cover for 216, 316





A. Kuuma Cast Aluminum Griddle

with built-in handles. Two-sided for smooth or raised-rib surface. For use with all Kuuma brand grills. Reversible. 16" x 8".

58390 Cast Aluminum Griddle



A



B. Cast Iron Griddle

with stainless steel handles. Two-sided for smooth or raised-rib surface. For use with all Kuuma brand grills. Reversible. 12.5" x 8.25".

58200 Cast Iron Griddle



B



C. Premium Fish & Veggie Grill Tray

with removable handle. Dishwasher-safe stainless-steel tray is perfect for delicate foods. Handle can be attached on any side of tray. Fits all Kuuma brand grills. 8" x 10".

58380 Fish/Veggie Tray

D. Skewer Set

Set of four 18 inch long skewers. Square shaft keeps food from slipping when the skewers are turned on the grill. Ring handle for easy turning, and to hang on grilling table or tray. Stainless steel.

58384 Skewers - Set of 4



C



D



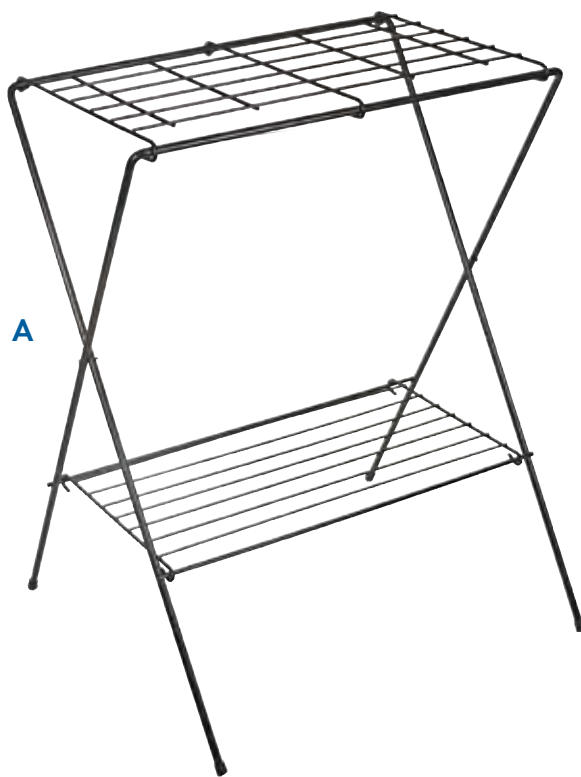

A

A. Folding Grill Stand Use with the 4100 Grill or other appliances. Steel stand folds flat for storage. Powder coated for rust resistance. 14" x 20" x 28". Black.

57321 Universal BBQ Stand

B. Deluxe Folding Grill Table

Spacious grill table has a lightweight, high strength steel frame and aluminum table top. Quick and easy to set up. Great for picnics, camping, sporting events and backyards. 57.75" w x 19" d x 32" h. Folds to fit durable carrying case (37" x 20" x 6" - included).

57293 Deluxe Folding Grill Table



B





Kuuma Grill Replacement Parts

Part#	Description	Fits Grill Models	
 58210	Burner tube, 16"	58140/58141/58155/58162	
 58211	Burner tube, 20"	58121/58130/58131/58133/58161/58173	
	58221	Cook Rack	58110/58130/58131/58133
	58222	Cook Rack	58120/58121
	58223	Cook Rack	58140/58141
	58224	Cook Rack	58160/58161
	58225	Cook Rack	58162
	58295	Cook Rack	58173
	58299	Cook Rack	58155
	58240	Grease Tray	58120/58121/58160/58161
	58243	Grease Tray	58130/58131/58133
	58244	Grease Tray	58140/58141
	58245	Grease Tray	58162
	58246	Grease Tray	58173
	58289	Grease Tray	58155
	58250	Heat Plate	58162
	58251	Heat Plate	58121/58161
	58252	Heat Plate	58110/58130/58131/58133
	58258	Heat Plate	58120/58160
	58259	Heat Plate	58140/58141
	58294	Lift & Clean Liner	58173
	58297	Lift & Clean Liner	58155
	58270	Low Pressure Valve Kit	58133/58141
 58275	Regulator	58121/58131/58140/ 58155/58161/58162/58173	
 58293	Charcoal Briquette Tray	58110	
	58296	Warming Rack	58173
	58299	Warming Rack	58155
	57800	Piezo Sparker	58131/58155/58173
	57858	Sparking Electrode	58131/58155/58173
	57867	Thermometer	58131/58155/58173



A1

A. GM12 Continuous Ignition Multi-Sparker This handy igniter is the one designed exclusively for igniting gas appliances. No butane to refill. The continuous ignition piezo electric sparker assures a large and immediate continuous spark. The automatic illumination micro-light and curved nozzle make tough lighting jobs easy. Uses one C battery (included).

A1 57533 GM12 - 13" long (7" pipe)

A2 57561 GM12X - 26" long (20" pipe)



A2

B. Gas Leak Detector Help protect your boat from gas leaks. Gas Leak detector bubbles at the problem area when gas is escaping.

10324 with sprayer 8 oz bottle

10325 with dauber 8 oz bottle

C. Gas Pressure Test Kit Test your gas system for leaks and system pressure at an appliance or at the gas controls. Easy-to-read gauge comes mounted in a durable case with a 30" hose and a brass pressure tap fitting.

10389 Test kit

10399 Replacement nipple for kit

10409 Replacement hose for kit

D. CAMLighter™ Elite Open a bottle and light your grill or heater with one handy and attractive tool. Matte aluminum finish with black accents. Textured back for a sure grip. Adjustable flame; refillable. CPSC certified.

58023 CAMLighter™ Elite Opener/Lighter



B



D



C



A. GM3 GasMatches™ The GM3 GasMatch sets the standard for top-of-the-line features. The continuous ignition system means that the flame will never blow out. Long slender design lets you get at hard-to-reach places with total safety. Features safety lock, fully adjustable flame and fuel viewing window. 10,000 starts. Refillable with butane lighter fluid. Uses one AA battery, included. CPSC certified.

- A1 57433 GM3™ - 14-3/4"
- A2 57543 GM3X™ - 26" (15" flex extender)
- A3 57684 GM3XE™ - 40-3/4" (26" flex extender)

B. GM9 GasMatches™ Great for barbecues, fireplaces, pilot lights, kerosene heaters and candles. 11" long. Safety lock, CPSC certified, adjustable flame, fuel viewing window. Refillable with butane lighter fluid. Packaged two per card.

57473 GM9 GasMatch™ 2/pk

C. GM4 GasMatch™ Our most popular mid-sized model. Piezo electric ignition, fully adjustable flame, safety lock, fuel viewing window, thousands of lights. CPSC certified. Refillable with butane lighter fluid. 11" long.

57453 GM4 GasMatch™

D. CAMLighter™ Butane Matches

Heavy-duty child resistant matches in 14", 8" or 3.5" length. Adjustable flame, refillable. Looks like a match, works like a lighter. A nice gift for anyone with a fireplace. CPSC certified.

- 57570 8" CAMPLighter 24/ctn
- 57573 8" CAMPLighter Blister Pack
- 58012 3.5" Mini CAMPLighter 24/ctn

E. Butane Refills (not shown) Multi-fill injectors in 78 gram and 165 gram sizes.

- 57416 78 gram butane fuel
- 57496 165 gram butane fuel

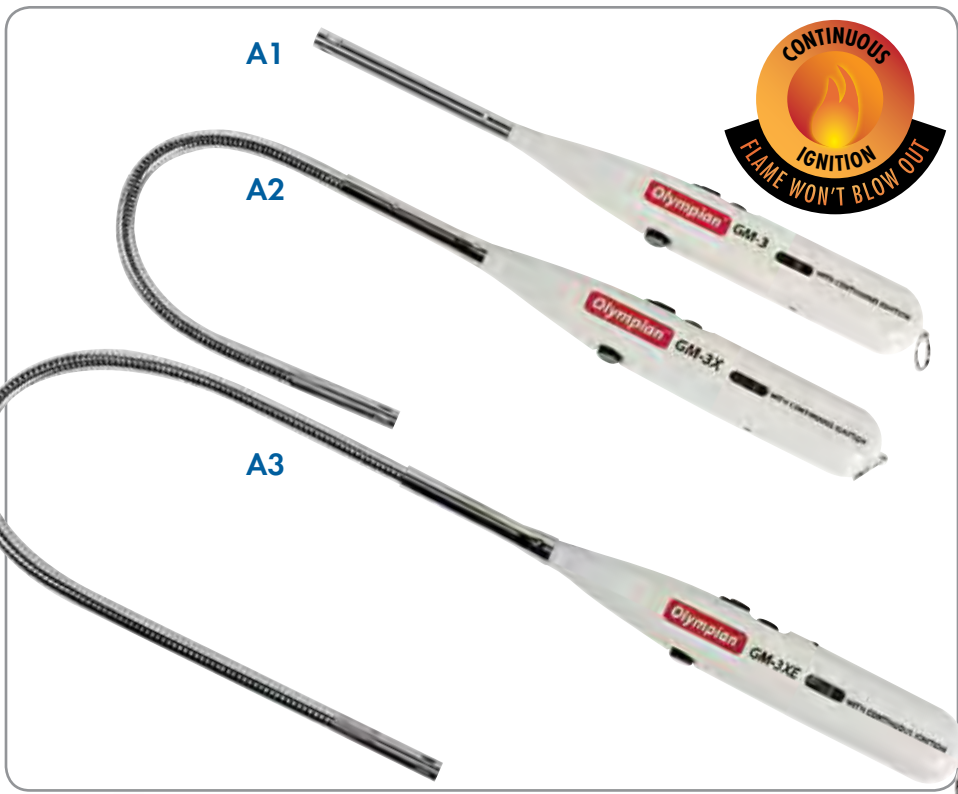

Olympian™

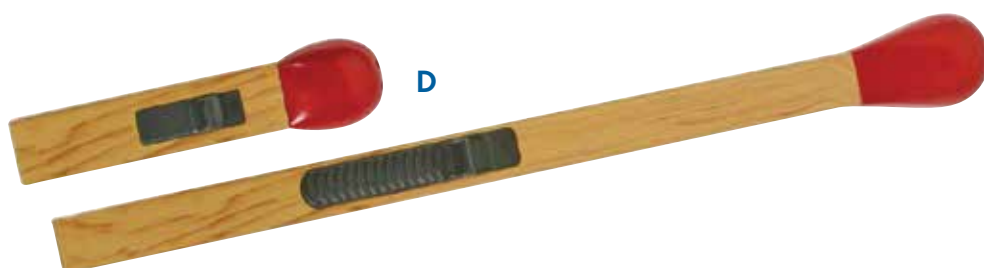

E

D

Featured products:



TST™ Marine
Premium Enzyme
Head Treatment



Swivel Stik™
Tank Rinser



Portable Toilets

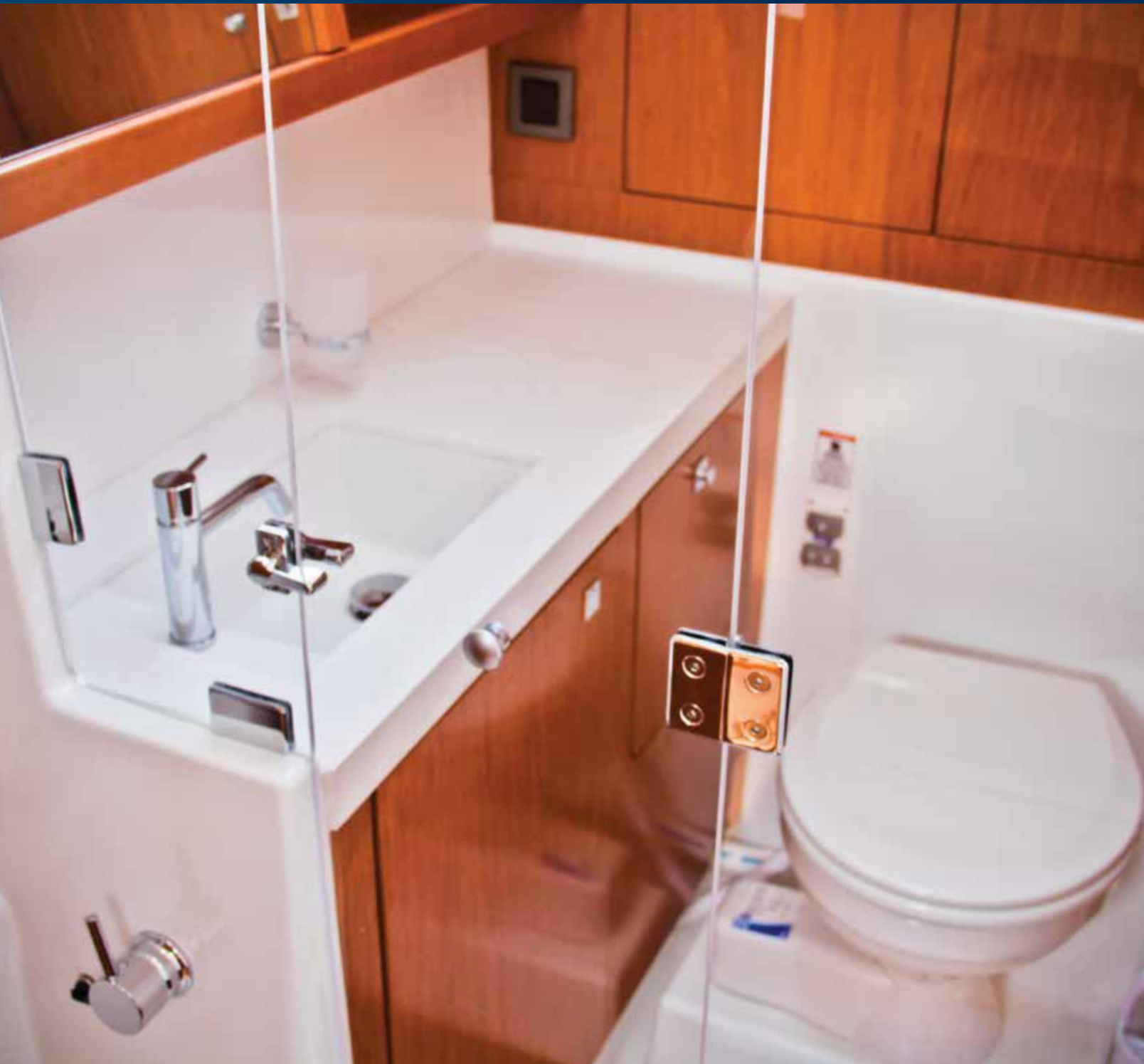

TST™ & Sanitation

PREMIUM ENZYME HEAD TREATMENT

Digests Waste and Tissue • Stops Odors Up to 7 Days
 No Harmful Formaldehyde • Just 2 oz Treats 40 gallons
 Septic Tank Safe • Fresh Pine Scent • 100% Biodegradable



A

A. TST™ Marine Premium Enzyme Head Treatment features a Bacteria/Enzyme formula to digest waste and break down tissue for easy biodegradation. Natural formulation digests waste, tissue, fats and proteins. Activates only in the presence of material requiring digestion. *Advanced formula is stable, with a long shelf life and is not temperature sensitive.* Also contains a buffering agent to prevent acid formation and septic odors. This product harnesses the natural process by which nature digests waste. Environmentally friendly and biodegradable. Fresh pine scent. 2 ounces treats 40 gallons.

- 41351 Eight 4-ounce Singles
- 41352 16 ounce
- 41354 32-ounce Measuring Bottle



B

B. TST™ Marine Head Treatment Singles Single-dose treatments require no mixing or measuring. Each 4-ounce bottle treats 40 gallons. Eight bottles/pack.

- 41361 (8) 4 ounce treatments



C

C. TST™ Marine Head Treatment Ultra-concentrated formula stops odors, breaks down waste and leaves a fresh scent. Safe for marine applications. Requires just two ounces per 40 gallons.

- 41362 Liquid, 32 ounce



D

D. TST™ Grey Water Odor Control Remove grease buildup in your grey water tank, sink and shower drain lines with this newly formulated treatment. Only four ounces per 40 gallons eliminates foul odors, leaving a fresh lemon scent.

- 40252 Grey Water Control, 32 ounce



E

F

E. TST™ Drain Valve Lube™ Lubricate plumbing lines while underway. Prevents sticking valves with coconut oil, making equipment last longer. Recommended for all applications: waste holding tanks, black and grey water systems.

- 40246 Drain Valve Lube, 16 ounce

F. TST™ Probe Cleaner Restore accurate sensor readings with a super-concentrated formula that attacks residue on probes. Works in black water and grey water holding tanks.

- 41146 32 ounce

A. Portable Toilets are designed for boating, camping, RVing or any other recreational activity. Sturdy polyethylene construction is compact and lightweight. The holding tank is detachable and includes a sealing slide valve to lock in odors and protect against leakage. It includes two side latches to secure the tank to the toilet and a carrying handle for easy transport. The toilet employs an easy-to-use bellow-type flush and pull slide valve for easy flushing. Includes a packet of Camco's TST biodegradable toilet chemical.

2.5-gallon (12.5"H x 16.25"W x 14.5"D);
5.6-gallon (16.38"H x 13.75"W x 16.13"D)

- 41531 2.5-gallon
- 41541 5.6-gallon

B. TST™ Tabs Deodorize black and grey water tanks with these compact tablets. One tab treats up to 40 gallons. Use in portable and marine toilets and grey water tanks.

- 41152 6 tabs/pack

C. Toilet Tissue Fast-dissolving, clog-resistant toilet tissue is biodegradable and septic tank safe. Contains no dyes or perfumes.

- 40278 2 Ply/4 per bag, 500 sheets/roll
- 40276 1 Ply/4 per bag, 280 sheets/roll

D. Swivel Stik™ Tank Rinsers

Holding tank rinser with shut-off valve dislodges and flushes stubborn waste deposits and odor-causing particles left after holding tank is emptied. Powerful rotary cleaning action reaches corners and walls of tank. One-quarter turn shut-off valve at your fingertips. All brass moving parts.

- 40094 Swivel Stik™



Featured products:



Hose Hanger



**Wash Brushes and
Accessory Poles**



XL Collapsible Bucket



Cleaners & Maintenance

100%
POWERFUL
100%
BIODEGRADABLE



A. Armada® Black Streak Remover An industrial strength, multi-purpose remover that safely and effectively eliminates black streaks. Armada Black Streak Remover contains no silicone or petroleum distillates, making it the safest product on the market for inflatable boat material and fenders. Black Streak Remover will also remove engine exhaust fume stains, oxidation and bird droppings.

40954 22 oz



B. Armada® Spider Fighter Remove ugly spider- and bird droppings with Armada Spider Fighter. Our concentrated citrus power eliminates black spots from fiberglass and is safe for all exterior surfaces, including clearcoat and gelcoat. A clear protective finish remains to help prevent spiders from returning, and the no-drip formula stays where you spray.

40872 Spider Fighter, 32 oz



C. Blast-Out Degreaser Fast-acting formula dissolves grease on contact. Super-concentrated cleaner safely removes grease, oil and dirt from driveways, garage floors, tires, engines, grills and more. Phosphate-free, and safe for plants and pets; contains no bleach or ammonia. Easy to use: just spray on and wash off.

41892 32 oz
41897 gallon



A. Hose Hanger While on your boat washing off the sea water from your latest voyage, keeping your water hose near-by can prove to be a struggle—but not if you have a Hose Hanger from Camco! The Hose Hanger hook holds securely on to rails up to 1 inch in diameter. One-piece design features molded-in, standard-sized, male and female water connections, which allow it to connect easily—in-line—right between your water hose and spray nozzle. No more chasing your water hose around a wet, slippery boat that's rocking back and forth and no more fishing your water hose out of the sea. Made of the light-weight, impact-resistant ABS with silicone hose washer for a water-tight seal.

20191 Hose Hanger



Keep your hose within arm's reach!



A

B. 210® Plastic Cleaner/Polish

The professionals' choice for protecting and maintaining isinglass, plexiglass and vinyl. Anti-static, anti-fog and non-streaking. 210® Plastic Cleaner/Polish seals the pores in all plastics, leaving a protective coating with UV inhibitors to prevent browning and hardening. Provides plastics with a clear, lustrous look.

40934 210®, 14 oz

C. 210® PLUS Plastic Scratch Remover

Remove surface scratches and blemishing with 210® PLUS. A one-step formula that is an extremely mild abrasive compound with anti-static and anti-fog properties. 210® PLUS is water soluble and easy to use with superior results.

40944 210® Plus, 15 oz

B



C

D



D. Blast-Out Pressure Washer Concentrate

Powerful pressure-washer cleaner specially formulated for RV and boat cleaning. Removes dirt, oil, grease and mildew stain. Use with a pressure washer or clean manually with a cloth, sponge or soft brush. Phosphate-free; contains no bleach or ammonia.

41867 Boat/RV Wash



A

B

C

D

A. Armada® True Wax Sealant

Easy on... Easy off! For the longest lasting protection available from a liquid wax, turn to Armada True Wax Sealant. True Wax contains 100% carnauba wax, UV sunlight inhibitors and fluorocarbon polymer resins. It stays liquid longer and can be applied to larger areas at a time before hardening. True Wax can be applied in extreme heat or cold and one application lasts a whole season! Perfect for fiberglass, chrome, gelcoat, rubber and vinyl!

- 40966 True Wax, 16 oz
- 40967 True Wax, gallon

B. Armada® Carnauba Wash & Wax Cleans, Shines & Protects in one easy step!

This non-toxic and biodegradable wash & wax is a premium grade cleaner for fiberglass, metal and painted surfaces and is the only boat soap available with real carnauba wax. Replenish your wax while you wash so that your sparkling shine lasts in between washings and reduces the frequency waxing needed.

- 40922 Carnauba Wash & Wax, 32 oz
- 40927 Carnauba Wash & Wax, gallon

C. Armada® Liquid Compound & Color Restorer

This advanced blend of rubbing compound combined with a proprietary color restorer formula will remove medium to heavy oxidation, chalking, rust, soot and exhaust stains from fiberglass. It will leave a high gloss finish and is a perfect first step in restoring fiberglass and gelcoat to its original shine and color. Self-dissolves while buffing so it leaves a dust-free, high-gloss finish. Rinses off easily with water or a clean towel. Follow with Armada True Wax Sealant to provide the longest lasting protection available.

- 40986 Liquid Compound, 16 oz

D. Armada® One-Step Cleaner Wax

A proprietary high-tech cleaner wax designed for the toughest jobs! Removes medium oxidation and chalking, rust and exhaust stains while leaving behind a slick, hard, high gloss barrier that protects against UV sunlight, acid rain, exhaust stains, salt and soot for a whole season!

- 40976 One-Step Cleaner Wax, 16 oz
- 40977 One-Step Cleaner Wax, gallon

A. Armada® AquaBlock™ Waterproofing & Stain Repellent

Contains UV and Mildew Resistant Agents. Most mills, including Sunbrella®*, apply a fluorocarbon polymer to the cloth at the factory for waterproofing and stain repellency. This is the most durable and effective waterproofing technology currently known. A polymer is like Teflon® for cloth.

Armada AquaBlock uses virtually the same fluorocarbon technology as the mills do to last an entire season. Application is therefore more effective, durable and easier to use than a less compatible agent.

AquaBlock has been independently laboratory tested against the three leading waterproofing products in the marine industry and was found superior.

40914 AquaBlock™ 22 oz

A



B



B. Armada® Lightning Fast Wax

Just spray and wipe to add a sparkling high performance wax shine to your boat with Armada Lightning Fast Wax! Perfect for touch ups; it is a quick and easy wet or dry application that is perfect for use on fiberglass, all painted surfaces and stainless steel (do not use on glass windows).

40885 Lightning Fast Wax, 16 oz



Makes
4
GALLONS

C. Armada® Mighty Brite® Mildew Stain Remover

A revolutionary, dry-powder formula developed to remove organic stains such as mildew, mold and other fungi and dirt. Also helps brighten soiled material. Perfect for vinyl, cloth, Sunbrella®* and canvas materials (not suitable for silk, leather or wool). Non-toxic and biodegradable. Will not cause damage from over-use and is safe on all colors. 16 oz container makes 4 gallons.

40904 Mighty Brite, 16 oz



D. Armada® Bilge Cleaner Super Concentrated, professional strength formula dissolves and eliminates grease, oil, fuel, scum, and sludge from your bilge while leaving behind a fresh clean scent. Non-toxic and biodegradable.

40897 Bilge Cleaner, gallon

D



*Sunbrella® is a registered trademark of Glen Raven Inc.

MULTI-PURPOSE HANDLES AND ACCESSORIES

A

Ergonomic Tear-Drop Design

FLOATS!

Designed to float in water if accidentally dropped.

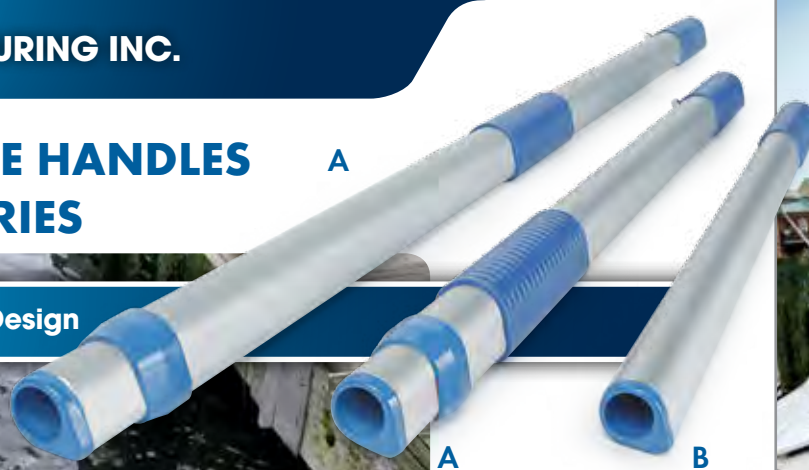

C



D1



A. Adjustable Multi-Purpose Handle

Teardrop profile. Anodized aluminum construction. Each handle has two non-slip TPE hand grips.

- 41910 2'-4'
- 41912 3'-6'
- 41914 5'-9'
- 41916 6'-11'

B. Fixed-length Multi-Purpose Handle

Teardrop profile. Anodized aluminum construction with non-slip TPE hand grip.

- 41900 2'
- 41902 4'

C. Multi-Purpose Handle Brush Head Attachments

7"-wide brush head. Rubber perimeter bumper. Available in 4 textures.

- 41920 Extra soft, light blue
- 41922 Soft, dark blue
- 41924 Medium, yellow
- 41926 Stiff, white

D2



D. Multi-Purpose Handle Cleaning Attachments

D1. Wash Head with Synthetic Wool Pad

- 41930 Wash head w/Pad
- 41932 Replacement Pad

D2. Wash Head with Microfiber Pad

- 41948 Wash Head w/Pad
- 41950 Replacement Pad

D3. PVA Mop Head

- 41934 Mop Head

D4. Squeegee

- 41936 Squeegee -Patented
- 41938 Squeegee Adapter

D3



D4





A. Multi-Purpose Handle Boating Attachments

A1. Paddle Blade

41946 22" long x 8" wide

A2. Fishing Gaff

41942 Hook depth of 3.5"

A3. Boat Hook

41940 Hook depth of 1.5"

A4. Landing Net

41944 17"x 20"x 30" deep

A1



A2



A3



A4

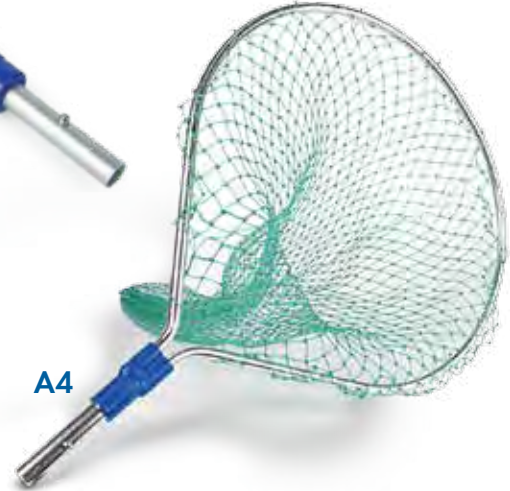

B. Adjustable Marine Wash Brush

Adjusts from 43" up to 71" long. Built-in ON/OFF switch provides full water control. Versatile brush features an 11" wide cleaning head with two types of bristles for maximum cleaning power: white bristles lift dirt and gray bristles brush it away!

43633 Adjustable Wash Brush

C. Hand Brush Ergonomic shape and non-slip handle make this brush ideal for many RV and household cleaning tasks.

43631 Hand Brush

D. XL Collapsible Bucket Over 18" wide for ease of use with large wash brushes. Collapses to 2-3/4" tall to fit in its own easy-to-carry storage bag (included). Made with durable watertight fabric. 18-1/4" x 9-1/2" x 10-1/2" bucket has a 5-gallon capacity.

42973 XL Collapsible Bucket

E. Collapsible Bucket The perfect size boating, fishing, camping and more. Watertight fabric holds 3 gallon (11-L) water capacity. Opens easily to 9.25" (23.5 cm) tall and folds to less than 2" (3.5 cm) for compact storage. Zippered storage bag included.

42993 Collapsible Bucket

F. Wash Sponge Curved shape for an easy grip while washing your boat.

44710 yellow, 7"x 4.5" x 2"

B



C



D



E



F





A. Dust Pan & Whiskbroom

Small size makes it easy to keep this handy duo close at hand. Whiskbroom snaps into dustpan when not in use. Hanger-hole for convenient storage.

43945 Dust Pan & Whiskbroom

B. Adjustable Broom Full size broom telescopes down to store capacity. Soft-bristled head adjusts to different angles for maximum cleaning power. Handle length is adjustable, too! Handy dustpan clips onto broom handle for storage.

43623 Adjustable Broom w/Dust Pan

C. Armada® Plastic Window Guards

Greatly extends the life of clear plastic windows by preventing the sun from burning holes in costly plastic window enclosures. Simple and inexpensive to install; simply snap Armada Plastic Window Guards on your metal railings to keep the plastic away from the burning heat. Stops scratching and abrasion of plastic windows due to rubbing.

65513 7/8" Rail Size, 6/pk

65523 1" Rail Size, 6/pk



D. Mini Dehumidifier

Compact moisture absorber reduces moisture which could lead to odors. Works to remove dampness from the air, helping to reduce mildew, mold and musty odors. Great for storage!

44195 Mini Dehumidifier



E. Non-Slip Tape, Black

Be sure footed under the wettest conditions. Textured surface with a permanent self adhesive backing can be easily cut to fit any area. Adheres to wood, fiberglass and painted surfaces. Great for pads, docks, decks, steps and boat ramps.

25401 Non-Slip Tape, 2" x 15'

E





A. Aluminum Step Platforms with adjustable- or fixed-height legs. Each stool has a 19 × 14½ inch platform. Easy to set up; supports up to 1000 pounds. Strong and sturdy construction with non-slip rubber feet. Legs fold for easy storage (storage height: 2¾ inches). Adjustable-leg stool adjusts between 7 and 8 ½ inches tall. Fixed-height stool is 8 inches tall.

43676 Step Platform, Adjustable Legs

43677 Step Platform, Fixed Legs

B. Step Stools Small stool supports up to 300 lb. Large stool supports up to 400 lb. Patent Pending. Platform dimensions: Small: 9 × 9⅞ × 15⅞ inches, Large: 9¼ × 10⅞ × 17⅜ inches.

43460 Stool, Plastic, Small

43470 Stool, Plastic, Large



C. Extra Step Heavy-duty steel-frame stool. Folding legs lock open to 7" height. Extra-wide 8" × 19" platform with angled legs to provide stability. Gripper strips on platform. Folds to only 2" wide for storage. Supports up to 300 lb.

43675 RV Extra Step



D. Fold-Away Step Stool This sturdy folding stool opens to 11-1/2" tall and supports up to 300 lb. Lightweight aluminum construction.

43672 Folding Stool



Featured products:



TastePURE® Carbon/
KDF® Water Filter



Fresh Water
DE-Winterizer



Premium Drinking Water
Hoses

TastePURE® / Fresh Water



TastePURE[®] / Fresh Water



TastePURE™ Water Filter Guide



**RV/MARINE
Carbon
Water Filter
#40645**

**RV/MARINE
KDF®/Carbon
Water Filter
#40043/40045**

**EVO™
RV/MARINE
KDF®/Carbon
Water Filter
#40631/40621**

**EVO™ VOC
RV/MARINE
KDF®/Carbon
Replacement Filter
#40624**

- 150 micron barrier
- Full-size, short-term use filter
- Carbon media
- Disposable

- 100 micron barrier
- High-flow carbon filter with KDF® to help prevent bacteria growth
- Disposable
- Includes anti-kink connector

- 5.0 micron barrier
- High-flow carbon filter with KDF® to prevent bacteria growth
- Cartridge is replaceable
- Includes hose extension

- 5.0 micron barrier
- High-flow carbon filter with KDF® to prevent bacteria growth
- Cartridge is replaceable
- Includes hose extension

Filter Media

Granular Activated Carbon (GAC)

Granular Activated Carbon (GAC) and KDF® mixture

Granular Activated Carbon (GAC) and KDF® with a Spun Polypropylene barrier

Superior Grade Granular Activated Carbon (GAC) and KDF® with a Spun Polypropylene barrier

Recommended Usage

120 days

One camping season

One camping season

One camping season

Micron Rating

150

100

5.0

5.0

Installation

Point-of-entry—Exterior

Point-of-entry—Exterior

Point-of-entry—Exterior

Helps Protect Against >>

Contaminant	RV/MARINE Carbon Water Filter #40645	RV/MARINE KDF®/Carbon Water Filter #40043/40045	EVO™ RV/MARINE KDF®/Carbon Water Filter #40631/40621	EVO™ VOC RV/MARINE KDF®/Carbon Replacement Filter #40624
VOCS* <small>*Volatile Organic Compounds</small>				✓
:: Aluminum	✓	✓	✓	✓
:: Bacteria		✓	✓	✓
:: Bad Taste	✓	✓	✓	✓
:: Cadmium		✓	✓	✓
:: Fungus		✓	✓	✓
:: Heavy Metals	✓	✓	✓	✓
:: Hydrogen Sulfide	✓	✓	✓	✓
:: Iron	✓	✓	✓	✓
:: Lead	✓	✓	✓	✓
:: Mercury	✓	✓	✓	✓
:: Mold	✓	✓	✓	✓
:: Odor	✓	✓	✓	✓
:: Turbidity (Cloudiness)	✓	✓	✓	✓
:: Sediment	✓	✓	✓	✓

This is just a partial list of contaminants removed by the TastePURE™ line of water filters.

A. Evo™ Premium Water Filter with replaceable cartridge

Reduces bad taste, odors, sediment, bacteria, chlorine and much more. Includes filter housing, one extension hose and one replaceable premium spun polypropylene filter cartridge. Filtration begins with water traveling through a porous shell with openings no greater than 5 microns in diameter. Filtered water then passes through a bed of KDF® and GAC (Granulated Activated Carbon) for further filtration and bacteria control. The result is fresh, clean, great tasting drinking water straight from your tap. For exterior use.

40631 Evo™ Premium Water Filter

40621 Evo™ Spun PP Cartridge

B. Water Filter Stand Hold your water filter upright and off the ground. Foot bar makes it easier to secure the stand in the ground. Lightweight. Zinc coated to inhibit rust.

40772 Water Filter Stand

C. Evo™ Premium Water Filter VOC Replacement Cartridge

Designed as a replacement cartridge for Camco's Evo Water Filter housing. Filtration begins with water traveling through a porous shell with openings no greater than 5 microns in diameter. Filtered water then passes through a bed of KDF® and GAC (Granulated Activated Carbon) for further filtration and bacteria control. *Contains premium carbon with a high microporosity level for absorbing harmful VOCs (Volatile Organic Compounds).* The result is fresh, clean, safe, great tasting drinking water straight from your tap.

40624 Evo™ VOC Water Filter Cartridge





A. TastePURE™ KDF®/Carbon Water Filter Larger capacity filter lasts an entire season. Greatly reduces bad taste, odors, chlorine and sediment in drinking water with a 100 micron fiber filter. Durable in-line, exterior mount filter has a wider body to increase flow. Includes flexible hose protector to minimize kinking.

40043



B. TastePURE™ Marine Water Filter Attaches inline to your hose to improve the taste and smell of your drinking water for up to 120 days. Filters down to 150 microns. Also eliminates water spots on fiberglass when used for washing down.

40645

C. TastePURE™ Spring Fresh™ Clean and deodorize your boat's fresh water systems with this safe, biodegradable formula. De-winterize fresh water holding tanks and lines. Good for periodic cleaning, freshening and deodorizing. One step, no-measure solution requires no mixing or preparation. One gallon cleans up to a 100 gallon tank.

40207 gallon

D. TastePURE™ Drinking Water Freshener Eliminate algae and slime buildup from drinking water tanks. Just one ounce helps remove bad smells and taste from 20 gallons of water.

40208 16 ounce



E. TastePURE™ DE-Winterizer For use with boats coming out of storage. Just one bottle freshens and deodorizes your Fresh Water System from tank to tap. Can be used for year-round freshening. Treats up to 60 gallons.

40218 16 ounce



B. TastePURE™ Drinking Water

Hoses Reinforced hoses for maximum kink resistance. Made with NSF certified hose. Lead-free, drinking water safe. BPA-free, phthalate-free formulation. No strong plastic taste is imparted to the drinking water. UV-stabilized for long life. Made in USA.

- 22783 25', 5/8" ID
- 22793 50', 5/8" ID
- 22803 75', 5/8" ID

C. TastePURE™ Premium Drinking Water Hoses

Heavy duty reinforced 5/8" ID drinking water hoses are 20% thicker than standard hoses. Anti-kink design features machined fittings and strain-relief ends for added durability. Lead-free, drinking water safe. BPA-free, phthalate-free formulation. No strong plastic taste is imparted to the drinking water. UV-stabilized for long life. Made with NSF certified hose. Made in USA.

- 22823 10' Premium Drinking Water Hose
- 22833 25' Premium Drinking Water Hose
- 22843 35' Premium Drinking Water Hose
- 22853 50' Premium Drinking Water Hose

D. Hose Hanger

While on your boat washing off the sea water from your latest voyage, keeping your water hose near-by can prove to be a struggle—but not if you have a Hose Hanger from Camco! The Hose Hanger hook holds securely onto round rails up to 1 inch in diameter. One-piece design features molded-in, standard-sized, male and female water connections, which allow it to connect easily—in-line—right between your water hose and spray nozzle. No more chasing your water hose around a wet, slippery boat that's rocking back and forth; no more fishing your water hose out of the sea. Made of the light-weight, impact-resistant ABS with silicone hose washer for a watertight seal.

- 20191 Hose Hanger



A. Cold Weather Water Hose Keep your water supply flowing even in freezing temperatures. Camco's Heated Water Hose combines a drinking-water-safe hose with a self-regulating heat source which is encapsulated in an all-weather, PVC coating for durability. Features machined and Nickel-plated fittings for maximum corrosion protection. Includes a female-to-male adapter for connection of the water source to either end of the hose; depending on the location of your electrical connection.

- 22900 12 ft Cold Weather Hose
- 22902 25 ft Cold Weather Hose
- 22903 50 ft Cold Weather Hose

B

C

D

Keep your hose within arm's reach!

Connects to your boat or RV at fresh water inlet

to provide an outside water faucet on your boat.



A



A. 90° Water Faucet Get an extra water source right at your boat's fresh water connection with this lightweight plastic faucet. Lets your fresh water hose hang without kinking. Use as a pressure release valve during disconnection.

22463 90° Water Faucet

B



B. Water Diverter Need an extra faucet at your dock? This brass threaded faucet attaches to a standard garden hose, allowing you to use the hose without disconnecting the water hook-up. Also acts as a pressure release during disconnection.

22475

Connects to fresh water supply faucet

to provide an outside water faucet while your boat or RV is connected to water source.



B

C. Flexible Hose Protector with Easy Gripper

Coiled attachment eliminates hose kinking at the faucet. Comes complete with Easy Gripper for effortless attachment to the faucet.

22703

D. Water Bandit Hook this 3-1/4" connector to any standard-size, unthreaded faucet or those with stripped threads and attach your garden hose. Stop wasting water due to poor connections. Suction grip tight fit.

22484

E. Hose Elbows Prevent hose kinking and strain, and extend hose life. 90° and 45° elbows eliminate unnecessary stress and strain on all water intake hose fittings. Made of brass for years of trouble-free use.

22505 90° Hose Elbow

22605 45° Hose Elbow

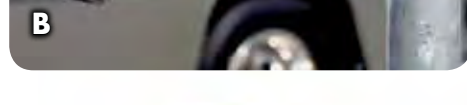

A. Water Pressure Regulator

Stop damage to your water hose, pump or internal lines from inconsistent water pressure in marinas. Reduce water pressure to a safe, consistent 40-50 PSI of operational pressure. Protects equipment and prevents hose failure, helping to prolong equipment life. Available in durable ABS plastic or brass. (FGH x MGH) Patented.

40143 Plastic Regulator 3/4" 6/ctn

40055 Brass Regulator 3/4" 6/ctn

A



B. Water Pressure Regulator with gauge

Helps protect plumbing and hoses from damage that can be caused by high-pressure city water. Attaches easily with convenient 3/4" garden hose threads. Easy-to-read dial. Pressure is factory pre-set at 40-50 PSI. Patented.

40064 Regulator with gauge

B



C



C. Backflow Preventers Allows fluid to only flow in one direction. Prevents backflow. Heavy duty brass body with stainless spring. 1/2" or 3/4" (Male x Female NPT).

23303 1/2", 1/card (CSA approved), 6/ctn

23402 3/4", bulk, 50/ctn

D. Stop Leak Connector Connect bent hose ends. This versatile connector includes a built-in one-piece flow-through flexible washer. Recommended for connecting damaged hose couplings and for new hoses to protect hose threads. Fits male or female end of a 3/4" garden hose.

20213 6/ctn

E. Hose Washers Stop your garden hose from leaking at the faucet and hose connections.

20153 10/card

F. Filter Washers Filter trash and debris from your water system. Fits any standard garden hose female coupling. Stainless steel mesh traps dirt particles before they enter your boat's system. Ideal for a washing machine hookup.

20183 3/card



D



E



F



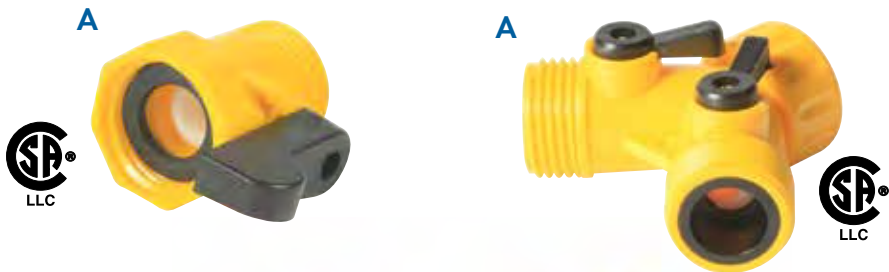

A. Shut-Off Valves Control water flow with a quarter-turn pressure seated valve. Y-style converts a single-line hose to two directions. Each side is valve controlled to easily adjust flow and pressure. Made of resilient plastic.

- 20073 Plastic Y-valve
- 20003 Plastic straight valve



B. Quick Hose Connects Attach hoses quickly and easily for boat or residential hook-up. Choose from solid brass models with or without automatic shut-off when disconnected, or a sturdy plastic model with convenient built-in shut-off valve.

- B1 20143 Brass connector / flow-through
- B2 20103 plastic connector with shut-off
- B3 20135 brass connector with auto-shut-off



C. Quick Hose Connect Value Pack includes two extra male connectors. Connect/Disconnect quickly between water hose and multiple attachments such as spray nozzle, sprinkler, water hose, pressure washer and many more! Shuts off automatically when disconnected. Use at your home, RV, boat or campsite—anywhere with a standard water hose hookup! Solid brass construction provides years of service.

- 20136 Quick Hose Connect Value Pack



A. Marine Showerhead Enjoy longer showers with this ergonomically designed, handheld showerhead. Convenient on/off switch allows you to pause the flow of water while shampooing, greatly reducing the amount of water used. No more rushing through your shower to conserve water. Multi-featured showerhead allows you a choice of four spray patterns. From a drenching rain to a gentle massage, you can personalize your shower with your favorite comfort settings.

- 43710 Showerhead, Chrome
- 43711 Showerhead, White
- 43712 Showerhead, Off-White

B. Marine Showerhead Kit The same ergonomically designed, handheld showerhead with convenient on/off switch described in item A, packaged with a flexible 60" shower hose. Kit includes showerhead, flex hose, washers, wall mount and hardware. Shower Flex Hose features built-in connectors for easy installation to a standard 1/2" shower arm and reinforced construction to eliminate hose kinking.

- 43713 Kit, Chrome
- 43714 Kit, White
- 43715 Kit, Off-White

C. Showerhead Mounts, Chrome Adjustable wall mount gives you great flexibility in positioning your showerhead. Two-position wall mount gives you a choice of two angles for your showerhead. Hardware included.

- 43718 Two-position
- 43719 Adjustable

D. Marine Shower Flex Hose Shower Flex Hose features a reinforced construction that eliminates hose kinking. Flexible 60" replacement hose with built-in connectors for easy installation to a standard 1/2" shower arm. Washers included.

- 43716 Flex Hose, Chrome
- 43717 Flex Hose, White



Featured products:



Freeze Ban -50



Refractometer



Do-It-Yourself Kit



Winterization

By-Pass Kits Camco offers a complete line of by-pass kits for a lifetime of durable performance. By-pass kits save antifreeze by allowing your water heater to be bypassed when winterizing.

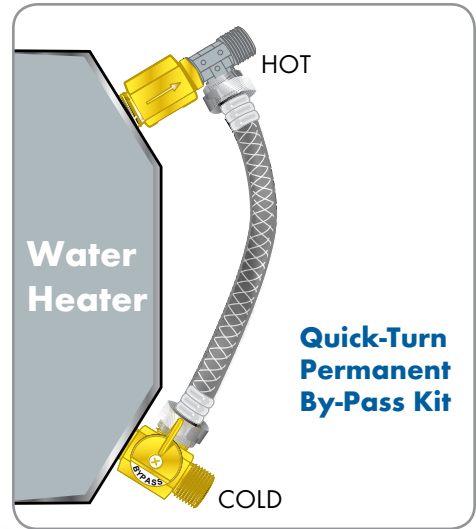
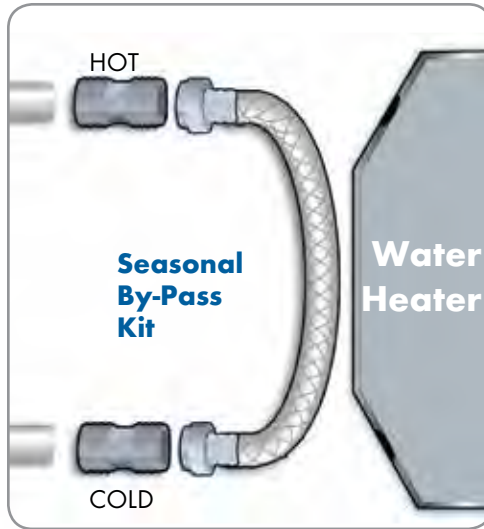
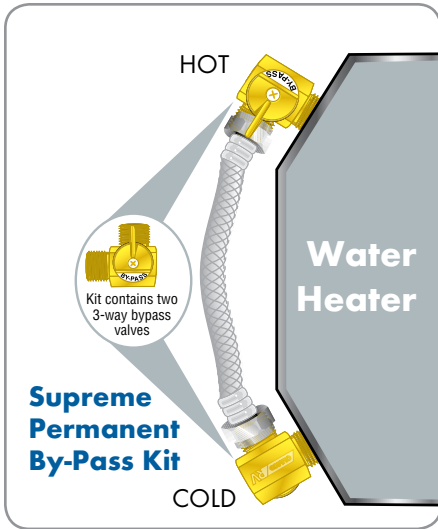

A. Supreme Permanent By-Pass Kit Simple, permanent installation of this kit allows you to easily drain your water heater for winterizing. Brass valves provide non-restrictive flow. Comes with kink-resistant nylon reinforced hose.

35953 With 8" hose for 6 gallon tank

35963 With 12" hose for 10 gallon tank



B. Seasonal By-Pass Kit This temporary by-pass kit allows you to hook up in the fall for winterizing and remove in the spring for reconnecting the system. Comes with kink-resistant nylon reinforced hose.

35713 Seasonal By-Pass Kit



C. Quick-Turn Permanent By-Pass Kit Save on antifreeze when you winterize with this easily-installed water heater by-pass kit. Sturdy, brass backflow preventer and 100% shut-off valve lets you bypass the water heater with a single turn. Patented.

35983 Quick-Turn Kit

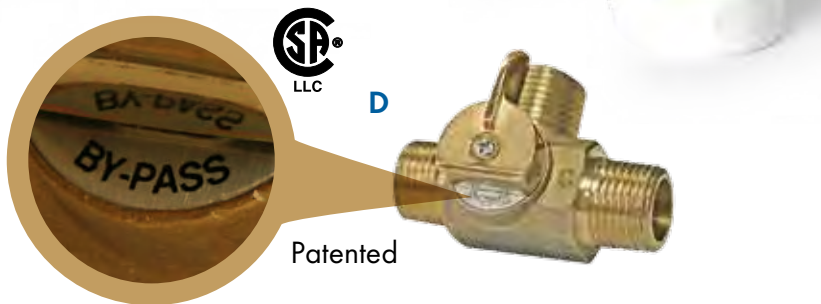

D. 3-Way By-Pass Valve Replacement Replacement 3-Way by-pass valve for the Supreme Permanent Bypass Kits and Quick-turn Permanent By-Pass Kit. Patented.

37463 3-Way Valve



A. Marine Antifreeze Protect your boat's potable water system from freeze damage. Camco antifreezes inhibit fouling and corrosion. They also help in lubricating pumps and valves throughout the system. Choose a temperature-specific product designed for your winterizing needs. Safe and tasteless.

- 30626 Premium Ban Frost 2000® 32 oz
- 30767 Freeze Ban -50 1 Gallon
- 30769 Freeze Ban -50 5 Gallon
- 30768 Freeze Ban -50 55 Gallon
- 30787 Winter Ban -100 1 Gallon
- 30788 Winter Ban -100 55 Gallon
- 30647 Winter Ban -50 1 Gallon



B. BanFrost 2000® Marine Engine Antifreeze Low-toxicity biodegradable engine protection. Use for winter storage of raw-water-cooled engines and as a permanent antifreeze/coolant for fresh water cooled systems. Replaces ethylene glycol: safer for people, pets and wildlife. All season/all purpose propylene glycol formula with CAM-3 inhibitor package offers superior corrosion protection.

- 30627 1 Gallon
- 30629 5 Gallon
- 30628 55 Gallon

C. Antifreeze pH Test Strips Test the pH of your Boiler Antifreeze solution to indicate the level of corrosion protection.

- 36011 Bottle of 50 strips

D. Ice Cutter™ Spray Thick formula stays where you spray for a more accurate and controlled application. Spray directly on windshield or other areas with frost and ice buildup for rapid melting power. Also helps protect against refreezing.

- 30522 32 oz Spray





A. Hand Pump Kit with Hose

Pump antifreeze directly into your boat waterlines and supply tanks. Kit includes flexible connecting line with city water connection. For connecting to an inside faucet, use the 2010 Compliant Faucet Adapter, sold separately.

36003 Hand Pump Kit



B. Pump Converter Winterizing Kit

Winterize your boat annually with ease. This permanent kit installs with an adjustable wrench and comes complete with brass valve, siphon hose, Teflon tape and pump adapters. Patented.

36543 Pump Converter



C. Blow-out Plugs

Completely clear your water lines with marine blow-out plugs. Screw the plug into the city water inlet, open all drains and faucets, attach and activate air pump until all lines are clear. Patented.

36103 Plastic 6/ctn

36104 Plastic 50/ctn

36153 Brass

36143 Quick-Connect Style



D. Freeze Check Refractometer

An economical, highly accurate instrument for testing the point at which antifreeze solutions begin to solidify. No charts, graphs or conversions. Eliminates guesswork, reassuring the user that the unit is protected to the desired level. Saves money by eliminating over-use of antifreeze and verifying proper protection. Recommended for use with winterization methods where propylene glycol based antifreezes are used.

65401 Refractometer

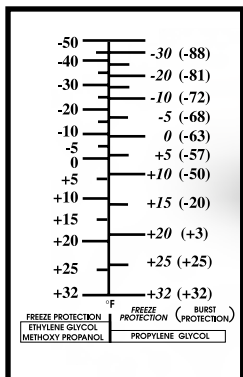



DIY Boat Winterizer Quickly and efficiently service inboard/outboard marine engines. The Do-It-Yourself Winterizer allows flushing and preparation of boat engine for winter storage with just five gallons of antifreeze and your flusher. Save time and money season after season. Great for technicians, too. For front mounted raw water pump systems use the Flush Adapter, sold separately.

65501 DIY Winterizer

65493 Flush Adapter for Engine Mounted Raw Water Pump



Featured products:



Decor-Mate Stove Topper



Bamboo Cutting Boards



Shatter-Resistant Glasses





A. Universal Silent Top™ Silence annoying stove top rattles while adding valuable counter space to your galley. Solid oak-finish hardwood stove top cover hides and protects burners. Non-toxic gloss finish for extra moisture protection. (19-5/8" x 17-1/2") Patented. Includes bonus Flexible Cutting Mat.

43521 Oak Accents™ Silent Top™

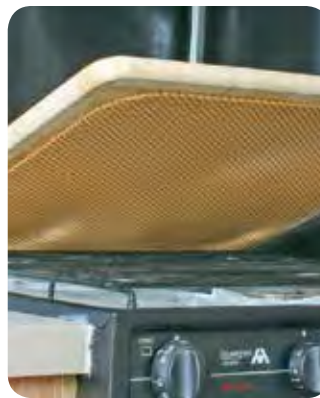

B. Hardwood Stove Topper/Cutting Board Hide burners, eliminate rattles, and add an attractive cutting board to your galley. Board doubles as a serving tray. Won't nick or dull knives. Non-skid backing holds board in place. Selected hardwoods are treated to preserve and enhance natural wood beauty. Built-in juice groove. Fits 3 or 4 burner stoves. Patented. (17" x 19-1/2" x 3/4") Includes bonus Flexible Cutting Mat.

43753 Hardwood Stove Topper



C. Decor-Mate Stove Topper Quiet stove top rattle and add much-needed counter space in your galley. Sits directly on stove top grates or over an existing stove cover. Stays firmly in place with non-skid backing. Durable polyethylene—cleans easily with soap and water. Patented. (17" x 19-1/2" x 1/2")

43704 black
43707 white
43709 almond



NEW

D. Bamboo Cutting Boards Handy bamboo cutting boards sized right for the galley. Three sizes and styles to meet your cooking needs.

- Finger-hole style (7-7/8" x 7-1/8" x 1/2")
- Handle style (7-7/8" x 11-13/16" x 1/2")
- Footed style with juice groove (11-13/16" x 10" x 13/16")

43542 Cutting Board with finger hole
43544 Cutting Board with handle
43546 Cutting Board with feet

A. Universal Fit Stove Top Cover

Protect and hide burners and add counter space in your galley. Cover acts as a splash guard between burners and wall when folded back. Flip up one side to use two burners or fold and store it away compactly when you need all four burners. Made of 20 gauge steel with powder-coated finish.

43554 black

43557 white

B. Marine Splash Guard

Protect your counter top from cooking spatter. Installs easily. High-impact clear plastic with clear anodized trim. Measures 20-1/4" along the counter, 11" up the wall.

44253 Splash Guard

C. Stowaway Flexible Cutting Mat

Protect galley counter tops from nicks, cuts and stains. Natural-colored mat eliminates spills by bending for easy pouring. Made of sturdy, lightweight recyclable plastic. Bend or roll for compact storage. FDA approved materials. Non-toxic and dishwasher safe. 11-1/2" x 15". Patented.

43770 Flexible Cutting Mat

D. Microwave Cooking Covers

Prevent spattering and reduce cooking time while venting steam automatically. Dishwasher safe and made of FDA approved materials. Set of two includes one 8" x 8" and one 10" x 10".

43790 2/pack

E. Gas Stove Burner Liners

Keep stove top burners clean and hide pitted or rusted burner wells. Liners make clean-up easier. Fits Wedgewood, Magic Chef® and most other marine gas stoves. Easy installation. 7-1/2" diameter.

43800 4/pack

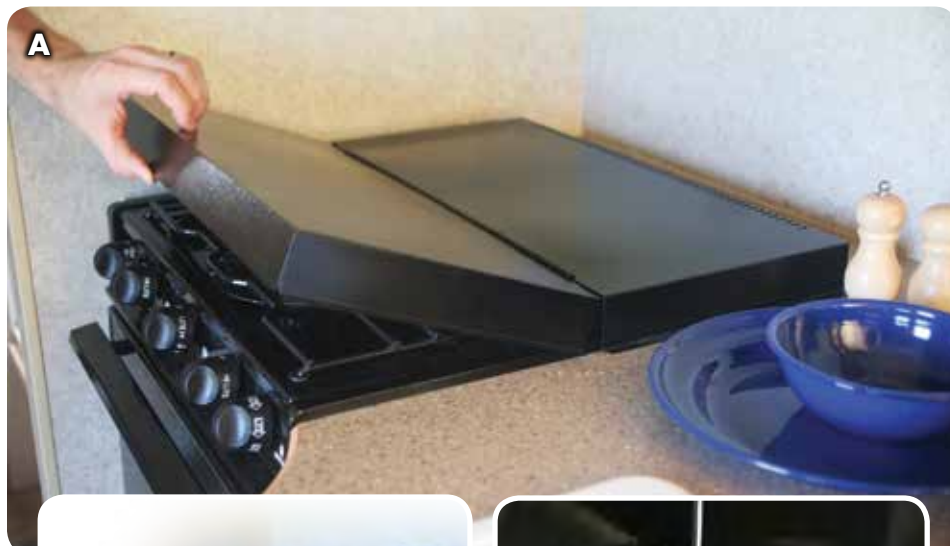



A

A. Marine Mini Dish Drainer w/Tray fits boat sinks, and is sized just right for limited counter space. Sloped drainer tray keeps counters dry. Drain tray snaps on top of rack for handy storage. Durable heavy-duty construction.

43511 Dish Drainer

B. Marine Mini Dishpan Designed to fit galley sinks. Durable, heavy-duty construction. Holds nine quarts. Camco's Mini Dish Drainer fits perfectly inside for easy storage.

43516 Mini Dishpan



B

C. Mini Sink Mate Cutting Board

Increase kitchen work space with a sturdy polyethylene cutting board. Ideal for cleaning, carving and chopping. Fits right on the galley sink; adjustable feet adapt to sink size. Won't nick or dull knives. With cut corner for scraps and built-in juice groove. Measures 12-1/2" x 14-1/2"; Fits sinks 10" x 14", 11" x 13-1/4" and 12" x 14". Patented.

43857 white

43859 almond



C



D. Sink-Shower Strainers Help prevent clogs with these stainless steel strainers. These strainers easily fit into your drain to keep food out of your plumbing. Bonus 3-pack for both sink and shower drains.

42273 Sink Strainers

E. Marine Sink Mat Cushion and protect glassware and dishes. Small size vinyl mat is specifically engineered for galley sinks. Multiple drain holes allow water to flow freely through mat. Mildew resistant. 10" x 11-3/4".

43720 white



D



E

A. Adjustable Cutlery Tray Sized to fit into RV and Marine drawers. Slides out from both sides for an easy custom fit. Adjusts from 9" to 13". Patented.

43503 Cutlery Tray

B. Cutlery Tray Economical cutlery tray fits easily into galley drawers to keep your flatware organized. Compact 7" x 11" size.

43508 Cutlery Tray

C. Knife Safe™ Frees up valuable drawer and counter space. Gives you convenient, safe access to your kitchen knives. Holds seven knives up to 2" wide. Patented.

43581 white

43583 beige

D. Adjustable Drink Holder Prevent spills with the adjustable drink holder. Mounts quickly and easily in boats, cars, vans and trucks. Arms easily adjust to hold almost any size bottle, can or mug. Mounts with tape or screws (included).

44044 black

44043 brown

E. Pop-A Bag Hanger™ Create a wastebasket anywhere with the Pop-A Bag Hanger. This is a great way to re-use your plastic grocery bags and save money on trash bags. Install inside a cabinet door, on a wall or workbench area. Pop-A-Bag Hanger™ comes with double sided tape for easy installation. Patented.

43593 Set of 2

F. Grease Bin Here's an easy way to dispose of cooking grease and fat, and save your drains from nasty clogs. Hot cooking grease can be poured directly into the foil-lined bag. Container keeps odors in so you can use the bag until it's full, and then just toss it out with the trash. Includes three foil liner bags. Five-pack of replacement bags also available. Patented.

42281 Grease Bin

42285 Replacement Bags - 5/pk

G. Wall-Mount Trash Can Compact trash can mounts to wall or inside cabinet. Features swing-top lid. Patented.

43961 Wall-Mount Trash Can





A. Refrigerator and Cupboard Bars Keep order in your galley refrigerator and cupboards during travel. Spring loaded bars keep items in place. Cupboard bars extend from 10" to 17"; Refrigerator bars extend from 16" to 28".

- 44073 double refrigerator bar - white
- 44093 double cupboard bar - white



B. Fridge Airator™ Cool your boat's fridge evenly and keep food fresher. High-volume air circulator absorbs odors with replaceable activated charcoal filter. Battery operated.

- 44123 Fridge Airator
- 42093 Replacement charcoal packs

C. Fridge Brace™ Keep food from sliding as you go. Helps keep cartons upright to reduce the risk of messy spills. Two pack. Patented.

- 44033 Fridge Brace

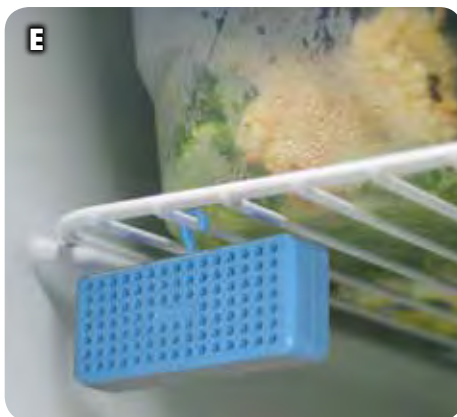

D. Mini Ice Cube Trays Small trays fit perfectly into boat freezers. Provides small size cubes for quick freezing. Set of two. (9" x 4" x 1")

- 44100 2/bag

E. Fridge Odor Absorber This space-saving refrigerator freshener packs a lot of odor-absorbing power into a small space. Perfect for compact RV, marine and dorm refrigerators.

- 44184 Fridge Odor Absorber



F. Fridge Door Stay Keeps your refrigerator door held open during storage. Improves air circulation and helps prevent mold and odor build-up.

- 45641 Door Stay

G. Slip-Stop® Keep everything safe and secure by preventing slipping and sliding. Washable, easily trimmed material works in tool boxes, rugs, van floors, shelves, dash boards or anywhere things slide around or rattle in your RV. Use as a liner between plates, cups and appliances.

- 43277 cream 1' x 12' roll
- 43278 slate blue 1' x 12' roll

Fridge
Door Stay



Break-Resistant Beverage Sets

No more broken glassware! BPA-free acrylic glasses have the look and feel of real glass, and the advantage of being shatter-resistant. Available in wine, pilsner, juice, tumbler, martini and margarita styles. Sold in boxed pairs. Top shelf dishwasher safe.

A. Wine Glass 9 oz. Set of 2.

43861 - Wine

B. Pilsner Glass 22 oz. Set of 2.

43891 - Pilsner

C. Juice Glass 7 oz. Set of 2.

43881 - Juice

D. Tumbler Glass 7 oz. Set of 2.

43871 - Tumbler

E. Martini Glass 10 oz. Set of 2.

43901 - Martini

F. Margarita Glass 12 oz. Set of 2.

43902 - Margarita



Make the most of limited storage and keep paper products clean and accessible. All products install easily in multiple locations and fit most standard packaging and product sizes.



A. Pop-A-Plate™ Save space and store nine-inch paper or plastic plates under your cabinet or shelf. Mounts easily.

57001 white

B. Pop-A-Bowl™ Save space by storing 6-inch disposable bowls or plates under your cabinet or shelf or next to the microwave. Mounts easily with screws (included).

57211 white

C. Pop-A-Napkin™ Keep napkins handy and clean. Napkin dispenser installs easily under cabinet or shelf. Easy to refill.

57041 white

D. Pop-A-Wrap™ Keep plastic wrap, aluminum foil or wax paper close at hand with easily-installed holder. Mounts under cabinet or shelf with screws. Serrated edge makes tearing fast and easy.

57131 white

E. Pop-A-Towel™ Keep paper towels clean and conveniently located. Holder can be permanently mounted on cabinet door, wall or under cabinet. Slides off the mounting bracket to stand alone or carry as needed.

57111 white



A. Stack-A-Plate™ with non-slip backing. Use in your cabinet to keep plates organized, and to stop them from sliding and rattling. Plates stay in place while traveling and are more protected from breakage. Set of two—one fits plates up to 7-1/4"; the other fits plates up to 10-1/4". Bright white. Dishwasher safe.

43601 Stack-A-Plate

B. Pop-A-Filter™ Keep 6" basket or cone coffee filters at your fingertips. Works with disposable plates and bowls too. Installs easily under cabinet or shelf.

57081 white

C. Pop-A-Bag™ Store grocery bags, trash bags and dryer sheets efficiently. Plastic bag holder/dispenser mounts easily on wall or inside cabinet with screws or double-sided tape. Holds up to 25 grocery bags.

57061 white

D. Pop-A-Tissue™ Keep facial tissues handy in wall- or cabinet-mounted dispenser. Installs easily with screws or adhesive tape. Can dispense upward or downward. Fits most boutique tissue brands.

57101 clear

E. Pop-A-Toothbrush™ Protect and store toothbrushes with easily-installed holder that guards against dust and germs. Cover opens automatically when toothbrush is pulled forward. Vented for quick drying Double-sided tape allows for permanent mounting.

57203 white



works with basket or cone style filters



Featured products:



Odor Absorber



Premium Quality
Awning & Leisure Mat



Portable Tables

Specialty Items



Specialty Items



Add a festive glow to your outdoor living area with these party light sets. Each 8-foot strand contains ten lights, and connector for hooking strands together. Each set includes two spare bulbs and a spare fuse. 120V with overload protection. UL Approved for indoor and outdoor use.

A. Party Lights - Chili & Cactus

Jaunty Chili and Cactus Party Light set.

42659 Chili & Cactus

B. Party Lights - Stars Patriotic Star Party Light set.

42656 Stars

C. Party Lights - Flags & Ribbons

Patriotic Flags and Ribbons Party Light set.

42657 Flags and Ribbons

D. Party Lights - Flamingos and Palm Trees Tropical fun Party Light Set.

42662 Flamingos and Palm Trees

E. Party Lights - Fuzzy Dice

Nostalgic "Fuzzy" Dice Light set.

42660 Fuzzy Dice

F. Party Lights - Bottles & Mugs

Spirited Bottles and Mugs Light set.

42661 Bottles and Mugs

G. Lantern Snaps Attach patio lights, screens, canvas or poly film to your awning quickly and easily. Open one end, snap to awning fabric, then snap the other end to the lights, or push the flexible tabs into the awning roller bar channel and attach the snaps to the tabs. Durable metal construction.

42713 4/pack



A

A. Odor Absorber Naturally activated charcoal helps absorb odors caused by mold, mildew and other pollutants. Use for long term storage of boats, RVs and cabins. Works great in refrigerators, crawl spaces, closets, basements and other locations. Helps control pet odors, kitchen smells, musty odors, tobacco and much more. Each individually wrapped Odor Absorber lasts up to four months.

44191 3-pack



B. Folding Ironing Board Tabletop ironing board with pressed-board top and quality fabric cover is small and easy to use. Features sturdy chrome-wire iron rest. Measures 32" x 12" when set up. Legs fold under and board folds to 16" x 12" for easy storage. (Iron not included).

43904 Ironing Board



32 x 12 inch ironing surface

B

C. Citronella Candle Citronella candle in a convenient metal container with lid for easy storage and transport. Helps keep the bugs away from your camping area.

51022 Citronella Candle

D. Mini Pop-Up Utility Container

Collapses to 2.5" high with built-in storage strap. Hook-and-loop tape on base to help hold in place.

42903 Mini Pop-Up Container



E. Multi-Clamp™ Secure objects of almost any shape or size with no tools. Each clamp holds objects between 1/2" and 4" in diameter. Made of flexible hardened plastic with UV inhibitors. Won't rust; resistant to most chemicals. Join two or more together for larger jobs.

39103 Multi-Clamp



C



D



E

A



A. Premium Quality Awning and Leisure Mat

This attractive 7' x 15' mat is made from a heavy-duty woven poly-vinyl material which allows snow and rain to drain through. Reinforced corners with rust resistant grommets provide an easy way to secure it using included ground stakes. Helps keep dirt

from being tracked onto your boat. Easily cleaned with soap and water. Comes with heavy canvas bag for transport and stowing.

- 42811 Brown
- 42812 Gray



B



C

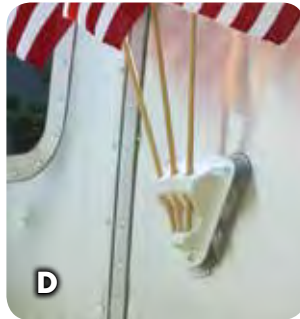

D

B. U.S. Flag A fabric, full detail printed flag, mounted on a 1/4" wooden staff with gilded spear. Finished edges. 12" x 18"
45491 US Flag

C. Happy Hour Flag A white fabric 12" x 18" flag with a beer mug, martini glass and the words "Happy Hour" in red.
45492 Happy Hour Flag

D. Suction Cup Flag Holders Easy to use; no drilling. Each suction cup holds up to three pounds. When moistened, suction cups stick to any smooth, clean nonporous surface. Remove before traveling. 3" x 5" 3-hole style holds flags with staffs up to 3/8". White ABS plastic.
45502 3-Flag Holder



E



E. Spiral Anchor Secure your pet outside. Works well in all kinds of soil; ideal for securing in sandy areas. Swivel ring helps prevent your pet's chain from becoming wrapped around the stake.
42572 Spiral Anchor



Zero Gravity Wide Recliner

- 4" wider than standard Zero Gravity chair
- Powder coated steel frame
- Adjustable head rest
- Dual locking system
- Folds to 5"
- Weather resistant, UV protected fabric

51830 Black Swirl
51831 Green Swirl
51832 Tan Fern



Zero Gravity Recliner

- Powder coated steel frame
- Adjustable head rest
- Dual locking system
- Folds to 5"
- Weather resistant, UV protected fabric

51810 Black Swirl
51811 Green Swirl
51812 Tan Fern



Director's Chair

- Includes 14" long x 9" wide table
- Lightweight aluminum frame
- Weather resistant, UV protected fabric
- Padded arm rests

51800 Black Swirl

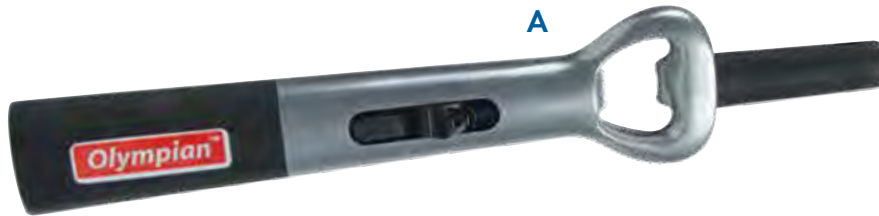

A. CAMPLighter™ Elite Open a bottle and light your grill or heater with one handy and attractive tool. Matte aluminum finish with black accents. Textured back for a sure grip. Adjustable flame; refillable. CPSC certified.

58023 CAMPLighter™ Elite Opener/Lighter

B. Tablecloth Clamps Hold tablecloths securely under the windiest conditions. Red plastic clamps won't rust or corrode. Use on tables from 1/2" to 2" thick.

44003 4/card



C



C. Telescoping Roaster The perfect tool for cooking marshmallows, hotdogs or sausages over an open fire. Stainless steel—Extends up to 34 inches.

44014 Telescoping Roaster



A. Aluminum Folding Tables

combine lightweight materials with a durable design. Perfect for boating, camping, tailgating, RVing, or out on the porch or patio. Tables set up without tools in seconds and folds to only 2" wide for compact storage.

Small table has a 12" x 10" top, opens to 16.5" tall and supports up to 130 lb. Folded dimensions: 18.5" x 12" x 2".

Large table has a 19.5 x 19" top, opens to 23.7" tall and supports up to 110 lb. Folded dimensions: 28.25 x 19.5 x 2".

FOLD-AWAY TABLES

51890 Folding Side Table, 12" x 10"

51891 Folding Table, 19.5 x 19"



B. Aluminum Roll-up Table

Lightweight functional design makes this table portable, easy to set-up and break down with storage bag included. Hollow, aluminum slat top attaches easily to cross-support bars and segmented legs. Seats 4-6 people. No tools required. The roll-top feature makes the table and bag compact for easy storage.

51892 Roll-Up Table w/Carrying Bag



Space-saving, impact-resistant products *Built for the boater.*



Cutlery Tray



Mini-Dish Drainer
w/Tray



Mini-Dish Pan



Sink Strainers, (3-
pack)



Stack-A-Plate, (2-
pack)



Slip Stop,
(Cream color)



Flexible Cutting Mat



Pop-A-Bag Hanger



Unbreakable Beverage Sets*

- A. Wine, 9 oz
- C. Margarita, 12 oz
- E. Juice, 7 oz



- B. Pilsner, 22 oz
- D. Martini, 10 oz
- F. Tumbler, 7 oz

*All of Camco's unbreakable beverage sets come in packs of two and are BPA Free.



Fridge Airator™



Fridge Odor Absorber



The
**Galley
Collection**
FROM CAMCO





CAMPING ESSENTIALS



A



B



A. Camping Cook Set Anodized aluminum nesting set with folding handles includes travel bag. Contains pot, saucepan, frying pan, three plastic bowls, a plastic spoon, plastic scoop with folding handle and a scrubber.

51312 Camping Cook Set - bilingual

B. Camp Stove Toaster Rack

Foldable compact design. Great for use with gas camping stoves. Toast up to 4 slices of bread at one time. 19" x 22".

51034 Toaster Rack

51035 Toaster Rack - bilingual

C



C. Camp Griddle Non-stick-coated aluminum griddle is perfect for making breakfast under the open sky. 10" x 16.5".

51048 Camp Griddle

51049 Camp Griddle - bilingual

D



D. Tripod Grill and Lantern Holder

Cook over an open fire with handy tripod grill. Seventeen-inch-diameter chrome-plated grilling surface is height-adjustable for better control of cooking temperatures. Or use it to hold your lantern for hands-free light. Fast and easy setup; compact storage.

51078 Tripod Grill and Lantern Holder

51079 Tripod Grill and Lantern Holder - bilingual





A. Cutting Board with built-in handle. BPA-free; made of FDA-compliant materials. Cutting Surface: 6-1/2 x 8-3/8 inches. Top-shelf dishwasher-safe. Polypropylene.

51300 Cutting Board - bilingual

B. Can Openers Compact, lightweight can openers are easy to use, and fold down to fit in a pocket. Nickel-plated hardened carbon steel stays sharp for many years. Set of two.

51040 Can Openers - set of two

51041 Can Openers - set of two - bilingual

C. Safety Fork 41-inch-long safety fork with stay-cool wooden handle has the tines turned inward. This helps prevent accidental injuries, and helps keep the food from sliding off into the fire.

51308 Safety Fork - bilingual

D. Telescoping Fork The perfect portable tool for roasting hot dogs or marshmallows over an open wood campfire. Extends out to 26 inches, telescopes down to a compact 13 inches for easy carrying.

51304 Telescoping Fork - bilingual

E. Fuel Funnel Fuel funnel with built-in screen for use with camp stoves and lanterns. 2.5 inch diameter.

51050 Fuel Funnel

51051 Fuel Funnel - bilingual

F. Knife Sharpener Molded of sturdy ABS with special ceramic sharpening surfaces to quickly and easily reshape a dull blade. Small enough to fit on a keychain.

51028 Knife Sharpener

51029 Knife Sharpener - bilingual

G. Campers' Salt and Pepper Shaker Convenient travel size. All-in-one design is moisture-proof and spill-proof. Unscrew ends to fill, unscrew from center to use.

51056 Salt and Pepper Shaker

51057 Salt and Pepper - bilingual



E



F



TELESCOPES TO 26 INCHES

D

C

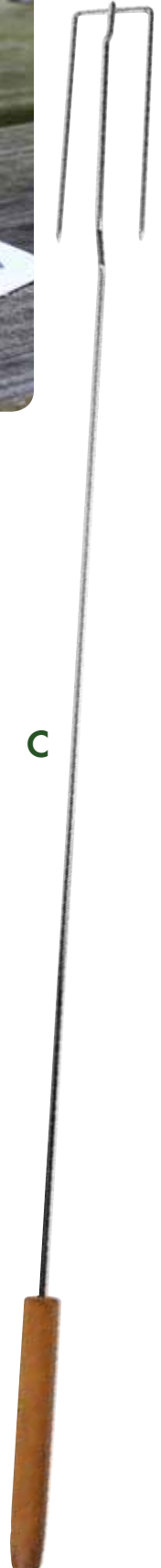

G



A. Tablecloths - Red & White Vinyl Available as tablecloth (52" × 84") only or tablecloth (54" × 84") with two bench covers (18" × 84"). Vinyl material makes for easy cleanup.

- 51018 Tablecloth
- 51019 Tablecloth - bilingual
- 51020 w/bench covers
- 51021 w/bench covers - bilingual

B. Deluxe Tablecloth Clamps are Spring loaded for a more secure hold. Tablecloth clamps fit picnic- or patio tables up to 1.5 inches thick. Set of four.

- 51076 Deluxe Tablecloth Clamps
- 51077 Deluxe Tablecloth Clamps - bilingual



C. Food Cover Tight mesh cover opens like an umbrella to keep your picnic safe from bothersome flies and insects. Cover measures 12 × 12 inches when open.

- 51302 Food Cover - bilingual

D. Expandable Water Carriers Available in 5 liter and 10 liter capacity, these BPA-free drinking water carriers have a built-in reinforced handle and a wide pour spout.

- 51092 5 L Water Carrier - bilingual
- 51093 10 L Water Carrier - bilingual

E. Expandable Water Carrier with spigot Camping water carrier holds 8 liters (2.1 gallons) of water. Screw-on spigot cap allows easy filling and controlled dispensing. Built-in handle for easy carrying. Great for camping or tailgating.

- 51084 Water Carrier with tap
- 51085 Water Carrier with tap - bilingual



F. Egg Carriers These clean, compact and unbreakable egg carriers help prevent eggs from breaking.

- 51012 Holds 6 Eggs
- 51013 Holds 6 Eggs - bilingual
- 51014 Holds 12 Eggs
- 51015 Holds 12 Eggs - bilingual





A. Camp Saw 10-inch triple-edge blade makes this an ideal saw for camping or home. Cuts natural and synthetic wood, plywood, drywall, PVC pipe and more.

51026 Saw w/sheath

51027 Saw w/sheath - bilingual

B. Pocket Saw Handy wire saw is over 20 inches long, but rolls up easily to fit in a pocket. Strong enough to cut through wood, bone, plastic and soft metals.

Wire length: 20.75 inches

51354 Pocket Saw - bilingual

C. Folding Saw Folding saw with triple-edge blade offers high-quality performance. Features comfortable ergonomic handle and a two-position locking blade for safety.

51352 Folding Saw - bilingual

D. Camp Axe A durable camp axe is a must-have tool for every campsite. Use while camping, hiking, backpacking or in the yard. This durable, heavy-duty axe has drop-forged steel head, a steel shaft and non-slip ergonomically designed handle for superior grip. Use the blade to split firewood or help clear areas for camping. Use the blunt side to help drive tent stakes. The included plastic sheath makes it safe to transport when not in use.

51082 Camp Axe

51083 Camp Axe - bilingual

E. Multi-Function Tool Stainless steel tool folds up to fit in pocket or pack. Includes three knife blades, two screwdrivers, can opener, bottle opener, mini-saw, grip teeth, pliers, wire cutters and two rulers. Includes carrying case.

51080 Multi-Function Tool

51081 Multi-Function Tool - bilingual

F. Lantern Hanger Campground-approved lantern hanger won't damage trees. Helps keep bugs up and away from campsite, and works on trees or posts up to 20 inches in diameter.

51054 Lantern Hanger

51055 Lantern Hanger - bilingual





A

A. Sewing Kit 50 yards (45.7 m) assorted thread, 5 needles, needle tube, needle threader, thimble, 8 buttons, 2 snaps, 5 safety pins, 2 straight pins, measuring tape and scissors in a travel-size plastic box.

- 51052 Sewing Kit
- 51053 Sewing Kit - bilingual

B. Folding Scissors Compact folding scissors tuck easily into your pocket, purse or pack. Ideal for fishing, camping or travel.

- 51060 Folding Scissors
- 51061 Folding Scissors - bilingual



B

C. Ditty Bag Set Great for organizing camping or home items. Made of water-repellent nylon and features a push-button draw string. Set contains 3 sizes: 6 x 12.5 inch, 5 x 11 inch, 4.25 x 9 inch

- 51008 Ditty Bag Set - Nylon, 3 pack
- 51009 Ditty Bag Set - Nylon, 3 pack - bilingual



C



D

D. Tent Whisk with Dust Pan

Travel-sized tent whisk snaps into dustpan to keep them together for convenience.

- 51032 Whisk w/dust pan
- 51033 Whisk w/dust pan - bilingual

E. Tent Stakes Made of heavy-duty steel with durable plastic T-stopper.

- 51010 Tent Stakes, 10 inch, 2 pack
- 51011 Tent Stakes, 10 inch, 2 pack - bilingual
- 51086 Tent Stake, 10 inch, bilingual - 100/bulk



E

F. Tent Pegs For tents, awnings, sports nets and more. Made of tough ABS plastic with large non-slip hook. High-visibility color. Set of six 9-inch or 12-inch pegs.

- 51044 Tent Pegs - 9 inch - set of 6
- 51045 Tent Pegs - 9 inch - set of 6 - bilingual
- 51102 Tent Pegs - 9 inch - 100/bulk - bilingual
- 51042 Tent Pegs - 12 inch - set of 6
- 51043 Tent Pegs - 12 inch - set of 6 - bilingual
- 51103 Tent Pegs - 12 inch - 50/bulk - bilingual



F

G. Ultralight Tent Stakes Corrosion-resistant lightweight aluminum stakes with cord for easier removal.

- 51089 Ultralight Tent Stakes - 9" set of 6 - bilingual
- 51106 Ultralight Tent Stakes - 12" set of 6 - bilingual
- 51104 Ultralight Tent Stakes - 9" - 100/bulk - bilingual
- 51105 Ultralight Tent Stakes - 12" - 50/bulk - bilingual



G

H. Tent Stake Puller Plated-steel tent peg puller with comfortable grip allows easy removal of tent pegs.

- 51058 Tent Peg Puller
- 51059 Tent Peg Puller - bilingual



H



A. Portable Toilets are designed for camping, RVing, boating or any other recreational activity. Sturdy polyethylene construction is compact and lightweight. The holding tank is detachable and includes a sealing slide valve to lock in odors and protect against leakage. It includes two side latches to secure the tank to the toilet and a carrying handle for easy transport. The toilet employs an easy-to-use bellow-type flush and pull slide valve for easy flushing. Includes a packet of Camco's TST® biodegradable toilet chemical.

2.5-gallon (12.5"H x 16.25"W x 14.5"D);

5.6-gallon (16.38"H x 13.75"W x 16.13"D)

41531 2.5-gallon - bilingual

41541 5.6-gallon - bilingual

B. TST® Camping Toilet Treatment

100% biodegradable formula stops odors for up to seven days. Use two ounces to treat portable toilets. Eliminates odors and lubricates seals; breaks down waste and tissue. Use 4 ounces to treat a 40-gallon holding tank. Safe for all septic tanks; contains no formaldehyde.

41162 TST Camping - 16 oz

41161 TST Camping - 4 4-oz bottles

C. Camping Toilet Tissue Stay-clean dispenser packs are easy to carry and great for camping. Keep a spare mini-roll or two in the glove compartment for travel. Two rolls per pack; 259 x 4.3 inches per roll. Biodegradable.

51358 Camping Toilet Tissue - bilingual



A

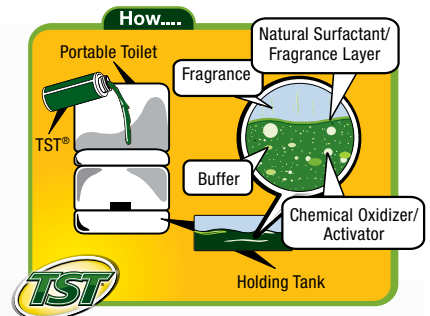

B



C





A



A. LED Lantern/Flashlight Ultra-bright LED with three modes: Ultra-bright, bright and flashing. Lantern telescopes for 360° illumination and has a metal C-ring for hanging; flashlight has adjustable-focus light beam. Powered by three AAA batteries (not included).

51374 LED Lantern/Flashlight - bilingual

B. Multi-Functional LED Lantern

Ultra-bright: up to 120 lumens. Can be set up as a tabletop- or hanging lantern, a spotlight or a lantern/spotlight combo. Lightweight and weather-resistant light has three brightness settings, and is powered by three AAA batteries (not included).

51378 Multi-functional LED Lantern - bilingual



B



C. Light Sticks Set of 6: One each of pink, red, blue, orange, yellow and green. Provide a long-lasting glow in any weather condition; they even work under water. Safe and easy to use; light sticks don't heat up and don't attract insects. Sticks are non-toxic and nonflammable; individually foil wrapped for light/moisture protection.

51336 Light Sticks - bilingual



C





A. Portable Propane Campfire

Features like an elevated fire tray and heat resistant base make this Portable Campfire perfect for use in campgrounds with fire restrictions; great for residential porch and patio use as well. Large 14½-inch burner ring allows for even distribution of gas and flame. 8-ft hose and adjustable regulator allows easy control of desired fire size up to 65,000 BTUs per hour with no ash, no mess and no smoke. Includes two bags of lava rocks. Legs fold completely under to fit into included storage bag.

58041 Propane Campfire



B. Collapsible Fire Ring

Safely contain your campfire with Camco's Portable Campfire Ring. The large, 27-inch-wide steel ring will accommodate your natural wood-burning fire. Six-piece hinged design unfolds and assembles easily with no tools required. Tree cut-outs create a captivating ambiance. Folds flat for storage. Includes a zippered bag for easy transportation.

51091 Folding Fire Ring - bilingual



C. Little Red Campfire™ Take your fire with you! Our compact, portable campfire is great for campsites with restrictions against in-ground fires. Take it tailgating, or put it on the patio...its size is convenient for wherever you need a fire. Realistic log pieces and full 9.5" diameter ring burner help create the natural look and ambiance of from-scratch campfires. Sturdy lid and security latches make it safe and easy to transport. Includes 8' propane hose for use with standard LP gas cylinders. RV campground approved. 11.25" fire tray diameter. 65,000 BTU/HR.

58031 Little Red Campfire™

Replacement **Parts for Little Red Campfire™**

58032 Replacement Log set

58034 Replacement Hose w/Regulator



D. Campfire Propane Adapter

Safely and easily installs to one of Camco's propane connection kits (59103, 59123 or 59143) to use the onboard propane supply to fuel your Campfire. Can also be used to convert any appliance from a Type I ACME to a 1"-20 Throwaway connection for use with a disposable 1-lb bottle of LP Gas.

59213 Propane Adapter





A



B



C

A. Rain Poncho Roomy one-size-fits-all poncho with hood has molded-in side snaps. Reversible; storage bag included. (200 x 127 cm).

51360 Rain Poncho - bilingual

B. Emergency Blanket Waterproof and windproof reflective mylar blanket helps retain body heat. Opens to 52 x 84 inches, folds down small enough to fit in a pocket.

51322 Emergency Blanket - bilingual

C. Survival Poncho This compact, lightweight poncho reflects and helps maintain body heat. Wind- and water-proof poncho can help keep you warm and dry in adverse conditions.

51320 Survival Poncho - bilingual

D. 6-Function Survival Whistle Includes a safety whistle, magnifier, compass, ultra-bright led, signal mirror and Fahrenheit/Celsius thermometer, all in one compact, easy-to-carry tool.

51364 Survival Whistle - bilingual

E. Lensatic Compass Don't get lost while camping! Use this handy compass to find your position using a map and three landmarks.

51362 Lensatic Compass - bilingual

F. Waterproof Pouches Triple-fold pouch tops with hook-and-loop closure and handy strap keep the water out so your valuables stay dry. Three sizes to accommodate everything from cell phones and keys to books and maps. 10.5 x 13.5, 6.75 x 10 and 4.75 x 7 inches.

51340 Waterproof Pouches, set of 3 - bilingual



D



E



F



F



A. Mosquito Net Fine polyester net (400 holes per square inch) helps protect against flying insects. Net has four sewn-in hanging cords and comes with storage bag. Sized to fit a standard camping cot or adult-size sleeping bag. 31 x 78 x 59 inches.

51366 Mosquito Net, Single

B. Tick Remover Remove ticks easily and safely with this tool. Special design holds securely with minimum risk of damaging tick during removal.

51316 Tick Remover

C. Citronella Candle Citronella candle in a convenient metal container with lid for easy storage and transport. Helps keep the bugs away from your camping area.

51022 Citronella Candle

51023 Citronella Candle - bilingual

D. Mosquito Coil Holder Securely holds burning mosquito coils and keeps the ash contained. Can be hung up or placed flat on a table. Uses standard mosquito coils, not included.

51062 Mosquito Coil Holder

51063 Mosquito Coil Holder - bilingual

E. Waterproof Safety Matches Wooden matches work even when damp. Four boxes of 40 each. Strike on box.

51334 Wooden Safety Matches

F. Lighter Flints Replacement flints for lantern lighter or camp stove. Packaged in a resealable storage bag.

51024 Lighter Flints, 10 pack

51025 Lighter Flints, 10 pack - bilingual

G. Magnesium Fire Starter Scrape off magnesium shavings, mix with tinder and strike the fire-steel with the attached sparker. The shavings will burn hot, even when damp, making fire-starting in wet conditions much easier. Compact starter is fireproof when solid.

51332 Magnesium Fire Starter

H. Firestarter Sticks Quick and safe way to start fires. Burn completely without odor. Non-toxic and waterproof. Easy to carry and store.

51016 Firestarter Sticks, 12 pack

51017 Firestarter Sticks, 12 pack - bilingual

A

B

C

E

G

D

F

H





A



On-off valves



A. Solar Camp Shower Enjoy a warm shower, even while camping far from civilization. 5 Gallon/ 20 liter capacity. Holds enough water for 3 or 4 showers. Includes flexible tube, tab, 2 m hanging cord and mini-showerhead. Made of non-toxic UV-Resistant PVC material. With on-off valves at fill cap and at showerhead.

51368 Camp Shower - bilingual

B. Soap Dish Covered soap dish with a securely snapping lid closure and vent holes in the bottom.

51356 Soap Dish - bilingual



B



C

C. Dunk Bag Nylon mesh Dunk Bag will not rot or retain odors. Handy all-purpose bag with sewn-in drawstring is great for laundry or storage. 19" x 22".

51031 Dunk Bag - bilingual

D. Laundry Bag Lightweight fabric laundry bag with mesh vent has a side pocket that doubles as a zippered pouch to hold the bag when its not in use.

51338 Laundry Bag - bilingual



D

E. Laundry Reel Lightweight, compact laundry reel is easy to set up. Contains 21 feet of laundry line and two hooks for easy mounting. Wind-up reel for easy storage.

51064 Laundry Reel

51065 Laundry Reel - bilingual



E



A

A. Propane Distribution Post with Storage Bag

Use up to three propane appliances simultaneously—with just one tank! Lantern, Portable Campfire, Grill, Camp Stove/Griddle, Heater and more. Includes: One 15-inch Propane Distribution Post: Excess Flow, Soft-Nose P.O.L. Propane Tank Connection and THREE—1"–20 Male Throwaway Cylinder—Appliance connections and one 15-inch Propane Distribution Post Extension: 1"–20 Male/Female Throwaway Cylinder Threads. All outlets feature auto-shutoff.

51096 Propane Distribution Post - bilingual



B. Foldable Camp Shovel

Foldable shovel with heavy-duty steel blade. Features serrated edge and locking collar. Folds compactly to carry along in its own storage pouch.

51074 Camp Shovel

51075 Camp Shovel - bilingual



B

C. Multi-Purpose Scissors

Multi-purpose scissors are the ideal tool for camping or home. Detachable stainless steel blades and a variety of useful tools; scissors, screwdriver, can opener, wrench, fish scaler, nutcracker, jar wrench, wire stripper, wire cutter, bottle opener and knife.

51038 Multi-Purpose Scissors

51039 Multipurpose Scissors - bilingual



C

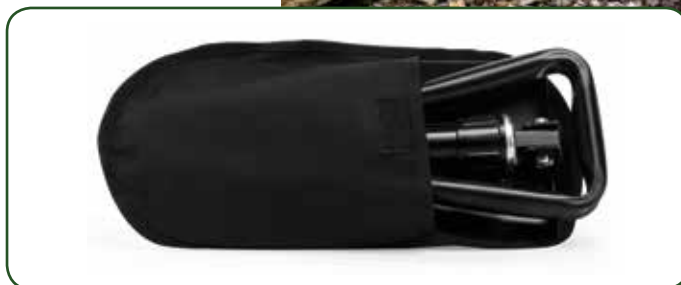

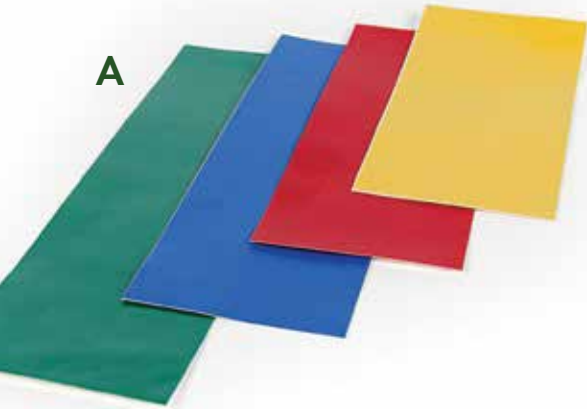

A



B

A. Vinyl Repair Tape For quick repair of rubber or vinyl gear, ground sheets, waders, rain gear and more. Contains four pieces of self-adhesive vinyl.

One each: 3 × 6 inch; 3 × 7 inch; 3 × 8 inch and 3 × 9 inch

51326 Vinyl Repair Tape - bilingual

B. Tarp Clips Two-piece clips work on tarps, plastic sheeting, tents and awnings to create an extra tie-down point without punching a hole in the fabric.

51344 Tarp Clips - Set of 4 - bilingual



C

C

C. Metal Grommet Kit includes heavy duty punch, anvil and 100 sets of 1/2-inch weather-resistant metal grommets. Great for repairing tarps, tents and awnings. Replacement grommet bag includes 20 sets.

51372 Metal Grommet Kit - bilingual

51328 Grommets - 20 sets - bilingual

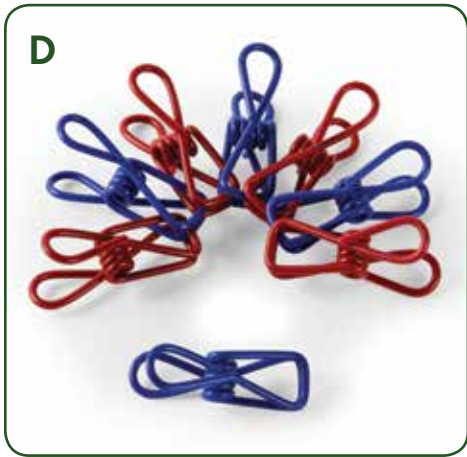

D

E

D. Utility Clips Set of eight clips with protective coating. Permanently string clips onto your 3/16 inch (4.8 mm) or smaller clothes line, so they won't get lost. Can also be used to hang patio lights, or as snack bag clips.

51036 Utility Clips - set of 8

51037 Utility Clips - set of 8 - bilingual



E. Snap Fastener Kit Comes with a flaring tool and setting base. Everything you need to add or replace snap fasteners. For tarps, tents, car or boat covers, awnings and more.

51006 Snap Fastener Kit, 10 Sets

51007 Snap Fastener Kit, 10 Sets - bilingual



F

G

F. Plastic Grommets Grommets for use with plastic or canvas sheets. Just snap together and tap to seal. Set of eight.

51046 Tap-In Grommets - 8-pack

51047 Tap-In Grommets - 8-pack - bilingual

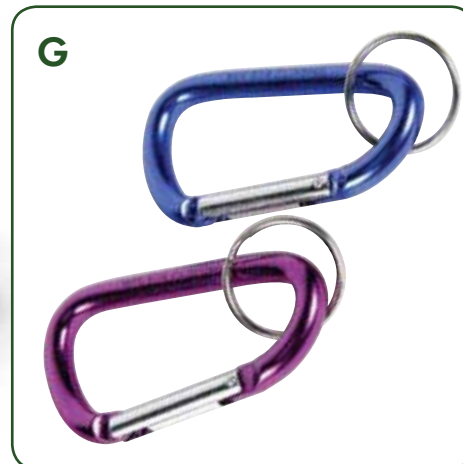

G. Carabiners Aluminum biner clips with key rings. Set of two Three-inch clips in assorted colors. Perfect for attaching light equipment to your backpack or belt. Not for climbing.

51346 Carabiners - set of two - bilingual



A. Utility Straps Durable 1-inch-wide polypropylene straps are ideal for camping or outdoor use. Attached buckle for securing the straps.

- 51066 Utility Strap - 4 ft
- 51067 Utility Strap - 4 ft - bilingual
- 51068 Utility Strap - 6 ft
- 51069 Utility Strap - 6 ft - bilingual
- 51070 Utility Strap - 8 ft
- 51071 Utility Strap - 8 ft - bilingual
- 51072 Utility Strap - 10 ft
- 51073 Utility Strap - 10 ft - bilingual



B. Sleeping Bag Straps Set of two durable 4-ft, 3/4-inch-wide polypropylene straps are ideal for securing sleeping bags, tents and other camping equipment. Attached buckle for fastening the straps.

- 51348 Sleeping Bag Straps - bilingual



C. Stretch Cord Ideal for camping and outdoor use. Coated hardened-steel hooks. Flexible rubber core. Weather-resistant outer layer. 50 inches long.

- 51000 Stretch Cord, 50 inch, 1-Pack
- 51001 Stretch Cord, 50 inch, 1-Pack - bilingual



D. 20-inch Stretch Cords Set of two durable stretch cords. Ideal for camping and outdoor use. Weather-resistant outer layer. Coated hardened-steel hooks and flexible rubber core.

- 51342 Stretch Cords, 20-inch , set of 2 - bilingual

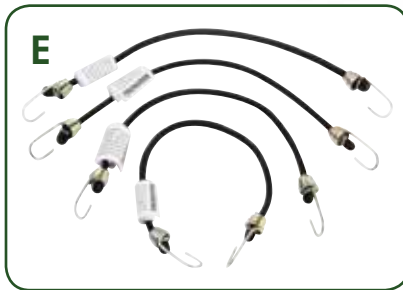

E. Mini Stretch Cords Set of four mini cords; ideal for camping and outdoor use. Hardened-steel hooks. Flexible rubber core. Weather-resistant outer layer.

- 51002 Mini Stretch Cords, 10 inch, 4-pk
- 51003 Mini Stretch Cords, 10 inch, 4-pk - bilingual

F. Braided Poly Cord Polypropylene shell with polyester core. Wound around a reusable plastic spool.

- 51004 Braided Poly Cord, 50 ft, Green
- 51005 Braided Poly Cord, 50 ft, Green - bilingual



G. 50 ft Rope Sturdy polypropylene braided rope for medium-duty camping use. Great around the house as well.

- 51350 50 ft Rope - bilingual



OTHER OUTDOOR PRODUCTS FROM CAMCO

Adirondack Tables Sturdy molded plastic tables fold for easy transport and storage. Available in Champagne, Sage, Charcoal or Brown. Folding Side Table: 15 x 12 x 14 inch. Folding Table: 19.5 x 18 x 15 inch

- 51883 Side Table, Champagne - bilingual
- 51880 Side Table, Sage - bilingual
- 51881 Side Table, Charcoal - bilingual
- 51882 Side Table, Brown - bilingual
- 51887 Table, Champagne - bilingual
- 51884 Table, Sage - bilingual
- 51885 Table, Charcoal - bilingual
- 51886 Table, Brown - bilingual



Aluminum Folding Tables

combine lightweight materials with a durable design. Perfect for RVing, camping, tailgating or out on the porch or patio. Tables set up without tools in seconds and folds to only 2" wide for compact storage.

Small table has a 12" x 10" top, opens to 16.5" tall and supports up to 130 lb. Folded dimensions: 18.5" x 12" x 2".

Large table has a 19.5 x 19" top, opens to 23.7" tall and supports up to 110 lb. Folded dimensions: 28.25 x 19.5 x 2".

FOLD-AWAY TABLES

- 51890 Folding Side Table, 12" x 10" - bilingual
- 51891 Folding Table, 19.5 x 19" - bilingual



Aluminum Roll-up Table

Lightweight functional design makes this table portable, easy to set-up and break down with storage bag included. Hollow, aluminum slat top attaches easily to cross-support bars and segmented legs. Seats 4-6 people. No tools required. The roll-top feature makes the table and bag compact for easy storage.

- 51892 Roll-Up Table w/Carrying Bag - bilingual

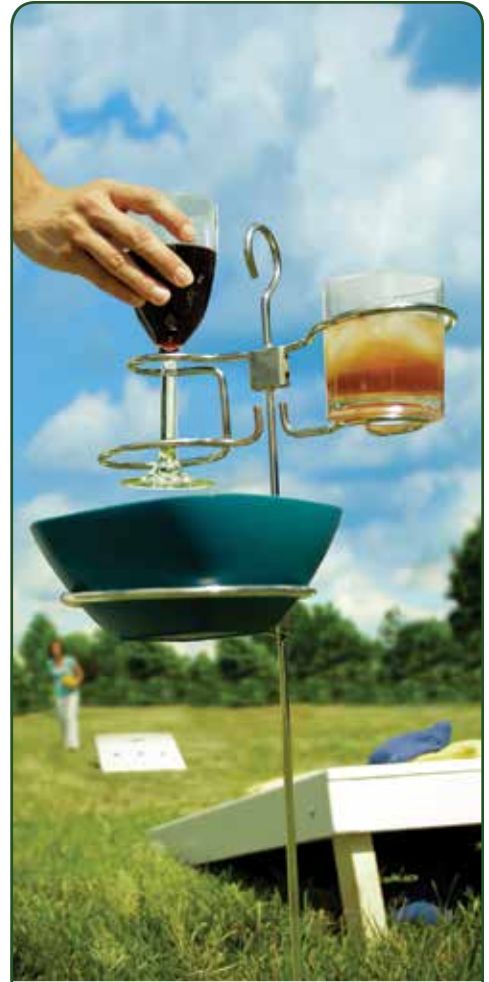

Tipsy Stix®

Holds a variety of beverages and snacks. Beverage holders lock in two ways for standard size beverages. Bonus snack holder holds bowls and plates. Great for outdoor parties and activities. Patent Pending.

- 51463 Tipsy Stix - bilingual



RV Collapsible Bucket The perfect size for RVing, camping, fishing, boating and more. 3 gallon (11 liter) capacity. Opens easily to 9.25" (23.5 cm) tall and folds to less than 2" (3.5 cm) for compact storage. Zippered storage bag included.

42993 Bucket



Handy Mat

This Handy Mat is perfect to take with you wherever you go. Includes built-in handles and convenient pockets on both sides. Folds out to 60 x 78 inches and folds to a compact 10.5 x 15 inches. Perfect for picnics, beaches, RVing and outings. Durable polypropylene may is weather-proof and mold- and mildew-resistant. UV stabilized for years of use. Easily cleans with soap and water.

42805 Handy Mat - bilingual



GardenPure™ Water Filter Promotes healthy plant growth A must-have filter for organic gardeners; reduces chlorine and chloramine compounds. Perfect for hydro- and aero-ponic gardening system. Improve the health of your plants and soil. Attaches to standard garden hose threads.

40694 GardenPure™ Water Filter - bilingual



Folding Grill Stand Use with the 4100 Grill or other appliances. Steel stand folds flat for storage. Powder coated for rust resistance. 14" x 20" x 28". Black.

57321 Universal BBQ Stand



Deluxe Folding Grill Table

Spacious grill table has a lightweight, high strength steel frame and aluminum table top. Quick and easy to set up. Great for picnics, camping, sporting events and backyards. 57.75" w x 19" d x 32" h. Folds to fit in durable carrying case (37" x 20" x 6" - included).

57293 Deluxe Folding Grill Table

