

READ AND SAVE THESE INSTRUCTIONS

WARNING

TO REDUCE THE RISK OF FIRE, ELECTRIC SHOCK, OR INJURY TO PERSONS, OBSERVE THE FOLLOWING:

1. Use this unit only in the manner intended by the manufacturer. If you have questions, contact the manufacturer at the address or telephone number listed in the warranty.
2. Before servicing or cleaning unit, switch power off at service panel and lock the service disconnecting means to prevent power from being switched on accidentally. When the service disconnecting means cannot be locked, securely fasten a prominent warning device, such as a tag, to the service panel.
3. Installation work and electrical wiring must be done by a qualified person(s) in accordance with all applicable codes and standards, including fire-rated construction codes and standards.
4. Sufficient air is needed for proper combustion and exhausting of gases through the flue (chimney) of fuel burning equipment to prevent backdrafting. Follow the heating equipment manufacturer's guideline and safety standards such as those published by the National Fire Protection Association (NFPA), and the American Society for Heating, Refrigeration and Air Conditioning Engineers (ASHRAE), and the local code authorities.
5. When cutting or drilling into wall or ceiling, do not damage electrical wiring and other hidden utilities.
6. Ducted fans must always be vented to the outdoors.
7. If this unit is to be installed over a tub or shower, it must be marked as appropriate for the application and be connected to a GFCI (Ground Fault Circuit Interrupter) - protected branch circuit.
8. Never place a switch where it can be reached from a tub or shower.
9. **Fluorescent models only:** Do not use a dimmer switch to control the light of this unit.
10. This unit must be grounded.

CAUTION

1. For general ventilating use only. Do not use to exhaust hazardous or explosive materials and vapors.
2. This product is designed for ceiling installation only. This product is designed for installation in ceilings up to a 12/12 pitch. Ductwork must point up. DO NOT MOUNT THIS PRODUCT IN A WALL.
3. To avoid motor bearing damage and noisy and/or unbalanced impellers, keep drywall spray, construction dust, etc. off power unit.
4. Please read specification label on product for further information and requirements.

Installer: Leave this manual with the homeowner. Homeowner: Use and Care information on page 4.

TYPICAL INSTALLATIONS

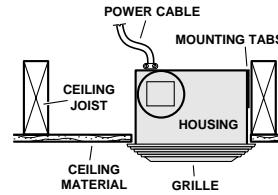

HOUSING MOUNTED DIRECTLY TO JOIST
2x6 (or larger) Discharge parallel to joists.

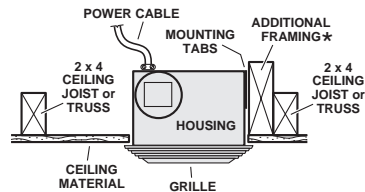

HOUSING MOUNTED TO 2x4 TRUSS
Requires additional framing for mounting tabs.
Discharge parallel to joists.

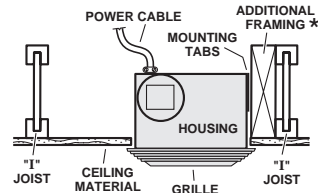

HOUSING MOUNTED TO "1" JOIST
Requires additional framing for mounting tabs.
Discharge parallel to joists.

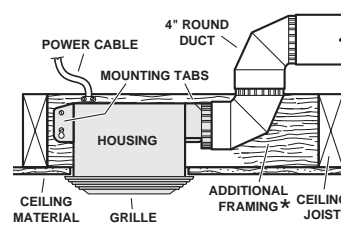

HOUSING MOUNTED TO ADDITIONAL FRAMING
Discharge 90° to joists.

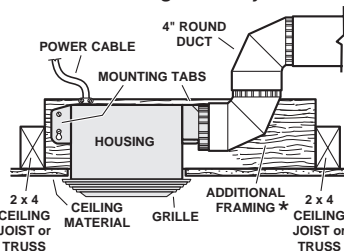

HOUSING MOUNTED TO 2x4 TRUSS
Requires additional framing for mounting tabs.
Discharge 90° to joists.

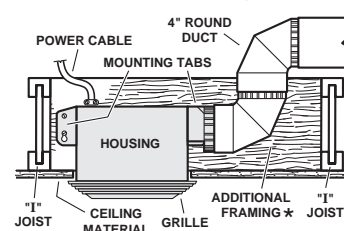

HOUSING MOUNTED TO "1" JOIST
Requires additional framing for mounting tabs.
Discharge 90° to joists.

* Additional framing must be a 2x6 (minimum height).

TYPICAL INSTALLATIONS

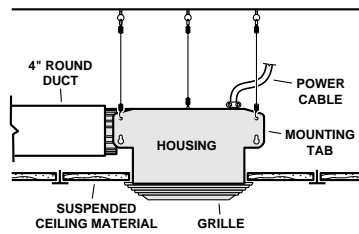

SUSPENDED CEILINGS

Housing hung with wires - 3-point mount.

INSTALL THE HOUSING

- PLEASE NOTE -

THE FOLLOWING INSTALLATION ILLUSTRATIONS SHOW 2 X 6 JOISTS. IF YOU HAVE A TRUSS OR "I"-JOIST INSTALLATION, MOUNT THE VENTILATOR TO THE ADDITIONAL FRAMING IN THE SAME MANNER. (Additional framing must be a 2x6 (minimum height).

New Construction

1. Choose the location for your fan in the ceiling. For best possible performance, use the shortest possible duct run and a minimum number of elbows.
2. Position mounting brackets against joist so that bottom edge of housing will be flush with finished ceiling.

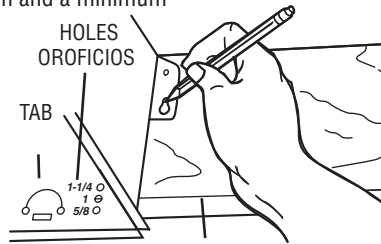

Additional positioning feature for 5/8", 1", & 1-1/4" thick ceiling material:

Holes in corners of housing are labeled with various ceiling material thicknesses. Position housing so bottom edge of joist is visible through a matched set of holes. The housing is now in the proper position for that ceiling material thickness.

Additional positioning feature for 1/2" thick ceiling material:

Bend two tabs, on side of housing, 90° outward. Lift housing until tabs contact underside of joist.

Mark the keyhole slot on both mounting brackets.

3. Set housing aside and drive nails partially into joist at the top of both keyhole marks.

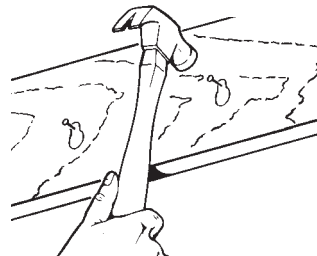

4. Hang housing from nails and pound nails tight. To ensure a noise-free mount, pound another nail through the top hole of each mounting tab.

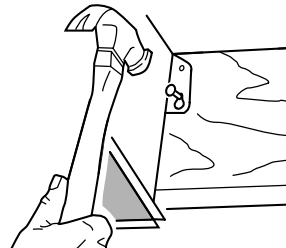

INSTALL THE HOUSING

Existing Construction

1. Choose the location for your fan/light in the ceiling. For best possible performance, use the shortest possible duct run and a minimum number of elbows.
2. In attic, position mounting brackets against joist. Trace outline of housing on ceiling material.
3. Set housing aside and cut ceiling opening slightly larger than marked.
4. Place housing in opening so that its bottom edge is flush with finished ceiling. Nail to joist through keyhole on both sides. To ensure a noise-free installation, drive another nail through the top hole of each mounting bracket.
5. Additional mounting holes are provided for installations where access from above is inconvenient or not possible. Nail or screw housing directly to joists or framing.

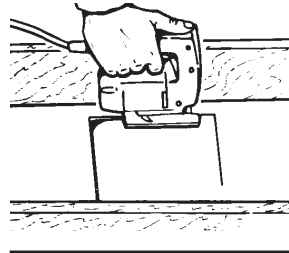
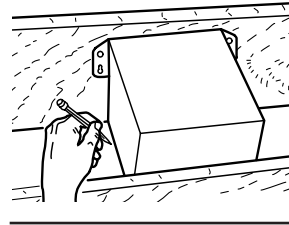

INSTALL THE DUCTWORK

NOTE: The duct connector has a counter-balanced damper flap. The flap will be "open" approx. 1" when duct connector is attached to housing. This design permits insulation to be in direct contact with fan/light housing per UL (Underwriters Laboratories) standards. The slightest backdraft, however, will close the damper flap, preventing air from entering unit or finished space.

1. Snap the damper/duct connector onto housing. Make sure that tabs on the connector lock into slots in housing. Top of damper/duct connector should be flush with top of housing.

NOTE: Make sure damper flap is in place inside of duct connector. If it is not: ① Squeeze top and bottom of connector to ② snap flap back into place.

2. Connect 4" round duct to damper/duct connector and extend duct to outside through a roof or wall cap. Check damper to make sure that it opens freely. Tape all duct connections to make them secure and air tight.

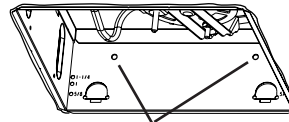
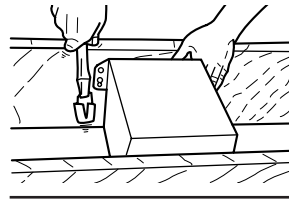

ADDITIONAL MOUNTING HOLES

CONNECT THE WIRING

1. Wire unit following diagram. Run electrical cable as direct as possible to unit. Do not allow cable to touch sides or top of unit after installation is complete.

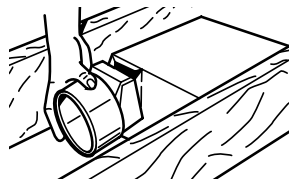

FLUSH AL RAS

ATTACH THE GRILLE

1. Slide light reflector into front of grille opening. Plug light into WHITE receptacle. Place grille / reflector combination over protruding screw, and fasten in place using acorn nut provided. **HAND TIGHTEN** acorn nut 1/4 turn after it is snug. **NOTE:** If grille and light reflector are not snug to ceiling, use a nut driver or pliers on acorn nut to snug grille to ceiling.
2. Install light bulb (not included). (See next page for type and size for your model.) Insert one tab on light lens into a slot in the grille / reflector combination. Squeeze other tab slightly and snap into remaining slot.

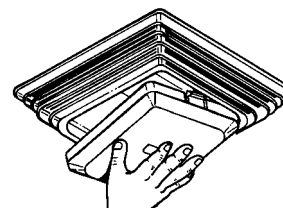
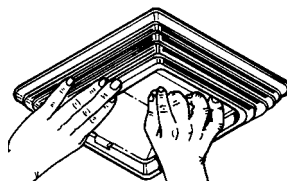
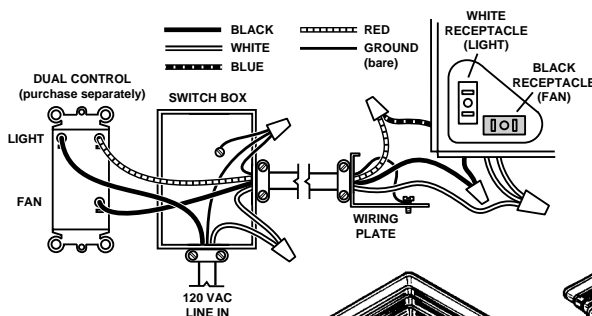
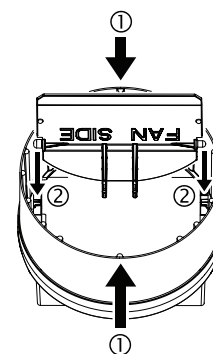
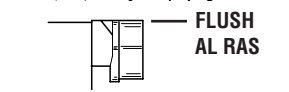

USE AND CARE

WARNING: DISCONNECT ELECTRICAL POWER SUPPLY AND LOCK OUT SERVICE PANEL BEFORE CLEANING OR SERVICING THIS UNIT.

BULB REPLACEMENT

Remove lens by gently depressing sides and pull down.
Use 100 Watt maximum incandescent bulb.

MOTOR LUBRICATION

The motor is permanently lubricated. Do not oil or disassemble motor.

CLEANING

TO CLEAN LENS AND GRILLE:

Remove light lens and bulb. Remove nut in center of reflector and lower assembly.
CAUTION: Grille and reflector are separate units. Unplug light from WHITE receptacle. Plastic parts can be cleaned with mild, soapy water (use a mild detergent, such as dishwashing liquid) and dried with a soft cloth. Do not use abrasive cloth, steel wool pads, or scouring powders.

TO CLEAN FAN ASSEMBLY:

Unplug fan assembly (BLACK receptacle). To remove motor plate: Find the single tab on the motor plate (located next to the receptacles). Push up near motor plate tab while pushing out on side of housing. Or insert a straight-blade screwdriver into slot in housing (next to tab) and twist screwdriver. Gently vacuum fan, motor and interior of housing. METAL AND ELECTRICAL PARTS SHOULD NEVER BE IMMERSSED IN WATER.

SERVICE PARTS

KEY Nº. CLAVE	PART NO. Nº. PIEZA	DESCRIPTION/DESCRIPCIÓN
1	97013578	Light Lens
2	97005316	Acorn Nut
3	1101299	Bulb Holder
4	97014211	Light Reflector
*	97014212	Light Reflector Assembly (includes Key Nos. 3 & 4)
5	97013974	Grille
6	97014926	Motor Plate
7	99260428	Motor Nut (2 req.)
8	99150582	Grille Screw
9	97015163	Blower Assembly (678)
10	97015165	Blower Assembly (679) (Blower Assemblies include Motor, Impeller, 6, 7 & 8)
11	99270982	Receptacle (Black)
12	99270981	Receptacle (White)
13	98009612	Wire Panel
*	97015171	Wire Panel Assembly (includes Key Nos. 11,12,13)
14	97014922	Housing
15	97014185	Damper
16	98008868	Wiring Plate
17	99150575	Screw, #8-18 x .375
18	99150471	Ground Screw

* Not shown assembled.
Order replacement parts by "PART NO." - not by "KEY NO."

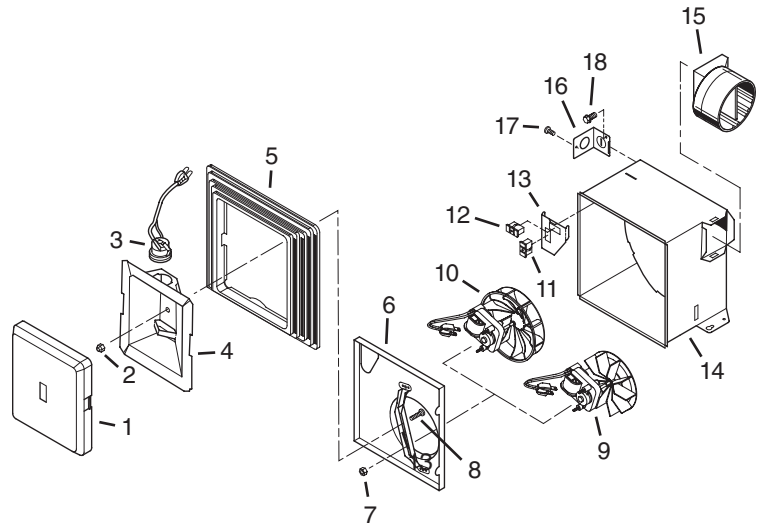

99045987B