

MODELS 670, 671, 671MX, 688 & 689 CEILING/WALL FANS

BROAN®

READ AND SAVE THESE INSTRUCTIONS

WARNING

TO REDUCE THE RISK OF FIRE, ELECTRIC SHOCK, OR INJURY TO PERSONS, OBSERVE THE FOLLOWING:

1. Use this unit only in the manner intended by the manufacturer. If you have questions, contact the manufacturer at the address or telephone number listed in the warranty.
2. Before servicing or cleaning unit, switch power off at service panel and lock the service disconnect means to prevent power from being switched on accidentally. When the service disconnect means cannot be locked, securely fasten a prominent warning device, such as a tag, to the service panel.
3. Installation work and electrical wiring must be done by a qualified person(s) in accordance with all applicable codes and standards, including fire-rated construction codes and standards.
4. Sufficient air is needed for proper combustion and exhausting of gases through the flue (chimney) of fuel burning equipment to prevent backdrafting. Follow the heating equipment manufacturer's guideline and safety standards such as those published by the National Fire Protection Association (NFPA), and the American Society for Heating, Refrigeration and Air Conditioning Engineers (ASHRAE), and the local code authorities.
5. When cutting or drilling into wall or ceiling, do not damage electrical wiring and other hidden utilities.
6. Ducted fans must always be vented to the outdoors.
7. Acceptable for use over a bathtub or shower when installed in a GFCI protected branch circuit.
8. Install fan at least five feet (1.52 m) above the floor.
9. Never place a switch where it can be reached from a tub or shower.
10. This unit must be grounded.

CAUTION

1. For general ventilating use only. Do not use to exhaust hazardous or explosive materials and vapors.
2. To avoid motor bearing damage and noisy and/or unbalanced impellers, keep drywall spray, construction dust, etc. off power unit.
3. Please read specification label on product for further information and requirements.

USE AND CARE

DISCONNECT ELECTRIC POWER SUPPLY AND LOCK OUT SERVICE PANEL BEFORE SERVICING THE UNIT.

PREVENTATIVE MAINTENANCE

A clean fan provides better service. Disconnect the power supply and clean the fan as described below:

TO CLEAN GRILLE - Use a mild detergent, such as dishwashing liquid, and dry with a soft cloth. DO NOT USE ABRASIVE CLOTHS, STEEL WOOL PADS, OR SCOURING POWDERS.

TO CLEAN FAN ASSEMBLY - Unplug motor cord from receptacle. To remove motor plate: Find the single tab on the motor plate (located next to the receptacle). Push up near motor plate tab while pushing out on side of housing. Or insert a straight-blade screwdriver into slot in housing (next to tab) and twist screwdriver. Gently vacuum fan, motor and interior of housing. METAL AND ELECTRICAL PARTS SHOULD NEVER BE IMMERSSED IN WATER.

TO REASSEMBLE ALL ABOVE PARTS - Reverse all procedures explained above.

MAINTENANCE

The motor is permanently lubricated and never needs oiling. If the motor bearings are making excessive or unusual noises, replace the motor with the exact service motor. You should replace the impeller at the same time.

INSTALLATION

1. Remove motor plate from housing by pushing down on rib in plate while pulling out on side of housing. Motor plate may also be removed by inserting a straight-blade screw driver into slot in housing and twisting screw driver. (FIG. 1)
2. Remove wiring cover from housing by pulling straight out. Unit is shipped ready to wire through the top of housing. To wire through the side, bend housing flap to cover top hole and expose side hole. DO NOT BREAK OFF FLAP. If flap breaks, Plug unused hole using standard electrical hole plug. (FIG. 2)
3. **Turn off electrical power at service entrance** and connect power cable to housing using appropriate connector. Wire black to black, white to white, and green to green or bare wire. Push all wiring up into corner of unit and replace wiring cover. Make sure cover holds housing flap in place against side or top of housing.
CAUTION: DO NOT ALLOW WIRES TO EXTEND OUTSIDE OF WIRING BOX. Wire left exposed will become pinched or cut when motor plate is installed. Electrical shock may result. (FIG. 3)
4. Choose the location for your fan. For best performance, use the shortest possible duct run and a minimum number of elbows. For wall installations: Position unit so damper flap closes when unit is off.

FIG. 1

SCREWDRIVER
SLOT

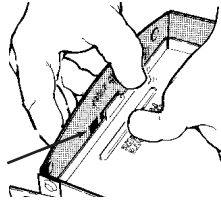

FIG. 2

WIRING
COVER

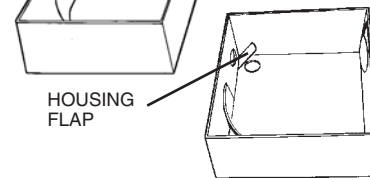
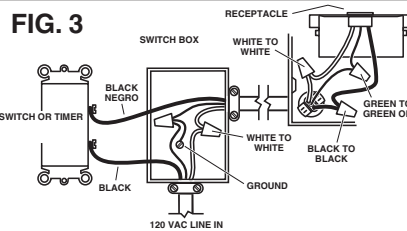

FIG. 3



5. New installation prior to finishing the ceiling or wall:

MAKE SURE HOUSING WILL BE FLUSH WITH FINISHED CEILING OR WALL. Slotted tabs are provided to locate housing flush with 1/2" ceiling or wall material. Bend tabs outward 90° (use a screwdriver if desired) and position housing so that tabs rest against bottom edge of joists (or front of stud). Nail housing to joist or stud using four nails to ensure a solid, quiet installation. **Ceiling installations:** Tabs on opposite side of housing can be bent outward to rest on top of 1/2" ceiling material and provide extra stability. (FIG. 4)

5. Replacement installation:

Position housing so that it is centered in existing opening. MAKE SURE HOUSING IS FLUSH WITH FINISHED CEILING OR WALL. After making electrical and ductwork connections (see steps 4, 5 and 6), nail housing in place. Drive nails through the housing where indicated by arrows. (FIG. 5)

5. New installation in an existing ceiling or wall:

From above ceiling or behind wall, position housing against stud or joist. Trace outline of housing on ceiling or wall material. (FIG. 6) Set housing aside and cut opening. Place housing in opening such that its **BOTTOM EDGE IS FLUSH WITH FINISHED CEILING OR WALL**. 1/2" ceiling or wall material: Bend tabs outward 90° (use a screwdriver if desired) to rest on top of ceiling or wall material and provide extra stability. Nail in place using four nails to ensure a solid, quiet installation. (FIG. 7)

6. Install 3" round duct onto damper/duct connector. If rigid ductwork is used, its seam should be positioned at top of damper/duct connector. Tape the joint and extend ducting to a wall cap or roof cap. Make sure the damper operates freely. Ceiling or wall can now be finished.

NOTE: If damper detaches from duct connector, re-insert it by squeezing duct connector top-to-bottom while guiding posts on damper flap into holders in duct connector. The horizontal rib should be on the outside surface of damper flap and damper flap should move freely inside of duct connector.

7. Replace the motor plate removed in Step 1. Insert two motor plate tabs into slots in housing and then pivot motor plate up until the third tab on plate snaps into matching slot in housing. Make sure tabs hold motor plate securely in place. Plug in motor. (FIG. 8)

8. Squeeze grille springs together and insert springs into slots in motor plate. (FIG. 9) Push grille up against ceiling or wall. (FIG. 10)

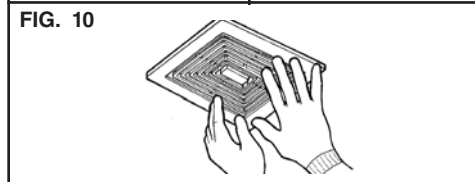
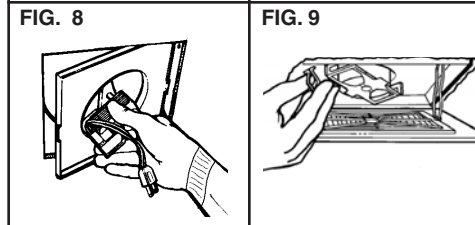
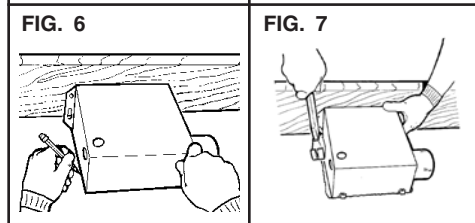
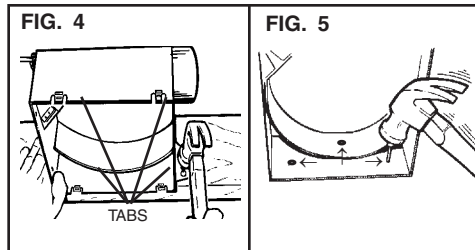

SERVICE PARTS

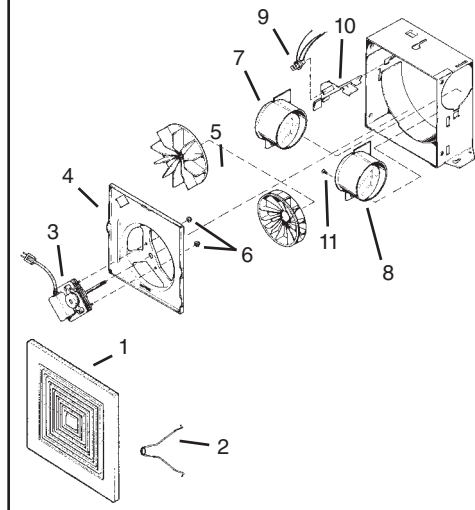

SERVICE PARTS	KEY NO.	PART NUMBER
Grille Assembly (Includes Key Nos 1 & 2)	1	S97011668
Grille Spring (2 Required)	2	S99140187
Motor (Model 670)	3	S99080254
Motor (Model 671, 671MX)		S99080255
Motor (Model 688)		S97012041
Motor (Model 689)		S97012042
Motor Plate	4	S98006791
Blower Wheel (Model 670, 671, 671MX)	5	S99020292
Blower Wheel (Model 688 & 689)		S99111002
Nut #6-32 (2 Required)	6	S99260428
Damper/Duct Connector (Models 670, 671, 671MX, 688, 689)	7	S97016377
Damper/Duct Connector (Model 1667HMTL)	8	S97015577
Receptacle	9	S99271654
Wiring Cover	10	S98006773
Screw, #8-18	11	S99150478

Always order replacement parts by "PART NUMBER" - not by "KEY NO."