

COMBINATION UNITS
MODEL 656 HEATER/LIGHT
MODEL 658 HEATER/FAN
656F AND 658F FINISH PACKS FOR USE
WITH 654H HOUSING PACKS.

BROAN®

**READ AND SAVE
THESE INSTRUCTIONS**

IMPORTANT INSTRUCTIONS

READ ALL INSTRUCTIONS BEFORE INSTALLING OR USING THIS HEATER.

To reduce the risk of fire, electric shock, or injury to persons, observe the following:

1. Use this unit only in the manner intended by the manufacturer. If you have questions, contact the manufacturer at the address or telephone number listed in the warranty.
2. Before servicing or cleaning unit, switch power off at service panel and lock the service disconnecting means to prevent power from being switched on accidentally. When the service disconnecting means cannot be locked, securely fasten a prominent warning device, such as a tag, to the service panel.
3. Installation work and electrical wiring must be done by a qualified person(s) in accordance with all applicable codes and standards, including fire-rated construction codes and standards.
4. When cutting or drilling into wall or ceiling, do not damage electrical wiring and other hidden utilities.
5. This heater is hot when in use. To avoid burns, do not let bare skin touch hot surfaces. Keep combustible materials, such as furniture, pillows, bedding, papers, clothes, etc. and curtains at least 3 feet (0.9 m) from the front of the heater.
6. Extreme caution is necessary when any heater is used by or near children or invalids and whenever the heater is left operating and unattended.
7. Do not operate any heater after it malfunctions. Disconnect power at service panel and have heater inspected by a reputable electrician before reusing.
8. Do not use outdoors.
9. To disconnect heater, turn controls to off, and turn off power to heater circuit at main disconnect panel (or operate internal disconnect switch, if provided).
10. Do not insert or allow foreign objects to enter any ventilation or exhaust opening, as this may cause an electric shock or fire, or damage the heater.
11. To prevent a possible fire, do not block air intakes or exhaust in any manner.
12. A heater has hot and arcing or sparking parts inside. Do not use it in areas where gasoline, paint, or flammable vapors or liquids are used or stored.
13. Use this heater only as described in this manual. Any other use not recommended by the manufacturer may cause fire, electric shock, or injury to persons.
14. To avoid electrical shock: Do not install unit in a tub or shower enclosure or any location where it may come in contact with water. Never place a switch where it can be reached from a tub or shower.
15. Do not connect heater to dimmer switch or speed control.
16. Provide a separate 15 AMP circuit. Use 14 GA. power cable of type which meets code.
17. This product is designed for ceiling installation only. This product is designed for installation in ceilings up to a12/12 pitch. Ductwork must point up. **DO NOT MOUNT THIS PRODUCT IN A WALL.**
18. Install in ceiling only, at least 6" from any wall.
19. The product must be grounded.

SAVE THESE INSTRUCTIONS

TOOLS AND MATERIALS REQUIRED

- Straight-blade & Phillips screwdrivers
- Saber or Keyhole Saw
- Hammer
- Pliers or Nut Driver

MODEL 658 ONLY

- 4" round duct and elbows (as needed)
- Roof or wall cap
- Duct tape
- Electrical supplies (to comply with codes)

PREPARATION

1. Unplug the heater assembly from the RED receptacle.
2. Loosen the two retaining screws on the inside of the heater discharge opening.
Place a screwdriver tip between the outer wall of the discharge opening and the fan housing. Gently pry outward until the exhaust discharge slips off the support lip on the outer housing. (FIG. 1)
3. Unhook hinge pins and lift heater assembly out of housing. (FIG. 2)

CAUTION: Remove the shipping ring from the heater blower inlet before operating the heater.

STEPS 4 & 5 - MODEL 658 ONLY

4. Unplug the fan assembly from the BLACK receptacle. Remove the plastic bag and set it aside.
 5. Remove the mounting screw and carefully lift the fan assembly out of the housing. (FIG. 3)
6. Refer to the wiring diagram of your unit on the next page. Remove appropriate knockout(s) by inserting a screwdriver blade into slots and bending it back and forth to break tabs. (FIG. 4)
 7. Insert the adjustable mounting brackets into the bracket channels on the housing. (FIG. 5)

FIG. 1

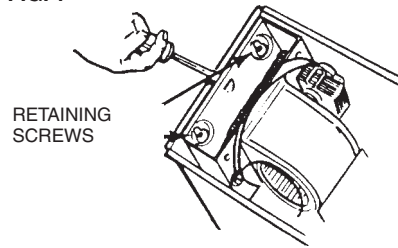

FIG. 2

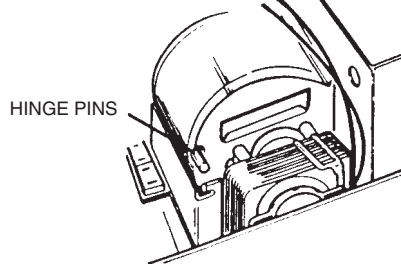

FIG. 3

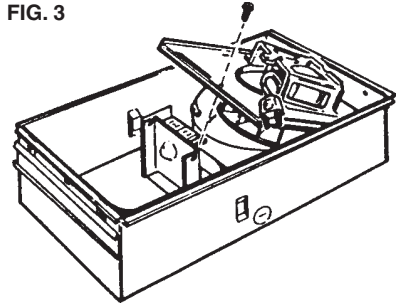

FIG. 4

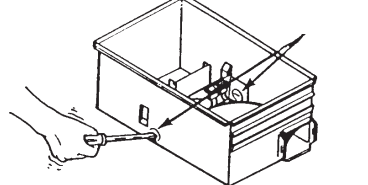
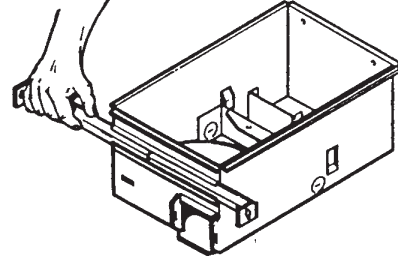

FIG. 5



INSTALLATION

WARNING: To reduce the risk of fire, do not store or use gasoline or other flammable vapors and liquids in the vicinity of the heater.

CAUTION: High temperature, risk of fire, keep electrical cords, drapery, furnishings, and other combustibles at least 3 feet (0.9 m) from the front of the heater and away from the side and rear.

STEP 8 - MODEL 658 ONLY

8. For best results, choose a location which allows fan to be vented outside with the shortest possible duct run and the fewest number of elbows. (FIG. 6)
9. Position unit between joists and extend mounting brackets. Position brackets such that bottom edge of housing will be flush with finished ceiling. Mark the top of keyhole slot on all four mounting brackets. (FIG. 6)
10. Remove unit temporarily, and pound nails partially into joists at all four marked locations. (FIG. 7)
11. Hang unit from nails and use embossed measuring guides to check if unit will be flush with finished ceiling. Pound nails tight. For wide joist centers: A #8 x 3/8 self-tapping screw can be used to join extended brackets together and create a rigid mount. To ensure a noise-free mount, crimp the bracket channels tightly around mounting brackets. (FIG. 8)

STEP 12 - MODEL 658 ONLY

12. Snap the damper/duct connector onto housing. Make sure that tabs on the connector lock in housing slots. (Top of damper/duct connector will be flush with top of housing.) (FIG. 9)
- NOTE:** Make sure damper flap is in place inside of duct connector. If it is not: ① Squeeze top and bottom of connector to ② snap flap back into place. (FIG. 10)

Installation work and electrical wiring must be done by a qualified person(s) in accordance with all applicable codes and standards, including fire-rated construction codes and standards.

13. Wire unit according to appropriate diagram. (FIG. 11 or FIG. 12)

NOTE

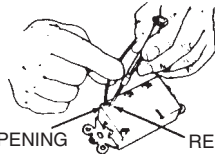

WIRING OPENING RELEASE SLOT

If the switch has not been wired properly and wires need to be moved:

1. Each wire opening has a release slot.
2. Push a small nail or screwdriver into release slot while gently removing wire.
3. DO NOT pull any wire out of the switch without using the release slot. The switch may be damaged.

14. Replace heater assembly removed in STEP 3 and plug it into RED receptacle. Direct wires away from blower inlet.

FIG. 6

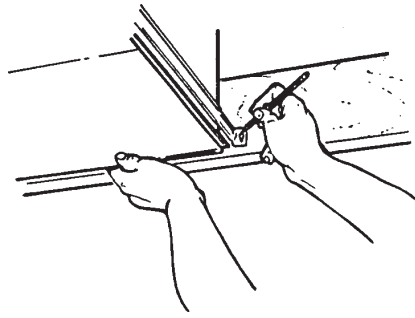

FIG. 7

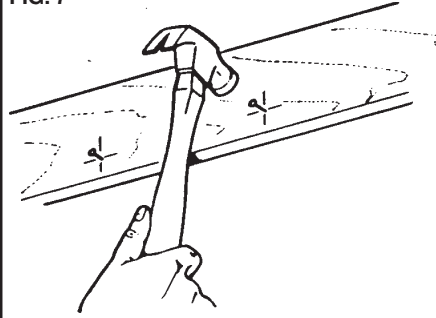

FIG. 8

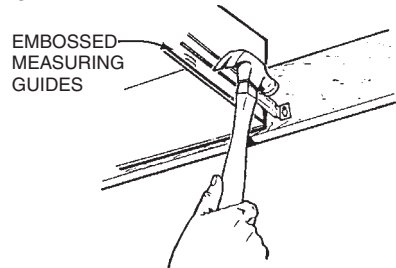

FIG. 9

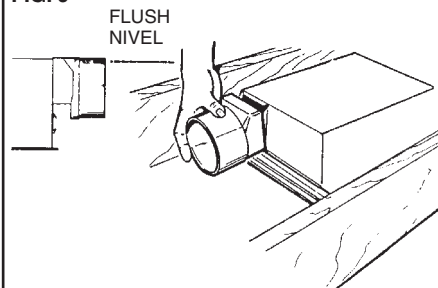
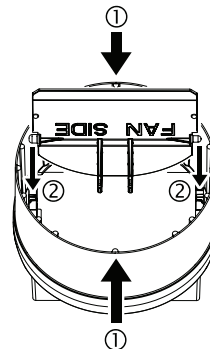

FIG. 10



STEP 15 - MODEL 658 ONLY

15. Replace fan assembly removed in STEP 5 and plug it into BLACK receptacle.

STEPS 16 & 17 - MODEL 656 ONLY

CAUTION: To avoid the possibility of overheating and/or fire, the grille must be installed as shown in Fig. 13. Acorn nut and tooth washer must attach to threaded rod through proper hole in light reflector.

16. Slide the light reflector into opening in grille and plug into WHITE receptacle. Use acorn nut and tooth washer from plastic bag to attach grille/reflector assembly to threaded rod on housing. Tighten securely using pliers or nut driver. Install a light bulb 100 Watt maximum. (FIG. 13)

17. Install light lens by (1) hooking one of its tabs into notch in grille/reflector assembly; (2) apply light pressure to other tab with fingertips and (3) snap into place. (FIG. 14)

STEP 18 - MODEL 658 ONLY

18. Fasten grille with single grille screw. Snap grille button into place over screw. (FIG. 15)

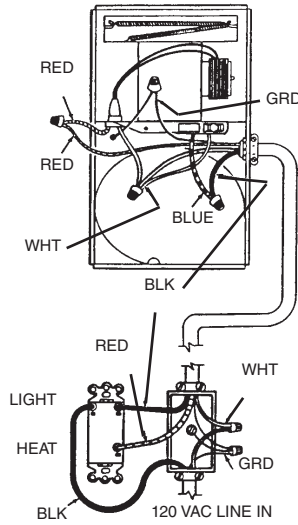
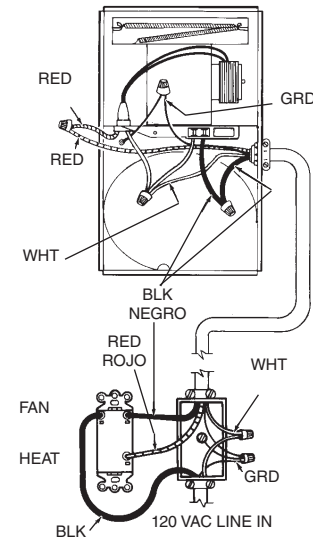
FIG. 11 MODEL 656**FIG. 12 MODEL 658**

OPERATION

Before using heater, make sure heater has been properly installed according to installation steps beginning with the "PREPARATION" section.

MAINTENANCE

TO REPLACE BULB - Remove lens by gently depressing sides and pull down. Use bulb rated up to 100 watts only.

LUBRICATION

The heater is permanently lubricated and never needs oiling or disassembly.

CLEANING

Clean heater once a month as follows:

1. Turn off power at service panel.
2. Make sure heating element is cool.
3. Use a soft brush attachment to gently vacuum grille openings or wipe grille clean with a soft cloth.
4. Restore power.

CAUTION: METAL AND ELECTRICAL PARTS SHOULD NEVER BE IMMERSSED IN WATER.

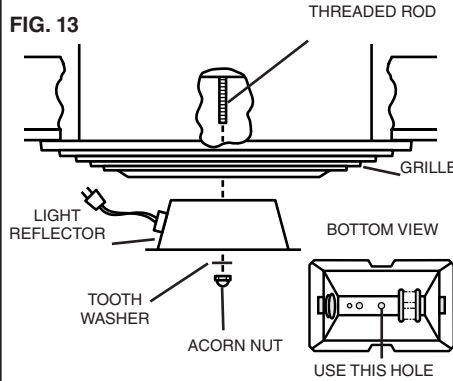
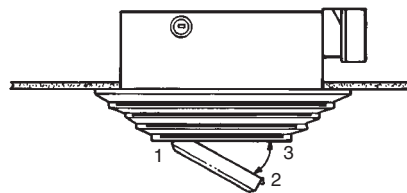
FIG. 13**FIG. 14****FIG. 15**