

BLACK+ DECKER™

CORDLESS HAND VACS

INSTRUCTION MANUAL

CATALOG NUMBERS

HHVI315JO

HHVI320JR

HHVI325JR

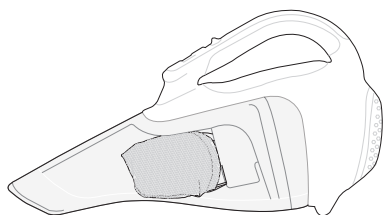

HHVI315JO

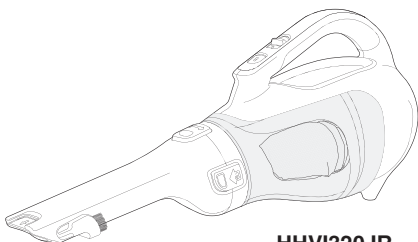

HHVI320JR
HHVI325JR

Thank you for choosing BLACK+DECKER!

PLEASE READ BEFORE RETURNING THIS PRODUCT FOR ANY REASON.

SAVE THIS MANUAL FOR FUTURE REFERENCE.

*XX is a placeholder for the two-digit number at the end of your vacuum's catalog number that designates your vacuum's color.

SAFETY GUIDELINES - DEFINITIONS

It is important for you to read and understand this manual.

The information it contains relates to protecting YOUR SAFETY and PREVENTING PROBLEMS. The symbols below are used to help you recognize this information.

⚠ DANGER: Indicates an imminently hazardous situation which, if not avoided, will result in death or serious injury.

⚠ WARNING: Indicates a potentially hazardous situation which, if not avoided, could result in death or serious injury.

⚠ CAUTION: Indicates a potentially hazardous situation which, if not avoided, may result in minor or moderate injury.

NOTICE: Used without the safety alert symbol indicates potentially hazardous situation which, if not avoided, may result in property damage.

IMPORTANT SAFETY INSTRUCTIONS

When using an electrical appliances, basic precautions should always be followed, including the following:

READ ALL INSTRUCTIONS BEFORE USING THIS APPLIANCE.

⚠ WARNING: Read all safety warnings and all instructions. Failure to follow the warnings and instructions listed below may result in electric shock, fire and/or serious injury.

⚠ WARNING: Some household dust contains chemicals known to the State of California to cause cancer, birth defects or other reproductive harm such as asbestos and lead in lead based paint.

⚠ WARNING: To reduce the risk of fire, electrical shock or injury:

- **⚠ WARNING:** To reduce the risk of electric shock – Do not use outdoors or on wet surfaces.
- Do not allow to be used as a toy. Close attention is necessary when used by or near children.
- Use only as described in this manual. Use only manufacturer's recommended attachments.
- Do not use with damaged cord or plug. If appliance is not working as it should, has been dropped, damaged, left outdoors, or dropped into water, return it to a service center.
- Do not pull or carry by cord, use cord as a handle, close a door on cord, or pull cord around sharp edges or corners. Do not run appliance over cord. Keep cord away from heated surfaces.
- Do not unplug by pulling on cord. To unplug, grasp the plug, not the cord.
- Do not handle charger, including charger plug, and charger terminals with wet hands.
- Do not put any object into openings. Do

not use with any opening blocked; keep free of dust, lint, hair, and anything that may reduce air flow.

- Keep hair, loose clothing, fingers, and all parts of body away from openings and moving parts.
- Use extra care when cleaning on stairs.
- Do not use to pick up flammable or combustible liquids, such as gasoline, or use in areas where they may be present.
- Do not pick up anything that is burning or smoking, such as cigarettes, matches, or hot ashes.
- Do not use without dust bag and/or filters in place.
- Do not charge the unit outdoors.
- Use only the charger supplied by the manufacturer to recharge.
- Do not incinerate the appliance even if it is severely damaged. The batteries can explode in a fire.
- This appliance is intended for household use only and not for commercial or industrial use.
- Shock Hazard. To protect against risk of electrical shock, do not put unit or charging base in water or other liquid.
- Do not allow the cord to hang over the edge of a table or counter or touch hot surfaces. The unit should be placed or mounted away from sinks and hot surfaces.
- Plug the charger directly into an electrical outlet.
- Use the charger only in a standard electrical outlet (120V/60Hz).
- Unplug the charger from outlet before any routine cleaning or maintenance.
- This product includes rechargeable nickel cadmium batteries. Do not incinerate batteries as they will explode at high temperatures.
- Leaks from battery cells can occur under extreme conditions. If the liquid, which is a 20-35% solution of potassium hydroxide, gets on the skin (1) wash quickly with soap and water or (2) neutralize with a mild acid such as lemon juice or vinegar. If the liquid gets into the eyes, flush them immediately

with clean water for a minimum of 10 minutes. Seek medical attention.

- Do not look into the air vents when the unit is switched on, as sometimes there is a possibility of small debris being discharged from the air vents, especially after cleaning / replacement of the filters as debris inside the unit can be disturbed.

temperature. Exposure to fire or temperature above 266°F (130°C) may cause explosion.





- e) **Have servicing performed by a qualified repair person using only identical replacement parts.** This will ensure that the safety of the product is maintained.

ADDITIONAL SAFETY WARNINGS

- a) **Prevent unintentional starting. Ensure the switch is in the off-position before connecting to battery pack, picking up or carrying the appliance.** Carrying the appliance with your finger on the switch or energizing appliance that have the switch on invites accidents.
- b) **Recharge only with the charger specified by the manufacturer.** A charger that is suitable for one type of battery pack may create a risk of fire when used with another battery pack.
- c) **Do not use a battery pack or appliance that is damaged or modified.** Damaged or modified batteries may exhibit unpredictable behavior resulting in fire, explosion or risk of injury.
- d) **Do not expose a battery pack or appliance to fire or excessive**

SAVE THESE INSTRUCTIONS

Symbols

- The label on your tool may include the following symbols. The symbols and their definitions are as follows:
V..... volts
A..... amperes
Hz..... hertz
W..... watts
min minutes
~ or *AC*..... alternating current
--- or *DC* .. direct current
n_o no load speed
 Class I Construction (grounded)
 earthing terminal
 safety alert symbol
 Class II Construction (double insulated)
.../min or rpm........ revolutions or reciprocation per minute

FUNCTIONAL DESCRIPTION

HHVI320JR & HHVI325JR

1. On/off switch
2. Bowl release button
3. Charging socket
4. Dust bowl
5. Nozzle
6. Nozzle release button
7. Nozzle rotating button
8. Extendable crevice tool
9. Flip-up Brush
10. Cloth filter
11. Wall mount bracket
12. Charger
13. Jack plug

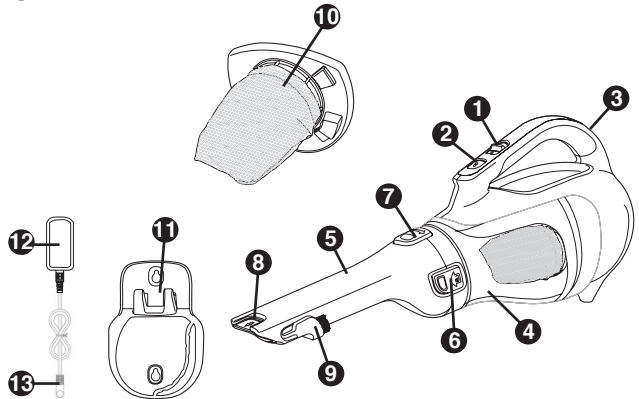

HHVI315JO

1. On/off switch
2. Bowl release button
3. Charging socket
4. Dust bowl
5. Nozzle
10. Cloth filter
11. Wall mount bracket
12. Charger
13. Jack plug

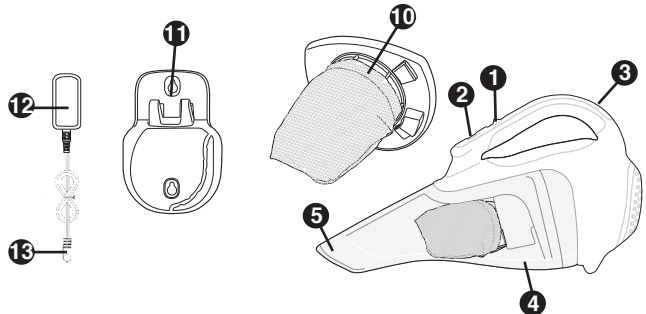

Assembly

⚠ WARNING: Do not attempt to modify or repair the appliance

Wall Mounting

The product can be wall mounted, if desired, using the wall mount bracket, screws and anchors supplied. To wall mount the vac, refer to **figures A, B, C and D**.

- **Figure A** - Mark the location of the screw holes (within reach of an electrical outlet for charging the vac while it is on the wall bracket).
- **Figure B** - Insert the charger cord into the curved slot in the wall mount bracket leaving approximately 8-9 inches (203mm - 227mm) excess as shown.

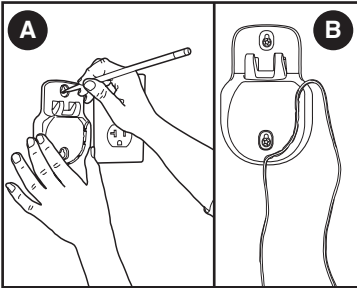

- **Figure C** - Hang the vac on the wall by placing the opening on the base of the vac over the hooks in the wall mount bracket as shown in **figure C**.

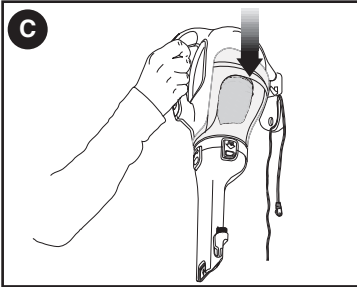

- **Figure D** - Insert the jack plug into the charging socket.

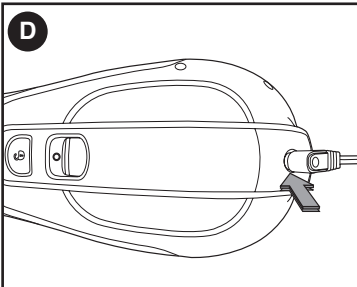

Charging the battery

⚠ WARNING: For use only with the supplied charger. From new, the rechargeable cells of the product need a minimum charge time of 16 hours to ensure full power.

We suggest you fully discharge the product when it is used for the first time as this will help the cells recharge faster.

- The switch must be in the off ("O") position, the product will not charge if it is in any other position.
- **Figure E** - Plug the jack plug of the charger into the charging socket of the tool. Plug the charger into any standard 120 Volt 60 Hz electrical outlet.

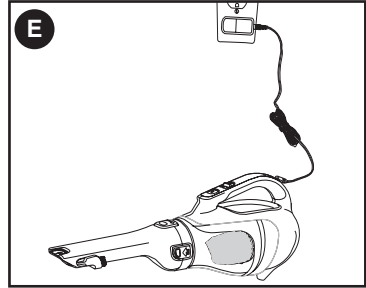

While charging, the charger may get warm, this is perfectly normal and safe. It is safe to leave the appliance connected to the charger indefinitely. The charger automatically reduces power consumption when charging is complete.

⚠ WARNING: Do not charge the battery at ambient temperatures below 39°F (4°C) or above 104°F (40°C).

Use

Switching on and off

- **Figure F** - To start, slide the On/Off switch forward (i.e. "O" = Off, "I" = On).
- To stop, slide the switch back.
- Return the product to the charger immediately after use so that it will be ready and fully charged for the next use. Ensure that the product is fully engaged with the charger plug.

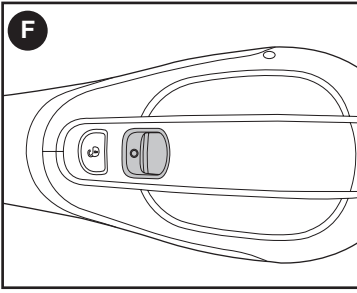

Cleaning and emptying the product

⚠ WARNING: Projectile/
Respiratory Hazard: Never use the vac
without its filter.

NOTE: The filter is re-usable, do not
confuse it with a disposable dust bag, and
do not throw it away when the product is
emptied. We recommend that you replace
the filter every 6-9 months depending on
frequency of use.

There are two methods of cleaning the bowl,
a quick empty method and a thorough clean
method.

For a quick empty (figures G, H)

- **Figure G** - Press in on both nozzle release
buttons on the sides of the nozzle and
remove the nozzle by pulling straight off.

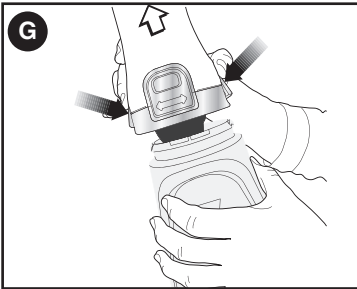

- **Figure H** - Empty the dust from the bowl.
- For a more thorough cleaning, remove
bowl as described below.

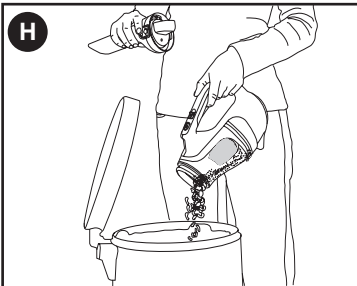

For a more thorough cleaning (figures I & J)

- **Figure I** - Remove the dust bowl by
pressing the bowl release button and
pulling the bowl straight off.
- Remove filter from within the bowl.

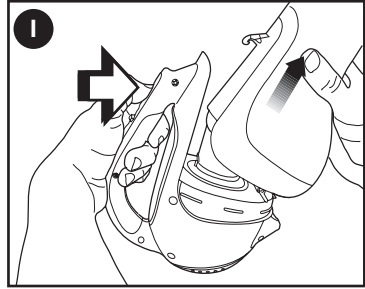

- Remove the cloth filter and shake or
lightly brush any loose dust off both filters.
- **Figure J** - The dust bowl and filter can be
washed in warm soapy water. Allow to
dry before placing back into the vac.

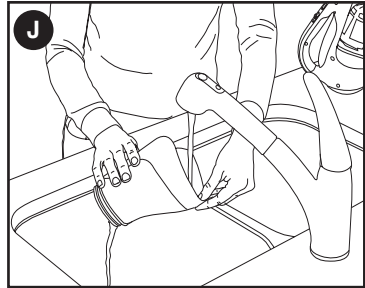

- Place filter back into the bowl pressing
firmly to ensure a secure fit.
 - To replace dust bowl, place it back onto the
handle until it "clicks" firmly into position.
- IMPORTANT:** Maximum dust collection will
only be obtained with a clean filter and an empty
dust bowl. If dust begins to fall back out of the
product after it is switched off, this indicates that
the bowl is full and requires emptying.
- Wash the filters regularly using warm,
soapy water and ensure that it is
completely dry before using again. The
cleaner the filter is, the better the product
will perform.
 - It is very important that the filter is
correctly in position before use.

Nozzle / Accessories (HHVI320JR and HHVI325JR)

- **Figure K** - A crevice tool is built into the
nozzle and can be extended as shown
in **figure K** by pulling the extension piece
until it locks into position.

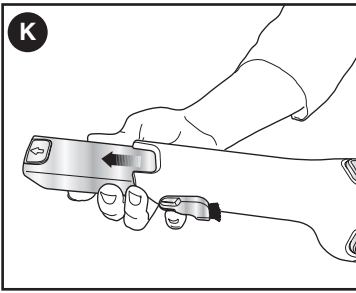

- **Figure L** - A brush accessory is built into the nozzle and can be flipped upwards for use.

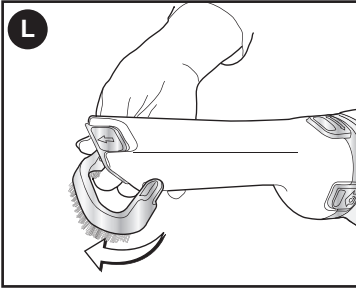

- **Figure M** - The nozzle can be rotated for better access in tight spots. To rotate the nozzle press the button shown in **figure M** and rotate the nozzle to the left or right until it clicks into place.

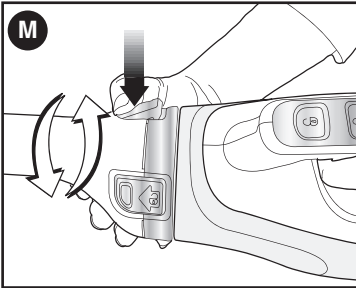

Assembly Accessories - Figure N (HHVI315JO Only)

Your hand vac may be supplied with some of the following accessories:

- A brush tool for furniture and stairs.
- A crevice tool for confined spaces.

Fitting

- Insert the appropriate accessory into the front of the appliance as show in **Figure N**.
- Make sure the accessory is fully pushed in.

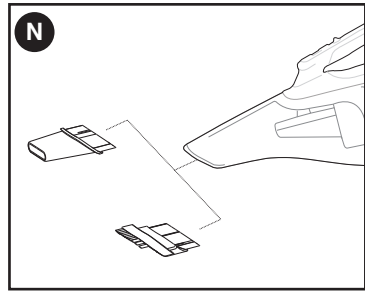

Replacing the filters

The filters should be replaced every 6 to 9 months and whenever worn or damaged. Replacement filters are available from your BLACK+DECKER dealer.

- Remove the old filters as described above.
- Fit the new filters as described above.

Maintenance

Use only mild soap and damp cloth to clean the vac. Never let any liquid get inside the vac; never immerse any part of the vac into a liquid.

⚠ WARNING: Make sure the vacuum is completely dry before using it.

IMPORTANT: To assure product SAFETY and RELIABILITY, repairs, maintenance and adjustment (other than those listed in this manual) should be performed by authorized service centers or other qualified service organizations, always using identical replacement parts.

Troubleshooting

If the product does not work, check the following:

- The charger was correctly plugged in for recharge. (It feels slightly warm to the touch.)
- The charger cord is not damaged and is correctly attached.
- The charger is plugged into a working electrical outlet.
- The switch is in the "OFF" position when charging.

WARNING: The use of

any accessory not recommended for use with this product could be hazardous.

The RBRC™ Seal

The RBRC® (Rechargeable Battery Recycling Corporation) Seal on the lithium-ion batteries (or battery packs) indicates that the costs to recycle these batteries (or battery packs) at the end of their useful life have already been paid by BLACK+DECKER. In some areas, it is illegal to place spent lithium-ion batteries in the trash or municipal solid waste stream and the Call 2 Recycle® program provides an environmentally conscious alternative. Call 2 Recycle, Inc., in cooperation with BLACK+DECKER and other battery users, has established the program in the United States and Canada to facilitate the collection of spent lithium-ion batteries. Help protect our environment and conserve natural resources by returning the spent nickel cadmium, nickel metal hydride or lithium-ion batteries to an authorized BLACK+DECKER service center or to your local retailer for recycling. You may also contact your local recycling center for information on where to drop off the spent battery. RBRC® is a registered trademark of Call 2 Recycle, Inc.