

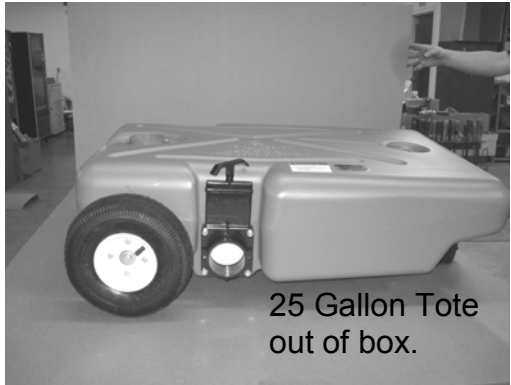

TOTE-ALONG OWNER'S INSTRUCTIONS

25 GALLON - P/N 25895



25 Gallon Tote out of box.



Contents of hardware bag ** and tow handle.

**Contents: Instructions, warranty card, tow handle, pin for handle, black square cap for handle, 1 grey filler hose, 1 bobber gauge, 2 bayonet hose adaptors, 2 hose clamps, 1 garden hose cap, 1 gasket for garden hose cap, 2 - 3" caps, 2 straps for caps, and 1 sewer hose.

Step 1 - Take everything out of the box (tank and hardware bag and handle).

Step 2 - Take everything out of the plastic bag.

Step 3 - Attach tow handle (be sure the handle is turned the

correct way--with the loop facing out or away from tank, so the handle will lean against tank when it is attached). Attach square black plastic cap to tow handle.



Attach tow handle with pin.

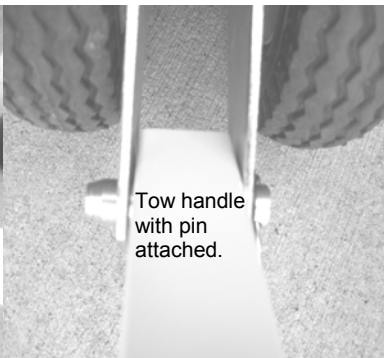

Tow handle with pin attached.



Tow handle attached to tank



Attach black cap.

Step 4 - Put sewer hose onto adaptors and tighten with clamps. (This is the hardest thing hardest part of putting your tank together.) To make your life easier and less muttering under your breath, take a hair dryer, heat the hose slightly. The hose will expand to make the connection simpler. You can do it without a hairdryer, but you may break a nail and it takes some time and patience. Once you get one adaptor end on, put the two silver hose clamps onto hose and then attach the other adaptor. That way you won't have to unscrew the hose clamp to insert it around the hose. Now, tighten the hose clamp at the base of the adaptor and hose. (You can use a coin to tighten, if you don't have a screwdriver handy.)

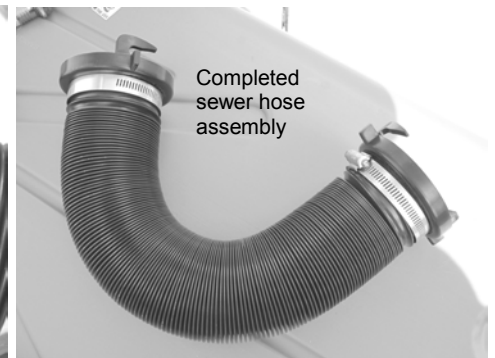
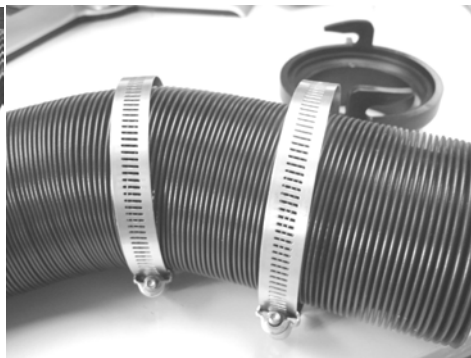

Completed sewer hose assembly

Step 5 - Attach one end of the rubber strap to 3" cap(s) and attach the other end of rubber strap to tank (one on side at valve and one on top). Close caps on tank for transporting. When you take the caps off to attach 3" adaptor/sewer hose assembly for emptying, you will still have your transport caps at hands reach.



3" cap with strap attached--side valve



3" cap with strap attached--top of tank



OVER PLEASE



Step 6 - Attach garden hose cap (as shown).

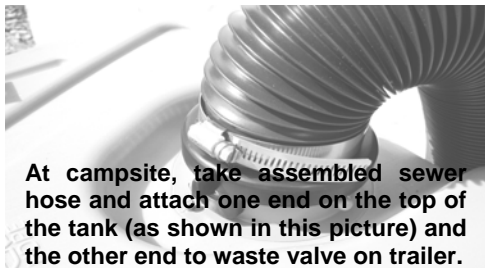

At campsite, take assembled sewer hose and attach one end on the top of the tank (as shown in this picture) and the other end to waste valve on trailer.

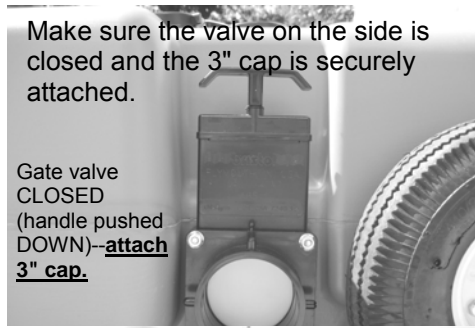

Make sure the valve on the side is closed and the 3" cap is securely attached.

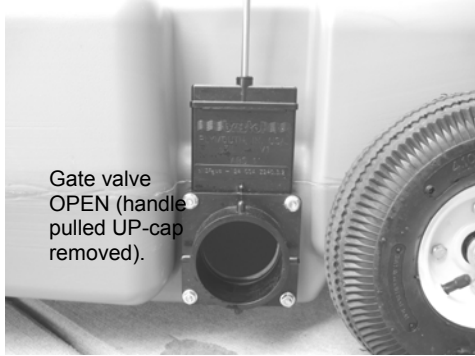

Gate valve OPEN (handle pulled UP-cap removed).



Bobber Gauge - Empty tank

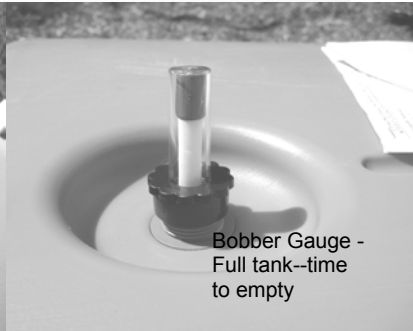

Bobber Gauge - Full tank--time to empty

Remove garden hose cap and install bobber gauge. Once tank is full (you can tell from the bobber gauge), it needs to be emptied. Remove the sewer hose from trailer waste valve and the tank (you don't want to tow the tank with the sewer hose attached). Attach the 3" cap to top of tank (where sewer hose was located). Now you can hook the tow handle to the hitch ball on whatever you have to drive around (car, golf cart, bike, etc.)

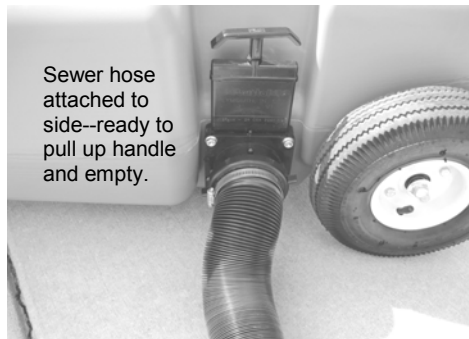

Sewer hose attached to side--ready to pull up handle and empty.



Garden hose filler attached--ready to hook to water supply to rinse tank.

Bring your sewer hose...you will use it at the dump site. (If you are done camping, bring your grey garden hose so you can rinse your tank.) At the dump site, attach one end of the sewer hose to the side of your tank and the other end to the dump station. Remove the garden hose cap or bobber gauge for ventilation. Open the valve on the side of the tank by pulling up on the black handle and contents of tank will empty.

Now you take the grey water hose and attach it where it was vented. You can hook up the water supply at the dump station and rinse your tank (if you are done camping). Put both 3" caps back on empty tank and take your accessories with you back to camp.

ITEM	PART NO.	REQ'D	DESCRIPTION
1	26060	2	ADAPTOR ASSEMBLY (3")
2	25905	1	SPINDLE ASSEMBLY
3	25911	1	TOW BAR
4	25910	1	AXLE SUPPORT
5	600-0055	1	HEX BOLT (#10-32 X .38)
6	610-1020	1	HEX NUT (#10-32)
7	15655	1	FILLER HOSE ASSEMBLY
8	10225	3	HOSE WASHER
9	10400	2	HOSE CLAMP
10	11576	1	HOSE CAP (3/4")
11	26048	2	CAP (3")
12	25912	1	CAPLUG (#FP-205)
13	643-0007	1	QUICK RELEASE PIN
14	12316	1	SEWER HOSE (5') □
15	27183	1	FRONT AXLE
16	25916	2	RETAINER PLATE DUMP VALVE
17	32273	2	WHEEL (6") □
18	25918	1	SPINDLE BEARING
19	25921	2	VALVE SEAL (3")
20	25922	1	BAYONET AND FLANGE (3")
21	600-0056	4	HEX HEAD BOLT (1/4-20 X .62) □
22	600-0054	4	HEX HEAD BOLT (1/4-20 X 2)
23	615-0001	2	PUSH NUT (5/8")
24	615-0002	2	PUSH NUT (1/2")
25	617-0083	2	BUSHING (42 GAL) (25 GAL)
25	617-0098	2	BUSHING (32 GAL)
26	635-0019	4	"O" RING
27	32274	2	WHEEL, REAR (10")
28	610-0025	4	FLANGE NUT
29	26136	1	REAR AXLE
30	25903	1	TANK 25 GALLON
31	25923	1	WASTE VALVE (3")
32	26097	1	STRAP (3")
33	17274	1	WARNING LABEL (25 & 32 ONLY)
34	30955	1	BOBBER GAUGE
35	26096	2	GASKET

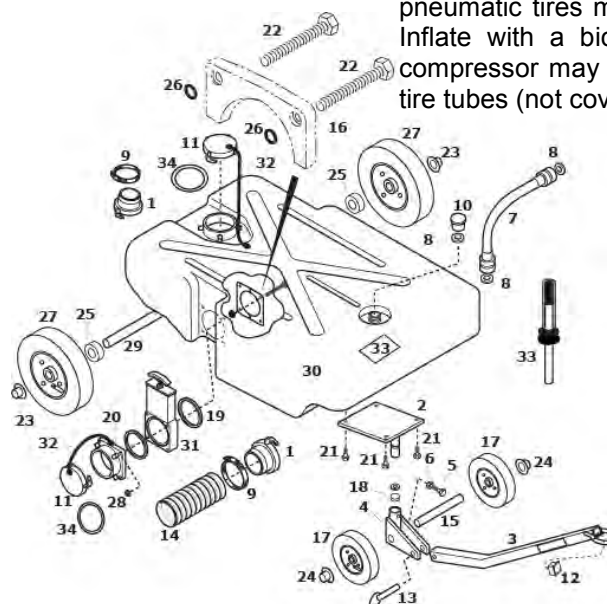

IMPORTANT NOTES: Do not tow your tank faster than 5 mph (or walking speed). This may damage tank or wheels and will NOT be covered under warranty. The pneumatic tires may need air periodically. Inflate with a bicycle air pump. An air compressor may over inflate and damage tire tubes (not covered under warranty).

